



01

ACCESSORI - ACCESSORIES 2024

# FREE WEIGHTS

## INDICE - INDEX - FREE WEIGHTS

	MANUBRI & BILANCIERI - DUMBBELLS & BARBELLS	22		Rastrelliera porta dischi pro - <i>Weight plates rack pro</i>	23
6	Manubri in uretano - <i>Urethane dumbbells</i>	23		Rastrelliera verticale porta dischi bumper e bilancieri- <i>Vertical bumper weight plates and barbells rack</i>	23
6	Manubri gommati con impugnatura rotante absolute <i>Rubber encased dumbbells with rotating handle absolute</i>			Rastrelliera orizzontale porta dischi bumper - <i>Horizontal bumper weight plates rack</i>	
7	Manubri gommati - <i>Rubber encased dumbbells</i>				
8	Bowflex manubri selectech 552i - <i>Bowflex selectech dumbbells 552i</i>	24		BILANCIERI OLIMPICI - OLYMPIC BARS	
8	Bowflex manubri selectech 1090i - <i>Bowflex selectech dumbbells 1090i</i>	24		Bilanciere cross competition 1000 - <i>Cross competition 1000 barbell</i>	
8	Rack manubri selectech - <i>Selectech dumbbells rack</i>	25		Bilanciere cross master 700 - <i>Cross master 700 barbell</i>	
9	Manubri esagonali absolute - <i>Hex dumbbells absolute</i>	25		Bilanciere cross challenge 450 - <i>Cross challenge 450 barbell</i>	
9	Manubri esagonali gommati - <i>Hex rubber dumbbells</i>	25		Bilanciere cross challenge women 250 - <i>Cross challenge women 250 barbell</i>	
10	Manubri cromati - <i>Chromed dumbbells</i>	26		Bilanciere cross technique 200 - <i>Cross technique 200 barbell</i>	
10	Manubri vinile - <i>Vinyl dumbbells</i>	26		Bilanciere cross technique 180 - <i>Cross technique 180 barbell</i>	
11	Bilancieri dritti precaricati - <i>Preloaded straight barbells</i>	27		Bilanciere olimpico esagonale trigrip - <i>Trigrip olympic hex barbell</i>	
11	Bilancieri curl precaricati - <i>Preloaded EZ curl barbells</i>	27		Bilanciere olimpico esagonale - <i>Olympic hex barbell</i>	
12	Bilanciere selectech 2080 - <i>Barbell selectech 2080</i>	28		Safety squat bar	
12	Kit extra 18 kg per bilanciere 2080 - <i>18 kg upgrade kit for barbell 2080</i>	28		Offset bar	
12	Stand per bilanciere 2080 - <i>Stand for barbell 2080</i>	29		Bilanciere power training 220 - <i>Power training 220 barbell</i>	
13	Rastrelliera porta manubri tondi componibile 3 ripiani <i>Modular rack for round dumbbells with 3 shelves</i>	29		Bilanciere power training 180 - <i>Power training 180 barbell</i>	
13	Rastrelliera porta manubri tondi componibile 2 ripiani <i>Modular rack for round dumbbells with 2 shelves</i>	30		Bilanciere power training 150 - <i>Power training 150 barbell</i>	
14	Telaio di supporto per 3 ripiani - <i>Side for 3 shelves</i>	30		Bilanciere power training 120 - <i>Power training 120 barbell</i>	
14	Telaio di supporto per 2 ripiani - <i>Side for 2 shelves</i>	30		Bilanciere power training 86 - <i>Power training 86 barbell</i>	
14	Ripiano standard - <i>Standard shelf</i>	31		Manubrio power training 51 - <i>Power training 51 dumbbell</i>	
15	Vassoio manubri esagonali - <i>Hex dumbbells shelf</i>	31		Rastrelliera pro porta bilancieri da terra - <i>Floor barbells rack pro</i>	
15	Set 16 sedi per manubri tondi - <i>Set of 16 round dumbbells seats</i>	31		Rastrelliera porta bilancieri da terra - <i>Floor barbells rack</i>	
16	Rastrelliera studio porta manubri a 2 ripiani <i>Studio rack for dumbbells with 2 shelves</i>	32		Rastrelliera porta bilancieri a parete - <i>Wall barbells rack</i>	
16	Rastrelliera porta manubri 10 coppie - <i>Dumbbells rack 10 pairs</i>	32		Rastrelliera porta bilancieri a parete - <i>Wall barbells rack</i>	
16	Rastrelliera porta manubri in vinile - <i>Vinyl dumbbells rack</i>	33			
17	Rastrelliera porta manubri 6 coppie - <i>Dumbbells rack 6 pairs</i>	33		ACCESSORI BILANCIERI - BARBELLS ACCESSORIES	
17	Rastrelliera porta manubri a 3 ripiani - <i>Dumbbells rack with 3 shelves</i>	34		Set di 4 jerk blocks impilabili - <i>Set of 4 stackable jerk blocks</i>	
17	Rastrelliera porta bilancieri 5 posti - <i>Barbells rack 5 places</i>	34		Coppia di cuscini ammortizzanti drop mats - <i>Drop mats</i>	
		35		Total core con base - <i>Total core with base</i>	
		35		Impugnatura T-Bar - <i>T-Bar handle</i>	
		35		Total core	
		36		Cuscino di protezione bilanciere per hip thrust a carico libero <i>Barbell pad for free weight hip thrust</i>	
		36		Cuscino di protezione per bilanciere e squat in gomma - <i>Rubber barbell/squat pad</i>	
		36		Cuscino imbottito di protezione per bilanciere e squat - <i>Rubber barbell/squat pad</i>	
18	Dischi olimpici in ghisa gommata - <i>Olympic rubber coated cast iron weight plates</i>	37		Cinture per sollevamento pesi - <i>Weightlifting belts</i>	
18	Dischi olimpici in ghisa - <i>Olympic cast iron weight plates</i>	37		Cintura per dip con sovraccarico - <i>Dip belt</i>	
19	Dischi bumper competition - <i>Competition bumper weight plates</i>	37		Guanti di protezione del palmo 3 fori - <i>Weightlifting palms with 3 holes</i>	
19	Dischi bumper challenge - <i>Challenge bumper weight plates</i>	38		Guanti di protezione del palmo in pelle - <i>Leather weightlifting palms</i>	
20	Dischi bumper crumb - <i>Bumper crumb weight plates</i>	38		Coppia ab straps cinghie nylon per trazioni - <i>Ab straps - pulling nylon belts</i>	
20	Dischi bumper training absolute - <i>Training bumper weight plates absolute</i>	38		Coppia ferma dischi in alluminio - <i>Pair of aluminium safety collars</i>	
21	Coppia dischi technique - <i>Technique plates</i>	39		Coppia ferma dischi in nylon - <i>Pair of nylon safety collars</i>	
21	Coppia dischi microcarichi gommati - <i>Fractional rubber coated weight plates</i>	39		Coppia ferma dischi a molla - <i>Pair of spring clip safety collars</i>	
21	Coppia dischi microcarichi in acciaio - <i>Fractional steel coated weight plates</i>	39		Magnesite in pani - <i>Chalk blocks</i>	
22	Rastrelliera porta dischi studio - <i>Studio rack for weight plates</i>	39			

**MANUBRI IN URETANO**  
**URETHANE DUMBBELLS**

I - Le teste monoblocco unite da impugnatura godronata a terminali conici sono collegate a pressione e saldate a cordone continuo.

Dimensione impugnatura: 150xø30/32 mm. Dimensione testa: 25/106xø126x195 mm

*EN - The monobloc heads joined by a knurled handle to conical terminals are connected by pressure and welded with a continuous seam.*

*Handle size: 150xø32/34mm. Head size: 25/106xø126x195 mm*

**cod. MPU-SET24**

I - Set coppie manubri in uretano da 4 a 24 kg (salto da 2 kg).

*EN - 10 pairs of urethane dumbbells 4-24 Kg (2kg step).*

cod. MPU-2 - Kg. 2  
cod. MPU-4 - Kg. 4  
cod. MPU-6 - Kg. 6  
cod. MPU-8 - Kg. 8  
cod. MPU-10 - Kg. 10  
cod. MPU-12 - Kg. 12  
cod. MPU-14 - Kg. 14

cod. MPU-16 - Kg. 16  
cod. MPU-18 - Kg. 18  
cod. MPU-20 - Kg. 20  
cod. MPU-22 - Kg. 22  
cod. MPU-24 - Kg. 24  
cod. MPU-26 - Kg. 26  
cod. MPU-28 - Kg. 28

cod. MPU-30 - Kg. 30  
cod. MPU-32 - Kg. 32  
cod. MPU-34 - Kg. 34  
cod. MPU-36 - Kg. 36  
cod. MPU-38 - Kg. 38  
cod. MPU-40 - Kg. 40



**MANUBRI GOMMATI CON IMPUGNATURA ROTANTE ABSOLUTE**  
**RUBBER ENCASED DUMBBELLS WITH ROTATING HANDLE ABSOLUTE**

I - Le teste innestate a pressione su impugnatura a terminali conici vengono saldate a cordone continuo per conferire massima solidità al manubrio; l'impugnatura rotante in TPU godronato è montata su un albero in acciaio cromato per diminuire al massimo gli attriti di rotazione. Dimensione impugnatura: 150xø32/34mm. Dimensione testa: 19,5/133xø126x193 mm

*EN - The heads, pressure-fitted onto the handle with conical terminals, are welded with a continuous seam to give maximum solidity to the dumbbell. The knurled TPU rotating handle is mounted on a chrome-plated steel shaft to reduce friction. Handle size: 150xø32/34mm. Head size: 19,5/133xø126x193 mm*

**cod. MGPR-SET24**

I - Set coppie manubri gommati con impugnatura rotante da 4 a 24 kg (salto da 2 kg).

*EN - 10 pairs of rubber dumbbells with rotating handle 4-24 Kg (2kg step).*

cod. MGPR-2 - Kg. 2	cod. MGPR-16 - Kg. 16	cod. MGPR-30 - Kg. 30	cod. MGPR-44 - Kg. 44
cod. MGPR-4 - Kg. 4	cod. MGPR-18 - Kg. 18	cod. MGPR-32 - Kg. 32	cod. MGPR-46 - Kg. 46
cod. MGPR-6 - Kg. 6	cod. MGPR-20 - Kg. 20	cod. MGPR-34 - Kg. 34	cod. MGPR-48 - Kg. 48
cod. MGPR-8 - Kg. 8	cod. MGPR-22 - Kg. 22	cod. MGPR-36 - Kg. 36	cod. MGPR-50 - Kg. 50
cod. MGPR-10 - Kg. 10	cod. MGPR-24 - Kg. 24	cod. MGPR-38 - Kg. 38	
cod. MGPR-12 - Kg. 12	cod. MGPR-26 - Kg. 26	cod. MGPR-40 - Kg. 40	
cod. MGPR-14 - Kg. 14	cod. MGPR-28 - Kg. 28	cod. MGPR-42 - Kg. 42	





**MANUBRI GOMMATI****RUBBER ENCASED DUMBBELLS**

I - Le teste innestate a pressione sull'impugnatura in acciaio godronato a terminali conici, vengono saldate a cordone continuo per conferire massima solidità al manubrio. Dimensione impugnatura: 150xø25/34mm. Dimensione testa: 32/141xø127/195 mm

*EN - The heads, pressure-fitted onto the knurled handle with conical terminals, are welded with a continuous seam to give maximum solidity to the handlebar. Handle size: 150xø25/34mm. Head size: 32/141xø127/195 mm*

**cod. MGP-SET24PRO**

I - Set coppie manubri gommati da 4 a 24 kg (salto da 2 kg).

*EN - 10 pairs of rubber dumbbells 4-24 Kg (2kg step).*

**cod. MGP-2PRO** - Kg. 2

**cod. MGP-4PRO** - Kg. 4

**cod. MGP-6PRO** - Kg. 6

**cod. MGP-8PRO** - Kg. 8

**cod. MGP-10PRO** - Kg. 10

**cod. MGP-12PRO** - Kg. 12

**cod. MGP-14PRO** - Kg. 14

**cod. MGP-16PRO** - Kg. 16

**cod. MGP-18PRO** - Kg. 18

**cod. MGP-20PRO** - Kg. 20

**cod. MGP-22PRO** - Kg. 22

**cod. MGP-24PRO** - Kg. 24

**cod. MGP-26PRO** - Kg. 26

**cod. MGP-28PRO** - Kg. 28

**cod. MGP-30PRO** - Kg. 30

**cod. MGP-32PRO** - Kg. 32

**cod. MGP-34PRO** - Kg. 34

**cod. MGP-36PRO** - Kg. 36

**cod. MGP-38PRO** - Kg. 38

**cod. MGP-40PRO** - Kg. 40

**cod. MGP-42PRO** - Kg. 42

**cod. MGP-44PRO** - Kg. 44

**cod. MGP-46PRO** - Kg. 46

**cod. MGP-48PRO** - Kg. 48

**cod. MGP-50PRO** - Kg. 50

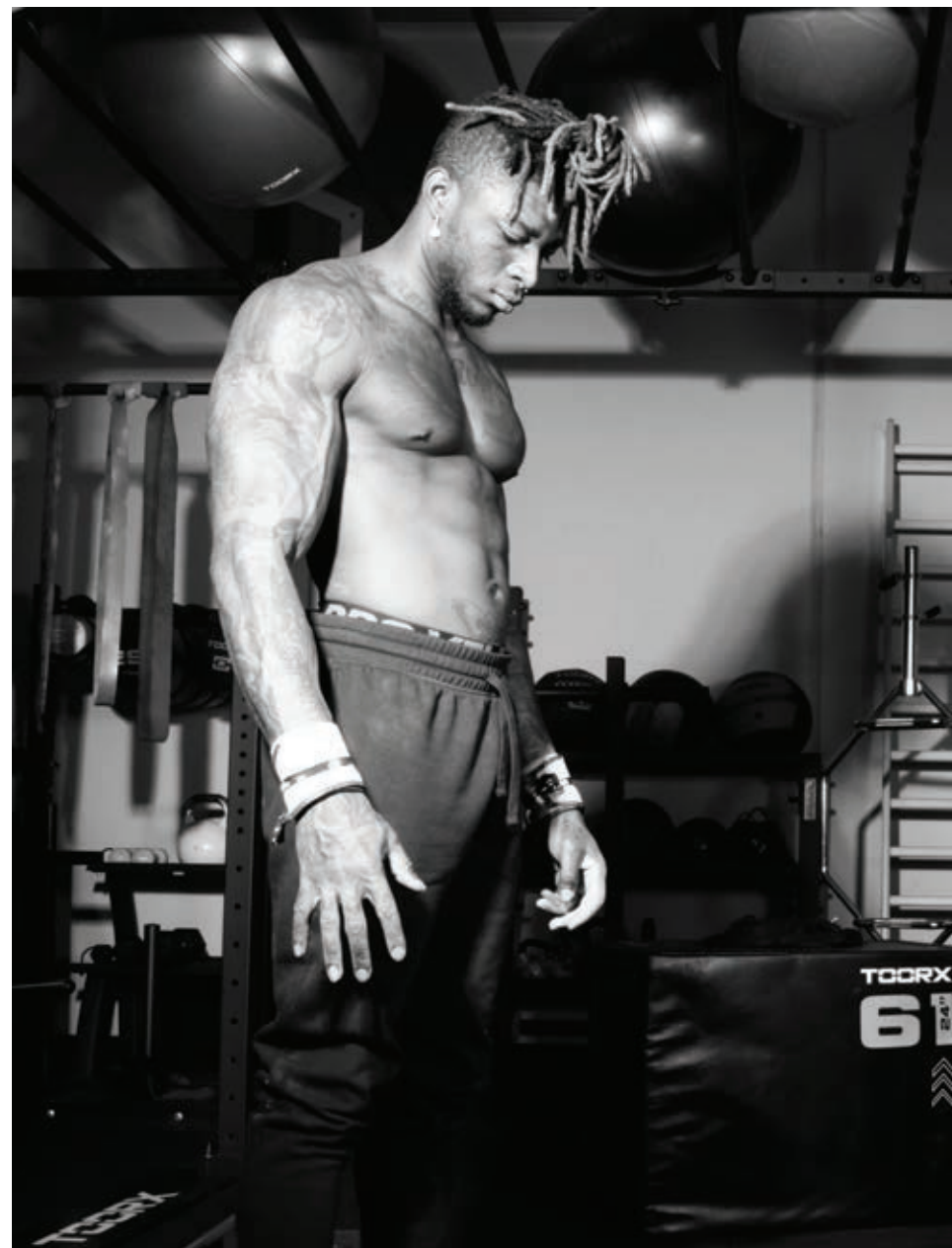

**MANUBRI SELECTECH 552i**  
**SELECTECH DUMBBELLS 552i**



**cod. BOW-552i**

I - Manubrio a carico variabile con set di 15 pesi a selezione rapida. La ghiera selettiva con indici da 2 a 24 permette di selezionare il carico di lavoro da effettivi 2,3 a 23,8 kg. con salto di 2 kg. Dischi in acciaio gommato ed impugnatura ergonomica per una presa salda anche nei carichi più alti. L'alloggiamento in ABS, necessario durante le operazioni di selezione del carico, può essere ospitato nel rack trasportabile dedicato.

Peso regolabile da 2,3 a 23,8 kg

Selezionatore dei pesi: 2,3 - 3,4 - 4,5 - 5,6 - 6,7 - 7,8 - 8,9 - 10 - 11,1 - 13,4 - 15,7 - 18 - 20,3 - 22,7 - 23,8 kg

Dimensione manubrio 43 x 21 x 23 cm

*EN - Adjustable selective dumbbell with 15 weight plates set. The selector dial indicates a possible range from 2 to 24, allowing you to select the working load from 2.3 to 23.8 kg. in increments of 2kg. Rubberized steel discs and ergonomic handles give a firm grip even with the heaviest loads The ABS housing, necessary during load selection operations, can be housed in the dedicated transportable rack.*

*Adjustable weight from 2,3 to 23,8 kg*

*Selectable weight plates : 2,3 - 3,4 - 4,5 - 5,6 - 6,7 - 7,8 - 8,9 - 10 - 11,1 - 13,4 - 15,7 - 18 - 20,3 - 22,7 - 23,8 kg*

*Dumbbell size 43 x 21 x 23 cm*



**MANUBRI SELECTECH 1090i**  
**SELECTECH DUMBBELLS 1090i**



**cod. BOW-1090i**

I - Manubrio a carico variabile con set di 17 pesi a selezione rapida. La ghiera selettiva con indici da 4 a 41 permette di selezionare il carico di lavoro da effettivi 4,5 a 40,8 kg. con salto di 2 kg. Dischi in acciaio gommato ed impugnatura ergonomica per una presa salda anche nei carichi più alti. L'alloggiamento in ABS, necessario durante le operazioni di selezione del carico, può essere ospitato nel rack trasportabile dedicato

Peso regolabile da 4,5 a 40,8 kg

Selezionatore dei pesi: 4,5 - 6,7 - 9,4 - 11,3 - 13,6 - 15,9 - 18,1 - 20,4 - 22,7 - 24,9 - 27,2 - 29,5 - 31,8 - 34 - 36,3 - 38,6 - 40,8 kg

Dimensione manubrio 44,5 x 24 x 25,5 cm

*EN - Adjustable selective dumbbell with 17 weight plates set. The selector dial indicates a possible range from 4 to 41, allowing you to select the working load from 4.5 to 40.8 kg. in increments of 2kg. Rubberized steel discs and ergonomic handles give a firm grip even with the heaviest loads The ABS housing, necessary during load selection operations, can be housed in the dedicated transportable rack*

*Adjustable weight from 4,5 to 40,8 kg*

*Selectable weight plates : 4,5 - 6,7 - 9,4 - 11,3 - 13,6 - 15,9 - 18,1 - 20,4 - 22,7 - 24,9 - 27,2 - 29,5 - 31,8 - 34 - 36,3 - 38,6 - 40,8 kg*

*Dumbbell size 44,5 x 24 x 25,5 cm*



**RACK MANUBRI SELECTECH**  
**SELECTECH DUMBBELLS RACK**



**cod. BOW-STAND**

I - Carrello porta-manubri a carico regolabile (BOW-552i/BOW-1090i) dotato di supporto tablet con superficie gommata antiscivolo per un miglior grip. Ingombro ridotto e facile da montare. Manubrio a carico variabile risultato di una tecnologia all'avanguardia, è un'ottima soluzione salvaspazio che consente di avere a disposizione un'intera serie di manubri già pre-caricati in uno spazio molto ridotto. È sufficiente una semplice rotazione della ghiera graduata per selezionare il carico desiderato. La struttura meccanica interna ne garantisce la precisione di selezione del peso.

*EN - Stand for adjustable selective dumbbells (BOW-552i/BOW-1090i) equipped with tablet holder with non-slip rubber surface for an ideal grip. Reduced footprint and easy to assemble. Adjustable selective dumbbell with 15 weight plates set. Based on a state-of-the-art technology, it is a great space-saving solution, which allows to have a whole set of dumbbells already pre-loaded in a very small space. All you have to do is a simple rotation of the graduated knob to select the desired weight. The internal mechanical structure guarantees the accuracy of weight selection.*



## MANUBRI ESAGONALI ABSOLUTE

### HEX DUMBBELLS ABSOLUTE

I - Le teste innestate a pressione sull'impugnatura a terminali conici, vengono saldate a cordone continuo per conferire massima solidità al manubrio. L'impugnatura è in acciaio godronato per favorire una presa salda e confortevole ed è finita con trattamento di brunitura protettiva. Teste rivestite in gomma di alta qualità.  
Dimensione impugnatura: 135xø23/24mm. Dimensione testa: 47/147,5xH58/200 mm

*EN - The pressure-engaged heads on the handle with conical terminals, are welded with continuous seam to give maximum solidity to the dumbbell. The handle is made with polished steel to ensure a firm and comfortable grip and is finished with protective burnishing treatment. High quality rubber coated heads.  
Handle size: 135xø23/34mm. Head size: 47/147,5xH58/200 mm*

cod. AMEG-1 - Kg. 1  
cod. AMEG-2 - Kg. 2  
cod. AMEG-3 - Kg. 3  
cod. AMEG-4 - Kg. 4  
cod. AMEG-5 - Kg. 5  
cod. AMEG-6 - Kg. 6  
cod. AMEG-7 - Kg. 7  
cod. AMEG-7,5 - Kg. 7,5  
cod. AMEG-8 - Kg. 8

cod. AMEG-9 - Kg. 9  
cod. AMEG-10 - Kg. 10  
cod. AMEG-12,5 - Kg. 12,5  
cod. AMEG-15 - Kg. 15  
cod. AMEG-17,5 - Kg. 17,5  
cod. AMEG-20 - Kg. 20  
cod. AMEG-22,5 - Kg. 22,5  
cod. AMEG-25 - Kg. 25  
cod. AMEG-27,5 - Kg. 27,5

cod. AMEG-30 - Kg. 30  
cod. AMEG-32,5 - Kg. 32,5  
cod. AMEG-35 - Kg. 35  
cod. AMEG-37,5 - Kg. 37,5  
cod. AMEG-40 - Kg. 40  
cod. AMEG-42,5 - Kg. 42,5  
cod. AMEG-45 - Kg. 45  
cod. AMEG-47,5 - Kg. 47,5  
cod. AMEG-50 - Kg. 50



## MANUBRI ESAGONALI GOMMATI

### HEX RUBBER DUMBBELL

I - Le teste innestate a pressione sull'impugnatura in acciaio godronato a terminali conici, vengono saldate a cordone continuo per conferire massima solidità al manubrio. Teste rivestite in gomma di alta qualità.  
Dimensione impugnatura: 135xø23/24mm. Dimensione testa: 47/147,5xH58/200 mm

*EN - The pressure-engaged heads on the knurled handle with conical terminals, are welded with continuous seam to give maximum solidity to the dumbbell. High quality rubber coated heads. Handle size: 135xø23/24mm. Head size: 47/147,5xH58/200 mm*

#### cod. MEG-SET25

I - Set coppie manubri esagonali gommati da 2,5 a 25 kg (salto 2,5 kg).  
*EN - 10 pairs of hex rubber dumbbells 2,5-25 Kg (2,5kg step).*

cod. MEG-1 - Kg. 1  
cod. MEG-2 - Kg. 2  
cod. MEG-3 - Kg. 3  
cod. MEG-4 - Kg. 4  
cod. MEG-5 - Kg. 5  
cod. MEG-6 - Kg. 6  
cod. MEG-7 - Kg. 7  
cod. MEG-7,5 - Kg. 7,5  
cod. MEG-8 - Kg. 8

cod. MEG-9 - Kg. 9  
cod. MEG-10 - Kg. 10  
cod. MEG-12,5 - Kg. 12,5  
cod. MEG-15 - Kg. 15  
cod. MEG-17,5 - Kg. 17,5  
cod. MEG-20 - Kg. 20  
cod. MEG-22,5 - Kg. 22,5  
cod. MEG-25 - Kg. 25  
cod. MEG-27,5 - Kg. 27,5

cod. MEG-30 - Kg. 30  
cod. MEG-32,5 - Kg. 32,5  
cod. MEG-35 - Kg. 35  
cod. MEG-37,5 - Kg. 37,5  
cod. MEG-40 - Kg. 40  
cod. MEG-42,5 - Kg. 42,5  
cod. MEG-45 - Kg. 45  
cod. MEG-47,5 - Kg. 47,5  
cod. MEG-50 - Kg. 50





## MANUBRI CROMATI CHROMED DUMBBELLS

I - Teste inserite a pressione su terminali tronco-conici finite con cromatura a specchio. L'impugnatura anatomica è godronata per favorire la presa ed è finita con cromatura per proteggerne la superficie dall'ossidazione.

Dimensione impugnatura: 120xø25/28mm. Dimensione testa: 23/70xø42/90 mm

*EN - Pressure-inserted heads on conical terminals with chrome plating finishing. The anatomical handle is knurled to facilitate grip and is finished with chrome plating to protect the surface from oxidation. Handle size: 120xø25/28mm. Head size: 23/70xø42/90 mm*

### cod. MC-SET

I - Set coppie manubri cromati con impugnatura anatomica da 1 a 10 Kg.

*EN - 10 pairs of chromed dumbbells with ergonomic handle set (1 - 10 Kg).*

cod. MC-1 - Kg. 1  
cod. MC-2 - Kg. 2  
cod. MC-3 - Kg. 3  
cod. MC-4 - Kg. 4

cod. MC-5 - Kg. 5  
cod. MC-6 - Kg. 6  
cod. MC-7 - Kg. 7  
cod. MC-8 - Kg. 8

cod. MC-9 - Kg. 9  
cod. MC-10 - Kg. 10



## MANUBRI VINILE VINYL DUMBBELLS

I - La struttura "pesante" è formata per fusione con struttura monoblocco a teste triangolari. Rivestiti in vinile con processo di dipping ad immersione.

*EN - The "heavy" structure is formed by fusion with a monobloc structure with triangular heads. Vinyl coated with immersion dipping process.*

### cod. MVT-SET

I - Set coppie manubri in vinile con testa triangolare da 1 a 10 Kg.

*EN - 10 pairs of vinyl dumbbells with triangular head set (1 - 10 Kg)*

cod. MVT-1 - Kg. 1      cod. MVT-6 - Kg. 6  
cod. MVT-2 - Kg. 2      cod. MVT-7 - Kg. 7  
cod. MVT-3 - Kg. 3      cod. MVT-8 - Kg. 8  
cod. MVT-4 - Kg. 4      cod. MVT-9 - Kg. 9  
cod. MVT-5 - Kg. 5      cod. MVT-10 - Kg. 10



cod. MV-05 - Kg. 0.5      cod. MV-4 - Kg. 4  
cod. MV-1 - Kg. 1      cod. MV-5 - Kg. 5  
cod. MV-2 - Kg. 2      cod. MV-6 - Kg. 6  
cod. MV-3 - Kg. 3



**BILANCIERI DRITTI PRECARICATI****PRELOADED BARBELLS**

**I** - Le teste innestate a pressione sull'impugnatura a terminali conici, vengono saldate a cordone continuo per conferire massima solidità al bilanciere. L'asta dritta è in acciaio godronato per favorire una presa salda e confortevole; la finitura testurizzata antigraffio delle teste ne conserva l'estetica nel tempo. Lunghezza bilanciere: 1034/1320 mm.

Dimensione asta: 970/1060xø25/30 mm. Dimensione testa: ø127/195 mm

**EN** - The heads, pressure-fitted onto the handle with conical terminals, are welded in a continuous seam to give maximum solidity to the barbell. The straight shaft is made of knurled steel to ensure a firm and comfortable grip; the scratch-resistant textured finish preserves its aesthetics over time. Barbell length: 1034/1320 mm.

Shaft size: 970/1060xø25/30 mm. Head size: ø127/195 mm

cod. BDP-5 - Kg. 5

cod. BDP-10 - Kg. 10

cod. BDP-15 - Kg. 15

cod. BDP-20 - Kg. 20

cod. BDP-25 - Kg. 25

cod. BDP-30 - Kg. 30

cod. BDP-35 - Kg. 35

cod. BDP-40 - Kg. 40

cod. BDP-45 - Kg. 45

cod. BDP-50 - Kg. 50

**BILANCIERI CURL PRECARICATI****PRELOADED EZ CURL BARBELLS**

**I** - Le teste innestate a pressione sull'impugnatura a terminali conici, vengono saldate a cordone continuo per conferire massima solidità al manubrio. L'asta sagomata è in acciaio godronato per favorire una presa salda e confortevole; la finitura testurizzata antigraffio delle teste ne conserva l'estetica nel tempo. Lunghezza bilanciere: 1034/1320 mm.

Dimensione asta: 970/1060xø25/30 mm. Dimensione testa: ø127/195 mm

**EN** - The heads, pressure-fitted onto the handle with conical terminals, are welded in a continuous seam to give maximum solidity to the barbell. The curled shaft is made of knurled steel to ensure a firm and comfortable grip; the scratch-resistant textured finish preserves its aesthetics over time. Barbell length: 1034/1320 mm.

Shaft size: 970/1060xø25/30 mm. Head size: ø127/195 mm

cod. BSP-5 - Kg. 5

cod. BSP-10 - Kg. 10

cod. BSP-15 - Kg. 15

cod. BSP-20 - Kg. 20

cod. BSP-25 - Kg. 25

cod. BSP-30 - Kg. 30

cod. BSP-35 - Kg. 35

cod. BSP-40 - Kg. 40

cod. BSP-45 - Kg. 45

cod. BSP-50 - Kg. 50





**BILANCIERE SELECTECH 2080**  
**BARBELL SELECTECH 2080**



**cod. BOW-2080**

**I** - Bilanciere a carico variabile da 9 a 36 kg. Con bilanciere dritto e curl, sostituisce un set da 14 bilancieri.

**I** 7 carichi selezionabili sono 9.1, 13.6, 18.1, 22.7, 27.2, 31.8, 36.3 kg. Dimensioni 150 x 30 x H32.

**EN** - Adjustable selective barbell from 9 to 36 kgs. With straight and curl barbells, replaces a set of 14 barbells. 7 loads available: 9.1, 13.6, 18.1, 22.7, 27.2, 31.8, 36.3 kg. Dimensions 150 x 30 x H32.



**KIT EXTRA 18 KG PER**  
**BILANCIERE 2080**



**18 KG UPGRADE KIT FOR BARBELL 2080**

**cod. BOW-2080-18**

**I** - Aumenta il carico massimo a 54 kg aggiungendo i 4 carichi: 40.5, 45, 49.5, 54 kg.

**EN** - Increase the max weight to 54 kg with 4 steps: 40.5, 45, 49.5, 54 kg.



**STAND PER BILANCIERE 2080**  
**STAND FOR BARBELL 2080**



**cod. BOW-2080-STAND**

**I** - Stand per bilanciere 2080 a carico variabile con porta tablet/smartphone.

**EN** - Stand for adjustable selective barbell 2080 with tablet/smartphone holder.



### **RASTRELLIERA PORTA MANUBRI TONDI COMPONIBILE A 3 RIPIANI** **MODULAR RACK FOR ROUND DUMBBELLS WITH 3 SHELVES**

**cod. RPMC-3**

**I** - Struttura portante modulare a 3 ripiani pensata per stivare manubri a testa tonda. Sostituendo le sedi in plastica incluse con il vassoio VME, diventa adatta allo stivaggio di manubri esagonali. Capacità minima di stivaggio: 12 coppie manubri testa tonda  
Dimensione prodotto: 180x100x120cm.

**EN** - Modular structure with 3 shelves designed to store round head dumbbells. Replacing the plastic seats with the shelf VME, it is suitable for hex dumbbells storage. Minimum storage capacity: 12 pairs of round head dumbbells  
Product size: 180x100xH120cm.



Manubri non inclusi.  
Dumbbells not included

### **RASTRELLIERA PORTA MANUBRI TONDI COMPONIBILE A 2 RIPIANI** **MODULAR RACK FOR ROUND DUMBBELLS WITH 2 SHELVES**

**cod. RPMC-2**

**I** - Struttura portante modulare a 2 ripiani pensata per stivare manubri a testa tonda. Sostituendo le sedi in plastica incluse con il vassoio VME, diventa adatta allo stivaggio di manubri esagonali. Capacità minima di stivaggio: 8 coppie manubri testa tonda  
Dimensione prodotto: 180x92xH84,5 cm.

**EN** - Modular structure with 2 shelves designed to store round head dumbbells. Replacing the plastic seats with the shelf VME, it is suitable for hex dumbbells storage. Minimum storage capacity: 8 pairs of round head dumbbells.  
Product size: 180x92xH84,5 cm.



Manubri non inclusi.  
Dumbbells not included

## TELAIO DI SUPPORTO PER 3 RIPIANI SIDE FOR 3 SHELVES

### cod. TS-3

I - Telaio monolitico di supporto dei ripiani, elemento strutturale verticale progettato per ospitare 3 ripiani: assemblando telaio + vassoi in serie ad una rastrelliera RPMC-3 è possibile ottenere uno storage a più campate, che può ospitare sia manubri esagonali che a testa tonda. Dimensione prodotto: 100x10x120cm.

*EN - Monolithic shelf support frame, vertical structural element designed to assembly 3 shelves: by assembling it + shelves in series with an RPMC-3 rack it is possible to obtain multi-span rack, which can store both hexagonal and round head dumbbells. Product size: 100x10xH120cm.*



## TELAIO DI SUPPORTO PER 2 RIPIANI SIDE FOR 2 SHELVES

### cod. TS-2

I - Telaio monolitico di supporto dei ripiani, elemento strutturale verticale progettato per ospitare 2 ripiani: assemblando telaio + vassoi in serie ad una rastrelliera RPMC-2 è possibile ottenere uno storage a più campate, che può ospitare sia manubri esagonali che a testa tonda. Dimensione prodotto: 100x10x90cm.

*EN - Monolithic shelf support frame, vertical structural element designed to assembly 2 shelves: by assembling it + shelves in series with an RPMC-2 rack it is possible to obtain multi-span rack, which can store both hexagonal and round head dumbbells. Product size: 100x10xH90cm.*



## RIPIANO STANDARD STANDARD SHELF

### cod. RSTD

I - Ripiano portante, costituisce l'elemento strutturale orizzontale a collegamento dei telai di supporto: se montato con le nervature verso l'alto può ospitare 4 coppie di sedi per manubri a testa tonda (SSMT) montandolo con le nervature verso il basso invece, può ospitare il vassoio per lo stivaggio dei manubri esagonali (VME). Dimensione prodotto: 161x32,5x6 cm.

*EN - Load-bearing shelf, it constitutes the horizontal structural element connecting the sides: if mounted with the ribs facing upwards, it can accommodate 4 pairs of seats for round-headed dumbbells (SSMT); by mounting it with the ribs facing downwards, it can accommodate the shelf for storing the hexagonal dumbbells (VME). Product size: 161x32,5x6 cm.*



Esempio di RSTD assemblato  
Example of RSTD assembled



## VASSOIO MANUBRI ESAGONALI HEX DUMBBELLS SHELF

cod. VME

I - Ripiano privo di divisioni, da montare sul ripiano standard (RSTD) capovolto: questa configurazione consente lo stivaggio dei manubri esagonali in quantità dipendente dalle pezzature riposte. Dimensione prodotto: 160x40x7cm.

*EN - Shelf without divisions, to be mounted on the standard shelf (RSTD) upside down: this configuration allows the storage of hexagonal dumbbells in quantities depending on the size of the items stored. Product size: 160x40xH7cm.*



Esempio di VME assemblato  
Example of VME assembled

## SET 16 SEDI PER MANUBRI TONDI SET OF 16 ROUND DUMBBELLS SEATS

cod. SSMT

I - Sedi in ABS per lo stoccaggio dei manubri a testa tonda - 16 pezzi.

*EN - ABS seats for storing round-headed dumbbells - 16 pieces.*



Esempio di SSMT assemblato  
Example of SSMT assembled



**RASTRELLIERA STUDIO  
PORTA MANUBRI A 2 RIPIANI**  
*STUDIO RACK FOR DUMBBELLS WITH 2 SHELVES*

**cod. RPM-B12**

I - Rastrelliera porta manubri a 2 ripiani 10/12 coppie.  
Dimensione prodotto: 192x87xH95 cm.

*EN - Dumbbells rack with 2 shelves (10/12 pairs).  
Product size: 192x87xH95 cm.*



**RASTRELLIERA  
PORTA MANUBRI 10 COPPIE**  
*DUMBBELLS RACK 10 PAIRS*

**cod. RPM-B10**

I - Rastrelliera porta manubri a colonna 10 coppie.  
Sedi di appoggio dei manubri con protezioni in PE.  
Dimensione prodotto: 47x47xH121 cm

*EN - Dumbbells rack 10 pairs. Seats with PE protections.  
Product size: 47x47xH121 cm*



**RASTRELLIERA  
PORTA MANUBRI IN VINILE**  
*VINYL DUMBBELLS RACK*

**cod. RMV-B**

I - Rastrelliera porta manubri in vinile con ruote di trasporto.  
Dimensione prodotto: 100x50xH105 cm.

*EN - Vinyl dumbbells rack with moving wheels.  
Product size: 100x50xH105 cm.*



**RASTRELLIERA  
PORTA MANUBRI 6 COPPIE  
DUMBBELLS RACK 6 PAIRS**

**cod. RPM-B6**

I - Rastrelliera porta manubri 6 coppie.  
Dimensione prodotto: 72x52xH107 cm.

*EN - Dumbbells rack 6 pairs.  
Product size: 72x52xH107 cm.*



**RASTRELLIERA  
PORTA MANUBRI A 3 RIPIANI  
DUMBBELLS RACK WITH 3 SHELVES**

**cod. RPM-B3R**

I - Rastrelliera porta manubri a 3 ripiani. Adatto a manubri fino a 22,5 Kg  
Dimensione prodotto: 134x54,5xH95 cm

*EN - Dumbbells rack with 3 shelves. Suitable for dumbbells up to 22.5 kg.  
Product size: 134x54,5xH95 cm*



**RASTRELLIERA  
PORTA BILANCIERI 5 POSTI  
BARBELLS RACK 5 PLACES**

**cod. RPBP-5**

I - Progettata per riporre 5 bilancieri precaricati. Sedi di appoggio del bilanciere protette con inserti in HDPE.  
Dimensione prodotto: 82,3x78,3xH130,6 cm.

*EN - Suitable for preloaded barbells. Barbell seats protected with HDPE pads.  
Product size: 82,3x78,3xH130,6 cm.*





**DISCHI OLIMPICI IN GHISA GOMMATA**  
**OLYMPIC RUBBER COATED CAST IRON WEIGHT PLATES**

I - Disco olimpico ricoperto in gomma inodore con finitura gofrata e design "trigrip" e boccia svasata in acciaio inox per un agevole carico-scarico della barra. Boccia olimpica 50mm.

*EN - Odorless rubber coated olympic weight plates, with rough finishing and 'trigrip' design stainless steel bushing for a more comfortable loading-unloading. Olympic bushing 50mm.*

- cod. **DGG-TG1.25** - Kg. 1,25 tri grip
- cod. **DGG-TG2.5** - Kg. 2,5 tri grip
- cod. **DGG-TG5** - Kg. 5 tri grip
- cod. **DGG-TG10** - Kg. 10 tri grip
- cod. **DGG-TG15** - Kg. 15 tri grip
- cod. **DGG-TG20** - Kg. 20 tri grip
- cod. **DGG-TG25** - Kg. 25 tri grip

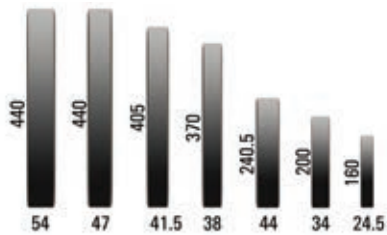

**DISCHI OLIMPICI IN GHISA**  
**OLYMPIC CAST IRON WEIGHT PLATES**

I - Disco olimpico in ghisa nera con design "trigrip". Boccia olimpica 50mm.

*EN - Olympic cast iron weight plates with 'trigrip' design Olympic bushing 50mm.*

- cod. **DGN-TG1.25** - Kg. 1,25 tri grip
- cod. **DGN-TG2.5** - Kg. 2,5 tri grip
- cod. **DGN-TG5** - Kg. 5 tri grip
- cod. **DGN-TG10** - Kg. 10 tri grip
- cod. **DGN-TG15** - Kg. 15 tri grip
- cod. **DGN-TG20** - Kg. 20 tri grip
- cod. **DGN-TG25** - Kg. 25 tri grip

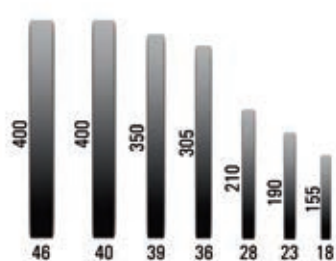

## DISCHI BUMPER COMPETITION

### COMPETITION BUMPER WEIGHT PLATES

I - Disco olimpico in gomma colorata con piastra centrale in acciaio.  
La colorazione dei dischi è conforme ai regolamenti IWF.  
Diametro disco 45cm. / Boccola olimpica 50mm.

*EN - Olympic coloured rubber weight plate with steel core.  
Colours IWF compliant. Plate diameter 45cm. / Olympic bushing 50mm.*

cod. DBC-5 - Kg. 5  
cod. DBC-10 - Kg. 10  
cod. DBC-15 - Kg. 15  
cod. DBC-20 - Kg. 20  
cod. DBC-25 - Kg. 25

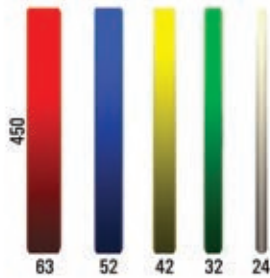

## DISCHI BUMPER CHALLENGE

### CHALLENGE BUMPER WEIGHT PLATES

I - Disco olimpico in gomma colorata con boccola svasata in acciaio inox.  
La colorazione dei dischi è conforme ai regolamenti IWF.  
Diametro disco 45cm. / Boccola olimpica 50mm.

*EN - Olympic coloured rubber weight plate with bushing in inox steel.  
Colours IWF compliant. Plate diameter 45cm. / Olympic bushing 50mm.*

cod. DBCH-5 - Kg. 5  
cod. DBCH-10 - Kg. 10  
cod. DBCH-15 - Kg. 15  
cod. DBCH-20 - Kg. 20  
cod. DBCH-25 - Kg. 25

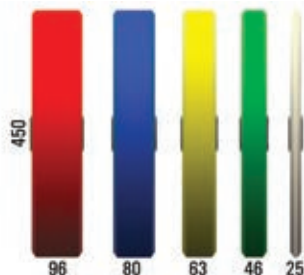

**DISCHI BUMPER CRUMB****BUMPER CRUMB WEIGHT PLATES**

I - Disco olimpico in gomma puntinata con boccia svasata in acciaio inox. Silenziosità e una minore capacità di rimbalzo, rendono i dischi bumper crumb ideali per gli allenamenti funzionali. Non adatti a centri crosstraining. Diametro disco 45cm. / Boccia olimpica 50mm.

*EN - Olympic weight plates made with rubber with coloured dots. No noise and low rebounding capacity make the crumb weight plates perfect for functional training. Not suitable for crosstraining boxes. Diametro disco 45cm. / Boccia olimpica 50mm.*

cod. DBCR-5 - Kg. 5      cod. DBCR-20 - Kg. 20  
 cod. DBCR-10 - Kg. 10    cod. DBCR-25 - Kg. 25  
 cod. DBCR-15 - Kg. 15

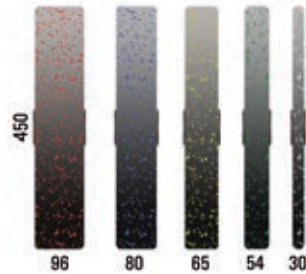
**DISCHI BUMPER TRAINING ABSOLUTE****TRAINING BUMPER WEIGHT PLATES ABSOLUTE**

I - Disco olimpico in gomma nera con boccia svasata in acciaio inox. Colore di numeri e grafica conformi ai regolamenti IWF. Diametro disco 45cm. / Boccia olimpica 50mm.

*EN - Olympic black rubber weight plate with stainless steel bushing. Colours IWF compliant. Plate diameter 45cm. / Olympic bushing 50mm.*

cod. ADBT-5 - Kg. 5  
 cod. ADBT-10 - Kg. 10  
 cod. ADBT-15 - Kg. 15  
 cod. ADBT-20 - Kg. 20  
 cod. ADBT-25 - Kg. 25

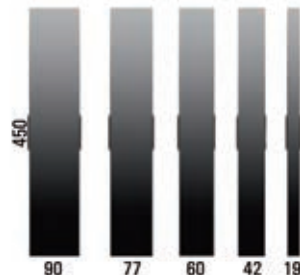



**COPPIA DISCHI TECHNIQUE**  
**TECHNIQUE PLATES**

I - Dischi olimpici in HDP con foro 50 mm. Ideati per la didattica degli esercizi con bilanciere libero.

*EN - Olympic HDP weight plates with 50 mm diameter hole. Designed for teaching.*

**cod. CDT-2.5** - Kg. 2.5  
**cod. CDT-5** - Kg. 5



**COPPIA DISCHI MICROCARICHI GOMMATI**  
**FRACTIONAL RUBBER COATED WEIGHT PLATES**

I - Coppia dischi microcarichi olimpici in gomma nera con foro ø 50 mm. Disponibili in 5 varianti di peso, consentono un allenamento preciso con aumento graduale del carico.

*EN - Fractional black rubber weight plates with ø50 mm hole. Available in 5 different weights, these plates allow a very precise workout with gradual loading increase.*

**cod. CDBM-0.5** - 2 x 0,5 kg  
**cod. CDBM-1** - 2 x 1 kg  
**cod. CDBM-1.5** - 2 x 1,5 kg  
**cod. CDBM-2** - 2 x 2 kg  
**cod. CDBM-2.5** - 2 x 2,5 kg



**COPPIA DISCHI MICROCARICHI IN ACCIAIO**  
**FRACTIONAL STEEL COATED WEIGHT PLATES**

I - Coppia dischi microcarichi in acciaio di colore nero con foro ø50 mm. Disponibili in 6 varianti di peso, consentono un allenamento preciso con aumento graduale del carico.

*EN - Fractional steel weight plates, with 50 mm diameter. These plates allow a very precise workout with gradual loading increase. Available in 6 different weights.*

**cod. CDM-025** - 2 x 0,25 kg  
**cod. CDM-05** - 2 x 0,5 kg  
**cod. CDM-1** - 2 x 1 kg  
**cod. CDM-1.5** - 2 x 1,5 kg  
**cod. CDM-2** - 2 x 2 kg  
**cod. CDM-2.5** - 2 x 2,5 kg



## **RASTRELLIERA PORTA DISCHI STUDIO** **STUDIO RACK FOR WEIGHT PLATES**

**cod. RPD-B50STUDIO**

I - Rastrelliera ad 8 manicotti di carico. Interasse adatto a dischi "trigrip" design.  
Dimensione prodotto: 116x116xH130 cm

*EN - Rack for weight plates with 8 plates holders suitable for "trigrip" design weight plates.  
Product size: 116x116xH130 cm*



## **RASTRELLIERA PORTA DISCHI PRO** **WEIGHT PLATES RACK PRO**

**cod. RPD-B50PRO**

I - Rastrelliera con 8 manicotti di carico. Interasse adatto a dischi "trigrip" design.  
Dimensione prodotto: 58x53xH96 cm

*EN - Rack for weight plates with 8 plates holders suitable for "trigrip" design weight plates.  
Product size: 58x53xH96 cm*



## **RASTRELLIERA VERTICALE PORTA DISCHI BUMPER E BILANCIERI** **VERTICAL BUMPER WEIGHT PLATES AND BARBELLS RACK**

**cod. RBV-B6**

I - Rastrelliera verticale porta dischi con 6 manicotti di carico e 6 porta bilancieri. Interasse adatto a dischi bumper. Dimensione prodotto: 70x70xH140,5 cm.

*EN - Vertical bumper weight plates and barbells rack with 6 plate holders and 6 barbell seats. Product size: 70x70xH140,5 cm.*



## **RASTRELLIERA ORIZZONTALE PORTA DISCHI BUMPER** **HORIZONTAL BUMPER WEIGHT PLATES RACK**

**cod. RBO**

I - Rastrelliera porta dischi bumper orizzontale con 8 divisioni, maniglia e ruote posteriori per lo spostamento. Dotata di manicotto per stivaggio microcarichi. Dimensione prodotto: 142x31xH27 cm

*EN - Horizontal bumper weight plates rack with 8 dividers, handle and rear moving wheels. With fractional bumper weight plates holders. Product size: 142x31xH27 cm*





**BILANCIERE CROSS COMPETITION 1000****CROSS COMPETITION 1000 BARBELL****cod. BO-1000**

I - Bilanciere olimpico con finitura hard chrome. Manicotti torniti antiscivolo montati su 4 cuscinetti a rulli e 2 bronzine. Carico max statico 1000 Kg. Lunghezza 220 cm. Peso 20 Kg. Diametro impugnatura 28 mm.

EN - Olympic chromed barbell hard chromed finishing. Sleeves with non-slip turned surface - 4 needle bearings + 2 bronze bushings. Max load 1000 Kg. Length. 220 cm. Weight 20 Kg. Grip dia. 28 mm.

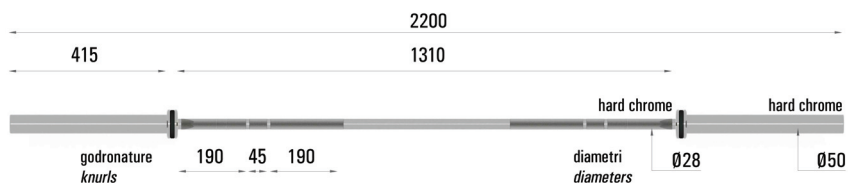
**BILANCIERE CROSS MASTER 700****CROSS MASTER 700 BARBELL****cod. BO-700**

I - Bilanciere olimpico con finitura hard chrome. Manicotti torniti antiscivolo montati su 3 cuscinetti a rulli e 2 bronzine. Carico max statico 700 Kg. Lunghezza 220 cm. Peso 20 Kg. Diametro impugnatura 28 mm.

EN - Olympic chromed barbell hard chromed finishing. Sleeves with non-slip turned surface - 3 needle bearings + 2 bronze bushings. Max load 700 Kg. Length. 220 cm. Weight 20 Kg. Grip dia. 28 mm.

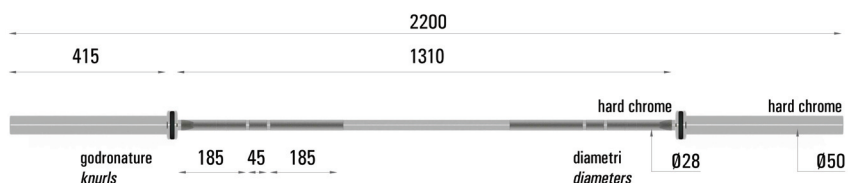

**BILANCIERE CROSS CHALLENGE 450****CROSS CHALLENGE 450 BARBELL****cod. BO-450**

I - Bilanciere olimpico in acciaio brunito. Manicotti con finitura superficiale hard chrome torniti antiscivolo montati su 2 cuscinetti a rulli e 2 bronzine. Carico max statico 450 Kg. Lunghezza 220 cm. Peso 20 Kg. Diametro impugnatura 28 mm.

*EN - Olympic black oxide barbell. Sleeves with non-slip turned surface - 2 needle bearings + 2 bronze bushings. Max load 450 Kg. Length. 220 cm. Weight 20 Kg. Grip dia. 28 mm.*

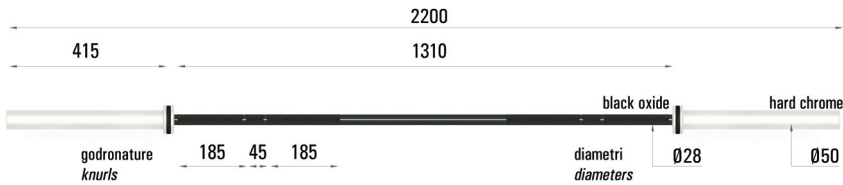
**BILANCIERE CROSS CHALLENGE WOMEN 250****CROSS CHALLENGE WOMEN 250 BARBELL****cod. BO-250**

I - Bilanciere olimpico in acciaio brunito. Manicotti con finitura superficiale hard chrome torniti antiscivolo montati su 2 cuscinetti a rulli e 2 bronzine. Carico max statico 250 Kg. Lunghezza 201 cm. Peso 15 Kg. Diametro impugnatura 25 mm.

*EN - Olympic black oxide barbell. Sleeves with non-slip turned surface - 2 needle bearings + 2 bronze bushings. Max load 250 Kg. Length. 201 cm. Weight 15 Kg. Grip dia. 25 mm.*

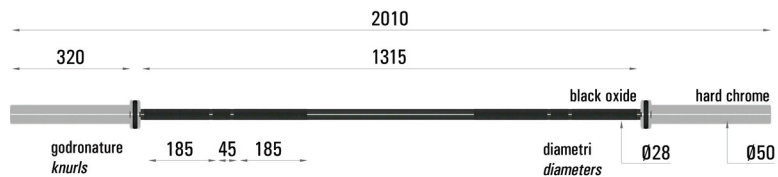

**BILANCIERE CROSS TECHNIQUE 200****CROSS TECHNIQUE 200 BARBELL****cod. BO-TEC200**

I - Bilanciere olimpico in alluminio con manicotti montati su 2 bronzine. Pensato per la didattica. Carico max statico 20 Kg. NON DROPPABILE. Lunghezza 200 cm. Peso 5 Kg. Diametro impugnatura 25 mm.

*EN - Aluminum olympic barbell with steel sleeves - 2 bronze bushings. Designed for teaching. Max load 20 Kg. NOT DROPPABLE. Length. 200 cm. Weight 5 Kg. Grip dia. 25 mm.*

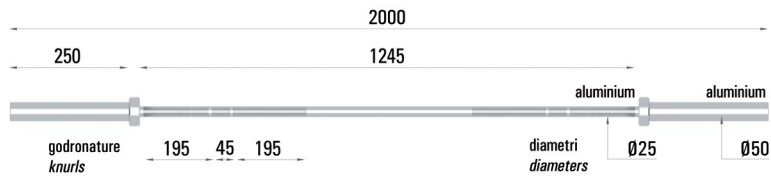
**BILANCIERE CROSS TECHNIQUE 180****CROSS TECHNIQUE 180 BARBELL****cod. BO-TEC180**

I - Bilanciere olimpico in alluminio con manicotti in acciaio cromato montati su 2 bronzine. Pensato per la didattica. Carico max statico 50 Kg. NON DROPPABILE. Lunghezza 180 cm. Peso 7,5 Kg. Diametro impugnatura 28 mm.

*EN - Aluminum olympic barbell with steel sleeves - 2 bronze bushings. Designed for teaching. Max load 50 Kg. NOT DROPPABLE. Length. 180 cm. Weight 7,5 Kg. Grip dia. 28 mm.*

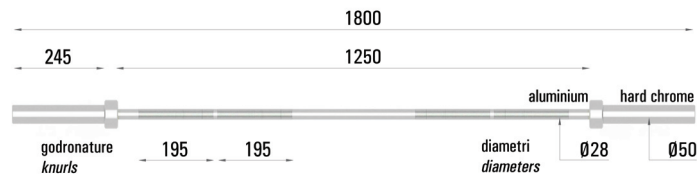



**BILANCIERE OLIMPICO ESAGONALE TRIGRIP****TRIGRIP OLYMPIC HEX BARBELL****cod. OSB-PRO**

I - Bilanciere olimpico esagonale con tripla impugnatura. Telaio a sezione scatolare. Carico max statico 300 Kg. Lunghezza 180 cm. Lunghezza manicotti 40 cm. Peso 28 Kg. Diametro impugnature 25/38/50 mm.

**EN** - Olympic hex chromed shrug bar with triple grip - spring clip safety collars. Max static load 300 Kg. Length 180 cm. Sleeves length 40 cm. Weight 28 Kg. Grip dia 25/38/50 mm.

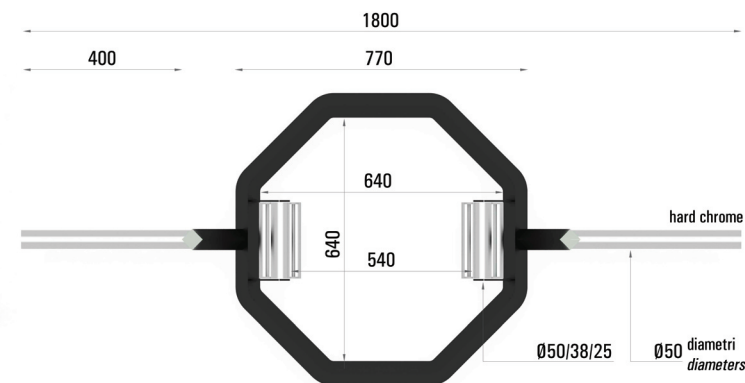
**SPECIAL****BILANCIERE OLIMPICO ESAGONALE****OLYMPIC HEX BARBELL****cod. OSB**

I - Bilanciere olimpico esagonale con doppia impugnatura. Carico max statico 300 Kg. Lunghezza 175 cm. Lunghezza manicotti 41 cm. Peso 28 Kg. Diametro impugnature 25 mm.

**EN** - Olympic hex chromed shrug bar with dual-handle - spring clip safety collars - grip 25 mm. - Max static load 300 Kg. Length 175 cm. Sleeves length 41 cm. Weight 28 Kg. Grip dia 25 mm.

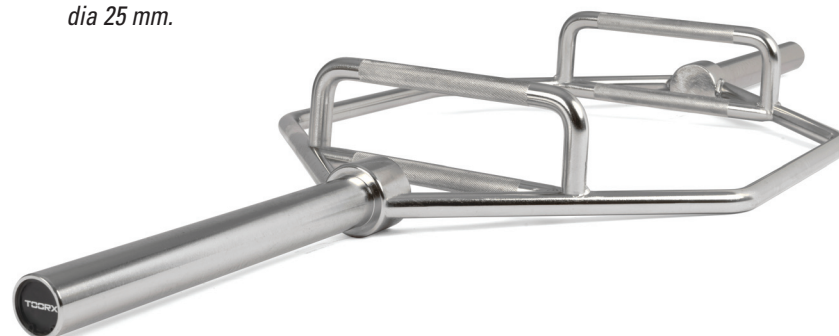
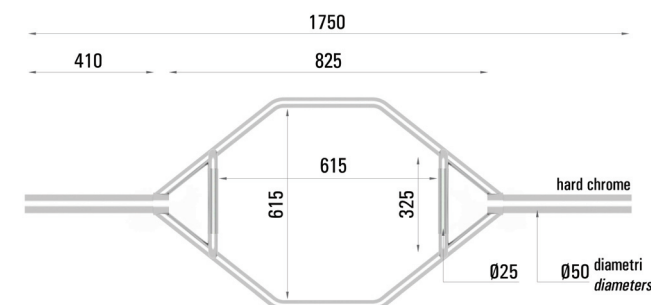
**SPECIAL**

## SAFETY SQUAT BAR

### cod. SSB

I - Bilanciere cromato sagomato con roller di appoggio singolo per il collo e doppio per le spalle. Manicotti hard chromed con tornitura antiscivolo montati su 2 cuscinetti a sfera e 2 bronzine. Carico max statico 320 kg. Lunghezza 220 cm. Lunghezza Manicotti 31,5 cm. Peso 20 Kg. Diametro impugnatura 28 mm. Roller spalle 250 x ø115mm. Roller collo 265 x ø80mm.

*EN - Chromed barbell with neck and shoulders roller pads. Chromed barbell chromed sleeves + non-slip turned surface - 2 needle bearings + bronze bushings - max static load 320 Kg. Lenght 220 cm. Sleeves lenght 31,5 cm. Weight 20 Kg. Grip dia 28 mm. Rollers (shoulders) 250 x ø115mm. Roller (neck) 265 x ø80mm.*

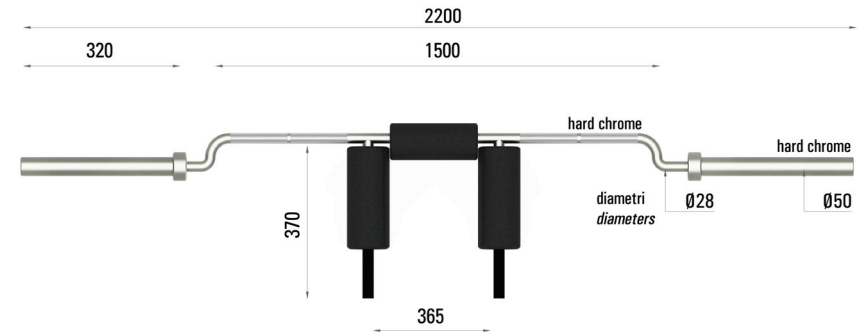

## OFFSET BAR

### cod. OB

I - Bilanciere cromato sagomato per utilizzo in panca supina o seal row bench. Manicotti hard chromed montati su 2 cuscinetti a sfera e 2 bronzine. carico max statico 320 kg. Lunghezza 220 cm. Lunghezza Manicotti 41 cm. Peso 20 Kg. Diametro impugnatura 28mm.

*EN - Chromed barbell shaped for supine bench or seal row bench use. Hard chromed sleeves - 2 needle bearings + bronze bushings - max static load 320 Kg. Lenght 220 cm. Sleeves lenght 41 cm. Weight 20 Kg. Grip ø 28 mm.*

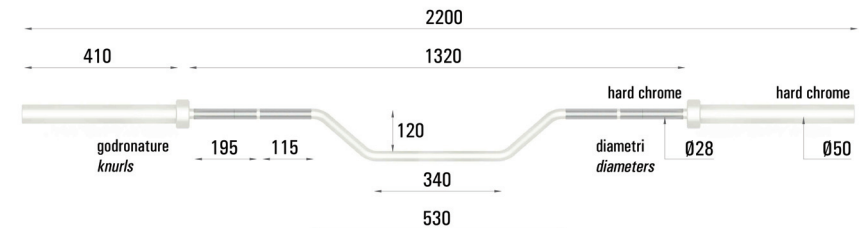

**BILANCIERE POWER TRAINING 220****POWER TRAINING 220 BARBELL****cod. B0-220**

I - Bilanciere olimpico con finitura superficiale hard chromed. Carico max. statico 320 Kg.  
NON DROPPABILE. Lunghezza 220 cm. Lunghezza manicotti 41,5 cm. Peso 20 Kg.  
Diametro impugnatura 28 mm.

*EN - Olympic hard chromed barbell – sleeves with bronze bushings - max static load 320 Kg.  
NOT DROPPABLE. Length 220 cm. Sleeves length 41,5 cm. Weight 20 Kg. Grip dia 28 mm.*

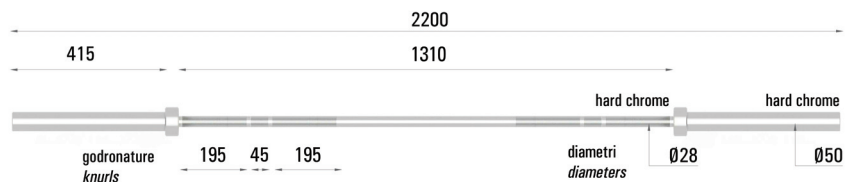
**BILANCIERE POWER TRAINING 180****POWER TRAINING 180 BARBELL****cod. B0-180**

I - Bilanciere olimpico con finitura superficiale hard chromed. Carico max. statico 320 Kg.  
NON DROPPABILE. Lunghezza 180 cm. Lunghezza manicotti 25 cm. Peso 15 Kg.  
Diametro impugnatura 28 mm.

*EN - Olympic chromed barbell – sleeves with bronze bushings - max static load 320 Kg.  
NOT DROPPABLE. Length 180 cm. Sleeves length 25 cm. Weight 15 Kg. Grip dia 28 mm.*

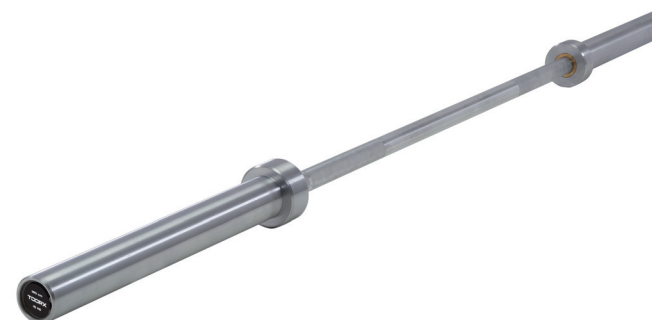
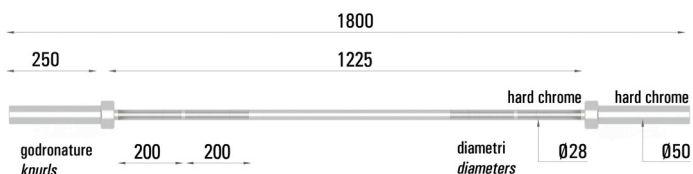



**BILANCIERE POWER TRAINING 150****POWER TRAINING 150 BARBELL****cod. B0-150**

I - Bilanciere olimpico con finitura superficiale hard chromed. Carico max. statico 320 Kg. Lunghezza 150 cm. Lunghezza manicotti 25 cm. Peso 13 Kg. Diametro impugnatura 28 mm.

*EN - Olympic hard chromed barbell - max static load 320 Kg. Lenght 150 cm. Sleeves lenght 25 cm. Weight 13 Kg. Grip dia 28 mm.*

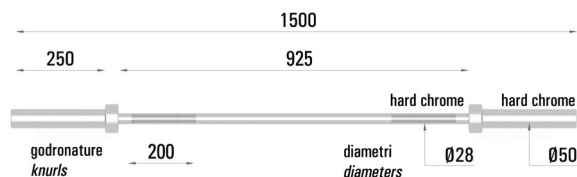
**BILANCIERE POWER TRAINING 120****POWER TRAINING 120 BARBELL****cod. BCO-120**

I - Bilanciere olimpico curl con finitura superficiale hard chromed. Carico max statico 300 Kg. Lunghezza 120 cm. Lunghezza manicotti 18 cm. Peso 9 Kg. Diametro impugnatura 28 mm.

*EN - Olympic chromed EZ curl barbell - max static load 300 Kg. Lenght 120 cm. Sleeves lenght 18 cm. Weight 9 Kg. Grip dia 28 mm.*

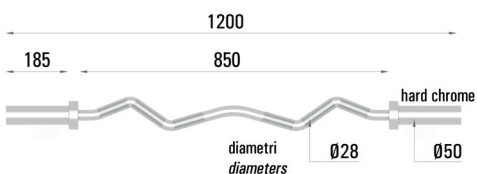

**BILANCIERE POWER TRAINING 86****POWER TRAINING 86 BARBELL****cod. BCO-86**

I - Bilanciere olimpico multipresa finitura cromata. Carico max 300 Kg.  
Lunghezza 86 cm. Lunghezza manicotti 17,5 cm. Peso 12 Kg. Diametro impugnatura 28 mm.

EN - Olympic chromed triceps barbell - max static load 300 Kg.  
Lenght 86 cm. Sleevs length 17,5 cm. Weight 12 Kg. Grip dia 28 mm.

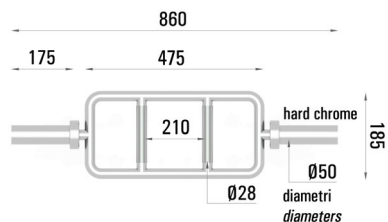
**MANUBRIO POWER TRAINING 51****POWER TRAINING 51 DUMBBELL****cod. MCO-51**

I - Manubrio olimpico caricabile finitura cromata con manicotti montati su bronzine  
Lunghezza 51 cm. Lunghezza manicotti 16,5 cm. Peso 5 Kg. Diametro impugnatura 28 mm.

EN - Olympic chromed dumbbell 51 cm. with bronze bushings.  
Lenght 51 cm. Sleevs lenght 16.5 cm. Weight 5 Kg. Grip dia 28 mm.

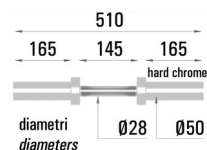

## **RASTRELLIERA PRO PORTA BILANCIERI DA TERRA** **FLOOR BARBELLS RACK PRO**

**cod. RPB-9PRO**

I - Rastrelliera porta bilancieri olimpici da terra (9 posti) con boccole di protezione per i manicotti terminali.

Dimensioni: 43x43xH17,9 cm

*EN - Floor olympic barbells rack (9 places) with bushing for barbells sleeves.  
Product size: 43x43xH17,9 cm*



## **RASTRELLIERA PORTA BILANCIERI DA TERRA** **FLOOR BARBELLS RACK**

**cod. RPB-9**

I - Rastrelliera porta bilancieri olimpici da terra (9 posti) con boccole di protezione per i manicotti terminali.

Dimensioni: 42x57xH22 cm

*EN - Floor olympic barbells rack (9 places) with bushing for barbells sleeves.  
Product size: 42x57xH22 cm*





## RASTRELLIERA PORTA BILANCIERI A PARETE WALL BARBELLS RACK

cod. RBV-3PRO

I - Rastrelliera porta bilancieri olimpici a parete (3 posti) con inserti di protezione in HDPE.

*EN - Wall olympic barbells rack (3 places) with HDPE protection pads.*



Bilancieri non inclusi.  
Barbells not included



## RASTRELLIERA PORTA BILANCIERI A PARETE WALL BARBELLS RACK

cod. RPB-8

I - Rastrelliera porta bilancieri olimpici a parete (8 posti) con inserti di protezione in HDPE.

*EN - Wall olympic barbells rack (8 places) with HDPE protection pads.*



Bilancieri non inclusi.  
Barbells not included

## JERK BLOCKS IMPILABILI STACKABLE JERK BLOCKS

cod. AHF-274

I - Realizzati in legno di betulla multistrato. Impilabili. 2x40, 2x30, 2x15, 2x6 cm  
Dimensioni 91 x 51 x H(40/30/15/6).

*EN - Made of birch plywood. Stackables. 2x40, 2x30, 2x15, 2x6 cm  
Dimensions: 91 x 51 x H(40/30/15/6).*



## COPPIA DI CUSCINI AMMORTIZZANTI DROP MATS DROP MATS

cod. AHF-257

I - Coppia di cuscini in grado di assorbire la caduta dei bilancieri, riducendo vibrazioni, rumore e impatto. Struttura interna in foam ad alta densità. Rivestimento in PVC.  
Dimensione cuscino singolo 60x100xH18 cm.

*EN - Shock mats able to absorb the barbells drops, reducing vibrations, noise and impact. Made of high density foam. PVC cover. Single mat dimensions 60x100xH18 cm*



Dischi peso e bilanciere non inclusi.  
Weight plates and barbell not included.

**TOTAL CORE CON BASE****TOTAL CORE WITH BASE****cod. AHF-155**

I - Piattaforma con superficie inferiore gommata antiscivolo, perno rotante a 360° e doppio inserto per bilancieri ø25 / ø50 mm. Con impugnatura T-Bar.

*EN - Platform with no slip rubber lower surface, 360° swivel and dual bar bracket to fit both ø25 / ø50 mm barbells. "T-bar" handles included.*

**IMPUGNATURA T-BAR****T-BAR HANDLE****cod. AHF-280**

I - Impugnatura antiscivolo per una presa ottimale.

*EN - Anti-slip handle for an optimal grip*

**TOTAL CORE****cod. AHF-198**

I - Snodo girevole. Inserto per bilancieri ø 50 mm. Il perno deve essere ancorato ad uno o più dischi olimpici per garantire stabilità durante l'esercizio. Ideale per allenamento core.

*EN - Swivel junction. Bar bracket suitable for ø 50 mm barbells. To be anchored to one or more olympic weight plates to guarantee stability during the use. Ideal for core training.*



Dischi peso e bilanciere non inclusi.  
Weight plates and barbell not included.

**CUSCINO DI PROTEZIONE BILANCIERE  
PER HIP THRUST A CARICO LIBERO**  
*BARBELL PAD FOR FREE WEIGHT HIP THRUST*

**cod. CIP-HT**

I - Realizzato con interno in cotone riciclato e copertura in tessuto PE impermeabile.

Dimensioni: 400 x ø180 mm.

*EN - Made of recycled foam, PE waterproof cover.  
Dimensions: 400 x ø180 mm.*



**CUSCINO DI PROTEZIONE IN GOMMA PER  
BILANCIERE E SQUAT**  
*RUBBER BARBELL/SQUAT PAD*

**cod. CIP-G**

I - In gomma NBR e dotato di cinghietti di chiusura.

Dimensioni: 400 x ø80 mm.

*EN - Made of NBR rubber. Clousure straps included.  
Dimensions: 400 x ø80 mm.*



**CUSCINO IMBOTTITO DI PROTEZIONE  
PER BILANCIERE E SQUAT**  
*BARBELL/SQUAT PAD*

**cod. CIP**

I - In gomma NBR rivestito in tessuto PE impermeabile

Dimensioni: 400 x ø80 mm.

*EN - Made of NBR rubber with cover in waterproof PE.  
Dimensions: 400 x ø80 mm.*





## CINTURE PER SOLLEVAMENTO PESI WEIGHTLIFTING BELTS

cod. CC-15S-M - misura S-M - size S-M

cod. CC-15L - misura L - size L

cod. CC-15XL - misura XL - size XL

I - Cintura in cuoio h. 15cm.

*EN - Leather belt H. 15cm.*



cod. CC-10S-M - misura S-M - size S-M

cod. CC-10L - misura L - size L

cod. CC-10XL - misura XL - size XL

I - Cintura in cuoio h. 10cm.

*EN - Leather belt H. 10cm.*



cod. CN-13,5

I - Cintura in nylon e neoprene h. 13,5cm e lunghezza 125cm con chiusura velcro misura unica

*EN - Neoprene/nylon belt H. 13,5cm - L. 125cm with velcro lock system one size fits all*



## CINTURA PER DIP CON SOVRACCARICO DIP BELT

cod. DIP-B

I - Cintura in cordura di nylon. La fascia centrale imbottita da 10cm. ed il gancio di collegamento della catena ne aumentano il comfort d'utilizzo.

Dimensioni: 70 x H10 cm

*EN - Nylon cordura belt. With central 10cm. padded band and a chain connection hook for high-comfort use.*

*Dimensions: 70 x H10 cm*



**GUANTI DI PROTEZIONE DEL PALMO 3 FORI**  
**WEIGHTLIFTING PALMS WITH 3 HOLES**

cod. **GPP3-S** - taglia S / size S

cod. **GPP3-M** - taglia M / size M

cod. **GPP3-L** - taglia L / size L

I - Paracalli con 3 fori e polsiera imbottita.

*EN - Palm glove with 3 holes and padded wrist guard.*

**GUANTI DI PROTEZIONE DEL PALMO IN PELLE**  
**LEATHER WEIGHTLIFTING PALMS**

cod. **GPP**

I - Paracalli con polsiera imbottita.

*EN - Palm glove with padded wrist guard.*

**COPPIA AB STRAPS CINGHIE NYLON**  
**PER TRAZIONI**

**AB STRAPS - PULLING NYLON BELTS**

cod. **AB-STRAPS**

I - Coppia di fasce in nylon per l'allenamento in sospensione del core.

*EN - Nylon bands for core suspension training.*



### COPPIA FERMA DISCHI IN ALLUMINIO PAIR OF ALUMINIUM SAFETY COLLARS

**cod. CFA**

I - Coppia ferma dischi in alluminio con pad interno antiscivolo color alluminio.

**EN** - Pair of aluminium safety collars with inner anti-slip pad aluminium colour.



### COPPIA FERMA DISCHI IN ALLUMINIO PAIR OF ALUMINIUM SAFETY COLLARS

**cod. CFAO**

I - Coppia ferma dischi in alluminio con pad interno antiscivolo color oro.

**EN** - Pair of aluminium safety collars with inner anti-slip pad gold colour.



### COPPIA FERMA DISCHI IN NYLON PAIR OF NYLON SAFETY COLLARS

**cod. CFSL**

I - Coppia ferma dischi SAFE LOCK – colore NERO

**EN** - Pair of collars SAFE LOCK – colour BLACK



### COPPIA FERMA DISCHI IN NYLON PAIR OF NYLON SAFETY COLLARS

**cod. CFSL-R**

I - Coppia ferma dischi SAFE LOCK – colore ROSSO

**EN** - Pair of collars SAFE LOCK – colour RED



### COPPIA FERMA DISCHI A MOLLA PAIR OF SPRING CLIP SAFETY COLLARS

**cod. CFBS**

I - Coppia ferma dischi a molla impugnatura big size.

**EN** - Pair of spring clip safety collars - big size grip.



### MAGNESITE IN PANI CHALK BLOCKS

**cod. AHF-185**

I - Ideale per gli allenamenti funzionali, ginnastica artistica, crosstraining e arrampicata sportiva. Disponibile in confezioni da 8 pani da 56 gr.

**EN** - Ideal for functional, gymnastic, crosstraining and climbing training. 8 blocks 56 gr each in a colour box.

