

GIARDINI

MASIERO



GIARDINI

MASIERO

Collections



Cordea
6

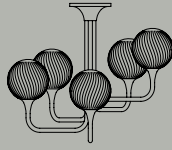

Tee
30

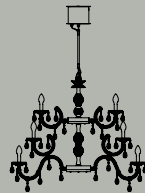

Drylight
56

Collections



Cordea

IT Cordea, ispirandosi alle luci degli spazi industriali di un tempo, reinterpreta una forma del passato in una visione sperimentale e contemporanea. Caratterizzata da un'alta fascia a contrasto che ne cinge il diffusore a cappello, è realizzata in forme e materiali studiati in sintonia con cromie volutamente classiche e neutre, capaci di creare atmosfere calde e confortevoli in ogni spazio outdoor.

EN Cordea, inspired by the lights of the industrial spaces of years gone by, reinterprets a shape from the past in an experimental, contemporary vision. Featuring a high-contrast band encircling the cap diffuser, it is made from shapes and materials designed in harmony with deliberately classic, neutral colours, to create a warm and comfortable atmosphere in any outdoor space.

DESIGN BY
FAVARETTO/PARTNERS

SUSPENSION
APPLIQUE
TABLE LAMP









CORDEA OUT
TL PORTABLE































Cordea

Struttura in metallo verniciato decorata con cinturino in gomma. Illuminazione Led. IP54

Painted metal structure decorated with a rubber strap. LED lighting. IP54

Gestell aus lackiertem Metall verziert mit einem Gummiband. LED-Leuchtmittel. IP54

Estructura de metal barnizado decorada con correa de goma. Iluminación LED. IP54

Structure en métal laqué décorée d'un bracelet en caoutchouc. Éclairage LED. IP54

КАРКАС ИЗ ОЦИНКОВАННОГО МЕТАЛЛА, ДЕКОР - КОЛЬЦО ИЗ РЕЗИНЫ. СВЕТОДИОДНОЕ ОСВЕЩЕНИЕ. IP54

饰有橡胶条带的涂色金属灯体结构。Led照明。防护等级IP54

هيكل معدني مطلي مزين بحزام مطاطي صغير. إضاءة ليد IP54

BAND FINISHING



E50 Windy Blue



BS1 Butter



E60 Highland

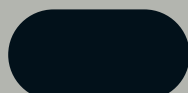

BS2 Black



E70 Champagne



BS3 Merlot



E80 Canyon

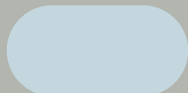

BS4 Baby Blue

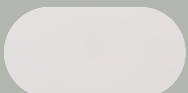

E95 Pure White



BS5 Green Olive



E98 Deep Black

CORDEA OUT S P IP54

Ø 22 cm / 8.70"
H 19 cm / 7.50"

INTEGRATED LED LIGHTING

10 W CRI>90
3000 K - 1510 NOMINAL LM

DIMM NO

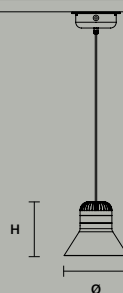

CORDEA OUT S G IP54

Ø 36 cm / 14.20"
H 16 cm / 6.30"

INTEGRATED LED LIGHTING

10 W CRI>90
3000 K - 1510 NOMINAL LM

DIMM NO

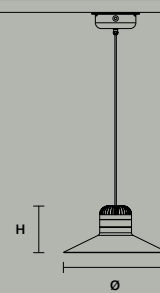

CORDEA OUT A P IP54

L 22 cm / 8.70"
H 19 cm / 7.50"
SP 30 cm / 11.80"

INTEGRATED LED LIGHTING

10 W CRI>90
3000 K - 1510 NOMINAL LM

DIMM NO

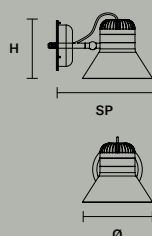

CORDEA OUT A G IP54

L 36 cm / 14.20"
H 16 cm / 6.30"
SP 44 cm / 17.30"

INTEGRATED LED LIGHTING

10 W CRI>90
3000 K - 1510 NOMINAL LM

DIMM NO

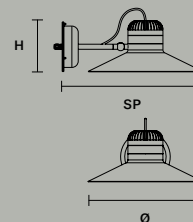

CORDEA OUT TL PORT IP54

L 22 cm / 8.70"
H 51 cm / 20.00"
SP 23.5 cm / 9.30"

INTEGRATED LED LIGHTING

5 W CRI>90
3000 K - 600 NOMINAL LM

DIMM OWN BUTTON

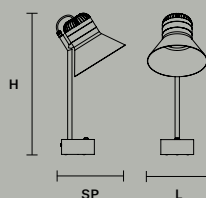

 For the US market, refer to the relevant price list.

INTEGRATED LED LIGHTING
30 W CRI>90
3000 K – 4530 NOMINAL LM

INTEGRATED LED LIGHTING
50 W CRI>90
3000 K – 7550 NOMINAL LM

INTEGRATED LED LIGHTING
30 W CRI>90
3000 K – 4530 NOMINAL LM

INTEGRATED LED LIGHTING
50 W CRI>90
3000 K – 7550 NOMINAL LM

DIMM TRIAC

DIMM TRIAC

DIMM TRIAC

DIMM TRIAC

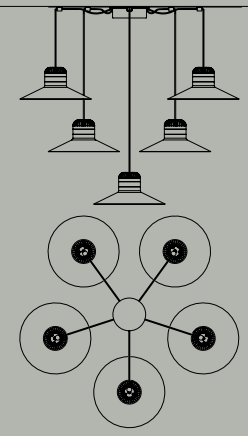
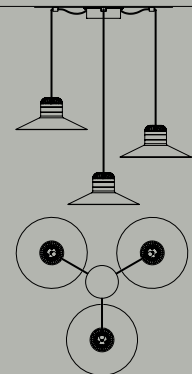
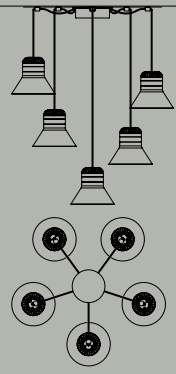
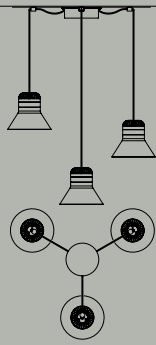

Finishings

BAND	FRAME					
BS1 Butter	€50 Windy Blue	€60 Highland	€70 Champagne	€80 Canyon	€95 Pure White	€98 Deep Black
						
BS2 Black	€50 Windy Blue	€60 Highland	€70 Champagne	€80 Canyon	€95 Pure White	€98 Deep Black
						
BS3 Merlot	€50 Windy Blue	€60 Highland	€70 Champagne	€80 Canyon	€95 Pure White	€98 Deep Black
						
BS4 Baby Blue	€50 Windy Blue	€60 Highland	€70 Champagne	€80 Canyon	€95 Pure White	€98 Deep Black
						
BS5 Green Olive	€50 Windy Blue	€60 Highland	€70 Champagne	€80 Canyon	€95 Pure White	€98 Deep Black
						

Tee

IT Tee è un esercizio progettuale di ricerca tra rigore geometrico ed eleganza, contrassegnato esteticamente dalla linea curva. Sfere luminose per gli esterni, animate da linee che richiamano la natura ondulatoria della luce e raccordate su steli curvati a foggia organica, ricordando la delicatezza del fiore di calla.

EN Tee is an exploratory design exercise which balances rigour and elegance, aesthetically distinguished by its curved form. Light spheres for the outdoors are brought to life by contours that reflect the undulating nature of light, connected on organically shaped stems, reminiscent of the gracefulness of the calla lily flower.

DESIGN BY
VALERIO COMETTI
+V12DESIGN

SUSPENSION
CEILING
APPLIQUE
TABLE LAMP
FLOOR LAMP
BOLLARD
GROUND

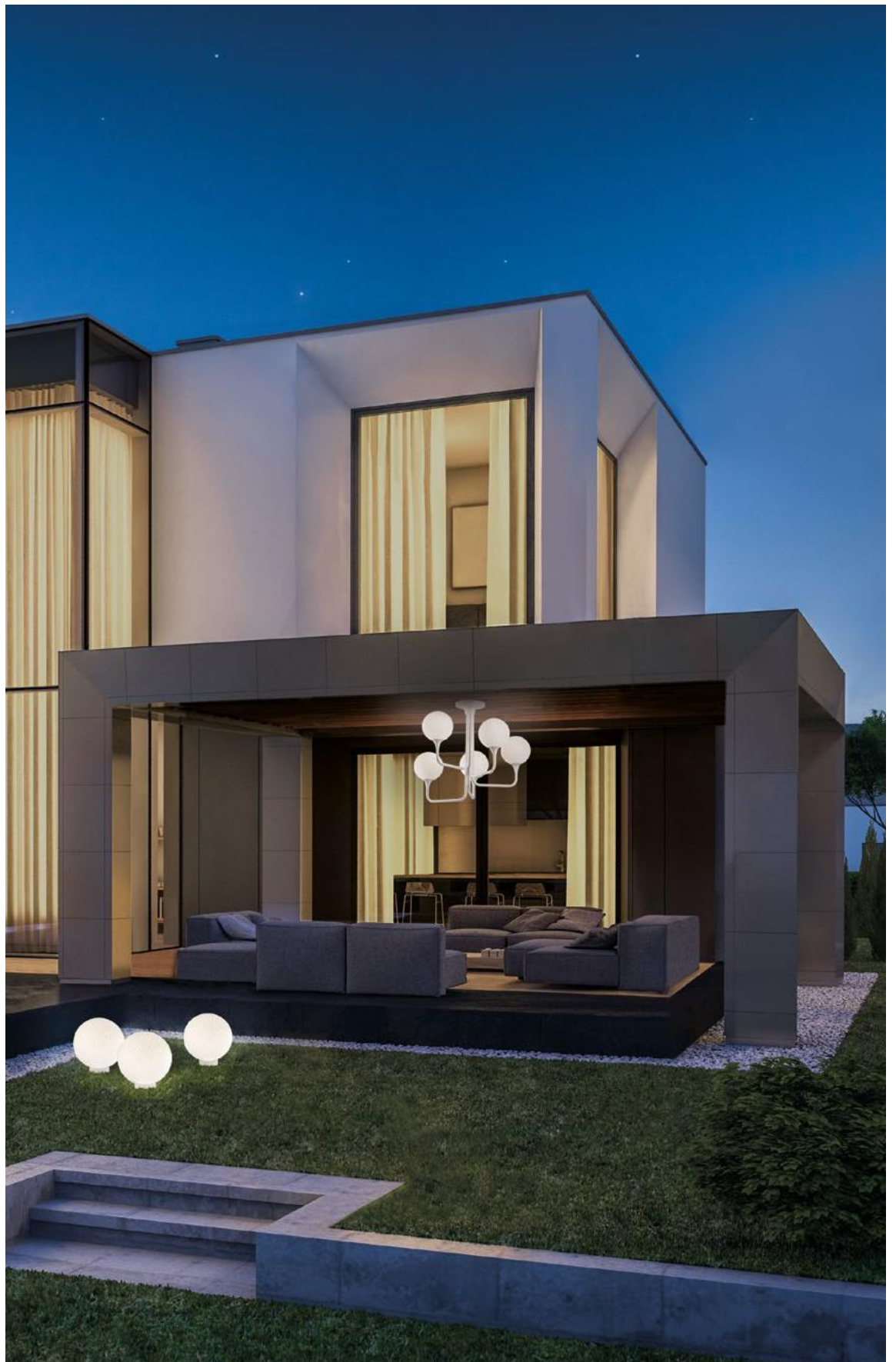









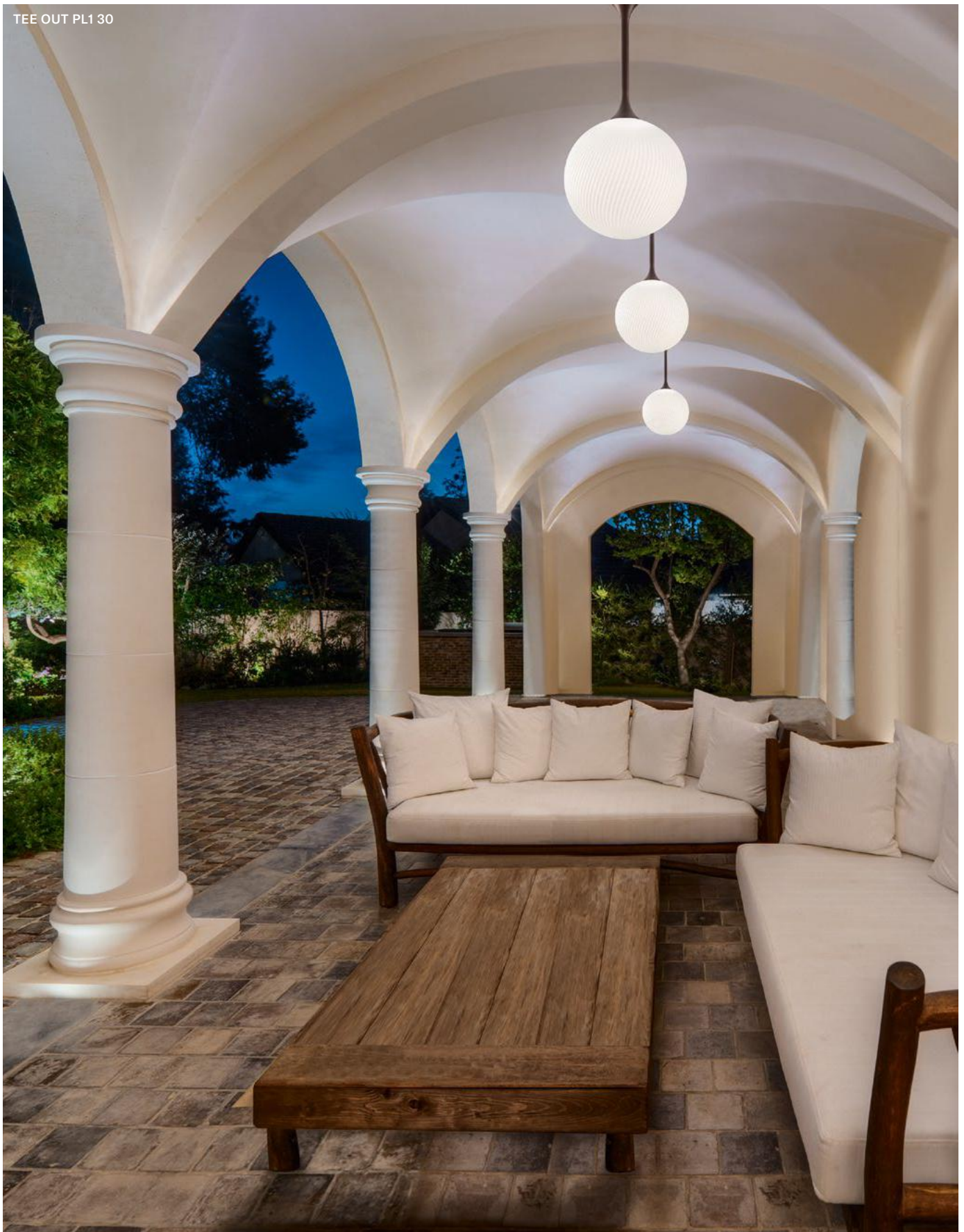

















TEE OUT BOL FIX 20



TEE OUT TL1 20
TEE OUT STL1 SELF







TEE OUT BOL STAKE 30
TEE OUT A1 20







Tee

Struttura in metallo verniciato.
Diffusori in polietilene.
Illuminazione tradizionale. IP54

Painted metal structure.
Polyethylene diffusers.
Traditional lighting. IP54

Gestell aus lackiertem Metall.
Schirme aus Polyethylen.
Herkömmliche Leuchtmittel. IP54

Estructura en metal barnizado.
Difusores en polietileno.
Iluminación tradicional. IP54

Structure en métal laqué.
Diffuseurs en polyéthylène.
Éclairage traditionnel. IP54

КАРКАС ИЗ ОКРАШЕННОГО МЕТАЛЛА.
ПЛАФОНЫ ИЗ ПОЛИЭТИЛЕНА.
ТРАДИЦИОННОЕ ОСВЕЩЕНИЕ. IP54

涂色金属灯体结构。聚乙烯灯罩。
传统照明。防护等级IP54

هيكل معدني مطلي. ناشرات ضوء من البولي إيثيلين
إضاءة تقليدية. IP54



E81 Hazelnut

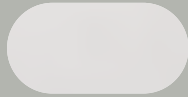

E95 Pure White

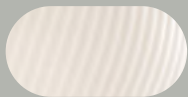

Polyethylene diffusers

TEE OUT S1 20

∅ 20 cm / 7.90"
H 30 cm / 11.80"

STANDARD LIGHTING

1 x E14x10 W MAX (NOT INCL.)*
USA 1 x E12x40 W MAX (NOT INCL.)*

* BULB MAX Ø 37 mm L 110 mm

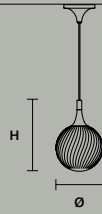

TEE OUT S1 30

∅ 30 cm / 11.80"
H 40 cm / 15.70"

STANDARD LIGHTING

1 x E27x20 W MAX (NOT INCL.)*
USA 1 x E26x60 W MAX (NOT INCL.)*

* BULB MAX Ø 62 mm L 185 mm

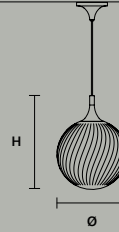

TEE OUT PL1 20

∅ 20 cm / 7.90"
H 49 cm / 19.30"

STANDARD LIGHTING

1 x E14x10 W MAX (NOT INCL.)*
USA 1 x E12x40 W MAX (NOT INCL.)*

* BULB MAX Ø 37 mm L 110 mm

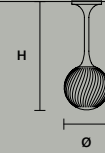

TEE OUT PL1 30

∅ 30 cm / 11.80"
H 64 cm / 25.20"

STANDARD LIGHTING

1 x E27x20 W MAX (NOT INCL.)*
USA 1 x E26x60 W MAX (NOT INCL.)*

* BULB MAX Ø 62 mm L 185 mm

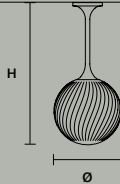

TEE OUT PL5

∅ 85 cm / 33.50"
H 68 cm / 26.80"

STANDARD LIGHTING

5 x E14x10 W MAX (NOT INCL.)*
USA 5 x E12x40 W MAX (NOT INCL.)*

* BULB MAX Ø 37 mm L 110 mm

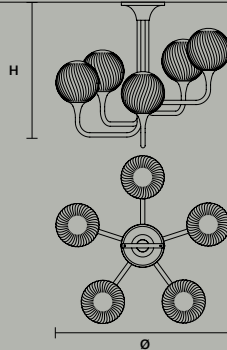

TEE OUT PL6 95

∅ 94 cm / 37.00"
H 66.5 cm / 26.20"

STANDARD LIGHTING

6 x E14x10 W MAX (NOT INCL.)*
USA 6 x E12x40 W MAX (NOT INCL.)*

* BULB MAX Ø 37 mm L 110 mm

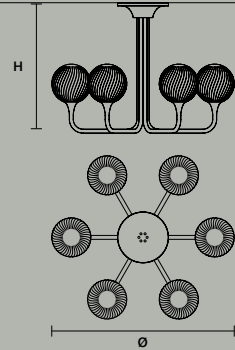

TEE OUT PL8 RD 120

∅ 120 cm / 47.20"
H 76.5 cm / 30.10"

STANDARD LIGHTING

8 x E14x10 W MAX (NOT INCL.)*
USA 8 x E12x40 W MAX (NOT INCL.)*

* BULB MAX Ø 37 mm L 110 mm

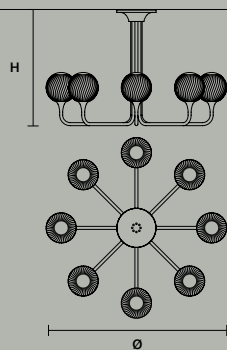

TEE OUT PL8 RD 160

∅ 167 cm / 65.70"
H 83.5 cm / 32.90"

STANDARD LIGHTING

8 x E27x20 W MAX (NOT INCL.)*
USA 8 x E26x60 W MAX (NOT INCL.)*

* BULB MAX Ø 62 mm L 185 mm

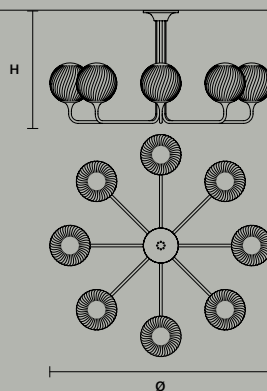

TEE OUT PL4+4 RD 100

∅ 100 cm / 39.40"
H 100 cm / 39.40"



STANDARD LIGHTING

8 x E14x10 W MAX (NOT INCL.)*
USA 8 x E12x40 W MAX (NOT INCL.)*

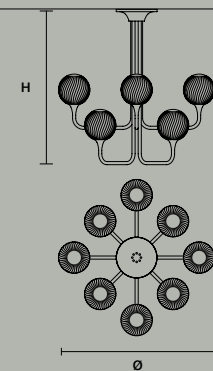
* BULB MAX Ø 37 mm L 110 mm



For the US market, refer to the relevant price list.

TEE OUT PL5+5 RD 120    IP54

∅ 120 cm / 47.20"
H 83.5 cm / 32.90"

STANDARD LIGHTING

10xE14x10 W MAX (NOT INCL.)*
USA 10xE12x40 W MAX (NOT INCL.)*

* BULB MAX ∅ 37 mm L 110 mm

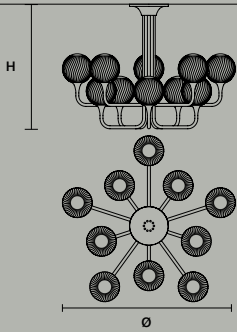

TEE OUT A1 20    IP54



L 20 cm / 7.90"
H 41 cm / 16.10"
SP 26 cm / 10.20"

STANDARD LIGHTING

1xE14x10 W MAX (NOT INCL.)*
USA 1xE12x40 W MAX (NOT INCL.)*

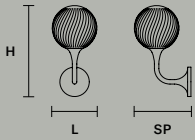
* BULB MAX ∅ 37 mm L 110 mm



TEE OUT PL8 OV 120    IP54

L 120 cm / 47.20"
H 63.5 cm / 25.00"
SP 80 cm / 31.50"

STANDARD LIGHTING

8xE14x10 W MAX (NOT INCL.)*
USA 8xE12x40 W MAX (NOT INCL.)*

* BULB MAX ∅ 37 mm L 110 mm

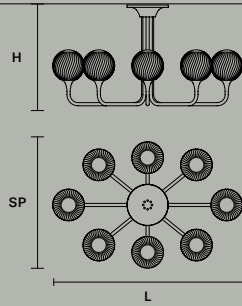

TEE OUT TL1 20    IP44



∅ 20 cm / 7.90"
H 48 cm / 18.90"

STANDARD LIGHTING

1xE14x10 W MAX (NOT INCL.)*
USA 1xE12x40 W MAX (NOT INCL.)*

* BULB MAX ∅ 37 mm L 110 mm



TEE OUT PL8 OV 160    IP54



L 160 cm / 63.00"
H 63.5 cm / 25.00"
SP 107 cm / 42.10"

STANDARD LIGHTING

8xE14x10 W MAX (NOT INCL.)*
USA 8xE12x40 W MAX (NOT INCL.)*

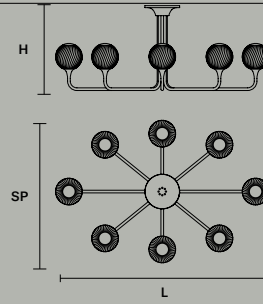
* BULB MAX ∅ 37 mm L 110 mm



TEE OUT GROUND 30    IP44



∅ 30 cm / 11.80"
H 33 cm / 13.00"

STANDARD LIGHTING

1xE27x20 W MAX (NOT INCL.)*
USA 1xE26x60 W MAX (NOT INCL.)*

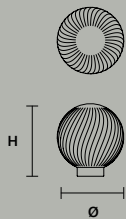
* BULB MAX ∅ 62 mm L 185 mm



TEE OUT BOL FIX 20    IP54



∅ 20 cm / 7.90"
H 55 cm / 21.70"

STANDARD LIGHTING

1xE14x10 W MAX (NOT INCL.)*
USA 1xE12x40 W MAX (NOT INCL.)*

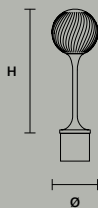
* BULB MAX Ø 37 MM L 110 MM



TEE OUT BOL STAKE 20    IP44



∅ 20 cm / 7.90"
H 55 cm / 21.70"

STANDARD LIGHTING

1xE14x10 W MAX (NOT INCL.)*
USA 1xE12x40 W MAX (NOT INCL.)*

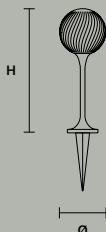
* BULB MAX Ø 37 MM L 110 MM



TEE OUT BOL FIX 30    IP54



∅ 30 cm / 11.80"
H 80 cm / 31.50"

STANDARD LIGHTING

1xE27x20 W MAX (NOT INCL.)*
USA 1xE26x60 W MAX (NOT INCL.)*

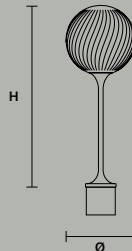
* BULB MAX Ø 62 mm L 185 mm



TEE OUT BOL STAKE 30    IP44

∅ 30 cm / 11.80"
H 80 cm / 31.50"

STANDARD LIGHTING

1xE27x20 W MAX (NOT INCL.)*
USA 1xE26x60 W MAX (NOT INCL.)*

* BULB MAX Ø 62 mm L 185 mm

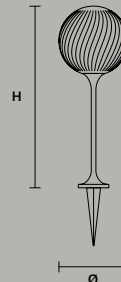

TEE OUT STL1 SELF    IP44

∅ 30 cm / 11.80"
H 160 cm / 63.00"

STANDARD LIGHTING

1xE27x20 W MAX (NOT INCL.)*
USA 1xE26x60 W MAX (NOT INCL.)*

* BULB MAX Ø 62 mm L 185 mm

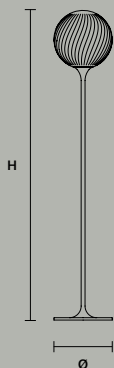

TEE OUT STL1 FIX    IP54

∅ 30 cm / 11.80"
H 160 cm / 63.00"

STANDARD LIGHTING

1xE27x20 W MAX (NOT INCL.)*
USA 1xE26x60 W MAX (NOT INCL.)*

* BULB MAX Ø 62 mm L 185 mm

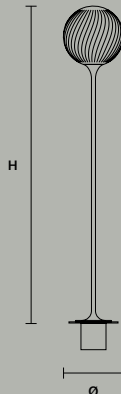

TEE OUT STL1 STAKE    IP44

∅ 30 cm / 11.80"
H 160 cm / 63.00"

STANDARD LIGHTING

1xE27x20 W MAX (NOT INCL.)*
USA 1xE26x60 W MAX (NOT INCL.)*

* BULB MAX Ø 62 mm L 185 mm



TEE OUT STL3 SELF    IP44

L 52 cm / 20.50"
H 170 cm / 66.90"
SP 45 cm / 17.70"

STANDARD LIGHTING

2xE14x10 W MAX (NOT INCL.)*
1xE27x20 W MAX (NOT INCL.)**

USA 2xE12x40 W MAX (NOT INCL.)*
1xE26x60 W MAX (NOT INCL.)**

* BULB MAX Ø 37 MM L 110 MM
** BULB MAX Ø 62 mm L 185 mm

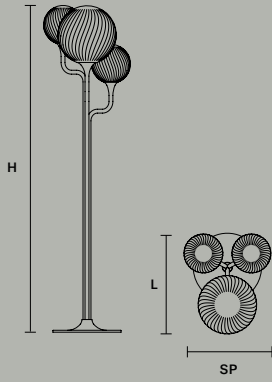

TEE OUT STL3 FIX    IP54

L 52 cm / 20.50"
H 170 cm / 66.90"
SP 45 cm / 17.70"

STANDARD LIGHTING

2xE14x10 W MAX (NOT INCL.)*
1xE27x20 W MAX (NOT INCL.)**

USA 2xE12x40 W MAX (NOT INCL.)*
1xE26x60 W MAX (NOT INCL.)**

* BULB MAX Ø 37 MM L 110 MM
** BULB MAX Ø 62 mm L 185 mm

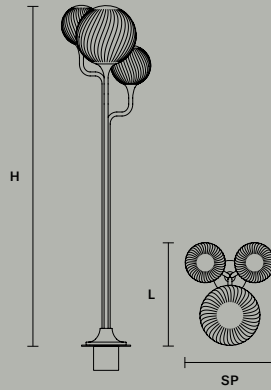

TEE OUT STL3 STAKE    IP44

L 52 cm / 20.50"
H 170 cm / 66.90"
SP 45 cm / 17.70"

STANDARD LIGHTING

2xE14x10 W MAX (NOT INCL.)*
1xE27x20 W MAX (NOT INCL.)**

USA 2xE12x40 W MAX (NOT INCL.)*
1xE26x60 W MAX (NOT INCL.)**

* BULB MAX Ø 37 MM L 110 MM
** BULB MAX Ø 62 mm L 185 mm

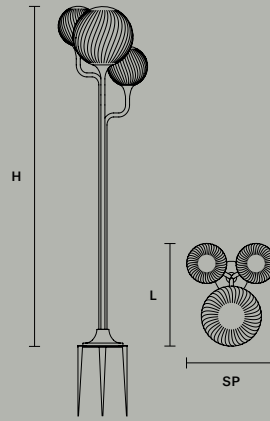

TEE OUT S3    IP54

STANDARD LIGHTING

3xE27x20 W MAX (NOT INCL.)*

USA 3xE26x60 W MAX (NOT INCL.)*

* BULB MAX Ø 62 mm L 185 mm



TEE OUT S5    IP54

STANDARD LIGHTING

5xE14x10 W MAX (NOT INCL.)*

USA 5xE12x40 W MAX (NOT INCL.)*

* BULB MAX Ø 37 MM L 110 MM



Drylight

IT Drylight è la collezione di lampadari veneziani per esterni che porta la magica atmosfera di Venezia nei terrazzi, dehors e giardini. Cristalli e pendenti dalle fogge settecentesche creano scenari luminosi ovattati, affascinanti e misteriosi, ottenuti con i più avanzati sistemi di domotica.

EN Drylight is the Venetian outdoor chandelier collection that brings the magical atmosphere of Venice to terraces, patios and gardens. The 18th-century style crystals and pendants create hushed, captivating, mysterious lighting environment, achieved through the most advanced home automation systems.

DESIGN BY
MASIERO LAB

SUSPENSION
APPLIQUE
TABLE LAMP
FLOOR LAMP





Tecnologia Drylight con protezione IP66: sicurezza totale in ogni condizione climatica

Drylight technology with IP66 protection level: complete safety in any weather conditions



CERTIFICAZIONE IP66

Totale protezione contro l'acqua.

IP66 CERTIFICATION

Total protection against water.



ILLUMINAZIONE A LUCE LED BIANCA OPPURE A LED RGB-W

Possibilità di ricreare infiniti scenari grazie alla tecnologia RGB-W.

WHITE LED LIGHTING OR RGB-W LED LIGHTING

Possibility to recreate countless scenarios thanks to RGB-W technology.



RESISTENTE AI RAGGI UV

Sviluppato con struttura in Policarbonato che non cristallizza o ingiallisce, testato per gli ambienti estremi.

UV RESISTANT

The structure is made of Polycarbonate, a material not subject to crystallization or yellowing, tested for extreme environments.



RESISTENTE ALLE ALTE E BASSE TEMPERATURE

Testato in camera climatica con escursioni termiche ripetute da -30 °C a +50°C.

RESISTANT TO HIGH AND LOW TEMPERATURES

Tested in climate chamber, with a temperature range from -30 °C to +50 °C.



VERSIONE RGB-W COMPATIBILE CON PROTOCOLLO DMX

Gestibile attraverso i più avanzati sistemi domotici.

RGB-W VERSION COMPATIBLE WITH DMX PROTOCOLS

Suitable for the most advanced home automation systems.



SEMPLICITÀ DI INSTALLAZIONE E MANUTENZIONE

EASY INSTALLATION AND LOW MAINTENANCE



RESISTENTE A UMIDITÀ, POLVERE E CORROSIONE

Ideale per utilizzi in bagni, SPA e piscine. Testato in nebbia salina, ideale per aree costiere e utilizzi marittimi.

HUMIDITY, DUST AND CORROSION RESISTANT

Suitable for installation in baths, spas and swimming pools. Tested in saline fog, ideal for coastal areas and marine use.



RESISTENTE ALLE SOLLECITAZIONI E AL VENTO

Testato in galleria del vento fino ad oltre 80 Km/h. (Solo Versione Extreme)

RESISTANT TO STRESS AND WIND

Tested in wind tunnel, with wind speeds higher than 80 Km/h. (Extreme version only)





Drylight è disponibile in versione Extreme, con pendagli e prismi in policarbonato, consigliata per uso esterno e in versione Premium, con pendagli ed ottagoni in cristallo molato raccomandata per uso interno.

Drylight is available in the Extreme version, with polycarbonate pendants and prisms, recommended for outdoor use, and in the Premium version, with cut crystal pendants and octagons, recommended for indoor use.



EXTREME

Pendagli e prismi in policarbonato.
Polycarbonate pendants and prisms.



PREMIUM

Pendagli e ottagoni in cristallo molato.
(Consigliato per uso interno).
Cut crystal pendants and octagons.
(Recommended for internal use only).

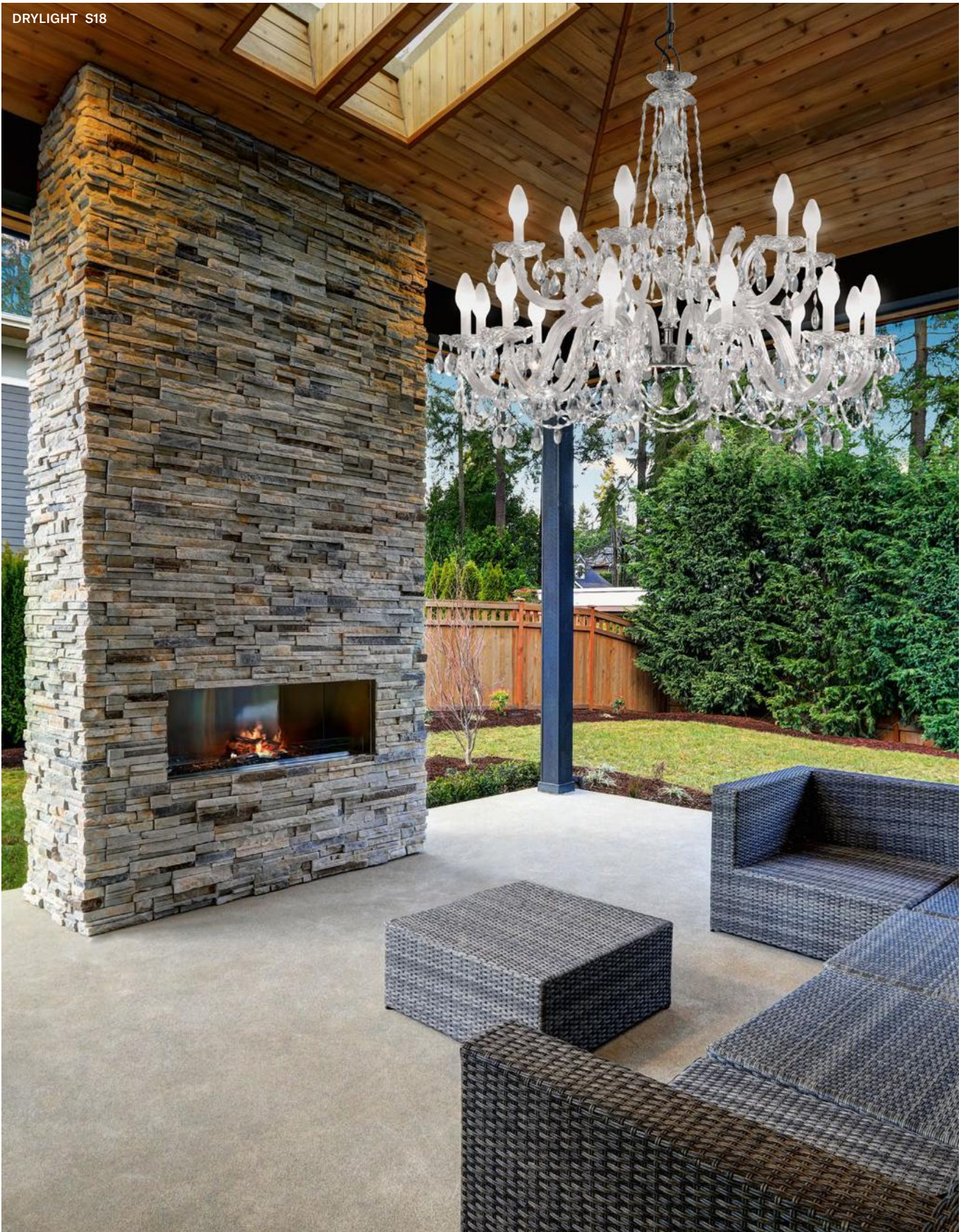



Disponibile in versione RGB-W con la possibilità di generare un'infinita gamma di colori, oppure in versione WHITE, che consente di intervenire solo sull'intensità della luce bianca.

Available in the RGB-W version, with the possibility of generating an infinite range of colours, and WHITE, with the possibility of modifying only the intensity of the white light.



DRYLIGHT LED WHITE



DRYLIGHT LED RGB-W

Drylight incorpora un sistema LED RGB-W ingegnerizzato per rispondere in modo efficiente alle esigenze di affidabilità e robustezza. Utilizza una soluzione brevettata che consente di realizzare infiniti scenari di intensità e colore della luce.

Drylight incorporates a LED RGB-W system engineered to efficiently meet the needs for reliability and strength. It is equipped with a patented system that allows to create endless combinations of light intensity and colour.























DRYLIGHT A2 RGB-W

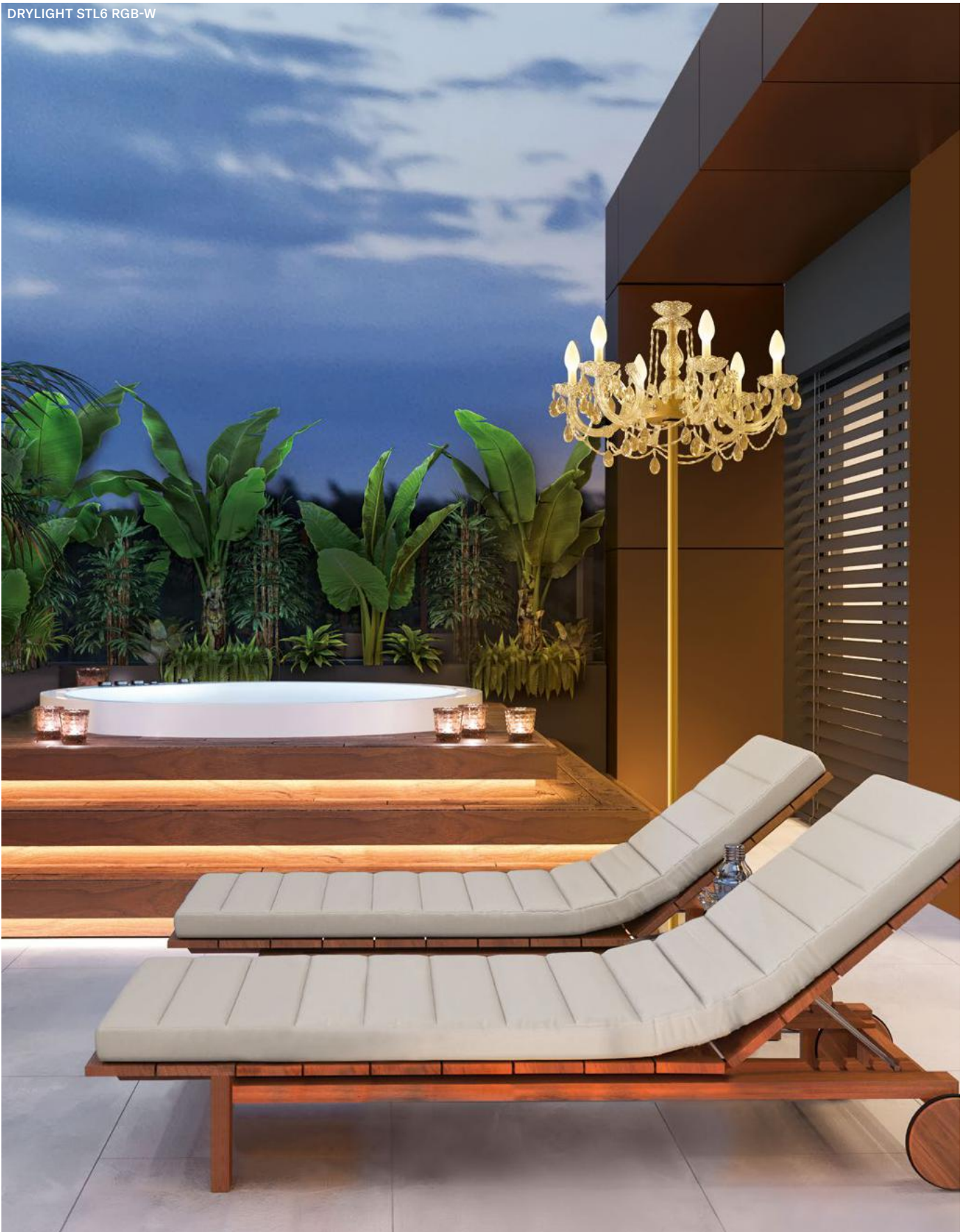





DRYLIGHT A2
DRYLIGHT S12









Drylight

Struttura in policarbonato con pendagli in policarbonato o cristallo molato (raccomandato per uso interno). Illuminazione Led. IP66

Polycarbonate structure with polycarbonate pendants or cut crystal (recommended for indoor use). LED lighting. IP66

Gestell aus Polycarbonat mit Behang aus Polycarbonat oder geschliffenem Kristall (für den Innenbereich empfohlen). LED-Leuchtmittel. IP66

Estructura en policarbonato con colgantes en policarbonato o cristal tallado (recomendado para uso interno). Iluminación LED. IP66

Structure en polycarbonate avec pampilles en polycarbonate ou cristal taillé (recommandé pour une utilisation à l'intérieur). Éclairage LED. IP66

КАРКАС ИЗ ПОЛИКАРБОНАТА С ПОДВЕСКАМИ ИЗ ПОЛИКАРБОНАТА ИЛИ ШЛИФОВАННОГО СТЕКЛА (РЕКОМЕНДУЕТСЯ ДЛЯ ВНУТРЕННЕГО ИСПОЛЬЗОВАНИЯ). СВЕТОДИОДНОЕ ОСВЕЩЕНИЕ. IP66

带有聚碳酸酯或切割水晶吊坠的聚碳酸酯灯体结构(建议室内使用)。Led照明。防护等级IP66

هيكل من البولي كربونات مع دلائيات من البولي كربونات أو الكريستال المصقول (موصى به للاستخدام الداخلي). إضاءة Led. IP66



E71 Silver Chrome

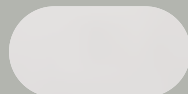

E95 Pure White



E99 Desert Gold

LIGHTING

1. Drylight Led White

2. Drylight Led RGB-W: Drylight incorpora un sistema LED RGB-W ingegnerizzato per rispondere alle esigenze di affidabilità e robustezza. Utilizza una soluzione brevettata che consente di realizzare infiniti scenari di intensità e colore della luce.

1. Drylight Led White

2. Drylight Led RGB-W: Drylight incorporates a LED RGB-W system engineered to meet the needs for reliability and strength. It is equipped with a patented system that allows to create endless combinations of light intensity and colour.

1.



2.



MATERIALS



EXTREME PENDANTS

Pendagli e prismi in policarbonato. Polycarbonate pendants and prisms.



PREMIUM PENDANTS

Pendagli e ottagoni in cristallo molato. (Consigliato per uso interno). Cut crystal pendants and octagons. (Recommended for internal use only).

RGB-W CONTROL

Il sistema RGB-W Control è dotato di una centralina* di controllo che consente di gestire tutte le funzioni in base alle esigenze dell'utilizzatore. Ogni dispositivo Drylight RGB-W può essere integrato nei sistemi domotici di qualsiasi abitazione gestiti con protocollo DMX.

Su richiesta è possibile fornire il dispositivo di uno di questi sistemi di gestione:

- 1. Radiocomando:** ogni singolo dispositivo può essere controllato con un radiocomando. Su richiesta, un unico radiocomando può gestire più dispositivi diversi.
- 2. App su smartphone o tablet:** Masiero ha sviluppato una App disponibile per sistemi IOS e Android che, con un'interfaccia semplice ed intuitiva, permette di gestire un numero infinito di dispositivi, contemporaneamente oppure singolarmente.

* Centralina non inclusa

The control unit* in the RGB-W Control system allows all functions to be managed according to the user's needs. Each Drylight RGB-W device can be integrated into any home automation system managed with the DMX protocol.

On request, the device can be provided with one of the following control systems:

- 1. Radio control:** each individual device can be controlled via a radio remote control. On request, a single remote control can manage several different devices.
- 2. App on your smartphone or tablet:** Masiero has developed an app for IOS and Android systems with a simple, intuitive interface to allow an infinite number of devices to be controlled together or individually.

* Control unit not included



1.



2.



For the US market, refer to the relevant price list.

MASIERO SMART LIGHT APP

Con la App Masiero Smart Light si possono gestire un numero infinito di dispositivi, tramite il sistema Host-slave.

With the Masiero Smart Light App, an infinite number of appliances can be controlled through the host-slave system.

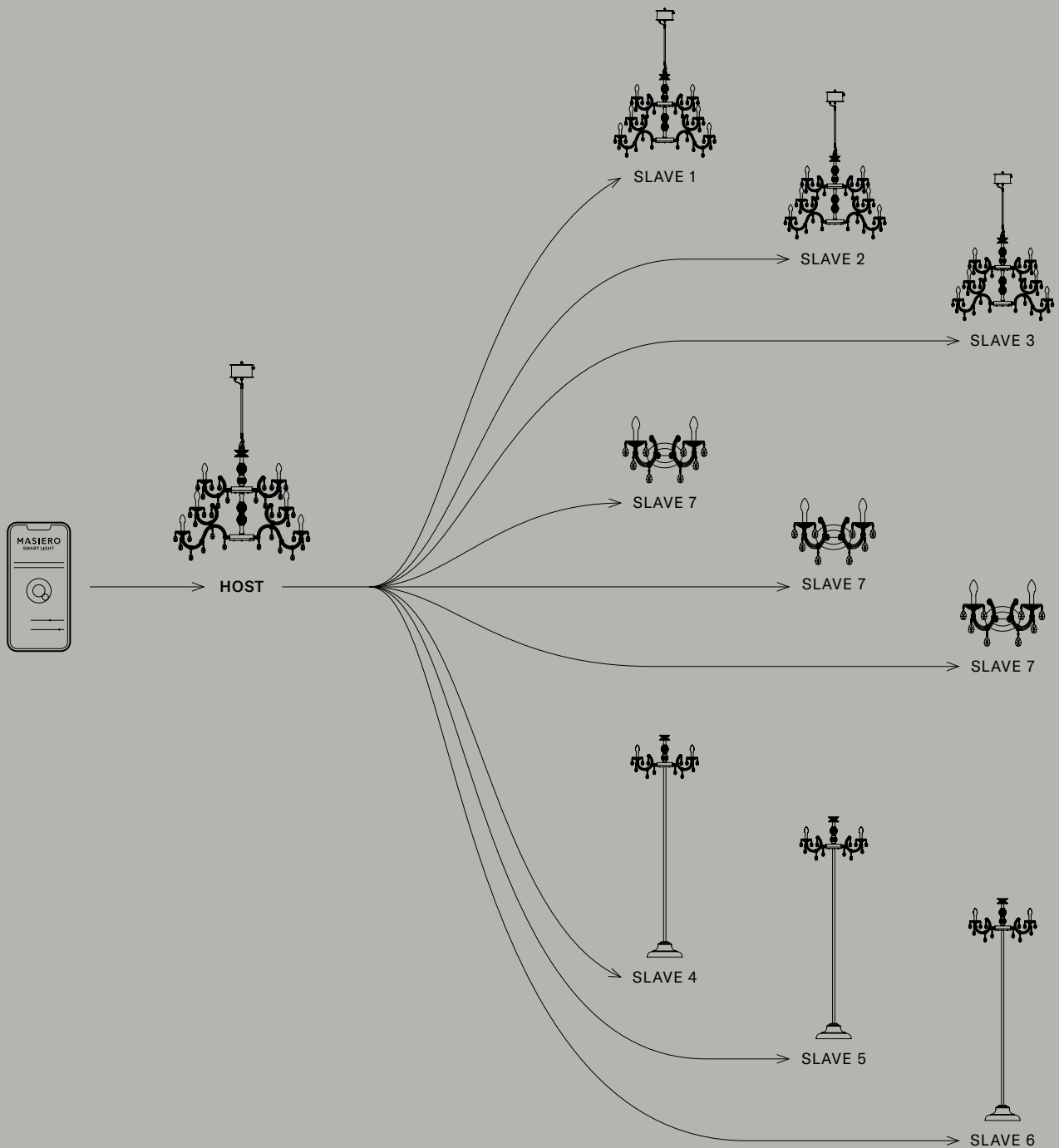

DRYLIGHT S6 WHITE  IP66

Ø 75 cm / 29.50"
 H 125 cm / 49.20"
 W 7,3 kg / 16,09 lb EXTREME
 8,7 kg / 19,18 lb PREMIUM
 H ROD 45 45 cm / 17.70" STANDARD
 H ROD 35 35 cm / 13.80" ON REQUEST
 H ROD 25 25 cm / 9.80" ON REQUEST

INTEGRATED LED LIGHTING

6xWHITE LED SOURCE – 3000 K
 13 W TOT – 1600 NOMINAL LM
 (DRIVER INCLUDED)
 DIMM NO
 USA 6xWHITE LED SOURCE – 3000 K
 13 W TOT – 1600 NOMINAL LM
 (DRIVER INCLUDED)
 DIMM 1-10V + PUSH

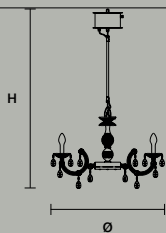

DRYLIGHT S12 WHITE  IP66

Ø 113 cm / 44.50"
 H 135 cm / 53.10"
 W 10,6 kg / 23,36 lb EXTREME
 13,4 kg / 29,54 lb PREMIUM
 H ROD 45 45 cm / 17.70" STANDARD
 H ROD 35 35 cm / 13.80" ON REQUEST
 H ROD 25 25 cm / 9.80" ON REQUEST

INTEGRATED LED LIGHTING

12xWHITE LED SOURCE – 3000 K
 26 W TOT – 3360 NOMINAL LM
 (DRIVER INCLUDED)
 DIMM TRIAC
 USA 12xWHITE LED SOURCE – 3000 K
 26 W TOT – 3360 NOMINAL LM
 (DRIVER INCLUDED)
 DIMM 1-10V + PUSH

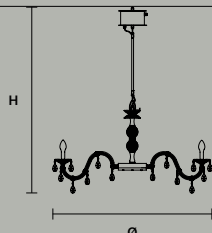

DRYLIGHT S18 WHITE  IP66

Ø 113 cm / 44.50"
 H 150 cm / 59.10"
 W 16,1 kg / 35,49 lb EXTREME
 20,2 kg / 44,53 lb PREMIUM
 H ROD 45 45 cm / 17.70" STANDARD
 H ROD 35 35 cm / 13.80" ON REQUEST
 H ROD 25 25 cm / 9.80" ON REQUEST

BOX

Øb 20 cm / 7.87"
 Hb 10 cm / 3.94"

INTEGRATED LED LIGHTING

18xWHITE LED SOURCE – 3000 K
 39 W TOT – 5040 NOMINAL LM
 (DRIVER INCLUDED)
 DIMM TRIAC
 USA 18xWHITE LED SOURCE – 3000 K
 39 W TOT – 5040 NOMINAL LM
 (DRIVER INCLUDED)
 DIMM 1-10V + PUSH

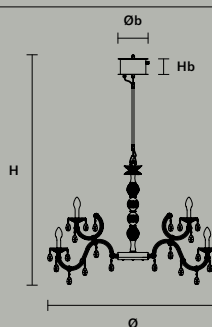

DRYLIGHT S24 WHITE  IP66

Ø 113 cm / 44.50"
 H 165 cm / 65.00"
 W 23,5 kg / 51,80 lb EXTREME
 29,7 kg / 65,47 lb PREMIUM
 H ROD 45 45 cm / 17.70" STANDARD
 H ROD 35 35 cm / 13.80" ON REQUEST
 H ROD 25 25 cm / 9.80" ON REQUEST

BOX

Øb 20 cm / 7.87"
 Hb 10 cm / 3.94"

INTEGRATED LED LIGHTING

24xWHITE LED SOURCE – 3000 K
 52 W TOT – 6720 NOMINAL LM
 (DRIVER INCLUDED)
 DIMM TRIAC
 USA 24xWHITE LED SOURCE – 3000 K
 52 W TOT – 6720 NOMINAL LM
 (DRIVER INCLUDED)
 DIMM 1-10V + PUSH

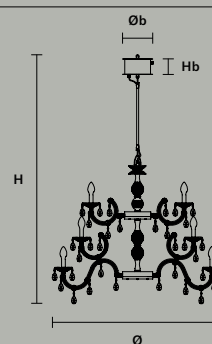

DRYLIGHT S6 RGB-W  IP66

Ø 75 cm / 29.50"
 H 125 cm / 49.20"
 W 7,3 kg / 16,09 lb EXTREME
 8,7 kg / 19,18 lb PREMIUM
 H ROD 45 45 cm / 17.70" STANDARD
 H ROD 35 35 cm / 13.80" ON REQUEST
 H ROD 25 25 cm / 9.80" ON REQUEST

INTEGRATED LED LIGHTING

6xRGB-W LED SOURCE
 24 W TOT (DRIVER INCLUDED)
 DIMMABLE
 USA 6xRGB-W LED SOURCE
 24 W TOT (DRIVER INCLUDED)
 DIMMABLE

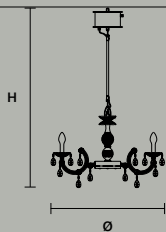



DRYLIGHT S12 RGB-W  IP66

Ø 113 cm / 44.50"
 H 135 cm / 53.10"
 W 10,6 kg / 23,36 lb EXTREME
 13,4 kg / 29,54 lb PREMIUM
 H ROD 45 45 cm / 17.70" STANDARD
 H ROD 35 35 cm / 13.80" ON REQUEST
 H ROD 25 25 cm / 9.80" ON REQUEST

INTEGRATED LED LIGHTING

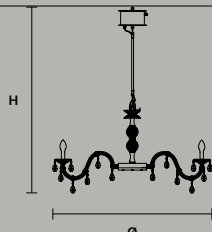
12xRGB-W LED SOURCE
 48 W TOT (DRIVER INCLUDED)
 DIMMABLE
 USA 12xRGB-W LED SOURCE
 48 W TOT (DRIVER INCLUDED)
 DIMMABLE



DRYLIGHT S18 RGB-W  IP66

Ø 113 cm / 44.50"
 H 150 cm / 59.10"
 W 16,1 kg / 35,49 lb EXTREME
 20,2 kg / 44,53 lb PREMIUM
 H ROD 45 45 cm / 17.70" STANDARD
 H ROD 35 35 cm / 13.80" ON REQUEST
 H ROD 25 25 cm / 9.80" ON REQUEST

BOX

Øb 20 cm / 7.87"
 Hb 14 cm / 5.51"

INTEGRATED LED LIGHTING

18xRGB-W LED SOURCE
 72 W TOT (DRIVER INCLUDED)
 DIMMABLE
 USA 18xRGB-W LED SOURCE
 72 W TOT (DRIVER INCLUDED)
 DIMMABLE

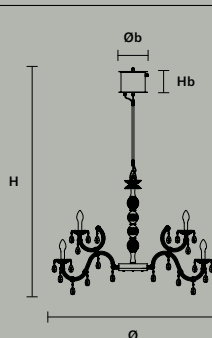

DRYLIGHT S24 RGB-W  IP66

Ø 113 cm / 44.50"
 H 165 cm / 65.00"
 W 23,5 kg / 51,80 lb EXTREME
 29,7 kg / 65,47 lb PREMIUM
 H ROD 45 45 cm / 17.70" STANDARD
 H ROD 35 35 cm / 13.80" ON REQUEST
 H ROD 25 25 cm / 9.80" ON REQUEST

BOX

Øb 20 cm / 7.87"
 Hb 14 cm / 5.51"

INTEGRATED LED LIGHTING

24xRGB-W LED SOURCE
 96 W TOT (DRIVER INCLUDED)
 DIMMABLE
 USA 24xRGB-W LED SOURCE
 96 W TOT (DRIVER INCLUDED)
 DIMMABLE

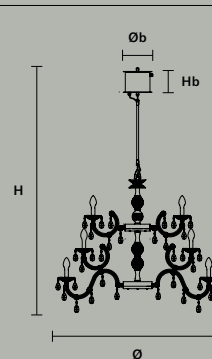

DRYLIGHT A2 WHITE **CE IP66**

L 44 cm / 17.30"
 SP 30 cm / 11.80"
 H 37 cm / 14.60"

INTEGRATED LED LIGHTING

2xWHITE LED SOURCE – 3000 K
 5 W TOT – 560 NOMINAL LM
 (DRIVER INCLUDED)

DIMM NO

USA 2xWHITE LED SOURCE – 3000 K
 5 W TOT – 560 NOMINAL LM
 (DRIVER INCLUDED)

DIMM NO

DRYLIGHT TL6 WHITE **IP66** CE IP44***

ø 75 cm / 29.50"
 H 120 cm / 47.20"

INTEGRATED LED LIGHTING

6xWHITE LED SOURCE – 3000 K
 13 W TOT – 1600 NOMINAL LM
 (DRIVER INCLUDED)

DIMM NO

USA 6xWHITE LED SOURCE – 3000 K
 13 W TOT – 1600 NOMINAL LM
 (DRIVER INCLUDED)

DIMM 1-10 + PUSH

BATTERY POWER (OPTIONAL)*

10 hours AUTONOMY
 5 hours TO RECHARGE

DRYLIGHT TL6 STAKE WHITE **IP66** CE IP44***

ø 75 cm / 29.50"
 H 120 cm / 47.20"

INTEGRATED LED LIGHTING

6xWHITE LED SOURCE – 3000 K
 13 W TOT – 1600 NOMINAL LM
 (DRIVER INCLUDED)

DIMM NO

USA 6xWHITE LED SOURCE – 3000 K
 13 W TOT – 1600 NOMINAL LM
 (DRIVER INCLUDED)

DIMM 1-10 + PUSH

BATTERY POWER (OPTIONAL)*

10 hours AUTONOMY
 5 hours TO RECHARGE

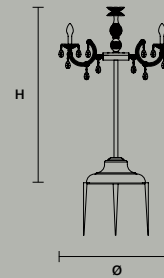
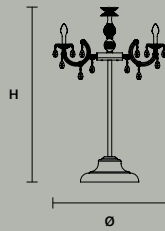
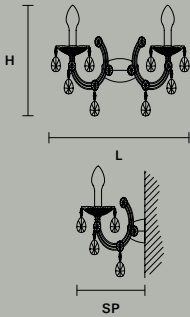

DRYLIGHT A2 RGB-W **CE IP66**

L 44 cm / 17.30"
 SP 30 cm / 11.80"
 H 37 cm / 14.60"

FLUSH-MOUNTED BOX (NOT INCLUDED)

Lb 10 cm / 3.93"
 SPb 7 cm / 2.75"
 H 10 cm / 3.93"

INTEGRATED LED LIGHTING

2xRGB-W LED SOURCE
 8 W TOT (DRIVER INCLUDED)
 DIMMABLE

USA 2xRGB-W LED SOURCE
 8 W TOT (DRIVER INCLUDED)
 DIMMABLE

DRYLIGHT TL6 RGB-W **IP66** CE IP44***

ø 75 cm / 29.50"
 H 120 cm / 47.20"

INTEGRATED LED LIGHTING

6xRGB-W LED SOURCE
 24 W TOT (DRIVER INCLUDED)
 DIMMABLE

USA 6xRGB-W LED SOURCE
 24 W TOT (DRIVER INCLUDED)
 DIMMABLE

BATTERY POWER (OPTIONAL)*

10 hours AUTONOMY
 5 hours TO RECHARGE

DRYLIGHT TL6 STAKE RGB-W **IP66** CE IP44***

ø 75 cm / 29.50"
 H 120 cm / 47.20"

INTEGRATED LED LIGHTING

6xRGB-W LED SOURCE
 24 W TOT (DRIVER INCLUDED)
 DIMMABLE

USA 6xRGB-W LED SOURCE
 24 W TOT (DRIVER INCLUDED)
 DIMMABLE

BATTERY POWER (OPTIONAL)*

10 hours AUTONOMY
 5 hours TO RECHARGE

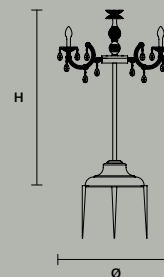
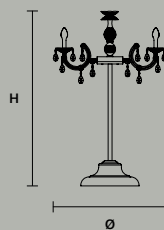
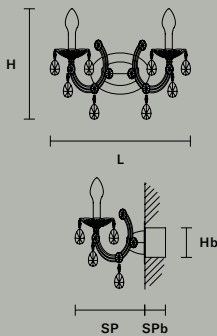

*IP66 FOR BATTERY VERSION

** NOT AVAILABLE FOR BATTERY VERSION

DRYLIGHT STL6 WHITE  ** CE IP44*

Ø 75 cm / 29.50"
H 245 cm / 96.50"

INTEGRATED LED LIGHTING

6xWHITE LED SOURCE – 3000 K
13 W TOT – 1600 NOMINAL LM
(DRIVER INCLUDED)

DIMM NO

USA 6xWHITE LED SOURCE – 3000 K
13 W TOT – 1600 NOMINAL LM
(DRIVER INCLUDED)

DIMM 1-10V + PUSH

BATTERY POWER (OPTIONAL) *

10 hours AUTONOMY
5 hours TO RECHARGE

DRYLIGHT STL6 STAKE WHITE  ** CE IP44*

Ø 75 cm / 29.50"
H 245 cm / 96.50"

INTEGRATED LED LIGHTING

6xWHITE LED SOURCE – 3000 K
13 W TOT – 1600 NOMINAL LM
(DRIVER INCLUDED)

DIMM NO

USA 6xWHITE LED SOURCE – 3000 K
13 W TOT – 1600 NOMINAL LM
(DRIVER INCLUDED)

DIMM 1-10V + PUSH

BATTERY POWER (OPTIONAL) *

10 hours AUTONOMY
5 hours TO RECHARGE

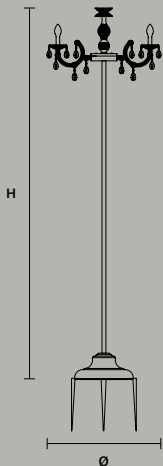

DRYLIGHT STL6 RGB-W  ** CE IP44*

Ø 75 cm / 29.50"
H 245 cm / 96.50"

INTEGRATED LED LIGHTING

6xRGB-W LED SOURCE
24 W TOT (DRIVER INCLUDED)

DIMMABLE

USA 6xRGB-W LED SOURCE
24 W TOT (DRIVER INCLUDED)

DIMMABLE

BATTERY POWER (OPTIONAL) *

10 hours AUTONOMY
5 hours TO RECHARGE

DRYLIGHT STL6 STAKE RGB-W  ** CE IP44*

Ø 75 cm / 29.50"
H 245 cm / 96.50"

INTEGRATED LED LIGHTING

6xRGB-W LED SOURCE
24 W TOT (DRIVER INCLUDED)

DIMMABLE

USA 6xRGB-W LED SOURCE
24 W TOT (DRIVER INCLUDED)

DIMMABLE

BATTERY POWER (OPTIONAL) *

10 hours AUTONOMY
5 hours TO RECHARGE

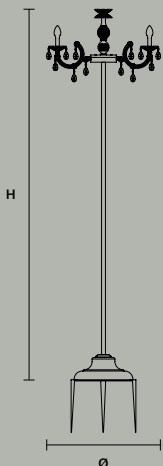

 ** NOT AVAILABLE FOR BATTERY VERSION

DRYLIGHT HANGING ROD

H ROD 45	45 cm / 17.70"
H ROD 35	35 cm / 13.80"
H ROD 25	25 cm / 9.80"

HANGING ROD

1 x 17.70" rod already assembled in the standard suspension. Maximum extension: 90 cm - 35.40" in addition to the standard.

DRYLIGHT SUPPORT

L	230-272 cm / 90.60"-107.10"
H	335-260 cm / 131.90"-102.40"

MATERIALS

Zin-coated and painted metal structure with adjustable height. Base geared for fixing to the ground, 51.20" x 51.20" with cross brackets for square concrete slabs.

We suggest to fix 4 square slabs 23.60" x 23.60", 33 Kg each. (Not included)

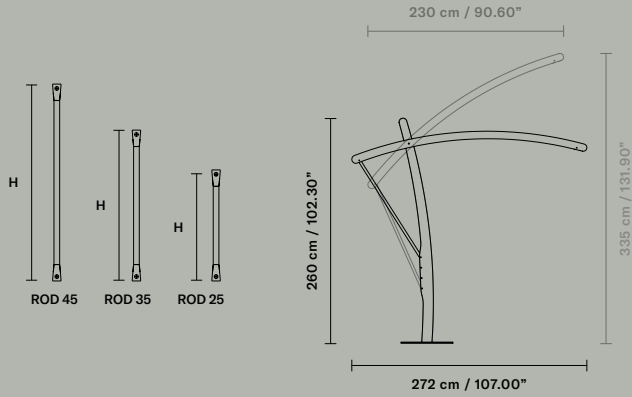

Technical info



Finishings

VERNICIATURA RAGGRINZATA OPACA
FINE TEXTURE PAINT



E50 Windy Blue



E60 Highland



E70 Champagne



E71 Silver Chrome



E80 Canyon

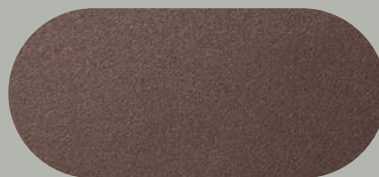

E81 Hazelnut

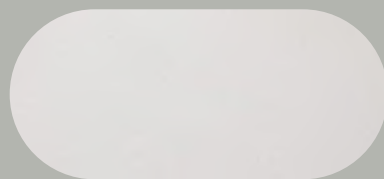

E95 Pure White

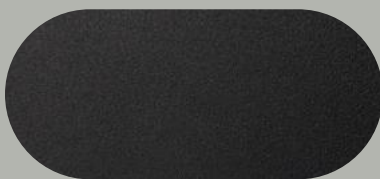

E98 Deep Black



E99 Desert Gold

General informations



Attesta la conformità del prodotto alle disposizioni delle Direttive comunitarie.

It certifies the conformity of the products to the European Community provisions.

Konformität des Produktes mit den Richtlinien der europäischen Gemeinschaft.

Certifica la conformidad del producto según las disposiciones de las directivas comunitarias.

Il atteste la conformità du produit aux dispositions des directives communitaires.

НАСТОЯЩИМ ПОДТВЕРЖДАЕТСЯ СООТВЕТСТВИЕ ПРОДУКЦИИ ПОЛОЖЕНИЯМ ДИРЕКТИВ ЕС.

CE 标记是指产品的制造商证明该产品符合适用的EC指令的所有基本要求。

يُشهد بمطابقة المنتج لأحكام توجيهات الاتحاد الأوروبي.



Il logo "ETL" si riferisce agli articoli che possono essere modificati con componenti certificati ETL. L'elenco degli articoli ETL si riferisce a prodotti testati e valutati in base agli standard di sicurezza del mercato statunitense. Per il mercato USA fare riferimento al listino dedicato.

"ETL" logos refers to articles which can be modified with ETL-compliance components. The "ETL" listing articles stands for tested and evaluated product to recognised US safety standards. For the US market, refer to the relevant price list.

Das "ETL"-Logo bezieht sich auf Artikel, die mit ETL-zertifizierten Komponenten modifiziert werden können. Die Liste der ETL-Artikel bezieht sich auf Produkte, die nach den Sicherheitsstandards des US-Marktes getestet und bewertet wurden. Für den US-Markt beachten Sie bitte die entsprechende Preisliste.

El logo "ETL" indica los artículos, que pueden modificarse con componentes certificados ETL. La lista de los artículos ETL se refiere a los productos sometidos a prueba y evaluados en función de los estándares de seguridad del mercado estadounidense. Consultar la lista de precios específica para el mercado de los Estados Unidos.

"ETL" logo se réfère aux articles qui peuvent être modifiés par des composants certifiés ETL. la liste des articles ETL se réfère à des produits testés et évalués selon les normes de sécurité du marché américain. Pour le marché américain se référer à la liste des prix.

логотип «ETL» относится к элементам, которые могут быть модифицированы с помощью сертифицированных ETL компонентов. список элементов ETL относится к продукции, протестированной и оцененной в соответствии с признанными стандартами безопасности США. для потребителей находящихся в США см. соответствующий прайс-лист.

"ETL" 徽标是指可以使用 ETL 认证的组件进行修改的项目。 ETL 项目列表是指根据美国市场的安全标准进行测试和评估的产品。 对于美国市场, 请参考美国市场价格表。

يشير شعار "ETL" إلى المنتجات التي يمكن تعديلها باستخدام مكونات معتمدة من ETL. تشير قائمة منتجات ETL إلى المنتجات التي تم اختبارها وتقييمها وفقاً لمعايير السلامة في السوق الأمريكي. بالنسبة لسوق الولايات المتحدة الأمريكية، يُرجى الرجوع إلى قائمة الأسعار المخصصة.



Flusso luminoso nominale. L'indicazione si riferisce al valore in assenza di rifrazione, come dichiarato dal produttore del componente.

Nominal luminous flux. It refers to the value without any refraction, as declared by the component manufacturer.

Die Masseinheit für den Lichtstrom. Die Angabe bezieht sich auf den Wert in der Abwesenheit von Brechung, wie vom Hersteller der Komponente angegeben.

Flujo luminoso nominal. La indicación se refiere al valor sin refracción, como declarado por el fabricante del componente.

L'unité SI de flux lumineux. L'indication correspond à la valeur en l'absence de réfraction, comme indiqué par le fabricant du composant.

НОМИНАЛЬНЫЙ СВЕТОВОЙ ПОТОК. УКАЗАНИЕ ОТНОСИТСЯ К ЗНАЧЕНИЮ В ОТСУТСТВИИ РЕФРАКЦИИ, КАК ЗАЯВЛЕНО ПРОИЗВОДИТЕЛЕМ КОМПОНЕНТОВ.

标称光通量。指示是指组件制造商声明的没有折射的值。

التدفق الضوئي الاسمي. يشير المؤشر إلى القيمة في حالة عدم وجود انكسار للضوء، كما هو مُعلن من قبل الشركة المصنعة للعنصر.



Lo schema IECEE CB è un sistema internazionale per l'accettazione reciproca di rapporti di prova e certificati relativi alla sicurezza di componenti, apparecchiature e prodotti elettrici ed elettronici operative e dei prodotti sulla base di un accordo multilaterale tra i paesi partecipanti e gli organismi di certificazione.

IECEE CB is an international system for the mutual acceptance of test reports and certificates of the safety of components, operational electrical and electronic equipment and products on the basis of a multilateral agreement between participating countries and certification bodies.

Das IECEE CB Schema ist ein internationales System zur gegenseitigen Anerkennung von Testberichten und Zertifikaten bezüglich der Sicherheit von Komponenten, betriebsbereite elektrische und elektronische Geräte und Produkte auf der Grundlage eines multilateralen Abkommens zwischen teilnehmenden Ländern und Zertifizierungsstellen.

IECEE CB es un sistema internacional para la aceptación mutua de informes de ensayo y certificados de seguridad de componentes, equipos y productos eléctricos y electrónicos operativos y de productos, sobre la base de un acuerdo multilateral entre los países participantes y los organismos de certificación.

Le système IECEE CB est un système international d'acceptation mutuelle des rapports d'essai et des certificats de sécurité des composants, équipements et produits électriques et électroniques opérationnels et des produits, sur la base d'un accord multilatéral entre les pays participants et les organismes de certification.

SCHEMA IECEE CB ПРЕДСТАВЛЯЕТ СОБОЙ МЕЖДУНАРОДНУЮ СИСТЕМУ ВЗАИМНОГО ПРИЗНАНИЯ СЕРТИФИКАТОВ И ОТЧЕТОВ ОБ ИСПЫТАНИЯХ, КАСАЮЩИХСЯ БЕЗОПАСНОСТИ ЭЛЕКТРИЧЕСКИХ И ЭЛЕКТРОННЫХ КОМПОНЕНТОВ И ОБОРУДОВАНИЯ, ОСНОВАННУЮ НА МНОГОСТОРОННЕМ СОГЛАШЕНИИ МЕЖДУ СТРАНАМИ-УЧАСТНИЦАМИ И ОРГАНАМИ ПО СЕРТИФИКАЦИИ.

认证是电工产品测试证书互认体系 (CB 体系) 是国际电工委员会电工产品合格测试与认证组织。

مخطط IECEE CB هو نظام دولي للقبول المتبادل لتقارير الاختبار والاعتمادات المتعلقة بسلامة المكونات، والمعدات، والمنتجات الكهربائية والإلكترونية التشغيلية والمنتجات بناءً على اتفاقية متعددة الأطراف بين الدول المشاركة وهيئات الاعتماد.

IP

Il grado di protezione IP è un parametro definito dallo standard internazionale IEC 60529 utilizzato per valutare il grado di protezione o l'efficacia di tenuta degli involucri elettrici contro l'intrusione di oggetti, acqua, polvere o contatti accidentali. Il grado IP è definito assieme a due valori numerici, il primo riguarda il grado di protezione alla polvere, mentre la seconda si riferisce al grado di impermeabilità all'acqua.

The Ingress Protection (IP) rating is a parameter defined by the international standard IEC 60529 that is used to rate the degree of protection or sealing effectiveness of electrical enclosures against the intrusion of objects, water, dust or accidental contact. The IP rating is defined using two digits, the first digit relates to the degree of protection against dust, while the second digit relates to the degree of impermeability to water.

L'indice IP est un paramètre défini par la norme internationale IEC 60529 utilisé pour évaluer le niveau de protection ou l'efficacité de l'étanchéité des boîtiers électriques contre l'intrusion d'objets, d'eau, de poussière ou les contacts accidentels. L'indice IP est défini par deux valeurs numériques, la première se rapportant au niveau de protection contre la poussière et la seconde au niveau d'imperméabilité à l'eau.

Die IP-Schutzart ist ein von der internationalen IEC-Norm 60529 festgelegter Parameter, der verwendet wird, um den Schutz oder die Wirksamkeit der Dichtheit von elektrischen Gehäusen gegen das Eindringen von Gegenständen, Wasser, Staub oder gegen unbeabsichtigtes Berühren anzugeben. Die IP-Schutzart wird mit zwei Kennziffern definiert, wobei sich die erste Kennziffer auf den Schutz gegen Staub und die zweite Kennziffer auf den Schutz gegen das Eindringen von Wasser bezieht.

El grado de protección IP es un parámetro definido por la norma internacional CEI 60529 que se utiliza para evaluar el grado de protección o la eficacia del aislamiento de las envolturas eléctricas contra la penetración de cuerpos sólidos, agua, polvo o contactos accidentales. El grado de protección IP se define con dos cifras numéricas, la primera se refiere al grado de protección contra el polvo, mientras que la segunda se refiere al grado de protección contra la penetración de agua.

СТЕПЕНЬ ЗАЩИТЫ IP - ЭТО ПАРАМЕТР, ОПРЕДЕЛЯЕМЫЙ МЕЖДУНАРОДНЫМ СТАНДАРТОМ IEC 60529 И ИСПОЛЬЗУЕМЫЙ ДЛЯ ОЦЕНКИ СТЕПЕНИ ИЛИ ЭФФЕКТИВНОСТИ ЗАЩИТЫ ЭЛЕКТРИЧЕСКИХ ШКАФОВ ОТ ПРОНИКНОВЕНИЯ ПРЕДМЕТОВ, ВОДЫ, ПЫЛИ ИЛИ ОТ СЛУЧАЙНОГО КОНТАКТА.

СТЕПЕНЬ ЗАЩИТЫ IP ОПРЕДЕЛЯЕТСЯ ДВУМЯ ЧИСЛОВЫМИ ЗНАЧЕНИЯМИ, ПЕРВОЕ ОТНОСИТСЯ К СТЕПЕНИ ЗАЩИТЫ ОТ ПЫЛИ, А ВТОРОЕ - К СТЕПЕНИ ВОДОНЕПРОНИЦАЕМОСТИ.

IP防护等级是一个由国际标准IEC 60529定义的参数,用于评估电气外壳针对异物侵入、液体渗入、灰尘进入或意外接触的防护等级或密封效果。

IP等级由两个数值共同定义,第一个表示防尘等级,第二个表示防水等级。

IP
درجة الحماية IP هي معلمة محددة بواسطة المعيار الدولي IEC 60529 مستخدمة لتقييم درجة الحماية أو فعالية إكمام الحاويات الكهربائية ضد اقتحام الأشياء، أو الماء، أو الأتربة، أو التلامس العرضي. يتم تحديد درجة الحماية IP بقيمتين رقميتين، الأولى تتعلق بدرجة الحماية من الأتربة، بينما تشير الثانية إلى درجة عدم نفاذية الماء.

MASIERO

Masiero si riserva il diritto di apportare ai propri articoli, senza nessun preavviso, qualsiasi modifica ritenesse opportuna.

Masiero reserves the right to introduce any changes to its own products, without notice in advance.

Masiero behält sich das Recht vor Änderungen vorzunehmen, ohne sofortige Benachrichtigung.

Masiero se reserva el derecho de aportar modificaciones consideradas oportunas a sus artículos sin preaviso.

Masiero se réserve le droit d'apporter une quelconque modification à les modèles sans préavis.

КОМПАНИЯ MASIERO ОСТАВЛЯЕТ ЗА СОБОЙ ПРАВО БЕЗ ПРЕДВАРИТЕЛЬНОГО УВЕДОМЛЕНИЯ, ЕСЛИ ЭТО БУДЕТ СОЧТЕНО ЦЕЛЕСООБРАЗНЫМ, ВНОСИТЬ В СОБСТВЕННЫЕ МОДЕЛИ ЛЮБЫЕ ИЗМЕНЕНИЯ.

Masiero保留对其认为适当的任何更改的权利,恕不另行通知。

تحتفظ شركة مازيرو "Masiero" بالحق في إجراء أي تعديلات تراها مناسبة على منتجاتها، دون إشعار مسبق.

ART DIRECTION, DESIGN
Designwork

LAYOUT
Masiero

PRINT
Italy, March 2023
by Grafica Antiga

Masiero srl

via Peschiere, 53
31032 Casale sul Sile
Treviso, Italy
T +39 0422 7861
F +39 0422 786250

info@masierogroup.com
masierogroup.com

Masiero USA LTD

100 Park Avenue
Suite 1600
New York, NY 10017
T +1 212 4666754

sales@masiero-usa.com
masiero-usa.com



