

NAHANCO

2026

a collection of products to inspire, manage, and elevate your brand

Fixtures

Forms

Swim

Tailored Luxury

Backroom Supplies

Bridal

& more



nahanco.com
established 1925

CUSTOMIZATION | RETAIL SUPPLIES | HANGING SOLUTIONS

Introduction 3 – 11

About NAHANCO • 2026 featured lines • custom work

Hangers 12 – 55



Shirt, Jacket, Suit & Pant/Skirt Styles • Adult, Junior & Children Sizes • Hangers for clothing, lingerie, swimwear, quilts, blankets & more • Multiple Materials, Finishes & Colors • Available in a range of Shapes, Sizes & Weights • Many styles with notches and non-slip accessories

WOOD categories

NAHANCO Line	12 - 16
SLIMLINE Wood	17 - 19
Equinox	20
Executive & Executive Flare	21
Northshire Signature Retro	22
Contemporary	23
Specialty Wood	24
Hotel	25
Suiting & Tailoring	26
Traditional Wood	27 - 29
Rubberized Wood	30
Bridal – mixed products	31 - 34

PLASTIC, METAL, SATIN, FLOCKED & more

Jackets & Outerwear	35 - 36
Flocked	37
Display	38
Swim	39
Lingerie - mixed materials	40 - 41
Metals – chrome, steel, aluminum & more	42 - 44
Silver & Gold Plastics	45
Traditional Black, Clear & White Plastics	46 - 53
VICS Plastics	54
Budget Plastics & Wire	55

Retail Supplies 56 – 145

From fixtures, signs and displays, to general supplies for preparing, organizing and managing a retail store



DIVIDERS size dividers • divider kits • size markers



56 - 60



HANGING SOLUTIONS accessory hangers • hooks • clips • attachments

61 - 68



BACKROOM reachers • hanger storage • work tables • folding tables & boards

69 - 72







PRICING SUPPLIES tagging & marking tools • fasteners • labels & tags

73 - 78

PRODUCT LINES & Page Guides



	GARMENT BAGS <i>poly bags • suit bags • travel bags • gown covers</i>	79 - 80
	RACKS & MERCHANDISERS <i>racks • merchandisers • shelves • bins</i>	81 - 100
	WALL SYSTEMS <i>slatwall • grid wall • wall mount • accessories</i>	101 - 112
	SIGNAGE  <i>metal & card stock signs, sign holders & hangers</i>	113 - 120
	SECURITY <i>traffic control • security devices</i>	121 - 124
	DRESSING ROOM <i>fabric care • room checks • tailor supplies • steamers</i> 	125 - 128
	BODY FORMS <i>jersey forms • mannequin forms • display forms</i>	129 - 135
	DISPLAY FIXTURES <i>jewelry & accessory displayers • mirrors</i>	136 - 138
	SHOE DISPLAYS <i>shoe forms • shoe hangers • racks • sizers</i>	139 - 141
	PACKAGING <i>bags • boxes • tissue paper</i>	142 - 145

a Guide to THE SYMBOLS used throughout the Catalog



Our new items



Sustainable product



Everyday Value Items

Low prices on items you use every day



Items that ship via truck



Items that can be customized



Hangers with concave bodies



Products made in the USA



Assembly video available on our website and YouTube channel



Our economy items



California Proposition 65 Warning

Products containing chemicals known to cause cancer, birth defects or other reproductive harm. For more information: www.P65Warnings.ca.gov.

a Note on PRODUCT WEIGHTS

Many of our items now list both the **actual** and the **dimensional** (shipping) weight as follows: *actual/dimensional* or *1/3, 3/7, etc.* When **multiple cartons** are shipped, commas separate the weights as follows: *2, 5 (2 ctns) or 3, 5/8 (2 ctns), etc.*

OUR ORIGINS

In 1925, our founder set out to provide the best retail experience he could, starting with the humble hanger. He invested his meager earnings into machinery, and his journey took off - in New York City, the fashion capitol of the US. Thus, National Hanger Company (NAHANCO) was born.

Over 100 years later, our mission remains the same. We are the industry's most trusted and reliable supplier of quality retail products, and we strive for excellent customer-first service and satisfaction.

As a US-based company, we provide equal pay jobs to local workers, and we support communities right here in America.

MADE IN AMERICA & SOURCED GLOBALLY



CUSTOMER SUPPORT

Great products are only the beginning. At NAHANCO, we pair quality with customer-first service on every order. Our world-class team of account managers and service specialists delivers retail-supply solutions and custom hanger programs to clients worldwide.



SUSTAINABILITY

One of the most important and sensitive topics today, NAHANCO endeavors to be ever more sustainable by making smart material choices. With hundreds of hanger options that fully comply with Green Key Certification, NAHANCO is the perfect partner for all of your sustainability goals.



A LEGACY OF CRAFTSMANSHIP AND DEDICATION

Our 2026 collection of products is meant to inspire, inform and emphasize the best our brand has to offer. A blend of classic designs, semi-custom and newly developed products can be utilized in whatever way excites you. The collections are inventoried and brandable for an effortless execution of your vision.



CUSTOM DESIGN SERVICES

NAHANCO is more than a retail resource. Through statement pieces, creative reuse, and thoughtful design, we can help transform and elevate spaces.

- In-house design teams
- Experienced manufacturing associates
- US-based, semi-custom capabilities
- Special event and VIP branding
- Guest purchase programs
- Specialized reporting & warehousing



Rubberized Wood

Weighty, wood bodies are enveloped in a smooth, no-slip, no-snag, rubber coating. The finish is buttery to the touch, adding a luxurious, tactile element to the shopping experience.



three rubber finishes - black, white & gray



Textured Collection



Top



Jacket



Pant



Lingerie



Natural & White Wood

Wood hangers in natural and white create a clean aesthetic. The subtle quality reads as minimal and effortless.

They are a neutral canvas, that can remain as they are, or branded.

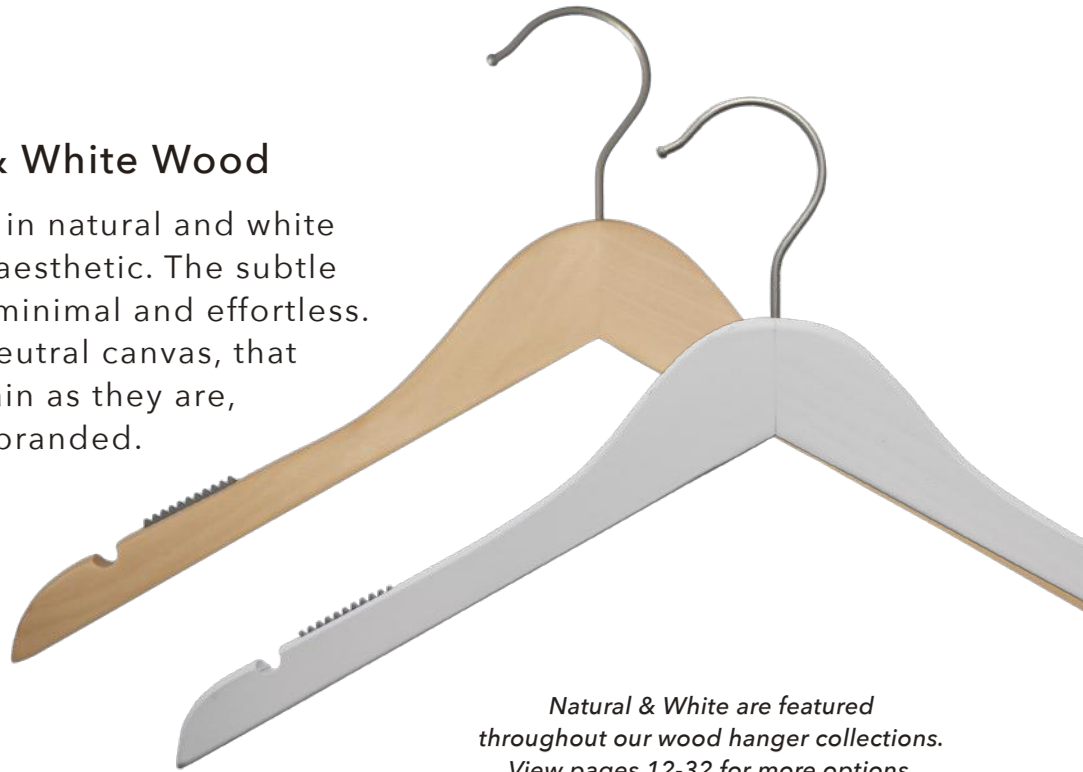

Natural & White are featured throughout our wood hanger collections. View pages 12-32 for more options.

Natural



Natural Collection at a glance

White



Whitewash & Greywash Wood

Two different stain washes applied to grainy woods. The light whitewash finish is an excellent counterbalance to the dark of the greywash, offering unique options for a tonal switch from season to season.



Finish Collection at a glance



Whitewash



Greywash



Metal Hanging & Quiet Luxury

Elevate your accessory hanging solutions to incorporate refined metal accessory hooks, clips, and rings in a variety of finishes to enhance your visual program.



View pages 61-62 for more



*Modern Accessories Collection
at a glance*

DESIGN SERVICES

NAHANCO is more than a hanger and store supply resource. We've been bringing brands and design visions to life for over 100 years. Through statement pieces, creative reuse, and thoughtful design, we transform interior concepts into custom hanger programs that elevate spaces while staying on budget.

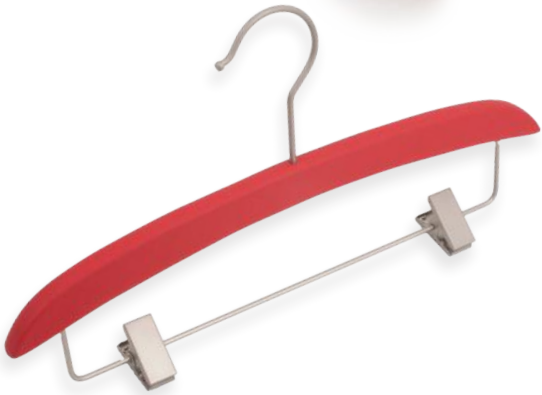
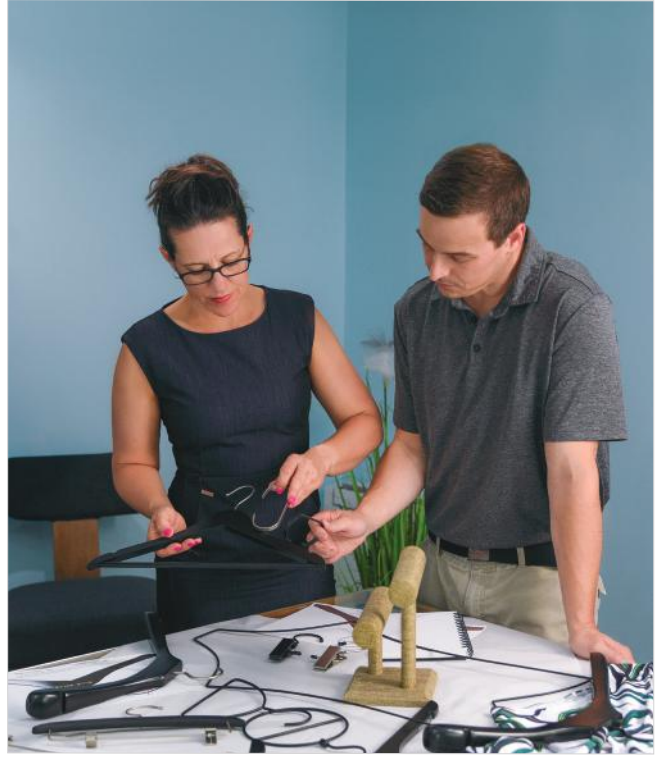



BUILDABRAND

Turn your visions into reality, with full involvement of both your creative teams and ours.



INSTABRAND

Select one of our stock hangers (or dividers) and add your logo



HANGERS

NAHANCO Line Wood



new

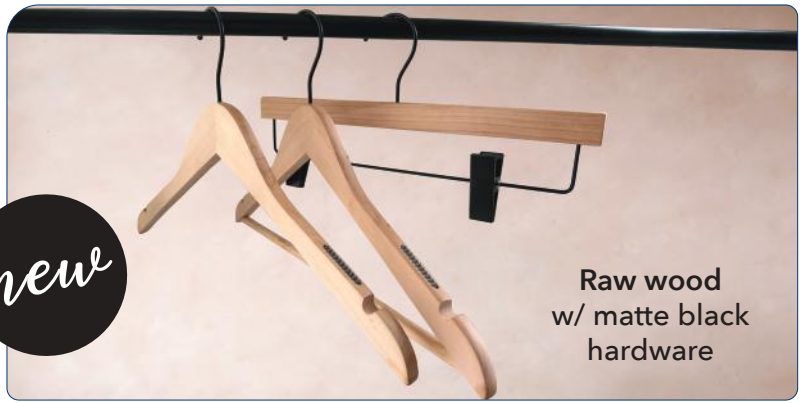

Raw wood
w/ matte black
hardware

FLAT SHIRT /DRESS HANGERS

Our most popular wood hanger style - and the style most often chosen for customization. Hardware is brushed chrome, bright chrome, gunmetal, black or gold. Range of wood finishes. Inset grippers.

17" wide - 1/2" thick body; 100 pcs /case. **SHIRT:** 28 lbs. / Dimensional wgt. 34 lbs
19" width - 1/2" thick body; 100 pcs /case. **SHIRT:** 31/42 lbs;



new

SHIRT HANGERS

Low gloss natural w/brushed chrome	20019	\$99.90	19"
	20017	\$139.99	17"
Low gloss white w/brushed chrome	20119	\$169.99	19"
	20117	\$139.99	17"
Low gloss black w/brushed chrome	20219	\$166.41	19"
	20217	\$139.99	17"
Low gloss mahogany w/brushed chrome	20319	\$169.99	19"
	20317	\$139.99	17"
Low gloss natural w/black	20017BH	\$139.99	17"
Low gloss raw w/black	21517BH	\$139.99	17"
High gloss black w/bright chrome	20417	\$139.99	17"
High gloss white w/bright chrome	20517	\$139.99	17"
Low gloss beech w/brushed chrome	20617	\$154.99	17"
Low gloss espresso w/gunmetal	20717	\$139.99	17"
Black rubber w/brushed chrome /no grippers ⚠	20817	\$139.99	17"
Low gloss whitewash w/brushed chrome	20917	\$154.99	17"
Raw finish w/gunmetal	21517	\$139.99	17"
Low gloss greywash w/brushed chrome	29917	\$154.99	17"
Low gloss black w/black	20217BH	\$139.99	17"
	20219BH	\$197.62	19"
High gloss black w/gold	20417GH	\$139.99	17"
High gloss white w/gold	20517GH	\$139.99	17"

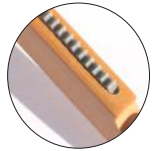

Inset Grippers
Featured on all
styles except
black rubber

NAHANCO Line Wood HANGERS

SUIT HANGERS w/ BAR

	Low gloss natural w/brushed chrome	19" 20019WB \$169.99 17" 20017WB \$143.99
	Low gloss white w/brushed chrome	19" 20119WB \$169.99 17" 20117WB \$143.99
	Low gloss black w/brushed chrome	19" 20219WB \$169.99 17" 20217WB \$143.99
	Low gloss mahogany w/brushed chrome	19" 20319WB \$169.99 17" 20317WB \$158.99
	Low gloss natural w/black	17" 20017WBBH \$143.99
	Low gloss raw w/black	17" 21517WBBH \$153.99
	High gloss black w/bright chrome	17" 20417WB \$143.99
	High gloss white w/bright chrome	17" 20517WB \$143.99
	Low gloss beech w/brushed chrome	17" 20617WB \$153.99
	Low gloss espresso w/gunmetal	17" 20717WB \$153.99
	Black rubber w/brushed chrome /no grippers	17" 20817WB \$158.99 
	Low gloss whitewash w/brushed chrome	17" 20917WB \$158.99
	Raw finish w/gunmetal	17" 21517WB \$153.99
	Low gloss greywash w/brushed chrome	17" 29917WB \$158.99
	Low gloss black w/black	17" 20217WBBH \$143.99 19" 20219WBBH \$169.99
	High gloss black w/gold	17" 20417WBGH \$143.99
	High gloss white w/gold	17" 20517WBGH \$143.99

new

FLAT SUIT HANGERS

Our most popular wood style in a suit hanger. Most styles have inset grippers. Hardware is brushed chrome, bright chrome, gunmetal, black or gold, depending on the finish.

17" width - 1/2" thick body; 100 pcs/case; 30 lbs./ Dim.wgt 36 lbs
19" width - 1/2" thick body; 100 pcs/case; 33/35 lbs



INSET GRIPPERS
Featured on all styles except black rubber



17" SUIT HANGER

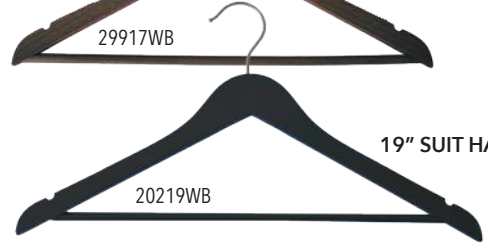

19" SUIT HANGER



FLAT 17" SUIT HANGER w/ CLIPS

260-17RC	Low gloss natural	\$150.99
261-17RC	Low gloss white	\$150.99
262-17RC	Low gloss black	\$150.99
263-17RC	Low gloss mahogany	\$150.99



INSET GRIPPERS



1/2" thick; brushed chrome hardware and inset grippers; 1 1/2" drop with brushed chrome clips; 100 /case; 37 lbs; available in four finishes

HANGERS NAHANCO Line Wood

NAHANCO LINE JACKET HANGERS



17" wide and 3/4" thick; features a 1 1/2" notched flare end; brushed chrome, bright chrome or gunmetal hook, depending on the finish; 24 /case; 16/19 lbs; available in ten finishes.

17" CONCAVE JACKET HANGER

23017	129.99	Low gloss natural /brushed chrome hook
23117	129.99	Low gloss white /brushed chrome hook
23217	129.99	Low gloss black /brushed chrome hook
23317	129.99	Low gloss mahogany /brushed chrome hook
23417	129.99	High gloss black /bright chrome hook
23517	129.99	High gloss white /bright chrome hook
23617	129.99	Low gloss beech /brushed chrome hook
23717	129.99	Low gloss espresso /gunmetal hook
23817	129.99	Black rubber /brushed chrome hook
23917	129.99	Low gloss whitewash /brushed chrome hook
23817BH	129.99	Black rubber /black hook
23817WWH	129.99	White rubber /white hook
23817G	129.99	Grey rubber /brushed chrome hook

NAHANCO LINE PANT/SKIRT HANGERS



Brushed chrome, bright chrome, black, gold, and gunmetal hardware, depending on the hanger finish; 3/8" thick with a 7/8" face; 100 pieces /case; 38 lbs

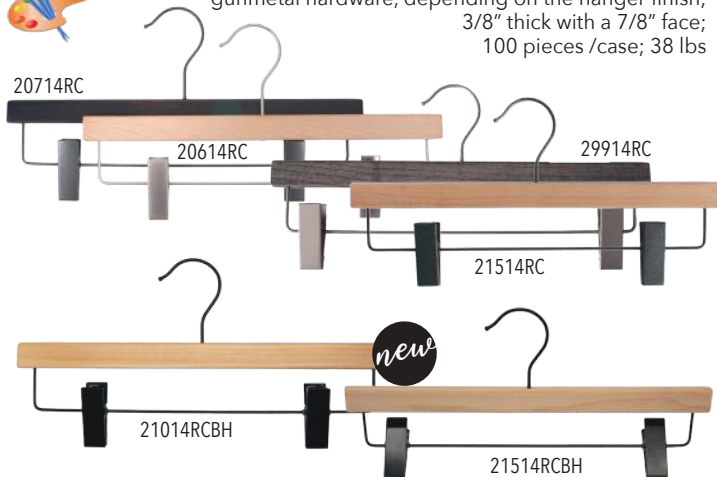

FLAT 16", 14" & 12" SKIRT/PANT HANGERS w/ CLIPS

21016RC	169.99	16"	Low gloss natural
21014RC	169.99	14"	
21012RC	169.99	12"	
21114RC	169.99	14"	Low gloss white
21112RC	169.99	12"	
21216RC	169.99	16"	Low gloss black
21214RC	169.99	14"	
21212RC	169.99	12"	
21314RC	169.99	14"	Low gloss mahogany
21312RC	169.99	12"	
20414RC	169.99	14"	High gloss black w/ bright chrome
20514RC	169.99	14"	High gloss white w/ bright chrome
20614RC	184.99	14"	Low gloss beech
20714RC	184.99	14"	Low gloss espresso w/ gunmetal
20814RC	169.99	14"	Black rubber
20914RC	184.99	14"	Low gloss whitewash
21514RC	184.99	14"	Raw finish w/ gunmetal
29914RC	184.99	14"	Low gloss greywash
21214BRC	169.99	14"	Low gloss black w/ black hook & bar
21216BRC	169.99	16"	Low gloss black w/ black hook & bar
20414RCGH	169.99	" 14"	High gloss black w/ gold
20514RCGH	169.99	14"	High gloss white w/ gold
21014RCBH	169.99	14"	Low gloss natural w/ black
21514RCBH	184.99	14"	Raw wood w/ black

For a visual reference to all of the NAHANCO Line finishes, see page 12 or visit nahanco.com



3/8" thick with a low gloss finish; brushed chrome hardware and locking wooden bar; 100 /case; 27 lbs; available in four finishes **\$127.99**

FLAT 14" PANT HANGERS w/ LOCKING BAR

21014PB	Low gloss natural
21114PB	Low gloss white
21214PB	Low gloss black
21314PB	Low gloss mahogany

NAHANCO Line Wood HANGERS

17" CONCAVE DISPLAY HANGER

24017	Low gloss natural	\$96.99
24117	Low gloss white	\$96.99
24217	Low gloss black	\$96.99
24317	Low gloss mahogany	\$96.99

17" wide and 3/4" thick with a 14" drop; with a 1 1/2" notched flare end and brushed chrome hardware; 12 /case; 14/27 lbs; available in four finishes.



DISPLAY HANGERS

with 1 1/2" flare end



24017



10" Infant Shirt Hangers

NAHANCO LINE CHILDREN'S HANGERS

Child-sized creations (10", 12" & 14" hangers)

10" INFANT SHIRT HANGERS



14" width - 1/2" thick body; 100 pcs /case.
12" width - 1/2" thick body; 100 pcs /case.
10" width - 1/2" thick body; 100 pcs /case.

SHIRT: 25/25 lbs
SHIRT: 18/23 lbs
SHIRT: 15/16 lbs; SUIT: 22/23 lbs

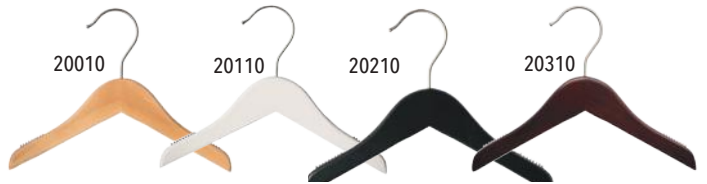

20010

20110

20210

20310

14" & 12" KIDS' SHIRT HANGERS

Low gloss natural w/brushed chrome

shirt	20014	\$139.99	14"
	20012	\$135.99	12"
	20010	\$157.12	10"
suit	20014WB	\$144.99	14"

Low gloss white w/brushed chrome

shirt	20114	\$139.99	14"
	20112	\$135.99	12"
	20110	\$157.12	10"
suit	20114WB	\$144.99	14"

Low gloss black w/brushed chrome

shirt	20214	\$139.99	14"
	20212	\$135.99	12"
	20210	\$157.12	10"
suit	20214WB	\$144.99	14"

Low gloss mahogany w/brushed chrome

shirt	20314	\$139.99	14"
	20312	\$135.99	12"
	20310	\$157.12	10"
suit	20314WB	\$183.74	14"

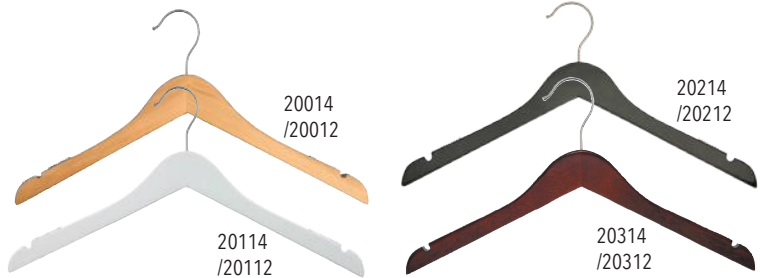

20014
/20012

20214
/20212

20114
/20112

20314
/20312

14" KIDS' SUIT HANGERS

We offer our wood children's hangers for every stage of growth:

The 10" are designed for infant (0-3 years) apparel. The 12" is ideal for the 3-8 year olds, and 14" are for 9 through tweens. 12" pant hangers are also available (see page 14 for details).

All children's hangers can be customized with logos or playful, colorful images.



20014WB

20214WB

20114WB

20314WB

HANGERS NAHANCO Line Wood



NAHANCO LINE BODY-SHAPED DISPLAY HANGERS

20217BHDISPLAY



23117WHDISPLAY



4 finish/metal combinations

Two body-shaped display hangers. NAHANCO Line wood flat shirt hangers and jacket hangers are combined with a body-shaped wire drop to create a hybrid wood/wire product.

Both styles are ideal for hanging and displaying a wide range of garments, from swimwear and lingerie, to dresses and more.

Each style comes in a choice of 4 finishes.

See page 39 for more details

NAHANCO LINE RUBBERIZED WOOD HANGERS



See page 30 for more details



Wood hanger bodies are enveloped in a smooth, no-slip, no-snag, rubber coating.

100 pieces /case

3 rubberized finishes



20817

20817BH

20817G

20817WWH

black rubber w/brushed chrome hardware

black rubber w/black hardware

grey rubber w/brushed chrome hardware

white rubber w/white hardware

20814RC

20814BRC

20814RCG

20814RCWWH

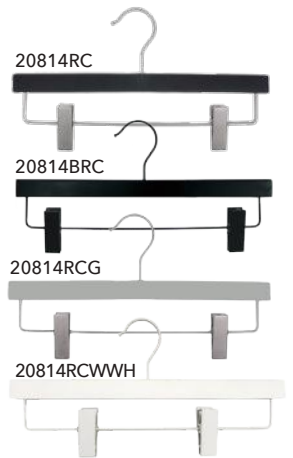

new

23817BH



23817WWH



23817G



23817



NAHANCO WOOD BRIDAL & FORMALWEAR HANGERS

Traditional NAHANCO line wooden hangers with reinforced heavy-duty hooks to prevent the hooks being pulled out from the weight of heavier garments. Soft grippers for delicate fabrics and notches for formalwear straps.

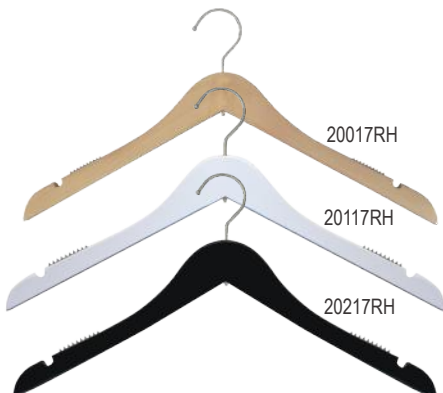

20017RH

20117RH

20217RH

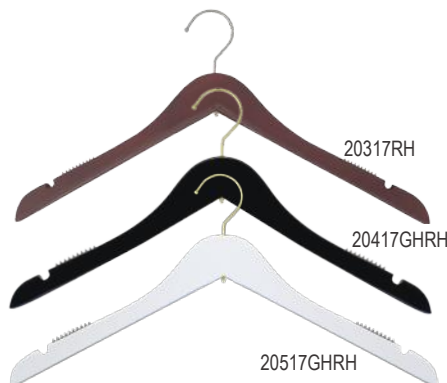

20317RH

20417GHRH

20517GHRH

Reinforced heavy-duty hooks



See page 31 for more details



SLIMLINE WOOD HANGERS

Fit **TWICE** the merchandise on your racks without giving up the luxury of a wood hanger.

NAHANCO SLIMLINE WOOD



Behold our SlimLine wood hanger! Almost as thin as our slimline velvet hangers, and as luxe as our NAHANCO line hangers.

Available in a range of finishes, including natural, black, white, and matte black rubber coated, mahogany, high gloss white, unfinished - all with swivel hooks and various hardware finishes, including brushed chrome, gold, black, and gunmetal hardware.



Great for smaller shops & home closets



SLIMLINE hangers are available to customize using our online DIY tool, the Custom Creator



WIDTH COMPARISONS | NAHANCO LINE & SLIMLINE

The Slimline jacket hanger (far left) flares to 1/2" in width, compared to the 3/4" flare of the NAHANCO jacket hanger (near left). The NAHANCO line shirt hanger (far right) is 1/2", twice the width of the Slimline version (near right), which has a flat 1/4" body.



HANGERS SLIMLINE Wood

pant hanger w/clips

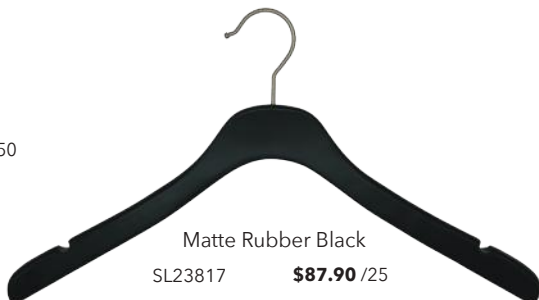

The SlimLine shape is also available in a heavier jacket style



NON-SLIP Black Rubber coated finish

NON-SLIP ATTACHMENTS FOR SLIMLINE WOOD

new

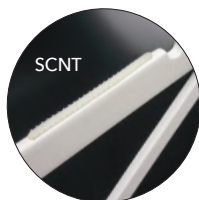
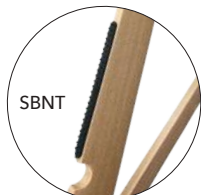

ADHESIVE GRIPPER

Non-slip Attachments w/ a Raised Textured Surface

Available in Black or Clear;
2 3/8" long x 3/16" wide; 1000 /case; 5 lbs.

SBNT Black **\$51.99**
SCNT Clear **\$51.99**

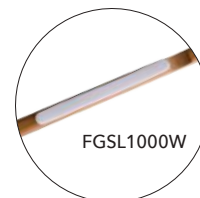

Non-slip accessories

ADHESIVE FOAM

Non-slip Attachments

Available in Black or White;
2 1/4" long; 1000 /case; 2/3 lbs.

FGSL1000B Black **\$55.46**
FGSL1000W White **\$55.46**

See page 67 for additional details

HANGER WIDTH COMPARISONS



SLIM VELVET



SLIMLINE WOOD



TRADITIONAL WOOD

SLIMLINE WOOD frees up crowded rails

TRADITIONAL HANGERS

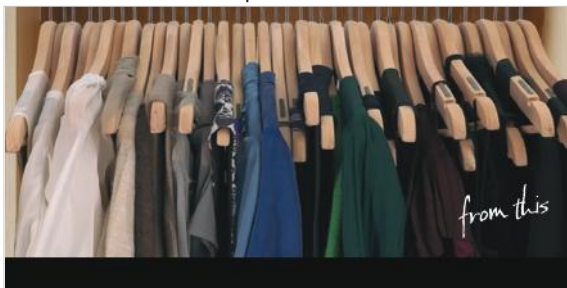

SLIMLINE HANGERS



SLIMLINE Wood HANGERS



SLIMLINE WOOD COLLECTION: 5 styles, each in 8 finishes

SHIRT HANGERS 50 /case 17" wide, ¼" thick; 8/13 lbs.

SL7001750	Low gloss Natural	59.90
SL7011750	Low gloss White	59.90
SL7021750	Low gloss Black	59.90
SL7081750	Matte Black Rubber coated	59.90
SL7051750GH	High gloss White w/Gold hook	59.90
SL7021750BH	Low gloss Black w/Black hook	59.90
SL7031750GH	Mahogany w/Gold hook	59.90
SL7151750GM	Raw finish w/Gunmetal hook	59.90

SHIRT/DRESS



JACKET HANGERS 25 /case 17" wide, ½" thick; 27 lbs.

SL23017	Low gloss Natural	87.90
SL23117	Low gloss White	87.90
SL23217	Low gloss Black	87.90
SL23817	Matte Black Rubber coated	87.90
SL23517GH	High Gloss White /gold hook	87.90
SL23217BH	Low gloss Black w/black hook	87.90
SL23317GH	Mahogany w/gold hook	87.90
SL25517GM	Raw finish w/gunmetal hook	87.90

JACKET



SKIRT/PANT HANGERS

50 /case 14" wide, ¼" thick; 12/12 lbs.

SL70014RC50	Low gloss Natural	79.90
SL70114RC50	Low gloss White	79.90
SL70214RC50	Low gloss Black	79.90
SL70814RC50	Matte Black Rubber coated	79.90
SL70514RC50GH	High gloss White w/Gold hook	79.90
SL70214RC50BH	Low gloss Black w/Black hook	79.90
SL70314RC50GH	Mahogany w/Gold hook	79.90
SL71514RC50GM	Raw finish w/Gunmetal hook	79.90

SKIRT/PANT



SUIT HANGERS

50 /case 17" wide, ¼" thick; 10/14 lbs.

with bar:

SL70017WB50	Low gloss Natural	69.90
SL70117WB50	Low gloss White	69.90
SL70217WB50	Low gloss Black	69.90
SL70817WB50	Matte Black Rubber coated	69.90
SL70517WB50GH	High gloss White w/Gold hook	69.90
SL70217WB50BH	Low gloss Black w/Black hook	69.90
SL70317WB50GH	Mahogany w/Gold hook	69.90
SL71517WB50GM	Raw finish w/Gunmetal hook	69.90

w/ bar

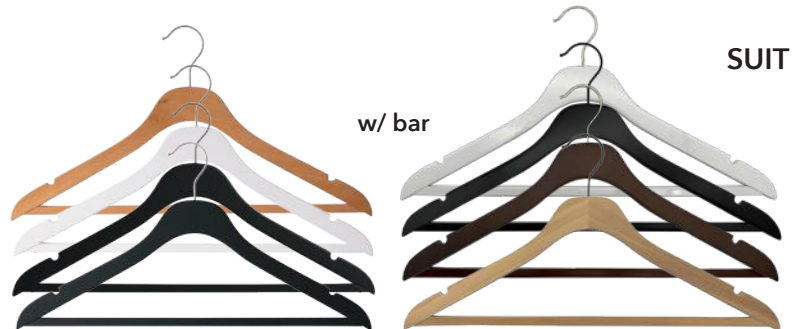

SUIT

50 /case 17" wide, ¼" thick; 12/19 lbs.

with clips:

SL70017RC50	Low gloss Natural	92.90
SL70117RC50	Low gloss White	92.90
SL70217RC50	Low gloss Black	92.90
SL70817RC50	Matte Black Rubber coated	92.90
SL70517RC50GH	High gloss White w/Gold hook	92.90
SL70217RC50BH	Low gloss Black w/Black hook	92.90
SL70317RC50GH	Mahogany w/Gold hook	92.90
SL71517RC50GM	Raw finish w/Gunmetal hook	92.90

w/ clips

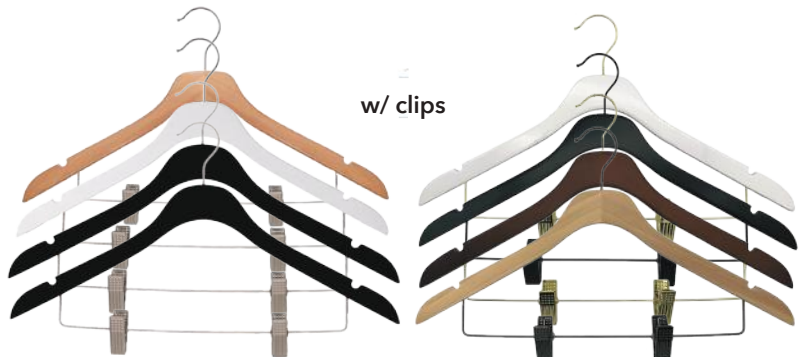

HANGERS Equinox Line

EQUINOX LINE SHIRT & PANT/SKIRT HANGERS

Thin, flat and sleek with deep, sculpted notches. Perfect for customizing. Everything you could want from a modern hanger.

Available in both wood and acrylic styles.



EQUINOX WOOD HANGERS



High Gloss Black & White and Low Gloss Natural w/ brushed chrome hardware; Low Gloss Espresso w/gunmetal hardware



Shirt hangers:

17"; 5/16" thick; 50 /case; 13/15 lbs.

29201750	Black	\$133.74
29101750	White	\$133.74
29701750	Espresso	\$133.74
29001750	Natural	\$133.74

Pant/skirt hangers:

14"; 5/16" thick; 50 /case; 16 lbs.



292014RC50	Black	\$166.24
291014RC50	White	\$166.24
297014RC50	Espresso	\$166.24
290014RC50	Natural	\$166.24

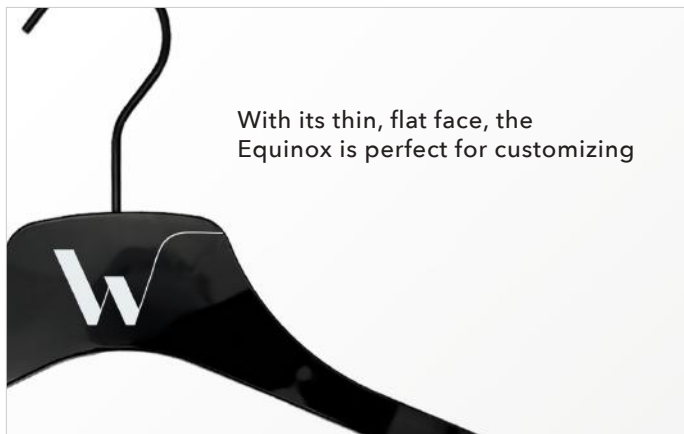

With its thin, flat face, the Equinox is perfect for customizing

EQUINOX ACRYLIC HANGERS

High Gloss Black, White & Clear



Shirt hangers:

17"; 5/16" thick; 50 /case; 14 lbs.

w/ brushed chrome hardware:		
9201750	Black	\$145.99
9101750	White	\$145.99
9001750	Clear	\$145.99

w/ gold hardware:		
92017GH50	Black	\$145.99
91017GH50	White	\$145.99
90017GH50	Clear	\$145.99

w/ black hardware:		
92017BH50	Black	\$145.99

w/ shiny chrome hardware:		
92017CH50	Black	\$145.99
91017CH50	White	\$145.99
90017CH50	Clear	\$145.99

Pant/skirt hangers:

14"; 5/16" thick; 50 /case; 17 lbs.

w/ brushed chrome hardware:		
92014RC50	Black	\$169.53
91014RC50	White	\$169.53
90014RC50	Clear	\$169.53

w/ gold hardware:		
92014RCG50	Black	\$169.53
91014RCG50	White	\$169.53
90014RCG50	Clear	\$169.53

w/ black hardware:		
92014BRC50BH	Black	\$169.53

w/ shiny chrome hardware:		
92014RCCH50	Black	\$169.53
91014RCCH50	White	\$169.53
90014RCCH50	Clear	\$169.53

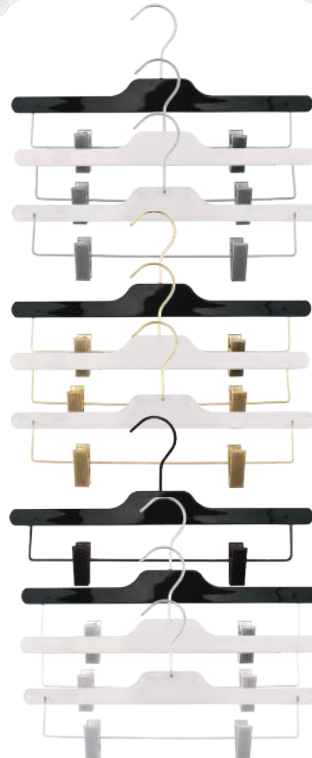

Executive Line Wood HANGERS

EXECUTIVE HANGERS

SHIRT HANGERS

50 /case 17 1/2" wide, 1/2" thick; 13 lbs. **\$77.75**

- 2007-14N Natural
- 2007-14W White
- 2007-14B Black
- 2007-14C Cherry



EXECUTIVE HANGER LINE

Concave with chrome hardware and a gloss finish

SUIT HANGERS w/bar

50 /case 17 1/2" wide, 1/2" thick; 15 lbs. **\$85.85**

- 2007-15N Natural
- 2007-15W White
- 2007-15B Black
- 2007-15C Cherry

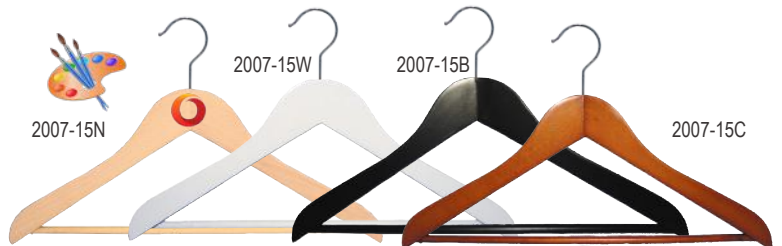

SUIT HANGERS w/clips

50 /case 17 1/2" wide, 1/2" thick; 21 lbs. **\$113.74**

- 2007-16N Natural
- 2007-16W White
- 2007-16B Black
- 2007-16C Cherry

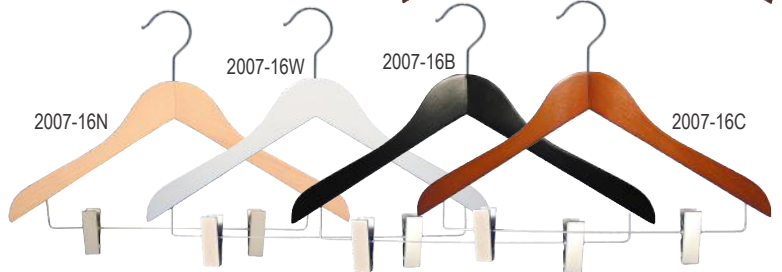

EXECUTIVE FLARE HANGERS

SHIRT HANGERS

25 /case 17 1/2" wide, 1/2" thick; 13/19 lbs. **\$77.75**

- 2007-17N Natural
- 2007-17W White
- 2007-17B Black
- 2007-17C Cherry



EXECUTIVE FLARE HANGER LINE

Concave with chrome hardware and a gloss finish

1 7/8" Flare

SUIT HANGERS w/bar

25 /case 17 1/2" wide, 1/2" thick; 16/22 lbs. **\$80.99**

- 2007-18N Natural
- 2007-18W White
- 2007-18B Black
- 2007-18C Cherry

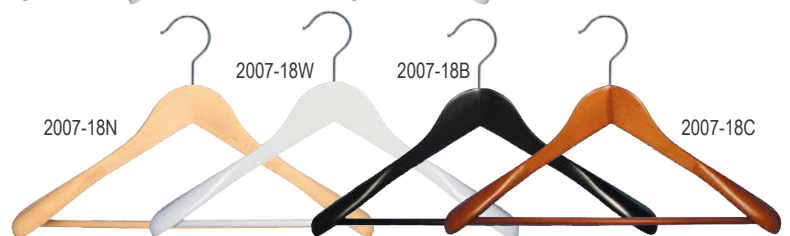

SUIT HANGERS w/clips

25 /case 17 1/2" wide, 1/2" thick; 17/19 lbs. **\$113.74**

- 2007-19N Natural
- 2007-19W White
- 2007-19B Black
- 2007-19C Cherry



SKIRT/PANT HANGERS

25 /case 14" wide, 1/2" thick; 7/9 lbs. **\$69.34**

- 200713N Natural
- 200713W White
- 200713B Black
- 200713C Cherry



EXECUTIVE PANT HANGER

Flat with chrome hardware and a gloss finish

HANGERS Northshire, Signature & Retro



NORTHSHIRE LINE JACKET HANGERS

A classic jacket hanger with a $\frac{3}{8}$ " shoulder, a 1 $\frac{1}{8}$ " flare and a ball end hook. 16 $\frac{1}{2}$ " wide; 24 pieces per carton; 9/15 lbs.



Northshire hangers feature notched, flared ends



25217	25117	25517	25717	29517	25317
Low Gloss Black w/ brushed chrome hardware	Low Gloss White w/ brushed chrome hardware	Raw Finish w/ gunmetal hardware	Low Gloss Espresso w/ gunmetal hardware	Low Gloss Greywash w/ brushed chrome hardware	Low Gloss Mahogany w/ brushed chrome hardware
24 pieces/ \$89.99	24 pieces/ \$89.99	24 pieces/ \$109.99	24 pieces/ \$109.99	24 pieces/ \$109.99	24 pieces/ \$109.99

SIGNATURE WOOD HANGERS

Flat with brushed chrome hardware

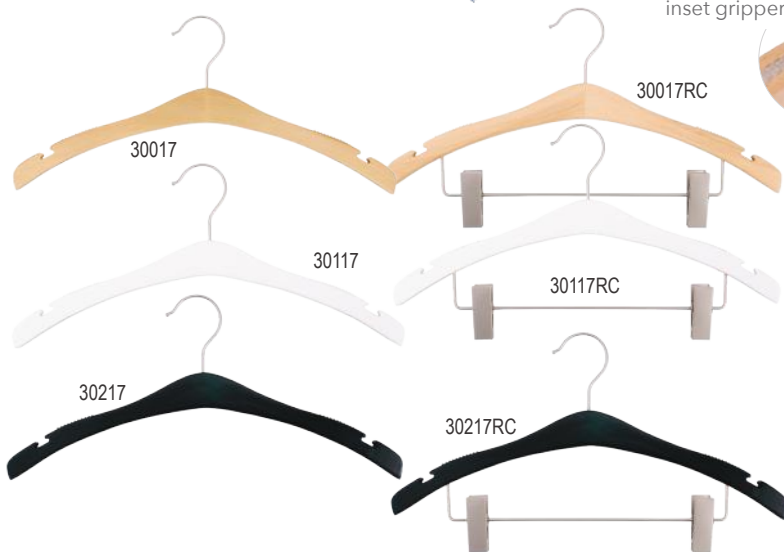

SIGNATURE HANGERS

SHIRT HANGERS

100 /case 16 $\frac{3}{4}$ " wide, $\frac{1}{2}$ " thick; 28 lbs.

30017	199.99	Low gloss natural
30117	199.99	Low gloss white
30217	199.99	Low gloss black

SUIT HANGERS w/clips

100 /case 16 $\frac{3}{4}$ " wide, $\frac{1}{2}$ " thick; 37/42 lbs.

30017RC	212.49	Low gloss natural
30117RC	212.49	Low gloss white
30217RC	212.49	Low gloss black

Each wooden hanger is unique, so expect slight variations in the lighter wood colors, wood grains and the landscape of each hanger face (resulting in minute differences in logo placement).

RETRO WOOD HANGERS

Flat with brushed chrome hardware



RETRO HANGERS

SHIRT HANGERS

100 /case 16" wide, $\frac{1}{2}$ " thick; 22/28 lbs.

40017	152.49	Low gloss natural
40117	152.49	Low gloss white
40217	152.49	Low gloss black

SUIT HANGERS w/clips

100 /case 16" wide, $\frac{1}{2}$ " thick; 37 lbs.

40017RC	209.99	Low gloss natural
40117RC	209.99	Low gloss white
40217RC	209.99	Low gloss black

Contemporary Wood HANGERS



 **CONTEMPORARY HANGER LINE**
Flat body with a softer slope, chrome hardware, ball-end hook and a gloss finish

SHIRT HANGERS w/notches

100 /case; 17" wide, 3/8" thick; 27/29 lbs. **\$148.99**

200720NN	Natural
200720WN	White
200720BN	Black



CONTEMPORARY PANT/SKIRT w/standard clips

100 /case; 14" wide, 3/8" thick; 30 lbs. **\$150.49**

200723N	Natural
200723W	White
200723B	Black

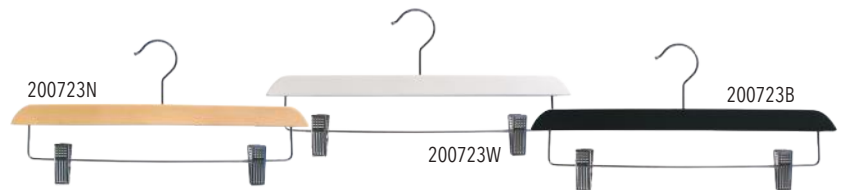

SHIRT HANGERS - no notches

100 /case; 17" wide, 3/8" thick; 34/35 lbs. **\$143.99**

2007-20N	Natural
2007-20W	White
2007-20B	Black
2007-20C	Cherry



SUIT HANGERS w/bar

100 /case; 17" wide, 3/8" thick; 37 lbs. **\$116.99**

2007-21N	Natural
2007-21W	White
2007-21B	Black
2007-21C	Cherry

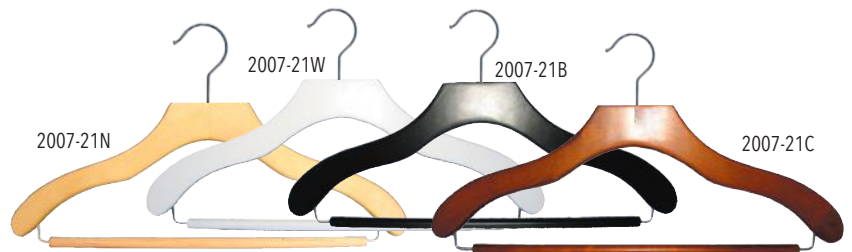

SUIT HANGERS w/Euro clips

100 /case; 17" wide, 3/8" thick; 37 lbs. **\$138.49**

2007-22N	Natural
2007-22W	White
2007-22B	Black
2007-22C	Cherry

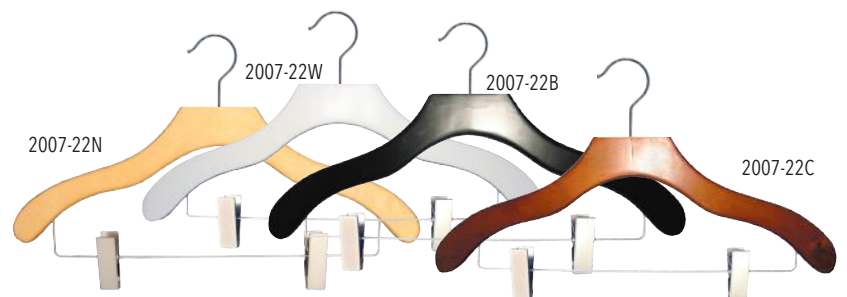

HANGERS Specialty Wood

SPECIALTY WOOD HANGERS

BAMBOO HANGERS Flat with chrome hardware

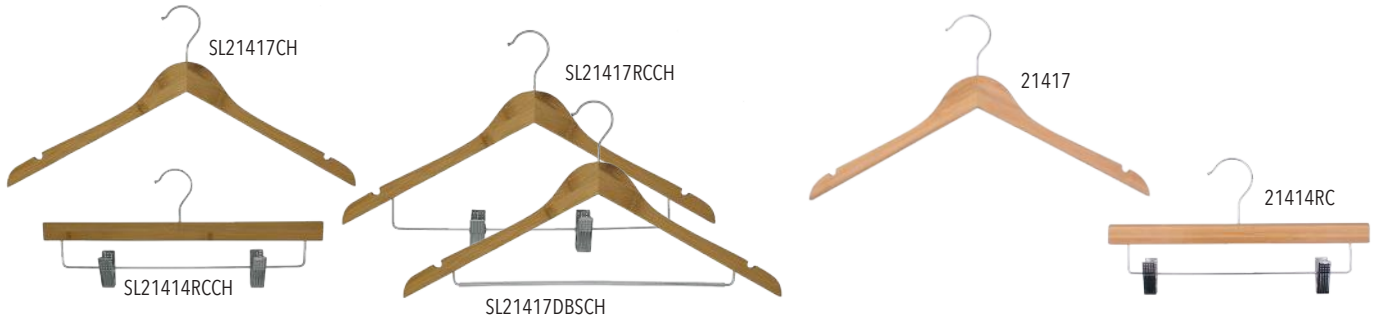

SLIMLINE BAMBOO Low gloss finish; 1/4" thick; 50 pieces/case.

Shirt hanger; 17" wide; 13 lbs; **SL21417CH \$ 97.49**
Pant/Skirt hanger; 14" wide w/ 7/8" face; 19 lbs; **SL21414RCCH \$ 113.11**
Suit hanger w/drop bar & clear sleeve; 17" wide; 13 lbs; **SL21417DBSCH \$ 138.74**
Suit hanger w/drop bar and clips; 17" wide; 13 lbs; **SL21417RCCH \$ 82.99**

STANDARD BAMBOO Low gloss finish; 1/2" thick; 50 pieces/case.

Shirt hanger; 17" wide; 13 lbs; **21417 \$112.49**
Pant/Skirt hanger; 14" wide w/ 7/8" face; 19 lbs; **21414RC \$129.99**

WALNUT GOLD SERIES HANGERS Gloss walnut finish with gold hardware



Flat Shirt hanger; 17" wide; 1/2" thick; 100 pieces/case; 26/29 lbs; **8317GH (no notches) \$123.74**

Concave Shirt hanger; 17" wide; 1" thick; 40 pieces/case; 24/28 lbs; **2017GH \$159.99**

Pant/Skirt hanger; 14" wide; 1/2" thick w/ 7/8" face; flat w/metal clips; 100 pieces/case; 30 lbs; **CLIPGH \$158.74**

DARK WOOD HANGERS

Flat with gunmetal hardware



Low gloss dark wood; 1/2" thick; 100 pieces/case.

Shirt hanger; 17" wide; 28/32 lbs; **LVS17TOPDKRS \$138.74**
Pant/Skirt hanger; 14" wide w/ 1 1/8" face; 38 lbs; **LVSPANTDKRS \$192.49**
Display hanger; 12 pieces/case. 17" wide w/ 16" drop; 17/27 lbs; **LVS23317DKRS16 \$98.74**

BENTWOOD HANGERS Flat with chrome hardware



Low gloss natural finish; 1/2" thick; 100 pieces/case.

Shirt hanger; 17" wide; 17 lbs; **664 \$133.74**
Pant/Skirt hanger; 15" wide; 22 lbs; **652 \$151.24**

MINI WOOD HANGERS Flat with chrome hardware /100 pcs

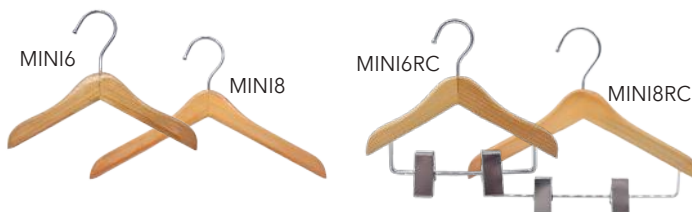

MINI6 6" wide 5lbs **77.99**
MINI8 8" wide 10lbs **81.49**

MINI6RC 6" wide 9lbs **103.49**
MINI8RC 8" wide 14lbs **113.49**

PET HANGERS 8" mini wood hangers engraved w/ paws or bone design



Natural finish; 1/2" thick; 5 pieces/carton

no clips 4 lbs	\$15.99	w/ clips 5 lbs	\$17.99
Paws	MINI8ENGPAW	Paws	MINI8RCENGPAW
Bone	MINI8ENGBONE	Bone	MINI8RCENGBONE

WOOD HOTEL hanger options include:



Traditional LINE

Traditional SUIT

NAHANCO LINE

Equinox LINE16

Contemporary LINE

Northshire LINE

The majority of our stock wood hanger styles also make great hotel hangers.

Order them as they are. Or customize them with your logo. A few of our many lines are pictured above. Page through our wood collections, and contact our service reps for more information about our hangers. Or, if you're interested in creating something unique to your brand, speak with a member of our sales team.

NAHANCO HOTEL FLAT WOODEN & CHROME HANGERS

Our Hotel Collection features flat suit ball top wooden hangers, a closed hook chrome hanger and the A-style and B-style security rings used with the ball top hangers. Great for imprinting your company's logo.

FLAT SUIT Ball Top Wood Hanger

w/Metal Sliding Clips

17 1/2" wooden suit hanger features a dropped bar and sliding chrome clips. Notched ends accommodate garments with straps. 100 pieces/case. 33/35 lbs. **\$208.01**



FLAT SUIT Ball Top Wood Hanger

w/Pant Bar

17 1/2" wooden flat suit hanger features a stationary pant bar. Notched ends accommodate garments with straps. 100 pieces/case. 29/30 lbs. **\$159.57**



- Black**
60217BECRC
- Mahogany**
60317BECRC
- Natural**
60017BECRC



- Black**
60217BEC
- Mahogany**
60317BEC
- Natural**
60017BEC

Most of our wooden hangers can be fitted with a ball post for hotel use. Please call Customer Service for details.



A-RING for Ball Top Hangers

Chrome plated steel hotel-style ring stays put when installed on any standard closet bar; easily detach from the circular hook. 100 pcs/bag. 9 lbs; HHSRA100 **\$42.82**



B-RING for Ball Top Hangers

Chrome finished steel clamping hanger. The B-Style Ring clamps down over the bar. 100 pcs/bag. 5/8 lbs; HHSRB100 **\$48.63**

17" CLOSED HOOK Chrome Hanger

Made with heavy duty 4mm chrome plated wire, this hanger is durable and long lasting. The opening diameter of the hook measures 1 1/2". 100 pieces/case. 25 lbs; 89017 **\$182.53**

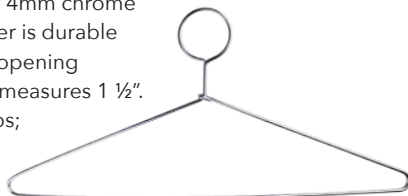

17" MINI HOOK Hangers

17" wooden suit hangers with a natural gloss finish and a flat 1/2" thick profile, feature notched ends for straps and a mini chrome hook to fit a 5/8" diameter hang bar. 100 pieces/case;
w/ 2" drop bar and pinch clips:
 8017RCMH **\$207.20**
w/ round wood pant bar:
 8017NOTCHMH **\$158.60**



HANGERS Suiting & Tailoring

Wood hangers and accessories for tailored garments



concave jacket and suit hangers

Premium hangers available in either a 1/2" or a 1" thick body, with a choice of gold or chrome hardware.

1/2" thick



flocked hang bars

1" thick



see pages 28-29
for product details

executive lines

The executive is available in two body types: the **standard** - 17 1/2" wide hanger with a ball-end hook and a concaved body; and the **flare** - 18" wide with a 1 7/8" flare for added garment support and structure. Both are available in four finishes.

standard



flare



see page 21
for product details

1 7/8" flare



body forms



A coat or half body form provides dimensional display.



see pages 129-133
for product details

fabric care

Quality garments require proper garment care with specialized tools like brushes and combs.



see page 125
for product details



Traditional Wood **HANGERS**



TRADITIONAL HANGER LINE

Premium wood hanger at an economy price



SHIRT HANGERS w/notches

100 /case; 17" wide, 1/2" thick; 28/29 lbs. **\$99.88**

81-17CH	Natural gloss	99.88
8217CHNOBAR	Black gloss	99.88
8117WCHNOTCH	White gloss	99.88



FLAT SHIRT HANGER
with Shoulder Notches
Chrome hook

SHIRT HANGERS - no notches

100 /case; 17" wide, 1/2" thick; 28/29 lbs. **\$99.88**

8117CHNONOTCH	Natural gloss	99.88
8117WCH	White gloss	99.88

FLAT SHIRT HANGER
without Shoulder Notches
Chrome hook



SUIT HANGERS w/bar

100 /case; 17" wide, 1/2" thick; 30/31 lbs. **\$99.88**

80-17	Natural gloss	99.88
8017W	White gloss	99.88
8217CH	Black gloss	99.88



FLAT SUIT HANGER
Stationary pant bar
Chrome hook

SUIT HANGERS w/2" chrome drop

100 /case; 17" wide, 1/2" thick; 30/31 lbs. **\$137.38**

8017CHRC	Natural	
----------	---------	--



FLAT SUIT HANGER
2" chrome drop
Chrome hook



PANT/SKIRT w/clips

100 /case; 14" wide, 1/2" thick; 31 lbs.

1214RCCH	White w/chrome hardware	118.63
6214RCCH	Natural w/chrome hardware	118.63
6214RCGH	Natural w/gold hardware	156.13
8214RCCH	Walnut w/chrome hardware	118.63
8214RCGH	Walnut w/gold hardware	162.49
2214RCCH	Black w/chrome hardware	118.63
2214RCGH	Black w/gold hardware	162.49



SKIRT/PANT HANGER
Flat with chrome or gold hardware

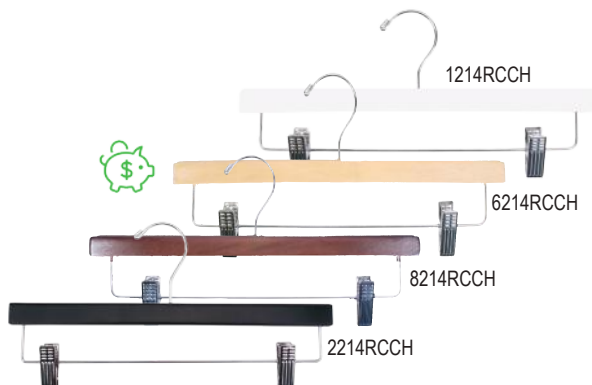

gold hardware



HANGERS Traditional Wood



EXTRA-THICK CONCAVE JACKET HANGER
Chrome hook

JACKET HANGERS / 1" thick

40 /case 17" wide, 1" thick; 22/32 lbs. **\$154.99**

2017CH	Walnut gloss	154.99
2117CH	Natural gloss	154.99
2217CH	Black gloss	154.99
2317CH	Natural w/waxed finish	154.99



EXTRA-THICK CONCAVE SUIT HANGER
Chrome hardware and locking trouser bar

SUIT HANGERS / 1" thick

40 /case 17" wide, 1" thick; 29/39 lbs.

2017CHPB	168.74	Walnut gloss
2117CHPB	168.74	Natural gloss
2217CHPB	168.74	Black gloss
2317CHPB	192.49	Natural w/waxed finish

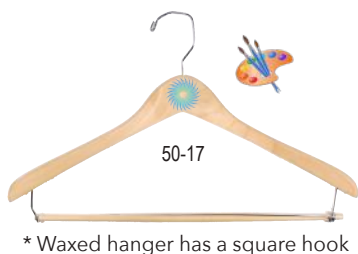

CONCAVE SUIT HANGER
Chrome or gold hardware with locking trouser bar

* Waxed hanger has a square hook

HOOK finishes:

CH/Chrome Hook
GH/Gold Hook



SUIT HANGERS / 1/2" thick

100 /case; 1/2" thick

50-14	254.83	14" Natural w/waxed finish, sq hook	27/35
50-17	247.86	17" Natural w/waxed finish, sq hook	39/40
50-19	254.83	19" Natural w/waxed finish, sq hook	42/48
7017CH	202.82	17" Walnut, chrome hook	38/49
7019GH	254.83	19" Walnut, gold hook	38/44
7117CH	202.82	17" Natural, chrome hook	38/45
7119GH	254.83	19" Natural, gold hook	41/48
72-17CH	206.39	17" Black, chrome hook	33/48
72-17	206.39	17" Black, gold hook	33/48



NOTCHED CONCAVE SUIT HANGER
Chrome or gold hardware

SUIT HANGERS / 1/2" thick w/2" drop

100 /case; 1/2" thick

70-17RC	214.97	17" Walnut, gold hardware	39/45
7117RCCH	214.97	17" Natural, chrome hardware	39/45
7217RCCH	214.97	17" Black, chrome hardware	39/48
72-17RC	239.27	17" Black, gold hardware	39/48

Traditional Wood HANGERS

JACKET HANGERS - Concave & 1/2" thick

100 /case; 17" wide, 1/2" thick **\$159.99**

1217CH	Black w/chrome hardware	29/31
12-17	Black w/gold hardware	29/31
14-17	Natural, waxed w/chrome hardware	29/31
1017CH	Walnut w/chrome hardware	29/33
1017GH	Walnut w/gold hardware	29/33
10-19GH	19" wide - Walnut w/gold hardware	33/36
11155CH	15 1/2" wide - Natural w/chrome hardware	22/30
1117CH	Natural w/chrome hardware	29/33
11-17GH	Natural w/gold hardware	29/33



CONCAVE JACKET HANGER
Chrome or gold hook

SUIT HANGERS - 1" thick w/BLACK FLOCKED BAR

40 /case; 17" wide, 1" thick; 29/39 lbs.

w/ CHROME hardware **\$192.38**

2017CHFB	Walnut gloss
2117CHFB	Natural gloss
2217CHFB	Black gloss

w/ GOLD hardware **\$195.61**

2017GHFB	Walnut gloss
2117GHFB	Natural gloss
2217GHFB	Black gloss



EXTRA-THICK CONCAVE SUIT HANGER w/Flocked Bar
Chrome or Gold hardware

SUIT HANGERS - 1/2" thick w/BLACK FLOCKED BAR

100 /case; 17" wide, 1/2" thick; 29/39 lbs.

w/ CHROME hardware **\$172.49**

7017CHFB	Walnut gloss
7117CHFB	Natural gloss
7217CHFB	Black gloss

w/ GOLD hardware **\$178.11**

7017GHFB	Walnut gloss
7117GHFB	Natural gloss
7217GHFB	Black gloss

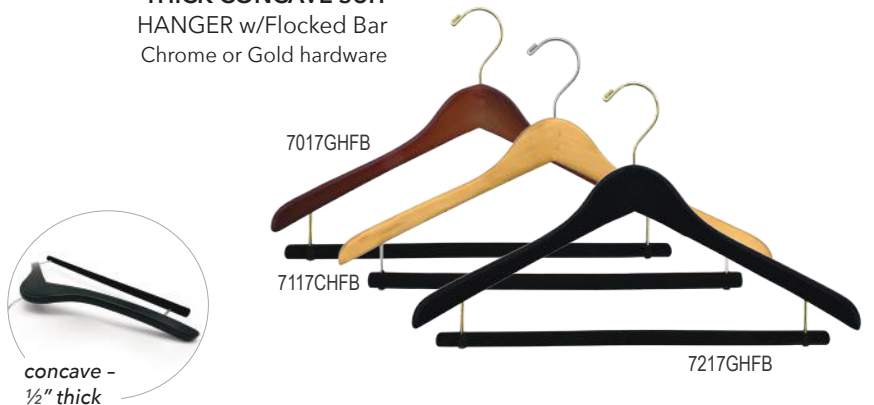

THICK CONCAVE SUIT HANGER w/Flocked Bar
Chrome or Gold hardware

DISPLAY HANGERS - 1/2" thick w/10" drop

12 /case; 17" wide, 1/2" thick; 7/34 lbs. **\$64.15**

101-17RC	Natural w/chrome hardware
100-17RC	Walnut w/chrome hardware

NOTCHED CONCAVE DISPLAY HANGER
Chrome hardware

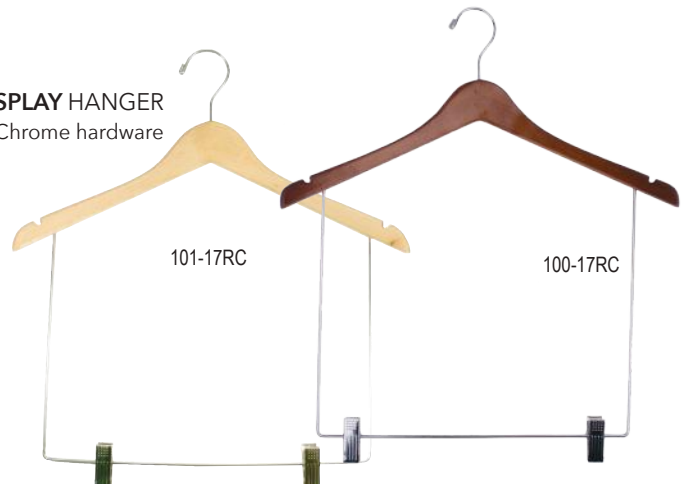

HANGERS Rubberized Wood

Non-slip with a buttery soft finish

NAHANCO LINE RUBBERIZED WOOD HANGERS

Initially designed for the performance wear industry. Heavy-duty, wood bodies are envelope d in a smooth, no-slip, no-snag, rubber coating. 100 pieces /case

17" FLAT TOP HANGERS

17" wide; 1/2" thick; rubber coated w/notched ends; 33/34lbs **\$139.99**

- 20817 Black rubber, chrome hook
- 20817BH Black rubber, black hook
- 20817G Grey rubber, brushed chrome hook
- 20817WWH White rubber, white hook



three rubberized finishes



14" FLAT PANT HANGERS

14" wide; 3/8" thick; rubber-coated; 31 /31 lbs

- 20814RC Black rubber, chrome hardware **\$169.99**
- 20814BRC Black rubber, black hardware **\$212.49**
- 20814RCG Grey rubber, brushed chrome hardware **\$212.49**
- 20814RCWWH White rubber, white hardware **\$212.49**

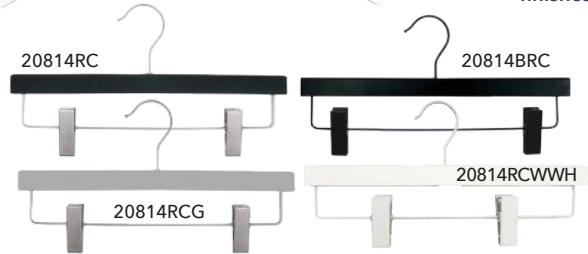

17" JACKET HANGERS

17" wide; 17" wide and 3/4" thick; features a 1 1/2" notched flare end; 1/2" thick; 24pc/case; 33/34lbs **\$129.99**

new



- 23817 Black rubber /brushed chrome hook
- 23817BH Black rubber /black hook
- 23817G Grey rubber /brushed chrome hook
- 23817WWH White rubber /white hook

RUBBERIZED WOOD INTIMATE HANGERS

Smaller than traditional top hangers, black rubber wrapped wood lingerie styles with no-slip brushed chrome clips are ideal for hanging sports bras and stretchy yoga apparel. 100 pieces /case



mini clips for hanging bottoms



fine rubber-tipped grippers for straps



- | | | | | |
|----------------|--------------|-----------|-----------------|--|
| w/ DROP | | | | |
| NH11BR | 11 7/8" wide | 16 /24lbs | \$178.74 | |
| NH13BR | 14" wide | 27lbs | \$191.24 | |

- | | | | | |
|-------------------|--------------|--------|-----------------|--|
| w/out DROP | | | | |
| NH12BR | 11 7/8" wide | 16 lbs | \$144.99 | |
| NH14BR | 14" wide | 18 lbs | \$157.49 | |

BRIDAL & FORMALWEAR

NAHANCO WOOD BRIDAL HANGERS

Traditional NAHANCO line wooden hangers with reinforced heavy-duty hooks to prevent the hooks being pulled out from the weight of heavier garments. Soft grippers for delicate fabrics and notches for formalwear straps.



Reinforced heavy-duty hooks

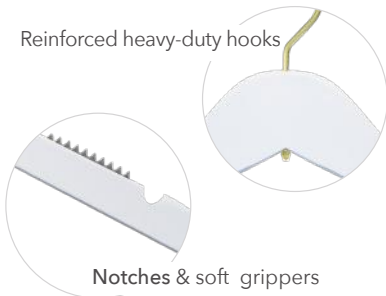

Notches & soft grippers



We are your branding and personalization partner. Custom imprint in as little as 5 to 7 days. Make it beautiful. Make it yours.

Contact us and/or scan the QR code for further details.



20017RH

20117RH

20217RH

20317RH

20417GHRH

20517GHRH

Hangers are 17" wide and 1/2" thick. Available in packs of 100 and 25.

100 pack 28/29 lbs.

\$144.36	20017RH	Low gloss Natural w/ brushed chrome hardware
\$144.36	20117RH	Low gloss White w/ brushed chrome hardware
\$144.36	20217RH	Low gloss Black w/ brushed chrome hardware
\$144.36	20317RH	Low gloss Mahogany w/brushed chrome hardware
\$149.36	20417GHRH	High gloss Black w/ gold hardware
\$149.36	20517GHRH	High gloss White w/ gold hardware

25 pack 10/10 lbs.

20017RH25	\$43.74
20117RH25	\$43.74
20217RH25	\$43.74
20317RH25	\$43.74
20417GHRH25	\$44.99
20517GHRH25	\$44.99



23017

23117

23217

23317

23817WWH

23817G

17" CONCAVE JACKET & GOWN HANGER

Ultra luxurious extra thick wooden hanger. Bridal. Menswear. Forms.

17" wide and 3/4" thick; features a 1 1/2" notched flare end; 24 /case; 16/19 lbs; See **pages 14** for all ten options. **\$129.99**

23017	Low gloss natural /brushed chrome hook	23317	Low gloss mahogany /brushed chrome hook
23117	Low gloss white /brushed chrome hook	23817G	Grey rubber coated /brushed chrome hook
23217	Low gloss black /brushed chrome hook	23817WWH	White rubber coated /white hook

BRIDAL & FORMALWEAR



IMPRINTED BRIDAL PARTY HANGERS

Use for bridalwear, pre-wedding clothing, robes and lingerie. They make great gifts or photographers' props, and can be sold in boutique settings. High quality wood hangers in stock. Buy as single hangers, or in sets.

Single hanger: **\$9.90**
Sets of 2: **\$18.90**

Visit nahanco.com for details



Visit the entire bridal party - bride, groom, bridesmaids, best man, etc. - and the complete range of options and finishes at nahanco.com. Scan the QR code and go directly to the Wedding Party hangers section.



LINGERIE WOOD HANGERS

Wood lingerie styles with rubber-tipped, no-snap clips are ideal for silky, slim straps. Drop bar with mini-clips for delicate items are ideal for coordinated lingerie sets.



See [page 40](#) for lingerie hangers



LINGERIE PADDED SATIN HANGERS

Satin hangers for intimate apparel. Resell, give away or display. Perfect for monogrammed sets, robes and lingerie.



MODERN HANGING ACCESSORIES

A high-end line of metal hanging accessories perfect for gloves, veils, scarves and shawls. Available in five fabulous finishes.



See [pages 61-62](#) for details



HALF-ROUND HANGERS



ROUND HANGERS



HANG-ALL CLIPS



C-SHAPED HOOKS

BRIDAL & FORMALWEAR



See page 80 for details

MUSLIN GOWN COVERS

Cloth covers w/ button closures.
Available in 62" length /4" gusset & 70" length/10" gusset
from \$35.99 /each



PINNABLE FORMS

High quality, pinnable forms.
See pages 129-132
to view our full line.



GOWN COVERS

Garment bags, specially designed for formalwear, keep items safe, wrinkle and damage free.
Also great for archiving, storage and transportation.

NON WOVEN GOWN COVERS

With large or extra-large gussets, great for ball gowns, mermaid styles and extra long trains.



CRYSTAL CLEAR GUSSETED VINYL GOWN COVERS

Reinforced hanger opening, 10" side gusset, and full-length zipper. 4 gauge vinyl. 54" to 72" long.
from \$56.49 /12 pcs



Gusset detail

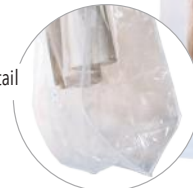

SMOOTH TAFFETA GOWN COVERS

Reinforced hanger opening, 10" side gusset, and full-length zipper. 4 gauge vinyl. 54" to 72" long.
from \$50.49 /12 pcs



See pages 79-80
for details and our
full selection of
garment bags

BRIDAL & FORMALWEAR



Gold & Silver hangers, page 45

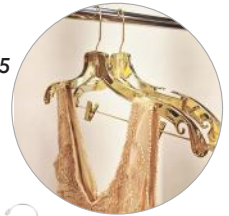

TRADITIONAL PLASTIC HANGERS

17" traditional plastic hangers with deep notches, strap holders and swivel hooks. High quality, durable and long lasting. Made in the USA. See page 48 for more product details.



BRIDAL / FORMAL HANGERS
no washer



EXTRA REINFORCED HANGERS
Chrome hook reinforced with a washer



HEAVY WEIGHT HANGERS
Chrome hook reinforced with a washer



Hook reinforced with a washer



XXX HEAVY WEIGHT HANGERS
Chrome hook reinforced with a washer

ASSORTED BRIDAL/FORMALWEAR BOUTIQUE SUPPLIES



TAILOR SUPPLIES
page 127

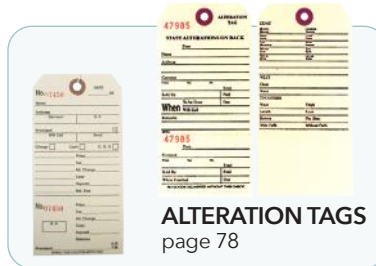

ALTERATION TAGS
page 78



PRICING SUPPLIES
pages 73-78



TRY-ON PANTIES
page 125



TIE/SCARF HANGERS
pages 64 & 66



CLIPS See pages 62-65 for more product details



FITTING CLIPS

PANTS CLIPS

HANG-ALL CLIPS

SHIRT CLIPS



STEAMERS
page 128

Plastic Jacket & Suit **HANGERS**

CONCAVE EXTRA WIDE-SHOULDERED PLASTIC SUIT HANGER

Black textured finish with smooth area for label. Chrome hook; 1 3/8" shoulder; 50/case



H70	79.18	17" wide	17/45
H90	90.23	19" wide	20/48
H110	68.04	21" wide	23/56



H70

CONCAVE PLASTIC SUIT HANGER

Black textured finish with smooth area for label. Chrome hook. 100 /case

H17SQ	78.08	17" wide	21/44
H17RH	78.08	17" wide	21/44
H19RH	83.20	19" wide	22/44



H17SQ

CONCAVE WIDE-SHOULDERED SUIT HANGERS

Textured finish with smooth area for label & locking trouser bar. Chrome hardware. 50 /case

2593	119.38	19" wide; 1 1/2" shoulder	21/48
2563	109.19	18" wide; 1 3/8" shoulder	20/43



2563

CONCAVE WIDE-SHOULDERED SUIT HANGER

Textured finish with smooth area for label. Chrome hook and clear support strap; 50 /case

2393	119.38	19" wide	16/39
2363	109.19	16 1/2" wide	18/43



2393

CONCAVE STURDY SUIT PLASTIC HANGER

Matte finish with locking trouser bar. Chrome hardware. 100 /case

2517RH	129.59	Black	17" wide	28/34
2518	114.36	Black	18" wide	37/48



2517RH

FLAT PLASTIC SUIT HANGER

Non-slip plastic bar and chrome hook; 17" wide; available in Black, White or Clear: 100 /case; 22/34 lbs. **\$59.99**

2700PB	Black
1700PB	White
700 PB	Clear



2700PB

700 PB

1700PB

PANT HANGER w/CUSHION GRIP CLIPS

Black with chrome hook and padded clips. 15 1/4" wide; 100 /case; 15/24 lbs. 2015PC **\$58.49**



2015PC

inside of clip

SUPER STRONG PANT HANGER

For outerwear and jeans. Black hanger with chrome hardware; 14" wide; 100 /case; 22 lbs; 2690EC **\$113.56**



2690EC

HANGERS Plastic Jacket & Outerwear



CONCAVE STURDY PLASTIC JACKET HANGER

Textured finish with smooth area for label.
Round or Square chrome hook; 100/case.

2417RH	67.49	17" Black	20/34
8417RH	67.49	17" Tan	18/28
2418	74.99	18" Black	22/46
8418RH	81.91	18" Tan	22/46
8417SQ	74.99	18" Tan	22/46

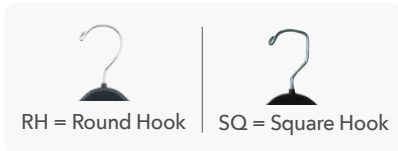

FLAT PLASTIC ACTIVE SPORTS HANGER

Smooth finish with area for label application. Black w/ chrome hook; 18" wide; 20/30 lbs;
100 /case; H1800RH **\$77.99**



CONCAVE WIDE-SHOULDERED JACKET HANGER

Textured finish with smooth area for label. Black w/chrome hook; 50 /case.

2293	86.67	19" wide	16/39
2263	83.27	16½" wide	16/38



CONCAVE WIDE-SHOULDERED JACKET HANGER

Textured finish with smooth area for label. Black w/chrome hook; 50 /case.

2493	82.46	19" wide; 1½" shoulder	14/39
2463	70.31	18" wide; 1¾" shoulder	14/35



PLASTIC CONTOUR JACKET HANGER

Textured finish with smooth area for label.
Black w/black hook; 100 /case.

NHC18	98.66	18" wide	21/40
NHC17	80.84	17" wide	20/39
NHC15	79.22	15" wide	18/28



FLAT ELEGANT SHIRT HANGER

17" wide; chrome hook; available in Ivory or Black: 100 /case; 13/21 lbs. **\$75.49**

NH250	Ivory
BH250	Black



FLAT ELEGANT COORDINATE SUIT HANGER

17" wide w/ notches; chrome hardware; available in Ivory or Black: 100 /case; 29/38 lbs.

BH252	190.51	Black
-------	---------------	-------



FLAT ELEGANT SHIRT/SWEATER HANGER

18½" wide; chrome hook; available in Ivory or Black: 100 /case; 18/31 lbs. **\$104.98**

NH229	Ivory
BH229	Black



FLAT SPORTSMEN'S OUTERWEAR HANGER

Black hanger, black hook, molded grippers; 18¾" wide; 100 /case; 21/32 lbs;
BH350BHM **\$98.82**

Extended Drop & Flocked Velvet **HANGERS**

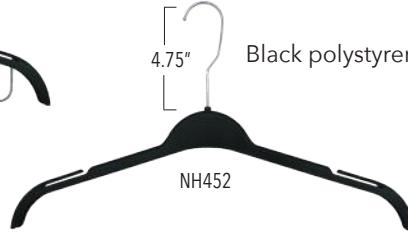

SHIRT/SUIT HANGERS
w/ **STATIONARY HOOK & EXTENDED DROP**

Perfect for Conveyor Systems.
Black polystyrene; 18 3/4" wide; 3" thick; 4 3/4" long hook; 100 /case.

NH450	64.36	Shirt/dress	12/21
NH452	126.86	Suit w/clips	23/29

SLIMLINE FLOCKED HANGER SERIES

Thin 17 3/8" wide, velvet flocked hangers with chrome hooks, often referred to as "huggables"

SHIRT with NOTCHES

HSL17NB	53.99	black	100/case	12/18 lbs
HSL17NP	36.84	pink	50/case	6 lbs

SHIRT NO NOTCHES

HSL17SB	62.99	black	100/case	12/18 lbs
---------	--------------	-------	----------	-----------

SUIT with NOTCHES

HSL17PB	42.49	black	100/case	12/18 lbs
HSL12PB	47.49	11.4" /black	100/case	11/12 lbs

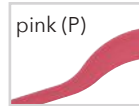

FLOCKED SLIMLINE HANGERS

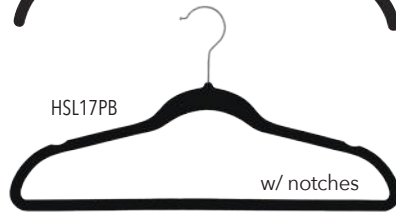
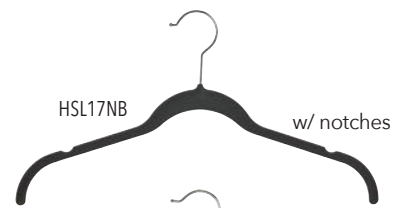

Top Sellers!

add-on CLIPS

Color-coordinated plastic clips for SlimLine Suit Hangers. 2 3/4" high x 1 1/2" wide; 100/case; 4 lbs. **\$21.99**

HSLCLIPB black



HSLCLIPB



SLIMLINE CLIPS

FLAT FLOCKED ELEGANT SHIRT HANGER

Black w/chrome hook; 17" wide w/notches; 12 /case; 12/21 lbs. FNH250 **\$8.99**

While supplies last

FLAT FLOCKED ELEGANT SHIRT/SWEATER HANGER

Black w/chrome hook; 18 1/2" wide; 12 /case; 18/31 lbs. FNH229 **\$10.49**

While supplies last



FLOCKED VELVET HANGERS

HANGERS Display

DISPLAY HANGERS



DISPLAY HANGERS w/ DROP
 White with 8" chrome drop
 Black with 8 or 12" chrome drop
 Pewter with 12" chrome drop



DISPLAY HANGERS - 1 1/2" thick

12 /case; 4" chrome hook; available in black or white

DHWS124W	30.46	12" w; White w/white	4/8
DHBS124B	30.46	12" w; Black w/black	
DHWS15WH12	34.67	15 1/2" w; White w/white	5/12
DHBS15BH12	36.29	15 1/2" w; Black w/black	5/18
DHBS17/4B	39.04	17 1/4" w; Black	6/15
DHWS15CH12	36.29	15 1/2" w; White w/chrome	
DHBS15CH12	34.67	15 1/2" w; Black w/chrome	4/8

DISPLAY HANGERS w/ DROP - 1 1/2" thick

12 /case; available in black or white

WSK8124W	41.47	White: 12" - 8" drop	6/15
BSK8124B	60.75	Black; 12" - 8" drop	
BSK12164B	57.19	Black; 15 1/2" - 12" drop	8/26
BSK12174B	60.75	Black; 17 1/4" - 12" drop	8/30

THINLINE DISPLAY HANGERS

Black w/chrome hardware; 12 /case **\$25.61**

DH4	17" wide; 1" thick	5/9
DH3	17" wide; 1 1/2" thick; 2" drop	7/19

FROSTED & BLACK DISPLAY HANGERS /FLAT

Clear frosted w/brushed chrome hardware or Black with chrome hardware; 100/case.

W004	97.59	15 1/2" w; Clear Frosted	17/21
W004B	75.05	15 1/2" w; Black	
W005	348.80	14" w; Clear Frosted	37
W005B	274.72	14" w; Black	
W006	97.59	17" w; Clear Frosted	18/25
W006B	91.16	17" w; Black	
W006RC	242.51	Clear Frosted	33/40
W006BRC	355.23	Black	

FROSTED & BLACK DISPLAY HANGERS /CONCAVE

Clear frosted w/brushed chrome hardware or Black with chrome hardware; 17" wide; 100/case.

W007	47.35	Clear Frosted	10/22
W007B	38.07	Black	
W007RC	101.46	Clear Frosted	13/28
W007BRC	76.72	Black	



Frosted hangers are available in a range of custom colors, minimum order of 3000 pieces (same color). Call our sales department for more information.



flared end

Wide flared ends give dimension, and deep notches hold straps.



WOOD /METAL STYLES



CONCAVE BODY-SHAPED DISPLAY HANGERS

Wood; 17" wide, 3/4" thick, 1 1/2" flared ends; 12 pcs; 12 lbs

23217BHDISPLAY	Black w/black hardware	130.61
23117WHDISPLAY	White w/white hardware	130.61
23017GHDISPLAY	Natural w/gold hardware	146.86
23017DISPLAY	Natural w/brushed chrome hardware	139.36

FLAT BODY-SHAPED DISPLAY HANGERS



4 finish/metal combinations



Soft grippers for delicate clothing, swimwear/lingerie.

Wood/metal; 17" wide; flat w/soft grippers; 12 pcs; 9 lbs

20217BHDISPLAY	Black w/black hardware	75.61
20117WHDISPLAY	White w/white hardware	75.61
20017GHDISPLAY	Natural w/gold hardware	91.86
20017DISPLAY	Natural w/brushed chrome hardware	84.36

BODY-SHAPED HANGERS

Our curvaceous drop hangers were designed with a woman's body in mind.

All three hanger styles - wire only; hybrid flat wood/wire; and a bulkier hybrid concave wood/wire - are made for both hanging and visual display.

ROUND METAL HANGERS

4mm wire; 14" dia; 12 pieces; 5 lbs.

BCH14	38.83	Chrome
BBH14	38.83	Black
BBH14BR	53.52	Black Rubber

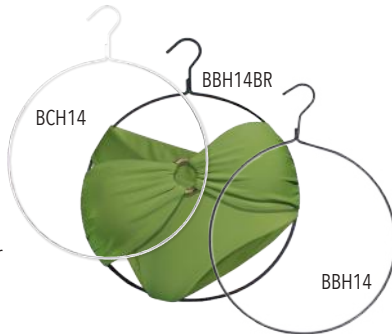

METAL STYLES



4.5mm WIRE BODY-SHAPED HANGERS

Formed with 4.5mm wire; 30" length from crotch to neck; 15" across shoulders; 11" waist; 16" hips; 12 pcs; 10/11 lbs.

BFWC12	Chrome	60.99
BFWB12	Black	56.49
BFWBR12	Black Rubberized	96.59
BFWW12	White	61.49

CHROME METAL BIKINI HANGER

w/2 bars & 4 clips
3.5mm wire; 12" wide;
50 pieces; 34/35 lbs.

BSH12-50
\$168.92



HANGERS Lingerie

WOOD

Wood hangers with fine, rubber-tipped lingerie strap clips.

The drop bar styles feature sliding, mini-clips that are superb for all types of panties, garter belts and other intimate accessories.



BR = Black Rubber non-slip coating

Wooden hanger w/chrome hardware with and without drops; 2 widths available; 100 pcs

11 7/8" w/drop; 16/24 lbs.

NH11	Unfinished beech	157.49
NH11B	Low gloss black	157.49
NH11BR	Black rubber coated w/brushed chrome	178.74

11 7/8" no drop; 16 lbs

NH12	Unfinished beech	132.49
NH12B	Low gloss black	132.49
NH12BR	Black rubber coated w/brushed chrome	144.99

14" w/drop; 27 lbs.

NH13	Unfinished beech	178.74
NH13B	Low gloss black	178.74
NH13BR	Black rubber coated w/brushed chrome	191.24

14" no drop; 18 lbs

NH14	Unfinished beech	144.99
NH14B	Low gloss black	144.99
NH14BR	Black rubber coated w/brushed chrome	157.49

SATIN

Traditional padded satin hangers are constructed with a wood core, padded and wrapped in satin fabric. Chrome posts with rounded heads hold straps. Adjustable clips are great for pairing lingerie sets.

new

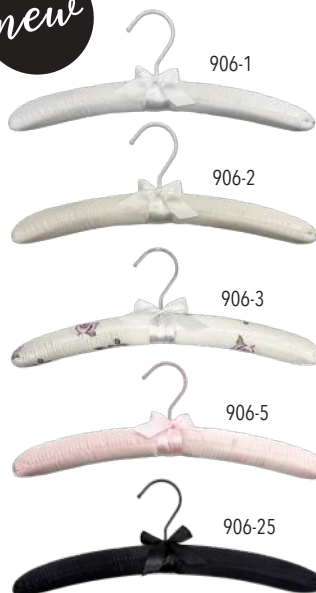

Satin hangers
w/ coordinating metal hook & bow
15" wide; 6 pcs; 2 lbs

906-1	White /white hook	11.99
906-2	Ivory /ivory hook	11.99
906-3	Floral /chrome hook	11.99
906-5	Pink /pink hook	11.99
906-25	Black /black hook	11.99



Black Satin w/ chrome hardware
15 3/4" wide; 100 pcs

40840	w/out drop	164.36	25 lbs
40841	w/ 2" drop	199.42	36 lbs



Ivory Satin w/chrome hardware
15 1/2" wide; 100 pcs

4720425	w/out drop	173.34	25 lbs
4720441	w/ 2" drop	187.27	27/35 lbs



Satin hangers
w/ coordinating hook & bow
While supplies last

15" wide; 6 pcs; 3/15 lbs

806-1	White	13.87
806/2	Ivory	14.64
806-5	Pink	11.79
806-25	Black	13.87
806-99	Plush Tiger w/gold hook	11.99



Body-shaped hangers
are also ideal for displaying lingerie.
See page 39 for details

Lingerie HANGERS

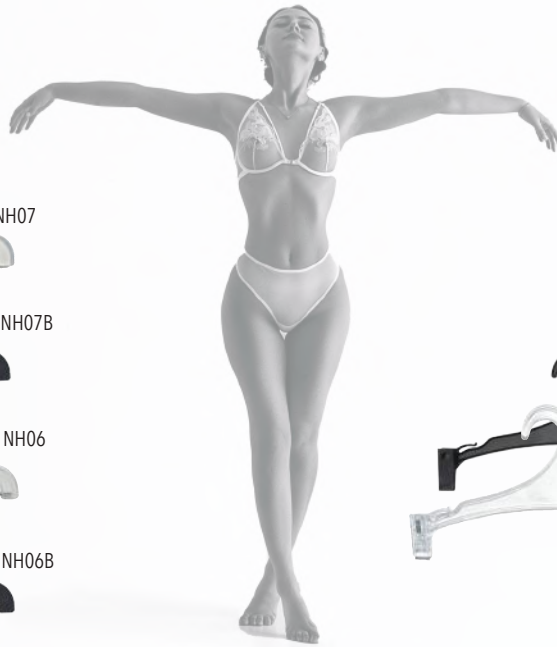

Black plastic hanger w/soft padded clips
12" wide; 200 pieces; 19/31 lbs.
8212 \$91.04



Polystyrene hangers
w/notches & non-slip applied to shoulders
15" wide; 1/4" thick; 100 pieces

Opaque w/brushed chrome hardware
Black w/chrome hardware

TOP hangers; 15 lbs:

black	NH07B	\$79.87
opaque	NH07	\$109.19

SKIRT/PANT hangers; 25 lbs:

black	NH06B	\$151.63
opaque	NH06	\$207.85



Molded polystyrene hangers w/plastic clips
10 1/2" wide; 250 pieces; 17/22 lbs.

Black	NH04B	\$128.30
Opaque	NH04	\$137.05

Molded polystyrene hangers w/oval logo area
12 1/4" wide;
500 pieces; 22/23 lbs.

Black	NH03B	\$128.30
Opaque	NH03	\$137.05



Thin molded polystyrene hangers
10" wide; 1/8" thick; choose from 3 pack sizes



Clear
1000pcs NHGS19 \$91.24
250pcs NHGS19250 \$24.11
100pcs NHGS19100 \$13.74



Clear w/logo area
1000pcs NHGS23 \$107.49
250pcs NHGS23250 \$24.36
100pcs NHGS23100 \$14.99

Grey dip coated metal hanger
w/chrome hook
12" wide; 100 pieces; 12/21 lbs.

NH08 \$116.30

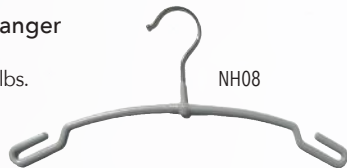

Chrome bottom hanger
w/clear plastic clips and grey tips
11" wide; 100 pieces; 13 lbs.

NH09 \$122.29



Clear economy hanger
10" wide; 1000 pieces; 27/37 lbs.

KM1 \$118.99



Thin molded polystyrene hangers
10" wide; 1/8" thick; choose from 2 pack sizes



Black
1000pcs BNHGS19 \$91.24
100pcs BNHGS19100 \$10.99



Black w/logo area
1000pcs BNHGS23 \$107.49
100pcs BNHGS23100 \$11.99

HANGERS Chrome-Plated Metal

CHROME-PLATED HANGERS

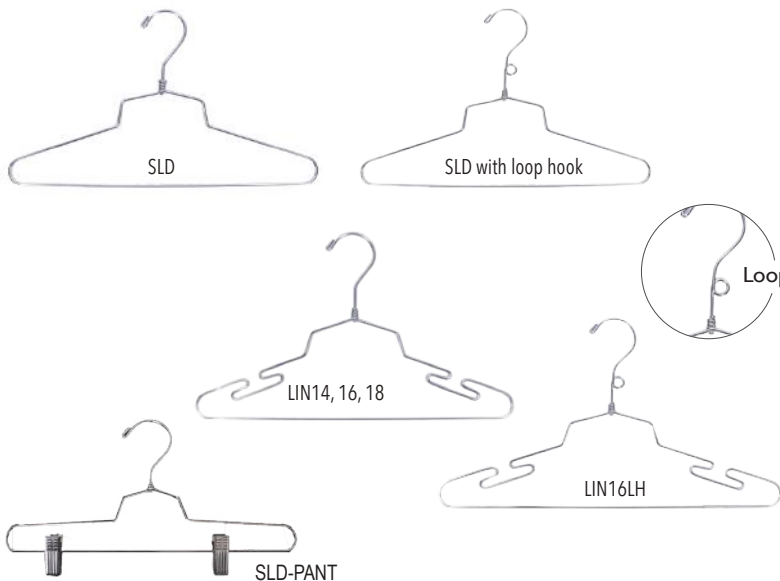

Pictured: 10x SKT12LH w/ DP1410 threaded through the loops



METAL SWIM HANGERS

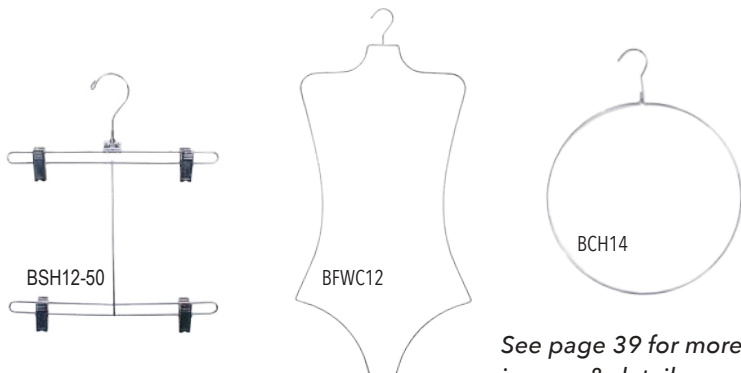

See page 39 for more images & details.

SHIRT/DRESS HANGERS /3.5mm wire gauge

100 /case; select width; standard or loop hook

SLD-12	96.39	12"	standard hook	18
SLD12LH	159.99		loop hook	
SLD-14	110.59	14"	standard hook	20
SLD14LH	151.19		loop hook	
SLD-16	124.29	16"	standard hook	22
SLD16LH	120.39		loop hook	
SLD-18	134.39	18"	standard hook	22
SLD18LH	139.99		loop hook	
SLD-19	139.99	19"	standard hook	24
SLD19LH	178.49		loop hook	

SHIRT/DRESS HANGERS w/notches /3.5mm wire gauge

100 /case; select width

LIN14	167.11	14"	standard hook	22
LIN16	147.69	16"	standard hook	
LIN16LH	151.89	16"	loop hook	24
LIN18	157.31	18"	standard hook	24

PANT/SKIRT HANGERS /3.5mm wire gauge

100 /case

SLD-PANT	186.52	14"	wide	22
SKT12	165.11	12"	wide; standard hook	20
SKT12LH		12"	wide; loop hook	

DIAPER PIN ROD for Loop Hook Hangers

14" wide; 10 pieces; 4 lbs. DP1410 \$17.99

COORDINATE HANGERS /3.5mm wire gauge

100 /case; 16" wide; standard or loop hook; 24lbs. \$219.36

SLC16	Standard hook
SLC16LH	w/ Loop Hook

COORDINATE ATTACHMENT HANGERS /3.5mm wire gauge

100 /case; 14" wide

DSA9	186.52	w/ 9" drop	24
DSA16	165.12	w/ 16" drop	29

CHROME BIKINI HANGERS w/2 bars & 4 clips /3.5mm wire

12" wide; 50 pieces; 34/35 lbs. BSH12-50 \$168.92

BODY SHAPE METAL HANGERS /4.5 mm wire gauge

30" length (crotch to neck); 15" across shoulders; 11" waist; 16" hips; 12 pcs; 10/11 lbs.

BFWC12	60.99	Chrome
BFWB12	56.49	Black
BFWBR12	96.59	Black Rubberized
BFWW12	61.49	White

ROUND METAL HANGERS /4mm wire gauge

14" dia; 12 pieces; 5lbs.

BCH14	38.83	Chrome
BBH14	38.83	Black
BBH14BR	53.52	Black Rubber

Chrome-Plated, Steel & Black HANGERS



BLACK CLAMP Pant Hanger

Chrome with black, rubberized coating;
10" wide; 50/case; 37 lbs; CP200 **\$100.60**

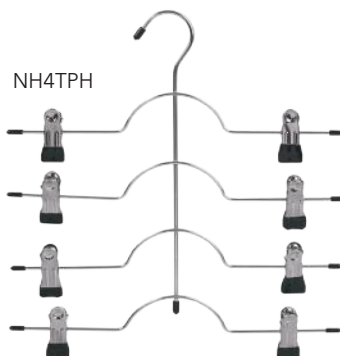

Chrome TIERED Metal Pant Hanger

Four-tiered pant hanger with rubber-tipped clips.
13" w x 15" h; 3/case; 3/6 lbs;
NH4TPH **\$16.72**



S-SHAPE Multilayer Metal Hanger

Lightweight and durable stainless steel w/ clear cap ends.
12" w x 15½" h; 3/case; 3/6 lbs;
NHMLPH **\$11.79**

Chrome-Plated GLOVES & HAT Hangers

Chrome plated; 3.5mm wire gauge; available in 100/case, 27 lbs. OR 12/case, 7 lbs.

- | | | |
|-----------|-----------------|--------------------|
| SLGLOVE | \$175.82 | 10" wide at bottom |
| SLGLOVE12 | \$33.18 | & 11½" high |
| SLHAT | \$192.33 | 9" wide at bottom |
| SLHAT12 | \$33.18 | & 11½" high |

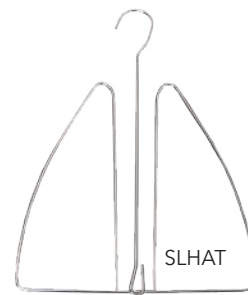

BEDSPREAD, DRAPERY & SLEEPING BAG HANGERS

Heavy-Duty BLACK Metal Hangers

These hangers sell individually, 1/pack.

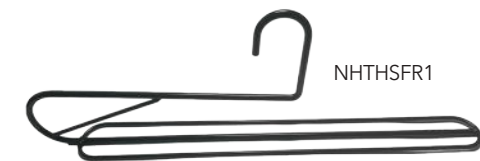

NHTHSFR1

NHTHSFR1 **\$20.87**
25" wide; 4 lbs.



NHTHSFR2

NHTHSFR2 **\$21.51** 31" wide; 8 lbs.



NHTHSHM1

NHTHSHM1 **\$22.29**
23" wide; Hooded mummy sleeping bag hanger; 5 lbs

Chrome-Plated Metal Hangers

These hangers sell 12/pack.



SBD22

SBD22 **\$71.49** 22" wide; 3mm wire gauge 9 lbs

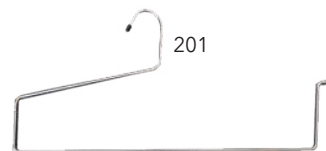

201

201 **\$58.24** 19" wide; 6.5mm wire gauge 9 lbs



201NOTAIL19

201NOTAIL19 **\$66.04** 19" wide; w/rubber sleeve; 9 lbs
8mm wire gauge



HANGERS Aluminum, Gunmetal & Steel

BRUSHED ALUMINUM HANGERS

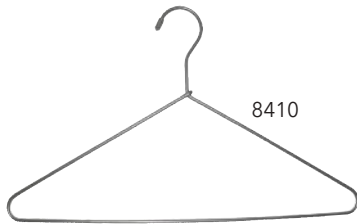

8410

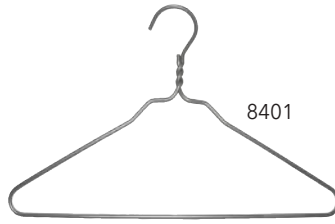

8401

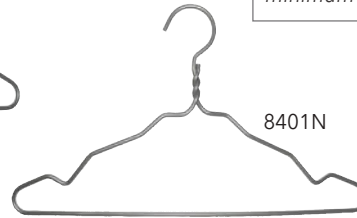

8401N

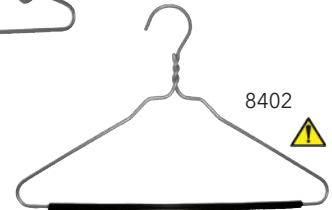

8402



TINTED ALUMINUM

Any of our aluminum hangers can be tinted with a custom pantone shade for an additional \$.03 per piece. There is a 5000 piece minimum for custom tinting.

SHIRT/DRESS Hangers /4mm wire gauge

Brushed aluminum; 100 /case.

8410	157.49	16¼" w/ straight neck	9/15 lbs
8401	209.74	16½" w/ twisted neck	11/16 lbs
8401N	159.90	16½" w/ twisted neck and notches	11/13 lbs
8402	163.79	16½" w/ twisted neck and black rubber sleeve	13/18 lbs

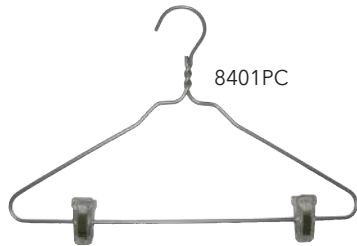

8401PC

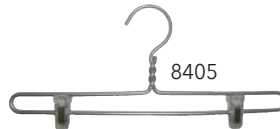

8405

SUIT & PANT/SKIRT Hangers /4mm wire gauge

Brushed aluminum; twisted neck; clear plastic clips; 100 /case.

8401PC	196.69	16½" suit hanger	9/15 lbs
8405	211.39	15" pant hanger	11/16 lbs

GUNMETAL HANGERS

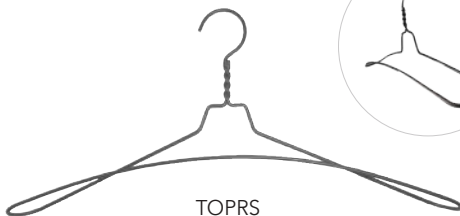

TOPRS



TOPRS /side view

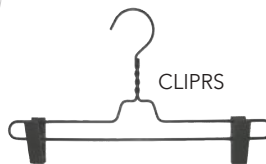

CLIPRS

SHIRT & PANT/SKIRT Hangers /3.5mm wire gauge

Gunmetal finish w/ twisted neck; 100 /case.

TOPRS	208.01	Shirt hanger; 18" w; 1¾" deep	23 lbs
CLIPRS	225.34	Pant hanger w/metal clips; 14" wide	27 lbs

STEEL HANGERS

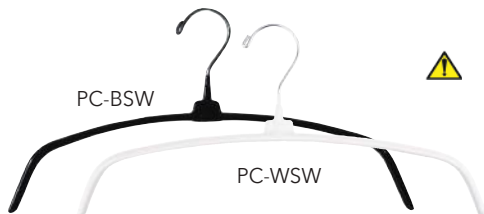

PC-BSW

PC-WSW



NON-SLIP STEEL Shirt Hanger /3.5mm wire gauge

A slim, tempered steel shirt hanger coated with a non-slip rubber. Chrome hook does not swivel; 16" wide; 100/case; 22/24 lbs. **\$100.09**

PC-BSW	Black
PC-WSW	White



2



CHROME-PLATED STEEL Skirt/Pant Hanger /5.4mm wire gauge

Black, vinyl-covered, non-slip bar; 100/case.

2	149.90	12½"	31 lbs
2-16	178.72	16"	38 lbs

Silver & Gold HANGERS



SILVER AND GOLD

A bold hanger collection for eye-catching garment displays. Strong, traditional plastic hangers are coated with gold or silver plating for a shiny alternative to everyday merchandisers.



Silver detail



Gold detail

JUMBO WEIGHT SHIRT HANGERS

17" wide; metallic coated w/notches and notched ends; 100/case; 15/22lbs

- 3405 G **224.53** Gold w/gold hook
- 4405 **208.98** Silver w/silver chrome hook



4405



3405 G

HEAVY WEIGHT COAT HANGER

17" wide; gold metallic coated w/gold hook; 100/case; 20/23lbs **3700G \$173.40**



3700G



4500RC

HEAVY WEIGHT SUIT HANGERS

17" wide; metallic coated w/notches, notched ends metal clips & hooks; 100/case

- 3500RC G **294.68** Gold w/gold hardware 24/29
- 4500RC **241.06** Silver w/silver chrome hardware 25/26



3500RC G

HEAVY WEIGHT SKIRT/PANT HANGERS

14" wide; metallic coated w/notches, notched ends metal clips & hooks; 100/case; 19lbs. **\$235.74**

- 3600RC G Gold w/gold hardware 24/29



3600RC G

HANGERS Plastic Traditional Shirt & Dress

Black plastics

HEAVY WEIGHT SHIRT HANGERS

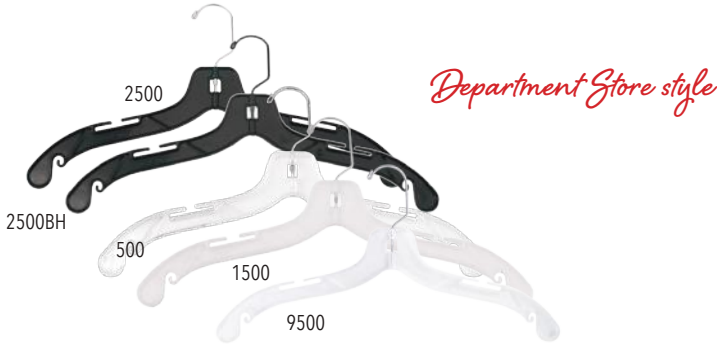

17" wide; 100 /case; 15/22 lbs.		
500	Clear w/chrome hardware	\$32.90
1500	White hi-impact w/chrome hardware	\$32.90
2500	Black w/ chrome hardware	\$32.90
2500BH	Black w/ black hardware	\$35.90
9500	Clear Break Resistant w/chrome	\$66.49
1500APW	White hi-impact w/washer & foam strips	\$58.49

weight is 15/26 lbs:

8500	High Gloss Black w/ chrome hook	\$35.99
8500BH	High Gloss Black w/ black hook	\$35.99



MEDIUM HEAVY WEIGHT SHIRT HANGERS



17" wide; 100 /case; 15/22 lbs.		
505	Clear w/chrome hardware	\$29.90
1505	White hi-impact w/chrome hardware	\$29.90
2505	Black w/ chrome hardware	\$29.90
2505BH	Black w/ black hardware	\$32.90

RECYCLED SHIRT HANGERS



100% RECYCLED PLASTIC; 17" wide; 100 /case; 15/25lbs.

8505	Black w/ chrome hardware	\$19.90
8505BH	Black w/ black hardware	\$21.90

MEDIUM HEAVY WEIGHT SHIRT HANGERS w/molded ridges

17" wide; 100 /case



MEDIUM HEAVY WEIGHT SHIRT HANGERS w/molded rubber grippers



weight is 14/24 lbs:

505R	Clear w/chrome hardware	\$35.49
1505R	White hi-impact w/chrome hardware	\$35.49
2505R	Black w/ chrome hardware	\$35.49

weight is 15/22 lbs:

2505RBH	Black w/ black hardware	\$35.49
---------	-------------------------	----------------

17" wide; 100 /case

505MG	Clear w/chrome hardware	\$36.99	13/13
2505MG	Black w/ chrome hardware	\$36.99	14/22
2505BHMGM	Black w/ black hardware	\$36.99	15/24

Plastic Traditional Shirt & Dress **HANGERS**

MIDDLE WEIGHT SHIRT HANGERS



17" wide; 100 /case; 13/26 lbs.

507	Clear w/chrome hardware	\$28.90
1507	White hi-impact w/chrome hardware	\$28.90
2507	Black w/ chrome hardware	\$28.90
2507BH	Black w/ black hardware	\$31.90

Value Hangers



T-SHIRT WEIGHT SHIRT HANGERS

T-shirt Hangers

17" wide; 100 /case; 12/18 lbs.

1508	Opaque white w/chrome hardware	\$27.90
2508	Black w/ chrome hardware	\$27.90
2508BH	Black w/ black hardware	\$30.90



HEAVY WEIGHT SHIRT HANGERS w/ridges & loop

*with Molded Ridges
& Coordinate Loop*

HEAVY WEIGHT SHIRT HANGERS w/ molded grippers

*with Molded Rubber Grippers
& Coordinate Hole*



17" wide; 100 /case; 13/26 lbs.

95500	Clear break resistant w/chrome	\$38.99
15500	White w/chrome hardware	\$30.49
25500	Black w/ chrome hardware	\$33.49
25500BH	Black w/ black hardware	\$33.99
25500BHMG	Black w/ black hardware & grippers	\$60.61



17" wide; 100 /case, 12/26 lbs

98800	Clear w/chrome hardware	\$36.49
18800	Clear break resistant w/chrome	\$26.99
28800	Black w/ chrome hardware	\$30.49
28800BH	Black w/ black hardware	\$29.99

more sizes on page 54

HANGERS Traditional Gown & Bridal



Bridal & Formal



BRIDAL & FORMAL HANGERS

17" wide; 100 /case; 17/22 lbs.

405	Clear w/chrome hardware	\$39.90
2405	Black w/ chrome hardware	\$39.90
1405	White hi-impact w/chrome hardware	\$39.90
2405BH	Black w/ black hardware	\$42.90

weight is 17/24 lbs:

1405APW	White hi-impact w/chrome & foam strips applied	\$67.49
---------	--	----------------



EXTRA REINFORCED BRIDAL & GOWN HANGERS

Chrome hook reinforced with a washer
17" wide; 100 /case

405WW	Clear w/washer	\$72.74	16/22
1405WW	White hi-impact w/washer	\$72.74	18/22
1405APWW	White hi-impact w/washer & foam strips	\$75.49	18/24

foam strips applied ————— *reinforced w/ washer*



Foam strips = APW | Reinforced w/ a washer = WW

See **page 31** for our selection of **WOOD BRIDAL HANGERS**



Department Store

Black plastics



HEAVY WEIGHT HANGERS

Chrome hook reinforced with a washer
17" wide; 100 /case
\$69.15



Molded Ridges

XXX HEAVY WEIGHT HANGERS

Chrome hook reinforced with a washer
17" wide; 100 /case

300WW	Clear w/washer	\$76.14	20/24
1300WW	White hi-impact w/washer	\$76.14	20/24
2300WW	Black w/washer	\$76.14	19/22



19" HEAVY WEIGHT SHIRT HANGERS

19" wide; 100 /case

900	Clear w/chrome hardware	\$74.99	18/31
1900	White hi-impact w/chrome hardware	\$74.99	18/33
2900	Black w/ chrome hardware	\$74.99	18/33

No Notches

great for sweaters & outerwear



NO-SNAG® HANGERS

17" wide; 100 /case; 19/22 lbs.

905	Clear w/chrome hardware	\$41.99
1905	White hi-impact w/chrome hardware	\$41.99
2905	Black w/ chrome hardware	\$41.99

Traditional Plastic Skirt & Pant HANGERS

14" HEAVY WEIGHT SKIRT/PANT HANGER

14" wide; 100/case; 19lbs.

- 600RC Clear
- 1600RC White hi-impact
- 2600RC Black
- 600PC Clear
- 1600PC White hi-impact
- 2600PC Black

\$49.90

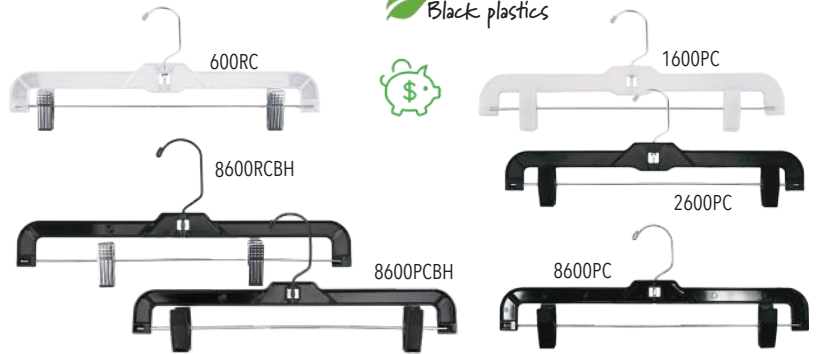

14" wide; 100/case; 19lbs.

- 8600RC Black Hi-gloss (**metal clips**)
- 8600RCBH Black w/Black Hook
- 8600PC Black Hi-gloss (**plastic clips**)
- 8600PCBH Black w/Black Hook

\$52.90

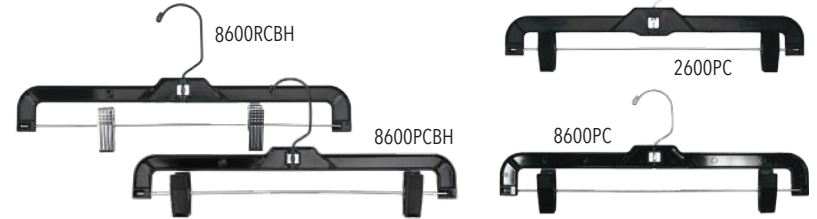

Metal clip (RC)
w/ vinyl insert



Plastic clip (PC)
available in
white or black



14" HEAVY WEIGHT SKIRT/PANT HANGER w/LONG HOOK

14" wide; 100/case; 19lbs.

\$49.90

- 600RCLH Clear
- 1600RCLH White hi-impact
- 2600RCLH Black
- 600PCLH Clear
- 1600PCLH White hi-impact
- 2600PCLH Black
- 2600RCBH Black w/Black Hook
- 2600PCBH Black w/Black Hook



14" JUMBO WEIGHT SKIRT/PANT HANGER

14" wide; 100/case; 20lbs.

\$58.68

- 602RC Clear
- 1602RC White hi-impact
- 2602RC Black
- 602PC Clear
- 1602PC White hi-impact
- 2602PC Black

Standard Hook



Long Hook (LH)



14" JUMBO WEIGHT SKIRT/PANT HANGER w/LONG HOOK

14" wide; 100/case; 20lbs.

\$58.68

- 602RCLH Clear
- 1602RCLH White hi-impact
- 2602RCLH Black
- 602PCLH Clear
- 1602PCLH White hi-impact
- 2602PCLH Black

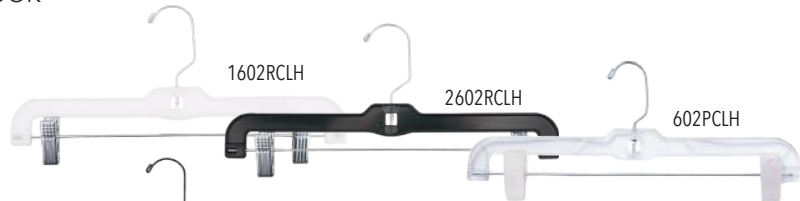

Black w/black hook; 14" wide; 100/case; 20lbs.

\$50.28

- 2602RCBH Black w/Black Hook
- 2602PCBH Black w/Black Hook



14" JUMBO WEIGHT SKIRT/PANT HANGER

Clear; 14" wide; 100/case; 19lbs.

9602RC

\$70.99

9602RC



16" HEAVY WEIGHT SKIRT/PANT HANGER

16" wide; 100/case; 21lbs.

\$72.74

- 616RC Clear
- 1616RC White hi-impact
- 2616RC Black



COORDINATE ATTACHMENT FOR SKIRTS & PANTS

14" wide; 4 1/2" drop; 100/case; 19lbs

\$59.90

- 614RC Clear
- 1614RC White hi-impact
- 2614RC Black
- 614PC Clear
- 1614PC White hi-impact
- 2614PC Black



HANGERS Traditional Plastic



BREAK RESISTANT



GLOSSY BLACK



HEAVY WEIGHT SUIT HANGERS

17" wide; 100/case

500RC	\$62.90	Clear	26/27
1500RC	\$62.90	White hi-impact	26/34
2500RC	\$50.49	Black	26/34
2500RCBH	\$62.90	Black w/ black hook	27/34
500PC	\$62.90	Clear	27/34
1500PC	\$62.90	White hi-impact	27/34
2500PC	\$62.90	Black	27/34
2500PCBH	\$62.90	Black w/ black hook	26/27
9500RC	\$94.99	Clear - Break Resistant	27/34
8500RC	\$74.49	Black Hi-gloss (<i>metal clips</i>)	26/28
8500RCBH	\$79.19	Black w/Black Hook	26/34
8500PC	\$79.49	Black Hi-gloss (<i>plastic clips</i>)	26/28
8500PCBH	\$79.19	Black w/Black Hook	26/34

HEAVY WEIGHT COAT HANGERS

Black plastics



with Long Hook

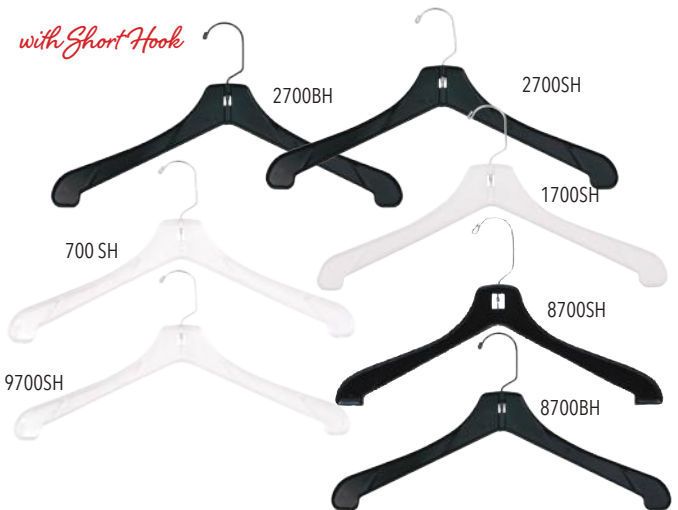

with Short Hook

COAT HANGERS/LONG HOOK

17" wide; 100 /case; 19/26 lbs.

5'13/16" Hanger Length

700	Clear w/chrome hardware	\$43.49
2700	Black w/ chrome hardware	\$44.99
1700	White hi-impact w/chrome hardware	\$44.99
9700	Clear Break Resistant w/chrome hardware	\$85.99
8700LH	Black High Gloss w/ chrome hardware	\$44.99

COAT HANGERS/SHORT HOOK

17" wide; 100 /case; 18/26 lbs.

3'15/16" Hanger Length

2700BH	Black w/ black hardware	\$43.49
2700SH	Black w/chrome hardware	\$43.49
700 SH	Clear w/chrome hardware	\$43.49
1700SH	White hi-impact w/chrome hardware	\$43.49
9700SH	Clear Break Resistant w/chrome hardware	\$84.99
8700SH	Black High Gloss w/ chrome hardware	\$44.99
8700BH	Black Hi-gloss w/ black hardware	\$44.99

IMPRINT SERIES

Great for Imprinting



SHIRT HANGERS 17" wide; 100 /case

RBK1400	\$83.74	Solid White	19/21
RBK2400	\$83.74	Black	

SKIRT/PANT HANGERS 14" wide; 100 /case

RBK1605	\$119.72	Solid White	21
RBK2605	\$117.94	Black	

SHIRT HANGERS 17" wide; 100 /case

9705	\$41.49	Break-resistant CLEAR	23
2705BH	\$46.49	BLACK w/black hook	17/33
2705CH	\$49.99	BLACK	17/33

Plastic Skirt & Pant HANGERS



SNAP GRIP PLASTIC HOOK SKIRT/PANT HANGER

200/case

2681-8	\$81.49	Black	8" w	15
2681-10	\$85.05	Black	10" w	14/19
2681-12	\$90.23	Black	12" w	18/19
1681/8W	\$85.05	White	8" w	11/19
1681/10W	\$90.23	White	10" w	13/18
1681/12W	\$97.20	White	12" w	15/23

SNAP IN SIDE SIZE CLIPS

White w/black imprint; ¼"L x ⅝"H x ¼"W;
1000/case; 2lbs. **\$22.29**

SCXS	size: XS
SCS	size: S
SCM	size: M
SCL	size: L
SCXL	size: XL
SC2XL	size: 2XL



snap in size clip

SIZE CLIPS work with:
P12, P13, P14, P16, B14, 2681-10, 2681-12,
1681/8W, 1681/10W, 1681/12W



PINCH CLIP PLASTIC HOOK SKIRT/PANT HANGER

100/case **\$63.74**

H29B	Black	9 ½" wide	10/15
H29W	White	9 ½" wide	10/15
H211B	Black	11 ½" wide	11/19
H211W	White	11 ½" wide	11/19



SNAP GRIP SWIVEL HOOK SKIRT/PANT HANGER

200/case

1686-8	\$81.49	White	8"	15
1686-10	\$83.27	White	10"	17
1686-12	\$93.64	White	12"	18/19
2686-8	\$40.99	Black	8"	15
2686-10	\$47.99	Black	10"	17
268610BH	\$83.26	Black w/black hook	10"	17
2686-12	\$58.49	Black	12"	18/19



PINCH CLIP SWIVEL HOOK SKIRT/PANT HANGER

100/case **\$67.49**

H39B	Black	9 ½" wide	10/15
H39W	White	9 ½" wide	10/15
H311B	Black	11 ½" wide	11/19
H311W	White	11 ½" wide	11/19



PINCH GRIP SWIVEL HOOK SKIRT/PANT HANGER

200/case

6008	\$50.49	CLEAR	8" w	18/20
6010	\$61.49	CLEAR	10" w	20/22
6012	\$57.49	CLEAR	12" w	23/32
6008B	\$35.99	BLACK	8" w	20
6010B	\$45.99	BLACK	10" w	16/22
6012B	\$48.49	BLACK	12" w	17/26
6014B	\$44.49	BLACK	14" w	21/32

w/ Soft Pad:

6210B	\$51.49	BLACK	10" w	16/22
6212B	\$45.99	BLACK	12" w	17/26
6214B	\$51.49	BLACK	14" w	21/32



Soft pad clip
Great for leather

SKIRT/PANT HANGER w/BLACK HOOK & CLIPS

14" wide; 50/case; 10lbs. **\$55.47**



14" BLACK PLASTIC SKIRT/PANT HANGER

w detachable strap & foam bar; 200/case; 25/34lbs. **\$133.11**

HANGERS Junior Plastic Hangers



Black plastics



SUPER HEAVY WEIGHT SHIRT HANGER

14" wide; 100/case; 11/15lbs.

\$28.99

414	Clear	
1414	White hi-impact	
2414	Black	
2414BH	Black w/Black hook	



SUPER HEAVY WEIGHT SUIT HANGER

14" wide; 100/case

\$59.90

414RC	Clear	20/22
1414RC	White hi-impact	20
2414RC	Black	18
2414RCBH	Black w/Black hook	18/24



Metal clip (RC)
w/ vinyl insert



Plastic clip (PC)
available in
white or black

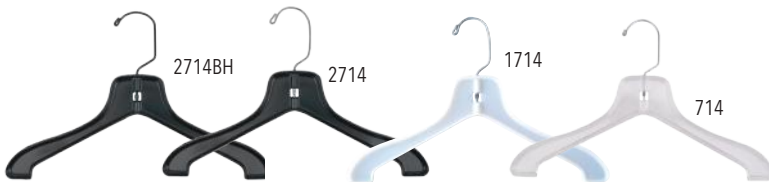

SUPER HEAVY WEIGHT COAT HANGER

14" wide; 100/case; 18/22lbs.

\$44.49

714	Clear	
1714	White hi-impact	
2714	Black	
2714BH	Black w/Black hook	

SUPER HEAVY WEIGHT SKIRT/PANT HANGER

12" wide; 100/case; 18lbs.

\$59.90

with metal clips:

611RC	Clear	
1611RC	White hi-impact	
2611RC	Black	
2611RCBH	Black w/Black hook	

with long hook & metal clips:

611RCLH	Clear	
1611RCLH	White hi-impact	
2611RCLH	Black	

with plastic clips:

611PC	Clear	
1611PC	White hi-impact	
2611PC	Black	
2611PCBH	Black w/Black hook	



COORDINATE ATTACHMENT SKIRT/PANT HANGER

12" wide; 100/case; 19lbs.

\$59.90

with metal clips:

612RC	Clear	
1612RC	White hi-impact	
2612RC	Black	

with plastic clips:

2612PC	Black	
--------	-------	--



Children's Plastic HANGERS

 Black plastics

SUPER HEAVY WEIGHT SHIRT HANGER

12"wide; 100/case; 10lbs.

\$26.99



- 412 Clear
- 1412 White hi-impact
- 2412 Black
- 2412BH Black w/Black hook



with LONG HOOK

12"wide; 100/case; 10/12lbs.

- 412LH \$27.49 Clear
- 1412LH \$26.99 White hi-impact



long hook (LH)

SUPER HEAVY WEIGHT INFANT SHIRT HANGER

10"wide; 200/case; 13lbs.

\$44.99

- 410 Clear
- 1410 White hi-impact
- 2410 Black
- 2410BH Black w/Black hook



Clear; 10"wide; 100/case; 7lbs.

\$23.99

- CP410 Clear

SUPER HEAVY WEIGHT SUIT HANGER

12"wide; 100/case; 19/22lbs.

\$59.90

- 412RC Clear
- 1412RC White hi-impact
- 2412RC Black
- 2412RCBH Black w/Black hook



with LONG HOOK

12"wide; 100/case; 19/22lbs.

\$59.90

- 412RCLH Clear w/Long hook
- 1412RCLH White w/Long hook



long hook (LH)

SUPER HEAVY WEIGHT COAT HANGER

12"wide; 100/case

- | | | | |
|--------|---------|--------------------|-------|
| 712 | \$37.99 | Clear | 14/22 |
| 1712 | \$37.99 | White hi-impact | 14/22 |
| 2712 | \$37.99 | Black | 14/28 |
| 2712BH | \$37.90 | Black w/Black hook | 14/28 |



SUPER HEAVY WEIGHT INFANT SKIRT/PANT HANGER

Metal or plastic clips; Long hook only; 9"wide; 100/case; 16/23lbs

\$74.88

- 610RCLH Clear
- 610PCLH Clear
- 1610RCLH White hi-impact
- 1610PCLH White hi-impact
- 2610RCLH Black
- 2610PCLH Black



HANGERS VICS /Floor-Ready Hangers

NAHANCO works directly with YOUR garment factories.
We can supply any of our hanger styles, giving you control over the hangers that you receive.

For more information and images, please visit nahanco.com



ECONOMY SHIRT HANGER
Black with molded non-slip shoulder
200/case

485B	\$24.99	15"	18/24
484B	\$29.49	17"	15/29
479B	\$36.99	19"	16/36



HEAVY WEIGHT SHIRT HANGER
With molded non-slip shoulder.
17" wide; 100/case; 13/22lbs.

98800	\$36.49	Break-resistant CLEAR
28800	\$30.49	BLACK
28800BH	\$29.99	BLACK w/Black hook
18800	\$26.99	WHITE



SUPER HEAVY WEIGHT SHIRT HANGER
17" wide; 100/case; 14/22lbs

95500	\$38.99	Break-resistant CLEAR
25500	\$33.49	BLACK
25500BH	\$33.99	BLACK w/Black hook
15500	\$30.49	WHITE



SHIRT HANGER With molded non-slip shoulder
Break-resistant clear; 19" wide; 100/case; 13/27lbs

99900	\$54.49
-------	---------



SHIRT HANGER
With molded non-slip shoulder.
15" wide; 100/case; 11/15lbs

94400	\$34.99	Break-resistant CLEAR
24400	\$27.99	BLACK
24400BH	\$32.49	BLACK w/Black hook
14400	\$27.49	WHITE



SHIRT HANGER
With molded non-slip shoulder.
12" wide; 100/case; 8/15lbs

92200	\$36.49	Break-resistant CLEAR
22200	\$37.99	BLACK
22200BH	\$39.49	BLACK w/Black hook
12200	\$26.49	WHITE



SHIRT HANGER
Black w/black hook; 200/case

NHPJ41	\$41.49	16"	15/36
--------	---------	-----	-------



SHIRT HANGER Black; 18½" wide; 200/case; 25/36lbs

2358	\$102.38
------	----------



Heavy Weight Coat Hanger
17" wide; 100/case

2705BH	\$46.49	BLACK w/black hook	17/33
2705CH	\$49.99	BLACK	17/33



Snap Grip Skirt/Pant Hanger 200/case

2686-8	\$40.99	BLACK	8"	15
2686-10	\$47.99	BLACK	10"	17
2686-12	\$83.26	BLACK	12"	18/22



PINCH GRIP SKIRT/PANT HANGER 200/case

w/ Soft Pad:				
6210B	\$51.49	BLACK	10"	16/22
6212B	\$45.99	BLACK	12"	17/26
6214B	\$51.49	BLACK	14"	21/32

6008	\$50.49	CLEAR	8"	18/20
6010	\$61.49	CLEAR	10"	20/22
6012	\$57.99	CLEAR	12"	23/32
6008B	\$35.99	BLACK	8"	20
6010B	\$45.99	BLACK	10"	16/22
6012B	\$48.49	BLACK	12"	17/26
6014B	\$44.49	BLACK	14"	21/32

SIZE MARKERS

Angular VICS size markers. Black with white print. 3/4" wide; 500 pieces/pack; 1 lb. Style VSM \$20.87

Call or see our website for a complete list of VSM size marker options

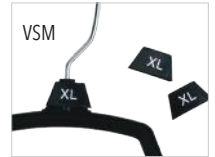

SIZE MARKER REMOVAL TOOL

5 5/8" metal tool removes size markers from hanger. 1/pack; 1 lb. Style VSMT00L \$9.49

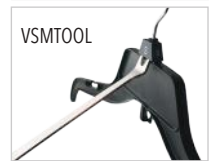

Budget HANGERS

INFANTS ALL PLASTIC HANGER

White; 10" wide; 500/case; 15/21lbs.
1150 \$59.90



SNAP IN SIDE SIZE CLIPS

White w/black imprint; ¼"L x 5/8"H x ¼"W;
1000/case; 2lbs. \$22.29



snap in size clip

SCXS size: XS
SCS size: S
SCM size: M
SCL size: L
SCXL size: XL
SC2XL size: 2XL

SIZE CLIPS work with:
P12, P13, P14, P16, B14, 2681-10,
2681-12, 1681/8W, 1681/10W,
1681/12/W

HIGH-IMPACT PLASTIC SHIRT HANGER

18"w; 500/case \$59.90

1158 White; 29/46lbs.

2158 Black; 30/42lbs.



ONE PIECE SUIT HANGERS

R16WB

white; 16"w; 500/case; 34/70lbs. \$189.00

R16WB250

white; 16"w; 250/case; 18/37lbs. \$92.90



TUBULAR HANGERS

144/case \$44.90

TBB Black 16 3/8" 15/22
TBR Red
TBW White

TBB2 Black 16/41
TBR2 Red 17" 16/41
TBW2 White 16/44



CLIPS FOR TUBULAR HANGERS

White; 100/case; 2 ¼"h; 100/case; 3lbs.

CLIP100 \$30.46



DRY CLEANING HANGERS

NT140

18"w; 14 gauge white wire; 500/case; 28lbs. \$74.99

NT145RS

16"w; 14 gauge wire w/ round, white cardboard;
500/case; 38lbs. \$81.91

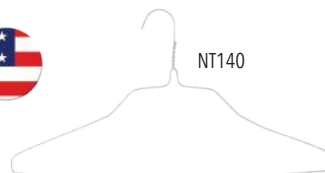

PLASTIC SHIRT/DRESS HANGER

White (P) Black (B)

P12	\$109.19	500	White	12"	16/20
P13	\$63.34	200	White	13 3/4"	11/20
P14	\$125.71	500	White	14"	20/31
B14	\$121.34	500	Black	14"	20/31

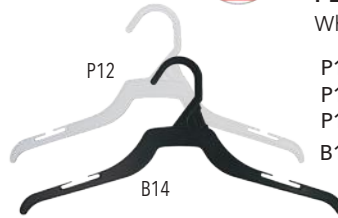

ECONOMY SHIRT HANGER

P18100

White; 18"w; 500/case; 8/9lbs. \$21.24

B18100

Black; 18"w; 500/case; 8/9lbs. \$18.74

SKIRT/PANT HANGER

SK8

White; 8"w; 500/case; 23/27lbs. \$92.88

SK11

White; 11"w; 500/case; 34/70lbs. \$109.68



COORDINATE SKIRT/PANT HANGER

SP8

White; 8"w; 500/case; 28lbs. \$126.99

SP11

White; 11"w; 500/case; 34/70lbs. \$109.68

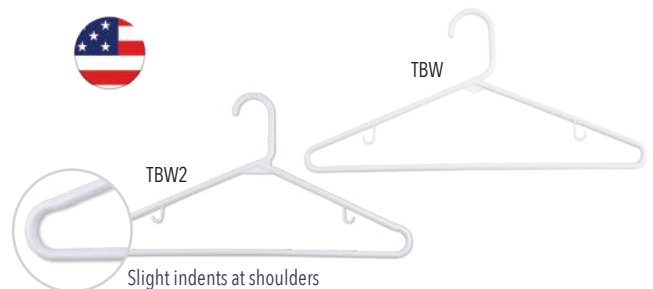

Slight indents at shoulders

SIZE DIVIDERS



We make the majority of our sizing products in the USA



Scan to explore more sizing details and/or visit nahanco.com

ROUND STANDARD

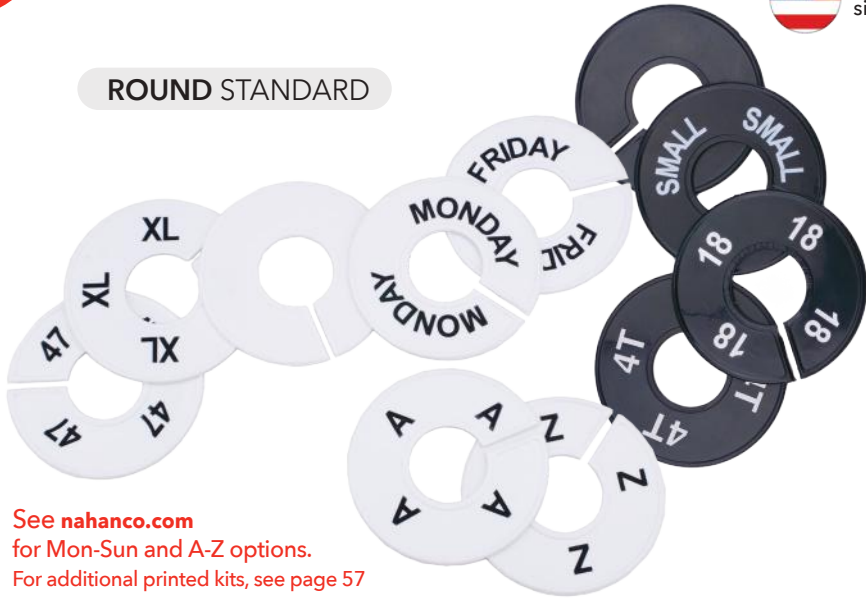

See nahanco.com for Mon-Sun and A-Z options. For additional printed kits, see page 57

3 1/2" outside diameter; 1 3/8" inside diameter; 1/2 lbs.

Imprinted: .35 each
 White w/black: "C"
 Black w/white: "CG"
Imprinted: .35 each
 Black w/silver: CBS
 Black w/white: CBW

Blank: .17 each
 Blank White: CWHIT-BLANK
 Blank Black: CBLK-BLANK

C2WHITE/
C2BLACK



ROUND LARGE INTERIOR

3 1/2" outside diameter; 1 5/8" inside diameter; 1/2 lbs.

Imprinted: .35 each
 White w/black: C2WHITE
 Black w/white: C2BLACK

Blank: .17 each
 Blank White: C2WHITE-BLANK
 Blank Black: C2BLACK-BLANK

CUSTOM

Colors and/or printing available for most styles. Give us a call!



UNIVERSAL

Fits round, square and rectangular hangrails. Choice of sizes or blank. 2"W x 5"H; 1 3/8" inside diameter; 1/2 lbs.

Imprinted: .35 each
 White w/black: QSD-W
 Black w/gold: QSD-B
 Black w/silver: QSDBS
 Black w/white: QSDBW

Blank: .17 each
 Blank White: QSDWHT-BLANK
 Blank Black: QSDBLK-BLANK

QSD



REGULAR

Fits round, square and rectangular hangrails. Choice of sizes or blank. 2 3/4"W x 6 3/4"H; 1 3/8" inside diameter; 1/2 lbs.

.56 each - printed
 White w/black: RSDW
 Black w/white: RSDB

.39 each - blank
 Blank White: RSD-WHITE-BLANK
 Blank Black: RSD-BLACK-BLANK

RSD

Made in China



GRAND

Fits round, square and rectangular hangrails. Choice of sizes or blank. 2 5/8"W x 5 3/4"H; 1 3/8" inside diameter; 1/2 lbs.

.56 each - printed
 White w/black: GSD-W
 Black w/gold: GSD-B

.39 each - blank
 Blank White: GSDWHT-BLANK
 Blank Black: GSDBLK-BLANK

GSD

PRICE **QUOTES** | CUSTOM **COLOR** | CUSTOM **PRINT**



SIZE DIVIDERS

EXTRA LARGE

Fits round, square and rectangular hangrails.
Choice of sizes or blank.
4"W x 7"H; 1 3/8" inside diameter; 1/2 lbs.

.64 each - printed
White w/black: XLRSDW
Black w/gold: XLRSDB
Black w/white: XLRSDBW

.39 each - blank
Blank White: XLRSD-WHITE-BLANK
Blank Black: XLRSD-BLACK-BLANK



QUEEN

Fits round hangrails. Choice of sizes or blank.
3 3/4"W x 9 1/2"H; 1 3/8" inside diameter; 5/6 lbs.
50 pieces per pack

Blank:	Imprinted*:
Blank White: D15 19.44	White w/black: D15I 27.86
Blank Clear: D05 19.44	Clear w/black: D05I 27.86
Blank Black: D25 19.44	Black w/white: D25I 27.86



** Minimum order of 100 pieces (same size) for imprinting*



KING

Slot for inter-changeable sizes. Packed with blank white inserts or specify pre-printed.
3 3/4"W x 10 3/4"H; 1 3/8" inside diameter;
200 pack /21lbs;
100 pack /11lbs.

White:	200	175 "E"	97.90
	100	175E-100	50.54
Clear:	200	75 "E"	97.90
	100	75E-100	50.54
Black:	200	275E	97.90
	100	275E-100	50.54

DELUXE

Works with E1 inserts.
3 3/4"W x 10"H; 1 3/4" inside diameter; 8 lbs.
50 pieces per pack/ **31.49**

White: D120W
Black: D220B

Made in China



Extra Inserts (E1)

Fits Deluxe and King size dividers.
3 1/4"W x 2 1/2"H; 1/2 lbs.
100 pieces per pack

White w/black imprint: "E1" **23.33**
Blank White: E1-BLANK **14.26**



PRICE **QUOTES** | CUSTOM **COLOR** | CUSTOM **PRINT**

SIZE DIVIDERS



PRINTED KITS

Round and Universal dividers. Choose from black, white, or mixed colors.

5 SIZES / XSMALL - XLARGE

Choose Black, White or Color; Round or Universal
 Sizes include: XS, S, M, L, XL



2 PIECES EACH SIZE

BLACK or WHITE 10-Piece Kit; 1 lb; **\$5.05 /kit**

Round / White CWBKIT1
 Round /Black CBWKIT1

Universal / White QSDWBKIT1
 Universal/Black QSDBKIT1

MIXED COLORS 10-Piece Kit; 1 lb; **\$5.83 /kit**

Round CCKIT1
 Universal QSDCKIT1

5 PIECES EACH SIZE

BLACK or WHITE 25-Piece Kit; 1 lb; **\$10.50 /kit**

Round / White CWBKIT2
 Round /Black CBWKIT2

Universal / White QSDWBKIT2
 Universal/Black QSDBKIT2

MIXED COLORS 25-Piece Kit; 1 lb; **\$13.35 /kit**

Round CCKIT2
 Universal QSDCKIT2

8 SIZES / XXSMALL - XXLARGE + BLANK

Choose Black, White or Color; Round or Universal
 Sizes include: XXS, XS, S, M, L, XL, XXL, blank



2 PIECES EACH SIZE

BLACK or WHITE 16-Piece Kit; 1 lb; **\$8.04 /kit**

Round / White CWBKIT3
 Round /Black CBWKIT3

Universal / White QSDWBKIT3
 Universal/Black QSDBKIT3

MIXED COLORS 16-Piece Kit; 1 lb; **\$9.20 /kit**

Round CCKIT3
 Universal QSDCKIT3

5 PIECES EACH SIZE

BLACK or WHITE 40-Piece Kit; 1 lb; **\$16.72 /kit**

Round / White CWBKIT4
 Round /Black CBWKIT4

Universal / White QSDWBKIT4
 Universal/Black QSDBKIT4

MIXED COLORS 40-Piece Kit; 1 lb; **\$19.96 /kit**

Round CCKIT4
 Universal QSDCKIT4

10 SIZES / 3 MONTHS - 4T

Black or White; Universal or Round; Sizes include: 3 Mo, 6 Mo, 9 Mo, 12 Mo, 18 Mo, 24 Mo, 30 Mo, 2T, 3T, 4T



1
PIECE
EACH SIZE

10-Piece Kit; 1 lb; **\$5.05 /kit**

Round / White CWBKIT5
 Round /Black CBWKIT5

Universal / White QSDWBKIT5
 Universal/Black QSDBKIT5

5
PIECES
EACH SIZE

50-Piece Kit; 2 lbs; **\$20.87 /kit**

Round / White CWBKIT6
 Round /Black CBWKIT6

Universal / White QSDWBKIT6
 Universal/Black QSDBKIT6

PRICE **QUOTES** | CUSTOM **COLOR** | CUSTOM **PRINT**

SIZE DIVIDERS



BLANK KITS

Round and Universal dividers. Choose from black, white, or mixed colors. Blank divider kits are available in a range of quantities.

BLACK & WHITE



SET OF 20 Black or White; Round or Universal; 1 lb; **\$4.67 /kit**

Round / White CWHTBLANK20
Round /Black CBLKBLANK20
Universal /White QSDWBLANK20
Universal /Black QSDBBLANK20



SET OF 50 Black or White; Round or Universal; 2 lbs; **\$9.98 /kit**

Round / White CWHTBLANK50
Round /Black CBLKBLANK50
Universal /White QSDWBLANK50
Universal /Black QSDBBLANK50



SET OF 100 Black or White; Round or Universal; 3 lbs; **\$16.72 /kit**

Round / White CWHTBLANK100
Round /Black CBLKBLANK100
Universal /White QSDWBLANK100
Universal /Black QSDBBLANK100

MIXED COLOR KITS



SET OF 5 COLORS

KITS OF 10 /2 each color; Round or Universal; 1 lb; **\$4.15 /kit**

Round CCKIT5
Universal QSDCKIT5



KITS OF 25 /5 each color; Round or Universal; 1 lb; **\$9.98 /kit**

Round CCKIT6
Universal QSDCKIT6



SET OF 8 COLORS

KITS OF 16 /2 each color; Round or Universal; 1 lb; **\$6.74 /kit**

Round CCKIT7
Universal QSDCKIT7



KITS OF 40 /5 each color; Round or Universal; 2 lb; **\$16.72 /kit**

Round CCKIT8
Universal QSDCKIT8

SALE & CLEARANCE KITS



SALE White with red; Round or Universal; 1 lb; **\$10.50 /kit**

Round CWRSALE25
Universal QSDWRSALE25



CLEARANCE Red & white; Round or Universal; 1 lb; **\$10.50 /kit**

Round CWRCLEARANCE25
Universal QSDRCLEARANCE25

BACK ROOM RAIL DIVIDERS



UNIVERSAL ROUND DIVIDER / HEAVY DUTY

5" dia w/ 1 1/2" inside dia.; 1/1 lbs. **\$0.63 /each**

C5B Black
C5R Red
C5W White

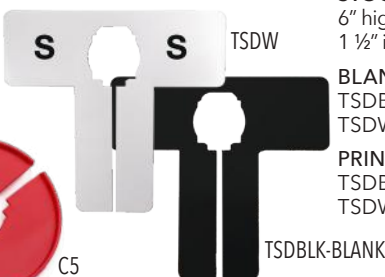

T-SHAPE STOCKROOM DIVIDER
6" high x 6 1/2" wide;
1 1/2" inside dia.; 1/3 lbs.

BLANK \$0.25 /each
TSDBLK-BLANK black
TSDWHT-BLANK white
PRINTED \$0.56 /each
TSDB black
TSDW white



EXTRA-LONG STOCKROOM DIVIDER

Black; 21 1/2" long; 4/7 lbs.
BRDAB **\$20.00 /25 pieces**

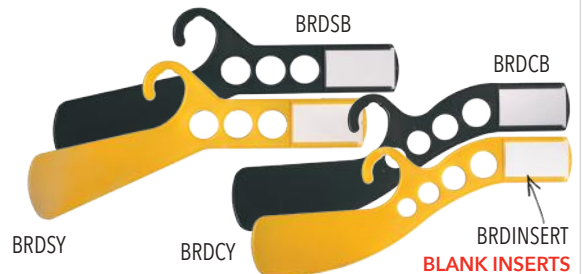

Packs OF 25

Choose Black or Yellow; Straight or Curvy body; 19" long; 4/5 lb.

Black Straight Body BRDSB **\$16.49**
Black Curvy Body BRDCB **\$16.49**
Yellow Straight Body BRDSY **\$16.49**
Yellow Curvy Body BRDCY **\$16.49**

White Blank Inserts

each 3 9/16" x 2 1/8"; 1 lb. 50 pcs/pack BRDINSERT **\$0.25 each**
BRDINSERT50 **\$9.59**

PRICE QUOTES | CUSTOM COLOR | CUSTOM PRINT

SIZE DIVIDERS Size Markers & Labels



PLASTIC SIZE MARKERS

Black/White Size Markers 3/4"



Red/White Size Markers 3/4"



Mini Size Markers 1/2"



Size Marker Remover Tool



snap in size clip



Storage Tray for Size Markers

TRAY

Side Size Clips

SM variations

Please visit nahanco.com for a complete list of all of the imprinted sizes available for our SM lines

SM /SMB /SM25

BLACK or WHITE 3/4" round; 1/2 lbs

SM WHITE w/black print 100 pcs **\$13.74**

SMB BLACK w/white print 100 pcs **\$13.74**

SM25 WHITE w/black print 25 pcs **\$4.15**

SMSALE

RED w/white print 3/4" round; 100 pcs; 1/2 lbs **\$13.74**

MSM

WHITE w/black print 1/2" round; 100 pcs; 1/2 lbs **\$11.15**

VSM /VSMTOOL

VSM BLACK w/white print 500 pcs **\$20.87**

Angular 3/4" markers; 1lb
(pictured on 484B hanger)

VSMTOOL METAL tool removes VSM markers from hanger; 1lb **\$9.49**

SMCOLOR

PLAIN COLOR (specify) 3/4" round; 100 pcs; 1/2 lbs **\$6.87**

COLORS: black, white, violet, brown, green, lt green, dk green, orange, beige, magenta, yellow, lt yellow, blue, dk blue, pink, neon-orange red, dk red, grey
(Actual colors may vary slightly from image)

RBKSM

Specify size 3/4" round; 100 pcs; 1/2 lbs **\$13.74**

SMALL (Red); MEDIUM (Orange); LARGE (Yellow); X-LARGE (Green); XXL (Navy Blue); XXXL (Black)

SC

WHITE w/black print 1/4" l x 5/8" h x 1/4" w; 1000 pcs; 2 lbs **\$22.29**

Specify size: sx (SCXS); s (SCS); m (SCM); l (SCL); xl (SCXL); xxl (SCXXL)

(works with hangers P12, P13, P14, P16, B14, 2681-10, 2681-12, 1681/8W, 1681/10W, 1681/12W)

TRAY

14 x 8 1/2 x 2"; 2/6 lbs **\$18.01 /each**

Clear heavy duty tray w/ locking clasps; Adjusts to up to 24 compartments

SIZING LABELS



DSM



DSM HEM /INSEAM LABELS **Custom available**

BLACK print on white background

1 1/4" w x 5" h; 250 pcs; 1/2 lbs **\$5.44**

Please visit nahanco.com for a complete list of available sizes

CLEAR ACETATE LABELS

CLEAR ROUND LABEL

w/Black Print

1/2" w; 1000 pcs; 1 lb **\$7.00**

IMPRINTS

LBXS	XS
LBS	S
LBM	M
LBL	L
LBXL	XL
LBXXL	XXL
LB1X	1X
LB2X	2X
LB3X	3X



PRICE QUOTES | CUSTOM COLOR | CUSTOM PRINT

Modern Accessories **HANGING SOLUTIONS**

MODERN ACCESSORIES

Our high-end line of metal hanging accessories
Available in multiple finishes

See page 62 for more details



Round hangers



Hang-all clips

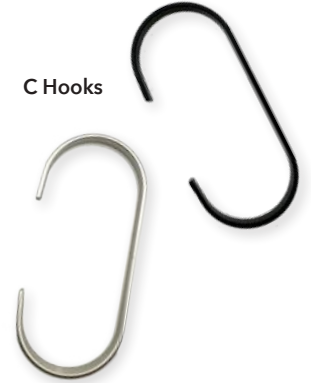

C Hooks

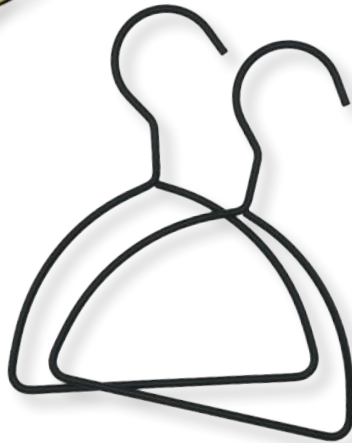

Half-round hangers



Peg hook clips



Hanger connectors



Universal ring clips

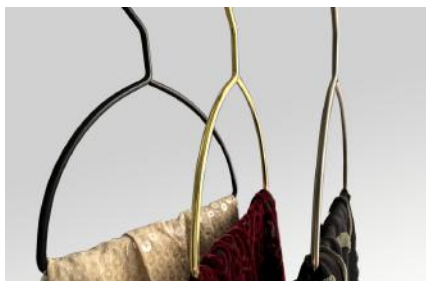

new



HANGING SOLUTIONS Modern Accessories

MODERN ACCESSORIES - the Collection



HALF-ROUND ACCESSORY HANGERS

Metal accessory hangers in 5 finishes with a fixed cut end hook. Dims: 7" (height), 5.9" Diameter (holder), 4mm wire; packs of 100 (19 lbs) or 10-(3 lbs) pieces:

AHLHMB	Matte black	100	\$87.49
AHLHMB10	Matte black	10	\$11.19
AHLHMC	Brushed chrome	100	\$115.49
AHLHMC10	Brushed chrome	10	\$14.69
AHLHMW	Matte white	100	\$87.49
AHLHMW10	Matte white	10	\$11.19
AHLHMC	Chrome	100	\$87.49
AHLHMC10	Chrome	10	\$11.19
AHLHMG	Shiny gold	100	\$126.69
AHLHMG10	Shiny gold	10	\$16.09



ROUND ACCESSORY HANGERS

Metal accessory hangers in 5 finishes with a 360° swiveling ball end hook. Dims: 9.5" (height), 5.9"; diameter (holder) 4 mm wire; packs of 100 (19 lbs) or 10-(3 lbs) pieces:

AHLFMB	Matte black	100	\$135.79
AHLFMB10	Matte black	10	\$17.49
AHLFMC	Brushed chrome	100	\$167.29
AHLFMC10	Brushed chrome	10	\$20.99
AHLFMW	Matte white	100	\$135.79
AHLFMW10	Matte white	10	\$17.49
AHLFMC	Chrome	100	\$135.79
AHLFMC10	Chrome	10	\$17.49
AHLFMG	Shiny gold	100	\$183.39
AHLFMG10	Shiny gold	10	\$23.09



C-SHAPED ACCESSORY HOOKS

Metal accessory hooks in 5 finishes. Dims: 4.3" (top to bottom), 0.32" wide; packs of 100 (9 lbs) or 10 (2 lbs) pieces.

CMHB	Matte black	100	\$57.39
CMHB10	Matte black	10	\$8.39
CMHBC	Brushed chrome	100	\$65.79
CMHBC10	Brushed chrome	10	\$8.39
CMHW	Matte white	100	\$57.39
CMHW10	Matte white	10	\$7.69
CMHCH	Chrome	100	\$57.39
CMHCH10	Chrome	10	\$7.69
CMHBG	Shiny gold	100	\$65.79
CMHBG10	Shiny gold	10	\$8.39



HANG-ALL CLIPS

Metal accessory clips in 5 finishes with a 360° rubber-tipped swiveling hook. Dims: 6" (top to bottom), 2.5" H Euroclip; packs of 100 (10 lbs) or 10 (1 lb) pieces.

610LESB	Matte black	100	\$79.90
610LESB10	Matte black	10	\$13.99
610LESBC	Brushed chrome	100	\$139.29
610LESBC10	Brushed chrome	10	\$17.49
610LESW	Matte white	100	\$111.99
610LESW10	Matte white	10	\$13.99
610LESC	Chrome	100	\$111.99
610LESC10	Chrome	10	\$13.99
610LESG	Shiny gold	100	\$159.59
610LESG10	Shiny gold	10	\$20.29

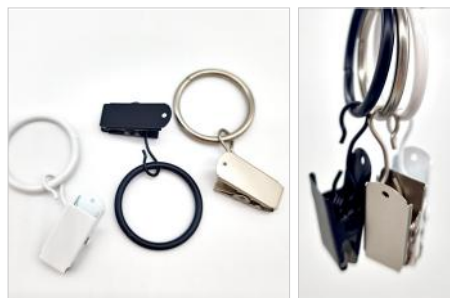

UNIVERSAL ACCESSORY CLIPS

Metal accessory clips with padded mini clip in 3 finishes. Dims: 2.5" hang length, 1" ring diameter; packs of 50 or 20 pieces; 1 lb.

UACBLK50	Matte black	50	\$51.79
UACBLK20	Matte black	20	\$16.79
UACBC50	Brushed chrome	50	\$51.79
UACBC20	Brushed chrome	20	\$16.79
UACWHT50	Matte white	50	\$51.79
UACWHT20	Matte white	20	\$16.79



PEG HOOK ACCESSORY CLIPS

Metal accessory clip with padded mini clip in 3 finishes. Dims: 1.25" hang length; packs of 50 or 20 pieces; 1 lb.

PHCBLK50	Matte black	50	\$51.79
PHCBLK20	Matte black	20	\$16.79
PHCBC50	Brushed chrome	50	\$51.79
PHCBC20	Brushed chrome	20	\$16.79
PHCWHT50	Matte white	50	\$51.79
PHCWHT20	Matte white	20	\$16.79



METAL HANGER CONNECTORS



Metal hanger connectors in 5 finishes. Dims: 1.25" hang length; packs of 50 pieces; 1 lb.

HCMBL	Matte black	50	\$9.99
HCMBBC	Brushed chrome	50	\$9.99
HCMCH	Chrome	50	\$9.99
HCMG	Shiny gold	50	\$10.99
HCMGM	Gunmetal	50	\$10.99

HANGING SOLUTIONS

JEAN HOOKS



4" HOOKS

SHKSM	Zinc	\$23.90
SHKSMRS	Gunmetal	\$43.73
SHKSMBC	Satin Chrome	\$43.73
SHKSMW	White	\$37.01
SHKSMB	Black	\$37.01

Metal jean hooks in 5 finishes.
 Dims: 4" from top to bottom,
 1 3/4" opening; sold in packs of 50;
 3 1/4 lbs. Also sold individually
 and in packs of 12.
 See nahanco.com for details.



7" HOOKS

SHKLG	Zinc	\$12.90
SHKLGRS	Gunmetal	\$19.41
SHKLGBC	Satin Chrome	\$19.41
SHKLGW	White	\$13.61
SHKLG B	Black	\$13.61

Metal jean hooks in 5 finishes.
 Dims: 7" from top to
 bottom, 1 3/4" opening;
 sold in packs of 12; 2 lbs.
 Also sold individually.
 See nahanco.com for details.



HANG-ALL CLIPS

Hang-all clips with metal hang hook. Available in six styles. 4.5" in length; sell in packs of 100; 6 7/16 lbs.



610ECS \$79.90
Brushed Chrome



610 \$46.06
Chrome



610W \$41.13
White



610EC \$75.84
Brushed Chrome



610B \$41.13
Black



610BBH \$46.82
Black w/black hook



HANGING SOLUTIONS

MINI WOODEN HANGERS



High quality wooden mini hangers in 6 and 8" widths. Great for doll clothes and accessories. Also works with pet clothes and accessories. Natural w/chrome hardware: 100 pcs/carton;



Can be imprinted for an additional charge. Contact us via phone, email or chat for details.

Without clips:

MINI6	6" wide	5lbs	\$77.99
MINI8	8" wide	10lbs	\$81.49

With clips:

MINI6RC	6" wide	9lbs	\$103.49
MINI8RC	8" wide	14lbs	\$113.49



See page 24 for pet themed mini hangers.

MINI RUBBERIZED HANGERS



Mini metal hangers in two widths are perfect for hanging/displaying leggings or ties. They feature a gunmetal finish with a black rubber coating along the hanger bar to prevent slippage. Hook measures 1 1/4" in diameter. 100 pcs/carton;

2MINI	4 3/4" wide x 3 3/4" high	6lbs	\$69.99
7MINI	8" wide x 4 1/4" high	8lbs	\$78.41

TIE / LEGGINGS / SCARF HANGERS



Black plastic hanger with black metal swivel hook. Ideal for hanging leggings, scarves.

25430005 11.5" wide; 50 pcs/pack; 5/9 lbs.; **\$39.85**



All black plastic hanger for hanging leggings and scarves, with a hook that measures approximately 0.9.

305078048 7" wide; 100 pcs/pack; 2/3 lbs.; **\$29.32**

BACK ROOM HOOKS



Heavy duty black, space-saving, plastic hook with attached nylon loop strap for hanger management; black.

100 pcs/carton:

GHB100	7"L; 8 lbs.;	\$74.52
GHB200	5 1/2"L; 7 lbs.;	\$74.52

12 pcs/carton:

GHB10012	7"L; 1 lb.;	\$14.56
-----------------	-------------	----------------

Clips HANGING SOLUTIONS

style #	\$	qty	description	size	wgt
610PB	30.46	100	Black	3 1/4"	2/6
HC101	35.64	100	Black	2"	3
HC100	35.64	100	White	2"	3
FITTING CLIPS	28.51	100	White	2"	3
FITTING CLIPS 12	8.29	12	White	2"	1
FITTING CLIP BC	99.97	100	Brushed chrome	2 3/8"	4
FITTING CLIP BC-12	14.70	12	Brushed chrome	2 3/8"	1
GIANT FITTING CLIP	34.73	50	White	4"	3
CC2W	22.38	100	White	2"	1/3
CC2B	22.38	100	Black	2"	1/3
CC2C	26.89	100	Clear	2"	1/3
RCW	59.62	500	White		4/6
RCW100	21.51	100	White		1/2
RCB	34.73	500	Black	2"	4/7
RCB100	8.42	100	Black		1/3
PCC	41.47	500	Clear	1 1/2"	3
PCC100	13.73	100	Clear	1 1/2"	1/3
PCB	38.75	500	Black - Pant Strut Clip	1 3/8" L x 3/8" W	2/2
PCB100	12.44	100			2/2
PCW	22.29	500	White - Pant Strut Clip	1 3/8" L x 3/8" W	2/2
PCW100	7.00	100			2/2
TIE BK	8.75	100	White	1 1/2" / 2 1/4" elast.	1
LONG	6.97	500	Clear	1 1/2"	1/3
LONGWHITE	8.42	500	White	1 7/16"	2/2
LONGWHITE100	4.15	100	White	1 7/16"	2/2
LJC200	5.18	200	Clear	2"	1/1
SHCLIP	13.22	500	White - Triangle Shape Shirt Clip	1 1/4" L x 5/8" W x 1/4" H	2/2
SHCLIP100	4.92	100			2/2
CLIP100	30.46	100	White	2 1/4" thick	3

CLOTHING CLIPS

HANG ALL CLIP

610PB



HERCULES CLIP

HC101/
HC100



FITTING CLIPS

FITTING CLIP



FITTING CLIP BC



GIANT FITTING CLIP

CLEVER CLIPS



CC2W



CC2B



CC2C

RING CLIPS

RCW



RCB



PANTS CLIPS

PCC / PCC100



PCB /
PCB100



PCW /
PCW100

SHIRT CLIPS

TIE BACK CLIP

TIE BK



LONG CLIPS

LONG

LONGWHITE



ALLIGATOR SHIRT CLIP

LJC200



TRIANGLE SHIRT CLIP

SHCLIP /
SHCLIP100



CLIP100



TUBULAR HANGER CLIP

Clip snaps on to any of our tubular hangers.

See page 55 for tubular hangers



HANGING SOLUTIONS Accessory Hangers

SCARF & ACCESSORIES RINGS /HANGERS



NHMSH25



CIR

CIR3100



1227-04

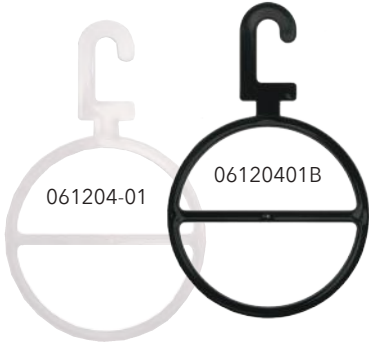

061204-01

06120401B



1227-05

1227-07



DISPLAYRING

DISPLAY-IT HOOKS



DH-WH

DH



6C1

SOCK HANGERS



SH1



SH2

TIE HANGER



TC

BELT HANGER

BC



SNAP HANGER

SNB

style #	\$	qty	description	size	wgt
NHMSH25	29.21	25	Flocked Chrome	3 3/4"H x 3"W 1/4" thick	4
CIR1M	50.38	1000	Clear	1 1/4" inside dia.	5/6
CIR	28.67	500			3
CIR100	10.04	100			1/2
CIR3100	24.30	100	Clear	2 1/2" inside dia.	4
1227-04	6.99		Black	3 1/8"H x 3 5/8"W	2/6
1227-05	3.49	100	Black	3 1/2"H x 1 5/8"W	2
1227-07	4.99		Black	2 3/4"H x 1 3/4" dia.	1/2
061204-01	20.90	100	Natural	6 3/8"H x 4 1/8" dia.	3/7
06120401B	20.90		Black		
DISPLAYRING	61.56	100	Chrome	2 1/4" dia.	3
DH	17.49	1000	Black	1 3/4" h	2/3
DH-WH	18.74	1000	White	1 3/4" h	2/3
DH500	11.86	500	Black	1 3/4" h	1/3
DHWH500	11.86	500	White	1 3/4" h	1/3
6C1	30.46	500	Black	2 3/4" h, 1" dia. ring	3
6C1-100	12.15	100			1
SH1	22.49	500	Black	3 1/2" 3 1/2"	2
SH1-100	7.49	100			1/2
SH2	21.80	500	Black	3 7/8" 3 7/8"	3
SH2-100	7.49	100			1/2
TC	30.46	500	Black	2 7/8"	6
TC100	7.94	100			2/3
BC	52.00	500	Black	open 5"	4
BC100	13.77	100			1
SNB-100	15.36	100	Black 2.5" x 2.5" when snapped shut	open 5"	2/3

HANGING SOLUTIONS

NON-SLIP ATTACHMENTS

Adhesive Gripper

Black or white adhesive gripper with a raised dotted surface; 3 1/4" long

BNT	1000 /case; 5 lbs.	\$80.99
BNT200	200 /case; 2 lbs.	\$25.99
WNT200	200 /case; 2 lbs.	\$25.99

Slim Adhesive Gripper

Black or clear adhesive gripper with a raised textured surface; 2 3/8" long x 3/16" wide

SBNT	1000 /case; 5 lbs.	\$51.99
SBNT200	200 /case; 2 lbs.	\$11.45
SCNT	1000 /case; 5 lbs.	\$51.99
SCNT200	200 /case; 2 lbs.	\$11.45

Adhesive Foam Non-slip Attachments

Black or White; 3 1/2" long or 2 1/4" long

regular	FG1000B	Black; 1000 /case; 2/3 lbs.	\$29.90
	FG1000W	White; 1000 /case; 2/3 lbs.	\$29.90
slim	FGSL1000B	Black; 1000 /case; 2/3 lbs.	\$55.46
	FGSL1000W	White; 1000 /case; 2/3 lbs.	\$55.46

Adhesive Foam Strips

Adhesive backed foam strips; 3/8" w x 4" l; White or Grey; Choose AP and add this cost to the price of any 100-hanger carton to have the non-slip applied

FP2W	White; 200 /case; 1/2 lbs.	\$9.72
FP7W	White; 1600 /case; 2/8 lbs.	\$41.60
FP2	Grey; 200 /case; 1/2 lbs.	\$8.29
FP-7	Grey; 1600 /case; 2/8 lbs.	\$27.73
AP	Specify color; 100 pairs.	\$27.73

Hanger Grips - Straight w/ Fins

Non-Slip Long Adhesive Grips; these flexible rubber grips are feathered with adhesive backing; 4" long x 3/8" wide

NSLONG	Natural; 1000 /case; 4 lbs.	\$70.76
NSLONG100	Natural; 100 /case; 1/2 lbs.	\$9.72
BNSLONG	Black; 1000 /case; 4 lbs.	\$70.76
BNSLONG100	Black; 100 /case; 1/2 lbs.	\$9.72

Rubber Non-slip Hanger Attachments

Grippers that fit over notched, plastic hanger arms without adhesives; 4" long; black or natural; available in packs of 1000 and 200

NS	Natural; 1000 /case; 7 lbs.	\$57.99
NS2	Natural; 200 /case; 2 lbs.	\$16.49
BNS	Black; 1000 /case; 7 lbs.	\$57.99
BNS2	Black; 200 /case; 2 lbs.	\$16.49



Stretch Foam Covers

White (w) and grey (c); 17" w; in packs of 500 and 100

2045W	White; 500 /case; 4/14 lbs.	\$42.12
2045C	Grey; 500 /case; 4/14 lbs.	\$42.12
2041W	White; 100 /case; 2/8 lbs.	\$9.72
2041C	Grey; 100 /case; 2/8 lbs.	\$9.72

Round Rubber Gripper

Available in Natural or Black; gripper stretches over end of most hanger styles and stays put without adhesive; 1" d

NSROUND	Natural; 100 /case; 1/2 lb.	\$15.29
BNSROUND	Black; 100 /case; 1/2 lb.	\$15.29

HANGING SOLUTIONS

HANGER CONNECTORS



PB /
BPB



Piggy Back Connectors

Plastic connector strips; natural & black; 10" (4 slots) & 2 1/2" (1 slot) lengths; 100 & 500 piece quantities;

Natural; 2 1/2":

PB 500 pcs; 2 lbs.; **\$34.73**

PB100 100 pcs; 1 lb.; **\$9.72**

Natural; 10":

PB10 500 pcs; 5/8 lbs; **\$99.79**

PB10-100 100 pcs; 2 lbs; **\$27.34**

Black; 10":

BPB-10 500 pcs; 5/8 lbs; **\$34.73**

BPB10-100 100 pcs; 2 lbs; **\$9.72**

PB10 /
BPB-10

PB8 BPB8



BPB1606

PB16 BPB16



Coordinate Strips

Display hanger strips; 50 pieces;

With 5 slots; 8"L x 1"W:

PB8 Clear; 1 lb.; **\$15.71**

BPB8 Black; 1 lb.; **\$15.71**

With 11 slots; 16"L x 1"W:

PB16 Clear; 2 lbs.; **\$33.86**

BPB16 Black; 2 lbs; **\$24.88**

BPB1606 Black heavy weight; 2 lbs.; **\$27.86**



NHHIPB



HC001

Clear, flexible connectors; 2 5/8" L x 1 5/8" W; 1000 pieces; 3 lbs; **NHHIPB \$39.99**



NHHIPB



HC001B

Plastic connectors; 1 3/4"; 1000 pieces; 3/4 lbs; **HC001 Natural \$52.00**
HC001B Black \$43.42



See our new metal hanger connectors pages 61-62

METAL HANGER CONNECTORS



PRESSURE SENSITIVE PACKAGE HANG TABS



PS1



PS2

HOOK STYLE

1 5/8"H x 1"W pre-cut hang tabs with adhesive strip; clear:

PS1 500 pcs; 1 lb; **\$34.73**

PS1100 100 pcs; 1 lb; **\$13.86**

WIDE, DELTA HOLE STYLE

The delta hole fits almost any style hook; plastic material with a clear adhesive backing; .015" thick; tab measures 1 5/8"W x 1 1/4"H; clear:

PS2 500 pcs; 1 lb; **\$26.43**

PS2100 100 pcs; 1 lb; **\$9.59**



NHH3

ECONOMY - ROUND STYLE

1 3/16" x 1 1/2" economy round hole hang tab with adhesive strip; clear:

NHH3 500 pcs; 1 lb; **\$11.99**



NHH1C



NHH4C

ECONOMY - HOOK STYLE

1 1/2" x 1 11/16" economy hook hang tab with adhesive strip; clear:

NHH1C 500 pcs; 1 lb; **\$19.49**

ECONOMY - DELTA HOLE STYLE

1 7/16"H x 1 5/8"W delta hole hang tab, wide with adhesive strip; clear:

NHH4C 500 pcs; 1 lb; **\$17.99**

Reachers, Boxes & Bins **BACKROOM**

style #	\$	qty	description	size	wgt
RH1MP	16.66	1	Chrome w/ wood handle 2 pieces, easy assembly	54" L	2/4
RH2	21.69	1	Chrome w/ wood handle 4 pieces, assembly required	70" L	2/3
RH3	25.89	1	Chrome w/ wood handle 5 pieces, assembly required	84" L	2/3
ARH	19.41	1	Aluminum w/ plastic tip -adjustable-	24" - 60" L	1/4
48S	38.75	1	Chrome	47 1/2" L	2/16
MBR	37.45	1	Wood w/ metal end	60" L	3/7



CHH-2	39.90	12	Cardboard holds 17" dress hangers	17½ x 5½ x 23	18/21
CHH-2 WHITE	68.30	12	White cardboard holds 17" dress hangers	17½ x 5½ x 23	18/21
CHH-3 WHITE	27.25	12	White cardboard holds 14" skirt/slack hangers	14½ x 3 x 23	14/16
H H	104.00	1	Black break resistant plastic	17½ x 6½ x 23	8/22

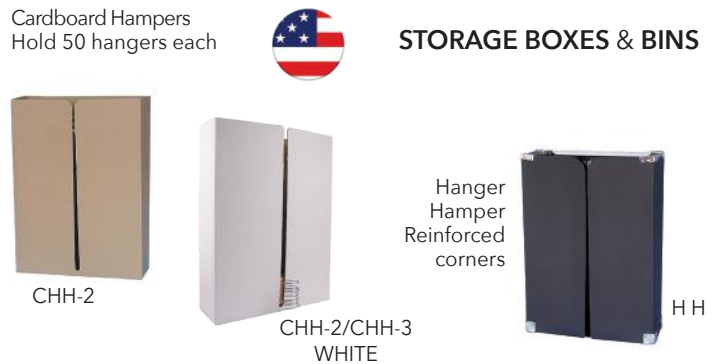

BB100	74.88	1	Black corrugated plastic w/ removable divider	Assembled: 22 x 21½ x 13 Collapsed: 22 x 21½ x 3	7/23
-------	-------	---	---	---	------



BACKROOM Hanger Racks & Stackers

HANGER COLLECTION RACKS



6-BAR HANGER RACK
Hang bars included



NH6CR

style #	\$	qty	description	size	wgt
NH6CR	158.99	1	Metal 6 Bar Rack w/ casters; rack is not adjustable	22½" w x 18" d x 51¼" h Bars evenly spaced at 8" apart	19

MOBILE COLLECTION RACK 24" SYSTEM *(takes IHB2400 bars - see below)*

8 bar capacity

CFR6024M4	287.06	1	bars sold separately	20d x	27/48
CFR6024M4WB	429.88		includes 8 (24") bars	26 3/8w x 66 3/8 h	34/48

6 bar capacity

CFR5024M4	241.32	1	bars sold separately	18d x	20/42
CFR5024M4WB	352.25		includes 6 (24") bars	26¼w x 55 h	25/42



CFR6024M4
CFR6024M4WB

8 bars



CFR5024M4
CFR5024M4WB

6 bars

All racks shown
with bars attached
(bars sold separately)

TRANSFER RACKS

NOTE: These items ship in
7-10 business days

ISTR21Z
ISTR24Z
ISTR30Z



IN STORE TRANSFER RACKS - 21", 24" & 30" SIZES *(bars not included)*

ISTR21Z	458.49	1	21" rack /uses IHB2100	20w x 22 3/8 x 77h	27
ISTR24Z	473.99	1	24" rack /uses IHB2400	20w x 26 x 77h	33
ISTR30Z	503.99	1	30" rack /uses IHB3000	20w x 31¼ x 77h	37

(Each rack holds 18 hang bars - bars sold separately)

COORDINATING HANGER BARS



IHB2100 / IHB2400 / IHB3000

COORDINATING HANGER BARS WITH CLAMPS - 3 SIZES

IHB2100	22.29	1	use with ISTR21Z	21" long	4
IHB2400	22.94	1	use with ISTR24Z & CFR mobile rack system	24" long	1/3
IHB3000	25.01	1	use with ISTR30Z	30" long	6

(24" long hang bar holds approximately 55 hangers)

Hanger Stackers, Racks & Caddies **BACKROOM**

style # \$ qty description size wgt



101 12.90 1 Chrome 33" H; base - 19 1/4" x 7 1/2" 5

HANGER STACKERS



Chrome Hanger Stacker Holds 100 hangers of average size.

Most Popular!



Deluxe Wood Hanger Stackers

101N-WD			Natural		
101W-WD	42.61	1	White	33 1/2" high, 19 1/4" x 7 1/8" base	5
101B-WD			Black		
101M-WD			Mahogany		



HANGER CADDIES

- sort /organize hangers by style
- eliminates tangling /breakage
- 21" holds approx. 40 hangers

D21 77.76 1 Chrome 21" H dress 5/18



BACKROOM Workstations & Folding

MOBILE WORKSTATION

VTL2046



style #	\$	qty	description	size	wgt
VTL2046	290.56	1	Steel tube folding table w/grey powdercoat finish and laminated work surface. With folding leaves and 2 shelves.	20" w x 18" d x 34 3/4" h without leaves Leaves are 20" x 14" each	7/23

**Note that this item ships in 7-10 business days*



MOBILE FOLD SYSTEM

NHMOBILEFOLD

NHMOBILEFOLD	372.99	1	Mobile Fold Station w/ casters	31" L x 12-33" w x 36" h base; center panel adjusts 7-13"; base 21" w	50
--------------	--------	---	--------------------------------	---	----

Simply fold and remove for a neat presentation



SHIRT FOLDING BOARDS



Choose from various sizes

FB1301	10.04			8 1/2" x 12"	
1301SF	12.15			8 1/2" x 15"	
FB1302	12.15	1	1/8" Clear Acrylic	10" x 12"	1/2
FB1303	13.12			11" x 12"	
FB1304	13.12			9 1/2" x 14"	

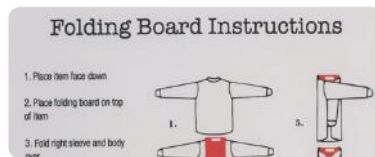
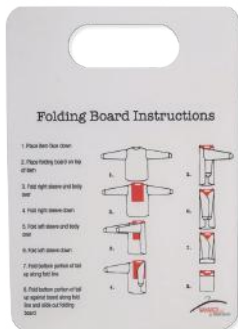

with printed instructions

FB1301PR

FB1301PR	11.02	1	Acrylic Board with printed folding instructions	8 1/2" x 12"	2
----------	-------	---	---	--------------	---

Tagging Accessories PRICING SUPPLIES

style # \$ qty description size wgt

National STANDARD

J11SKIT 19.99 1 J11S tool, needles & fasteners KIT 2/6

J11S 9.88 1 National Standard RED Tagging Tool Standard 1/3

Standard Replacement Needles

300R 10.37 4 pack Plastic w/steel needles Standard 1

Standard Fasteners - Natural

F1/2	5000	Natural	1/2"	1/3
F1	5000	Natural	1"	1/3
F2	5000	Natural	2"	1/3
F3	5000	Natural	3"	1/3
F5	5000	Natural	5"	1/3

Standard Fasteners - Colors

F1-COLORS	11.02	5000	Specify	1"	1/3
F3-COLORS	11.02	5000	Specify	3"	1/3
954718	11.02	5000	Black	1/2"	1/3

C-Hook (Tacking Hook)

TH 19.12 5000 Natural 1 7/8" 2/7

National FINE

J11F 17.33 1 National Fine RED Tagging Tool Fine 1/3

Fine Fabric Replacement Needles

400F 13.63 4 pack Plastic w/steel needles Fine 1

Fine Fabric Fasteners - Natural

FF1	6.97	5000	Natural	1"	1/3
FF2	6.97	5000	Natural	2"	1/3

NATIONAL STANDARD TAGGING TOOL



Tagging Tool Kit
Nahanco one J11S tagging tool, one pack needles & one pack each of 1" and 3" natural standard fasteners (5000 pieces each)

NATIONAL STANDARD TAGGING FASTENERS

F1/F3 - Colors

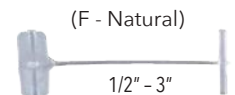
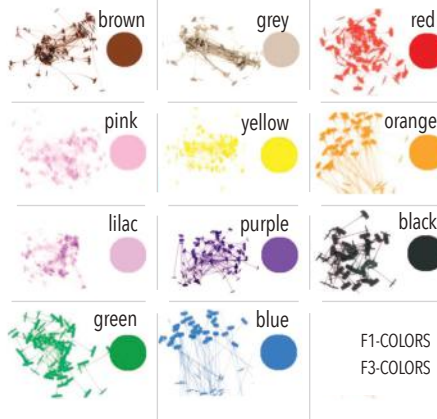

C-HOOK FASTENERS

Pair and tag with one hook. For use in standard guns



NATIONAL FINE TAGGING TOOL

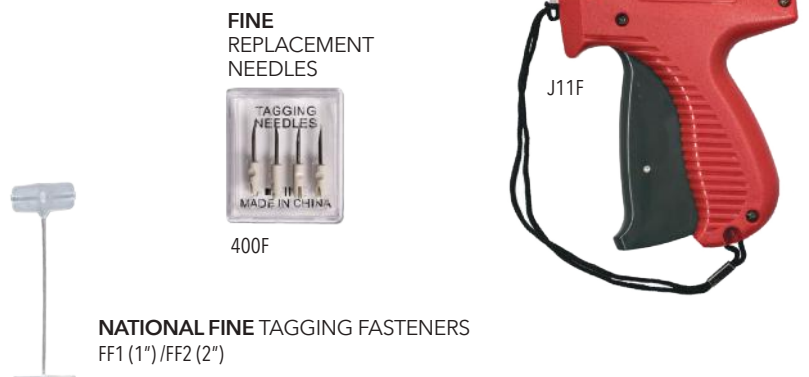

NATIONAL FINE TAGGING FASTENERS
FF1 (1") / FF2 (2")

PRICING SUPPLIES Tagging Accessories

DENNISON STANDARD TAGGING TOOLS



DENNISON MARK III® STANDARD TAGGING TOOL

MTGS



DENNISON SCISSOR GRIP STANDARD TAGGING TOOL

STGS



760111801 / 760034907

DENNISON NEEDLE LOCKS

08941



DENNISON STANDARD REPLACEMENT NEEDLES



DENNISON STANDARD TAGGING FASTENERS
06214 (1")/06215 (3")

style #	\$	qty	description	size	wgt
---------	----	-----	-------------	------	-----

Dennison STANDARD

MTGS	23.99	1	TEAL Tagging Tool	Standard	1/3
STGS	36.99	1	BEIGE Tagging Tool	Standard	1/3
760111801	3.87	1	Needle Locks: For MTGS	Standard	1/3
760034907	3.87	1	Needle Locks: For STGS	Standard	1/3
08941	16.90	4 pack	Replacement needles	Standard	1
06214	9.90	5000	Natural	1"	2/7
06215	9.90	5000	Natural	3"	2/7

DENNISON MARK III® FINE TAGGING TOOLS



MTGF

DENNISON MARK III® FINE TAGGING TOOL

760111801 / 760034907



DENNISON NEEDLE LOCKS



STGF

DENNISON SCISSOR GRIP FINE TAGGING TOOL



08944

DENNISON FINE REPLACEMENT NEEDLES

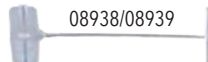

08938/08939

DENNISON STANDARD TAGGING FASTENERS

Dennison FINE

MTGF	31.90	1	ORANGE Tagging Tool	Fine	1/3
STGF	67.99	1	BLUE Tagging Tool	Fine	1/3
760111801	3.87	1	Needle Locks: For MTGF	Fine	1/3
760034907	3.87	1	Needle Locks: For STGF	Fine	1/3
08944	16.72	4 pack	Replacement needles	Fine	1
08938	14.90	5000	Natural	3/4"	1/3
08939	14.90	5000	Natural	2"	1/3

DENNISON SYSTEM1000 TAGGING TOOL



SYS1000



DENNISON SYS1000 NEEDLE LOCKS

760796901



DENNISON STANDARD REPLACEMENT NEEDLES

08941

DENNISON SYS1000 FASTENERS (08284/5)



Dennison SYSTEM 1000

SYS1000	49.90	1	PURPLE Tagging Tool	Standard	2/7
760796901	2.58	1	Needle Locks: For SYS1000	Standard	1/3
08941	16.90	4 pack	Replacement needles	Standard	1
08284	17.90	5000	Natural	1"	1/2
08285	17.90	5000	Natural	2 1/2"	2/10

Tagging & Marking PRICING SUPPLIES

style #	\$	qty	description	size	wgt
DH	17.49	1000	Black		2/3
DH500	11.86	500	Black	1 3/4"	1/3
DH-WH	18.74	1000	White		2/3
DHWH500	11.86	500	White		1/3
<hr/>					
SC3	19.88	5000	Natural	3"	1/3
SC5	19.88	5000	Natural	5"	1/3
SC9	22.38	5000	Natural	9"	1/3
<hr/>					
08302	34.90	5000	Natural	3"	1/3
08300	29.90	5000	Natural	5"	1/3
<hr/>					
08350	44.90	5000	Natural	5"	2/3
08350M	24.90	5000	Natural	5"	2/3
08470	39.90	1000	Natural	7"	2/7
08471	44.90	1000	Natural	11"	2/7
08401	55.90	1000	Black (solid barlock)	8"	2/7

NAHANCO fasteners - Best Value!



NAHANCO SUPER CIRCLE FASTENERS - 3", 5", 9" (SC)



DISPLAY-IT-HOOK (DH)
You'll find hundreds of uses for this inexpensive display method



DENNISON SECURE-A-TAC - 3" & 5" (08300/ 08302)



08350 **DENNISON SECURE-A-TIE - 5"**
08350M **ECONOMY SECURE-A-TIE - 5"**



DENNISON BARLOCK LADDER TIES



08470, 08471

Dennison MARKING TOOLS

style #	\$	qty	description	size	wgt
09225	49.90	1	Pricing Tool Single line		2/7
Labels:					
09140	66.99	15M	White	1/2x7/8"	
09141	66.99	15M	Red	1/2x7/8"	1/3
H89891	13.87	5 Pack	Ink rolls - black		1/2

DENNISON 09225 THE MIGHTY ONE™
Prints 1 line, 8 characters

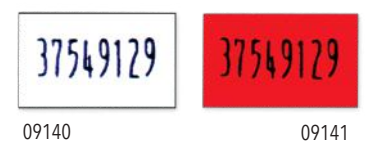

style #	\$	qty	description	size	wgt
06220	89.90	1	Pricing Tool Double line		2/7
Labels:					
06298	66.99	12.5M	White	5/8x7/8"	2/3
06302	66.99	12.5M	Red	5/8x7/8"	
H89892	13.87	5 Pack	Ink rolls - black		1/2

DENNISON 06220 MODEL 210 HAND LABELER
Prints 2 lines, 10 characters

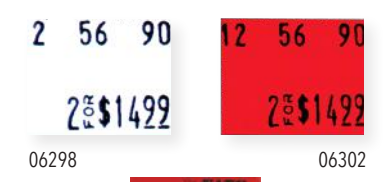

INK ROLLER H89892



PRICING SUPPLIES Marking Tools

MONARCH MARKING TOOLS



MONARCH 1110-2
Prints 1 line, 6 characters



REB111



LABELS



REB135



REB112



INK ROLLER
3003



LABELS



1130 TOOLS
Prints 1 line, 6 characters



1130-IR



SILICONE LUBRICANT
3002

PLASTIC LABEL PEELER
3104-1



MONARCH 1115-4
Prints 2 lines, 8 characters

LABELS

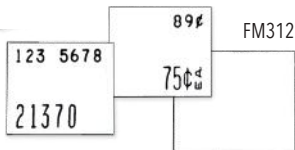

INK ROLLER
3004

style # \$ qty description size wgt

Monarch MARKING TOOLS

1110-2	91.63	1	Pricing Tool Single Line		2/7
--------	-------	---	-----------------------------	--	-----

REB111	22.29	17M	Labels: White	3/8x3/4"	
REB135	17.90	17M	Red/Yellow	3/8x3/4"	2/3
REB112	17.90	17M	Red	3/8x3/4"	

3003	6.99	1	Ink roller replacement		2/3
------	------	---	------------------------	--	-----

1130	74.26	1	Pricing Tool, Compact Size Single line		1/3
------	-------	---	--	--	-----

F0122	27.73	25M	Labels: White	.62x.44"	
F0132	34.73	25M	Red	.62x.44"	2/3
F0151	48.60	25M	Green	.62x.44"	

1130-IR	8.42	1	Ink roller replacement		1
---------	------	---	------------------------	--	---

3002	12.57	1	SILICONE	1/2 oz.	1
------	-------	---	----------	---------	---

3104-1	2.85	1	PLASTIC	5"	1
--------	------	---	---------	----	---

1115-4	139.90	1	Pricing Tool Double Line		2/7
--------	--------	---	-----------------------------	--	-----

FM312	26.44	15M	Labels: White	5/8x3/4"	2/3
-------	-------	-----	------------------	----------	-----

3004	6.99	1	Ink roller replacement		1
------	------	---	------------------------	--	---

Tags & Labels PRICING SUPPLIES

style # \$ qty description size wgt

T1 /Unstrung	14.36	1000	Specify	1 3/8x2 3/4"	2
T1S /Strung	24.36	1000	Specify	1 3/8x2 3/4"	2
T2 /Unstrung	14.36	1000	Specify	1 3/4x2 7/8"	2
T3 /Unstrung	11.24	1000	Specify	1 1/4x1 7/8"	2
T2S /Strung	24.49	1000	Specify	1 3/4x2 7/8"	2
T3S /Strung	26.89	1000	white (1)	1 1/4x1 7/8"	2
	26.89	1000	light blue (19)	1 1/4x1 7/8"	2
	21.51	1000	All other colors	1 1/4x1 7/8"	2
Unstrung					
T4	14.36		White	1 3/4x2 7/8"	2
T5	11.24	1000	White	1 1/4x1 7/8"	2
Strung					
T4S	20.90		White	1 3/4x2 7/8"	2
T5S	23.49	1000	White	1 1/4x1 7/8"	2
Unstrung					
641	26.44		Red/white	1 7/8x3 1/2"	3
510	18.01	1000	Red/white	1 3/4x2 7/8"	2
Strung					
641S	36.16		Red/white	1 7/8x3 1/2"	3
510S	24.36	1000	Red/white	1 3/4x2 7/8"	3
Unstrung					
328	22.38		Red/white	1 3/4x2 7/8"	2/3
328C	22.38	1000	Red/yellow	1 3/4x2 7/8"	2/3
316	15.71		Red/white	1 1/4x1 7/8"	1/3
316C	12.57		Red/yellow	1 1/4x1 7/8"	1/3
Strung					
328S	18.90		Red/white	1 3/4x2 7/8"	3
328CS	23.63	1000	Red/yellow	1 3/4x2 7/8"	2
316S	23.63		Red/white	1 1/4x1 7/8"	2
316CS	18.90		Red/yellow	1 1/4x1 7/8"	2
Unstrung					
200			Red/white	1 3/4x2 7/8"	
380	18.01	1000	Red/yellow	1 3/4x2 7/8"	2
320			Red/white	1 3/4x2 7/8"	
Strung					
200S			Red/white	1 3/4x2 7/8"	
380S	24.36	1000	Red/yellow	1 3/4x2 7/8"	2
320S			Red/white	1 3/4x2 7/8"	
Unstrung					
348	18.01		Red/white	1 3/4x2 7/8"	2/3
346	13.87	1000	Red/white	1 1/4x1 7/8"	2
Strung					
348S	24.36	1000	Red/white	1 3/4x2 7/8"	2
346S	21.51		Red/white	1 1/4x1 7/8"	1



COUPON TAGS HORIZONTAL

T1 / T1S available in:

- (1) white
- (2) lavender
- (3) grey
- (4) dark blue
- (5) pink
- (12) lavender
- (13) buff
- (19) light blue

T2 / T2S / T3 / T3S available in:

- (1) white
- (2) lavender
- (3) grey
- (4) dark blue
- (5) pink
- (9) yellow
- (10) red
- (12) lavender
- (13) buff
- (14) orange
- (15) light green
- (16) dark green
- (19) light blue



T4 / T5

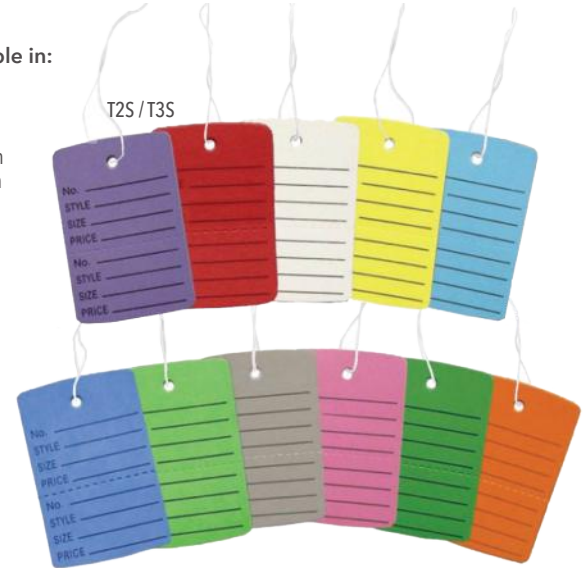

COUPON TAGS VERTICAL

CLEARANCE TAGS



328C

SALE TAGS



316C



641



510

SPECIAL TAGS



200



380



320

DISCOUNT TAGS



348



346

PRICING SUPPLIES Tags & Labels

style #	\$	qty	description	size	wgt
HOLD	21.13		Blue/white	2 3/8x4 3/4"	
SOLD	21.13	1000	Red/white	2 5/8x4 1/4"	5
SALE	27.90		Red/yellow	2 3/8x4 3/4"	



SLIT TAGS
Slip over existing tag

85L	39.90		2 sided, manila Strung	3 1/2x8 1/2"	6
85A	22.94	500	Unstrung, Button hole	3 1/2x6 1/4"	
TL			1 sided, strung manila	3 1/8x6 1/4"	4
TA	35.38	500			
TR					

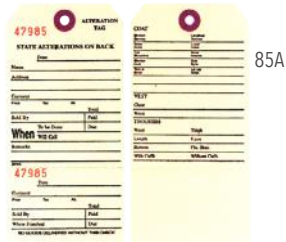

ALTERATION, LAYAWAY AND REPAIR TAGS



DELUXE LAYAWAY ALTERATION



4473TAG
BLANK TAG



PRESSURE SENSITIVE LABELS

975				1"	
970	8.42	500	Red/white	1"	1
962				1x1 1/4"	
965				1x1 1/4"	

4473TAG	6.80	250	White	1 3/4x2 7/8"	1
---------	------	-----	-------	--------------	---

Strung					
4S	22.52			1 x 1 1/2"	1/2
5S	21.71	1000	White	1 1/8x1 13/16"	1/2
6S	22.52			1 5/16x1 15/16"	2/3
7S	27.86			1 1/2x2 1/4"	2/3
8S	29.48			1 3/4x2 11/16"	2/3
Unstrung					
4NS	8.75			1 x 1 1/2"	1
5NS	10.53	1000	White	1 1/8x1 13/16"	1
6NS	10.53			1 5/16x1 15/16"	2/3
7NS	11.34			1 1/2x2 1/4"	2/3
8NS	15.71			1 3/4x2 11/16"	2/3



MERCHANDISE TAGS

(4S - 8NS)
Available strung or unstrung.

APT5NKFT

APT2NKFT

8SKFT

6SKFT

KRAFT TAGS

Shipping & Merchandise tags

Kraft Shipping Tags, Unstrung:					
APT5NKFT	4.92	50	Large	2.375" x 4.75"	1/1
APT2NKFT	4.40	50	Small	1.625" x 3.25"	1/1

Kraft Merchandise Tags, Strung:					
8SKFT	5.57	50	Large	1.75" x 2.875"	1/1
6SKFT	4.92	50	Small	1.25" x 1.875"	1/1

Strung						
APT1	28.50	1000		2 3/4x1 3/8"	2	
APT2	29.80	1000		3 1/4x1 5/8"	2	
APT3	31.09	1000		3 3/4x1 7/8"	3	
APT4	37.57	1000	Manila	4 1/2x2 1/8"	3	
APT5	40.16	1000		4 3/4x2 3/8"	4	
APT6	42.76	1000		5 1/4x2 5/8"	5/6	
APT7	24.61	500		5 3/4x2 7/8"	3	
APT8	27.20	500		6 1/4x3 1/8"	3	
Unstrung						
APT1N	15.54	1000			2 3/4x1 3/8"	2
APT2N	19.43	1000			3 1/4x1 5/8"	3
APT3N	20.72	1000	Manila	3 3/4x1 7/8"	3/4	
APT5N	27.20	1000		4 3/4x2 3/8"	4/6	
APT6N	29.80	1000		5 1/4x2 5/8"	6	
APT8N	23.32	500		6 1/4x3 1/8"	3	



MANILA ALL-PURPOSE TAGS (APT)

Available strung or unstrung.



GARMENT BAGS

style #	\$	qty	description	size	wgt
K30	163.09	1	Chrome Bagjack adjusts 39-68"H	18x31x74"H	29
K31	97.86	1	Chrome Bagjack adjusts 39-68"H	13" x 18"	14
K32	83.46	1	Chrome Bagjack adjusts 39-68"H	Base: 12" dia.	14

LARGE RUN CUSTOM POLYBAGS

Minimum 50 rolls (can mix sizes same color bag and print).

Customer must supply camera-ready artwork.

Black or white bags - stock ink colors include: red, blue, black, white, orange, yellow, green. One time plate charge of \$75.00

Call us for a low, low price quote!

POLYBAG STANDS



GARMENT BAG DISPENSER / SINGLE ROLL POLYBAGS

Base made of 1" square tubing w/ball bearing mounted platform for ease of turning



3-ROLL BAG DISPENSER

Base made of 1" square tubing

K30

BAGGING JACK

For polybags; with heavy weight base



POLYBAGS



GARMENT BAGS (POLYBAGS) ON A ROLL

- 1/2 mil Medium Weight Clear Poly Bags (NTP, X)
- 1 mil Super Weight Clear Poly Bags (U)
- 1 mil Super Weight Poly Bags in White (W) or Black (B)

TRANSPORTATION GARMENT BAGS

Water-repellent cotton duck w/ full length heavy-duty zippers and 15" hanging bar (with accessory pocket)

Holds up to 25 garments



HL38L
HL48L
HL57L

40" SUIT COVERS

Polyethylene (taffeta finish), 3 gauge



UV340BB

GARMENT BAGS



CUSTOMIZE



NW40BB / NW48BBTUX



NW455B

NON-WOVEN FUR COVERS

Cloth-type covers

NON-WOVEN SUIT COVERS

Cloth-type covers

NTP330	51.49	840	Clear	21x4x30"	
NTP338	51.49	663	1/2 mil	21x4x38"	
NTP340	51.49	562	opening at top of	21x7x40"	25
NTP354	51.49	466	each bag	21x4x54"	
NTP372	51.49	350		21x4x72"	
X336	69.99	999		21x3x36"	
X354	69.99	666	Clear	21x3x54"	33
X372	69.99	500	1/2 mil	21x3x72"	
U336	69.99	519	Clear	21x3x36"	33
U354	69.99	333	1 mil	21x3x54"	
U372	59.99	249		21x3x72"	
W336	75.49	500	White	21x3x36"	
W354	69.99	333	1 mil	21x3x54"	33
W372	75.49	249		21x3x72"	
B336	76.49	500	Black	21x3x36"	
B354	76.49	333	1 mil	21x3x54"	33
B372	76.49	249		21x3x72"	
HL38L	60.99	1	Dark Blue	38"	
HL48L	68.49	1	Dark Blue	48"	3/33
HL57L	75.49	1	Dark Blue	57"	

UV340BB	222.99	100	Black poly	24 x 40"	29/33
NW40BB	217.99	100		24 x 40"	22
NW48BBTUX	81.99	50	Black w/ID pocket	24 x 48"	24
NW54BB	156.69	50		24 x 54"	27
NW455B	217.99	50	Black w/handles and 4" gusset	24 x 45"	32



Customize NW styles - minimum order of 100 PIECES

GARMENT BAGS



ZIPPERED SUIT COVERS
3 gauge, taffeta finish
S40 / S54

SEWN SHOULDER COVERS



N8X21

CRYSTAL CLEAR GUSSETED VINYL GOWN COVERS

Reinforced hanger opening and full-length zipper. 4 gauge



Gusset detail

- BB54
- BB60
- BB66
- BB72



HEAVY-DUTY EMBOSSED VINYL BRIDAL GOWN COVERS

Features a clear vinyl pouch. 3 gauge

BLK72
W72
PNK72

MUSLIN GOWN COVERS
Cloth covers w/ button closures

MDGB1



NW7210/206
WHITE NON-WOVEN BRIDAL COVER
Cloth-type material

HEAVY-DUTY FULL LENGTH GOWN COVERS

Clear vinyl pouch and reinforced hanger opening. 3 gauge

WGS72



C36 / C54 / C72

OVERLAP CLEAR COVERS
Heavy binding, reinforced hanger opening and extra-wide overlap. 2 gauge



style #	\$	qty	description	size	wgt
S40	233.49 226.99	100	Clear White or Black	24 x 40"	34
S54	296.49 276.49	100	Clear White or Black	24 x 54"	36
N8X21	86.49	100	Clear /2 gauge	8 x21"	6/10
10" Gusset / Imprint available					
BB72	69.49		CLEAR	24 x 72"	12
BB66	65.49		CLEAR	24 x 66"	11
BB60	60.49	12	CLEAR	24 x 60"	10
BB54	56.49		CLEAR	24 x 54"	10
BLK72	57.99		Black Vinyl	24" wide at top; 36" at bottom; 72" long	9/10
W72	57.99	12	White Vinyl		
PNK72	62.49		Pink Vinyl		
Natural muslin garment bags for gowns Made of 100% cotton muslin with button closures. Acid-free and moth resistant					
MDGB1	35.99	1	4" gusset	62 x 24"	1/2
MDGB2	39.99	1	10" gusset	70 x 24"	1/2
NW7210	221.49	50	Non-woven white cloth 10" gusset	24 x 72"	35
NW72206	144.49	25	Large 7"-20" full side gusset	24 x 68"	25
 Customize NW styles - minimum order of 100 PIECES					
WGS72	66.99	12	Full 10" Gusset White Vinyl	24 x 72"	11/12
C36	31.49		Clear Vinyl	24 x 36"	4/7
C54	36.99	12	Clear Vinyl	24 x 54"	6/8
C72	40.49		Clear Vinyl	24 x 72"	7/8

Collapsible Racks RACKS & MERCHANDISERS

COLLAPSIBLE ROLLING RACKS

Fold flat for easy transportation and storage



RCS-1

Chrome; 1" round tubing w/4" casters; 22 1/2" wide.
Adjustable height: 55" - 60" - 65"; 48" hangrail
tubing w/12" pullouts; weight capacity of approx.
250 lbs. 1/carton; 16/24lbs. **\$79.99**



RCS2

Heavy Gauge Chrome. Lightweight, foldable rolling
rack with a weight capacity of approx. 150 lbs.
Features include: adjustable height risers - 66" - 71";
Center bar that extends 8" on either side;
4 casters 1/carton; 17lbs. **\$59.90**

RCS-1

RCS2

RCS-1 vs RCS2

Collapsible, Rolling
Clothing Racks:
A side by side comparison

\$79.99	cost	\$59.90
Actual 16lbs/shipping 24lbs	weights	Actual 17lbs/shipping 17lbs
Holds approx. 250lbs	weight capacity	Holds approx. 150lbs
55" - 65"H 48"L x 22.5"W	measurements	65.5" - 70"H 48"L x 22.5"W
NO locking wheels	wheels	TWO locking wheels
4.45"H collapsed	compact	3"H collapsed

BOTH RACKS HAVE

12" Adjustable Sliding Sides

12" extending sides

Clip for storage

Adjustable heights

Heavy-duty steel frames

RACKS & MERCHANDISERS Collapsible Racks - Accessories



style #	\$	qty	description / size	wgt
---------	----	-----	--------------------	-----

Accessories that work with racks
RCS1 & RCS2

Check product descriptions for details

RCS-1/RCS2 ACCESSORIES

Add-on Bar
RCS1AO

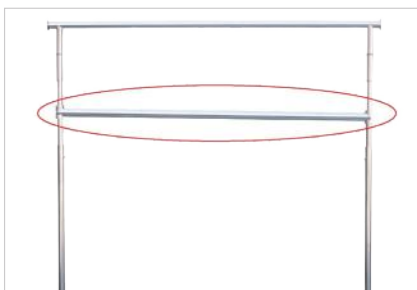

Add on chrome hang bar for rolling clothes racks

RCS1AO			for RCS-1	
	\$19.46	each		4/5 lbs
RCS2AO			for RCS2	

Shelf/Display Screen
RCA5



RCA5	\$56.99	each	Chrome: Opened, 45" x 38" /Folded, 45" x 19" Screen only, rack not included (works with RCS-1 rack). Includes two connecting brackets, one stabilizing hook, and 3" wheels with 3/8" stems. Fold screen in half to serve as merchandise shelf.	13/19 lbs
------	---------	------	--	-----------

Garment Rack Cover

RCA100



RCA100	\$98.50	each	60"L x 50"H x 24"W Deluxe zipper garment rack cover. Navy blue nylon	3/10 lbs
--------	---------	------	--	----------

Carrying Bag

BRSWF



BRSWF	\$63.89	each	Black heavy canvas carrying bag for collapsible rolling rack RCS-1 (see RCS-1 pg 81)	4/12 lbs
-------	---------	------	---	----------

Rolling Z Racks RACKS & MERCHANDISERS

style # \$ qty description / size wgt

Z101 \$104.86 1 **Chrome finish stockroom rolling Z clothes rack** 33/70

- 73" overall height, 60"L x 69"H x 21"W
- Ideal for use in showrooms and warehouses
- Will nest together for easy storage when not in use
- Heavy Z base is one piece construction
- The hangrail is made of 1-1/4" round tubing
- Includes 4" industrial rubber casters

RZE12 \$10.50 2 2 - 12" height extensions for Z101 33/20

RZH60 \$28.51 1 60" add on hangrail for Z101 2

Z201 \$132.99 1 **Chrome finish industrial rolling Z clothes rack** 34/39

- 63"L x 66"H x 22"W with a blue base
- Heavy duty Z base is one piece construction
- Will nest together for easy storage when not in use
- Features 4" industrial casters
- Hangrail made of 1 1/4" square tubing and is 58 1/2" in length
- Ideal for showrooms and warehouses
- Ships Oversized UPS

Z2464 \$80.49 1 set Clear Z-rack cover and 2 support bars set for Z101 & Z201; 63.5"W x 69.5"H x 22.5"D 10

NHRCPB100 \$82.99 100 pc/ctn Rack cover: large, flat polly bag; 58"W x 100"L; 1 mil. thick 43

NHRCPB25 \$33.99 25 pc/ctn Rack cover: large, flat polly bag; 58"W x 100"L; 1 mil. thick 10



STANDARD Z RACKS

Z Rack extensions

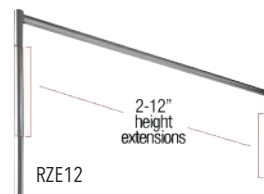

Add-on hangbar



NESTING Z RACKS

Industrial "Z" Rack  Racks nest together to save space

Z201

HEAVY DUTY Z RACKS

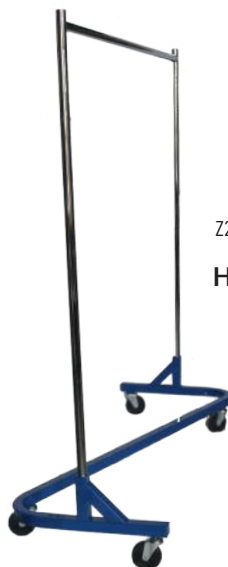

Z RACK COVER

Z2464



UNIVERSAL RACK COVER

NHRCPB25/100

RACKS & MERCHANDISERS Utility Racks

HEAVY DUTY COLLAPSIBLE RACK



style #	\$	qty	description / size	wgt
RCS3	\$160.99	1	Chrome, 22" wide 1" round chrome tubing Double 48" hangrails with four 12" pull-out rods Height adjustable from 55 to 60 to 65" 4" ball bearing casters	40/45



EL8000

**CLASSIC
UTILITY
RACK w/5
WIRE
SHELVES**

Best Value!



EL8000	\$79.90	1	Classic Utility Rack w/ 5 shelves 38" L x 14"W x 60" H (61.5"H w/casters) Zinc-plated industrial-strength steel SHIPS TRUCK	29/29
--------	---------	---	--	-------

HEAVY DUTY UTILITY RACK

EL8162



EL8162	\$199.90	1	Chrome Utility Rack 6 Shelves 48"W x 18"D x 72"H 2 3/4" dia. casters	98
--------	----------	---	---	----



STOCKROOM ROLLING RACK

K43	\$126.28	1	60" L, 1 1/4" hangrail Adjusts in height from 54 - 74"; 20" W; 3" casters	27
-----	----------	---	---	----

Pairs with casters **WHEL** and **TW10KIT** (details on page 90)

HEAVY DUTY INDUSTRIAL ROLLING RACK



R504



R504	\$138.46	1	70"H x 66"L 1 1/4" chrome tubing 4" ball bearing casters Ships Oversize UPS	34
------	----------	---	---	----

The original garment center workhorse.
Base is all-welded construction with heavy steel angle iron.
Large 4" ball casters for easy mobility under heavy loads.

R504AO	\$34.11		Add on hangbar for R504 to create a lower level for hanging	8/8
--------	---------	--	---	-----

Floor Racks RACKS & MERCHANDISERS

style #	\$	qty	description / size	wgt
K23	\$102.06	1	Chrome Rectangular tubing 32 2-16" straight arms. Adjust every 3" from 48-72" H	
K24	\$102.06	1	Chrome Rectangular Tubing 34 2-18" slant arms. Adjust every 3" from 48-72" H	
K21X	\$106.27	1	Chrome / 2-16" straight arms with X style base and 4 casters. Arms adjust every 3" from 48-72" H	27



CHROME 2-ARM RECTANGULAR TUBING RACKS



1/2" W x 1 1/2" H rectangular tubing arms:

B90	\$79.06	1	Straight arm is 16"	26
B91	\$79.06	1	Slant arm is 18"	

Both racks are independently adjustable every 3", from 52" to 73" H

MATTE BLACK ADJUSTABLE 2-ARM RACKS



K20	\$83.86		1" square tubing 16" straight arm	18,6,5/8 (3 ctns)
K22	\$83.86	1	18" slant arm	23/33
K25	\$83.86		Arms adjust every 3" from 48-72" H	18,6,6/8 (3 ctns)



CHROME 2-ARM SQUARE TUBING RACKS

K39	\$49.90	1	Chrome - 45" H x 19 1/2" W Square tubing upright w/2 round tubing arms with disc ends	10/13
-----	---------	---	---	-------



CHROME BAG RACK

ARM13	\$7.39	1	16" Chrome straight arm for square tubing racks	6/8
-------	--------	---	---	-----



REPLACEMENT ARM

For Square tubing racks:

TV17	\$7.00		17" Chrome Rectangular tubing - for vertical 1" tubing /add-on twist-on arms for square tubing racks	
TV12	\$5.57	1	12" Chrome Square tubing For vertical 1" tubing	1/6
TV16	\$5.99		16" Chrome Square tubing For vertical 1" tubing	

Twist on Displayers for 1" Square Tubing



ADD-ON DISPLAY BARS

RACKS & MERCHANDISERS Floor Racks

4-WAY GARMENT RACKS with Rectangular Tubing

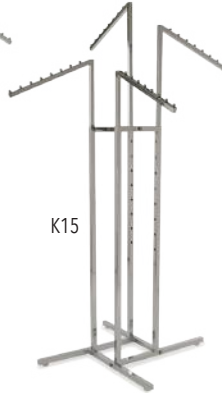
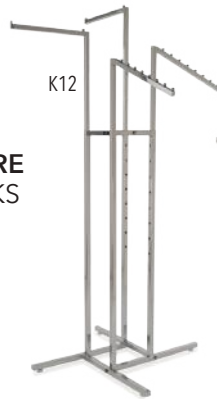
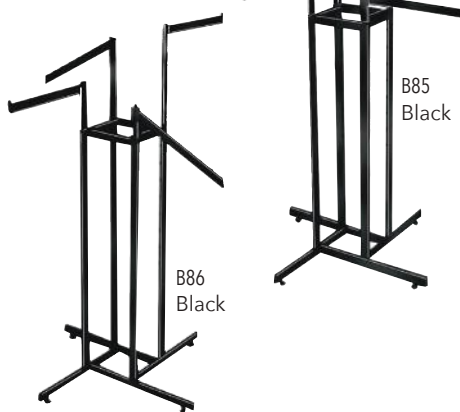
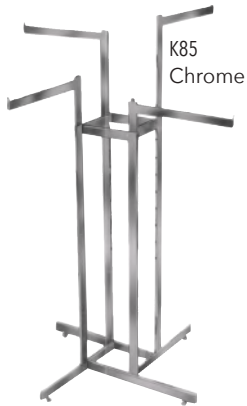

4-ARM SQUARE TUBING RACKS

1" Square Tubing

HIGH CAPACITY FLOOR RACKS



ADD-ON DISPLAY BARS

Twist on Displayers for Vertical
1/2" x 1 1/2" Rectangular Tubing



style #	\$	qty	description / size	wgt
K85	\$114.49	1	Chrome 4- 16" Straight arms Rectangular Tubing	33/35
B85	\$118.32	1	Black 4- 16" Straight Arms Rectangular Tubing	36
B86	\$118.32	1	Black, 2- 16" Straight arms; 2- 18" Slant arms Rectangular Tubing	38



Racks K85 & B85 pair with caster style
CTM60 (details on page 90)



Rack B86 pairs with caster style
CTM60 (details on page 90)

K10	\$111.86		1" square tubing 16" straight arm	
K12	\$111.86	1	18" slant arm Arms adjust every 3"	30
K15	\$111.86		Arms adjust every 3" from 48-72" H	

K10, K12 & K15 pair with casters from kit
TW10KIT (see details on page 90)



K80	\$145.02		Chrome, 4- 22" Straight arms; Rectangular tubing	34
B80	\$121.05	1	Black 4- 22" Straight arms Rectangular tubing	36
K80SC	\$170.49		Satin Chrome 4-22" Straight arms Rectangular tubing	38



The above 3 racks pair with caster style
CTM60 (details on page 90)

All of the above racks listed on this page
adjust in height every 3" from 48" to 72" high

For Rectangular tubing racks:

RV22	\$9.49	1	22" Chrome Rectangular tubing; For vertical 1/2" x 1 1/2"	2/6
------	--------	---	---	-----

Floor Racks RACKS & MERCHANDISERS

style #	\$	qty	description / size	wgt
K40	\$116.42	1	Chrome: 1" Square tubing 1 1/4" round hangrails 60"L x 22" W Height adjustable every 3" from 48-66"	38
K41	\$139.86	1	Same as K40 but with center V reinforcing	40



Both K40 and K41 pair with casters
WHEL and **TW10KIT**
(see details on page 90)

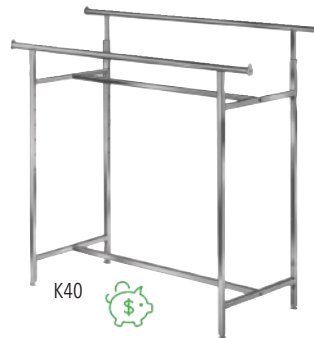

DOUBLE BAR RACKS



RACK ACCESSORIES

(for racks K40 /K41)

KH1	\$40.82	2	Chrome: 60" add-on hangrail for K40 or K41 racks allows you to create 15' of continuous hangrails using only 2 racks	8
KH2	\$35.38	2	60" add-on hangrail for K40 or K41 racks allows you to create upper and lower hanging	8



Add-on
Hangrails

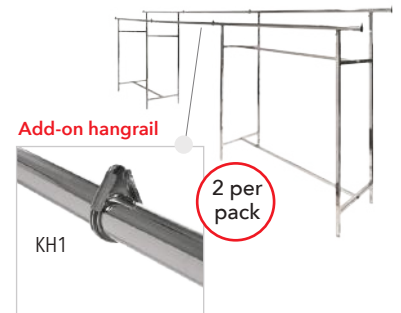

Double-Bar Grid
Clothing Rack
Topper
1000034

1000034	\$88.49	1	Chrome grid topper 23"x54"x3" Ships oversize UPS	14/32
---------	---------	---	---	-------

K35	\$143.99	1	Chrome: 1" Square tubing 16-twist on 12" tubular arms 61" H	34
K36	\$143.99	1	1" Square tubing 16-twist on 1/2"x7/8"x12" rectangular arms 61" H	35

FOLDING LINGERIE DISPLAYERS



K16	\$112.99	1	Chrome: 1" Square tubing 8- 18" slant arms Total of 40 hooks	33
-----	----------	---	---	----

K16 pairs with a variety of casters -
CTM65, TW12 & TW12LK (details on page 90)



CTM65



TW12

TW12LK

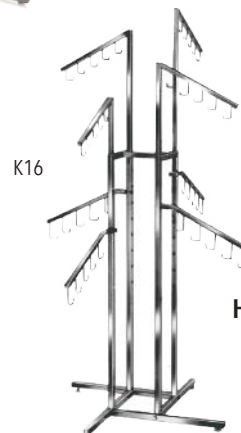

HANDBAG DISPLAYER

RACKS & MERCHANDISERS Round Racks

ROUND GARMENT RACKS



K50

Can be used with casters



K53
Cannot be used with casters

ROUND RACKS

Welded Construction

Can be used with casters



K52WD



K71WDSC



K73WD



K73WDSC



KR57MAB

HALF-ROUND RACK



K62

style #	\$	qty	description / size	wgt
---------	----	-----	--------------------	-----

K50	\$139.86	1	36" round chrome rack Ships oversize UPS	8/17, 26 (2 ctns)
-----	----------	---	--	----------------------

Works with casters from kit
TW10KIT516 (see page 90 for details)

Rack adjusts every 3" from 48" to 66"; uprights are 1" square tubing; round 1 1/4" hangrail; includes shelf supports.

K53	\$160.29	1	36" chrome round revolving rack; Adjusts in height from 48-63"	34/90
-----	----------	---	---	-------

Racks with WELDED CONSTRUCTION

(allows for heavy loads)

K52WD	\$149.90	1	36" round chrome rack Ships truck	TRUCK 35/90
-------	----------	---	---	----------------

Works with **CTM65** caster style - (details on page 90)

K71WDSC	\$152.99	1	36" Satin chrome; adjusts from 48"-66" H Ships truck	TRUCK 39/90
---------	----------	---	---	----------------

K73WD	\$142.99	1	42" round chrome rack Ships truck	TRUCK 38/90
-------	----------	---	---	----------------

Works with **TW10KIT** casters - (details on page 90)

K73WDSC	\$171.49	1	42" round satin chrome rack Ships truck	TRUCK 38/90
---------	----------	---	--	----------------

Works with **CTM65** casters - (details on page 90)

KR57MAB	\$181.90	1	42" Black - same as K73 Ships truck	TRUCK 48/90
---------	----------	---	---	----------------

Works with **CTM60** casters - (details on page 90)

Racks adjust from 48" to 70" H; uprights are 1" square tubing; square tubing legs taper at bottom to allow casters to fit snugly; hangrail is made of 1" x 1 1/2" rectangular tubing; includes shelf supports

K62	\$126.96	1	43" half round rack; Adjusts in height every 3" from 49-73" / 1" sq. tubing / round hangrail	25/34
-----	----------	---	--	-------

Round Racks Accessories RACKS & MERCHANDISERS

style #	\$	qty	description / size	wgt
---------	----	-----	--------------------	-----

ROUND RACK ACCESSORIES

KH5KD	\$69.99	1	36" diameter add on hangrail for K50/K52WD	11/12
-------	---------	---	--	-------



KH7	\$27.09	4	Clamps to add a ring	4
-----	---------	---	----------------------	---



1000394	\$75.49	1	30" Chrome grid topper	9/31
---------	---------	---	------------------------	------

CHROME GRID (1000394) attached to a K50 rack



GLASS OR MELAMINE ROUND TOPPERS

G30	\$102.49	2	2 pieces per carton 30" glass topper, 3/16" thick <i>for use with 36" round racks</i>	52
-----	----------	---	---	----

G36	\$50.49	1	1 piece per carton 36" glass topper, 1/4" thick <i>for use with 42" round racks</i>	30
-----	---------	---	---	----

G30/G36 ships UPS oversized - charges will apply



RTW30	\$45.99	1	30" round white topper	14
-------	---------	---	-------------------------------	----

RTB	\$45.99	1	30" round black topper	
-----	---------	---	-------------------------------	--

Toppers are for use with 36" round racks

SHP1	\$1.49	1 piece	Topper support <i>note that 4 pieces are needed for each rack</i>	1
------	--------	---------	--	---



RACKS & MERCHANDISERS Accessories

REPLACEMENT WHEELS



CTM60



CTM65 (Back view)



TW12

TW12LK



TW10KIT



WHRC

WHEL

BLACK BEAUTY RACKS

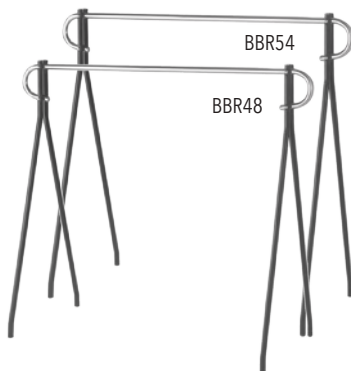

BBR54

BBR48

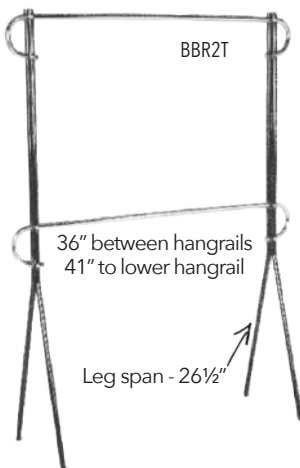

BBR2T

36" between hangrails
41" to lower hangrail

Leg span - 26 1/2"

TIE & BELT DISPLAYERS



Revolving Belt Rack

K58



K56

2 Tier Revolving Belt Rack



SPIRAL COSTUMER

Best Seller!



K29

MANNEQUIN FORM NOTCHED COSTUMERS



VM504BR

Mannequin form not included (see page 132)



VM504MTW



VM504MAB

style #	\$	qty	description / size	wgt
CTM60	9.99		2" ball caster, 1" stem	1/3
CTM65	10.99		2" ball caster, 5/8" stem	1/3
		1		
TW12	3.49		2" twin wheel caster, 5/8" stem	1/3
TW12LK	3.49		2" twin wheel caster, 5/8" stem w/ locking brake	1/3
TW10KIT	8.81	1 set	set of (4) 2" wheels, 3/8" stem; (2) w/locking brakes; (2) w/out Works w/ racks: K73WD, K40, K41, K43, K10, K12, K15	2/2
WHRC	36.81	4	Replacement casters - 4" for RCS-1, RCS2, RCS3	6
WHEL	37.32	4	Heavy duty replacement casters - 2 locking and 2 non-locking; 2 3/4" dia. K40 / K41 / K43	5
BBR2T	92.39		76" H x 5' L	26
BBR48	52.10	1	48" H x 5' L	14
BBR54	53.49		54" H x 5' L	16
			Black with chrome hangrails	
K56	121.99	1	60" H Chrome Upper ring 19" diameter w/ 20- 3" hooks Lower ring 27" D w/ 28- 3" hooks 18" diameter base	11,17,15 (3 ctns)
K58	96.49		52" H Chrome 19" diameter ring w/ 20- 3" hooks 18" diameter base	23, 4/90 (2 ctns)
K29	75.46	1	Chrome Spiral Costumer Spiral w/ 29 balls - 65" H round tubing, 18 1/2" base	26
VM504BR	99.90	2	Notched Costumer Satin Chrome Adjusts every 3" from 49 - 78" high	11, 15 (2 ctns)
VM504MTW	79.90	2	Notched Costumer Matte White Adjusts every 3" from 49 - 78" high	11, 14 (2 ctns)
VM504MAB	79.90	2	Notched Costumer Matte Black Adjusts every 3" from 49 - 78" high	11, 15 (2 ctns)

Pipeline RACKS & MERCHANDISERS

PIPELINE GARMENT RACKS

Racks have an anthracite grey or a gloss white finish, where noted.
Each garment rack includes 3" casters, two locking & two non-locking.



Non-adjustable Ballet Bar Rack
64" high; Base: 51"W x 23-3/8"D; 1 piece; 31 lbs.

Anthracite Grey - NHPSBB \$145.49
Gloss White - NHPSBBWTE \$137.99



Adjustable Ballet Bar Rack

Height adjusts from 48" to 72" high.
Base: 51"W x 23-3/8"D; 1 piece; 35 lbs.

Anthracite Grey - NHPSBBADJ \$185.99
Gloss White - NHPSBBADJWTE \$176.49



Add-On Hangbar

Only fits the adjustable ballet bar racks
NHPSBBADJ, NHPSBBCB1ADJ &
NHPSBBCB2ADJ; 1 piece; 6 lbs.

Anthracite Grey - NHPSAOH \$54.99
Gloss White - NHPSAOHWH \$54.99



60" Wide Ballet Bar Rack

64" high; Base: 60"W x 23-3/8"D; 1 piece; 31 lbs.

Anthracite Grey - NHPSBB60

\$158.99



60" Wide Adjustable Ballet Bar Rack

Height adjusts from 48" to 72" high.
Base: 60"W x 23-3/8"D; 1 piece; 38/46 lbs.

Anthracite Grey - NHPSBB60ADJ
Gloss White - NHPSBB60ADJWH

\$203.86

Double Tier Ballet Bar Rack

Top Bar height adjusts
from 63" - 78" high.

Lower Bar Height
adjusts from
45" - 60" high.

Tier step differen
measures 18".

Base: 49 5/8"W
x 23 1/4"D; 1 piece;

34/40 lbs.

Anthracite Grey - NHPSBBDTADJ \$191.49



Adjustable Double Ballet Bar Rack

Each 50" Long hangbar adjusts from 50" to 78" high.
Base: 50"W x 29"D; 1 piece; 61 lbs.

Anthracite Grey - NHPSBLLADJ \$303.99

Gloss White - NHPSBLLADJWH \$288.99

Double Ballet Bar Rack with Top

Frame Only -
NHPSBB2TS

48"W x 24"D x 52"H;
1 piece; 31 lbs.

\$321.49

NHPSBB2TS - MDF
Optional Top in Darkwood
measures
28" x 60" x 1.5";
1 piece; 51 lbs.

\$161.49



more PIPELINE →

RACKS & MERCHANDISERS Pipeline

PIPELINE GARMENT RACKS



Adjustable 4-Way Rack

16" long arms adjust from 48" to 72" high; base measures 30"; 1 piece; 44 lbs.

Anthracite Grey **NHPSA4; \$200.49**
Gloss White **NHPSA4WH; \$200.49**



Double Bar Rack

48"L x 22"W; 60" Long Hangbars adjust from 53 1/2" to 80" high; 2 pieces; 2ctns. 52, 10 lbs.

Anthracite Grey **NHPSDBR; \$252.99**
Gloss White **NHPSDBRWH; \$252.99**



Adjustable 36" Round Rack

Adjusts from 45" to 67" high; four (4) rubber tipped shelf supports (takes 30" round toppers - see pg 89); 1 piece; 49/52 lbs.

Anthracite Grey **NHPSR36; \$223.99**
Gloss White **NHPSR36WH; \$175.49**



Adjustable Ballet Bar Rack

w/one crossbar

41"W x 22"D; 44-72" high; 13" faceouts; 1 piece; 36 lbs.

Anthracite Grey **NHPS2CBADJ \$186.49**



Adjustable Ballet Bar Rack

w/one crossbar

41"W x 22"D; 44-72" high; 13" faceouts; 1 piece; 37 lbs.

Anthracite Grey **NHPSBBCB1ADJ; \$203.99**
Gloss White **NHPSBBCB1ADJWH; \$115.99**



Adjustable Ballet Bar Rack
w/two crossbars

41"W x 22"D; 44-72" high; 13" faceouts; 1 piece; 50 lbs.

Anthracite Grey **NHPSBBCB2ADJ \$223.99**



Adjustable 2-Way Rack

21"W x 21"D; 44-72" high; 13" faceouts; 2 pieces; 4,8 lbs. / 4,17 lbs. (2 ctns)

Anthracite Grey **NHPS2WADJ; \$124.99**
Gloss White **NHPS2WADJWH; \$124.99**



4-Leg Costumer

60"H x 21"W x 21"D w/ 6" faceout; 1 piece; 15 lbs.

Anthracite Grey **NHPSC2; \$102.49**
Gloss White **NHPSC2WH; \$102.49**



Replacement 2" Casters
Fits pipeline racks & costumers

NON-LOCKING	LOCKING
1 piece; 2/6 lbs	1 piece; 18 lbs
NHCASPS	NHCASPSLK
\$6.99	\$7.49

Pipeline RACKS & MERCHANDISERS

PIPELINE OUTRIGGER AND WALL UNITS

Units and accessories have an anthracite grey or a gloss white finish, where noted.



Outrigger Wall Unit

Set of two 96"H slotted uprights (1/2" slots on 1" centers).
Can be spaced 24" or 48" on Centers; 1 piece; 30 lbs.

Anthracite Grey **NHPSOR**; **\$153.99** Gloss White **NHPSORWH**; **\$153.99**

Freestanding Merchandiser

94" high x 20" deep x 48" wide. Slots (1/2" slots on 1" centers) are on each upright; 1 piece; 38, 28, 12 / 90, 90, 12 - 3 ctns.

Anthracite Grey **NHPSFS96**; **\$420.49**
Gloss White **NHPSFS96WH**; **\$420.99**

ACCESSORIES FOR OUTRIGGERS AND WALL UNITS



Extension Kits for Freestanding Merchandiser

Connect & stabilize two units together.
• Guarantees easy alignment for the 24" or 48" accessories between 2 units.
• Kits include 2 spacers. Can be used on top & bottom or along back.

Anthracite Grey - **NHPSFSKT24** - 24" w 7 lbs; **\$30.49**
Gloss White - **NHPSFSKT24WH** - 24" w 7 lbs; **\$30.49**

Anthracite Grey - **NHPSFSKT48** - 48" w 10 lbs; **\$34.99**
Gloss White - **NHPSFSKT48WH** - 48" w 10 lbs; **\$34.99**



Hangrails

Mounts on rear facing slots of uprights.
2 pieces/carton.

48" wide; 14 lbs:
Anthracite Grey - **NHPSORHB48** **\$90.99**
Gloss White - **NHPSORHB48WH** **\$96.49**
24" wide; 10 lbs:
Anthracite Grey - **NHPSORHB24** **\$83.99**
Gloss White - **NHPSORHB24WH** **\$83.99**



Hangrail with 1 Faceout

Works on forward facing slots of uprights of Freestanding Merchandiser only.
24" wide w/12 3/4" faceout;
2 pieces/carton; 11/17 lbs.

Anthracite Grey - **NHPSORFO24N**
Gloss White - **NHPSORFO24NWH**
\$100.99



Hangrail with 2 Faceouts

Works on forward facing slots of uprights of Freestanding Merchandiser only.
48" wide w/12 3/4" faceouts;
2 pieces/carton; 21/31 lbs.

Anthracite Grey - **NHPSORFO48N** **\$161.99**
Gloss White - **NHPSORFO48N WH** **\$161.99**



Hangrail with 1 Faceout

Mounts on rear facing slots of uprights.
24"W with one 12" long faceout;
2 pieces/carton; 18/20 lbs.

Anthracite Grey - **NHPSORFO24**
Gloss White - **NHPSORFO24WH**

\$134.49



Hangrail with 2 Faceouts

Mounts on rear facing slots of uprights.
48"W with two 12 3/4" long faceouts;
2 pieces/carton; 29/37 lbs.

Anthracite Grey - **NHPSORFO48** **\$165.49**
Gloss White - **NHPSORFO48WH** **\$165.49**



Add On Arms

3" Long
1 piece; 1 lb
Anthracite Grey - **NHPSCLP03**
Gloss White - **NHPSCLP03WH**
\$15.99

16" Long
2 pieces; 2 lbs
Anthracite Grey - **NHPSFO13**
Gloss White - **NHPSFO13WH**
\$57.99

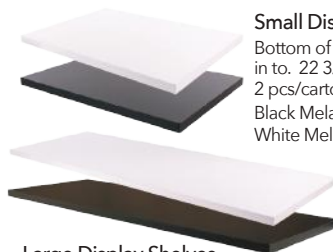

Large Display Shelves

Bottom of shelf includes a slot for brackets to lock in to and metal support bar to handle heavy loads; 46 3/8"W x 15 3/4"D;
2 pcs/carton; 46 lbs.

Black Melamine - **NHPSORSLF48-ML** **\$132.99**
White Melamine - **NHPSORSLF48MLWH** **\$125.99**

Small Display Shelves

Bottom of shelf includes a slot for brackets to lock in to. 22 3/8"W x 15 3/4"D;
2 pcs/carton; 20 lbs.

Black Melamine - **NHPSORSLF24-ML**
White Melamine - **NHPSORSLF24MLWH**

\$60.99



Self Brackets

Left & right (set) for use w/ shelves
2 set (4 pcs); 4 lbs.

Anthracite Grey - **NHPSORKB**
Gloss White - **NHPSORKBWH**

\$29.49

RACKS & MERCHANDISERS Pipeline Accessories

ACRYLIC SIGN HOLDERS

Sign holder with swedge stem and C style clamp.
Fits pipeline racks & costumers.



5"H x 7"W
includes clamp; 1 piece; 1 lb.
Anthracite Grey - NHPSPJ57P24;
\$13.49
Gloss White - NHPSPJ57P24WH;
\$13.49



7"H x 11"W
includes clamp; 1 piece; 1lb.
Anthracite Grey - NHPSPJ711P24;
\$19.44
Gloss White - NHPSPJ711P24WH
\$15.99

WALL MOUNT FACEOUTS



4 1/2" Long
1 piece; 1 lb
Anthracite Grey - NHPSSWM04 **\$10.99**
Gloss White - NHPSSWM04WH **\$10.99**



10" Long
1 piece; 1 lb
Anthracite Grey - NHPSSL10 **\$14.99**
Gloss White - NHPSSL10WH **\$14.99**

SLATWALL FACEOUTS



4 1/2" Long
1 piece; 1 lb
Anthracite Grey - NHPSSW04 **\$9.12**
Gloss White - NHPSSW04WH **\$8.52**



10" Long
1 piece; 1 lb
Anthracite Grey - NHPSSW10 **\$11.16**
Gloss White - NHPSSW10WH **\$11.49**

PIPELINE TABLES & FLOOR DISPLAYERS



Large Nesting Table

Frame w/top 62"w x 34"d x 32"h;
1 pc; 18, 42 lbs (2 ctns);
Anthracite Grey - NHPNTLSET;
\$328.99
Gloss White - NHPNTLWHSET;
\$328.99

Large Nesting Table



Small Nesting Table

Frame w/top 48"w x 24"d x 24"h;
1 pc; 39, 41 lbs (2 ctns);
Anthracite Grey - NHPNTSSET;
\$231.99
Gloss White - NHPNTSWHSET;
\$231.99

Table Topper

Frame w/top 54"w x 14"d x 13 1/2"h;
Dark Brown Melamine table top;
1 pc; 6, 29 lbs (2 ctns);
Anthracite Grey - NHPNTTOPSET
\$128.99

Tower Table



Frame w/top
14"w x 14"d x 40"h;
Dark Brown Melamine table
top;
1 pc; 36, 81 lbs (2 ctns);
NHPSTTSET **\$166.49**

Frame w/top
28"w x 16"d x 18"h;
Dark Brown Melamine table top;
1 pc; 39, 17 lbs (2 ctns);
NHPSDTSET **\$161.49**

Display Table



Black Pipeline RACKS & MERCHANDISERS

BLACK ECONOMY PIPE RACKS A matte-black pipe rack collection for less



- 1 Ballet Bar Rack - black**
48" w x 23.5" d; 48-72" h adjustable; 1 piece; 34/37 lbs; **NHPLKBB \$132.32**
* Casters available
- 2 Round rack - black**
Round rail-36" dia; base-42" d; 46" h (not adjustable); includes casters; 1 piece;
20/44, 15 lbs (2 ctns); **NHPLRR \$303.00**
- 3 Half-round rack - black**
35" w / height adjustable from 54"; 1 piece; 20, 8/21 lbs (2 ctns);
NHPLHR \$129.60
- 4 4-way pipe rack - black**
30" base; 16" arms; 48-72" h; 1 piece; 40, 19 lbs (2 ctns); **NHPLK4 \$206.97**
* Casters available
- 5 2-way pipe rack - black**
24.5" w x 18.5" d base; 16" arms; 48-72" h; 1 piece; 18, 4 lbs (2 ctns); **NHPLK2 \$96.81**
* Casters available
- 6 H rack - black**
48" w x 30" d base; height 48-72"; (*Grid topper sold separately*); 1 piece; 50,
17/21, 7 lbs (3 ctns); **NHPLKH \$209.43**
* Casters available
- 7 Outrigger pipe rack - black**
90" h; 1/2" slots on 1" center; stands 3.5" from wall; 2 pieces; 19 lbs;
NHPLKF5 \$131.80
- 8 Display rack with 3 wood trays - black**
24" L x 24" W x 52" H; (3) adjustable wood trays measure 17" L x 10" W x 3" h, are
finished in cinnamon melamine & rotate to a 45° or 90° angle; 1 piece; 39/70 lbs;
DTB242452BP \$347.72

BLACK ECONOMY PIPE RACK ACCESSORIES matte black finish



C Hangrail for Outrigger rack - black
24" w; 12" deep; 1 piece; 20/21 lbs;
NHPL12CH \$18.53

3" Casters - black
3" casters, two with brakes and
two without; 4 pieces; 5 lbs;
NHPLCASTER \$46.66



NHPLCASTER



**12" Hangrail bracket for
Outrigger rack - black**
1 piece; 22 lbs; **NHPLCR12
\$7.26**



**12" Faceout w/ ball end for
Outrigger rack - black**
1 piece; 19 lbs;
NHPLRDW12 \$5.18



**3" Hangrail bracket for
Outrigger rack - black**
1 piece; 14 lbs;
NHPLCR3 \$5.18

RACKS & MERCHANDISERS Ladder Systems

BLACK LADDER SYSTEM

The extremely versatile Ladder System allows you to vary your merchandising techniques to suit any retail environment.

The black finish tower ladders measure 73"H and can be accessorized with specialized hangrails, shelves, face-outs and waterfalls (sold separately).

Ships truck.
Some assembly required.

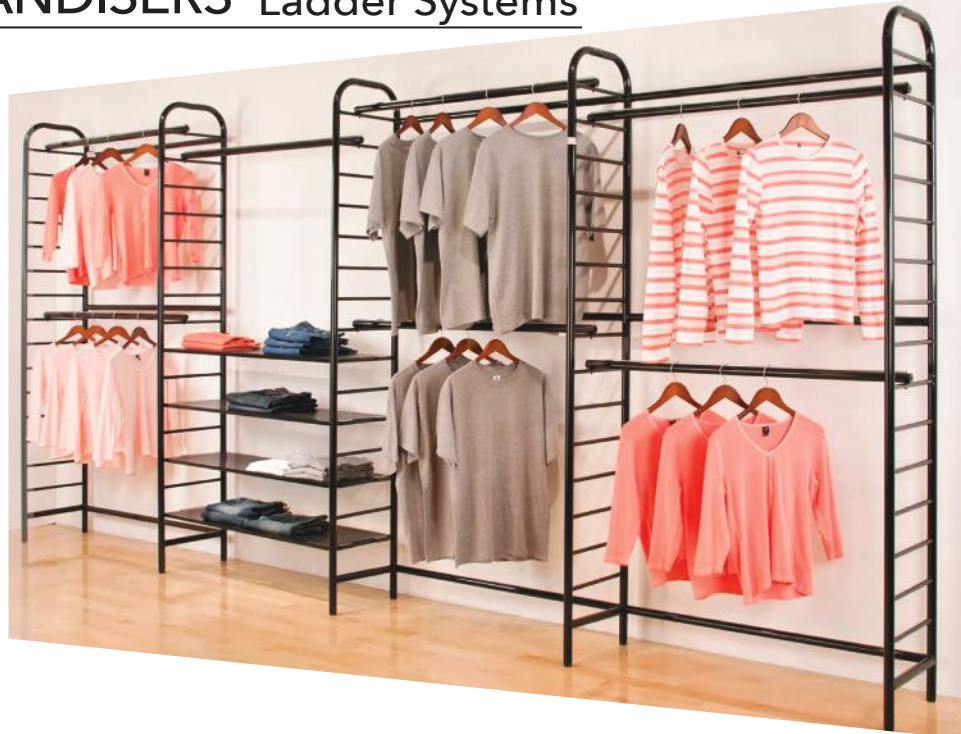

1 A305B



2 A304B

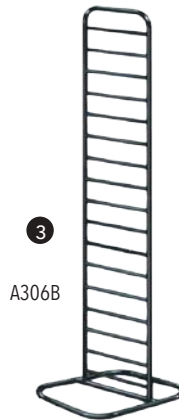

3 A306B



4 A301B



5 AT66B



6 AT77B



7 ARL48B



8 AF12B



9 NHACT4



10 AF7B

- 1 **Double Two-Tier Wall Unit - black**
16"W x 96"L x 88"H; 1 piece; 92 lbs; **must ship truck**; A305B \$310.49
- 2 **Single Two-Tier Wall Unit - black**
16"W x 48"L x 88"H; 1 piece; 58/90 lbs; **must ship truck**; A304B \$202.99
- 3 **Tower Ladder - black**
14"W x 73"H; 18" x 22" base; 1 piece; 23 lbs; A306B \$100.49
- 4 **Double Center Floor Rack - black**
28"W x 48"L x 58"H; 1 piece; 57 lbs; **must ship truck**; A301B \$188.99
- 5 **Top Shelf - black** Fits A301B
Epoxy coated perforated steel; 25" x 48"; 1 piece; 18/26 lbs; AT66B \$98.99

- 6 **Interior Shelf - black** Fits all ladders
Epoxy coated perforated steel; 14" x 45"; 1 piece; 11/15 lbs; AT77B \$53.99
- 7 **Straight Hangrail - black**
With attached 1/4" chrome wire protector; 48"; 1 piece; 4/5 lbs; ARL48B \$16.49
- 8 **12" Faceout - black**
Rectangular tubing; 1 piece; 2 lbs; AF12B \$6.99
- 9 **Caster - black**
4" castor w/ 1"L & 5/16" dia. stem; 150 lb. capacity; 1 piece; 2/2 lbs; NHACT4 \$9.07
- 10 **7-Cube waterfall - black**
16" L; 1/2" x 1 1/2" thick; 1 piece; AF7B \$9.49

Designer 400 RACKS & MERCHANDISERS

DESIGNER 400 SERIES

style #	\$	qty	description / size	wgt
---------	----	-----	--------------------	-----

Chrome

RV24	9.49	1	Attaches to rectangular or square tubing 1/2" on 1" center	5/9
------	------	---	--	-----

RV24 - A bracket made of rectangular tubing that supports DA224 (13" x 24") Duron shelves. The bracket has a clamp that attaches to an upright of a rectangular or square tubing rack. Tightening screws included.

TWIST ON SHELF SUPPORT
Converts any 4 arm rack to display folded and hanging apparel



RV24 for Square or Rectangular Tubing



K410B	171.49		Black shelves	
K410GY	173.99	1	Grey shelves	9/11, 26 lbs (2 ctns)
K410W	171.49		White shelves	

57" H, 1" matte black square tubing frame; (8) 12" shelf brackets; (4) 13" x24" shelves; includes casters and one T-stand



K410B



K410GY



K410W

K411B	278.99		Black shelves	9/11,
K411GY	288.99	1	Grey shelves	9/11, 41 lbs (3 ctns)
K411W	278.99		White shelves	

54" H, 1" matte black square tubing frame; (16) 12" shelf brackets; (8) 13" x24" shelves; (2) 36" x 1 1/4" round hangrails



K411GY



K411B



K411W

K400B	182.49		Black shelves	
K400GY	186.49		Grey shelves	9/11, 32 lbs (2 ctns)
K400W	182.49	1	White shelves	

57" H, 1" x 2" matte black rectangular tubing frame; (8) 12" shelf brackets; (4) 13" x24" shelves; includes casters; two 16" arms adjust to 70" H



K400GY



K400B



K400W

RACKS & MERCHANDISERS Showcases

ECONOMY IMPORT SHOWCASES



FULL VISION SHOWCASES

Assembly required



style #	\$	qty	description	size	wgt
Includes 2 glass shelves and shelf brackets:					
SC4B	224.76	1	Black	38"H x 18"D x 48"L	80/90, 30, 10, 10 lbs; (4 ctns)
SC4W			White		
SC4M			Maple		
SC4C			Cherry		
SC6B	318.36	1	Black	38"H x 18"D x 72"L	100, 30, 30, 20 lbs; (4 ctns)
SC6W			White		
SC6M			Maple		
SC6C			Cherry		



CORNER FILL-IN

Fill-in counters enable you to create various counter configurations and display merchandise.

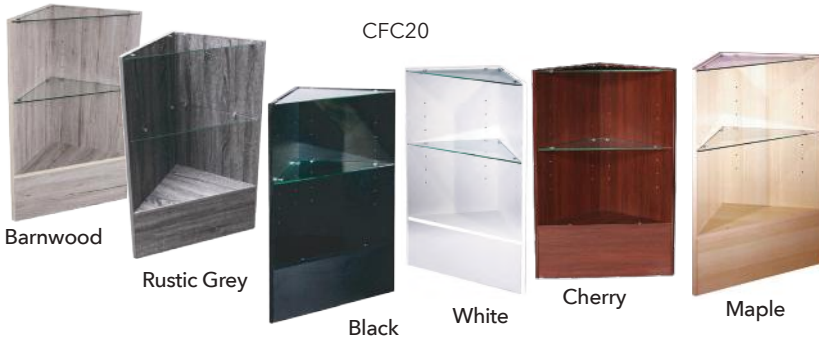

CFC20	134.14	1	Corner fill-in - includes 2 glass shelves	38"H x 18"D x 18"L	36/75
-------	--------	---	---	-----------------------	-------

Specify Barnwood, Rustic Grey, Black, White, Maple or Cherry for CFC20 above and SCPC18 below

PENTAGONAL FILL-IN



SCPC18	138.67	1	Pentagonal fill-in - includes 2 glass shelves	38"H x 18"D x 18"L	30, 18 lbs; (2 ctns)
--------	--------	---	---	-----------------------	----------------------------

REGISTER STAND

Perfect as a stand alone or with a wrap counter and corner fill-in unit



Includes 1 (4"H) drawer & 1 wood shelf Well Top (w/6" well):					
RS24BW			Barnwood		
RS24RG			Rustic Grey		
RS24B	134.52	1	Black	38"H x 18"D x 24"L	81
RS24W			White		
RS24M			Maple		
RS24C			Cherry		

Shelves RACKS & MERCHANDISERS

style #	\$	qty	description /size	wgt
W1224	84.99		White / 12"x24"	
B1224	84.99	8	Black / 12"x24"	45
M1224	80.49		Maple / 12"x24"	
W1248	85.99		White / 12"x48"	
B1248	85.99	4	Black / 12"x48"	45
M1248	81.99		Maple / 12"x48"	
W1448	107.49		White / 14"x48"	
B1448	107.49	4	Black / 14"x48"	50
M1448	101.49		Maple / 14"x48"	

MELAMINE SQUARE EDGE SHELVES

B1224



W1224

- Sturdy 3/4" thick
- Durable, easy to clean
- Finished on all 6 sides

M1224



METAL SHELF OVERLAY RETAIL SIGNS "Metal Shelf Talkers" w/framed front

Metal shelf signs

Ledge piece is 6" front to back;
sign holder piece is 6 1/2" across

NHSTCH	9.72		High polished chrome	
NHSTV	7.00	1	Metal	1

Accepts 6 1/2"W x 1 1/2"H paper inserts, (not included)



NHSTCH



NHSTV



All sizes packed 4 of one size and color per carton:

13" Shelves - to be used with 12" brackets:

OPEN BOTTOM

13" x 24"

DA224B	44.49	4	Black	9/11
DA224W	47.49		White	

13" x 48"

DA248B	87.99	4	Black	29
DA248W	82.99		White	



DA224B

DURON BULLNOSE SHELVES

15" Shelves - to be used with 14" brackets:

OPEN BOTTOM

DA448B	110.49	4	15" x 48" (black)	27/30
DA448W	110.49		15" x 48" (white)	27



DA224W

RACKS & MERCHANDISERS Displayers

DUMP BIN Adjustable base deck. Casters optional



white black

GTC48

chrome

BIN2

FOLDING SQUARE BASKET



style #	\$	qty	description / size	wgt
All styles measure 38" x 38" x 34 3/4"				
GTC48B	149.43		BLACK	80
GTC48W	149.43	1	WHITE	Ships UPS ground
GTC48C	256.49		CHROME	
<hr/>				
BIN2	47.17	1	BLACK 30" x 18" x 1 8"	11/14
<hr/>				
Impulse Tower w/4 Bowls: Clear polycarbonate bowls with metal grey powdercoated base and pole. Acrylic signholder top included; 65 1/2" H;				
IMPULSE41P	119.49	1	bowls: 12 1/8" dia; 6 1/8" depth base: 16" dia. signholder: 7" x 5 1/2"	22/27
<hr/>				
Wire Spinner Rack 4 adjustable spinning tiers with 16 hooks; Black;				
NHSDR	110.15	1	Heavy duty plastic base and sign holder for signs 8 1/2 x 11" and 1mm thick; Dims: 24" footprint; 66" high; hook length 5"	14/24
<hr/>				
3-Tier Round Impulse Bin: 45"H x 18"W; w/ 3 round baskets each measuring 7"H x 18"W				
DDB4518B	89.99	1	Black	23/23
DDB4518W	85.54		White	
<hr/>				
3-Tier Square Bin: Black; 19"W x 47"H; baskets – 6 1/2"H x 16"W each				
DDB1947B	121.38	1		30/30
<hr/>				
4-Tier Round Display Bin: Black; 54 1/2"H x 12"W; w/ 4 circular baskets measuring 6 1/2"H x 12"W				
DDB1254B	107.44	1		19/19
<hr/>				
Black floor display rack with 4 separate brushed chrome wire rotating baskets. Rack measures 66"H x 22"W; Each individual basket measures 21 3/4"W x 7"D				
IMPULSE4W	115.99	1		10/38

IMPULSE41P

IMPULSE POSTS

Great for small or end of season clearance items near the register



Holder for
8.5"x11" signs

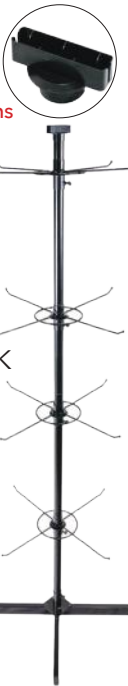

WIRE SPINNER RACK

NHSDR

3-TIER BINS



DDB4518B



DDB4518W

DDB1947B



DDB1254B



4-TIER BINS

IMPULSE4W

STANDARD SLATWALL PANELS

Laminated, 3/4" medium density fiber board.
 Optional inserts must be installed at time of manufacturing for an additional charge (see inserts on following page /102).
 4' high x 8' long panels. Each panel weighs between 80-100 lbs., and must ship via truck.



Panels made in the USA



Crate charge on 1-34 sheets is \$75.00.



Slatwall Orientation /Horizontal



CALL or visit online CHAT at nahanco.com for more information.
 Our friendly Customer Service reps are based in the USA and ready to assist.

SOLIDS / MIRROR



WHITE
 SW48W
 \$88.99



BLACK
 SW48BK
 \$93.99



LIGHT GREY
 SW48LG
 \$90.99



DARK GREY
 SW48G
 \$90.99



MIRROR
 SW48MIR
 \$363.99

Actual colors may vary slightly from images

WOOD GRAINS



OAK
 SW48O
 \$117.99



MAHOGANY
 SW48M
 \$96.99



HARDROCK MAPLE
 SW48HM
 \$90.99



WEATHERED BARNWOOD
 SW48WB
 \$97.99



ASH BARNWOOD
 SW48AB
 \$97.99

All prices are per panel with No Insert (NI) | Lead time is 2-3 weeks, with and with out inserts

WALL SYSTEMS Slatwall Panels



STANDARD SLATWALL PANELS

Actual colors may vary slightly from images

RUSTICS /textured



ASPEN OAK
SW48AO
\$97.99

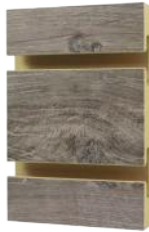

STORMY OAK
SW48SO
\$97.99



TIMBERCREEK OAK
SW48TCO
\$97.99



RECLAIMED BARNWOOD
SW48RB
\$97.99



CAMPFIRE ASH
SW48CA
\$97.99



WHITEWASHED FENCE
SW48WWF
\$97.99

SLATWALL INSERTS

Order slatwall panels with or without inserts. If inserts are desired, note that they levy an additional charge and must be installed at the time of manufacturing.

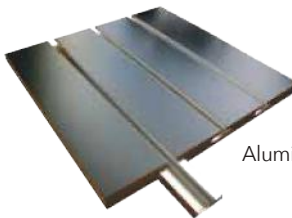

Metal inserts

Aluminum / AI

Black Aluminum / BAI



Black panel w/ Black Aluminum Inserts

Metal inserts add strength and enhance the appearance of slatwall panels.

NOTES:

All prices are per panel with No Insert / NI

Lead time is 2-3 weeks, with and without inserts

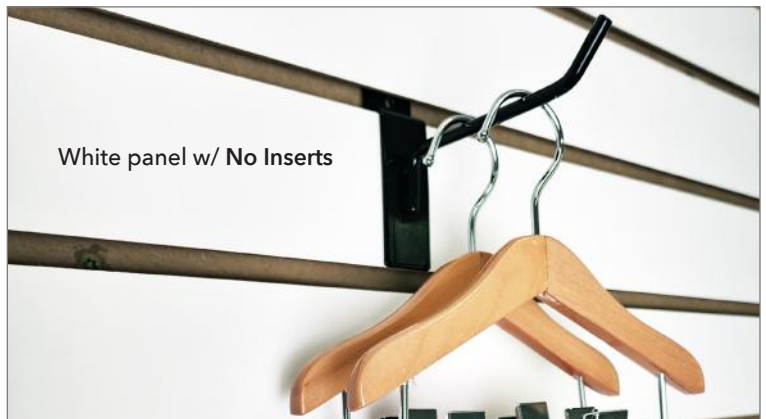

White panel w/ No Inserts

Slatwall Accessories WALL SYSTEMS

style #	\$	qty	description	size	wgt
XT4	14.69		Chrome		
XT4B	6.49	12	Black	4"	2
XT4W	6.49		White		
XT6	14.69		Chrome		
XT6B	7.49	12	Black	6"	2
XT6W	7.49		White		
XT8	14.70		Chrome		
XT8B	9.07	12	Black	8"	3
XT8W	9.07		White		
XT10	14.70		Chrome		
XT10B	9.99	12	Black	10"	3
XT10W	9.99		White		
XT12	16.66		Chrome		
XT12B	10.99	12	Black	12"	4
XT12W	10.99		White		

Mounting plate width: 3/4" (for all hook styles listed above)

Hook widths: Chrome - 3/16" w; Black /White - 1/4" w

XTB	6.49		Black		
XTW	6.49	12	White	1"W x 3 1/4"H	2
XTH	11.07		Chrome		

SWFRC	2.99	1	Chrome	3"	1/2
-------	------	---	--------	----	-----

SW6	3.49		Chrome	6"	1/2
SW12	9.79	1	Chrome	12"	
SW12B	3.49		Black	12"	1/6
SW12W	3.49		White	12"	

HW5H	7.00	1	Chrome	16"	2/6
------	------	---	--------	-----	-----

RWA9	8.42	1	Chrome Rectangular tubing	Adjusts from 9" to 12" to 15" long	2
------	------	---	------------------------------	--	---

RW12	7.26		Chrome	12"	1/6
EBLR3	3.99		Black	12"	
EWHR3	4.15	1	White	12"	
RW6	4.15		Chrome	6"	1/2

SW5HB	5.49		Black		
SW5H	8.71	1	Chrome	16"	2/6
SW5HW	5.49		White		

RW5HB	5.96		Black		
RW5H	7.99	1	Chrome	17 1/4"	2/6

SW6BC	6.35		Chrome		
SW6BB	4.15	1	Black	16 5/8"	2/6
SW6BW	4.15		White		

RW7B	5.99	1	Black	16 5/8"	2/6
------	------	---	-------	---------	-----

J2387	33.17	1	CLEAR Holds 36 - 2" cards (not included)	12" W x 12 1/2" H	2/6
-------	-------	---	--	----------------------	-----

SW122	26.31	12	Brushed chrome	3 7/16"H x 2"L	2/5
-------	-------	----	----------------	-------------------	-----

HG100	63.34	100	White	2" clip	3
HG101	63.34	100	Black	2" clip	3

SLATWALL HOOKS

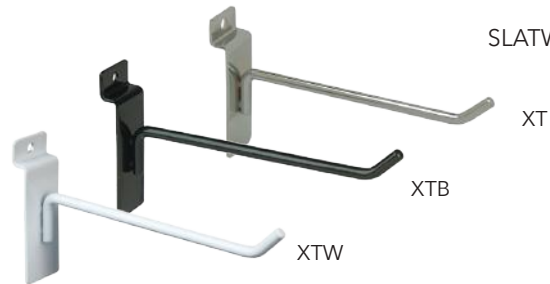

XTH

SWFRC

SLATWALL FACEOUTS

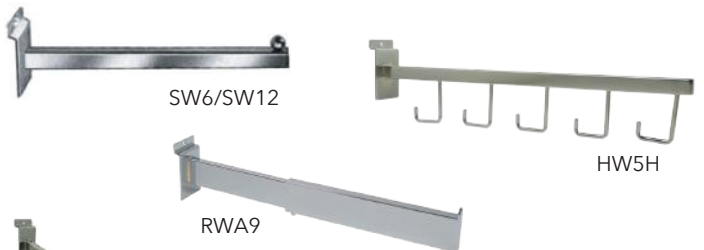

SW6/SW12

HW5H

RWA9

RECTANGULAR TUBING



Square Tubing
5 Hook Waterfall
SW5H

Rectangular Tubing
5 Hook Waterfall
RW5H

RW12/EBL/EWH/RW6

Rectangular Tubing
7 Cube Waterfall
RW7B

SLATWALL WATERFALLS

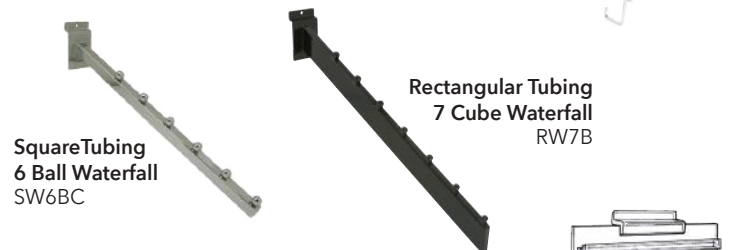

Square Tubing
6 Ball Waterfall
SW6BC

SLATWALL JEWELRY DISPLAYER

See page 137
for jewelry cards

Slatwall
Jewelry Card
Displayer
J2387



SLATWALL CLIPS



SW122

HG100

HG101

WALL SYSTEMS Slatwall Accessories



SHELF BRACKET
Chrome, black or white available

- See page 99 for shelving -



ADJUSTABLE SHELF BRACKET
12" - chrome
14" - chrome



SLATWALL SUPPORT ARMS
3380-76 for 8" & 10" brackets
3380-77 for 12" & 14" brackets
3380-78 for 12" rectangular tubing



3" & 12" RECTANGULAR HANGRAIL
Chrome, black or white available



ROUND HANGRAIL BRACKET

- See page 112 for tubing -



RECTANGULAR TUBING 'U' HANGRAIL



ROUND TUBING 'U' HANGRAIL



SCARECROW DISPLAYER



MILLINERY DISPLAYER
3" diameter



FOAM PAD
FPMC



SLATWALL CAP MERCHANDISER
Holds 12 hats



REVOLVING BELT/TIE DISPLAY

SW500

style #	\$	qty	description	size	wgt
SW8KB	2.99		Chrome		
SW8KBB	1.89		Black	8"	2/7
SW8KBW	2.49		White		
SW10KB	4.61		Chrome		
SW10KBB	2.10		Black	10"	1/6
SW12KB	4.89	1	Chrome		
SW12KBB	2.30		Black	12"	1/6
SW12KBW	2.30		White		
SW14KB	5.59		Chrome		
SW14KBB	2.99		Black	14"	1/6
SW14KBW	2.99		White		
SWAJ12	5.49	1	CHROME	12"	1/6
SWAJ14	4.92			14"	1/6
3380-76	6.35			7 3/4"	
3380-77	6.35	1	CHROME	11 1/2"	1/3
3380-78	4.99			11 1/2"	
SWFB	5.57		CHROME	12"	2/7
SWFBB	4.49		BLACK	12"	2/7
SWR2	3.49	1	CHROME	3"	1/3
SW/RT	5.99	1	CHROME	12"	1/6
SWR81	20.22		CHROME	22"W x	
EMABR81	18.01	1	BLACK	11" D	5/21
EMTWR81	18.01		WHITE		
SW681C	18.01		CHROME	23"W x	
SW681B	17.37	1	BLACK	12" D	5/21
SW681W	17.37		WHITE		
SWT	20.22	1	CHROME	Adjusts	
EBLT	14.49		BLACK	20 1/2" to	4/21
SWML	2.99	1	CHROME		
SWMLB	2.99	1	BLACK	4 1/2" H x	1/3
SWMLW	2.30	1	WHITE	8" D	
FPMC	7.49	10	GREY	3"	1
BCDSW	5.49		CHROME	8 1/2"	
BCDSWB	5.44	1	BLACK	x 14" x 2"	2/6
BCDSWW	4.99		WHITE		
SW500	38.65	1	CHROME	11" x 17"	1/6
				12 - 4" hooks	

Slatwall Accessories WALL SYSTEMS

style #	\$	qty	description	size	wgt
NHPSSW04	9.12	1	Anthracite Grey	4 1/2" L	1
NHPSSW04WH	8.52	1	Gloss White	4 1/2" L	1
10" Faceouts:					
NHPSSW10	11.16	1	Anthracite Grey	10" IL	1
NHPSSW10WH	11.49	1	Gloss White	10" IL	1
Matte Black Faceouts:					
SWP12B	11.15	1	Matte black faceout	12" L	2
Matte Black Waterfalls:					
SWP6NB16	16.85	1	6-ball	16 1/2" IL	4
SWP5H16	18.27	1	5-hook	16 1/2" IL	4
2326	21.99	1	1/8" ACRYLIC	8" W x 4" D	1/3
2035	8.99	1	1/8" ACRYLIC	7w x 11"h	2/7
2385	27.60	1	1/8" ACRYLIC	8" W x 10 1/4" H	2/7
850S	2.49	1	ACRYLIC	4" x 10" w/ 2" tall sign channel at front	2/3
2020S	1.49	1	ACRYLIC	4" x 10"	2/3
2200S	4.49	1	ARYLIC 45° downslant swivels 180°	2 3/4"W x 9"D	1/3
2476	18.99	1	ACRYLIC	17" W x 7" H x 3 1/2"D	1
ACR26SW	4.99	1	ACRYLIC	4 x 9" 8 1/2 x 11"	2/3
ACR28SW	9.99	1	ACRYLIC	8 x 10"	1/7
ACR102	12.99	1	ACRYLIC	8 x 10"	1/7
ACR140	24.99	1	3/16" ACRYLIC	12"L x 9"W x 2"D	2/6

PIPELINE SLATWALL FIXTURES

Coordinates with other pipeline store fixtures (pages 91-94)

ANTHRACITE GREY & GLOSS WHITE FIXTURES

NHPSSW04



NHPSSW04WH



NHPSSW10WH

NHPSSW10

MATTE BLACK FIXTURES



SWP12B



SWP6NB16



SWP5H16

ACRYLIC SLATWALL FIXTURES



SIGN HOLDER

2035



2326

JEWELRY DISPLAY BAR



JEWELRY CARD DISPLAYER

Holds twenty 2" cards

See page 137 for cards

2385



850S

MEDIA SHELF

SLATWALL SHOE SHELF



2020S



ADJUSTABLE SHOE SWIVEL

2200S

SLATWALL HANGER

Extends 3" from wall



2476



ACR26SW

BROCHURE HOLDERS



ACR28SW

SLATWALL MIRROR



ACR102

SLATWALL TRAY

ACR140



WALL SYSTEMS Grid Wall & Accessories

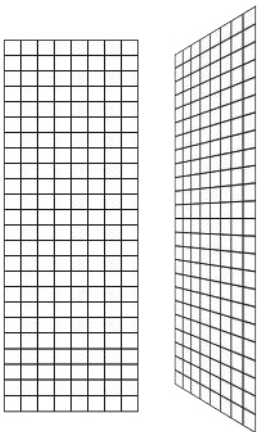

GRID WALL - 1/4" Wire
Uses grid wall accessories only

SLATGRID PANELS
Uses either grid wall or slatwall accessories **3 Panels per Carton**

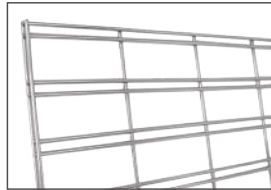

Slatgrid - Chrome
STG

8' lengths must ship via truck or oversized UPS 

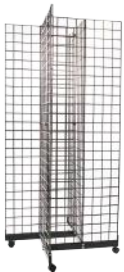

4BA

FOUR WAY BASE
Requires four panels and 12 grid-to-grid connectors. Includes casters



3TB



TRIANGLE BASE
Requires three panels and nine grid-to-grid connectors. Includes casters

GONDOLA BASE
Requires four panels and nine grid-to-grid connectors



G48



LEGS FOR GRID



GL24

CGW7



GRID-TO-GRID
For 1/4" wire. Connects grid panels at any required angle



WTEWB

WALL BRACKET
For mounting grid wall panels to the wall

style #	\$	qty	description	size	wgt
GW26	105.49	3	CHROME		
BLK26	97.99	3	BLACK	2'W x 6'H	55
WTE26	97.99	3	WHITE		
GW28	144.99	3	CHROME		Truck/UPS
BLK28	119.99	3	BLACK	2'W x 8'H	66/90
WTE28	119.99	3	WHITE		
STGC26	135.99	3	CHROME		
STGB26	106.99	3	BLACK	2'W x 6'H	47
STGW26	106.99	3	WHITE		
STGC28	169.99	3	CHROME		Truck/UPS
STGB28	141.99	3	BLACK	2'W x 8'H	52/90
STGW28	141.99	3	WHITE		
GW4BA	50.49		CHROME		
BLK4BA	43.49	1	BLACK	36" x 36"	11
WTE4BA	43.49		WHITE		
GW3TB	45.49		CHROME		
BLK3TB	41.49	1	BLACK	24"	10/11
WTE3TB	41.49		WHITE		
GWG48	49.49		CHROME		
BLKG48	39.99	1	BLACK	48 x 24"	12
WTEG48	39.99		WHITE		
GL24C	24.90		CHROME		
GL24B	21.99	1 pair	BLACK	24" H x 24" L	7
GL24W	21.99		WHITE		
CGW7	1.62		CHROME		
CBLK7	1.62	1	BLACK	N/A	1
CWTE7	0.99		WHITE		
GWWB	3.49		CHROME		
BLKWb	3.49	1	BLACK	3"	1
WTEWB	2.49		WHITE		

Grid Wall Accessories WALL SYSTEMS

style #	\$	qty	description	size	wgt
GWH4C	9.49	12	CHROME	4"	1/3
GWH4B	9.99		BLACK		
GWH4W	9.99		WHITE		
GWH6C	9.49	12	CHROME	6"	1/2
GWH6B	9.99		BLACK		
GWH6W	9.99		WHITE		
GWH8C	10.49	1	CHROME	8"	1/2
GWH8B	9.99		BLACK		
GWH8W	9.99		WHITE		
GWH10C	10.49	1	CHROME	10"	1/2
GWH10B	9.99		BLACK		
GWH10W	9.99		WHITE		
GW11	4.55	1	CHROME	12"	3/6
BLK11	3.80		BLACK		
WTE11	4.95		WHITE		
RG12	3.26	1	CHROME	12"	2/7
BLKR3	3.25		BLACK		
WTER3	1.99		WHITE		
			<i>while supplies last</i>		
GW12	3.35	1	CHROME	12"	2/7
BLK12	3.35		BLACK		
GW5H	5.31	1	CHROME	5 hook	2/6
BLK5H	5.31		BLACK		
WTE5H	5.31		WHITE		
GW7B	5.99	1	CHROME	7 ball	2/10
BLK7B	4.60		BLACK		
WTE7B	4.69		WHITE		
GWFRFC	2.99	1	CHROME	3"	1/3
GWFRB	2.49		BLACK		
GWML	2.99	1	CHROME	4 1/2" H 8" Deep	2/7
BLKML	2.99		BLACK		
FPMC	7.49	10	GREY	3"	1
KHG684	18.99	1	CHROME	52 1/4"	3/21
KHG681	17.99	1	CHROME	19 1/4 x 11"	3/21
BLHG681	17.49		BLACK		
GW12KB	3.89	1	CHROME	12"	2/7
BLK12KB	2.99		BLACK		
WTE12KB	2.99		WHITE		
GW14KB	3.25	1	CHROME	14"	2/6
BLK14KB	2.99		BLACK		
HML4MAB	5.57	1	BLACK	4"	1/3
GWRT	5.49	1	CHROME	12"	2/7



GRID WALL HOOKS
Specify Chrome (C), White (W), or Black (B)



**12" SQUARE TUBING
FACE OUT**



GRID WALL FACE OUTS

**12" RECTANGULAR TUBING
FACE OUT**



**12" ROUND TUBING
FACE OUT**

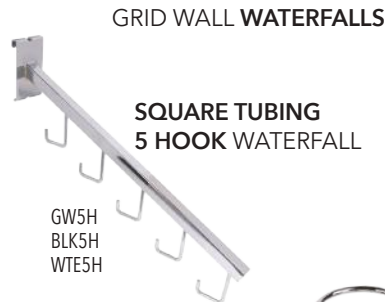

GRID WALL WATERFALLS

**SQUARE TUBING
5 HOOK WATERFALL**



**SQUARE TUBING
7 BALL WATERFALL**



**MILLINERY
DISPLAYER**



**FOAM PAD
FPMC**



**GARMENT HOOK
GWFRFC**



STRAIGHT HANGRAIL



'U' HANGRAIL

GRID WALL SHELF BRACKETS

- See page 99 for shelving -

HANGRAIL BRACKETS

For 1/2" x 1 1/2" rectangular tubing

- See page 112 for tubing -

12" ROUND HANGRAIL BRACKET

For 1 1/4" round tubing

WALL SYSTEMS Grid Wall Accessories



GRID WALL CAP MERCHANDISER
Holds approximately 12 hats



BCDGWB



GW122

GRID WALL CLIPS



HS101

TRIANGULAR SHELF

BLKS90

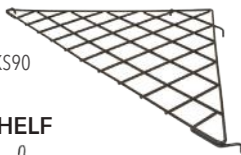

SLANT SHELF

BLKS91

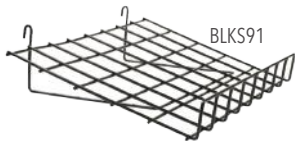

STRAIGHT SHELF

GWS93



INJECTION MOLDED SHOE SHELF

JGR410ST



ACRYLIC SIGN HOLDERS

HPSG



STANDARD BASKETS

Fits Slatwall, Grid Wall and Pegboard



BSK11B

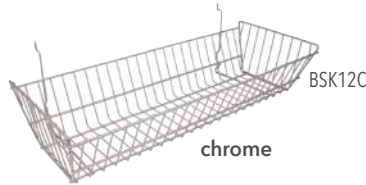

BSK12C

chrome



black

BSK13B



white

BSK14B



BSK15W

style #	\$	qty	description	size	wgt
BCDGW	6.35		CHROME		
BCDGWB	6.35	1	BLACK	8 1/2 x 14 x 2"	1/7
BCDGWW	6.35		WHITE		
GW122	35.93	12	BRUSHED CHROME	3 7/16" H	2/3
HS101	42.93	100	BLACK	2"	8
BLKS90	10.49	1	BLACK	24 x 24 x 34 1/2"	6/21
GWS93	24.36		CHROME		
BLKS93	19.99	1	BLACK	15 x 24"	6/21
WTES93	21.51		WHITE		
GWS91	21.99	1	CHROME	15 x 24"	6/21
BLKS91	19.49		BLACK		
JGR410ST	4.99	1	STYRENE	4 x 10"	1/3
CLEAR ACRYLIC					
HPSG57V	6.09		Vertical	5 1/2w x 7"h	
HPSG811V	11.99	1		8 1/2w x 11"h	1/2
HPSG57H	6.09		Horizontal	5 1/2h x 7"w	
HPSG711H	9.49	1		7h x 11"w	1/2
HPSG811H	11.99			8 1/2h x 11"w	
BSK11B	15.99		Black	24w x 12d	
BSK11C	15.94	1	Epoxy Chrome	x 4"h shallow	4/12
BSK11W	15.99		White		
BSK12B	20.49		Black	24w x 10d	
BSK12C	21.49	1	Epoxy Chrome	x 5"h double slope	4/12
BSK12W	20.49		White		
BSK13B	9.72		Black	12w x 12d	
BSK13C	10.99	1	Epoxy Chrome	x 4"h small basket	3/10
BSK13W	9.72		White		
BSK14C	11.79	1	Epoxy Chrome	12w x 12d x 8"h sloped front	3/10
BSK15B	14.64		Black	12w x 12d	
BSK15C	15.94	1	Epoxy Chrome	x 8"h deep basket	4/14
BSK15W	14.64		White		

Slotted Standards WALL SYSTEMS

style #	\$	qty	description	size	wgt
---------	----	-----	-------------	------	-----

Satin Zinc:

Universal

SS1048	54.82	10	Single	48"	11
SS1060	64.54		Single	60"	15
SS1072	75.69		Single	72"	16
SS1084	88.13		Single	84"	19

Heavy Duty

SS1248	63.12	10	Single	48"	16
SS1260	75.49		Single	60"	19
SS1272	90.99		Single	72"	23
SS1284	100.49		Single	84"	26
SS2248	83.98	10	Double	48"	24
SS2272	132.45		Double	72"	36
SS2284	138.99		Double	84"	43

Extra Heavy Duty

SS3048	92.99	10	Single	48"	29
SS3060	126.88		Single	60"	36
SS3072	132.49		Single	72"	44
SS3084	137.99		Single	84"	51

SLOTTED STANDARDS

Universal, Heavy Duty, Extra Heavy Duty

** Screws not included*

UNIVERSAL SLOTTED STANDARDS

Steel thickness: 1/16" (.062");
 Universal: 1/2" slots on 1" centers;
 countersunk mounting
 screw holes 9" apart



HEAVY DUTY SLOTTED STANDARDS

Steel thickness: 3/32" (.093") /
 (.062" at the recessed slots);
 Universal: 1/2" slots on 1" centers;
 countersunk mounting
 screw holes 9" apart

EXTRA HEAVY DUTY SLOTTED STANDARDS

Steel thickness: 1/8" (.125");
 1" slots on 2" centers;
 countersunk mounting
 screw holes 12" apart



FACEOUT DISPLAYERS

To use on heavy duty slotted standards with 1/2" slots on 1" centers

TS12	4.25	1	CHROME	12"	2/6
TS5H	7.65		CHROME	18"	2/6
RS12	5.49	1	CHROME	12"	2/6
RS14	5.57		CHROME	14"	2/6
TS7B	7.49	1	CHROME	18"	2/6

STRAIGHT ARM

Square tubing



TS12

5-HOOK

Square tubing



TS5H

STRAIGHT ARM

Rectangular tubing



RS12/14

7-BALL

Square tubing



TS7B

FACEOUT DISPLAYERS

To use on extra heavy duty slotted standards with 1" slots on 2" centers

TR7B	2.46	1	CHROME	18"	2/6
RR12	5.99	1	CHROME	12"	2/6
RR14	10.70		CHROME	14"	2/6
RR7B	12.70		CHROME	18"	2/6



7-BALL

Square tubing

TR7B



RR12/14

7-CUBE

Rectangular tubing

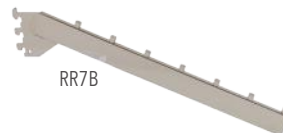

RR7B

STRAIGHT ARM

Rectangular tubing

WALL SYSTEMS Slotted Standard Brackets

HANGROD BRACKETS - to fit 1 1/4" tubing



12" BRACKETS
With nylon stabilizer. For slotted standards with 1/2" slots on 1" centers.



12" DOUBLE BRACKETS
For slotted standards with 1/2" slots on 1" centers.

style #	\$	qty	description	size	wgt
A212	7.49	1	CHROME	12"	2/6
B212	12.49	1	CHROME	12"	3

RECTANGULAR TUBING BRACKETS

For use on slotted standards with 1/2" slots on 1" centers



3" BRACKET
Flat steel.



8" BRACKET
Rectangular tubing.



12" BRACKET
Rectangular tubing.



14" BRACKET
Rectangular tubing.

CR3	6.53		CHROME	3"	
CR3B	3.49		BLACK	3"	1/3
		1			
CR8	7.65		CHROME	8"	2/6
CR12	7.08		CHROME	12"	2/6
CR12B	4.99		BLACK	12"	
CR14	9.96		CHROME	14"	2/6

RECTANGULAR TUBING BRACKETS

For use on slotted standards with 1" slots on 2" centers



3" BRACKET
Flat steel.



8" BRACKET
Rectangular tubing.



12" BRACKET
Rectangular tubing.

GR3	5.80		CHROME	3"	1/3
GR3MAB	3.99		BLACK	3"	
GR8	6.99	1	CHROME	8"	2/6
GR12	6.49		CHROME	12"	2/6
GR12MAB	4.99		BLACK	12"	
GR14	7.64		CHROME	14"	2/6

- See page 89 for shelving -



TAP-IN SHELF BRACKET
Fits universal 1/2" slots on 1" centers. (.080" thick)



ADJUSTABLE SHELF BRACKETS
Fits universal 1/2" slots on 1" centers. Five positive spring loaded settings.



EXTRA HEAVY DUTY SHELF BRACKETS
Fits Extra Heavy Duty Standards. 1" slots on 2" centers. With tightening screw fit "imperial" (.125" thick). Accepts snap-on attachments for use with hangrails.



HEAVY DUTY SHELF BRACKETS w/ LIP
Fits universal extra heavy duty standards, 1" slots on 2" centers with tightening screw.

GA8	2.99		CHROME	8"	
GA10	1.94	1	CHROME	10"	2/6
GA12	2.79		CHROME	12"	
GA14	2.99		CHROME	14"	
GC12	3.11	1	CHROME	12"	2/6
G12	5.59	1	CHROME	12"	2/6
G14	4.25	1	CHROME	14"	
GSBL12	4.99	1	CHROME	12"	3/6
GSBL14	5.49	1	CHROME	14"	

Pegboard & Wall Mount WALL SYSTEMS

style #	\$	qty	description	size	wgt
STANDARD					
PHS4	7.00		4" long		
PHS6	7.65		6" long	1/8" D	1/3
PHS8	8.42		8" long		
HEAVY DUTY					
PHH6	9.07		6" long		1/3
PHH8	9.72		8" long		1/3
PHH10	11.15	12	10" long	3/16" D	2/6
PHH12	7.26		12" long		2/6
EXTRA HEAVY DUTY					
PHX6	11.79		6" long		1/3
PHX8	12.57		8" long	1/4"D	1/3
PHX10	13.87		10" long		2/6
PHX12	15.29		12" long		2/6
PEGBOARD ACCESSORIES					
PB1C9	8.42	100	WHITE	ONE SIZE FITS ALL	1
WALLMOUNT ACCESSORIES					
SHP6	18.01	12	7 GAUGE	6"	3/7
SHP8	20.22			8" w/ 2" tab	
PB6B	2.99	1	CHROME	16 5/8"	1/6
PB5H	3.49	1	CHROME	16"	1/6
PBML	8.42	1	CHROME	8 x 4 1/4"	1/3
PIPELINE WALL MOUNT FACEOUTS					
ACR28PB	12.83	1	ACRYLIC	8 1/2 x 11"	1/7
TB12	6.17		CHROME	12"	
RB12	5.49	1	CHROME	12"	2/6
TB7B	6.49	1	CHROME	16 5/8" 7 BALL	2/6
RB7B	6.72	1	CHROME		
TB5H	7.00	1	CHROME	16" 5 HOOK	2/6
FR3	9.80	1	CHROME	3"	1/3
NHPSWL10WH	14.99		Gloss White	10"	
NHPSWL10	14.99	1	Anthrocite Grey	10" long	14

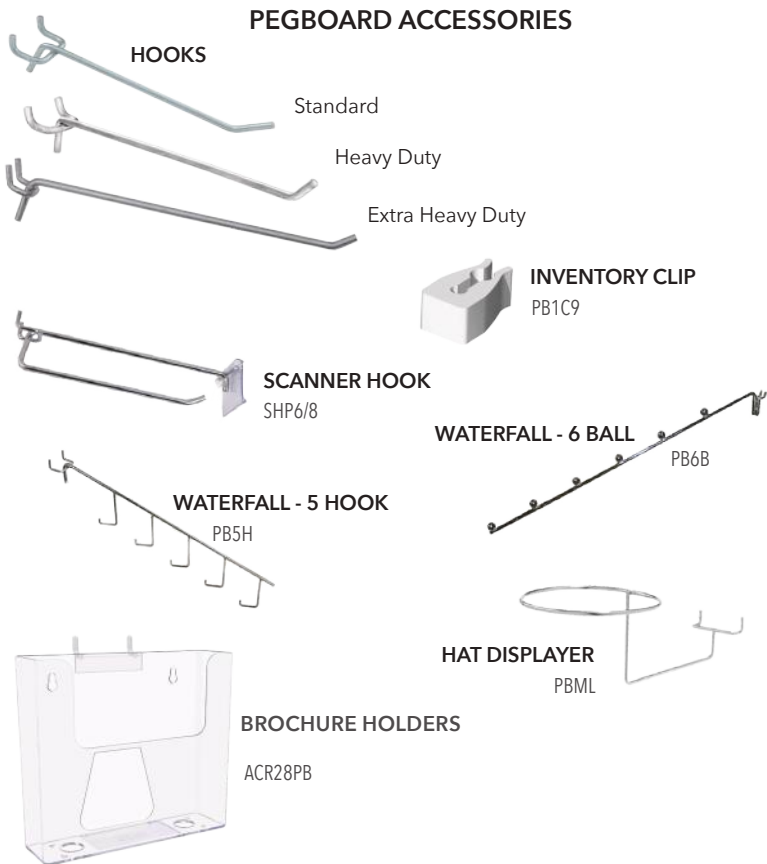

PIPELINE WALL MOUNT FACEOUTS

See our selection of coordinating pipeline store fixtures (pages 91-94)



WALL SYSTEMS Tubing & Accessories

ROUND TUBING & ACCESSORIES

ROUND TUBING
1 1/4" diameter, 14 gauge

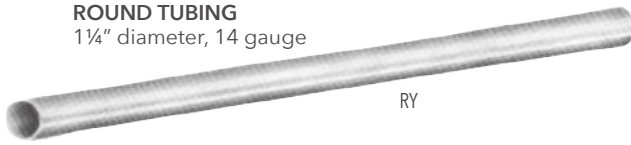

U FLANGE
For 1 1/4" and
1 5/16" round
tubing
UF9



O FLANGE
For 1 1/4" and
1 5/16" round tubing
OF7

SPLICER
For 1 1/4"
round tubing
RYSP



END CAP
For 1 1/4" and
1 5/16" tubing
EC2

RECTANGULAR TUBING & ACCESSORIES



RECTANGULAR TUBING
1/2" x 1 1/2" x 17 gauge



style #	\$	qty	description	size	wgt
RY4	12.49		CHROME	4'	4/7
RY5	12.99		CHROME	5'	6
RY6	16.99	1	CHROME	6'	6/7
RY8	26.49		CHROME	8'	8
RY10	33.49		CHROME	10'	11
RY12	38.99		CHROME	12'	13

UF9	3.11		CHROME	UFLANGE	1
OF7	2.10		CHROME	OFLANGE	1
RYSP	1.99	1	CHROME	SPLICER	1/3
EC2	1.49		CHROME	END CAP	1

RH7B	7.99		CHROME	14"	2/6
RH7BMAB	7.00		BLACK	14"	
RH5H	9.49		CHROME	17 3/4"	2
RH6	4.54	1	CHROME	6"	1/2
RH2C	3.89		CHROME	2"	1/3
RH12	8.89		CHROME	12"	2/6
RH12MAB	4.99		BLACK	12"	
H4	.78		CHROME	4"	
H6	.99		CHROME	6"	1/3
H9	.91		CHROME	9"	
H12	1.49		CHROME	12"	

RE2	5.59			2'	2
RE3	8.42		All sizes	3'	3
RE4	16.51		available in	4'	4/5
RE5	14.64		chrome except	5'	5
RE6	18.79	1	4' which is also	6'	6/10
RE8	23.49		available in	8'	6/12
RE10	30.99		available in	10'	7
RE12	38.99		black and white	12'	9
REMB4	11.79			4'	4/5

RECTANGULAR TUBING & ACCESSORIES

END CAPS



EC4 chrome plated
EC4MAB matte black

**EXTENDED
END CAPS**



EC5 chrome plated
EC5MAB matte black

SPLICER



RESP splicer for
rectangular tubing

EC4	.91		CHROME	TUBING	
EC4MAB	.99		BLACK	1/2" x 1 1/2"	
EC5	1.44	1	CHROME	TUBING	
EC5MAB	1.49		BLACK	1/2" x 1 1/2" w/1" extension	1
RESP	1.99		CHROME	1/2" x 1 1/2"	

Open/Closed Signs SIGNAGE

Open/Closed Sign Kits

Sturdy metal constructed, double-sided signs with two pre-drilled holes. Kits include one (1) black metal chain with two (2) black S hooks for hanging, and two (2) suction cups. Printed in the USA.

All signs are 12" w x 8" h; printed with an "open" message on the front and a "closed" message on the back; 5lbs.

19.99/kit



front



back

Black Script
NMSKBS



front White/Black NMSKWOC back



front Vines NMSKVOG back



front Blue Wash Tones NMSKBLO back



front



back

Blue Retro NMSKBLO2



front Spanish NMSKABSE back



front



back

Hiring - Black NMSKBWH



front Grey w/Dots NMSKGO back



front



back

Hiring - Red NMSKRWH



front Red NMSKRO back



front



back

Black NMSKBO



front Black Awesome NMSKBOWA back



front



back

Red Awesome NMSKROWA

SIGNAGE

Card Stock Signs



Card Stock signs, available in 3 sizes and 9 designs.

Double sided. Printed on high quality 10 point card stock. Made in the USA.

Don't see the message you're looking for? Give us a call and let us know what you need. We can custom make it for you!

<p>SMALL 5.5" w x 3.5" h \$1.93 /each \$9.50 /5 pcs \$18.90 /10 pcs</p>	<p>MEDIUM 7" w x 5.5" h \$2.19 /each \$10.75 /5 pcs \$20.35 /10 pcs</p>	<p>LARGE 11" w x 7" h \$2.32 /each \$11.20 /5 pcs \$21.64 /10 pcs</p>
<p>SHIP WEIGHTS: each - 1 lb 5-pack - 1 lb 10-pack - 1 lb</p>		

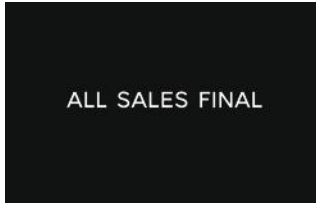

CD35ASF2 /small
CD57ASF2 /medium
CD711ASF2 /large



CD35ASF1 /small
CD57ASF1 /medium
CD711ASF1 /large



CD35S1 /small
CD57S1 /medium
CD711S1 /large



CD35S2 /small
CD57S2 /medium
CD711S2 /large



CD35S3 /small
CD57S3 /medium
CD711S3 /large



CD35S4 /small
CD57S4 /medium
CD711S4 /large

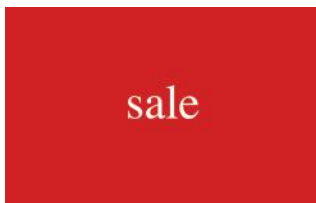

CD35S5 /small
CD57S5 /medium
CD711S5 /large



CD35NA2 /small
CD57NA2 /medium
CD711NA2 /large



CD35NA1 /small
CD57NA1 /medium
CD711NA1 /large



CD35SS /small
CD57SS /medium
CD711SS /large



SALEBANNER
Glossy red sale printed vinyl tags slip over the hook of a hanger. 2" w x 4" h; 5/16" dia. hole is 3/16" from top; 100 pcs; 1/3 lb.
27.73



Plastic Display Cards
Red & White plastic card stock, slightly textured on front. Available in 3 styles. 7" w x 11" h; 1 pc; 1 lb.
RAH44 3.89

Sign Holders SIGNAGE

style #	\$	qty	description / size	wgt
BH28	39.99	1	Chrome, 22x28", 60" H (holds graphics up to 3/16" thick, usable sign area 20 3/4" x 26 3/4")	18
The following signs all hold graphics up to 1/4" thick:				
BH28BAW	116.51	1	Black, All Weather, 22x28", 60"H indoor/outdoor	18
BH22	37.49	1	Chrome, 14x22", 53"H	13
BH28MAB	52.99	1	Matte black, 22x28", 60" H	23
BH23	75.30	1	Chrome, extra heavy base, 14x22", 53"H	13
BH29	76.49	1	Chrome, weighted base, 22x28", 60" H	22
BH24	42.49	1	Chrome, rectangular tubing, 14x22", 56"H	7



BH22/BH28
BH28MAB
Chrome or Black
10" x 14"
flat base

BH23/BH29
Chrome
Extra heavy weighted
10" x 14" base



BH28BAW
Black
All Weather
Sign Holder
10" x 14"
flat base

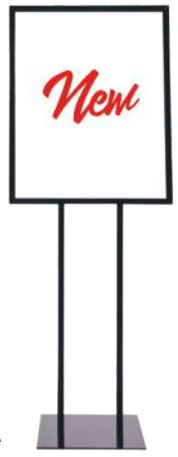

BH24
Chrome
Rectangular
tubing frame

ACRYLIC SIGN PROTECTORS



BH28SP

**SIDEWALK SALE
SIGN KIT**

BH28SP2

BH28SP	43.03	2	Acrylic Sign Protectors (2) crystal clear panels; each 22"w x 28"h x .04" thick (works with BH28 - sold separately)	4
BH28SP2	97.84	1 kit	"Sidewalk Sale" Sign Kit Kit includes (1) BH28 sign, (2) "Sidewalk Sale" poster signs, (2) sign protectors (BH28SP)	24

BH30	82.99	1	Rect. tubing, 22x28", 56" H; Chrome holds graphics up to 3/16" thick	9,8 lbs; (2 ctns)
BH30MAB	65.49	1	Rect. tubing, 22x28", 56" H; Matte Black; holds graphics up to 1/4" thick	9,8 lbs; (2 ctns)
BH55	97.99	1	Double 22" x 28" sign holder; 56" H; Chrome; holds graphics up to 3/16" thick	9,8 lbs; (2 ctns)
BH55MAB	89.49	1	Double 22" x 28" sign holder; 56" H; Matte Black; holds graphics up to 1/4" thick	9,8 lbs; (2 ctns)
BH77	199.98	1	Triple 22" x 28" sign holder; 90" H; Chrome; holds graphics up to 3/16" thick	35/98, 10/25 lbs; (2 ctns)
BH77MAB	163.99	1	Triple 22" x 28" sign holder; 90" H; Matte Black; holds graphics up to 1/4" thick	



BH30
BH30MAB
Chrome or Black
Single sign holder.
Rectangular tubing
frame base - 15" x 24"



BH55
BH55MAB
Chrome or Black
Double sign holder.
Rectangular tubing
frame base -
15" x 24"



BH77
BH77MAB
Chrome or Black
Triple sign holder.
Rectangular tubing
frame base -
24" x 25"

Metal shelf signs

Ledge piece is 6" front to back;
sign holder piece is 6 1/2" across

NHSTCH	9.72	1	High Polished Chrome	1
NHSTV	7.00	1	Metal	

Accepts 6 1/2"W x 1 1/2"H paper inserts; (not included)

METAL SHELF OVERLAY RETAILS SIGNS W/FRAMED FRONT

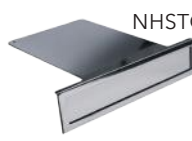

NHSTCH



NHSTV

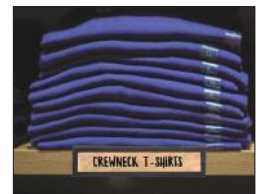

SIGNAGE Sign Holders & Accessories

SQUARE CORNER CARD FRAMES



MCP711-MB

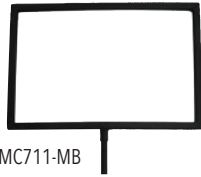

MC711-MB



SC22-MB SC20-MB



MC57, MC711, MC114



MCP57, MCP711



SB57
SB711

ROUND CORNER CHROME FRAMES



CF711

CHROME CLAMPS & STEMS



C5



C6



SC22



SC23



SC8



SC11



M3



M6



NS3

MAGNETIC CLAMPS



SC17



SC20



SC21

style #	\$	qty	description / size	wgt
MCP711-MB	14.70	1	7x11" Matte black mitre corner card frame w/double 4" stem 3/2x5" base	7/10
MC711-MB	10.49	1	7x11" Matte black square corner frame w/3" threaded stem attchd.	6/10
SC20-MB	8.90	1	Matte black magnetic clamp threaded	1
SC22-MB	2.79	1	Matte black all purpose clamp threaded	1
MC57	30.49	6	5/2x7" chrome frame w/ 3/8" fitting	2
MC711	39.06	6	7x11" chrome frame w/ 3/8" fitting	6/10
MC114	42.90	6	11x14" chrome frame w/ 3/8" fitting	6/10
MCP57	8.42	1	chrome, 5/2x7 card frame mitred Double 4" stem, 4x7" base	2/6
MCP711	9.72	1	chrome, 7x11" card frame mitred Double 4" stem, 4x7" base	2/6
SB57	9.49	1	10"H shovel base, 5/2x7"	2/6
SB711	10.50	1	10" H shovel base, 7x11"	2/6
CF711	8.42	6	7x11" frame w/ 3/8" fitting * while supplies last	6/7
C5	20.22	6	1" Square w/3" stem - 3/8"	2/3
C6	17.37	6	1/2 x 1 1/2" rect. 2" stem - 3/8"	2/3
SC22	13.29	6	Universal all purpose clamp; Fits round, square & rect. tubing threaded	2/3
SC23	16.49	6	All purpose clamp for 3/8" swedge	2/3
SC8	15.99	6	Spring clamp for 1" sq. tubing w/ threaded 3/8" fitting	2/3
SC11	9.99	6	Spring clamp for rect. tubing w/ threaded 3/8" fitting	2/3
M3	4.92	6	3" threaded stem - 3/8"	2
M6	7.49	6	6" threaded stem - 3/8"	2
NS3	4.92	6	3" swedge stem - 3/8"	2
SC17	21.51	6	Magnetic clamp for 1/4 & 3/8" threaded stem	2
SC20	31.23	6	Magnetic clamp for 3/8" threaded stem	2/3
SC21	31.23	6	Magnetic clamp for 3/8" swedge stem	2/3

Sign Holders /Acrylic SIGNAGE

style #	\$	qty	description / size	wgt
ALLIGATOR SIGN CLIP HOLDERS Satin Nickel / down position clip:				
WSAC1SN	14.99	1	12" H	3/6
WSAC2SN	14.49	1	24" H	3/11
WSAC4SN	15.49	1	42" H	4/21
WSAC5SN	3.95	1	Clear, 1"x1" square base; 4"H	0.5/1
WSAC7SN	4.38	1	"S" design; stainless steel; 3 1/2"H	0.5/1
Clear:				
POP1	18.01		Double clip sign holder 3 1/2" long; clip - 0.75"W x 1.5" H	1/3
POP2	31.23		Clip on sign holder w/ spring loaded graphic holder; 4" long; clip - 3.2"W x 1"H	2/7
POP3	41.60	20	Clip on sign holder w/ spring loaded graphic holder; 6 1/4"L; clip - 3.2"W x 1"H	2/7
POP4	24.36		Clip on sign holder w/ fixed graphic holder; 3 5/8" long; clip - 2.2"W x 0.88"H	2/7
PK57	11.15	1	5 1/2 x 7" card holder w/ chrome double stem	2/3
PK711	15.03	1	7x11" card holder w/ chrome double stem	3/6
JPC57	45.99	6	5 1/2 x 7 1/2" frame w/ universal stem	2/3
JPC711	52.49	6	7x11" frame w/ universal stem	3/7
Horizontal, double-sided, bottom load sign holders:				
PG711	50.49	6	Straight 7x11" card holder	3/7
PJ711	50.49	6	Card holder, chrome channel 7x11" w/ 3/8" fitting	3
PH711	21.49	6	Slanted 7x11" card holder	7/10
HPCT811V	12.57	1	11"H x 8 1/2"W	2/3
HPCT114V	20.87	1	BOTTOM LOAD VERTICAL 14"H x 11"W	2/3
COUNTER BROCHURE HOLDER				
IMCT811	5.99	1	8 1/2" x 11" clear	2/6



ALLIGATOR CLIP SIGN HOLDERS



WSAC5SN



WSAC7SN



CLIP-ON SIGN HOLDERS



POP1



POP2



POP3



POP4

ACRYLIC CARD HOLDERS



PK57 / PK711



JPC57 / JPC711



PG711



PJ711



PH57 / PH711

TOP & BOTTOM LOAD SIGN HOLDERS

Crystal clear sign holders



HPCT811V



Bottom Load
Vertical
HPCT114V



BROCHURE HOLDER

IMCT811

SIGNAGE Sign Hanging & Accessories

CEILING ANCHORS



style #	\$	qty	description / size	wgt
GCH02	17.37	10	1/4" swivel hook slot; rotates 360°; snaps on ceiling grids	5
GCH04	34.08	10	Ceiling anchor w/ steel spring & 15/64" loop	5
GCH05	14.94	10	Clear hinged hook ceiling anchor	5
GCH06	13.87	10	7/8" loop ceiling anchor w/ 2" base; twist to connect	5
RMB18	8.42	1	Plated steel magnet with hook: 1 1/2" dia - holds 18 lbs 2" dia - holds 20 lbs 2 1/2" dia - holds 38 lbs	1
RMB20	13.87			
RMB38	17.37			
MCL1	.75	1	Plated steel magnet in 2 sizes: 1" - holds 5 lbs 2" - holds 14 lbs	1
MCL2	1.00			
<i>While supplies last</i>				
250145	5.29	1	White Gorilla magnet: holds up to 20 lbs	1
250026	37.99	50	White snail adhesive disk	1/3

ClearOne-Up™ Spider Anchors

Spider Anchors

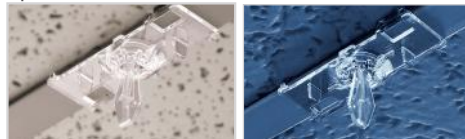

RAN1UP

RAN1UP2

RAN1UP	7.52	10	use w/ hooks to hold signs perpendicular or parallel	1/3
RAN1UP2	5.99	10	2 piece - use w/ hooks to hold signs perpendicular, parallel or 45°	



PINCH

PINCH	2.99	10	Galvanized steel	1
-------	------	----	------------------	---

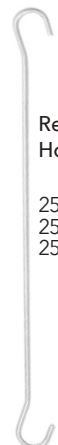

Regular Hook

2500808
2500812
2500816



S HOOKS

300100

300795

125309

Galvanized Steel:				
300100	14.32	100	Long S Hook - 2 5/8"H	2/3
125309	3.29	100	Standard S Hook - 1"H	1
300795	11.15	50	Large S Hook - 1 5/8"H	



Double Loop Cable (pairs)

DLC6
DLC12
DLC18
DLC24



06SC150H10

Galvanized Steel:				
2500808	13.87	50	Regular Hook 8"	2/3
2500812	15.29	50	Regular Hook 12"	2
2500816	20.87	50	Regular Hook 16"	2/9
Double loop cable - sold in pairs; 1/32" uncoated stainless steel w/ 1/2" long loops; holds up to 50 lbs				
DLC6	9.72	2	6" Cable length	5
DLC12	11.15	2	12" Cable length	
DLC18	12.57	2	18" Cable length	
DLC24	13.87	2	24" Cable length	

MIRACLE STICKS® ADHESIVE SIGN TABS

NHMS



06SC150H10	5.49	10	Suction cup - Clear with plated steel hook 1 3/4"	1/3
NHMS	15.99	500	Adhesive on both sides. Apply to back of signs to avoid messy taping. 3/8" x 1 5/8"	1



SIGN HANGING SYSTEMS & HANGING HARDWARE FOR GRAPHIC DISPLAYS

Featuring plastic gripper bar sets with snap closures, hanging dowel kits, sign clips that can be used for hanging signs - or simply turn them over to use as countertop displays. We have updated our ceiling anchors too, including magnets, hooks and cables. Easy to assemble and versatile for every season.

PLASTIC GRIPPER BAR SETS

Set includes a top and bottom bar, and feature snap grips that close easily. Strong with a rigid torque. Fits signs up to .070" thick. Each set includes two snap grips, two universal hanging clips and is available in three sizes.



GSHR - straight

Straight Sets

Clear. Available in 3 sizes:

GSH24R - (C)	24" long	11.79
GSH36R - (C)	36" long	15.29
GSH48R - (C)	48" long	19.44



GSHO - oval

Oval Sets

Silver. Available in 3 sizes:

GSH24O - (S)	24" long	20.87
GSH36O - (S)	36" long	24.36
GSH48O - (S)	48" long	31.88



Can be used 2 ways



GSHC

Mini size
1 1/4" w x
2" h

2" w x 3" h

RMB

Round magnetic base w/hook available on page 118



HANGING DOWEL KITS

Made for banners with a hem, top and bottom. Each kit includes (2) aluminum 1/2" diameter dowels, end caps and (1) diamond braided cord. Available in 3 sizes.

GDSH24	24" long	11.79
GDSH36	36" long	13.87
GDSH48	48" long	15.29

GDSH



SIGN HANGING & COUNTERTOP CLIP SETS

Solid aluminum alloy sign clips coated in a satin finish. Clips feature rubber grips, a binder spring and the ability to grip signs up to 1/2" in thickness.

Satin silver or black. Sold in sets of two, same size/color.

GSHCL	2"W x 3"H	39.53
GSHCLB		
GSHCS	1 1/4"W x 2"H (mini)	27.73
GSHCSB		



SIGNAGE Outdoor & Miscellaneous

FEATHER BANNER SWOOPER FLAG SIGN KITS



SALEFB CLEARANCEFB OPENFB OPENSFFB

15 FOOT HIGH FLAG SIGN KIT

Includes 1 flag (12' x 2.5'), 1 4-piece pole kit & 1 stake; stands 15' high when assembled; 1 kit/carton; 7 lbs. **\$97.07 /kit**

- | | |
|-------------|---------------------------------|
| SALEFB | Sale Sign kit |
| CLEARANCEFB | Clearance Sign kit |
| OPENFB | Open (blue/red) Sign kit |
| OPENSFFB | Open (stars & stripes) Sign kit |

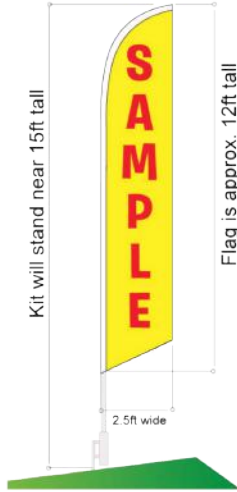

FLAGS



PFL00100



PFL00200

SALE & OPEN FLAGS

Large 3' x 5' flags. Lightweight and durable outdoor polyester material, double stitched on flying edges for extra durability, and two metal grommets for easy display. 1 /carton; 1 lb.

- | | |
|---------------|---------------------|
| SALE PFL00100 | \$13.87 each |
| OPEN PFL00200 | \$19.43 each |

PENNANTS



PNR100-OMC



PNR100-OPT

TRIANGLE PENNANTS

(48) 12" x 18" pennants on 100' of nylon rope. Please specify color: Red/White/Blue(OPT) or Multi-Colored(OMC).

- | |
|---------------------------|
| 1 /carton; 2/10 lbs. |
| PNR100-OPT \$26.49 |
| PNR100-OMC \$24.99 |



OPENHRB2

LED OPEN SIGN

LED red and blue open sign with black base for indoor use. Measures 13"H x 21 1/2"W x 1"D. Weight 3lbs. Lifetime of 10,000 hours. Low power consumption. No Flashing. Power supply and chain included; 18 5/8" w x 9 5/8" h. 1 /carton; 3/12 lbs. **\$55.34**



NHMBB03G

A-FRAME SIDEWALK CHALKBOARD

Features a mahogany finish. Can be used with chalk and liquid chalk markers (sold separately). It is double-sided and sits on rubber stoppers to prevent scratches and add stability. Can be used indoors and/or outdoors.

Closed Dimensions: 20 1/2" (w) x 39 1/2" (h) x 2" (d)
Open Dimensions: 20 1/2" (w) x 37 1/2" (h) x 27" (d)
Writable Area: 17 3/4" x 28 3/4"

1 /carton; 18/24 lbs. **\$116.51**



NHMBB03B

A-FRAME SIDEWALK MARKER BOARD

Features a mahogany finish and black marker board perfect for dry-erase or liquid chalk markers (sold separately). It is double-sided and sits on rubber stoppers to prevent scratched floors and added stability. Indoor use only.

Closed Dimensions: 20 1/2" (w) x 39 1/2" (h) x 2" (d)
Open Dimensions: 20 1/2" (w) x 37 1/2" (h) x 27" (d)
Writing Area: 17 3/4" x 58 3/4"

1 /carton; 18/24 lbs. **\$116.51**

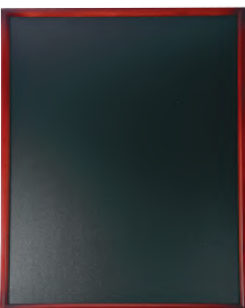

NHMBB10C

FRAMED SQUARE CHALKBOARD

Features a mahogany finish and can be used with chalk and liquid chalk markers (sold separately). It can be hung in portrait and landscape with the (2) hooks provided. Indoor use only.

Overall Size: 24" x 30" x 1"
Writable Area: 22 1/2" x 28 1/2"

1 /carton; 9/10 lbs. **\$68.04**



PFL00200KT

OPEN FLAG w/POLE KIT

Kit consists of one 3' x 5' OPEN flag and a 6' flag pole. The flag pole is white, painted steel and includes a mounting bracket and screws, rotating flag clips, and a gold plastic eagle mounted on the top.

1 kit /carton; 2/5 lbs. **\$42.76**

FLUORESCENT LIQUID CHALK MARKERS

Wipe away easily with a wet cloth. A set includes 8 markers: Blue, Green, Pink, Purple, Orange, Red, White, and Yellow.

w/ 1/8" SMALL BULLET TIP (8)

8 /carton; 1 lb. **\$25.66**

NHGEB06



w/ 5/8" LARGE FLAT TIP (8)

8 /carton; 1/2 lbs. **\$50.67**

NHGEB05

TRAFFIC CONTROL

Everyone experiences waiting in lines. Organized waiting feels shorter and less stressful. Visible queuing ensure customers understand where to check out. Choose from a range of stanchions for forming wait lines and guiding foot traffic.

RETRACTABLE BELT STANCHIONS

Economical steel posts and belts with slow-retracting brake available in three options.

40.5" tall; 10' black belt; 1/pack; 47/50 lbs./pair

PRBSBBK Black Post; 14" base \$57.49

PRBPS1BK Polished Steel Post; 14" base \$69.49

**Price is per post / ships in pairs*

- Same day shipping on most orders.
- Ships knocked down.
- Easy assembly - no tools required.

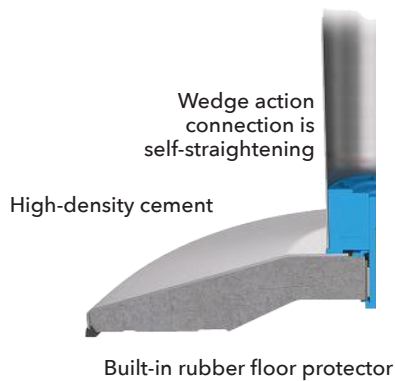

PRBSBBK
Smooth
Black

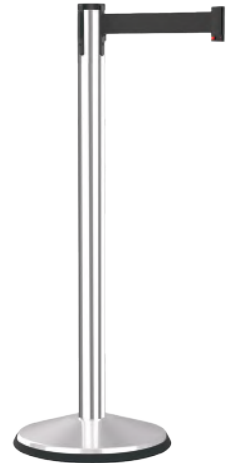

PRBPS1BK
Polished
Stainless
Steel

Economy accessories - page 123

WALL MOUNT BARRIERS

Wall mount barriers - Great for small spaces, closing off restrooms and other areas for cleaning. Great for micro physical inventories or cycle counts. Close off VIP areas for special customers. Economically priced and durable.

WALL MOUNT BARRIER

Wall mount barriers with 10' belts; 1/pack; 2.5/3 lbs. \$30.99

WALL MOUNT RECEIVING END

Receiving end; 1 lb. \$11.49

TLRE Black



WM100SBBK Black w/black belt



WM100PS1SB Chrome w/black belt

SECURITY Traffic Control

TENSABARRIER® 890 SERIES

Premium retail staple for stanchions. Military-grade fabric belt & high-grade premium posts. Added Safety: extra slow retracting and low edge base for people with mobility issues. Ships pre-assembled!

RETRACTABLE BELT STANCHIONS

40" h post; 7' long military-grade fabric belt - (0.89mm thick and 2" wide); 1 /pack; 20/26 lbs.

TENSABARRIER® accessories detailed on page 123



Polished chrome post
w/ black belt
NH890PCB \$183.49



Satin chrome post
w/ black belt
NH890SCB \$183.49



Black post
w/ black belt
NH890BB \$183.49

POST & ROPE Style and durability for high-end retail and hospitality. Classic Post and Rope stanchions are professional quality at an economic price.

POSTS /STANCHIONS



Prices are for one post - but must be bought in pairs.
39.5 - 41.25" tall; 25 lbs.

FLATTOP
Black
MLFTMB \$51.99

BALL TOP
Gold
MLBTPB \$78.99

URN TOP
Polished Stainless
MLUTPS \$62.99

ROPES



3 SNAP END FINISHES:

Black snap end

Chrome snap end

Gold snap end

Braided Polypropylene:



Natural
Hemp



Black

Velour

(w/cotton core):



Black

Pair posts with snap end ropes. 6' and 8' lengths; hemp or velour ropes; 3 choices of snap end finishes; 5 lbs.

BRAIDED/6 foot ropes \$72.99 /each

TRBLKB6 Black/black snap end
TRBLKG6 Black/gold snap end
TRBLKC6 Black/chrome snap end
TRHEMPB6 Natural/black snap end
TRHEMPG6 Natural/gold snap end
TRHEMPC6 Natural/chrome snap end

BRAIDED /8 foot ropes \$85.99 /each

TRBLKG8 Black /gold snap end
TRBLKC8 Black /chrome snap end
TRHEMPG8 Natural /gold snap end
TRHEMPC8 Natural /chrome snap end

VELOUR/6 foot ropes \$93.99 /each

VRBLKB6 Black /black snap end
VRBLKG6 Black /gold snap end
VRBLKC6 Black /chrome snap end

VELOUR /8 foot ropes \$112.99 /each

VRBLKB8 Black /black snap end
VRBLKG8 Black /gold snap end
VRBLKC8 Black /chrome snap end

TRAFFIC CONTROL ACCESSORIES

Guide customers with signs. Boost impulse sales by strategically merchandising your queue areas for waiting customers.

890 SERIES TENSABARRIER® SYSTEM *see page 122 for coordinating posts*

TENSABARRIER® SIGN BRACKET



Black plastic sign cone and slot for sign; The acrylic pocket allows you to use your own sign; Bracket can hold a hard backed 1/4" thick

170133899HD 2/5 lbs. **\$49.99**

TENSABARRIER® IMPULSE BOWL



Bowl includes adapter that slides onto stanchion; Made from lightweight polycarbonate plastic; Heavy duty adapter for stability

NH890IB 3/5 lbs. **\$64.49**

ECONOMICAL POST & TENSION SYSTEMS *see page 121 for coordinating posts*

Pair stanchions with heavy duty sign frames or stock engraved messages signs.

HEAVY DUTY SIGN FRAMES



Display messages with premium post mount sign frames. 8.5x 11", durable steel construction, welded square corners and slotted top accepts up to 1/4" thick insert material.

Frame includes adapter cone (works with 2.5" diameter posts) and 2 pieces of clear, non-glare acrylic inserts. Slotted cap for top loading.

TLSK1811MB matte black; 2.5/3 lbs. **\$36.49**

TLSK1811PC polished chrome; 2.5/3 lbs. **\$36.99**

ENGRAVED SIGNS



Universal Economy
7X11" engraved signs.
Single sided.

Custom message signs are available upon request.

PRENT please enter here; 3.5 lbs. **\$24.49**

PREX exit; 3.5 lbs. **\$24.49**

SIGN BRACKETS

Install a 7X11 engraved sign with a bracket. Universal post adapter. Works with 2.5" dia posts.

PRSBBS smooth black; 3.5/5 lbs. **\$43.49**

PRSBPC polished chrome 3.5/5 lbs. **\$43.49**



SECURITY Security Devices



COUNTERFEIT CASH DETECTOR

Counterfeit detector unit only; 2 3/4" x 4 1/2";
1 /pack; 1 lb; NHFT **\$56.99**
Includes AC adapter



3 TESTS:
watermark,
UV strip
& ink
detector



DETECTOR KIT /BATTERY

NHFTRB Detector kit w/battery;
both pieces 2 3/4" x 4 1/2";
1 kit /pack; 1 lb. **\$72.99**

NHFTRBADD Battery only.
rechargeable; 2 3/4" x 4 1/2";
1 /pack; 1 lb. **\$16.99**

PEN STYLE COUNTERFEIT DETECTOR

Each pen tests up to 5,000 bills

K20020 Black Pen; 1/pack; 1 lb. **\$5.57**

K20020S Set of 3 Pens; 1/pack; 1 lb. **\$16.59**

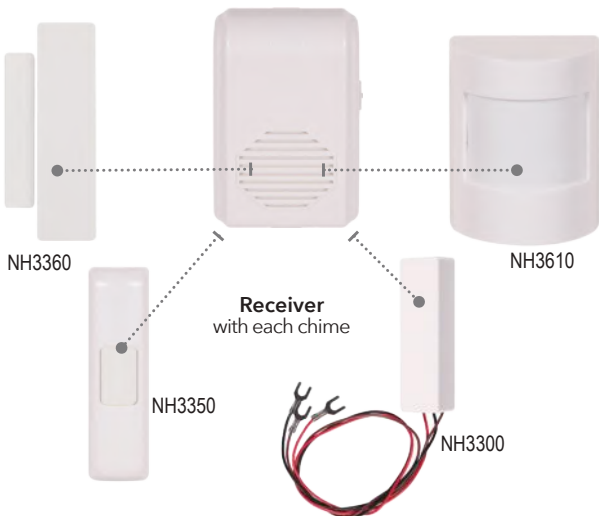

WIRELESS ENTRY ALERT[®] CHIMES AND RECEIVER KITS

All kits feature: up to 500 ft. range; 64-88 dB at 1 foot; UL/cUL listed,
FCC and IC Compliant. 1/pack; 1 lb.

NH3360 Chime alert w/Receiver; 10 selectable chimes **\$52.99**

NH3350 Musical doorbell chime w/ Receiver; 10 selectable sounds **\$55.99**

NH3300 Doorbell extender w/ Receiver; 2 selectable sounds **\$55.99**

NH3610 Motion-activated chime w/ Receiver; 10 selectable chimes;
weather sealed **\$54.49**

Easy to install. No expensive wiring.



COMPACT MOTION DETECTOR

Self-contained indoor alarm. Motion detection activates a chime or alarm sound. Uses 9V
battery (not included). Detects motion at a range of up to 32 feet. Fully automatic. No
alignment required. Mount where you need it: ceiling, walls, etc. No wires. Easy install.

3x3x2 1/4"; 1/pack; 1 lb. **\$62.47**



SECURITY CHAIN KIT w/RING & LOCK

Economical and effective anti-theft.
Feed chain through garment and secure to
garment rack or display.

Kit includes 8" ring, 46" chain, lock and
key; 1 /pack; 1/3 lbs; 606 **\$6.87**



REPLACEMENT LOCKS

Standard replacement
locks; 5 /pack; 1 lb;
LOCKS **\$3.11**

DRESSING ROOM SUPPLIES

style #	\$	qty	description	size	wgt
NHBLB	24.36	1	Brass wire lint brush	9 1/4" long	2/3
NHCB	20.87	1	Horse hair coat brush, deluxe	14 1/4" long	2/3
NHNB	25.66	1	Lint & Nap brush - Brass wire center with outside row of horse hair bristles - excellent for suedes & sweaters	4 1/2"L x 2 1/2"W	2/3
NHFC	34.73	1	Fabric comb w/steel blade to remove pills from wool garments	6" wide; 7 1/4" long	2/3
NHSC	25.66	1	Sweater comb	6" long, 4 5/8" x 2 1/4" head	2/3
NHCSR	9.72	1	Janie® Dry Spot Commercial Stick Remover	.40 ounces	2/3
NHSR	6.49	1	Grandma's Secret Spot Remover	2 ounces	2/3
TS	54.17	100	White	Misses	2/3
TSJ	44.45		White thong	Junior	2/3
TCP1	77.99	1000	Natural	1 1/2x5"	3
LL30	4.37	1	8" Lint Roller w/ handle	30' roll	1/2
LLR	2.58		4" Refill		
1030A	30.99	1	One bottle Non-aerosol	8 oz	2
1061	20.49	1	One can Aerosol	12 oz	2
SG2000	95.99	1	Electric spot cleaning gun	Standard	5/6



NHBLB

BRASS WIRE LINT BRUSH



HORSE HAIR COAT BRUSH

NHCB



FABRIC COMB

NHFC

LINT & NAP BRUSH

NHNB



SWEATER COMB

NHSC

Janie® DRY STICK COMMERCIAL SPOT REMOVER

NHCSR



GRANDMA'S SECRET SPOT REMOVER

NHSR



TRY-ON PANTY
Excellent for bathing suits.
Each is packed individually.



TSJ

HYGIENIC LINER



TCP1

LINT ROLLER & Replacement Rolls



1030A



1061

Ever Blum® COSMETIC STAIN REMOVER

POWDER SPOT REMOVER
For fine garments.

LL30



LLR



SG2000

Albatross® ELECTRIC SPOT CLEANING GUN

DRESSING ROOM SUPPLIES

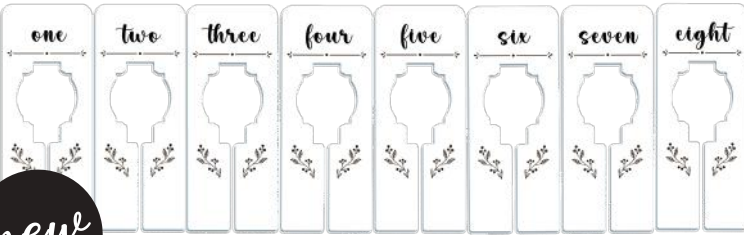

new

QSDWBKIT22

style #	\$	qty	description	size	wgt
---------	----	-----	-------------	------	-----

Each kit comprises 8 pieces (numbered 1-8):

QSDWBKIT22	5.90	8 /kit	White w/ black print	2 x 5"	2
QSDWBKIT20	5.90	8 /kit	Black w/ white print	2 x 5"	2
QSDWBGKIT21	5.90	8 /kit	White w/ green vines	2 x 5"	2

FITTING ROOM CHECKS

QSDWBKIT20



Each piece is printed on both sides



Made in the USA



QSDWBGKIT21

Let us create Custom Kits for you!



LSB

PLASTIC SHOPPING BASKETS

Choose from two sizes: JSB (Jumbo) and LSB (Large).

Hot stamp printing is available for this item. Ask for details. *All baskets are drop ship only.*

Basket stands sold separately (below).

Allow 5-10 business days to ship

JSB	101.22	12	SPECIFY color	19 1/8 x 13 1/4 x 10" (8 gallons/ 28 liters)	26/43
LSB	83.07	12	SPECIFY color	17 x 11 3/4 x 9" (6 gallons/ 22 liters)	20/29

Colors: Blue (BL), yellow (Y), red (R), black (BLK), grey (GY) and green (G). Note that other colors are available with a 60-90 day lead time.

BASKET STAND

Black wire metal stand available in two sizes that correspond to shopping baskets above.

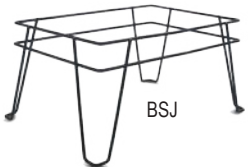

BSJ



BSJ	36.16	1	BLACK METAL	JUMBO	5/16
BSL	33.31	1	BLACK METAL	LARGE	3/14



PGB-BLK

PULL & GO BASKETS

- Easy grip pick-up handle and ergonomic, antibacterial, lockable telescopic pull handle
- Smooth panel on the top rim can be used for logo branding
- Washable and 100% recyclable

PGB-BLK	206.71	6	Black	21"L x 15"W x 17"H (36"H W/ handle extended) 43 liter capacity; max weight 55lbs	35/35
---------	--------	---	-------	---	-------

DRESSING ROOM SUPPLIES

style #	\$	qty	description	size	wgt
NTEZ	9.59	1	EZ-Off Iron Cleaner	5.25 oz. tube	1/3
ZD100	27.60	1	1- 1 oz. tube of soleplate cleaner 1- application cloth 1- polish/finish cloth 1- set of instructions		1/3
NTHI450F	26.31	1	Replacement Resin Filter - for use w/gravity feed irons		1
NTTIS-NTP5N	41.60	1	Ironing shoe (for use with NTP5N iron)		1
834	6.87	5	White, 60"	60"	1
NTTMC	3.63	1	Crotch tape measure	60"	1/3
NTPCT	2.85	1	Pin cushion tomato	Red/Green	1/3
NTSR6	2.72	1	Large seam ripper		1
NTSR5	1.68	1	Small seam ripper		1
NT4	3.50	3	For all needle types	Gold	1
NTTCA/ NTTCAR	15.16 15.16	48	Tailor's chalk	White Red	1/3
NTZE	6.87	1	Zipper ease		1
NHBSK	18.79	1 kit	Singer® Beginner's Sewing Kit: scissors, needles, pins, thread, measuring tape, thimble, marking pencils, pin cushion, sew/knit gauge, seam ripper included		2/3
NHBT	7.65	1	Basting Tape	1/4" x 11 1/3" yds	2/3
NT301C	12.99	1	Thread clip	4 1/2"	1
NT2025	19.43	1	Scissors	5"	1/3
NT601	13.74	1	Lightweight threadclip	4 3/4"	1/2
NT690	22.16	1	Lightweight dressmaker	9"	1/2
NTTPIN24	15.16	1/2 lb.	T-pin	1 1/2"	1/3
NTX24SD	22.16	1 lb.	Dressmaker pin	1 1/2"	1/7
285	20.74	1 lb.	Straight pin	1"	1/3
NTX3SC	26.49	1440	Safety pin	2" #3	2/3
00	36.03	1440	brass safety	3/4"	1/2



NTEZ

IRON CLEANER



ROWENTA SOLEPLATE CARE CLEANER KIT
ZD100



RESIN FILTER

NTHI450F



NTTIS-NTP5N

IRONING SHOE



834

MEASURING TAPES



NTTMC

MEASURING TAPES

Colors will vary



NTPCT

IRONING SHOE



NTTCA
NTTCAR

TAILOR'S CHALK



NTSR5/
NTSR6

SEAM RIPPER



NT4

NEEDLE THREADER



NTZE

ZIPPER EASE



NHBSK

SINGER
Beginner's Sewing Kit



NHBT

BASTING TAPE



NT301C

THREAD CLIP



NT2025

MULTIPURPOSE SCISSORS



NT690

LIGHTWEIGHT SCISSORS
Fine quality, sharp steel blades with lightweight plastic handle



NT601

LIGHTWEIGHT SCISSORS



NTTPIN24

PINS



NTX24SD

PINS



285

PINS



NTX3SC

PINS



00

PINS

DRESSING ROOM SUPPLIES

STEAMERS



JIFFY CLOTHES STEAMERS & ACCESSORIES

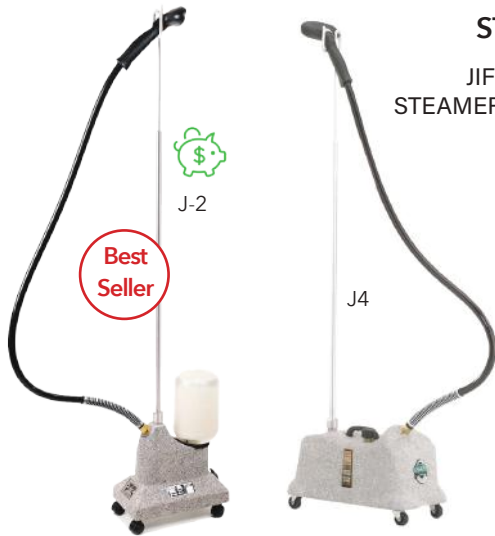

JIFFY HANDHELD STEAMER



STEAM BUTLER ST500



NTIRON

IRONS

STEAM IRON



NH2601



HEAT GLOVES



NTP5N

GRAVITY FEED IRON

Self-contained gravity feed iron system. The water tank gets installed above the iron (about 3 feet) and the gravity forces the water into the iron once the steam button is pushed.



STEAM PRO IRON

VR8324U1



style #	\$	qty	description	size	wgt
J-2	199.90	1	Standard 65" L Hose, 1 gal. water reservoir	1300 watts	18/21
J4	328.67	1	J4000 / Heavy Duty, 65" L Hose, 1 gal. water reservoir	1500 watts	25
J1	166.28	1	Hat Steamer 1 gal. water reservoir	1300 watts	14/21
#3	11.49	1	Replacement bottle for J-2	1 gallon	1/6
2A	81.99	1	Hose/Head replacement for J-2 & J4	65" L Hose	3/4
2C	37.99	1	Replacement head/handle for J1 /J-2/ J4		1/1
1030	45.49	1	Rod & nut set for J1 /J-2/ J4		3/3
J6	86.99	1	Plug In 8 oz. water reservoir	600 watts	3/7
0669	36.42	1	Water tank replacement for J6		1/1
0661	2.99	1	Inside O-ring replacement for J6		1/1
0662	2.99	1	Outside O-ring replacement for J6		1/1
0665	34.99	1	Right case half - J6		1/1
0666	24.99	1	Left case half - J6		1/1
0663	34.99	1	Steam cap w/face plate for J6		1
ST500	114.49	1	Grey Steam Butler 1 gallon water reservoir, snap on brush	1350 watts	19
JC100	12.57	1	Liquid Cleaner	8 oz	2/3
NTIRON	64.54	1	Iron has extra power & steam output; auto off; lifetime sole plate	8 ft. cord	4/10
NH2601	27.49	1 pair	Black Heat Gloves: steam /heat resistant; latex free; machine washable	size Large	1/3
NTP5N	211.51	1	Gravity Feed Iron Comes complete w/ water bottle, hoses, iron rest and filter	120 volt 5 lb.	10/13
VR8324U1	298.07	1	Steam Pro Iron	6.5 bar pump pressure w/ 350g/minute steam boost	10

Jersey Covered Forms BODY FORMS

PREMIUM JERSEY DISPLAY - Dressmaker Forms & Accessories

High-quality professional grade jersey covered forms for dimensional display. Professional, pinnable and long-lasting. Use for display, dressmaking, and tailoring. Create yours for a customized look.

Available in
2 classic colors
cream /CR &
black /BC

1 Select a Jersey Torso Form



Ladies Dress Torso

P26CR / P26BC

Size 8

100.49

7/8" Flange

10/47 lbs

Ladies Blouse Torso

P34CR / P34BC

Size 8

92.99

7/8" Flange

8/47 lbs



Prices reflect torso only.
Complete forms shown for effect.



Mens Shirt /Sweater Torso

P97CR / P97BC

Size 38

84.99

7/8" Flange

9/47 lbs

Mens Coat/Shirt Torso

P85CR / P85BC

Size 38

100.49

7/8" Flange

12/47 lbs



Prices reflect torso only.
Complete forms shown for effect.



Complete the Set: pair one of the Body Form torsos above with a neck block and a base (see p130)

BODY FORMS Jersey Forms /Components

PAIR COMPONENTS: body form torso (p129) + neck block + base

2 Add a Neck Block

WOOD styles



natural walnut mahogany

Wood Finial Neck Blocks 13.99
 Women's styles:
 NB301N / NB301S / NB301M
 Men's styles:
 NB302N / NB302S / NB302M
 (N=Natural / S=Walnut / M=Mahogany)



natural walnut mahogany

Neck Block Caps 11.99
 Women's styles:
 NDISKF / WDISKF / MDISKF
 Men's styles:
 NDISKM / WDISKM / MDISKM
 (N=Natural / W=Walnut / M=Mahogany)

METAL styles



finial disk black metal

UNISEX NECK BLOCKS
Brushed Chrome:
 Finial / FSFSCFIN **50.49**
 Disk / FSFSC **12.99**
Black Metal: BKDISCM 11.99



Add a **HANGING LOOP (HL)** for **\$6.99**

3 Add a Base / Floor Standing

WOOD styles

Round or Tripod:
 42" Total Height
 (24" - Base / 18" - Chrome Pole)
 7/8" Flange compatible
 10/35lbs - 7/21lbs



mahogany natural mahogany natural walnut

Wood Bases - All Versions 50.99
 Round Base: WB172N7/8; WB172S7/8; WB172M7/8
 Tripod Base: WB212N7/8; WB212S7/8; WB212M7/8
 (N, Natural / S, Walnut / M, Mahogany)

METAL styles

Dressmaker Base:
 36" Upright Height
 7/8" Flange compatible
 36 lbs
 Includes casters



DMB2 Natural Metal 110.99

Jersey Form Sets **BODY FORMS**

BOUTIQUE DRESSMAKER FORMS /COMPLETE SETS

 Includes: Cream pinnable form, acorn finial neck block and traditional style base with castors and decorative pedal in black or polished chrome.



NHZMMFBK



NHZMMFCH

Female Dress Sets

NHZMMFBK / **223.99**

Cream with Black

NHZMMFCH / **236.49**

Cream with Polished Chrome

Chest 36.5"
Waist 25.5"
Hip 36.5"
Height 30"
Adj. Height 63"-82"
Weight 22/50

Male Coat Sets

NHZMMMKB / **223.99**

Cream with Black

NHZMMMCH / **236.49**

Cream with Polished Chrome

Chest 40"
Waist 28"
Hip 39"
Height 29"
Adj. Height 60"-79"
Weight 22/50



NHZMMMKB



NHZMMMCH

JERSEY FORM SETS

Complete Sets - Budget Friendly - Professional Grade



NHBFFBM



NHBFFOW

Metal bases have a 48" high pole



NHBFFBW



NHBFFCW

Female Dress Sets

92.99

Satin Chrome Stand and neck cap

Black Jersey NHBFFBM
 Cream Jersey NHBFFOW

Wood Stand and wood neck cap

Black Jersey w/black wood NHBFFBW

Cream Jersey w/natural wood NHBFFCW

Size 8
 Shoulder 15"
 Chest 36"
 Waist 25"
 Hip 36"
 Height 29"
 Weight 15

Male Suit Sets

108.99

Satin Chrome Stand and neck cap

Black Jersey NHBFBMB
 Cream Jersey NHBFCMC

Wood Stand and wood neck cap

Black Jersey w/black wood NHBFBWB

Cream Jersey w/natural wood NHBFCWC

Size 38
 Shoulder 19"
 Chest 38"
 Waist 33"
 Hip 39"
 Height 33"
 Weight 20



NHBFBMB



NHBFCMC



NHBFBWB



NHBFBWC

Wooden bases are 34.5" high

PIN-ON FLEXIBLE ARMS

Male / Female **43.99**

Pinnable flexible arms can be pinned to improved upper torso display. (Fills arms of garments)



FXA001R Female 23 1/4" long 2/12

FXA002R Male 26" long 3/12

BODY FORMS Jersey Forms & Accessories

LADIES & MENS 3/4 LENGTH FORMS

High Quality Jersey-Covered Forms. Versatile - leg mount or hang.
Easy to dress.



Best Sellers!



Hanging Loop (included)

Ladies 3/4 Torso

118.99

P27CR / P27BC
Cream / Black

Size 6
30" High
7/8" Flange
10/45

Mens 3/4 Torso

118.99

P86CR / P86BC
Cream / Black

Size 38
33" High
7/8" Flange
10/45

Price of form includes hanging loop and neck block of your choice:



Each preferred form comes complete with neck block. Specify: **N** (Natural); **W** (Walnut); **M** (Mahogany); **BC** (Brushed Chrome); or **BK** (Black metal).

Hanging Loop **HL** included in price

Bases are sold separately - see leg mount bases (pictured) below right

FLOOR STANDING NOTCHED COSTUMERS with adjustable height

Pairs with hanging jersey forms, full and half round body forms and display hangers.
Hanging loop included - can be easily removed.

see **page 90**
for more details



Notched costumers are also ideal for hanging display hangers



visit **nahanco.com**
for more details



Forms shown hanging from notched costumers
(forms not included)

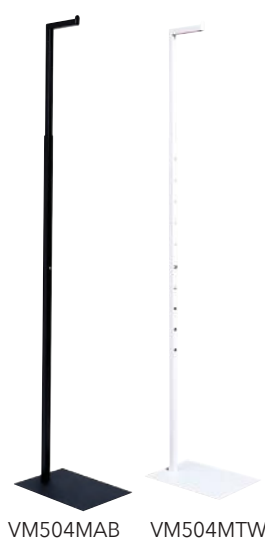

VM504MAB VM504MTW

Sold in Sets of 2

VM504BR - Satin Chrome

99.90

VM504MAB - Matte Black

79.90

VM504MTW - Matte White

79.90

Adjusts every 3" from 51-78"

LEG MOUNT BASES

Leg only bases for use with 3/4 length forms - 7/8" flange compatible

61.99 /each

TFB/58
Matte Black / Center PoleBase/12x12"; 32" High

TFC/58
Brushed Chrome / Offset Pole Base/12x16"; 32" High

Ships in 2 cartons 4/6 actual, 10/13 billable



Polyethylene Forms **BODY FORMS**

Milky White | Budget | Unbreakable | Polyethylene Forms

Affordable and durable display. Color-infused polyethylene, difficult to break or chip, for long lasting display that doesn't need maintaining or replacing. Armless for easy dressing. Realistic display, full round.

FEMALE

Measurements: bust 34" / waist 24" / hip 35"
Order a form only **OR** a complete set for displaying

FEMALE TORSO FORM

NHLP4WH	NHLPH4M	NHLPF4M
Female Torso Form (form only)	Floor Standing Set Hanging base	Floor Standing Set Leg Mount base
Height 35"	Form Height 35" Upright: adjustable 43-74" Base: 14" x 14"	Form Height 35" Upright: 42" Base: 12" x 16"
8/46 lbs	23/60 lbs	24/66 lbs
100.49	155.49	158.99

FEMALE SHIRT FORM

NHLPB4WH	NHLPHB4M	NHLPFB4M
Female Shirt Form (form only)	Floor Standing Set Hanging base	Female Shirt Set Mount base/counter display
Height 24"	Form Height 24" Upright: adjustable 43-74" Base: 14" x 14"	Form Height 24" Upright: 26" Base: 10" x 10"
6/36 lbs	15/60 lbs	12/47 lbs
100.49	148.99	148.99

MALE

Measurements: Chest 39" / waist 32" / hip 37"
Order a form only **OR** a complete set for displaying

MALE SHIRT FORM

NHMPB5WH	NHMPHB5M	NHMPFB5M
Male Shirt Form (form only)	Floor Standing Set Hanging base	Male Shirt Set Mount base/counter display
Height 24"	Form Height 24" Upright: adjustable 43-74" Base: 14" x 14"	Form Height 24" Upright: 26" Base: 10" x 12"
8/36 lbs	20/60 lbs	15/47 lbs
100.49	148.99	141.49

MALE TORSO FORM

NHMP5WH	NHMPH5M	NHMPF5M
Male Torso Form (form only)	Floor Standing Set Hanging base	Floor Standing Set Leg Mount base
Height 40"	Form Height 40" Upright: adjustable 43-74" Base: 14" x 14"	Form Height 40" Upright: 42" Base: 12" x 16"
10/66 lbs	27/60 lbs	24/66 lbs
100.49	155.49	158.99

BODY FORMS Polyethylene Forms

INJECTED MODED HALF-ROUND FORMS - STYRENE
Heavy duty hook included. High quality, long lasting and reusable.

Best Seller!



LADIES
TORSO

LHR15



Ladies
waist - 15" across; bust - 19"; hip - 18";
shoulder to shoulder - 16"; height - 31"
w/out hook & 36" w/hook;
back of form is hollow; matte finish

style #	\$	qty	description / size	wgt
LHR15B	15.99	1	Matte black	6/71
LHR15W			Matte white	

INJECTION MOLDED FORMS
Half-round forms feature high-quality, lightweight construction. The injection molding process ensures that these forms contain much thicker plastic (1/8" thick) than comparable vacuum formed forms.



LADIES UPPER
TORSO

LHR35

Ladies Upper Torso
19 x 17 x 6"
Matte black
Matte white

LHR35B	12.99	1		4/22
LHR35W				

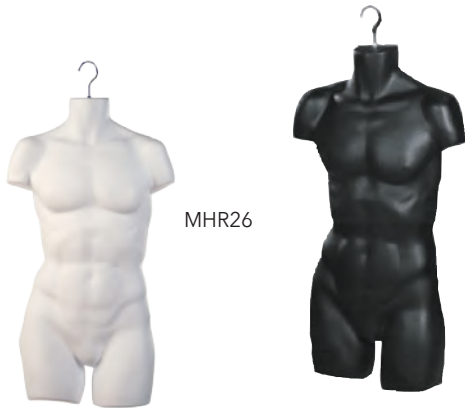

MHR26

MENS TORSO

Mens
35 x 20 x 6"

MHR26B	19.99	1	Matte black	6/71
MHR26W	19.99		Matte white	

HALF-ROUND
VALUE TORSO FORMS

FF15W



Value Torso Forms
** While Supplies Last*

style #	\$	qty	description / size	wgt
FF15B	4.99	1	Girls Sizes 7-14 - 23 x 13 x 1" Black	2/21
FF15W	4.99		White	

FEMALE HIP TORSO



PEFHIPMW

MALE HIP TORSO



PEMHIPMW

Made from Polyethylene - affordable and durable

PEFHIPMW	49.49	1	Female hip torso milky white Hips are 36", waist measures 26" and the form stands at 14" H	6/20
PEMHIPMW	47.49		Male hip torso milky white Hips are 38", waist measures 33" and the form stands at 16"H	6/20

Heads & Hosiery Forms **BODY FORMS**

style #	\$	qty	description / size	wgt
---------	----	-----	--------------------	-----

77	9.07	1	11 1/2" tall / White	1/10
804	19.31		20" tall / White	1/12

3-D STYRO MANNEQUIN HEAD FORMS



77



804

Mannequin heads above have a hole for mounting on wall

Universal Wall Mount - one bracket fits all

2775	14.64	1	Slatwall/ Pegboard head holder	1/2
------	-------	---	--------------------------------	-----



2775



Men's sock display;
magnetic/weighted for stability;
Beige:

HM0340	44.32		Knee high leg, 17 3/4" high	3/10
HM0320	33.18	1	Calf high leg, 11 3/4" high	2/7
HM0310	30.46		Low calf high leg, 10" high	2/7

MEN'S WEIGHTED, SELF-STAND SOCK DISPLAY FORMS



HM0340



HM0320



HM0310

The above three styles feature a stability block



MSDW	23.99	1	White	1/2.1
MSDFT	23.99	1	Beige	1/2.1

fits sizes 10-13

MSDW



MSDFT



TRY ON SOCKS /Foot protectors

TOS1



TOS1B



SO1G



AS1



See page 141 for more
information on our selection of
try on socks and hosiery

DISPLAY FIXTURES Jewelry

BURLAP JEWELRY DISPLAYS

Tightly wrapped burlap for durable, eco-chic displays with a beautiful natural woven linen look



NHNNE1
Narrow Necklaces Easel Back Stand
Thin easel stand; 4 1/4"W x 8 7/8"H; 1 piece; 1 lb. **\$5.99**

NHNNE2
Wide Necklaces Easel Back Stand
Displays 1 double-strand or 2 necklaces; 8 1/4"W x 12 1/2"H; 1 piece; 1 lb. **\$5.99**



NHNBD1
T-Bar Bracelet Display
Holds several bracelets; low profile bar is 1 5/8"D x 7 1/4"W x 5"H; 1 piece; 1 lb. **\$12.99**

NHNBD2
8" Tall Double T-Bar Bracelet Display
10"W x 8"H; 1 piece; 1 lb. **\$25.99**



NHNND2
T-Bar Necklace Display
For necklaces and chains; 12"L x 3 1/2"W x 12"H; bar is 2" in diameter; 1 piece; 1 lb. **\$23.99**

NHNDET
Extra Tall T-Bar Necklace Display
T-Bar stand for necklace and chain displays; 14"W x 18"H; 1 piece; 1 lb. **\$28.99**



Displays 1 pair of earrings

T-Bar Earring Displays
T-stand for earring displays; 1 piece; 1 lb; available in 3 sizes:
Small
NHNEDS2 4 3/4"H; **\$4.99**
Medium
NHNEDTS 5 3/4"H; **\$6.49**
Tall
NHNEDS3 6 3/4"H; **\$6.99**



Fixed Finger Ring Displays
Fixed fingers fit and display any ring; 1 piece; 1 lb.
Single Finger
NHNRD5 2 1/8"L x 2 1/8"W x 2 3/8"H; **\$3.99**
Three Finger
NHNRD3 4 7/8"L x 2 1/4"W x 2"H; **\$6.99**
Five Finger
NHNRD5 8"L x 2"W x 2 1/4"H; **\$11.99**



NHNBD3
Pillow Jewelry Display
Small burlap pillow for displaying bracelets, small pendants and pins; 3"L x 3"W; 1 piece; 1 lb. **\$3.99**



NHNEDFL
Earring & Pendant Display Stand
For 1 pair of earrings or a pendant; 2"W x 3"H; 1 piece; 1 lb. **\$3.99**

ECONOMY BLACK VELVET JEWELRY DISPLAYS

A range of displayers finished in a flocked, faux velvet. Attractive & affordable.



252-3
Earring Display Tree
Accommodates 12 pairs of earrings on 3 display bars; 10 1/4"W x 8 1/2"H; 1 piece; 1 lb. **\$23.99**



NHBFE1
Easel Necklace Stand
Single necklace or chain display; 3 3/4"L x 5 1/4"H; 1 piece; 1 lb. **\$4.15**



NHBFRD1
Finger Displays
Fixed fingers ring displays; 1 piece; 1 lb.
Single Finger
NHBFRD1 2 1/4"L x 2 1/4"W x 2 1/4"H; **\$3.99**
Five Finger
NHBFRD5 8"L x 2"W x 2 1/2"H; **\$11.99**



NHBEPDB
Earring & Pendant Display
2"W x 3"H; 1 piece; 1 lb. **\$2.99**



NHBFPD1
Pillow Displays
Versatile displayers for bracelets, watches and pins; 1 piece; 1 lb. **Small** about 3"L x 3"W **\$2.99**

Jewelry DISPLAY FIXTURES

JEWELRY DISPLAYERS

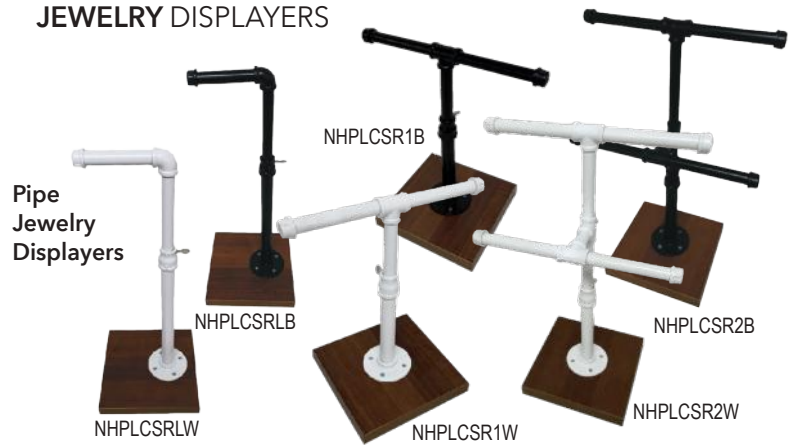

Pipe Jewelry Displayers



Rotating Jewelry Displayer



Acrylic T-Bar Jewelry Displayers

Jewelry Cards

Cards can also be used on displayers and peg hooks.



JCB100

JCW100

856

Counter Top Revolving Jewelry Display Holds 108 two-inch cards.

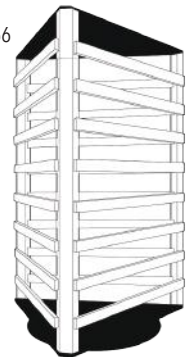

style #	\$	qty	description	size	wgt
Black or White counter top jewelry displays w/adjustable heights and a 8" x 8" cherry wood base					
NHPLCSR1W NHPLCSR1B	28.49	1	L-shaped hang bar: white black	3 1/2" w bar; 21 -31" high	2
NHPLCSR1W NHPLCSR1B	28.49	1	Single T hang bar: white black	12" w bar; 17-22" h	2
NHPLCSR2W NHPLCSR2B	34.49	1	Double T hang bar: white black	12" w bars; 17-22" h	2/3
NHAND2	10.50	1	Clear acrylic double T	4 1/4" / 8 3/4"	1/3
NHAND1	9.07	1	Clear acrylic single T	18 1/2" H	2/6
4-sided rotating display					
NHAED32	16.72	1	Holds 32 cards - 2"	5 x 5 x12"	3/19
NHAED144	29.16	1	Holds 144 cards - 2"	10 1/2 x 10 1/2 x 19 1/2"	18/23
3-sided rotating display					
856	25.99	1	Clear acrylic w/ black	19 1/2" H	5/10
JCW100	11.79	100	White card	2" x 2"	1/2
JCB100			Black card		
JT1	23.49	1000	White w/ red silk string	1/2 x 7/8"	1/3
JT2	18.01			3/8 x 3/4"	
JT3	13.61		White Adhesive	7/16 x 11/2"	
JT4	13.74			9/16 x 15/8"	
JPC1	5.75	1	Yellow	7 1/2"L x 5" W	1
A845	8.42	1 Set of three	CLEAR	3x3x3" 4x4x4" 5x5x5"	2/6
J1394	8.68	1	Clear CounterStand	13/4 x23/4 x3"	1
J2394	9.72	1	Clear Slatwall	2 1/8"	

Jewelry Tags



JT1

JT2

JT3

JT4

Jewelry Risers



A845

JPC1

Jewelry Polishing Cloth

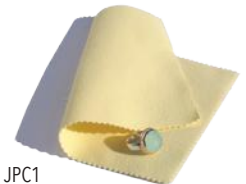

J1394



DISPLAY FIXTURES Jewelry

Double Face Mirrors



NHQ61016



Q61014

style #	\$	qty	description	size	wgt
Q61014	63.12	1	CHROME oval mirror	10x14x22" 6" base	8/13

NHQ61016	67.26	1	CHROME rectangular mirror	10 x 12" H 3" base	8/13
----------	-------	---	---------------------------	-----------------------	------

A859



Sunglass Racks



SUNGLASS36



SUNGLASS44

A859	70.11	1	CLEAR ACRYLIC 2" or 3" D shelves	7"D x 15"W x 10"H	2/10
------	-------	---	-------------------------------------	----------------------	------

SUNGLASS36	114.49	1	Sunglass rack w/ 5" mirror - holds 36 pairs	28" H x 14" Dia	8/30
------------	--------	---	---	--------------------	------

SUNGLASS44	105.99	1	Sunglass rack w/ 5" mirror - holds 44 pairs	32" H x 14" Dia	9/30
------------	--------	---	---	--------------------	------

Reversible Counter Step Display



Countertop
or Hanging
Cap Display

CAP3

BLACK METAL					
CAP3	56.99	1	Holds 24 to 30 caps	24H x 9W x 13"D	6/12

POWDER COATED wire tubing Silvervein:					
CAP8	138.67	1	Holds 64 to 80 caps: 8 pocket tower	65H x 14W x 14"D	16/17

CAP16	202.56	1	Holds 128 to 160 caps 16 pocket, 2 sided	65H x 14W x 24"D	16/17 10/13 (2 ctns)
-------	--------	---	---	---------------------	----------------------------

Tower Cap Displayers

CAP16



Deluxe Cap/ Hat Trees

Revolving or
stationary - 20
arms with
foam caps



K26

KREV26	155.49	1	CHROME Revolving	18x61 3/8" 14" sq. base	1 14 5 14 (4 ctns) 34 lbs
--------	--------	---	---------------------	----------------------------	--

K26	132.49	1	CHROME Stationary	18x61 3/8" 14" sq. base	14 5 14 (3 ctns) 33 lbs
-----	--------	---	----------------------	----------------------------	-------------------------------------

CAP8



Countertop Handbag Stand

NHCSRHB



NHCSRHB	37.45	1	CHROME	17" - 31" H; 8" base	6/18
---------	-------	---	--------	-------------------------	------

Blouse Displayer
Complete w/ base and
waist cincher
Q61814



Q61814	42.38	1	CHROME	5/8 x 18"-36"H 6" base 16" hanger	7/19
--------	-------	---	--------	--	------

Hook Stand Displayer



Scarf Stand

Includes 100
white clips

Q83010

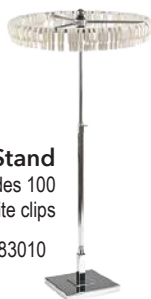

Q61810	32.66	1	CHROME	5/8 x 18"-36"H 6" base	6/19
--------	-------	---	--------	------------------------------	------

Q83010	65.97	1	CHROME	5/8 x 18"-36"H 8" base 14" dia.	8/13
--------	-------	---	--------	--	------

SHOE DISPLAYERS

style #	\$	qty	description / size	wgt
MF0040	4.67	1	Clear Plastic Espadrille Form, size 6-7	1/7
MF0013	5.18	1	Clear Plastic Gladiator Form, size 6-7, 13" tall	1/7



Espadrille & Gladiator Forms
Profile of foot, with notched ridges for straps



Z-Bend Shoe Rests

1205	31.88	1 set	Acrylic 3"W x 5"H 3"W x 6 1/2"H 3"W x 8"H 5mm thick bottom measures 5 1/2" deep Set includes all 3 sizes	10/17
------	-------	-------	--	-------

Beveled Edge Slant Shoe Risers



Shoe Rests



G-Bend Shoe Risers



1229A	8.42	1	Acrylic 3/16" thick	3
1229B	9.72	1	9 1/4"L x 4"W x 5"H	3
1229C	11.15	1	9 1/4"L x 4"W x 7"H	3/6
1230	22.29	1 set	9 1/4"L x 4"W x 9"H Set includes all 3 sizes	3/6

1413	8.29	1	Acrylic 1/8" thick Single Shoe Rest 4 3/4"H x 3"W x 3 3/4"D	1/2
------	------	---	--	-----

See page 135 and 140-141 for our selection of foot & hosiery forms

1210	40.18	1 set	Acrylic 4 mm thick, 7 1/2" D 3"W x 4 1/2"H 3"W x 6 1/2"H 3"W x 9 1/2"H Set includes all 3 sizes	3/10
------	-------	-------	--	------

Natural color in four sizes:

ZDB109OF1	31.88		9" high	1/2
ZDB113OF1	34.73	12	13" high	2/6
ZDB121OF1	52.75		21" high	4
ZDB126OF1	58.32		26" high	4



ZDB1210F1



Roll Up Boot Shapers

Inexpensive boot shapers are made out of a smooth natural plastic finish, easy to insert and remove, and they automatically adjust to fill the boot; in four sizes - 9", 13", 21" and 26"

Boot Shapers

ZDB

Smooth plastic finish.
Easy to insert and remove.
Specify (M) Male or (F) Female



ZDB1240	7.65		7" low top	1/2
ZDB1230	8.42	1	9" medium height	1/2
ZDB1020	9.72		14" high top tall	2/6

Specify **M** for male and **F** for female
Note that male boot shapers are 1" wider than female shapers

MAR6121PR	10.53	1 pair	14" black plastic boot form	1/2
-----------	-------	--------	-----------------------------	-----



MAR6121PR



Boot Weights

Drop into boots for a more stable display



ZSHOT060

ZSHOT060	3.50	1	Boot weight	1
----------	------	---	-------------	---

SHOE DISPLAYERS



Sandal Hangers

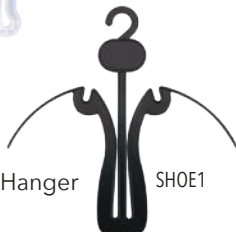

Sport Sandal Forms
Full-round sandal forms specifically designed for open or closed sandals. Also fits thong styles.

Shoe Forms

Fits right or left shoe. Made from lightweight, natural plastic.



Flexi-Form

Made from lightweight, unbreakable plastic.



Black Shoe Forms - womens/mens



8-Shelf Shoe Merchandiser
Includes 12" adjustable, tilt shelves. 
Ships via truck only

style #	\$	qty	description / size	wgt
710CH	132.09	100	Chrome w/ black rubber tips; 5" wide	10
JLP156	52.97	500	3 7/8" W x 3 7/8" H	9/12
JLP156100	20.61	100	Natural	3/6
JLP256	52.97	500	Black	9/12
JLP256100	19.36	100		3/6
SH1	22.49	500	Black; 3 1/2" wide	2
SH1-100	7.49	100		1/2
SHOE1	103.19	500	Black; 7 1/4" W x 7 1/4" H	19/21
SHOE1100	22.52	100		4/6
KLGYMR			Men's Gray Sprinkle Right - size 8-9	
KLGYML			Men's Gray Sprinkle Left - size 8-9	
KLGYWR	15.29	1	Women's Gray Sprinkle Right - size 6-7	1/2
KLGYWL			Women's Gray Sprinkle Left - size 6-7	
KLGYR13			Children's Gray Sprinkle Right - size 13	
KLGYL13			Children's Gray Sprinkle Left - size 13	
SHOEFORM10	.45		3 3/8" long, 3" wide	
SHOEFORM13	.89	1	4 1/4" long, 3 1/2" wide	1/2
SHOEFORMMM	.58		4 7/8" long, 3" wide	
SHOEFORMMW	.65		5 7/8" long, 3" wide	
FM7400B			Charcoal Men's, sizes 8-10	
FW7500B	4.15	1	Women's, sizes 4-10	1/2
FC7600B			Children's, sizes 10-13	
FRMDISWB	6.87		Women's Low-cut black Fits sizes 6-9	
FRMDISMB	6.87	1	Men's Low-cut black Fits sizes 8-11	1/2
FRMDISMHB	8.29		Men's High-top Black Fits sizes 8-11	
FRMDISWHB	8.29		Women's High-top Black Fits sizes 6-9	
SSUE	328.49	1	Chrome 56"H x 46"W x 25"D Ships Truck	25 20/25 20/25 (3 ctrns)

SHOE DISPLAYERS

style # \$ qty description size wgt

SDM				Men's	
SDW				Women's	
SDC	88.78	1	CHROME	Children's	2/6
SDA				Athletic	

* Style SDA measure both men and women

SDJ	90.07	1	STURDY PLASTIC	Junior	2/6
24625	20.87	1	Wood; measures men, women and children	17 x 1 1/2"	1/2

T14915	138.54	50			2/3
			GREY	9"	
T14915-10	31.88	10			1/2

06UPC02	5.99	144	BRONZE	1 1/8"	1/2
---------	------	-----	--------	--------	-----

While Supplies Last

Disposable, Polyester/
Nylon Blend

TOS1	8.29	144	BEIGE	ONE	1/3
TOS1B	8.29	144	BLACK	SIZE FITS	1/3
SO1G	16.72	24	BLACK	MOST	1/3
AS1	23.59	50	WHITE		2/7
05010	13.87	48	BEIGE KNEE-HI		1/3

NHSDR	110.15	1	Black Metal Rack; 4 spinning tiers w/16 hooks & sign holder; 66"H, 24" footprint, 5" long hooks	66"H, 24" footprint, 5" long hooks	14/24
-------	--------	---	---	------------------------------------	-------

09059	96.49	144		3"	7
-------	-------	-----	--	----	---

09059/12	8.99	12	NICKEL PLATED	3"	1
----------	------	----	---------------	----	---

SHOEBLA	31.88	144	BLACK	3 1/2"	7
---------	-------	-----	-------	--------	---

SHOEBLAI	62.34	144	BLACK printed	3 1/2"	7
----------	-------	-----	---------------	--------	---

Shoe horns can be printed: Printing area is 2" x 1/2". \$75 plate charge, and a 3 gross minimum (342 pieces) for imprinting. Shoe horns also available in COLORS: 3 gross minimum (342 pieces). Green, Red, Yellow, Blue or White

MBR	37.45	1	Wood box reacher w/ metal end	60" L; 4" square metal plate, L-shaped	4/7
-----	-------	---	-------------------------------	--	-----

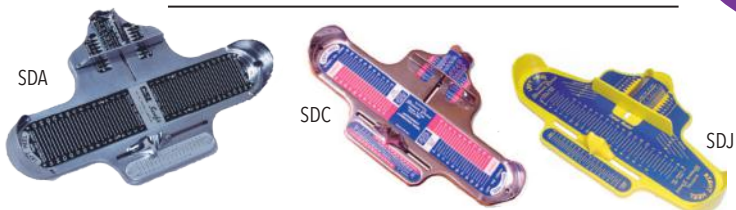

FOOT MEASURING DEVICES



24625

T14915



Grey Tether with Split Ring/Adhesive Backing
For securing shoes on display.



06UPC02

Bronze Sign-Holder Clip
Clips small signs to the back of footwear.

Try On Socks

Foot protectors



TOS1 TOS1B SO1G AS1



Best Seller!

05010

new

Holder for 8.5"x11" signs



NHSDR



Spinning Sock Displayer



Shoe Horns

Call for color and printing options

09059

SHOEBLA



MBR

Box Reacher
Remove shoe boxes from high shelves with our 5-foot long tool.



PACKAGING Kraft Shopping Bags

Available in 3 colors - White, Kraft, and Matte Black.

These bags are imprintable and a great way to advertise your store.

See page 143 for more details.



SBCN2E



SBCN7E



SBVN1



SBVN1E



SBVN2E



SBQN1



SBQN2E



KSB4E



KSB5E



KSB6E



KSB7E



KSB81



KSB82E



KSB91



KSB92E

CUSTOM PRINTING: Custom printing applies to all style numbers below - see following page 143 for details

	style #	\$	qty	color	size	imprint area	wgt
1	SBCN2E	59.99	250	Kraft Eco	8x4.75x10.5"	6x5"	24/30
2	SBCN7E	73.99	250	Kraft Eco	10X5X13"	7X8"	24/30
3	SBVN1	86.99	250	White	16x6x12.5"	10x7"	38/52
4	SBVN1E	87.32	250	White Eco	16x6x12.5"	10x7"	38/52
	SBVN2E	107.99	250	Kraft Eco	16x6x12.5"	10x7"	38/52
5	SBQN1	88.99	200	White	16x6x19"	10x11"	43
6	SBQN2E	89.99	200	Kraft Eco	16x6x19"	10x11"	42
7	KSB4E	35.99	250	White Eco	6x3.25x8.375"	3x4"	15
	KSB5E	36.99	250	Natural Eco	6x3.25x8.375"	3x4"	15
8	KSB6E	66.41	250	White Eco	10x7x13.5"	7x8"	43
	KSB7E	73.99	250	Natural Eco	10x7x13.5"	7x8"	43
9	KSB81	80.99	250	White	13x7x13.5"	9x8"	29
	KSB82E	63.99	250	Natural Eco	13x7x13.5"	9x8"	29
10	KSB91	92.99	250	White	13x7x17"	9x9"	44
	KSB92E	121.99	250	Natural Eco	13x7x17"	9x9"	44

A note about imprint areas and set-up fees:

2 different bag sizes will need 2 different set ups.

- check the imprint area specs on for more info

different size imprint areas will need different set ups

KSB82E



Custom Kraft Bags PACKAGING

CUSTOM BAG OPTIONS for our Natural, White or Black Kraft bags

Create walking billboards for your store

STEP 1

CHOOSE A BAG

Choose from any of our Natural, White or Black Kraft bags featured on [page 142](#)

STEP 2

DESIGN IT

(Choose from 2 print options below)



INK PRINT

A flexible plate is dipped in liquid ink and stamped onto the bag.

ADVANTAGES: Can print small details.

DISADVANTAGES: Ink color appearances may vary.

COST: \$0.28 per side, per bag / \$0.56 for both sides



HOT STAMP

Foils are pressed and transferred through heat onto the bag.

ADVANTAGES: Produces a true, even color.

DISADVANTAGES: Doesn't allow for small details.

COST: \$0.45 per side, per bag / \$0.90 for both sides



Ink Print



Hot Stamp

STEP 3

SET IT UP & PLACE YOUR ORDER

ARTWORK

Vector files are preferred - Illustrator (.ai) files are best. (.docx files will not be accepted)

If artwork quality is not acceptable, art fees may apply.

Please call us (1-800-426-4377) for assistance

SET-UP FEES

Ink Printing and Hot Stamp

Set up fees are per bag size, per order

Please call for set-up fees

ORDERING

Call it in:

1.800.426.4377 and speak with one of our Customer Reps

You can also connect with us via email (mail@nahanco.com)

PACKAGING Shopping Bags

ECO KRAFT EURO SHOPPERS/BAGS



ECO NATURAL KRAFT EURO SHOPPERS/BAGS

style #	\$	qty	description	size	wgt
NHK19616	171.99	100	XX-Large Shopper	19 x 6 x 16"	48/49
NHK1010	145.99	200	X-Large Shopper	10 1/4 x 10 x 10"	30/31
NHK1048	94.99	200	Large Shopper	10 x 4 x 8"	23/24
NHSN513	46.99	250	Tall Wine/Gift Bag w/Serrated Edge	5 1/4 x 3 1/2 x 13"	19/21

Eco friendly, reusable, recyclable and compostable, these bags are made of 80% recycled fibers and 80% post-consumer content

CARNIVAL GROOVE EUROTOTES (KE)



CARNIVAL GROOVE EUROTOTES

KE9NH	96.49	200	Kraft w/ natural	9x3 1/2x7"	20
KE13	145.99	200	cotton handles; top &	13x5x10"	33
KE16NH	94.99	100	bottom board inserts	16x5x13"	23

NHF020THA



REINFORCED DIE CUT THANK YOU BAGS

NHF015THA

THANK YOU DIE CUT BAGS

NHF015THA	95.49	500	Medium	15x18x4"	24
NHF020THA	126.99	500	Large	20x20x5"	35

SUPER GLOSS MERCHANDISING BAGS

In 2 sizes and 2 colors



Clear

White



SUPER GLOSS BAGS

NHSG9WH	55.49	1000	White - small	9 x 12"	11
NHSG9CLE			Clear - small	1.25 mil.	
NHSG12WH	76.49	1000	White - medium	12 x 15"	16
NHSG12CLE			Clear - medium	1.25 mil.	

PLASTIC MERCHANDISE BAGS

Economy, high density plastic



Type style and color may vary



Cannot be imprinted

PLASTIC MERCHANDISE BAGS

TSB3-30	27.09	1000	Thank You Type style & color may vary	11 1/2 x 6 1/2 x 21"	13
BGA2-1	51.99	1000	White	12x15"	10

Tissue & Boxes **PACKAGING**

style #	\$	qty	description	size	wgt
TP1	38.99	1000	WHITE	18 x 24"	10/14
TP2	49.99	sheets	Tissue Paper	20 x 30"	15/22
TP3	58.32	500 sheets	WHITE Tissue Paper	24 x 36"	?
TP25	47.28	480 sheets	BLACK Tissue Paper	20 x 30"	7
NH11018	24.49	sheets	Solid Recycled KRAFT Tissue Paper		9
TIKNP	50.99	2400 sheets	NEWSPRINT Heavy Tissue Paper for bulky items	15 x 20"	50



WHITE TISSUE

BLACK TISSUE

KRAFT TISSUE

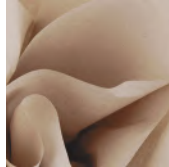

NEWSPAPER PRINT TISSUE

WHITE:					
AB2	82.49	100	Shirts	15x9½x2"	29
AB3	63.49	50	Sweaters	17x11x2½"	20/21
AB4	68.99	25	Coats	24x14x4"	21/28
KRAFT:					
KAB2	78.99	100	Shirts	15x9½x2"	27/29
KAB4	61.99	25	Coats	24x14x4"	23

WHITE APPAREL BOXES



KAB 2 / 4

AB 2/3/4

NATURAL APPAREL BOXES with kraft interior

CORRUGATED BOXES

NH1293BLA	96.49		Black		
NH1293NAT	67.99	24	Natural	3" h x 12" l x 9" w	16
NH1293WHI	96.99		White		
NH883BLA	125.99		Black		
NH883NAT	103.99	48	Natural	3" h x 8" l x 8" w	22
NH883WHI	125.99		White		
NH994BLA	178.49		Black		
NH994NAT	119.99	48	Natural	4" h x 9" l x 9" w	30
NH994WHI	178.49		White		



CORRUGATED E-COMMERCE BOXES

available in four sizes



NH1293BLA

NH994WHI

NH883NAT

WHITE

COTTON FILLED JEWELRY BOXES

JB1	26.99	100	Earring	2½x1½x 7/8"	4/6
JB2	37.11	100	Bracelet	3½x3½x1"	12/14
JB3	48.07	100	Necklace	8x2x 7/8"	10/15
JB4	40.99	100	Large pin	5½x3¾x 7/8"	10/19

JB 1/2/3/4

JB 1/2/3N

KRAFT

JB1N	22.49	100	Earring	2½x1½x 7/8"	4/6
JB2N	31.91	100	Bracelet	3½x3½x1"	12/14
JB3N	48.99	100	Necklace	8x2x 7/8"	10/15



index

Acrylic sign holders ..94, 105, 108, 117	Foot/Leg forms 134, 140-141	Needles (replacement) 73-74	Signs 113-115, 123
Alteration tags34, 78	Foot measuring device 141	Non slip attachments 18, 67	Size dividers & markers 56-60
Bagging Jack79	Garment bags 33, 79-80	Package hangers 68	Slatwall & accessories 101-105
Bags 33, 79-80	Glass toppers (round racks) 89	Packaging 142-145	Slatwall panels 101-102
Baskets100, 108, 126	Glove hangers 43	Peagboard accessories 111	Sleeping bag hangers 43
Bedsread hangers 43	Grabber 69	Pennants 120	Sock hangers 66
Belt hanger66	Grid wall & accessories 106-108	Pipeline Series91-95, 10	Stain Remover 125
Belt racks90, 104	Handbag racks..... 85, 138	Pins 127	Standards & accessories 109-110
Bikini hangers16, 39	Hang all clips 61-63	Pin tickets 78	Steamers 128
Body forms 129-135	Hanger accessories 18, 67	Plastic hangers 34-38, 41, 45-55	Storage tray 60
Boot hanger 140	Hanger collection racks 70-71	Polybag rolls & dispensers 79	Suit covers 79-80
Boot shapers & weights 140	Hangers (garment) 12-55	Pricing Supplies 73-78	Sunglass racks 138
Boxes (gift, apparel, jewelry) 145	Hanger stackers 71	Rack cover 82-83	Swimwear hangers 16, 39
Boxes (storage) 69	Hanger storage 69	Racks (garment) 81-97	Tables 94
Box reacher 69, 14	Hanger strips, connectors 61-62, 68	Reaching hook 69	Tacking hooks 66, 75
Bridal bags33, 80	Hat hangers 43	Register Stands 98	Tagging tools 73-75
Bulletin sign holders 115	Head forms 135	Repair tags 77-78	Tags 77-78
Cap Racks 138	Hosiery forms 135	Rolling racks 81-84, 91-92, 95, 97	Tailor supplies 127
Card frames 115, 116	Hotel hangers 25	Rubber hangers12-19, 30-32, 39-40	Tie hanger66
Cards /stock signs 114	Intimate apparel hangers32, 40-41	S Hooks 63, 118	Tie racks 90
Casters (racks)..... 86-87, 90, 92, 95	Irons & Accessories..... 127-128	Safety pins 127	Tissue paper 145
Chalkboards 120	Jean hooks 63	Sandal forms 139-140	Traffic control 121-123
Circle fasteners 75	Jersey Forms..... 129-132	Sandal hangers 140	Try-on protectors 125
Clamps (sign holders) 94, 116	Jewelry displays 136-137	Satin hangers 40	Tubing & accessories 112
Cleaning gun & solvent 125	Jewelry tags & cards 137	Scarf racks 138	Tubular hangers 55
Clips 61-63, 65-66	Kraft bags 135-137	Scarf rings/hangers 61-62, 64, 66	Twist on arms (racks) 86
Clothing racks 81-96	Kraft tags 78	Scissors 127	Utility Racks/Storage 84
Coordinate strips 68	Kraft tissue 145	Seam ripper 127	VICS hangers 54
Counterfeit detector pen 124	Labels (pricing) 78	Secure lock system 124	Wall mount accessories 111-112
Counterfeit cash detector kit 124	Labels (sizing) 60	Security devices 124	Wooden hangers 6-8, 12-32, 39-40
Display bins100	Ladder systems 96	Shelves 99	Workstations 72
Display hangers 15, 29, 38-39	Layaway tags 78	Shoe accessories 139-141	Z-racks 83
Door alarms 124	LED sign 120	Shoe forms 139-140	
Dressing room supplies 125-128	Leggings hangers 61-62, 64	Shoe horns 141	
Dry cleaning hangers 55	Lint rollers 125	Shoe merchandisers 139-141	
Dump bins100	Literature holders 105, 111, 117	Shoe risers 139	
Fabric brushes..... 125	Mannequin forms 133-135	Shopping baskets 126	
Fasteners 73-75	Markers 120	Shopping bags 142-144	
Fitting room checks 126	Marking tools 75-76	Shoulder covers 80	
Fitting clips 34, 65	Measuring tape 127	Showcases 98	
Flags 120	Message boards 120	Sidewalk signs 115, 120	
Flocked hangers 37	Metal Hangers 25, 39, 41-44	Sign kits 113, 115, 119-120	
Foam hanger covers 67	Millinery display 104, 138	Sign holders 94, 108, 114-119, 123	
Folding boards 72	Mirrors (counter) 138	Sign hanging systems 118-119	

More Ways to Pay

Terms: Net 30 days credit. Sorry, no CODs.

Credit Cards:



Prepayment: prepay by ACH or wire payment in advance.

Pricing

Prices are subject to change without notice.

Shipping Information

Shipments are made F.O.B. our warehouse or point of origin. Small orders ship via UPS. Some packages bill as oversized by UPS. When orders exceed UPS limits, we ship via common carrier.

Returns

If you're not satisfied with your purchase, please contact us, explain the problem and we'll take the necessary steps to resolve the problem to your satisfaction. At times there may be a 25% restocking charge for items returned plus freight costs. Customer service will advise you of these charges should they apply to you. Sorry...**No Returns after 30 days.**

Carrier Damage

Our products are inspected prior to shipment and any customer claims for visible or concealed damage must be made with the delivering carrier. Our responsibility ceases when the merchandise is turned over to the carrier.

Backorders

Unfortunately, on occasion we may have to backorder an item. As soon as the item is available, we will ship it - unless otherwise requested not to. If an item is out of stock for more than 30 days, we will notify you.

Please note that we are not responsible for typographical errors.

THE BENEFITS OF WORKING WITH US

Our US-based industry professionals are available to consult with you on your business needs.

With over 100 years of experience in the retail industry, we have unmatched experience in building and executing custom programs designed for your individual business needs.

We offer customizable reporting on your historical usage and spend.

We leverage our buying power to offer highly competitive prices on the items you buy - whether a one-off need or a high-volume, ongoing supply program.

THE RANGE OF SERVICES WE PROVIDE



E COMMERCE ORDERING PLATFORM

Our web-based ordering platform can be customized to your brand-specific catalog.



WAREHOUSING & INVENTORY MGMT

We can maintain inventory of the items you buy from us, so they are ready to ship when you need them.



SOURCING

Custom, branded or generic merchandising supplies; domestic or imported, we have you covered.



LOGISTICS & DISTRIBUTION

Services are scaled to fit your needs: to your warehouse, direct roll-outs or consolidated shipments.

SUSTAINABILITY

One of the most important and sensitive topics on the planet today - especially as it applies to the business world. NAHANCO endeavors to be ever more sustainable with each passing year.

SUSTAINABILITY AND NAHANCO HANGERS:

WOOD

All of our Wood Hangers are made from sustainable materials - Lotus wood and Bamboo - that are grown in China.



PLASTIC

Plastic Hangers have a useable shelf life of over ten years. And if damaged, the hanger can be recycled. We recycle our own scrap plastic from the manufacturing process.



Every manufacturing process produces a little excess that doesn't meet standards.

RECYCLED PLASTICS

Our black hangers are made of up to 80% internal and external recycled plastic material. All other hangers we manufacture use up to 20% of internal recycled plastic.



Classic 2505 style



New 8505 style
(100% recycled plastic)



We're reducing waste, conserving resources, and keeping production right here in the USA. NAHANCO continues to innovate for a more sustainable future.



NATIONAL HANGER COMPANY
P.O. Box 818, 276 Water St
North Bennington, VT 05257

2026



NAHANCO PRO

Streamline your retail supply ordering
AND keep the exceptional NAHANCO
customer service you love.

- ✓ FREE Client Membership
- ✓ 24/7 Online Ordering
- ✓ Special Client Pricing
- ✓ Multi-User Platform
- ✓ Real-Time Order Tracking/History
- ✓ Personalized Supply Catalogs

SIGN UP TODAY!

NAHANCOPRO.com
1.800.HANGERS

