

FERMAX

Produktbrochure - ADK



FERMAX

Resistant

Anti-vandal access control range
Maximum robustness IP66 IK09



REF.5238

RESISTANT MEMOKEY KIT

Memokey + Proximity Resistant is a stand-alone anti-vandal access control unit with integrated keypad and contactless proximity reader that lets you manage up to 600 users.



REF.5237

RESISTANT PROXIMITY KIT

Proximity Resistant is a stand-alone anti-vandal access reader with capacity for up to 1000 cards due to its connection to external controller (ref.5276).

1. Access control kits





4905 EM CITYLINE PROXIMITY KIT 		
Authentication: Proximity (EM)	Aesthetic: Cityline	Controller: Integrated
Authorisations: Master card	Users: 400	
Flush mounted. Includes reader (ref.6992), power supply 12Vac/1A (ref.4802), 5 cards EM (ref.23361) and 1 key fob EM (ref.4515) and S1 flush box (ref.8948)		
Optional	5276 MINI STAND-ALONE CONTROLLER* (External controller, 1000 users, remote control IR)	
	2306 MANUAL PROGRAMING KEYPAD (Programmer compatible with FERMAX EM cards)	





4906 CITYLINE MEMOKEY KIT		
Authentication: PIN	Aesthetic: Cityline	Controller: Integrated
Authorisations: Master PIN	Users: 100	
Flush mounted. Includes keypad (ref.6991) and power supply 12Vac/1A (ref.4802) and S1 flush box (ref.8948)		



5238 RESISTANT MEMOKEY KIT  		
Authentication: Pin/Proximity (MIFARE/EM)	Aesthetic: Resistant	Controller: Integrated
Authorisations: PIN Master	Users: 600	
Includes keypad (ref.5293), power supply 12Vac/1A (ref.4802), 3 cards MIFARE (ref.52750) and 2 key fob MIFARE (ref.52740). Authentication options: PIN only, Proximity only, PIN+Proximity.		
Optional	5276 MINI STAND-ALONE CONTROLLER* (External controller, 1000 Users, remote control IR, secure door)	



5237 RESISTANT PROXIMITY KIT  		
Authentication: Proximity (MIFARE/EM)	Aesthetic: Resistant	Controller: External
Authorisations: IR Remote control	Users: 1000	
Includes proximity reader (ref.5296), controller with IR remote control (ref.5276), power supply 12Vdc/2A (ref.4813), 3 cards MIFARE (ref.52750) y 2 key fob MIFARE (ref.52740).		



5249 RF 868MHZ SYSTEM KIT FOR SHOPS		
Authentication: RF	Aesthetic: Other	Controller: Integrated
Authorisations: Prog.button	Users: 500	
It includes receiver (ref.5250), power supply 12Vac/1A (ref.4802) and 3 remote controls (ref.5259).		

* Ref. 5276 requires 12Vdc power supply via additional power supply ref. 4813.

2. Readers and keypads

INTEGRATED Controller



ref.6992/6957







ref.6991



ref.5293



ref.5250

6992 EM CITYLINE PROXIMITY READER 		
Authentication: Proximity (EM)	Aesthetic: Cityline	Controller: Integrated
Authorisations: Master card	Users: 400	Includes flush box S1 ref. 8948
6957 CITYLINE DESFIRE PROXIMITY READER  NEW		
Authentication: Proximity	Aesthetic: Cityline	Controller: Integrated
Authorisations: Master card	Users: 400	Includes flush box S1 ref. 8948
6991 CITYLINE MEMOKEY		
Authentication: PIN	Aesthetic: Cityline	Controller: Integrated
Authorisations: PIN Master	Users: 100	Includes flush box S1 ref. 8948
5293 RESISTANT KEYPAD W/PROXIMITY  		
Authentication: PIN/Proximity (MIFARE/EM)	Aesthetic: Resistant	Controller: Integrated
Authorisations: PIN Master	Users: 600	
Optional	5276. CONTROLLER MINI* (C.External, 1000 users, control remote IR)	
5250 RF BASIC-2B RECEIVER		
Authentication: RF	Aesthetic: Other	Controller: Integrated
Authorisations: Prog.button	Users: 500	

* Ref. 5276 requires 12Vdc power supply via additional power supply ref. 4813.

EXTERNAL Controller

The following devices only have a Wiegand output and require a stand-alone External mini Controller ref. 5276:



ref.6958/6957







ref.5296



ref.5190



ref.5266

6958 CITYLINE WG MIFARE/EM PROXIMITY READER  		
Authentication: Proximity (MIFARE/EM)	Aesthetic: Cityline	Controller: External
6957 CITYLINE DESFIRE PROXIMITY READER  NEW		
Authentication: Proximity (DESFIRE)	Aesthetic: Cityline	Controller: External
Includes flush box S1 ref. 8948		
5296 EM/MIFARE WIEGAND RESISTANT PROXIMITY READER  		
Authentication: Proximity (EM/MIFARE)	Aesthetic: Resistant	Controller: External
Includes flush box S1 ref. 8948		
5190 WIEGAND CITYLINE KEYPAD		
Authentication: PIN	Aesthetic: Cityline	Controller: External
Includes flush box S1 ref. 8948		
5266 RF-WIEGAND RECEIVER 12VDC		
Authentication: RF	Aesthetic: Other	Controller: External

Accessories

4533	DESFIRE USB CARD READER	5208	CONTACTLESS PUSHBUTTON SURFACE BOX
4534	USB PROGRAMMER DESFIRE CARDS	1076	MC740 G2 MAGNETIC CONTACT
4813	POWER SUPPLY DIN6 100-240Vac 12Vdc/2A	7061	CITYLINE SURFACE BOX S1 (130X128X33 mm)
67501	UNIVERSAL LOCK RELEASE 990N-P22 MAX 12-24Vdc/ca	7062	CITYLINE SURFACE BOX S2 (130x151x33 mm)
67524	UNIVERSAL LOCK RELEASE 990A-S 12-24Vdc/ca	8851	FLUSH BOX S1 (115x114x45 mm)
5287	FLUSH MOUNTED PUSHBUTTON (2 WIRES)	8852	FLUSH BOX S2 (115x138x45 mm)
5288	SURFACE MOUNTED PUSHBUTTON (2 WIRES)	5234	USB INKEY-MINI FINGERPRINT READER
5207	CONTACTLESS PUSHBUTTON FLUSH MOUNTED (4 WIRES)	24661	USB ADAPTOR TO RS485

FERMAX

FERMAX
ADGANGSKONTROL







FERMAX

FERMAX

PROXIMITY ACCESS CONTROL

KITS THIS GUIDE WILL HELP YOU CHOOSE THE RIGHT PRODUCT FOR YOUR INSTALLATION

1 How will the **user** be identified?

PROXIMITY		PIN CODE		FINGERPRINT	RF
					
6992/6957 EM	5296 MF/EM	6991/5190	5293 MF/EM	5233 MF	5250

EM 125KHz	MIFARE 13,56MHz	RECOMMENDED DESFIRE 13,56MHz AES 256
--------------	--------------------	---

User identification by **key fobs or cards**.
Standard or enhanced security with AES 256 encryption (DESFIRE).
Also available on certain keypad models.

2 How many **users** will need to be managed?

<p>100 TO 600 users</p> <p>See number of users for each reference</p>	→	<p>UP TO 1000</p>  <p>5276</p>	→	<p>MORE THAN 1000</p>  <p>5233</p>
--	---	--	---	--

3 Which **aesthetic** do you prefer?

RESISTANT



CITYLINE



SKYLINE

See DUOX PLUS section
Integration with video door entry system

See page 42

4 Do you need to increase the **security** of the door?

- NO** Devices with internal controller
- They have a relay for a direct control of the electric lock release.
 - Number of users according to each equipment.
 - Management of the users by card, PIN... master.

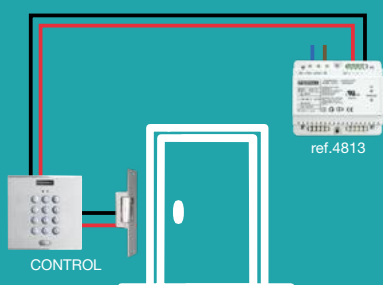

- YES** Devices with external controller ref. 5276
- They have communication with the equipment that controls the door: secured door. The keypad/reader does not have wiring to the rear of the door lock.
 - Extended number of users: 1000 users.
 - User management via IR control.

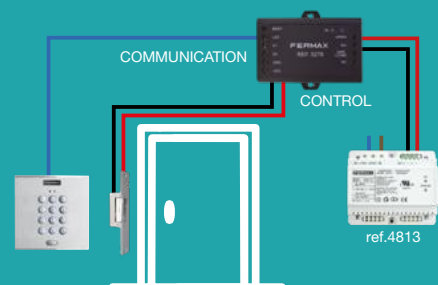

Summary







Authentication	Technology Proximity	Users	Aesthetic	Controller	Ref.	Kit
Proximity	EM	400	Cityline	Integrated	6992	4905
	Desfire	400			6957	
PIN Code		100			6991	4906
PIN Code + Proximity	Mifare/EM	600	Resistant		5293	5238
RF		500	-		5250	5249
Fingerprint + Proximity	Mifare	5.000	Inkey Mini		5233[1]	
Smartphone	Bluetooth	Unlimited	-		2637	



Proximity	EM	1.000	Cityline	External (ref. 5276) [2]	6992	4905
	Desfire					6957
	EM/Mifare				6958	
	EM/Mifare		Resistant		5296	5237
PIN Code			Cityline		5190	
PIN Code + Proximity	Mifare		Resistant		5293	5238
RF			-		5266	
Fingerprint + Proximity	Mifare	Inkey Mini	5233			



[1] Although it has a relay, it is necessary to connect an External relay to control a door release. It is recommended to use ref. 2013 relay.

[2] Ref. 5276 requires 12Vdc power supply via an additional power supply ref. 4813.

Identifiers

RECOMMENDED	DESFIRE 		NEW  Add more SECURITY with DESFIRE!
	KEY FOB	CARD	
			

EM 		
KEY FOB	CARD	BRACELET
4515	23361	6949
		

MIFARE 	
KEY FOB	CARD
52740	52750
	

RF 868Mhz	
REMOTE CONTROL	
5259	5231
	

3. AC-MAX access control system



Complete system for users management from PC, both locally and remotely by means of a free PC software.

Free software available at www.fermax.com



ADVANCED FEATURES

- Real-time event logging.
- Remote software management: configuration, registration/cancellation of users, etc.
- Timetable control.
- Anti-passback, occupancy limitation, automations.

ADVANTAGES



Easy to install and competitive kit format



Assistant that guides the installer through the process of creating their own configuration



Visual management of accesses via IP network with site map



Integrated fingerprint readers which are managed using the same software



Allows events to be registered in customisable formats

2 OR 4 DOORS KIT

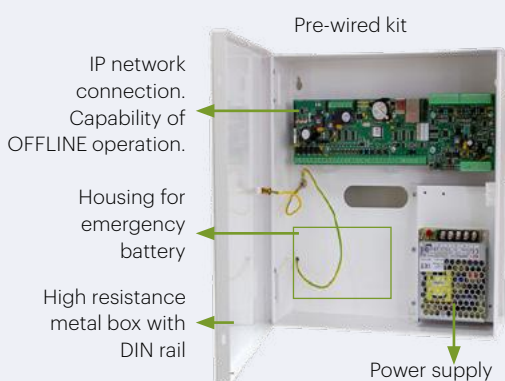

- Control of 2 or 4 doors. Up to 4 or 8 entry/exit readers. Wiegand/RS-485 connection.

BASIC SCHEME

Free software. Includes wizard to guide you through the configuration. Unlimited 5223/5224 kits. 8192 credentials per kit. Event logging, reports, etc. Remote management.

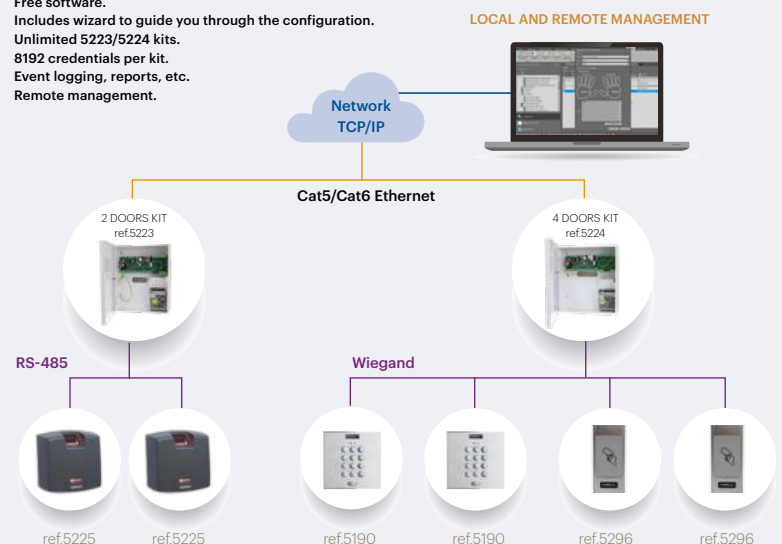

AC-MAX LT 2.0 Software

One single free software with all common required functions already built-in: system configuration, management of users, roles and credentials, log of events, reports, integration of CCTV cameras, occupancy limit&count,...

“ST version” also available, with advanced functionalities.

Available languages: Spanish, English, Portuguese, French, German, Dutch.

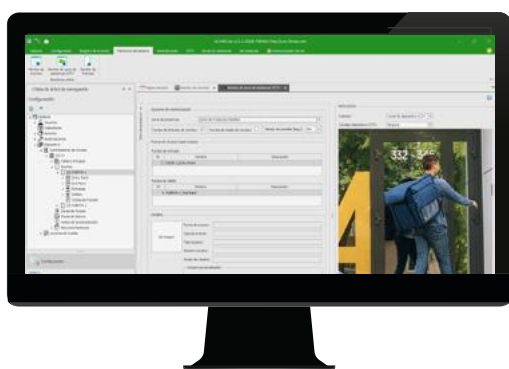

SOFTWARE FEATURES	LT 2.0
CAPACITY	
Licences required	NO
No. of doors	No limits
No. of users/central	8.192
No. of central units	No limits
No. of relays	No limits/ 128 per controller
No. of sensors	No limits/ 128 per controller
No. of events	8.000.000
BASIC FUNCTIONS	
Configuration Wizard	Yes
Real time event monitoring	Yes
Reports	Yes
Built-in fingerprint enrolment	Yes
Site Map	No*
Software remote door opening	Yes
Local Antipassback	Yes
Different operator profiles	Yes
Access Zones	Yes
Occupancy limit	Yes
Occupancy count	Yes
List of persons in a zone	Yes
Alarm zones	Yes
Automations	Yes (8 modes)
Credential expiry date	Yes
Different credentials per user	Yes

SOFTWARE FEATURES	LT 2.0
ADVANCED FUNCTIONS	
Limited number of accesses per user	No
Global Antipassback	No*
Perimetral zones	No*
Client/Server installation	Yes
Multi company partition	No**
Different projects management	Yes
Internet remote management	Yes
Time & Attendance	Basic
Basic visit management	No*
Design/Print prox cards	No*
Advanced authorization	No*
Authentication policies	Yes
Asset management	No*
Email alerts	No*
Fire Alarm inputs	No*
INTEGRATION	
External Database	Yes
CCTV video stream reception	Yes
API	Free
Lift Control	No*

* Check availability with ST 2.0 version

**Available in ST 2.0 version and requires a licence.

KITS



ref.5223



ref.5224



ref.5296

5223	2-DOOR AC-MAX CONTROLLER KIT
Includes metal box with power supply, an IP controller unit and a 2 door expander. Dimensions: 295x285x90. Power supply: 3,6 A.	
5224	4-DOOR AC-MAX CONTROLLER KIT
Includes metal box with power supply, an IP controller unit and a 4 door expander. Dimensions: 325x305x100. Power supply: 5,4 A.	
5296	RESISTANT PROXIMITY READER

For projects with more than 4 doors: just connect the desired number of kits to the same IP network. They are managed from a single software by IP.

ACCESSORIES

<p>6957 DESFIRE CITYLINE READER</p>  <p>Wiegand</p>	<p>6958 MIFARE CITYLINE READER</p>  <p>Wiegand</p>	<p>5293 PROX. RESISTANT KEYPAD</p>  <p>Wiegand</p>	<p>5190 CITYLINE KEYPAD</p>  <p>Wiegand</p>	<p>5266 RF RECEIVER</p>  <p>Wiegand</p>	<p>5225 FINGERPRINT READER</p>  <p>RS-485</p>
---	--	--	---	--	---



ref.5222



ref.5201



ref:1608/5204

5222	LIFT CONTROL 8 FLOOR KIT
The 5222 kit includes a 5221 licence for the control of up to 8 plants. This kit can accommodate a maximum of 2x additional ref. 5201. From the ninth floor upwards, include one 5201 + 5221 for each additional 8 floors.	
5201	EXPANDER 8 INPUTS / 8 OUTPUTS (EXP8-IO)
5221	L.C. 8 FLOORS LICENCE Extension
5209	METAL BOX FOR LIFT CONTROL
1608	AC-MAX LICENCE DONGLE (KEY6-USB)
5204	DESKTOP PROXIMITY READER AC-MAX (KEY3-USB)

MIFARE		RF 868Mhz		DESFIRE	
KEY FOB	CARD	REMOTE CONTROL		KEY FOB	CARD
52740	52750	5259	5231	4532	4531
					

Access control

DIAGRAM. KITS WITH INTEGRATED CONTROLLER

KEYPAD

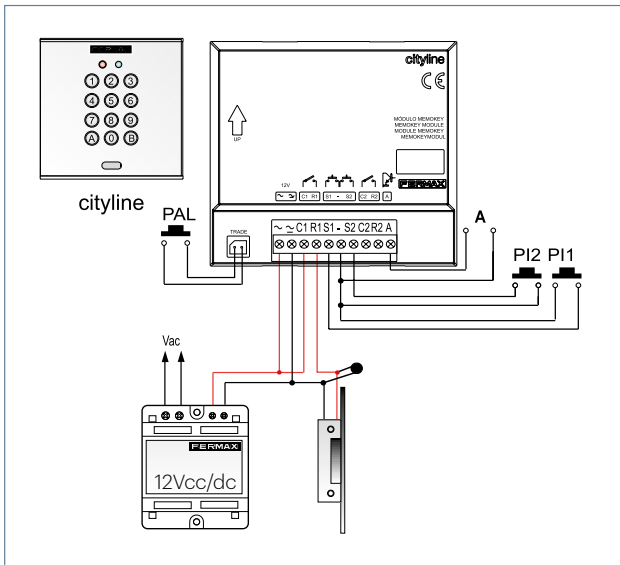

PROXIMITY

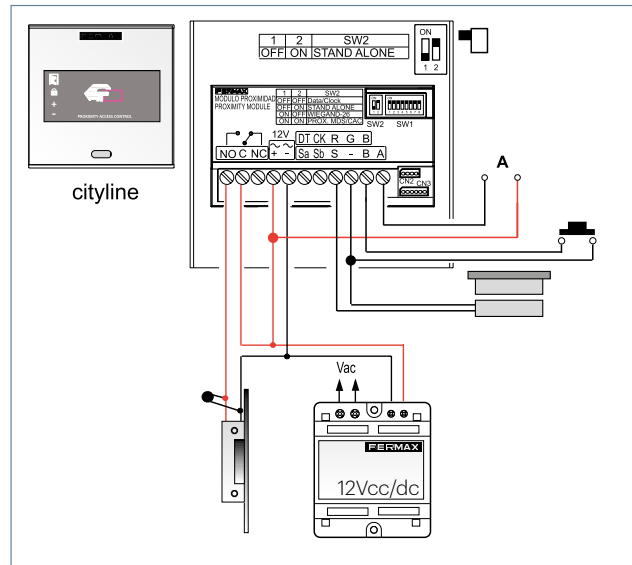

FINGERPRINT

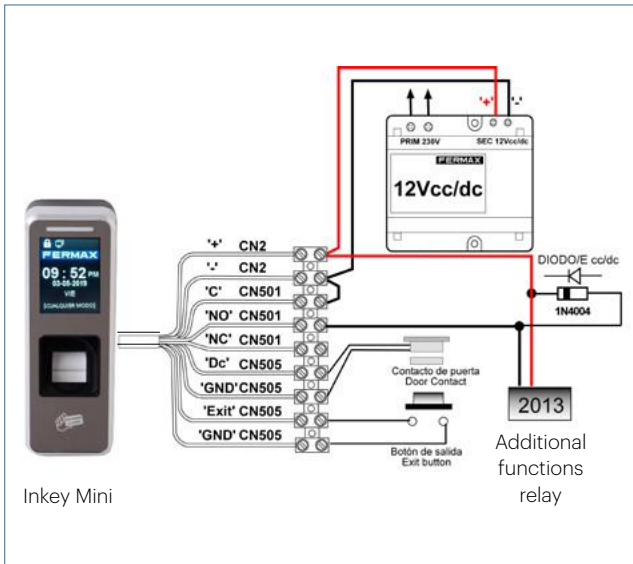

Access control

DIAGRAM. KITS

RESISTANT KEYPAD WITH INTEGRATED CONTROLLER

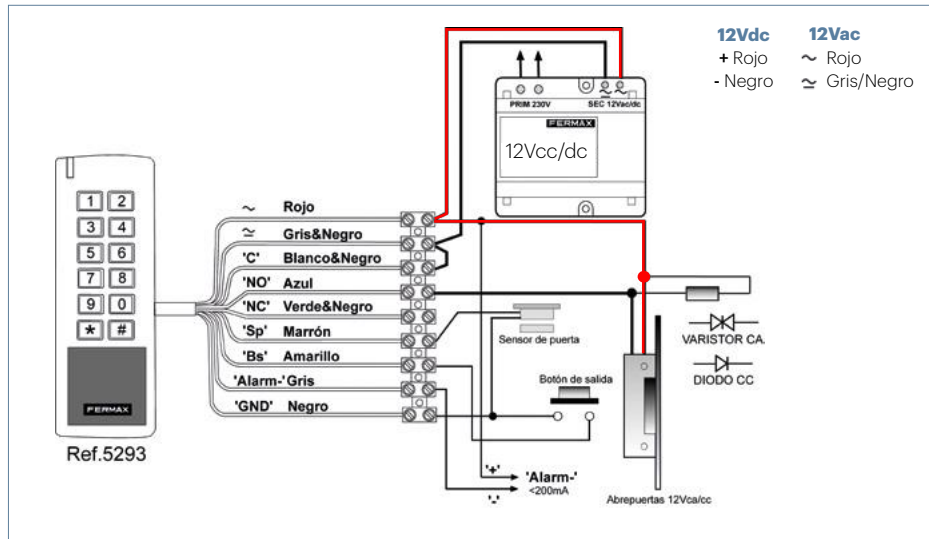

WITH MINI EXTERNAL CONTROLLER

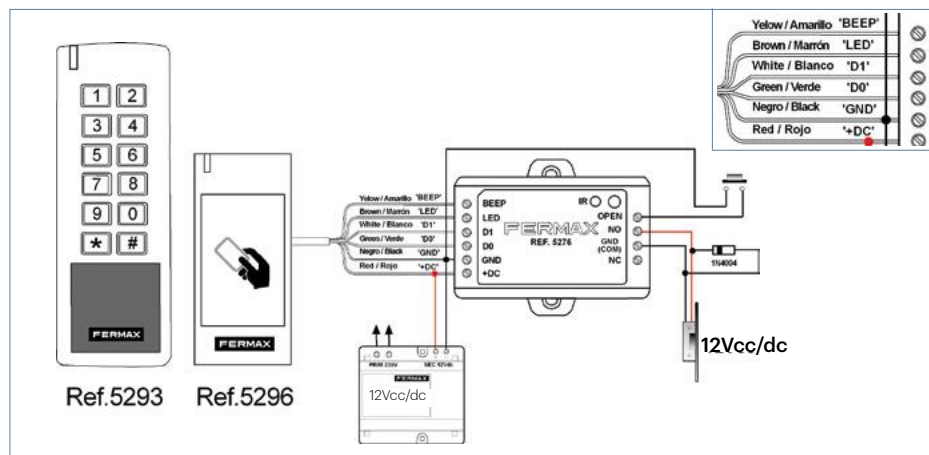
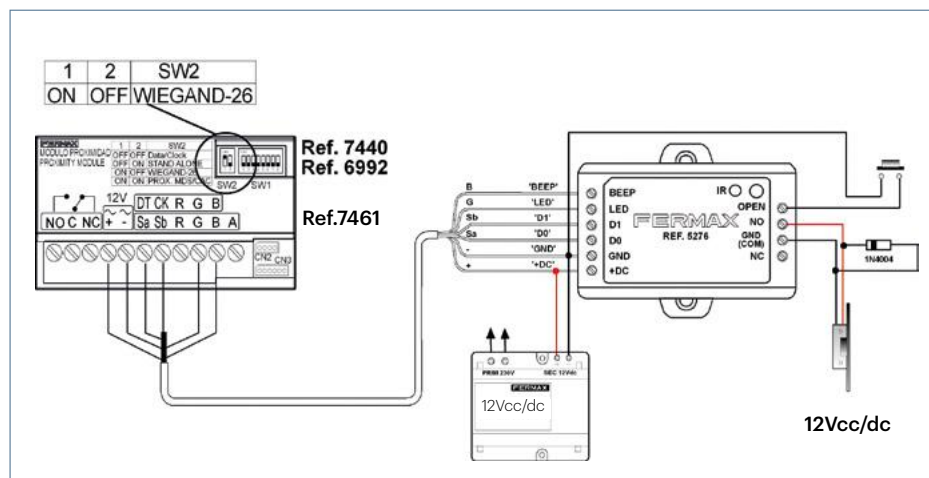

Access control

DIAGRAM. AC-MAX

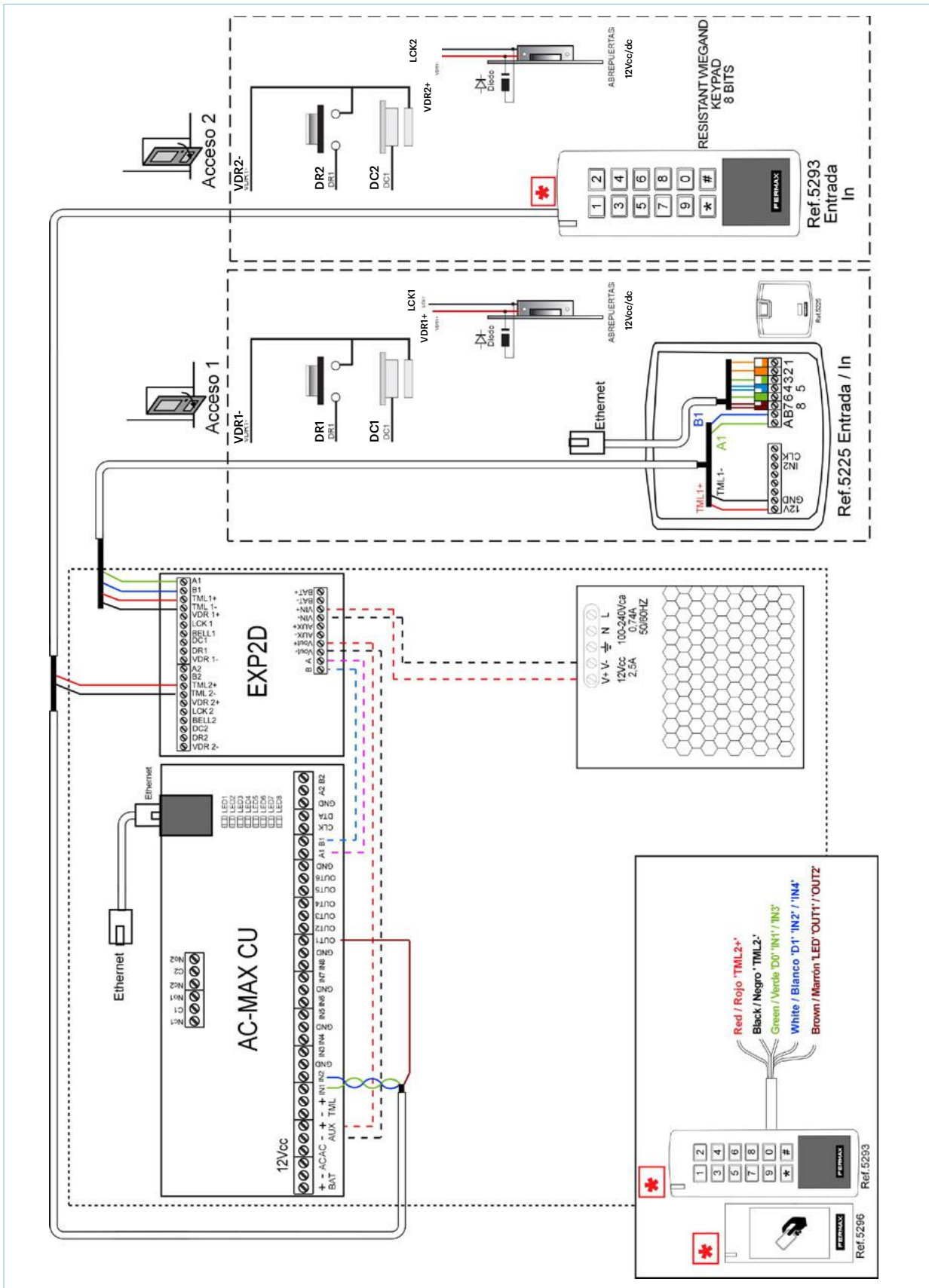

FERMAX

www.freund.dk

FREUND ELEKTRONIK A/S
Fuglebakken 119, 5210 Odense NV
freund@freund.dk - Tlf: 66 16 24 14