

NOVOSTI!

2026



GET IT ON
 **Google Play**

 **Download on the
App Store**

BUDUĆNOST = TRACON

Dragi kupci,

Tržište se stalno menja, a mi pratimo najnovije trendove. To jasno pokazuje činjenica da ove godine u rukama možete držati naš treći mini-katalog koji predstavlja nove proizvode.

Naš zajednički cilj ostaje nepromenjen: da osiguramo da naši kupci uvek mogu da biraju između modernih, pouzdanih i jednostavnih rešenja.

Naše nove proizvode dizajniramo u skladu sa tim - sa fokusom na promišljen dizajn, praktičnost i bezbednost - kako bismo postigli najbolji mogući rezultat u svakom slučaju.

Sa našim kontinuiranim razvojem i proširenjem asortimana, težimo da našim kupcima pružimo pravu konkurentsku prednost, uz pružanje brzih i pouzdanih odgovora na potrebe krajnjih korisnika.

Verujemo da će vam naš najnoviji katalog biti koristan i da će dodatno ojačati naš zajednički rad.

Hajde da zajedno krenemo napred u svetlost budućnosti.

TRACON EVROPA

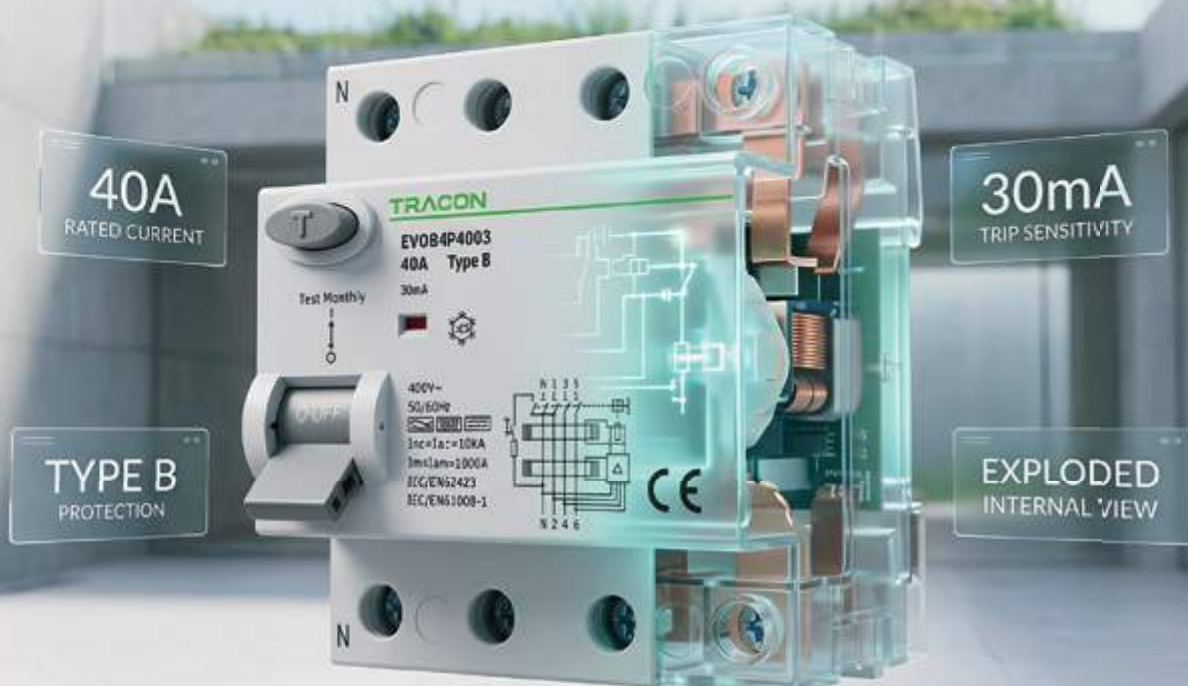

SADRŽAJ



Stezaljka za račvanje sa glavnog kola **5**



Prese za završne čaure **9**



Setovi alata sa izolacijom na 1000V **11**



Multifunkcionalna klešta **20**



Set odvrtča **22**



Digitalni moment šrafčiger **25**



Set kombinovanih ključeva sa računom **26**



Merna traka **28**



Lamelni brusni disk, rezna ploča **30**



Set bitova **33**



Akumulatorska presa **35**



SDS Plus, burgije i dleta **38**



Baštenska stojeća svetiljka sa utičnicom **44**



Solarna LED zidna lampa sa senzorom pokreta **45**



Ručna LED svetiljka sa akumulatorom **47**



Prenosivi LED reflektori sa schuko ili french utičnicom **51**



Plafonska LED lampa sa prek. za podeš. temp. boje **55**

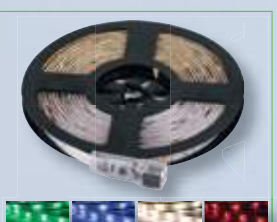

LED trakasti setovi **57**



Svetiljka za nameštaj, LED T5 **58**



Nova porodica detektora prisustva u Tracon-u **61**



Zidna svetiljka, zakrivljeni oblik **68**



Zaštićena svetiljka za LED cevi **70**



Zaštićena industrijska LED svetiljka **72**



LED svetiljke za hale **73**



Solarna hibridna LED ulična rasveta sa senzorom pokreta **79**

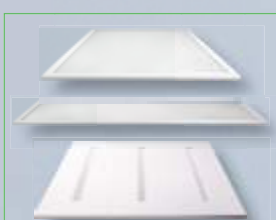

LED paneli **81**



Pametni dom **87**



Senzor ugljen monoksida (CO) **91**



Senzor za detekciju praznjenja luka **92**



Produžni kabl na metalnom bubnju **97**



Pametne utičnice **99**



Zaštićene razdelne kutije **102**



Stalak za punjač E-automobile **103**



Porodica osigurača rastavnih prekidača **105**



Komplet za čišćenje solarnih panela **108**

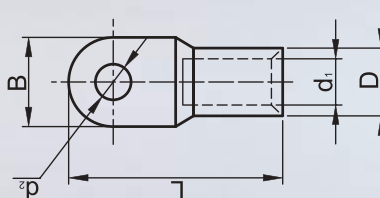

NEIZOLOVANE CEVASTO OKASTE STOPICE I PAPUČICE, SERIJA CLM

TRACON	d ₁ (mm)	d ₂ (mm)	D (mm)	L (mm)	B (mm)	mm ²					
						1	2	3			
CLM1.5-3	1,8	3,7	3,3	18	8,7						
CLM1.5-4	1,8	4,3	3,3	18	8,7	1,5-2,5	1,5	1-1,5			
CLM1.5-5	1,8	5,3	3,3	18,5	8,7						
CLM2.5-4	2,7	4,3	4,3	18	8,7						
CLM2.5-5	2,7	5,3	4,3	19	8,7	2,5-4	2,5	1,5			
CLM2.5-6	2,7	6,4	4,3	20	9						
CLM4-5	3,3	5,3	5,0	21	8,7						
CLM4-6	3,3	6,4	5,0	23	11	4-6	4	2,5			
CLM6-5	3,8	5,3	5,5	27,5	10,3						
CLM6-6	3,8	6,4	5,5	27,5	10,3	10	6	4			
CLM6-8	3,8	8,4	5,5	27,5	13						
CLM10-6	4,7	6,5	6,6	27,5	10,3	10-16	10	6			
CLM10-8	4,7	8,5	6,6	30,5	13,5						
CLM16-6	5,6	6,5	7,8	29,5	11,2	16	16	10			
CLM16-8	5,6	8,5	7,8	33	13,5						
CLM25-6	7,1	6,5	9,5	39	13,7						
CLM25-8	7,1	8,5	9,5	39	13,7	25-35	25	16			
CLM25-10	7,1	10,5	9,5	42	16						
CLM35-6	8,2	6,5	10,8	44	15,3						
CLM35-8	8,2	8,5	10,8	44	15,3	50	35	25			
CLM35-10	8,2	8,5	10,8	48	15,7						
CLM35-12	8,2	13	10,8	48	18						
CLM50-8	10,1	8,5	13	47,5	18,9						
CLM50-10	10,1	10,5	13	51,5	18,9	70	50	35			
CLM50-12	10,1	13	13	51,5	18,9						
CLM70-8	11,5	8,5	14,7	50,6	21,1						
CLM70-10	11,5	10,5	14,7	54,6	21,1	95	70	50			
CLM70-12	11,5	13	14,7	54,6	21,1						
CLM95-10	13,5	10,5	16,7	58,8	24,7	120	95	70			
CLM95-12	13,5	13	16,7	58,8	24,7						
CLM120-10	15,6	10,5	19	69	27,7						
CLM120-12	15,6	13	19	69	27,7	150	120	70-95			
CLM120-16	15,6	17	19	69	27,7						
CLM150-12	16,5	13	21	76,5	30,4						
CLM150-14	16,5	15	21	76,5	30,4	-	150	95			
CLM150-16	16,5	17	21	76,5	30,4						
CLM185-12	18,4	13	23	82,5	34,2						
CLM185-14	18,4	15	23	82,5	34,2	-	185	120-150			
CLM185-16	18,4	17	23	82,5	34,2						
CLM240-14	21	15	26	89	38,7	-	240	150-185			
CLM240-16	21	17	26	89	38,7						
CLM300-16	23,4	17	28,6	95	42,6	-	300	185-240			
CLM400-16	26,8	17	32,8	108,2	48,3	-	400	300			
CLM400-20	26,8	21	32,8	108,2	48,3	-	400	300			
CLM500-16	29,8	17	38,4	115,5	54,9	-	500	300			
CLM625-16	34,5	17	44	133,1	63	-	625	400			

RELEVANT STANDARD
EN 61238-1

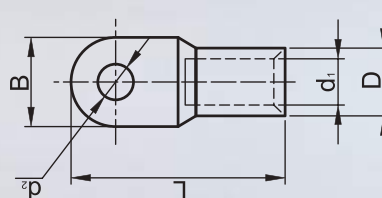

NEIZOLOVANE CEVASTO OKASTE STOPICE I PAPUČICE, SERIJA D

TRACON	d ₁ (mm)	d ₂ (mm)	D (mm)	L (mm)	B (mm)	mm ²					
D6-5	3,8	5,3	5,5	33	8,5						
D6-6	3,8	6,4	5,5	34,5	8,5	6	6	4			
D10-5	4,5	5,3	6	36	9						
D10-6	4,5	6,4	6	37,5	9						
D16-6	5,5	6,4	8,5	46,5	13	10	10	6			
D16-8	5,5	8,4	8,5	49	13						
D16-10	5,5	10,5	8,5	51	17						
D25-6	7	6,4	10	48,5	14	16	16	10			
D25-8	7	8,4	10	51	16						
D25-10	7	10,5	10	53	17	25	25	16			
D25-12	7	13	10	54	19						
D35-8	8,2	8,4	12,5	55	17	35	35	25			
D35-10	8,2	10,5	12,5	57	19						
D35-12	8,2	13	12,5	58	21	35	35	25			
D50-8	10	8,4	14,5	65	20						
D50-10	10	10,5	14,5	67	22						
D50-12	10	13	14,5	68	24	50	50	35			
D50-16	10	17	14,5	71	28						
D70-8	11,5	8,4	16,5	68	24						
D70-10	11,5	10,5	16,5	70	24	70	70	50			
D70-12	11,5	13	16,5	71	24						
D70-16	11,5	17	16,5	74	30						
D95-10	13,5	10,5	19	80	28						
D95-12	13,5	13	19	81	28	95	95	70			
D95-16	13,5	17	19	84	32						
D120-10	15,5	10,5	21	85	32						
D120-12	15,5	13	21	86	32	120	120	95			
D120-16	15,5	17	21	89	32						
D120-20	15,5	21	21	92	38	120	120	95			
D150-10	17	10,5	23,5	93	34						
D150-12	17	13	23,5	94	34						
D150-16	17	17	23,5	97	34	150	150	120			
D150-20	17	21	23,5	100	40						
D185-10	19	10,5	25,5	97	37						
D185-12	19	13	25,5	98	37	185	185	150			
D185-16	19	17	25,5	101	37						
D185-20	19	21	25,5	104	40						
D240-12	21,5	13	29	108	42	185	185	150			
D240-16	21,5	17	29	111	42						
D240-20	21,5	21	29	114	45						
D300-16	24,5	17	32	119	48	240	240	185			
D300-20	24,5	21	32	122	48	300	300	240			
D400-16	27,5	17	38,5	140	55	400	400	300			
D400-20	27,5	21	38,5	140	55	400	400	300			
D500-20	31	21	42	150	60	500	500	400			
D625-20	34,5	21	44	160	60	625	625	500			

RELEVANT STANDARD
EN 61238-1



RVOG

BEZVIJČANE SPOJNICE VODOVA

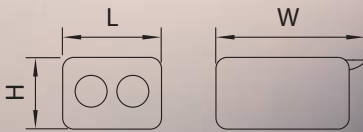

Cu-Sn	In max. 32 A	Ta -10...+55 °C	PC	IP 20
-------	---------------------------	---------------------------	----	-----------------

U_i 450 V	Cu-Sn	In max. 32 A	Ta -40...+105 °C	PC	IP 20
-------------------------------	-------	---------------------------	----------------------------	----	-----------------

TRACON	mm ²	L (mm)	W (mm)	H (mm)
RVOG2	2 × 0,2-4 (2,5)	13,2	20,1	9,2
RVOG3	3 × 0,2-4 (2,5)	18,8	20,1	9,2
RVOG4	4 × 0,2-4 (2,5)	24,3	20,1	9,2
RVOG5	5 × 0,2-4 (2,5)	30,3	20,1	9,2
RVOGB2	2 × 0,5-6 (4)	15,9	23,3	10,9
RVOGB3	3 × 0,5-6 (4)	23,2	23,3	10,9

TRACON	mm ²	L (mm)	W (mm)	H (mm)
RVOGTT11	2 × 0,5-4 (2,5)	39,3	8,3	10
RVOGTT22	4 × 0,5-4 (2,5)	39,3	14,9	10
RVOGTT33	6 × 0,5-4 (2,5)	39,3	22,9	10

NEW 2025



FLECUR...

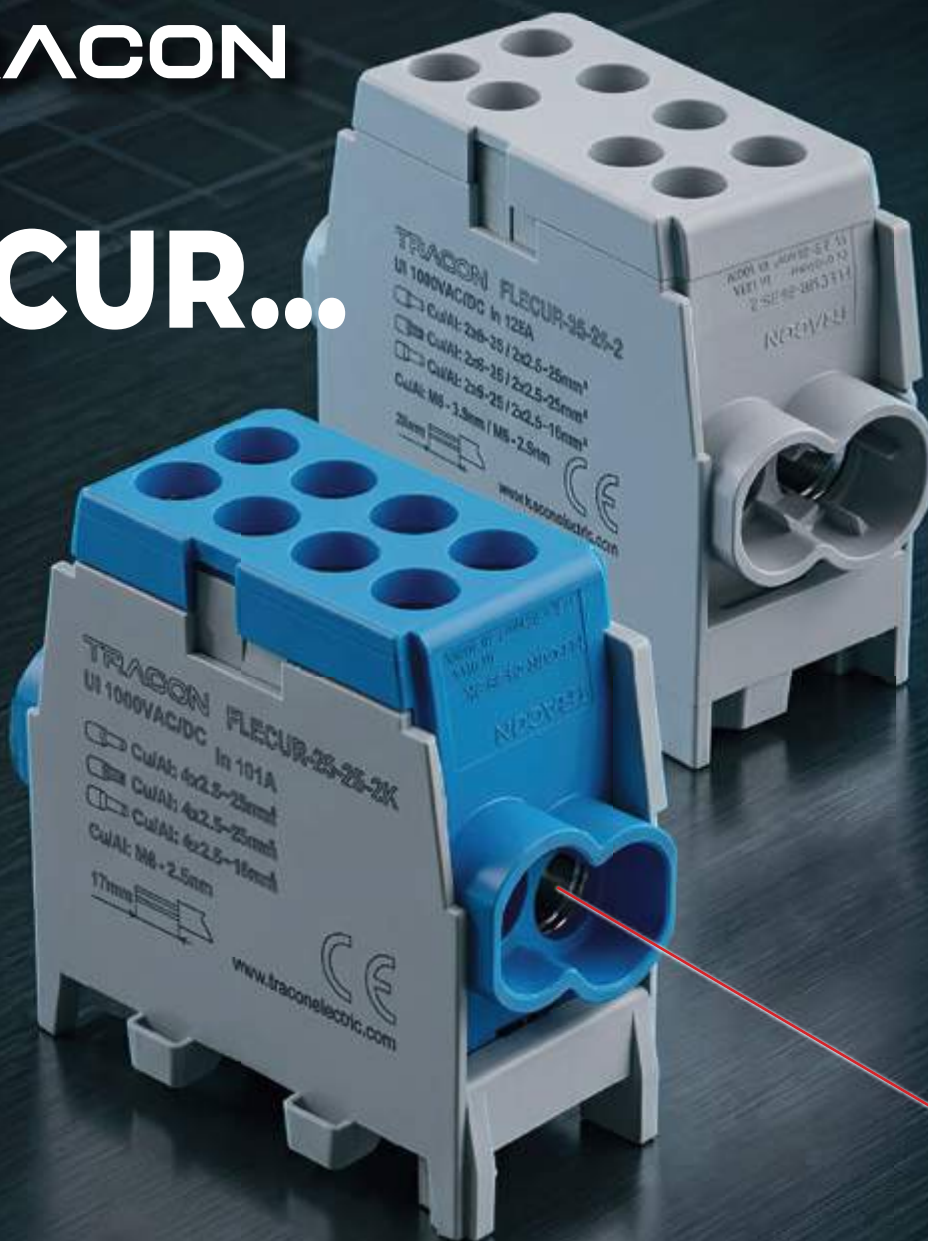

**STEZALJKA
SADRŽI
KONTAKTNU
PASTU!**

STEZALJKA ZA RAČVANJE SA GLAVNOG KOLA

400 V AC					
-----------------	--	--	--	--	--



TRACON	mm ²				In		W (mm)	L (mm)	H (mm)	X
FLECUR-25-25-2	2×25	2×16	2×25	2×16	101 A		21,3	43,9	41,2	4×M6
FLECUR-25-25-2K	2×25	2×16	2×25	2×16	101 A		21,3	43,9	41,2	4×M6
FLECUR-35-25-2	2×35	2×25	2×25	2×16	125 A		24,5	54,8	42,7	2×M8 ; 2×M6
FLECUR-35-25-2K	2×35	2×25	2×25	2×16	125 A		24,5	54,8	42,7	2×M8 ; 2×M6









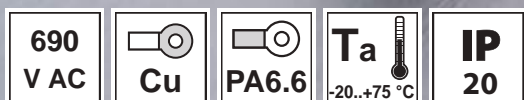



FSK..



REDNA STEZALJKA GLAVNOG VODA (može plombirati)



TRACON	mm ²				In		W (mm)	L (mm)	H (mm)
									
	IN			OUT					
FSK35SZ	2 × 35	2 × 25	3 × 35	3 × 25	100		50	70	45
FSK35K	2 × 35	2 × 25	3 × 35	3 × 25	100		50	70	45
FSK35B	2 × 35	2 × 25	3 × 35	3 × 25	100		50	70	45
FSK35Z	2 × 35	2 × 25	3 × 35	3 × 25	100		50	70	45
FSK35F	2 × 35	2 × 25	3 × 35	3 × 25	100		50	70	45
FSK35R	2 × 35	2 × 25	3 × 35	3 × 25	100		50	70	45



GLOV..

ZAŠTITNE RUKAVICE

TRACON zaštitne rukavice pružaju zaštitu ruku i siguran hvat tokom montaže, održavanja i industrijskih radova.

Pravilno odabrane rukavice doprinose smanjenju rizika od povreda.

- Osnovne zaštitne rukavice (GLOVA) su pogodne za opštu mehaničku zaštitu.
- Rukavice za ekran na dodir (GLOVB) omogućavaju vam da upravljate digitalnim uređajima bez skidanja rukavica.
- Rukavice otporne na posekotine i za ekran na dodir (GLOVC) pružaju povećanu zaštitu pri radu sa oštrim predmetima.

TRACON		
GLOVA8	8/M	
GLOVA9	9/L	
GLOVA10	10/XL	
GLOVA11	11/XXL	
GLOVB8	8/M	
GLOVB9	9/L	
GLOVB10	10/XL	
GLOVB11	11/XXL	
GLOVC8	8/M	
GLOVC9	9/L	
GLOVC10	10/XL	
GLOVC11	11/XXL	



TRACON MARK













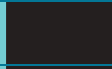

TRACON



MARKER

Otkrijte naš raznovrstan asortiman flomastera, gde vas čekaju raznovrsni flomasteri i markeri za pisanje i obeležavanje za svakodnevnu, „uradi sam“ ili profesionalnu upotrebu! Izbor uključuje alkoholne markere i flomastere sa različitim debljinama vrhova (tanke i debele verzije) - pomoću kojih možete lako kreirati precizne natpise ili oznake.

Ovi flomasteri su pogodni za pisanje/crtanje na papiru, kartonu, kao i drugim materijalima kao što su plastika, drvo, metal ili staklo, i idealni su za pojedinačne oznake ili brze natpise.

TRACON			
MARKIPBL	1-3 mm	Industrijski marker	
MARKOSBL	0,3 mm	OHP marker	
MARKOMBL	1-1,5 mm	OHP marker	
MARKOMB	1-1,5 mm	OHP marker	
MARKOMR	1-1,5 mm	OHP marker	
MARKPMW	1-2 mm	Lak marker	
MARKPMBL	1-2 mm	Lak marker	
MARKPMY	1-2 mm	Lak marker	
MARKPBW	2-4 mm	Lak marker	
MARKPBL	2-4 mm	Lak marker	
MARKPBY	2-4 mm	Lak marker	





9039-HEXAB



9039-AUTO





9039-1016



CRIMPSET

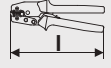

PRESE ZA ZAVRŠNE ČAURE

TRACON	 mm ²		
9039-1016	0,25-16	180 mm	391 g
9039-AUTO	0,08-10	200 mm	466 g
CRIMPSET	—	225 mm	543 g
9039-HEXAB	0,25-6	180 mm	395 g

Alat za presovanje **9039-1016** može da se podešava između 10 mm² i 16 mm².



SOPSTVENI RAZVOJ!
SLIM FIT dizajn tako da imbus šrafovi i na najužim mestima više nisu prepreka!



SET IMBUS KLJUČEVA, IZOLOVANA NA 1000V, 5 KOM

TRACON	mm
ISET5	3, 4, 5, 6, 8



CSSET9

**SET OKASTIH KLJUČEVA,
IZOLOVANI NA 1000V,
9 KOMADA**



DSET16

**SET IMBUS I NASADNIH
KLJUČEVA
SA RAČNOM,
IZOLOVANI NA
1000V,
16 KOMADA**



SETOVI ALATA SA IZOLACIJOM NA 1000V

TRACON	mm
CSSET9	10, 11, 12, 13, 14, 17, 19, 21, 24
DSET16	4, 5, 6, 8 / 8, 10, 12, 13, 14, 17, 19, 22



**SET
KLJUČEVA,
IZOLOVANI NA 1000V,
20 KOMADA**

TRACON	mm
VSET20	6, 7, 8, 9, 10, 11, 12, 13, 14, 15, 16, 17, 18, 19, 21, 22, 24, 27, 30, 32

**SETOVI ALATA
SA IZOLACIJOM NA 1000V**



**SET
KLJUČEVA,
IZOLOVANI
NA 1000V,
7 KOMADA**

TRACON	mm
VSET7	8, 10, 12, 13, 14, 17, 19



**SET IMBUS KLJUČEVA,
IZOLOVANI NA 1000V,
6 KOMADA**

SETOVI ALATA SA IZOLACIJOM NA 1000V

TRACON	mm
ISET6	3, 5, 6, 8, 10, 12



AW...

MS-1000

**FRANCUSKI KLJUČ,
MAKAZE ZA SEČENJE KABLOVA**

**KLJUČ, IZOLOVAN
NA 1000 V**

TRACON	Maksimalni otvor		
AW200	25 mm	200 mm	308 g
AW250	30 mm	250 mm	513 g
AW300	36 mm	300 mm	750 g

TRACON			
MS-1000	0-6 mm ²	160 mm	100 g

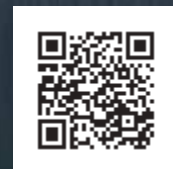

CK1

CK2

**NOŽEVI ZA KABLOVE,
IZOLOVANI NA 1000V**

TRACON			
CK1	200 mm	49,7 mm	81 g
CK2	200 mm	49,7 mm	81 g

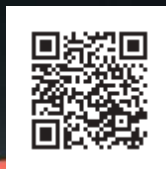

KLEŠTA IZOLOVANA NA 1000V



CB-1000



CC-1000



CC22-1000



CF-1000



CH-1000



CL-1000



CW-1000

TRACON	Amax	dmax	Length	m	Description
CC22-1000	16 mm ²	5.5 mm	160 mm (VDE)	215 g	Alat za sečenje kablova
CB-1000	—	—	160 mm	200 g	Univerzalna klešta za guljenje
CC-1000	—	—	160 mm	240 g	Bočni sekač klešta
CF-1000	—	—	180 mm	306 g	Kombinovana klešta
CH-1000	—	—	165 mm	250 g	Klešta za rezanje kablova
CL-1000	—	—	200 mm	250 g	Pljosnata klešta
CW-1000	—	—	250 mm	500 g	Klešta za vodene pumpe







ODVRTAČI IZOLOVANI NA 1000V

TRACON				
CD2575	⊖	2,5 × 75 mm	163 mm	49 g
CD3100	⊖	3 × 100 mm	188 mm	51 g
CD35100	⊖	3,5 × 100 mm	188 mm	55 g
CD4100	⊖	4 × 100 mm	188 mm	56 g
CD55125	⊖	5,5 × 125 mm	223 mm	75 g
CD65150	⊖	6,5 × 150 mm	258 mm	83 g
CDPH060	⊕	PH0 × 60 mm	148 mm	49 g
CDPH180	⊕	PH1 × 80 mm	178 mm	60 g
CDPH2100	⊕	PH2 × 100 mm	208 mm	72 g
CDPZ060	⊕	PZ0 × 60 mm	148 mm	49 g
CDPZ180	⊕	PZ1 × 80 mm	178 mm	60 g
CDPZ2100	⊕	PZ2 × 100 mm	208 mm	72 g
CDT154100	⊛	T15 4 × 100 mm	188 mm	65 g
CDT2055125	⊛	T20 5,5 × 125 mm	223 mm	70 g
CDT2555125	⊛	T25 5,5 × 125 mm	223 mm	78 g
CDDK6208	⊗	SL/PZ2 × 100 mm	208 mm	87 g
CDDK45178	⊗	SL/PZ1 × 80 mm	80 mm	56 g



GARNITURA ODVRTAČA SA NAPONOM IZOLACIJE DO 1000V

TRACON				
CSET9	1,0 × 5,5 × 125 mm 0,8 × 4,0 × 100 mm 0,4 × 2,5 × 100 mm	PH2 × 100 mm PH1 × 80 mm	—	—
CSET13	1,2 × 6,5 × 100 mm 1,0 × 5,5 × 100 mm 0,8 × 4,0 × 100 mm 0,5 × 3,0 × 100 mm	PH2 × 100 mm PH1 × 80 mm	PZ2 × 100 mm PZ1 × 80 mm	T20 × 100 mm T15 × 100 mm T10 × 100 mm
CSET1000	1,0 × 5,5 × 125 mm 0,8 × 4,0 × 100 mm 0,4 × 2,5 × 75 mm	PH2 × 100 mm PH1 × 80 mm PH0 × 60 mm	—	—



TRACON





CSETP5



CDHN...

**SET PRECIZ-
NIH ODVIJAČA
IZOLOVANIH
NA 1000 V**

**ŠESTOUGAONI
NASADNI KLJUČ,
1000V**

ŠESTOUGAONI NASADNI KLJUČ, 1000 V

TRACON		
CSETP5	0,5 × 3,0 × 65 mm 0,4 × 2,5 × 65 mm 0,4 × 2,0 × 50 mm	PH0 × 65 mm PH00 × 65 mm

TRACON		
CDHN6		6 × 233 mm
CDHN8		8 × 233 mm
CDHN10		10 × 243 mm



MF...



MF5

MF4

MF6

MULTI-FUNKCIONALNA KLEŠTA





CN... DIAMOND ODVRTAČI



TRACON		
CN5100		5 × 100 mm
CN6100		6 × 100 mm
CN8150		8 × 150 mm
CN538		5 × 38 mm
CN638		6 × 38 mm
CNPH1100		PH1 × 100 mm
CNPH2100		PH2 × 100 mm
CNPH3150		PH3 × 150 mm
CNPH138		PH1 × 38 mm
CNPH238		PH2 × 38 mm
CNPZ1100		PZ1 × 100 mm
CNPZ2100		PZ2 × 100 mm
CNPZ3150		PZ3 × 150 mm
CNT15100		T15 × 100 mm
CNT20100		T20 × 100 mm
CNT25100		T25 × 100 mm
CNT27100		T27 × 100 mm

TRACON				
CNSET9	PH1 × 100 mm	5 × 100 mm		PZ1 × 100 mm
	PH2 × 150 mm	6 × 150 mm	–	PZ2 × 100 mm
	PH3 × 150 mm	8 × 150 mm		PZ3 × 150 mm
CNSET12	PH1 × 100 mm	5 × 100 mm	T15 × 100 mm	PZ1 × 100 mm
	PH2 × 100 mm	6 × 100 mm	T20 × 100 mm	PZ2 × 100 mm
	PH3 × 200 mm	8 × 150 mm	T25 × 100 mm	PZ3 × 150 mm



CNSET.. SET ODVRTAČA





TRACON			
CNSET18	PH3 × 150 mm	8 × 150 mm	T5 × 50 mm
	PH2 × 100 mm	6 × 100 mm	T6 × 50 mm
	PH1 × 75 mm	5 × 75 mm	T7 × 50 mm
	PH2 × 38 mm	6 × 38 mm	T8 × 50 mm
	PH00 × 50 mm	2,5 × 50 mm	T9 × 50 mm
	PH0 × 50 mm	3,0 × 50 mm	T10 × 50 mm
CNSET36	PH2 × 100 mm	8 × 150 mm	T5 × 50 mm
	PH1 × 75 mm	6 × 100 mm	T6 × 50 mm
	PH2 × 38 mm	5 × 75 mm	T7 × 50 mm
	PH00 × 50 mm	6 × 38 mm	T8 × 50 mm
	PH0 × 50 mm	2,6 × 50 mm	T9 × 50 mm
		3,0 × 50 mm	T10 × 50 mm

18 kom. GLAVA ZA BIT + DRŽAČ BITOVA



SET PRECIZNIH ODVRTAČA

TRACON			
CNSETP7	PH00 × 50 mm PH0 × 50 mm	2,5 × 50 mm 3,0 × 50 mm	T8 × 50 mm T9 × 50 mm T10 × 50 mm

TRACON

CHSET17



12 kom. GLAVA ZA BIT +
DRŽAČ BITOVA

TRACON

CNUSET6

**SET
ODVRTAČA
NA UDARANJE**



TRACON



CNUSET6

PH1 × 100 mm

5 × 100 mm

PH2 × 150 mm

6 × 150 mm

PH3 × 150 mm

8 × 150 mm





TS10



Kada obrtni moment dostigne unapred podešenu vrednost zujalica pišti. Kada se dostigne vrednost, zujalica će dugo pištati

DIGITALNI MOMENT ŠRAFCIGER

1. Držač bitova sa automatskim zaključavanjem
2. LED indikator
3. LCD displej
4. Dugme za promenu jedinice
5. Zvučni signal
6. Dugme „Gore“
7. Dugme „Dole“
8. Dugme za promenu/brisanje
9. Dugme za izbor režima
10. Smer kazaljke na satu/suprotno od kazaljke na satu
11. Indikacija podešenog ograničenja obrtnog momenta
12. Broj sačuvanih vrednosti obrtnog momenta
13. Indikator napunjenosti baterije
14. Indikator zvučnog signala
15. Indikator režima
16. Indikator jedinice
17. Indikator vrednosti obrtnog momenta

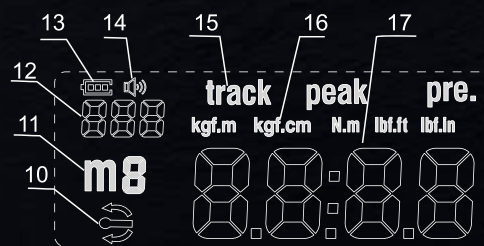
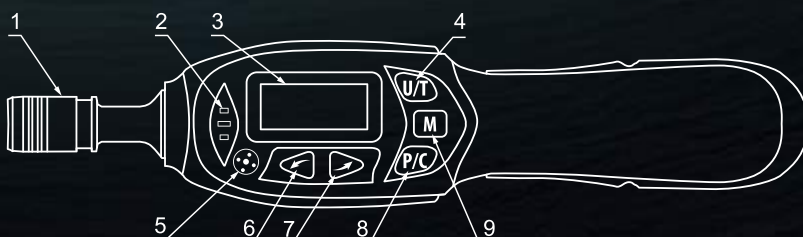

TRACON



0,5 - 10



235 mm



192 g

TS10



SET KOMBINOVANIH KLJUČEVA SA RAČNOM

TRACON	mm
KK6	8, 10, 12, 13, 14, 17
KK15	8, 9, 10, 11, 12, 13, 14, 15, 16, 17, 18, 19, 21, 22, 24
RKK7	8, 10, 12, 13, 14, 17, 19
RKK10	8, 10, 11, 12, 13, 14, 16, 17, 19, 21





HAM..

UDARNE PONUDE



Waffle-Face čelična glava.

Maksimalno prijanjanje, minimalni odskok.



Ergonomska kompozitna drška:

Udobnost i prigušivanje vibracija.



Integrirana kandža za cepanje:

Svestranost u cepanju.



Dizajnirano da traje:

Dug vek trajanja.



TRACON		
HAM1	330 mm	687 g
HAM2	330 mm	687 g



MSZ..



MSZDIG



MSZM5



MSZL5

MERNA TRAKA

TRACON	L (m)	W (mm)	R (m)		
MSZL3	3	16	-	AUTO-LOCK	-
MSZL5	5	25	-	AUTO-LOCK	-
MSZL10	10	25	-	AUTO-LOCK	-
MSZM5	5	25	-	-	✓
MSZDIG	5	19	40	-	-





SPIR...

SPIRP...

SPIR..

SPIRE500

SPIRM200





LIBELA

TRACON	L (mm)		
SPIR400	400	3	✓
SPIR600	600	3	✓
SPIR1000	1000	3	✓
SPIRE500	500	2	-
SPIRM200	200	3	✓
SPIRP400	400	3	-
SPIRP600	600	3	-
SPIRP800	800	3	-
SPIRP1000	1000	3	-
SPIRP1200	1200	3	-



CSK../VK..





LAMELNI BRUSNI DISK, REZNA PLOČA

TRACON					
CSK125P40	125	22,2	—	P40	✓
CSK125P60	125	22,2	—	P60	✓
CSK125P80	125	22,2	—	P80	✓
CSK125P120	125	22,2	—	P120	✓
VK11510	115	22,2	1,0 mm	—	—
VK12510	125	22,2	1,0 mm	—	—
VK12516	125	22,2	1,6 mm	—	—
VK23019	230	22,2	1,9 mm	—	—

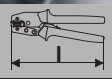

TW..

MEHANIČKI MOMENT KLJUČ

TRACON	 Nm			
TW25	5 - 25	1/4	247 mm	313 g
TW110	10 - 110	3/8	460 mm	955 g
TW210	30 - 210	1/2	496 mm	1150 g



CFSET4

SET PAJSERA

TRACON	L (mm)
CFSET4	600, 450, 300, 200



BIT..

SET BITOVA

TRACON	25 mm	50 mm	HSS 4241
BIT15	PH1, PH2, PZ1, PZ2, H4, H5, SL4, SL6, T10, T25	PH1, PH2, PZ1, PZ2, SL5	–
BIT32	PH1, PH2, PH3, PZ1, PZ2m PZ3, SL3, SL4, SL5, H3, H4, H5, T10, T15, T20, T25, T27, T30	PH1, PH2, PZ1, PZ2, SL3, SL4, T10, T15, T20	2, 2.5, 3, 4, 5



TRACON		L (mm)
BITSLPZ1	SL/PZ1	70
BITSLPZ2	SL/PZ2	70
BITSLPH2	SL/PH2	55





CSV43





CSV33



CSV33

CSV..

KLEŠTA ZA SEČENJE PVC CEVI

TRACON	d _{max} 		
CSV33	33 mm	210 mm	156 g
CSV43	43 mm	225 mm	279 g





DM50

AKUMULATORSKA PRESA

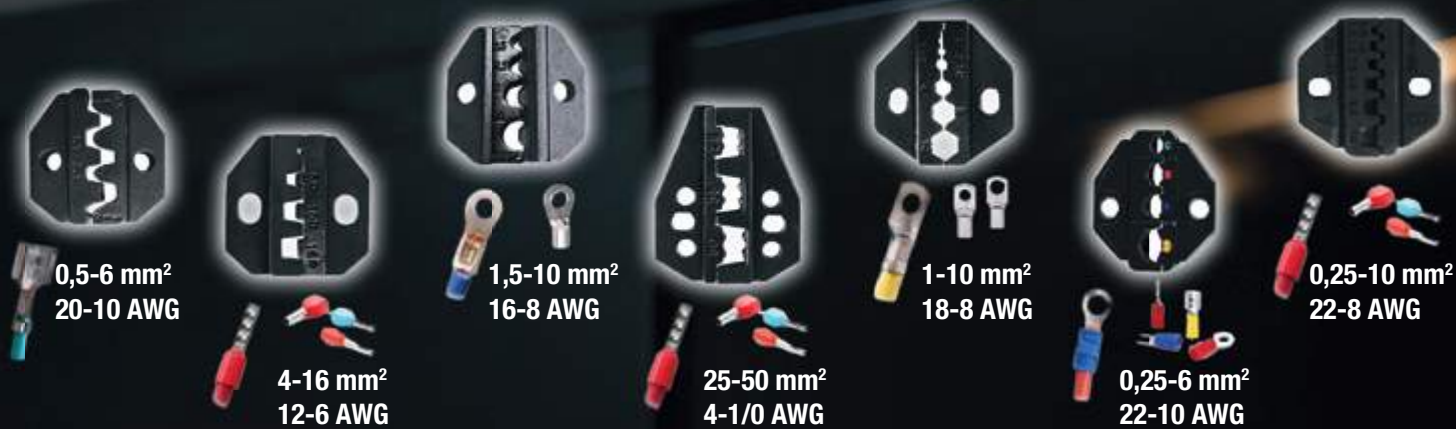



TRACON	mm ²	kN max	m	V	Ah	Li-ion
DM50	0,5 - 50	16	1440 g	18 V	2 × 2500 mAh	Li-ion

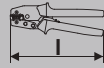

TZCS2

ALAT ZA REZANJE I GULJENJE PROVODNIKA

TRACON	 mm ²		 m
TZCS2	0,03-10	198 mm	142 g



BC..

BC14

BC8



SEKAČ ZA ŠRAFOVE

TRACON			
BC8	CR-V	205 mm	374 g
BC14	CR-V	350 mm	861 g



FUSZ.. VESZ..



FUSZP..

SDS PLUS, BURGIJE I DLETA

TRACON	D (mm)	L (mm)	Broj oštrica burgije
FUSZ6160	6	160	2
FUSZ8160	8	160	2
FUSZ10160	10	160	2
FUSZ12160	12	160	2
FUSZP6160	6	160	4
FUSZP8160	8	160	4
FUSZP10160	10	160	4
FUSZP12160	12	160	4

TRACON	D (mm)	L (mm)	Broj oštrica burgije
VESZP14250	14	250	–
VESZF1425020	14	250	–
VESZF1425040	14	250	–



TRACON



ZSTH..

PRESA ZA SPOJNU ČAURU
SA ZGRČAVANJEM IZOLACIJE



LYZST

SET ZA POPRAVKU KABLA



TRACON	d ₁ (mm)	D (mm)	L (mm)	mm ²				D ₁ (mm)	D ₂ (mm)	S (mm)	
ZSTHPSET	1,8	4,6	37	1-1,5	0,5-1,5	0,75-1	19	9	2,15		
ZSTHKSET	2,6	5,4	36,6	2,5-4	1,5-2,5	1,5-2,5	LYZST	24	8	2,4	
ZSTHSSET	3,6	6,6	42	4-6	4-6	2,5-4		24	8	2,4	



T..U

UNIVERZALNA TIPLA



TRACON	D × L (mm)	d × l (mm)
T6U	6 × 30	–
T8U	8 × 40	–
T10U	10 × 55	–
T6UCS	6 × 30	4 × 40
T8UCS	8 × 40	5 × 50
T10UCS	10 × 55	6 × 60

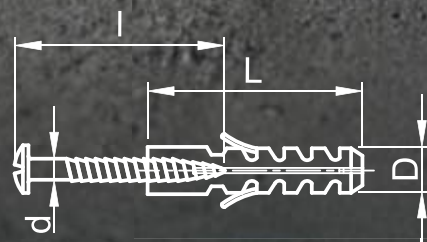

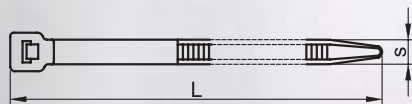

RELEVANT STANDARD
EN 62275



Trajno otporna na: derivate ugljovodnika, organske razređivače, alkohol
 Umereno otporna na: organske kiseline, baze, neorganske soli i drugim organskim materijalima
 Nije otporna na: neorganske kiseline i oksidantima

TRADICIONALNE VEZICE



TRACON

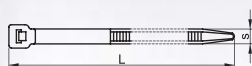

80PR		81PR		75 × 2,2 mm	0,75 - 15 mm	35 N
NEW 110PR		NEW 111PR		120 × 4,6 mm	3,5 - 23,8 mm	110 N
120PR		121PR		98 × 2,5 mm	1 - 21 mm	45 N
130PR		131PR		135 × 2,6 mm	1 - 32 mm	45 N
150PR		151PR		140 × 3,6 mm	2 - 36 mm	80 N
160PR		161PR		160 × 2,6 mm	1 - 40 mm	45 N
170PR		171PR		200 × 3,6 mm	2 - 50 mm	80 N
180PR		181PR		180 × 7,8 mm	3,5 - 45 mm	250 N
190PR		191PR		200 × 4,8 mm	3 - 50 mm	110 N
200PR		201PR		200 × 2,6 mm	1 - 52 mm	45 N
210PR		211PR		290 × 4,8 mm	3,5 - 79 mm	110 N
220PR		221PR		360 × 4,8 mm	3,5 - 103 mm	110 N
230PR		231PR		290 × 3,6 mm	2 - 80 mm	80 N
NEW 240PR		NEW 241PR		250 × 3,6 mm	3,5 - 68 mm	80 N
250PR		251PR		250 × 4,8 mm	3 - 68 mm	110 N
260PR		261PR		365 × 7,8 mm	8 - 100 mm	250 N
270PR		271PR		260 × 2,5 mm	3 - 73 mm	45 N
280PR		281PR		280 × 8,0 mm	4 - 65 mm	180 N
NEW 290PR		NEW 291PR		290 × 12,4 mm	9 - 76 mm	450 N
300PR		301PR		300 × 7,8 mm	5 - 80 mm	250 N
370PR		371PR		370 × 3,6 mm	5 - 108 mm	80 N
NEW 380PR		NEW 381PR		380 × 2,8 mm	3 - 110 mm	45 N
NEW 400PR		NEW 401PR		400 × 8,8 mm	8,5 - 115 mm	350 N
430PR		431PR		430 × 4,8 mm	3,5 - 115 mm	110 N
450PR		451PR		450 × 7,8 mm	35 - 130 mm	250 N
530PR		531PR		550 × 8 mm	10 - 160 mm	250 N
550PR		551PR		550 × 4,6 mm	4 - 160 mm	110 N
580PR		581PR		580 × 12,4 mm	9 - 168 mm	450 N
610PR		611PR		610 × 8,8 mm	9 - 181 mm	350 N
NEW 740PR		NEW 741PR		740 × 4,8 mm	3,5 - 220 mm	110 N
NEW 750PR		NEW 751PR		750 × 7,6 mm	8,5 - 226 mm	250 N
760PR		761PR		780 × 9 mm	35 - 233 mm	350 N
850PR		851PR		850 × 12,6 mm	40 - 255 mm	450 N
1000PR		1001PR		1000 × 12,6 mm	40 - 302 mm	450 N
NEW 1530PR		NEW 1531PR		1530 × 9,0 mm	8,5 - 450 mm	450 N

**BEZ ALATA
ZA SEČENJE,
SA UGRAĐENIM
SEČIVOM!**

SPECIJALNE VEZICE

SAMOSEČIVA VEZICA

TRACON			
200TC	200 × 4.4 mm	3 - 50 mm	110 N
280TC	280 × 4.4 mm	4 - 65 mm	110 N



**UŠTEDITE VREME SA SAMOREZIVIM KABLOVSKIM VEZICAMA.
ZATEGNITE, ZAVRNITE — NISU POTREBNI ALATI
ZA SEČENJE.**

POZICIONABILNA DVOSTRUKA VEZICA

TRACON			
200R	200 × 4.8 mm	3 - 50 mm	110 N
300R	300 × 4.8 mm	5 - 80 mm	110 N



RBIL..

STEZALJKA ZA CEVI



TRACON	
RBIL12	8 - 12 mm
RBIL20	12 - 20 mm
RBIL32	20 - 32 mm
RBIL50	32 - 50 mm



RRBIL..

STEZALJKA ZA CEVI OD NERĐAJUĆEG ČELIKA



TRACON	
RRBIL16	10 - 16 mm
RRBIL25	16 - 25 mm
RRBIL40	25 - 40 mm
RRBIL50	35 - 50 mm



RSZ..

TRAKA ZA FIKSIRANJE

TRACON		L x W x H (mm)
RSZ4	4 mm	10 m x 12 mm x 0,5 mm
RSZ6	6 mm	10 m x 17 mm x 0,5 mm
RSZ8	8 mm	10 m x 25 mm x 0,6 mm



GARN2F,
GARN2S

GARN..

GARN..

BAŠTENSKA STOJEĆA SVETILJKA SA UTIČNICOM



TRACON				P_{max}			L x W x H (mm)
GARNE27	max. 35 W	E27	3 x 1,5, H05VV-F	–	–	–	85 x 85 x 500
GARN2FE27	max. 35 W	E27	3 x 1,5, H05VV-F	max. 2600 W	–	2	85 x 85 x 500
GARN2SE27	max. 35 W	E27	3 x 1,5, H05VV-F	max. 2600 W	2	–	85 x 85 x 500
GARN2S	–	–	3 x 1,5, H05VV-F	max. 2600 W	2	–	85 x 85 x 350
GARN2F	–	–	3 x 1,5, H05VV-F	max. 2600 W	–	2	85 x 85 x 350



TRACON



LSC..



LSCB2W

LSCW2W



SOLARNA LED ZIDNA LAMPA SA SENZOROM POKRETA

SMD LED

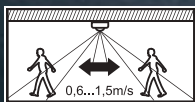
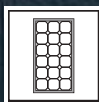

TRACON	[W]	[lm]	Tc [K]	V	P _{max}		L x W x H (mm)
LSCB2W	2 W	300 lm	4000 K	3,7 V / 1,2 Ah Li-Ion	4,4 Wp		88 x 74 x 95
LSCW2W	2 W	300 lm	4000 K	3,7 V / 1,2 Ah Li-Ion	4,4 Wp		88 x 74 x 95



LST..



SOLARNA LED ZIDNA LAMPA SA SENZOROM POKRETA



LSTBR45CCT



TRACON					
LSTBP3NW	3 W	300 lm	4000 K	3,7 V / 0,8 A	193 × 141 × 33
LSTB10NW	10 W	1100 lm	4000 K	3,7 V / 2,6 A	193 × 141 × 33
LSTB20NW	20 W	1800 lm	4000 K	3,7 V / 5,2 A	264 × 204 × 33
LSTBR45CCT *	45 W	5000 lm	4000 K	3,7 V / 10,8 A	322 × 352 × 36
LSTW20NW	20 W	1800 lm	4000 K	3,7 V / 5,2 A	264 × 204 × 33

* Može se upravljati i daljinskim upravljačem!



HARMONY
BY TRACON

STL..

RUČNA LED SVETILJKA SA AKUMULATOROM



STL10W



STLCN10W



STLB20W

- 100/50%
- SMD LED
- Tc [K]
- IP 44



TRACON	[W]	[lm]	[h]	[K]	[V]	[h]
STLB20W	20 W	1200 lm	4 h	3000 / 4000 / 6500 K	3,7 V, 3 Ah Li-Ion	5 h
STLCN10W	10 - 1,5 W	300 + 90 lm	8 h	6500 K	3,7 V, 4 Ah Li-Ion	3,5 h
STLS10W	10 - 2 W	500 + 110 lm	4 h	6500 K	3,7 V, 1,8 Ah Li-Ion	3 h



STLFL..

LED REFLEKTORI SA AKUMULATOROM



TRACON	2 x 5 W	LED	[lm]	Tc [K]	[h]	V	[h]
STLFL25W	2 x 5 W	70 W	1000 lm	4000 K	1.5 h	3,7V / 3,6Ah Li-ion	3 h
STLFL10W	10 W	70 W	800 lm	4000 K	2 h	3,7V / 3,6Ah Li-ion	3 h
STLFLU10W	10 W	70 W	1000 lm	4000 K	3 h	3,7V / 4,4Ah Li-ion	4 h
STLFLU20W	20 W	150 W	2000 lm	4000 K	3 h	3,7V / 6,6Ah Li-ion	4 h





TRACON



RSMDA..

PRENOSIVI LED REFLEKTORI +USB PUNJAČ



TRACON	 [W]	 LED	 [lm]	 Tc [K]	 [h]	 V
RSMDAF10W	10 W	75 W	800 lm	4000 K	3 h	3,7V / 2,2 Ah
RSMDAF20W	20 W	150 W	1600 lm	4000 K	3 h	3,7V / 4,4 Ah

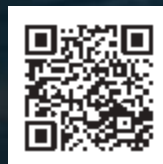

RSMDA..



STALAK I LED REFLEKTOR SA STALKOM

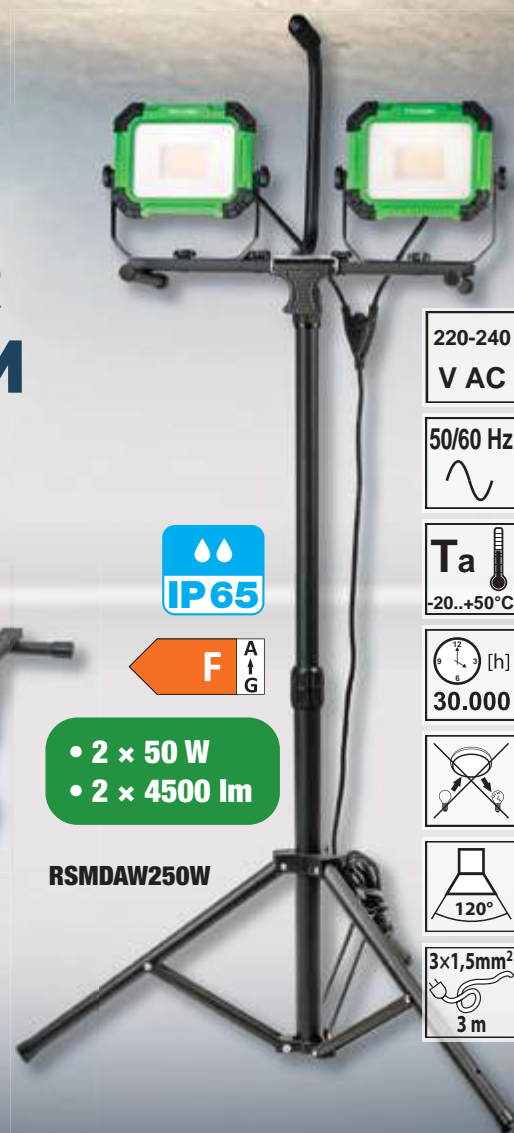

Radna lampa se može lako skinuti sa postolja i koristiti samostalno.



RSMDAW..



RSMDAWS50W



RSMDAWF100W



RSMDAWF50W, RSMDAWF100W

PRENOSIVI LED REFLEKTORI

SA SCHUKO ILI FRENCH UTIČNICOM

230 V AC	50/60 Hz	Tc [K] 4.000 K		 120°	 30.000 [h]	Ta -20..+50°C	 3x1,5mm ² 1,5 m	
-------------	----------	-------------------	--	----------	----------------	------------------	-----------------------------------	--

TRACON				P_{max}			
	[W]	LED	[lm]		SCHUKO	FRENCH	
RSMDAWS50W	50 W	400 W	4500 lm	max. Σ 2600 W	1	-	
RSMDAWS100W	100 W	750 W	9000 lm	max. Σ 2600 W	2	-	
RSMDAWF50W	50 W	400 W	4500 lm	max. Σ 2600 W	-	1	
RSMDAWF100W	100 W	750 W	9000 lm	max. Σ 2600 W	-	2	

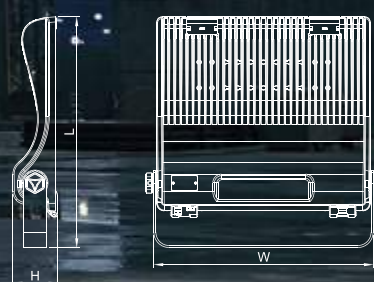

RHISN.. LED REFLEKTOR

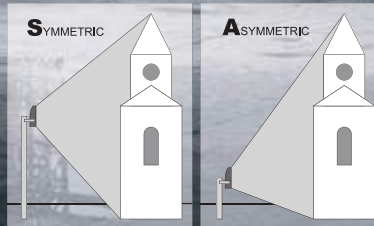

100-240 V AC 50/60 Hz ≥75 Ra ON-OFF >30.000 SMD LED 3 x 1,5mm² 30 cm IK08 1 [m]

TRACON	[W]	[W]	[lm]	[K]		L (mm)	W (mm)	H (mm)	
RHISN2550W	50 W	150 W	7000lm	4000K		317	255	63	
RHISN25100W	100 W	250 W	14000lm	4000K		346	295	67	
RHISN25150W	150 W	400 W	21000lm	4000K		380	326	73	
RHISN25200W	200 W	500 W	28000lm	4000K		436	367	78	
RHISN25300W	300 W	800 W	42000lm	4000K		471	427	78	
RHISNS50W	50 W	150 W	7000lm	4000K		317	255	63	
RHISNS100W	100 W	250 W	14000lm	4000K		346	295	67	
RHISNS150W	150 W	400 W	21000lm	4000K		380	326	73	
RHISNS200W	200 W	500 W	28000lm	4000K		436	367	78	
RHISNS300W	300 W	800 W	42000lm	4000K		471	427	78	
RHISNA50W	50 W	150 W	7000lm	4000K		317	255	63	
RHISNA100W	100 W	250 W	14000lm	4000K		346	295	67	
RHISNA150W	150 W	400 W	21000lm	4000K		380	326	73	
RHISNA200W	200 W	500 W	28000lm	4000K		436	367	78	
RHISNA300W	300 W	800 W	42000lm	4000K		471	427	78	



RSMD8Y..



LED REFLEKTOR



TRACON					L x W x H (mm)		
RSMD8YS100W	100 W	14000 lm	4000 K		460 x 311 x 70		
RSMD8YS150W	150 W	21000 lm	4000 K		460 x 311 x 70		
RSMD8YS200W	200 W	28000 lm	4000 K		520 x 367 x 72		
RSMD8YS240W	240 W	33600 lm	4000 K		520 x 367 x 72		
RSMD8YS300W	300 W	42000 lm	4000 K		581 x 417 x 72		
RSMD8YS400W	400 W	56000 lm	4000 K		581 x 417 x 72		
RSMD8YS500W	500 W	70000 lm	4000 K				
RSMD8YS600W	600 W	84000 lm	4000 K				672 x 473 x 79
RSMD8YA100W	100 W	14000 lm	4000 K				460 x 311 x 70
RSMD8YA150W	150 W	21000 lm	4000 K				460 x 311 x 70
RSMD8YA200W	200 W	28000 lm	4000 K				520 x 367 x 72
RSMD8YA240W	240 W	33600 lm	4000 K				520 x 367 x 72
RSMD8YA300W	300 W	42000 lm	4000 K				
RSMD8YA400W	400 W	56000 lm	4000 K				581 x 417 x 72
RSMD8YA500W	500 W	70000 lm	4000 K				672 x 473 x 79
RSMD8YA600W	600 W	84000 lm	4000 K				672 x 473 x 79

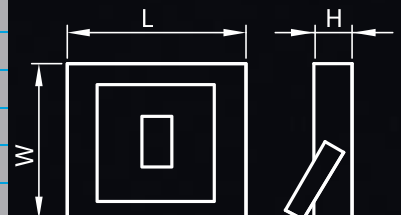



HARMONY
BY TRACON

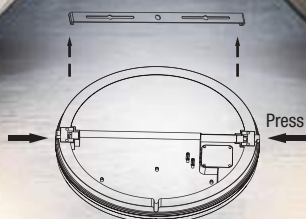

jednostavno
montiranje



MFK..

LED PLAFONSKA LAMPA SA PREKIDAČEM ZA PODEŠAVANJE TEMPERATURA BOJE



TRACON			Tc [K]		D × H (mm)	
MFK20CCT	20 W	2000 lm	3000/4000/6500 K		200 × 55	
MFK30CCT	30 W	3000 lm	3000/4000/6500 K		300 × 55	
MFK40CCT	40 W	4000 lm	3000/4000/6500 K		400 × 55	
MFK50CCT	50 W	5000 lm	3000/4000/6500 K		500 × 55	
MFKBL20CCT	20 W	2000 lm	3000/4000/6500 K		200 × 55	
MFKBL30CCT	30 W	3000 lm	3000/4000/6500 K		300 × 55	
MFKBL40CCT	40 W	4000 lm	3000/4000/6500 K		400 × 55	
MFKA20CCT	20 W	2000 lm	3000/4000/6500 K		200 × 55	
MFKS20CCT *	20 W	2000 lm	3000/4000/6500 K		200 × 55	

NEW 2024

NEW 2024

* sa senzorom pokreta



HARMONY
BY TRACON



2
YEARS
WARRANTY

IP65

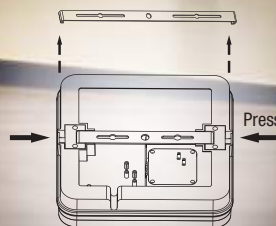

jednostavno
montiranje

MFKN..

PLAFONSKA LED LAMPA SA PREK. ZA PODEŠ. TEMP. BOJE



TRACON					L x W x H (mm)	
MFKN18CCT	18 W	1850 lm	3000/4000/6500 K		220 x 220 x 55	
MFKN24CCT	24 W	2500 lm	3000/4000/6500 K		290 x 290 x 55	
MFKNA18CCT	BASIC	18 W	1850 lm	3000/4000/6500 K		220 x 220 x 55
MFKNA24CCT		24 W	2500 lm	3000/4000/6500 K		290 x 290 x 55
MFKNBL18CCT	18 W	1850 lm	3000/4000/6500 K		220 x 220 x 55	
MFKNBL24CCT	24 W	2500 lm	3000/4000/6500 K		290 x 290 x 55	
MFKNS18CCT *		18 W	1850 lm	3000/4000/6500 K	220 x 220 x 55	

* sa senzorom pokreta



MFIP..

ZAŠTIĆENA OKRUGLA PLAFONSKA LAMPA



MFIP2E27

HARMONY
BY TRACON

230 V AC	50/60 Hz	max. 35 W				
TRACON				D x H (mm)		
MFIP1E27			1 x E27	256 x 90		
MFIP2E27			2 x E27	290 x 92		

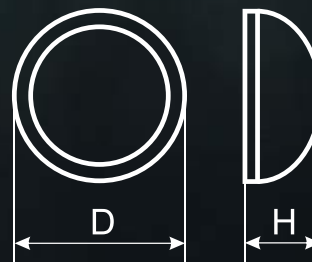

PLASTIČNO GRLO ZA SIJALICU E27



FE27SETFB

3
kom.



FE27SETSW



230 V AC		[mm ²] 2 x 1,5	
-------------	--	-------------------------------	--

TRACON				
FE27SETSW		E27	max. 60 W	
FE27SETFB		E27	max. 60 W	

SA BRZOM SPOJKOM

PRIKLJUČAK
SA STEZALJKOM



HARMONY
BY TRACON



LED-SET

LED TRAKASTI SETOVI

Naše LED trake su dostupne i u setovima, koji sadrže sve potrebne module za funkcionisanje, prema tome njihova montaža (ugradnja) je brza i jednostavna.

12 V DC	[h] 25.000	ON-OFF >30.000	SMD LED		120°	Hg 0 mg	T _{up} < 1s		
------------	---------------	-------------------	------------	--	------	------------	----------------------	--	--

TRACON	[W]	[lm]		L (m)	T _c [K]		
LED-SET-K-RGBW-2M	4,8 W / m	400 lm / m	10 mm	2	RGB+4000 K	100 mm	
LED-SET-K-RGBW-3M	4,8 W / m	400 lm / m	10 mm	3	RGB+4000 K	100 mm	
LED-SET-K-RGBW-5M	4,8 W / m	400 lm / m	10 mm	5	RGB+4000 K	100 mm	



HARMONY
BY TRACON



LBVN..

SVETILJKA ZA NAMEŠTAJ, LED T5



Proizvod ima kablovski ulaz sa obe strane, tako da se može nizati! Proizvod ima prekidač za podešavanje temperature boje!

230 V AC	SMD LED	Ra ≥80	House icon	Light bulb icon T _{up} < 1s	Dimensions icon 2x0,5 mm ² 1,2 m	Life span icon 30.000 [h]	Hg 0 mg	50/60 Hz	On-Off icon >30.000	Dimmer icon
-------------	------------	-----------	------------	---	---	------------------------------	------------	----------	------------------------	-------------

TRACON	Light bulb icon [W]	Light bulb icon LED	Light bulb icon [lm]	T _c [K]	L x W x H (mm)	Ei
LBVN5WCCT	5 W	7 W	500 lm	3000/4500/6500 K	305 x 22 x 28	
LBVN10WCCT	10 W	14 W	1000 lm	3000/4500/6500 K	570 x 22 x 28	
LBVN15WCCT	15 W	21 W	1500 lm	3000/4500/6500 K	870 x 22 x 28	F A G
LBVN20WCCT	20 W	28 W	2000 lm	3000/4500/6500 K	1170 x 22 x 28	
LBVN25WCCT	25 W	35 W	2500 lm	3000/4500/6500 K	1470 x 22 x 28	



HARMONY
BY TRACON



LBVL..

SVETILJKA ZA OSVETLJENJE NAMEŠTAJA, SA REG. JAČ. SVETLOSTI

- Senzorski prekidač na dodir (senzor UKLJ./ISKLJ.)
- Dimovanje dužim dodirom (podešavanje osvetljenosti)
- Podesiva temperatura boje (2700–6000 K)
- Direktno povezivanje na 230 V
- Tanki dizajn za ugradnju ispod nameštaja



230 V AC	50/60 Hz	25.000 [h]	ON-OFF >30.000	2x0,5 mm ² 2,5 m	Ra ≥80	RoHS	SMD LED	House icon	Mounting icon	Sensor ON-OFF	IP 20
----------	----------	------------	----------------	-----------------------------	--------	------	---------	------------	---------------	---------------	-------

TRACON	Power [W]	Light flux [lm]	Color temperature [K]	L x W x H (mm)	Sensor ON-OFF	Ei
LBVL18WCCT	18 W	1100 lm	2700 - 3000 - 4000 - 5000 - 5700 K	600 x 48 x 14	✓	
LBVL2X18WCCT	2 x 18 W	2 x 1100 lm	2700 - 3000 - 4000 - 5000 - 5700 K	2 x 600 x 48 x 14	✓	G A t G
LBVLSET2X6WCCT	2 x 6 W	2 x 400 lm	3000 - 4000 - 6000 K	2 x 392 x 41,2 x 10,3	✓	

Bočne spoljne svetiljke za SPOT izvore svetlosti

Naša SPGU linija proizvoda je proširena verzijama za spoljašnju upotrebu, sa senzorima svetlosti i pokreta!



SPGU10IPF1F

92×86×123 mm



SPGU10IPF2A

92×86×164 mm



BASIC



BASIC



SPGU10IPF1A

92×86×123 mm



SPGU10IPF2F

92×86×164 mm



SPGU10IPFA1F

105×68×163 mm



SPGU10IPFA2F

105×68×222 mm



SPGU10IPFA1A

105×68×163 mm

SPGU10IPFA2A

105×68×222 mm



SPGU10IPFS1F

105×68×163 mm

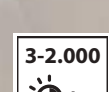

SPGU10IPFS1A

105×68×163 mm

SPGU10IPFS2A

105×68×222 mm

SPGU10IPFS2F

105×68×222 mm



NOVA PORODICA DETEKTORA PRISUSTVA U TRACON-U

Udobnost i preciznost u jednom uređaju!

U savremenom svetu, postoji sve veća potražnja za efikasnom i inteligentnom kontrolom osvetljenja. Za razliku od tradicionalnih detektora pokreta, naši PRS detektori prisustva se ne isključuju čak ni kada nema pokreta, čime se obezbeđuje radno okruženje bez smetnji. Infracrveni i visokofrekventni senzori garantuju pouzdan rad, sa maksimalnim dometom od 10 metara, čime se obezbeđuje potpuna pokrivenost većih površina.

Dostupni su u ugradnoj i plafonskoj verziji, u crnoj i beloj boji, harmonično se uklapaju u svako okruženje. Neki modeli imaju naprednu funkciju senzora daha, koja pruža još veću preciznost u detekciji prisustva. Nude idealno rešenje za kancelarije, sale za sastanke, biblioteke i svaku prostoriju gde je potrebno adekvatno osvetljenje čak i tokom statičkih aktivnosti.

Senzor prisustva sa praćenjem disanja



PRSR700



Pomoću širokog frekventnog opsega, senzori takođe mogu otkriti ljudsko disanje.

TRACON



360°



3-2000 lux



10 s...12 min.



61,5 mm

IP..

D x H (mm)

PRSR700

360°

3-2000 lux

10 s...12 min.

61,5 mm

IP 20

Ø 115 x 24

PRSR753

360°

3-2000 lux

10 s...12 min.

61,5 mm

IP 20

Ø 76 x 75,4



PRSR753

Dozvoljene snage uključivanja

	TRACON	PRSR700	PRSR753
		2000 W	1200 W
		2000 W	1200 W
		1000 W	600 W
		1000 W	600 W
		1,5 - 3,5 m	1,5 - 3,5 m
		< 6 m	< 6 m

ZAŠTIĆENI INFRACRVENI DETEKTORI POKRETA

Pasivni infracrveni senzori pokreta (PIR) detektuju promenu temperature oko predmeta, a u slučaju dovoljne mere promene se uključuje relej koji je ugrađen u senzor.

Stoga sam senzor mora da „vidi” telo u pokretu, bez toga neće doći do uključivanja. Osetljivost je uvek veća u slučaju poprečnog kretanja, a manja u slučaju dolaznog kretanja, iz tog razloga montažu infracrvenih senzora sa jednim senzorom preporučujemo paralelno sa očekivanim smerom kretanja. Osetljivost infracrvenih senzora nije podesiv!



230 V AC	50/60 Hz						
TRACON		lux		L x W x H D x H (mm)	IP..		
TMB-112BL ●●	180°	3-2000 lux	10 s ... 15 min.	91 x 84 x 63	IP 44		

Dozvoljene snage uključivanja

TRACON						
TMB-112BL ●●	1000 W	800 W	300 W	300 W	1,8 - 2,5 m	<12 m



PAMETNI SENZORI POKRETA

TMB-05T



230 V AC	50/60 Hz				
----------	----------	--	--	--	--

TRACON		lux			IP..	D x H (mm)
TMB-05DA	360°	10-2000 lux	10 s ... 60 min.	55 mm	IP 20	∅ 102 x 76,6
TMB-05T	360°	5-2000 lux	5 s ... 60 min.	-	IP 20	∅ 115 x 24,3

Parametri senzora se takođe može podesiti iz aplikacije Tuya (TMB-05T) i Dali sistema (TMB-05DA).



Dozvoljene snage uključivanja

TRACON						
TMB-05DA	-	-	-	-	2,2 - 6 m	< 20 m
TMB-05T	2000 W	2000 W	1000 W	1000 W	2,2 - 4 m	< 8 m

Zaštićeni infracrveni detektori pokreta



TMB-060BIP



TMB-061E



TMB-112X



TMB-112XB



TMB-115X



TMB-115XB



TMB-118X

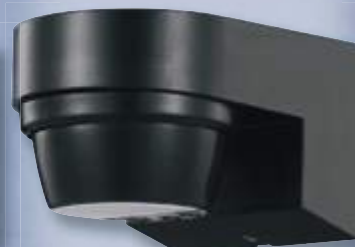

TMB-118XB



TRACON	(°)	lux		IP..	L x W x H (mm)
TMB-060BIP	190°	3-2000 lux	10 s ... 7 min.	IP 65	86 x 86 x 64
TMB-061E	360°	3-2000 lux	10 s ... 30 min.	IP 54	Ø62 x 92
TMB-112X	180/360°	3-2000 lux	10 s ... 15 min.	IP 54	80 x 68 x 56
TMB-112XB	180/360°	3-2000 lux	10 s ... 15 min.	IP 54	80 x 68 x 56
TMB-115X	180/360°	3-2000 lux	10 s ... 15 min.	IP 65	120 x 80 x 52
TMB-115XB	180/360°	3-2000 lux	10 s ... 15 min.	IP 65	120 x 80 x 52
TMB-118X	240/360°	3-2000 lux	10 s ... 15 min.	IP 65	100 x 75 x 62
TMB-118XB	240/360°	3-2000 lux	10 s ... 15 min.	IP 65	100 x 75 x 62

TRACON		HALOGEN	CFL	LED	h _t	L _s
TMB-060BIP	500 W	500 W	200 W	200 W	1 - 1,8 m	<9 m
TMB-061E	1200 W	1200 W	600 W	600 W	2,2 - 6 m	<20 m
TMB-112X	1200 W	1200 W	600 W	600 W	1,8 - 2,2 m	<12 m
TMB-112XB	1200 W	1200 W	600 W	600 W	1,8 - 2,2 m	<12 m
TMB-115X	1200 W	1200 W	600 W	600 W	1,8 - 2,5 m	<12 m
TMB-115XB	1200 W	1200 W	600 W	600 W	1,8 - 2,5 m	<12 m
TMB-118X	2000 W	2000 W	1000 W	1000 W	1,8 - 2,5 m	<14 m
TMB-118XB	2000 W	2000 W	1000 W	1000 W	1,8 - 2,5 m	<14 m

Unutrašnji infracrveni detektori pokreta



TMB-060B



TMB-061F



TMBU-47



TMB-05H



230 V AC	50/60 Hz			INFRA			
TRACON				L x W x H D x H (mm)	IP..		
TMB-060B	190°	3-2000 lux	10 s ... 7 min.	80 x 80 x 59	IP 20		
TMB-061F	360°	3-2000 lux	10 s ... 15 min.	Ø77 x 92	IP 20		
TMBU-47	360°	3-2000 lux	10 s ... 30 min.	Ø111 x 63	IP 20		

Dozvoljene snage uključivanja

TRACON		HALOGEN	CFL	LED		
TMB-060B	500 W	500 W	200 W	200 W	1 - 1,8 m	<9 m
TMB-061F	2000 W	2000 W	1000 W	1000 W	2,2 - 4 m	<30 m
TMBU-47	2000 W	2000 W	1000 W	1000 W	2,2 - 6 m	<16 m

Infra senzor kretanja, na zid, beli

220-240 V AC	50/60 Hz		RADAR		
TRACON				IP..	L x W x H (mm)
TMB-05H	360°	3-2000 lux	10 s ... 12 min.	IP 20	Ø 115 x 24

TMBDIMM



Sklopka i dimer na dodirivanje, skrivena instalacija

TRACON	I_n	U_n		LED	L x W x H (mm)
TMBDIMM	3 A	12 - 24 VDC	max. 60 W		Ø 48 x 48 x 6

Sklopke sumraka

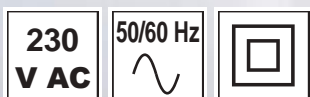

TRACON	In	lux	ON - t _{off}	IP..	L x W x H (mm)
ALK-OUT	10 A	5-50 lux	-	IP 44	∅ 82 x 108
<small>NEW 2025</small> ALK-OUT2	10 A	<5-50 lux	-	IP 66	∅ 78 x 92
ALK-BOX	16 A	2-100 lux	-	IP 20	90 x 35 x 66
ALK-IN	5 A	3-50 lux	1-8 h, OFF	IP 44	109 x 70 x 40
<small>NEW 2025</small> ALK-IN2	15 A	<3-500 lux	-	IP 65	109 x 70 x 40
ALK-472	1 A (100 W)	5-15 lux	1-12 h, OFF	IP 20	∅ 52 x 89
ALK110	-	50-800 lux, 1-10 VDC	-	IP 20	∅ 21 x 64

Dozvoljene snage uključivanja

TRACON	ALK-OUT	ALK-BOX	ALK-IN	ALK-472
	300 W	500 W	900 W	100 W
 HALOGEN	200 W	300 W	500 W	100 W
 CFL	100 W	120 W	200 W	50 W
 LED	100 W	120 W	200 W	50 W

Svojstvo svake sklopke sumraka je, da prilikom prvog priključenja na napajanje vrše samotestiranje koji se sastoji od jednog uključivanja, i jednog isključenja. Normalni rad uređaje počinje nakon ovog samotestiranja sa vremenskim kašnjenjem od 15 s – 1 min .

Senzor ALK110 je pogodan za kontrolu osvetljenja svetiljke sa kontrolnim signalom od 1-10 V. Senzor ne zahteva eksterno napajanje.



SL..



SLB..

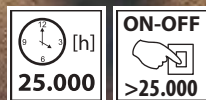

ZIDNA PLASTIČNA SVETILJKA SA SENZOROM KRETANJA



SLU..

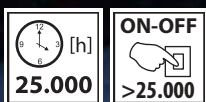

SLN

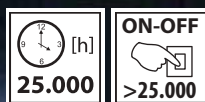

SLT

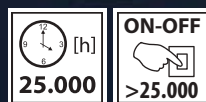

SLKS

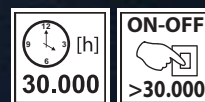

TRACON				L x W x H (mm)	D x H (mm)	IP..	
SLB10W	10 W	800 lm	4000 K	289 x 147 x 90	—	IP 54	
SLB15W	15 W	1100 lm	4000 K	289 x 147 x 90	—	IP 54	
SLU10W	10 W	950 lm	4000 K	270 x 135 x 70	—	IP 54	
SLU15W	15 W	1450 lm	4000 K	270 x 135 x 70	—	IP 54	
SLT15W	15 W	1300 lm	4000 K	175 x 182 x 72	—	IP 65	
SLN20W	20 W	1900 lm	4000 K	210 x 210 x 41	—	IP 65	
SLKS15W	15 W	1500 lm	4000 K	—	Ø 210 x 49	IP 65	

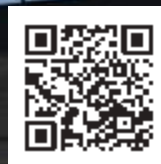

OKRUGLA ZIDNA LAMPA SA SENZOROM POKRETA



TRACON			Tc [K]		D x H (mm)	IP..	
MFPM18CCT	10/15/18 W	1000/1500/1800 lm	3000/4000/6000 K	–	∅ 231 x 19	IP 20	
MFM012	max. 2 x 60W	–	–	2 x E27	∅ 275 x 117	IP 44	–
MFMI12W	12 W	900 lm	4000 K	–	∅ 290 x 57	IP 20	
MFMI16W	16 W	1100 lm	4000 K	–	∅ 290 x 57	IP 20	
MFMI20W	20 W	1800 lm	4000 K	–	∅ 290 x 57	IP 20	

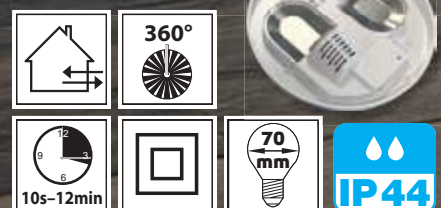
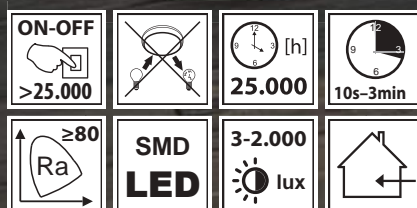
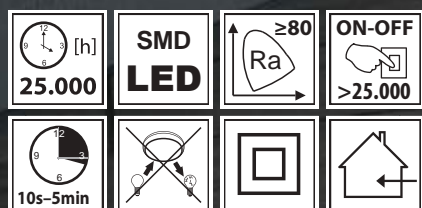

Zidna svetiljka, zakrivljeni oblik

Naša nova svetiljka zakrivljenog oblika takođe ima posebne karakteristike. Ugrađeni senzor pokreta može se isključiti kada nije potreban, a njegova snaga se može podesiti (12 – 15 – 20 W) ako se svetlo nakon instalacije ispostavi da je previše jako.

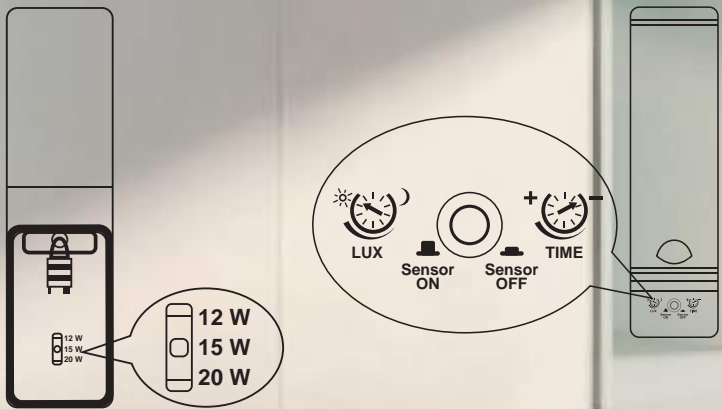

230 V AC	50/60 Hz	Ra ≥80	SMD LED	30.000 [h]	ON-OFF >30.000	RoHS	REACH	UL	Household	HARMONY BY TRACON
TRACON	[W]	[lm]	Tc [K]	L x W x H D x H (mm)	Ei					
SLIBA20W	20 W	2300 lm	4500 K	250 x 66 x 188	E					

Svetlosna tabla sa kućnim brojem sa senzorom kretanja i brojevima

* sa opcijom naknadnog osvetljenja

Kao opcija, može se podesiti osnovna opcija svetla, koja obezbeđuje smanjenu osvetljenost za određeni vremenski period ako se ne detektuje kretanje.

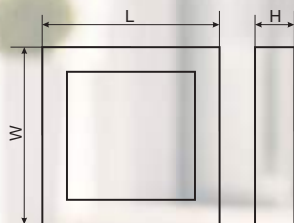
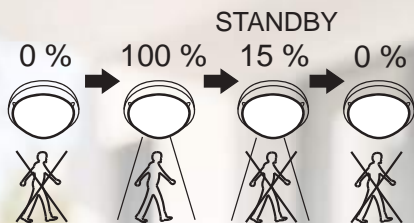

230 V AC	50/60 Hz	10s-15min	30.000 [h]	ON-OFF >30.000	RoHS	REACH	UL	Household	SMD LED	Person
TRACON	[W]	[lm]	Tc [K]	L x W x H (mm)	Ei					
MFHV20W	20 W	1800 lm	4500 K	300 x 277 x 52	F					

MFM..



Zidne svetiljke od plastike sa senzorom kretanja



HARMONY
BY TRACON

TRACON				D × H (mm)	Tc [K]	IP..	Ei
MFM01	1 × E27	max. 1 × 25 W	–	270 × 103	–	IP20	–
MFM02D*	–	16 W	1300 lm	300 × 87	4500 K	IP66	G
MFM04N	–	12 W	950 lm	245 × 59	4500 K	IP44	G
MFM04D*	–	23 W	1700 lm	315 × 67	4500 K	IP44	G
MFM07*	–	22 W	2400 lm	300 × 40	4500 K	IP65	F

* sa opcijom naknadnog osvetljenja

Kao opcija, može se podesiti osnovna opcija svetla, koja obezbeđuje smanjenu osvetljenost za određeni vremenski period ako se ne detektuje kretanje.

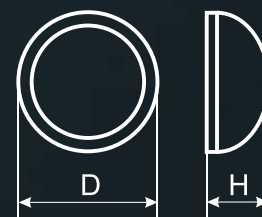
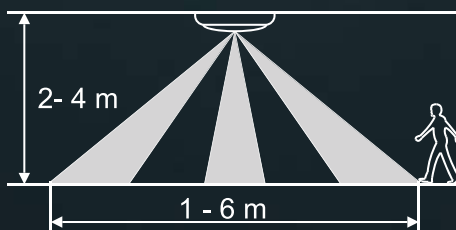

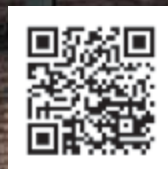

TLFVLEDN..





ZAŠTIĆENA SVETILJKA ZA LED CEVI

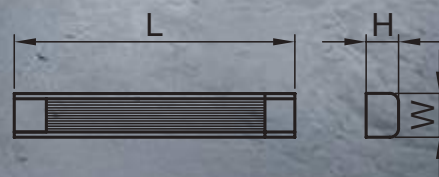

Klipse su u sklopu pribora.



TRACON				L x W x H (mm)
TLFVLEDN106	1 x 18 W	1 x 600 mm	x 6	672 x 64,4 x 60
TLFVLEDN112	1 x 36 W	1 x 1200 mm	x 12	1282 x 64,4 x 60
TLFVLEDN115	1 x 58 W	1 x 1500 mm	x 14	1582 x 64,4 x 60
TLFVLEDN206	2 x 18 W	2 x 600 mm	x 6	627 x 98,4 x 60
TLFVLEDN212	2 x 36 W	2 x 1200 mm	x 12	1282 x 98,4 x 60
TLFVLEDN215	2 x 58 W	2 x 1500 mm	x 14	1582 x 98,4 x 60

Ožičenje svetiljki je izvedeno za LED cevi za napajane sa jedne strane (LT8G.., LT8GH), ožičenje se mora korigovati za dvostrano napajane cevi, na osnovu uputstva za upotrebu!



LVG..



INDUSTRIJSKA ZAŠTIĆENA LED SVETILJKA ZA NIZANJE

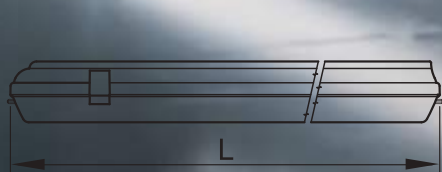

Proizvod ima kablovski ulaz sa obe strane, tako da se može nizati!

230 V AC	50/60 Hz	□	🏠	↕	SMD LED	🔧	IK08	PC / PC	120°	Tc [K] 4.000 K	ON-OFF >30.000	🕒 [h] 30.000
----------	----------	---	---	---	---------	---	------	---------	------	-------------------	-------------------	-----------------

TRACON	💡 [W]	💡 LED	💡 [lm]	Tc [K]	📐 [°]	L x W x H (mm)	Ei
LVG0618NW	18W	2 x 18 W	1650 lm	4000 K	120°	650 x 74 x 42,5	
LVG1236NW	36W	2 x 36 W	3300 lm	4000 K	120°	1250 x 74 x 42,5	F A I G
LVG1545NW	45W	2 x 58 W	4000 lm	4000 K	120°	1550 x 74 x 42,5	
LVG1560NW	60W	2 x 60 W	7000 lm	4000 K	120°	1550 x 74 x 42,5	E A I G



LVB..

ZAŠTIĆENA INDUSTRIJSKA LED SVETILJKA

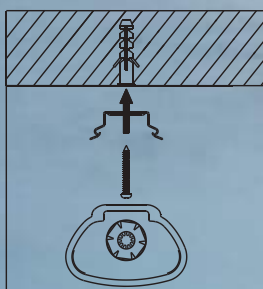
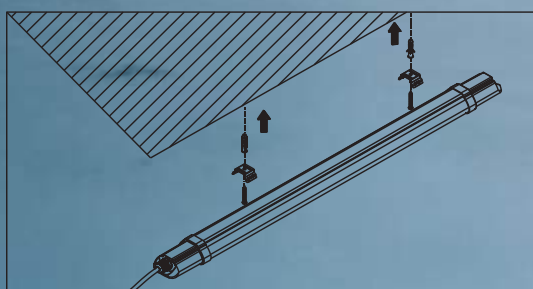

Proizvod ima kablovski ulaz sa obe strane, tako da se može nizati!



230 V AC	50/60 Hz	ON-OFF >30.000	15.000 [h]	Ra ≥80	□	🏠	🚫	↑	Ta -20..+50°C	SMD LED	🚫	IK06
-----------------	----------	-------------------	------------	--------	---	---	---	---	------------------	---------	---	------

TRACON	💡	LED	💡 [lm]	Tc [K]	△ [°]	L x W x H (mm)	Ei
LVB0618NW	18 W	2 x 18W	2700 lm	4000 K	120°	674 x 53 x 27	
LVB1236NW	36 W	2 x 36W	5400 lm	4000 K	120°	1274 x 53 x 27	DAG
LVB1545NW	45 W	2 x 58W	6750 lm	4000 K	120°	1574 x 53 x 27	



LHBAN..

**LED SVETILJKA
ZA HALE,
SPOLJAŠNJA,
OBLIKA UFO**



- Snaga 60-200 W
- Regulacija jačine svetlosti
- Životni vek 50.000 sati
- do 40.000 lumena

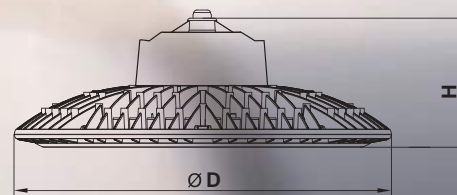

TRACON						
	(W)	LED	(lm)	Tc [K]	D × H (mm)	
LHBAN100W	60/80/100W	250 W	12000/16000/20000lm	4000 K	1 – 10 V	273 × 156
LHBAN150W	90/120/150W	400 W	18000/24000/30000lm	4000 K	1 – 10 V	300 × 159
LHBAN200W	120/150/200W	500 W	24000/32000/40000lm	4000 K	1 – 10 V	330 × 162





LHBF..

LED SPOLJAŠNJA SVETILJKA ZA HALE

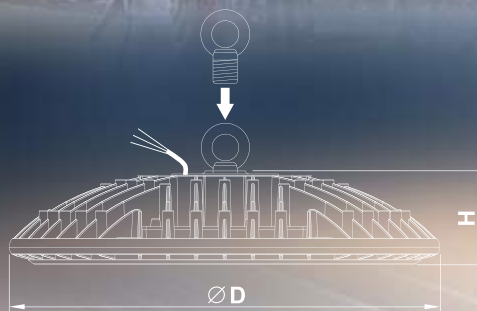

220-240 V AC	50/60 Hz	≥ 75 Ra	30.000 [h]	ON-OFF >30.000				Ta -20..+50°C		IK08	
------------------------	----------	-----------------	---------------	-------------------	--	--	--	------------------	--	------	--

TRACON	[W]	LED	[lm]	Tc [K]	D x H (mm)	Ei
LHBF100W	100 W	250 W	13000 lm	4500 K	290 x 75	
LHBF150W	150 W	400 W	19000 lm	4500 K	290 x 75	
LHBF200W	200 W	500 W	26000 lm	4500 K	340 x 78	
LHBF240W	240 W	750 W	31000 lm	4500 K	340 x 78	



LHBPW..



LHBPW240CCT

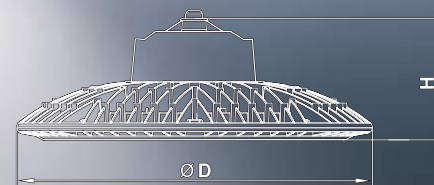

LED SPOLJAŠNJA SVETILJKA ZA HALE

- regulacija temperature boje
- i jačine svetlosti

90-265 V AC	50/60 Hz	[h] 50.000	ON-OFF >30.000	Tc [K] 30-50-100%						Ta -20...+50°C	IK08	120°	
-----------------------	----------	---------------	--------------------------	----------------------	--	--	--	--	--	-------------------	------	------	--

TRACON		[lm]	Tc [K]	D × H (mm)	
LHBPW100CCT	60 / 80 / 100 W	10200 / 13600 / 17000 lm	3000 / 4500 / 6000 K	290 × 173	
LHBPW150CCT	100 / 120 / 150 W	17000 / 20400 / 25000 lm	3000 / 4500 / 6000 K	290 × 173	
LHBPW240CCT	150 / 200 / 240 W	25000 / 34000 / 40000 lm	3000 / 4500 / 6000 K	340 × 178	



LHBHN..

LED SVETILJKE ZA HALE, SA REGUL. JAČINE SVETLOSTI



TRACON									
	[W]	LED	[lm]	[°]	[K]	[lm]	[°]	[mm]	
LHBHN100W	100 W	250 W	17000 lm	120 / 40°	4000 K	571 × 102 × 100	1 – 10 V		
LHBHN150W	150 W	400 W	25500 lm	120 / 40°	4000 K	802 × 102 × 100	1 – 10 V		
LHBHN200W	200 W	500 W	34000 lm	120 / 40°	4000 K	1024 × 102 × 100	1 – 10 V		



LSJH..

LED ULIČNO OSVETLJENJE, MOŽE SE OKAČITI, LSJH SERIJA

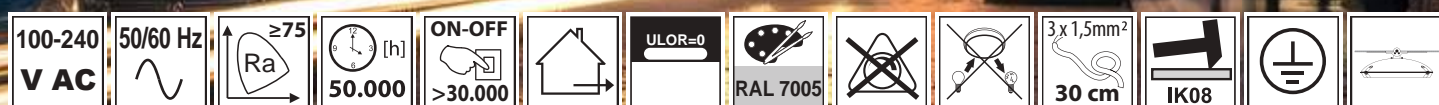

TRACON	W	LED W	[lm]	Tc [K]	D x H (mm)
LSJH30W	30 W	70 W	3900 lm	4500 K	500 x 211
LSJH50W	50 W	150 W	6500 lm	4500 K	500 x 211
LSJH100W	100 W	300 W	13000 lm	4500 K	500 x 211
LSJH30WW	30 W	70 W	3900 lm	2700 K	500 x 211
LSJH50WW	50 W	150 W	6500 lm	2700 K	500 x 211
LSJH100WW	100 W	300 W	13000 lm	2700 K	500 x 211

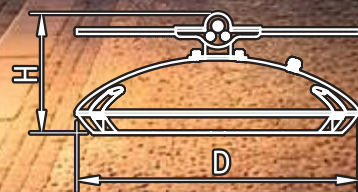



LED OSVETLJENJE ZA PARKOVE LSJP SERIJA..



TRACON					
LSJPA30W	30 W	70 W	3900 lm	4500 K	Ø 60 mm × 6 m
LSJPA50W	50 W	150 W	6500 lm	4500 K	Ø 60 mm × 8 m
LSJPA100W	100 W	300 W	13000 lm	4500 K	Ø 60 mm × 12 m
LSJPA30WW	30 W	70 W	3900 lm	2700 K	Ø 60 mm × 6 m
LSJPA50WW	50 W	150 W	6500 lm	2700 K	Ø 60 mm × 8 m
LSJPA100WW	100 W	300 W	13000 lm	2700 K	Ø 60 mm × 12 m
LSJPB30W	30 W	70 W	3900 lm	4500 K	Ø 60 mm × 6 m
LSJPB50W	50 W	150 W	6500 lm	4500 K	Ø 60 mm × 8 m
LSJPB100W	100 W	300 W	13000 lm	4500 K	Ø 60 mm × 12 m
LSJPB30WW	30 W	70 W	3900 lm	2700 K	Ø 60 mm × 6 m
LSJPB50WW	50 W	150 W	6500 lm	2700 K	Ø 60 mm × 8 m
LSJPB100WW	100 W	300 W	13000 lm	2700 K	Ø 60 mm × 12 m

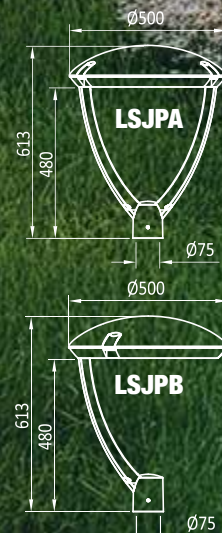



LSLSH..

SOLARNA HIBRIDNA LED ULIČNA RASVETA SA SENZOROM POKRETA

100-240 V AC		T _a -20...+50°C	SMD LED			IP 65
------------------------	--	-------------------------------	----------------	--	--	--------------

Može se napajati i iz mreže i pomoću solarnih panela.

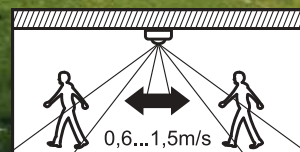

TRACON			T _c [K]		P _{max}		L × W × H (mm)
LSLSH40W	40 W	6600 lm	4000 K	9,6V / 12 Ah LiFePO4	115 Wh	4 m / Ø 60 mm	507 × 306 × 251
LSLSH60W	60 W	9600 lm	4000 K	12,8V / 12 Ah LiFePO4	153 Wh	6 m / Ø 60 mm	649 × 306 × 251



LSPLM

LED SOLARNO OSVETLJENJE ZA PARKOVE SA SENZOROM POKRETA

	T_a -20...+50°C	SMD LED		IP 65
--	-------------------------------------	----------------	--	--------------

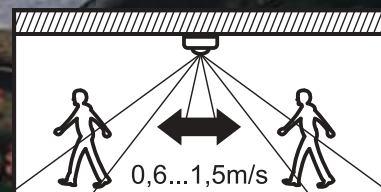

TRACON	15 W	2000 lm	T_c [K] 3000 / 4000 / 6000 K	3,2V / 12 Ah LiFePO4	3 - 4 m	L x W x H (mm) Ø 325 x 185
LSPLM15W						

IP65 zaštićeni LED panel

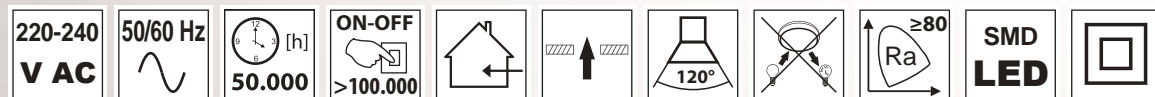

TRACON					L x W x H (mm)	
LPIP606040NW	40 W	4 x 18 W	4.000 lm	4.000 K	595 x 595 x 10	

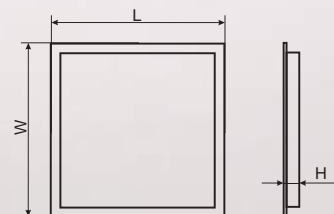

LED paneli sa 3 LED trake, kvadratni, beli

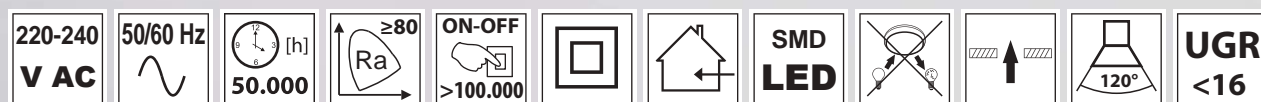

TRACON					L x W x H (mm)	
LPG606040NW	40 W	4 x 18 W	4000 lm	4000 K	596 x 595 x 15	
LPG606050NW	48 W	4 x 18 W	4800 lm	4000 K	596 x 595 x 15	

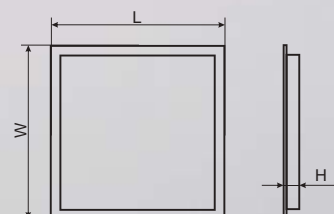

LED panel sa ivičnim osvetljenjem, kružno osvetljenje



TRACON					L x W x H (mm)	
LPR606040CCT	40 W	4 x 18 W	4000 lm	3000 - 4000 - 6000 K	595 x 595 x 30	

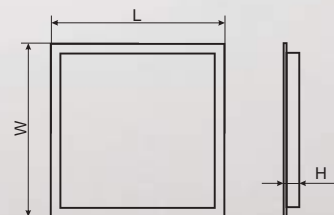



Duboki LED paneli sa pozadinskim osvetljenjem

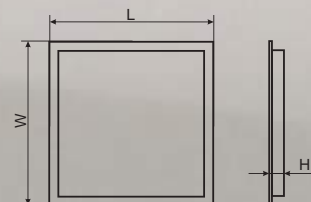
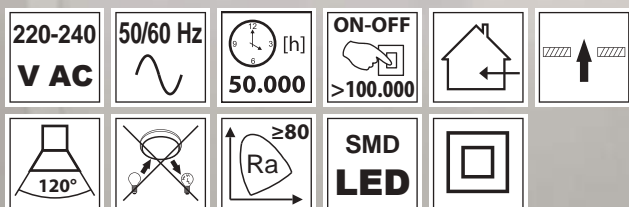

TRACON					L x W x H (mm)		
LPXUN3012040WW	40 W	2 x 36 W	4800 lm	2700 K	1195 x 295 x 30		
LPXUN3012040NW	40 W	2 x 36 W	4800 lm	4000 K	1195 x 295 x 30		
LPXUN3012040CW	40 W	2 x 36 W	4800 lm	6500 K	1195 x 295 x 30		
LPXUN606040WW	UGR <19	40 W	4 x 18 W	4800 lm	2700 K	595 x 595 x 30	
LPXUN606040NW		40 W	4 x 18 W	4800 lm	4000 K	595 x 595 x 30	
LPXUN606040CW		40 W	4 x 18 W	4800 lm	6500 K	595 x 595 x 30	
LPXUN606050WW		48 W	4 x 18 W	5760 lm	2700 K	595 x 595 x 30	
LPXUN606050NW	48 W	4 x 18 W	5760 lm	4000 K	595 x 595 x 30		
LPXUN606050CW	48 W	4 x 18 W	5760 lm	6500 K	595 x 595 x 30		
LPXN3012040NW	UGR <21	40 W	2 x 36 W	4800 lm	4000 K	1195 x 295 x 30	
LPXN606040NW		40 W	4 x 18 W	4800 lm	4000 K	595 x 595 x 30	
LPXN606050NW		48 W	4 x 18 W	5760 lm	4000 K	595 x 595 x 30	

TRACON APP



Okviri za montažu za LED panele

Panel	Pribor	Okvir	Visina okvira (mm)
LPY (9mm)	–	LP6060K/LP30120K (Tanak)	50
	INV-DL-15 (inverter)	LP6060K/LP30120K (Tanak)	50
	LPCC (dim. drajver)	LP6060K/LP30120K (Tanak)	50
	LPD (deblji drajver)	LP6060K/LP30120K (Tanak)	50
	LPDH (tanji drajver)	LP6060K/LP30120K (Tanak)	50
LPX/LPXU (30mm)	–	LP6060K/LP30120K (Tanak)	50
	INV-DL-15 (inverter)	LP6060KH/LP30120KH (Deblji)	65
	LPCC (dim. drajver)	LP6060KH/LP30120KH (Deblji)	65
	LPD (deblji drajver)	LP6060KH/LP30120KH (Deblji)	65
	LPDH (tanji drajver)	LP6060K/LP30120K (Tanak)	50
LPIP (30mm)	–	LP6060KH (Deblji)	65
	INV-DL-15 (inverter)	LP6060KH (Deblji)	65
	LPCC (dim. drajver)	LP6060KH (Deblji)	65
	LPD (deblji drajver)	LP6060KH (Deblji)	65
	LPDH (tanji drajver)	LP6060KH (Deblji)	65

Uz pomoć dodatnih montažnih ramova, LED paneli se mogu instalirati i van zida.

Materijal rama: aluminijum
Boja rama: bela

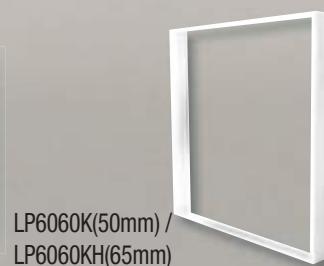

Zaštitne mreže

TRACON	L × W × H (mm)	
LP6060R	650 × 650 × 80	LP..6060..
LP30120R	1250 × 350 × 80	LP..30120..

Zaštitna mreža LP6060R/LP30120R može da se koristi sa bilo koji okvirom za LED panele

Materijal rama: aluminijum
Boja rama: bela

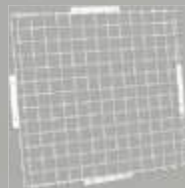

Oprema za viseću montažu LED panela

TRACON	600 × 600	300 × 1.200
LP606040F	LPX..., LPY..., LPG...	

Sa sajlama dužine 1.5 m

U slučaju izuzetno visokih spuštenih plafona za 1.5 m se može niže montirati panel, nije potrebno ceo spuštenu plafon rekonstruisati sem za panele **LP606040**.

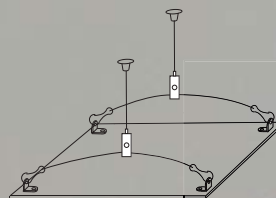



EXIT..

LED PUTOKAZ ZA IZLAZ SA OSVETLJENOM IVICOM SA PIKTOGRAMIMA NA LEPJENJE

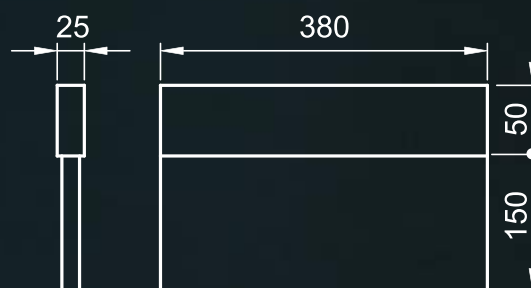
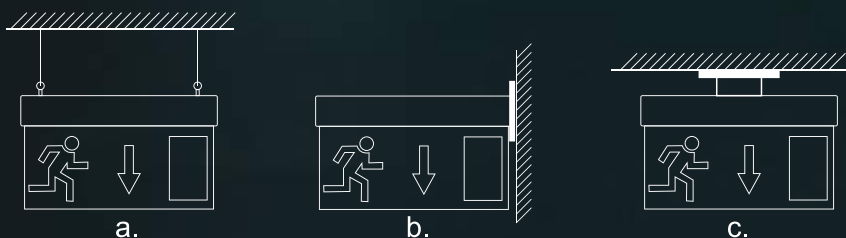

TRACON	4 W	≥3 h	300 lm	× 36	NM	3.7 V	1.200 mAh	Li-ion
--------	-----	------	--------	------	----	-------	-----------	--------

Svetiljke sa nekontinuiranim radom (NM), uključuju se nakon što je isključeno spoljno električno napajanje.



HARMONY
BY TRACON



LALD18W

LAL8W

LAL..

LED STOLNE SVETILJKE

220-240 V AC	[h] 25.000		SMD LED
-----------------	---------------	--	--------------------

TRACON	[W]	[lm]	Tc [K] 	
LALD18W	18 W	1200 lm	4000 K	
LAL8W	8 W	600 lm	3000-4500-6500 K	



LG4H2W,
LG4H2NW,
LG4X2NW,
LG4X2W

LG93,4NW

LHH2NW,
LHH3NW,
LHH3W



LG.., LH..

LED IZVOR SVETLOSTI

25.000 [h]	ON-OFF >30.000		Ra ≥80	SMD LED	Hg 0 mg	Tup < 1s
------------	----------------	--	--------	---------	---------	----------

TRACON	U _n					T _c [K]		D × L (mm)	Ei
LG4H2W	12 V AC/DC	G4	2 W	10 W	200 lm	2700 K	270°	12 × 39 mm	F
LG4H2NW	12 V AC/DC	G4	2 W	10 W	200 lm	4000 K	270°	12 × 39 mm	F
LG4X2NW	12 V AC/DC	G4	2 W	10 W	180 lm	4000 K	270°	11 × 37 mm	F
LG4X2W	12 V AC/DC	G4	2 W	10 W	180 lm	3000 K	270°	11 × 37 mm	F
LG93,4NW	230 VAC	G9	3,4 W	30 W	635 lm	4000 K	360°	18 × 50 mm	B
LHH2NW	230 VAC	E14	2 W	10 W	200 lm	4000 K	360°	16 × 45 mm	F
LHH3NW	230 VAC	E14	3 W	25 W	350 lm	4000 K	360°	16 × 55 mm	E
LHH3W	230 VAC	E14	3 W	25 W	350 lm	2700 K	360°	16 × 55 mm	E



SMARTREE

PAMETNI DOM

Pametna i jednostavna za kombinovanje – pametni sistem SMARTTREE od Tracon-a

- Velika prednost SMARTTREE sistema je u tome što se predajnici i prijemnici sistema mogu slobodno kombinovati jedni sa drugima, tako da se fleksibilan sistem može kreirati od najjednostavnijih kontrola do srednje velikih bez korišćenja posebne aplikacije.
- Elementi sistema međusobno komuniciraju putem radio frekvencije, kontrole zahtevaju instalaciju najmanje jednog predajnika i jednog prijemnika, ali veći broj jedinica može biti uključen u kontrolno kolo.
- Unapred programirani kompleti pomažu manje iskusnim korisnicima sa lakom instalacijom.

PREDAJNICI



EFNY2

EFNY2W

tasteri

EFNY4

EFNY4W



EFT2

EFT4

daljinski upravljači

EFT8

EFT36



EFPAAH

sa montiranjem
u Ø 60 kutije
sa spoljnim dugmetom

EFPAAE



KONTROLNI KOMPLETI **SMARTR**EE

EFSV1

osvetljenje



EFSV2

EFSVD

dimer



EFSR

žaluzina



EFSU

univerzalna



CIJA 868.32 MHz

PRIJEMNICI

EFPV1

univerzalna kontrola



EFPV2

prekidač za osvetljenje

EFPV2K



EFPD

dimovanje



sa montiranjem
u Ø 60 kutije

EFPV2DC

EFPV3DC

LED traka (10-14 VDC)

EFPC

EFPRGB



EFPRL

kontrola žaluzina

EFPRC



u razvodnu
tablu
35x7,5
montažnu šinu

EFPM1

univerzalna kontrola

EFPM2



Detaljni tehnički podaci:



TRACON	Naziv	Tehnički podaci
EFNY2	Taster sa radio predajnikom, 2 kanalni, za montažu na zid	3 VDC, 868,32 Mhz, 300 m
EFNY2W	Taster sa radio predajnikom, 2 kanalni, za montažu na zid, beli	3 VDC, 868,32 Mhz, 300 m
EFNY4	Taster sa radio predajnikom, 4 kanalni, za montažu na zid, krem	3 VDC, 868,32 Mhz, 300 m
EFNY4W	Taster sa radio predajnikom, 4 kanalni, za montažu na zid, beli	3 VDC, 868,32 Mhz, 300 m
EFT2	Daljinski upravljač, 2 kanalni, sa priveskom za ključeve	3 VDC, 868,32 Mhz, 300 m
EFT4	Daljinski upravljač, 4 kanalni, sa priveskom za ključeve	3 VDC, 868,32 Mhz, 300 m
EFT8	Daljinski upravljač, 8 kanalni	3 VDC, 868,32 Mhz, 350 m
EFT36	Daljinski upravljač, 36 kanalni	3 VDC, 868,32 Mhz, 300 m
EFPAH	Taster sa radio predajnikom, 4 kanalni, u montažnu kutiju	230 V, 50 Hz, 868.32 MHz, 250 m
EFPAE	Taster sa radio predajnikom, 4 kanalni, u montažnu kutiju, na baterije	3 VDC, 868,32 Mhz, 250 m
EFPV1	Radio prijemnik, u montažnu kutiju, 1 kanalni	230 V, 50 Hz, 1×5 A, 1 NO/NC, 868.32 MHz
EFPV2	Radio prijemnik, u montažnu kutiju, 2 kanalni	230 V, 50 Hz, 2×5 A, 2 NO, 868.32 MHz
EFPD	Dimer u montažnu kutiju, 1 kanalni	230 V, 50 Hz, 250 W, 868.32 MHz
EFPV2K	Radio prijemnik, u montažnu kutiju, 2 kanalni, za prekidač	230 V, 50 Hz, 2×5 A, 2 NO, 868.32 MHz
EFPV2DC	Radio prijemnik, u montažnu kutiju, 2 kanalni	10-14 VDC, 2×5 A, 2 NO, 868.32 MHz
EFPV3DC	Radio prijemnik, u montažnu kutiju, 3 kanalni	10-14 VDC, 3×2,5 A, 868.32 MHz
EFPC	LED kontroler, za montažnu kutiju, 1 kanalni	10-14 VDC, 2×5 A, 868.32 MHz
EFPRGB	LED kontroler, za montažnu kutiju, 1 kanalni	10-14 VDC, 250 W, 868.32 MHz
EFPRL	Upravljanje žaluzinama, za montažnu kutiju, lokalni	230 V, 50 Hz, 2×5 A, 2 NO, 868.32 MHz
EFPRC	Upravljanje žaluzinama, za montažnu kutiju, lokalni/centralni	230 V, 50 Hz, 2×5 A, 2 NO, 868.32 MHz
EFPM1	Modularni prijemnik radio signala, 1 kanalni	230 V, 50 Hz, 8 A, 1 NO/NC, 868.32 MHz
EFPM2	Modularni prijemnik radio signala, 2 kanalni	230 V, 50 Hz, 8 A, 2 NO/NC, 868.32 MHz
EFSV1	Bežični kontrolni komplet, 1 kanalni, zidni taster	230 V, 50 Hz, 5 A, 1 NO/1 NC, 868.32 MHz
EFSVD	Bežični dimer komplet, 1 kanalni	230 V, 50 Hz, 250 W, 868.32 MHz
EFSR	Komplet za bežično upravljanje žaluzina, 1 kanalni	230 V, 50 Hz, 2×5 A, 2 NO, 868.32 MHz
EFSV2	Bežični kontrolni komplet, 2 kanalni, zidni taster	230 V, 50 Hz, 2×5 A, 2 NO, 868.32 MHz
EFSU	Bežični univerzalni kontrolni komplet, sa priveskom za ključeve	230 V, 50 Hz, 5 A, 1 NO/1 NC, 868.32 MHz

CO..



SENZOR UGLJEN-MONOKSIDA (CO)

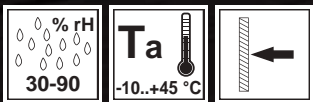

TRACON						
CO218A						40 × 110 mm
CO208A	>85 dB / 3 m	No signal	60 - 90 min	10 - 40 min	<3 min	125 × 85 × 40 mm
CO216LA						113 × 85 × 37 mm

EARC

SENZOR ZA DETEKCIJU PRAŽNENJA LUKA

- EARC detektor greške luka sa integrisanim strujnom zaštitnom sklopkom.
- Detalji porudžbine, pribor, električne šeme i dimenzije.



AFDD Senzor pražnjenja luka, MCB, RCD

230 V AC	AFDD RCCB MCB	35x7.5	[mm ²] 1-25	T _a -25...+55°C	U _i 500 V				I _{cn} EN 60898 6 kA	IP 20	A
-------------	---------------------	--------	----------------------------	-------------------------------	-------------------------	--	--	--	-------------------------------------	----------	---

TRACON	xP 	I _n (A)	I _{Δn} (mA)	
EARC2B603		6	30 mA	
EARC2B1003		10		
EARC2B1303		13		
EARC2B1603		16		
EARC2B2003		20		
EARC2B2503		25		
EARC2B3203		32		
EARC2B4003		40		
EARC2C603		6		
EARC2C1003		10		
EARC2C1303		13		
EARC2C1603		16		
EARC2C2003		20		
EARC2C2503		25		
EARC2C3203		32		
EARC2C4003		40		

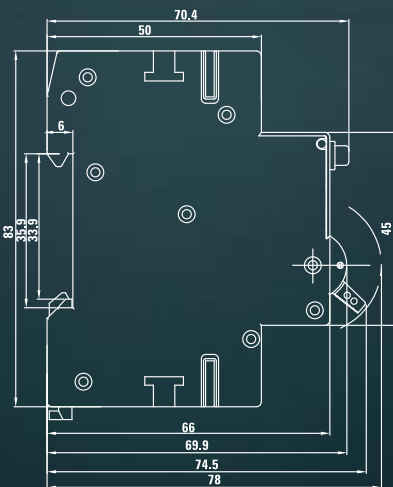

Dimenzije:

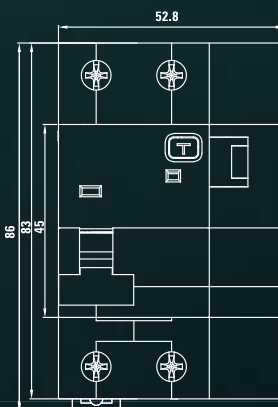

Dijagrami:

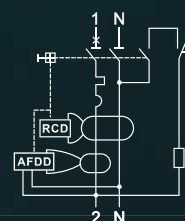



ACS2P63

AUTOMATSKA IZBORNA SKLOPKA

230 V AC	35x7.5	x26.000	x1.500	690 V	Ta -25...+55°C	[mm ²] 1-25	63A gG	U_{imp} 8 kV	IP 20
-----------------	--------	---------	--------	--------------	--------------------------	----------------------------	--------	--------------------------------	-----------------

TRACON	I_n (A)		
ACS2P63	63		



BELLW6-1V1

BELLW7-1V1

BELLW..

BEZIČNO ZVONO

Ta
-20...+45°C
 IP
44

TRACON			A ← L → B						
BELLW6-1V1	230 V AC	kinetikus	100 m	82 dB	18	✓	✓	1 kom	1 kom
BELLW7-1V1	230 V AC	kinetikus	100 m	82 dB	16	✓	✓	1 kom	1 kom



KVKGE..

KOMBINOVANI ZAŠTITNI PREKIDAČ (1 MODUL)

230 V AC	x20.000	x4.000	35x7.5	$[mm^2]$ 1-16	T_a -25...+55°C	U_i 690 V	I_{cn} EN 60898 6 kA	OFF	E3	40 A gG	IP 20
----------	---------	--------	--------	------------------	----------------------	----------------	------------------------------	-----	----	---------	-------

TRACON		I_n (A)	$I_{\Delta n}$ (mA)
B	C		
KVKGEB-6/100	KVKGE-6/100	6	100
KVKGEB-6/30	KVKGE-6/30	6	30
KVKGEB-10/100	KVKGE-10/100	10	100
KVKGEB-10/30	KVKGE-10/30	10	30
KVKGEB-13/100	KVKGE-13/100	13	100
KVKGEB-13/30	KVKGE-13/30	13	30
KVKGEB-16/100	KVKGE-16/100	16	100
KVKGEB-16/30	KVKGE-16/30	16	30
KVKGEB-20/100	KVKGE-20/100	20	100
KVKGEB-20/30	KVKGE-20/30	20	30
KVKGEB-25/100	KVKGE-25/100	25	100
KVKGEB-25/30	KVKGE-25/30	25	30
KVKGEB-32/100	KVKGE-32/100	32	100
KVKGEB-32/30	KVKGE-32/30	32	30

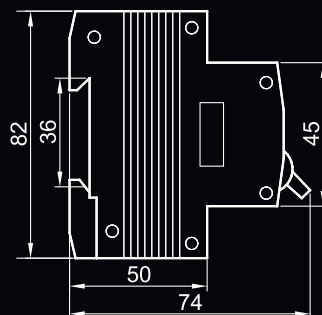
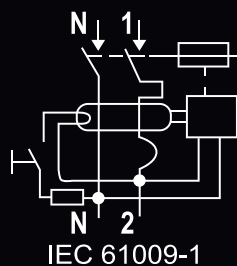

Za naizmenične i pulzirajuće jednosmerne mreže!

07.2026.

TRACON



E4KUSB



HE..

PRENOSNI RAZDELNICI, NORMALAN, BELA

TRACON				P_{max}	SCHUKO	
1,5 m	3 m	5 m				
	HE3	HE31	HE3-3M	HE3-5M	max. 3680 W	× 3
	HE4	HE41	HE4-3M	HE4-5M	max. 3680 W	× 4
	HE5	HE51	HE5-3M	HE5-5M	max. 3680 W	× 5
	HE6	HE61	HE6-3M	HE6-5M	max. 3680 W	× 6
	HEK3	HEK31	HEK3-3M	HEK3-5M	max. 3680 W	× 3
	HEK4	HEK41	HEK4-3M	HEK4-5M	max. 3680 W	× 4
	HEK5	HEK51	HEK5-3M	HEK5-5M	max. 3680 W	× 5
	HEK6	HEK61	HEK6-3M	HEK6-5M	max. 3680 W	× 6

HE3, HE4, HE5, HE6,
HEK3, HEK4, HEK5,
HEK6, E4KUSB

HE31, HE41, HE51,
HE61, HEK31,
HEK41, HEK51,
HEK61

HE3-3M, HE4-3M,
HE5-3M, HE6-3M,
HEK3-3M, HEK4-3M,
HEK5-3M, HEK6-3M

HE3-5M, HE4-5M,
HE5-5M, HE6-5M,
HEK3-5M, HEK4-5M,
HEK5-5M, HEK6-5M

TRACON				P_{max}	SCHUKO
1,5 m	USB Type A	USB Type C			
	E4KUSB	1× 5 VDC max. 2.4A	1× 5 VDC max. 3.4A	max. 3680 W	× 4



KDH..

PRODUŽNI KABL NA METALNOM BUBNJU

250 V AC I_n max. 16 A

TRACON			P_{max} 	P_{max} 	 SCHUKO	IP..	
KDH10	10 m	3 × 1,5 mm ² , (H05VV-F)	3200 W	1000 W	× 4	IP 20	
KDH15	15 m	3 × 1,5 mm ² , (H05VV-F)	3200 W	1000 W	× 4	IP 20	
KDH20		20 m	3 × 1,5 mm ² , (H05VV-F)	3200 W	1000 W	× 4	IP 20
KDH25		25 m	3 × 1,5 mm ² , (H05VV-F)	3200 W	1000 W	× 4	IP 20
KDH30		30 m	3 × 1,5 mm ² , (H05VV-F)	3200 W	1000 W	× 4	IP 20
KDH40		40 m	3 × 1,5 mm ² , (H05VV-F)	3200 W	1000 W	× 4	IP 20
KDH50		50 m	3 × 1,5 mm ² , (H05VV-F)	3200 W	1000 W	× 4	IP 20
KDH10IP	10 m	3 × 1,5 mm ² , (H07RN-F)	3200 W	1100 W	× 4	IP 44	
KDH20IP	20 m	3 × 1,5 mm ² , (H07RN-F)	3200 W	1100 W	× 4	IP 44	
KDH25IP		25 m	3 × 1,5 mm ² , (H07RN-F)	3200 W	1100 W	× 4	IP 44
KDH30IP		30 m	3 × 1,5 mm ² , (H07RN-F)	3200 W	1100 W	× 4	IP 44
KDHM20IP		20 m	3 × 1,5 mm ² , (H07RN-F)	3200 W	1100 W	× 4	IP 44
KDHM25IP		25 m	3 × 2,5 mm ² , (H07RN-F)	3200 W	1100 W	× 4	IP 44
KDHM40IP		40 m	3 × 1,5 mm ² , (H07RN-F)	3200 W	1100 W	× 4	IP 44



07.2026.

TRACON

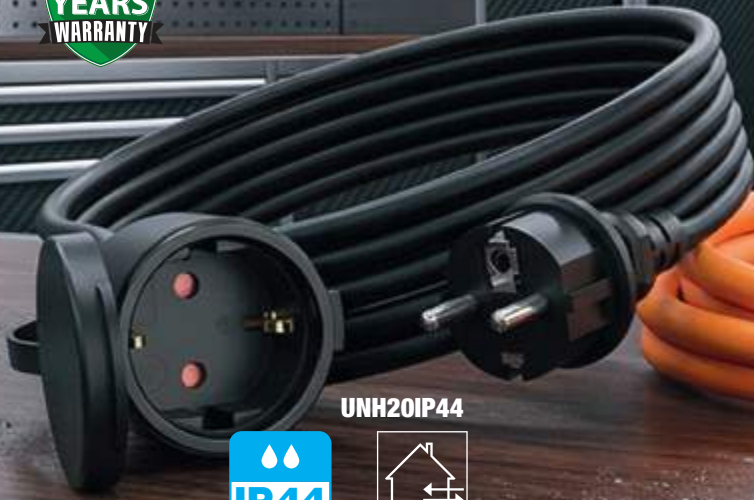

UNH20IP44



UNH...



UNH.. UNIVERZALNI PRODUŽNI KABL

250
V AC

In
max.
16 A



TRACON			P_{max} 	P_{max} 	 SCHUKO
UNH10	10 m	H05VV-F	3200 W	1000 W	× 1
UNH15	15 m	H05VV-F	3200 W	1000 W	× 1
UNH20	20 m	H05VV-F	3200 W	1000 W	× 1
UNH25	25 m	H05VV-F	3200 W	1000 W	× 1
UNH30	30 m	H05VV-F	3200 W	1000 W	× 1
UNH20IP44	20 m	H07VV-F	3200 W	1100 W	× 1



HARMONY
BY TRACON

TRACON



TNSM1,
TNSM1-FR



TNSM2,
TNSM2-FR



HSM4-2A1C-2M,
HSM4-2A1C-2M-FR

PAMETNE UTIČNICE

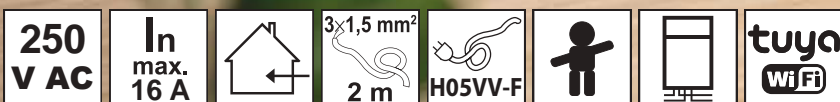

TRACON	$I_{max} > I_n$	SCHUKO	FRENCH	USB-A	USB-C		P_{max}	L (m)
TNSM1	✓	1	–	–	–	1x	3680 W	–
TNSM1-FR	✓	–	1	–	–	1x	3680 W	–
TNSM2	✓	2	–	–	–	1x	3680 W	–
TNSM2-FR	✓	–	2	–	–	1x	3680 W	–
HSM4-2A1C-2M	✓	4	–	2	1	1x	3680 W	2
HSM4-2A1C-2M-FR	✓	–	4	2	1	1x	3680 W	2

Pametni adapteri za utičnice za udoban i energetski efikasan dom

Utičnice u razdelnicima mogu se uključivati ručno zajedno ili pojedinačno iz aplikacije. Razdelnik takođe ima 2 USB-A i 1 USB-C porta, koji se takođe mogu uključivati iz aplikacije. Adapteri se mogu uključivati ručno ili iz aplikacije, a njihova potrošnja se takođe može meriti iz aplikacije. Svi proizvodi imaju bravu za decu za zaštitu mališana. Svi tipovi su dostupni u (Schuko) i pin (French) verzijama sa zaštitnim kontaktom.

TRACON

TND..

VIŠEKANALNI PRIKLJUČAK - PRETVARAČ

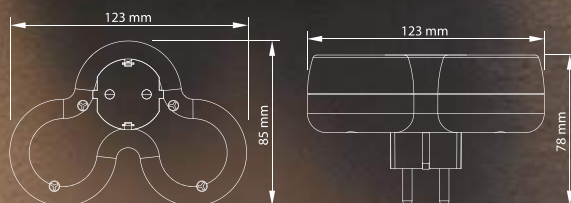

TRACON	P_{max}				
TND2-USBAC	max. 3680W	SCHUKO	USB A+C	out: USB-C 20W	out: USB-A, 18W
		× 2	1 + 1	5V 3A, 9V 2,22A, 12V 1,67A	5V 3A, 9V 2A, 12V 1.5A

PRIKLJUČNICA SA ADAPTER SKLOPKOM

KACS3

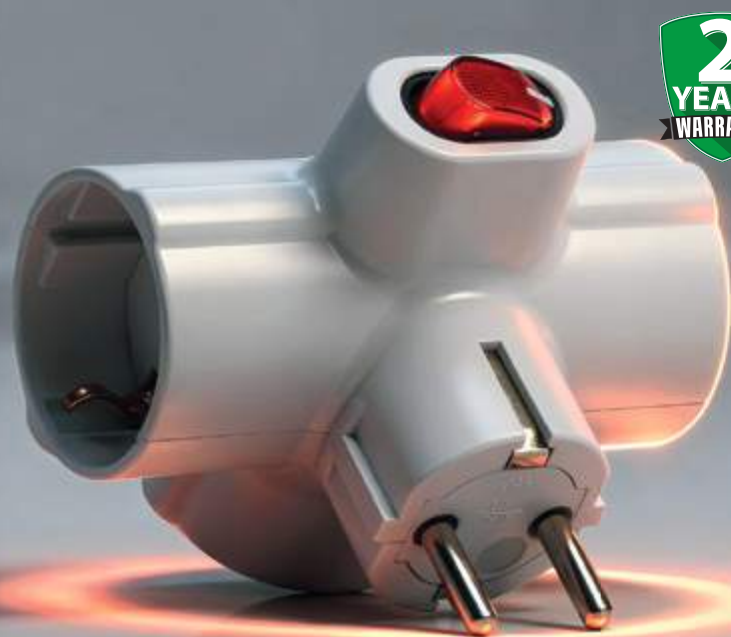

TRACON		P_{max}
KACS3	SCHUKO	
	× 3	max. 3680 W





UGRAĐENA UGAONA INDUSTRIJSKA UTIČNICA,

IP67 ZAŠTITA

- **IP67 zaštita**
zaštićeno od prašine i vode, idealno za spoljašnju upotrebu
- **Kosi, ugradni dizajn**
lakše i praktičnije povezivanje
- **Standardno industrijsko rešenje**
prema IEC 60309-2
- **Širok opseg**
16A / 32A, 230V / 400V, višestruki raspored polova
- **Kodiranje bojama,**
pozicionirana na 6 sati, brza i jasna identifikacija

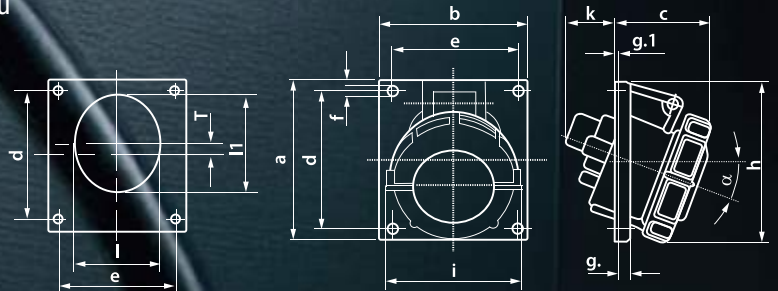

TRACON	I _n	U _n		a (mm)	b (mm)	c (mm)	d (mm)	e (mm)
TICS-313IP67	16 A	250 V	2P + ⊕	97	80	55	73	60
TICS-314IP67	16 A	400 V	3P + ⊕	97	80	57	73	60
TICS-315IP67	16 A	400 V	3P + N + ⊕	97	80	62	73	60
TICS-323IP67	32 A	250 V	2P + ⊕	100	92	64	85	80
TICS-324IP67	32 A	400 V	3P + ⊕	100	92	64	85	80
TICS-325IP67	32 A	400 V	3P + N + ⊕	100	92	65	85	80



EDFKIP65U..



EDFKIP65N..

EDFKIP

ZAŠTIĆENE RAZDELNE KUTIJE



TRACON	x17.5	H (mm)	W (mm)	D (mm)
	4	210,3	142,8	99,5
	8	209	215	98
	12	259	298	140
	24	420	323,5	139,5
	36	595,3	299,75	147
	18	286,3	411	137,8
	54	595,3	414,25	148
	5	159	118,5	88,6
	8	154,5	200,5	88,9
	12	197,5	255	106
	24	356,16	275,51	106,2
	15	197,5	310	106
	18	197,5	364	106

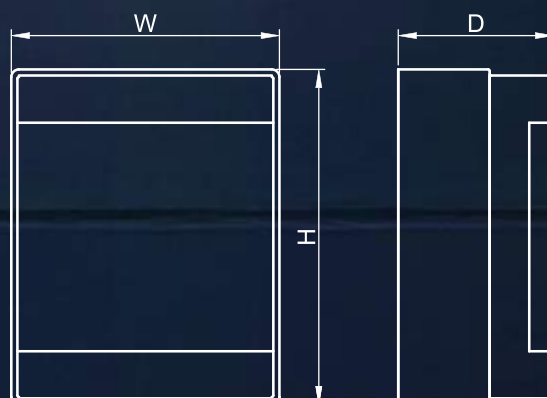

TECS..

STALAK ZA PUNJAČ E-AUTOMOBILE



TECS303S



TECS303T

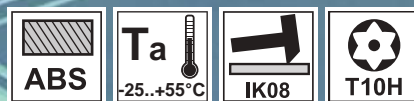
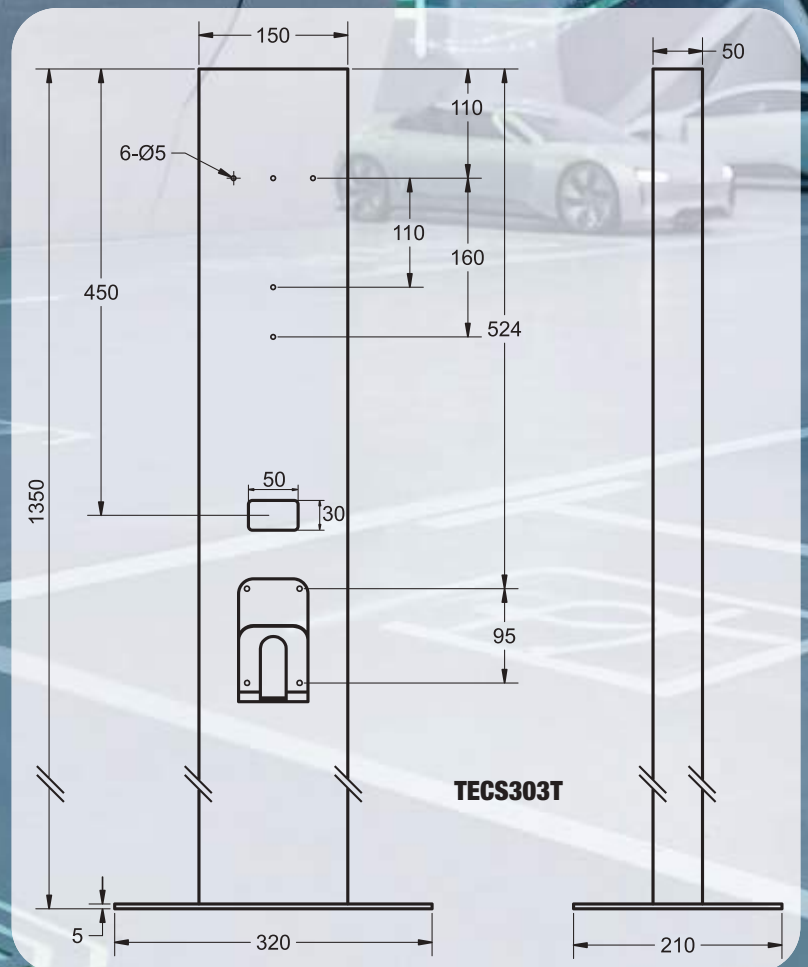

TRACON	H x W x D (mm)	
TECS303T	320 x 210 x 1350	



TRACON	In	Un		IP..	H x W x L (mm)
TECS303S	32 A	400 V	3x32A/400V	IP65	335 x 245 x 140



AKMN

KOMPAKTNI PREKIDAČ



TRACON	I_e	I_r	I_{cu} (kA _{eff}) AC 400 V	I_{cs} (kA _{eff}) AC 400 V	ON-OFF-ON... sc/h I_{max}		 I_{max}	
AKMN1-160	160 A	(128-160) A	36	25	120	7000	1000	1,8 kg
AKMN2-250	250 A	(200-250) A	36	25	120	7000	1000	2,5 kg
AKMN3-400	400 A	(320-400) A	50	35	60	4000	1000	6 kg
AKMN4-630	630 A	(504-630) A	50	35	60	4000	1000	6,67 kg



PORODICA OSIGURAČA RASTAVNIH PREKIDAČA

CFB...



Cilindrični osigurači za osigurač rastavljača

- Za normalne sisteme, za osigurače AC690V, 10x38, 14x51 i 22x58
- Za solarne sisteme, za osigurače DC 1000V, 10x38
- Za solarne sisteme, za osigurače DC 1500V, 10x85

DSH...



Horizontalni rastavni osigurači

- Mogućnost montiranja na montažnu ploču
- Za sisteme sa međusobnim rastojanjem šine 60 mm
- Razni dodaci (prizma kopča, poklopac terminala, indikator položaja mikro prekidača)

DSV...



Vertikalni rastavni osigurači

- Za sisteme sa međusobnim rastojanjem šine 185 mm
- Izvedba sa rastavljanje po polovima
- Izvedba sa rastavljanje 3 pola zajedno
- Razni dodaci (terminal sabirnice, mikro prekidač indikatora položaja)



MED...



PLASTIČNA KUTIJA ELEKTRONIKE



TRACON		W (mm)	L (mm)	H (mm)	IP..	
MED884	-25..+60°C	80	80	40	IP44	
MED8125		80	120	50	IP67	
MED10105	-25..+60°C	100	100	50	IP67	
MED15117		150	110	70	IP67	
MED15117S*		150	110	70	IP54	
MED15157		150	150	70	IP67	
MED15157T		150	150	70	IP67	
MED23128		230	125	80	IP54	
MED35128		350	125	80	IP54	
MED403013		400	300	130	IP67	
MED46128		460	125	80	IP54	
MED403013T		400	300	130	IP67	
MED12085*		120	80	50	IP54	
MED383012		380	300	120	IP54	
MED19148		190	145	80	IP67	
MED19148T		190	145	80	IP67	
MED25209	-25..+60°C	250	200	90	IP67	
MED25209T		250	200	90	IP67	
MED312313		310	230	130	IP67	
MED312313T		310	230	130	IP67	

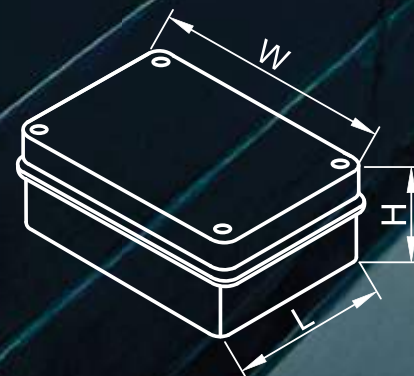







* bez označenih otvora



DCMSPV45

RASTAVNA SKLOPKA ZA NIZANJE
ZA PV SISTEME



 1500 V DC	 35x7.5	 OFF	 [mm ²] 0,5-16	 In max. 45 A	 Ta -40..+85°C	 IP 20
---	---	--	---	---	---	---





SC6

KOMPLET ZA ČIŠĆENJE SOLARNIH PANELA

TRACON

L
(mm)

SC6

161 - 600 cm



STALNA KONTROLA KVALITETA SISTEMA



**Naš aktuelni sertifikat
možete preuzeti na našoj
web stranici!**

TRACON EVROPA

Tracon Budapest Kft.

H-2120 Dunakeszi,
Pallag u. 23.

Tracon Slovakia, s.r.o.

SK-94501 Komárno,
Rozmarínová 10.

Tracon Electric s.r.l.

RO-310304 Arad,
Str. Aurel Crisan, nr. 1-3

Tracon d.o.o. Varaždin

HR-42000, Varaždin,
Ivana Severa 15.

TRACON Electric d.o.o.

SLO-9220 Lendava,
Industrijska 6

Tracon Electric s.r.o.

CZ-286 01 Čáslav,
Pražská 816/1

Tracon d.o.o. Bačka Topola

SRB-24300 Bačka Topola,
Moravska 26

Tracon Polska Sp. z o.o.

PL- 43-300 Bielsko-Biała
ul. Cieszyńska 43

**Distributor von der
Schweiz – EBK Design**

CH-8113 Boppelsen,
Ruggernstr.11

TRACON Austria GmbH

A-1170 Geblergasse 93, Wien
Tel.:+43 1 5441666

Distributor Kosovo

START 4Q GROUP SH.P.K.
GRACANICA - JUNIK, P.N.
LIVAGJE

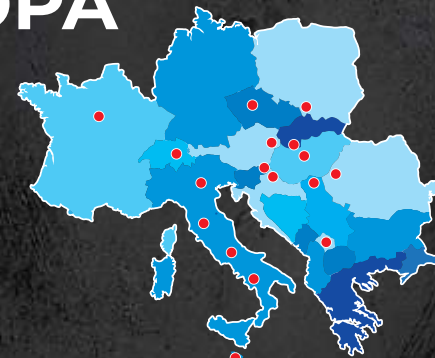
**Distributor Montenegro**

- RAVEL DOO
CG – 81000, Podgorica,
8. Jula br. 16

Distributor Malta –

VCT Ltd.
MST 4032, Mosta,
Ponsonby Street

RADNO VREME:

Ponedjeljak-Petak:

od 7.30 do 15.30 sati

Prodajna služba:

Tel./fax: 024-712-503

E-mail:

tracon@tracon.co.rs

Adresa:

24300 Bačka Topola,
Moravska 26