

CATALOGUE

01 壁式带灯
Wall
Mounted
LED
Mirror 03-14

02 台式带灯
Desktop
LED
Mirror 15-20

03 壁式无灯
Wall
Mounted
Cosmetic
Mirror 19-34
21-36

04 台式无灯
Desktop
Cosmetic
Mirror 37-47





AVAILABLE PLUGS 各国插头



European
欧洲



Australian
澳大利亚



British
英国



Brazil
巴西



American
美国



Italian
意大利



South African
南非

B 青古铜
Bronze



A 镀金
Gold

THE PRODUCT

CHROMATOGRAPHY. 产品色谱
注：该页代表所有产品颜色



C 仿古
Antique copper



D 黑古铜
ORB



E 拉丝银
Brushed nickel



F 红古铜
Red Copper



G 玫瑰金
Rose gold



H 镀铬
Chrome

HSY-1001

镜面尺寸 Mirror Size	Ø200 L445xH330mm	毛重(箱) GW(CTN)	14KGS
镜面厚度 Mirror Thickness	20mm	装箱数 Quantity	10SETS
净重(只) NW(SETS)	1KGS	泡沫包装 Foam Packing	410x385X650mm

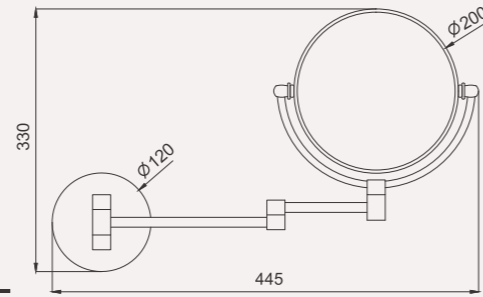

壁式带灯美容镜

WALL MOUNTED LED MIRROR

The clean design characterized by high personality and carefully planned details reflects the productive philosophy of a company always able to interpret and comply with current life style.

HSY-1002

镜面尺寸 Mirror Size	Ø200 L445xH330mm	毛重(箱) GW(CTN)	14KGS
镜面厚度 Mirror Thickness	20mm	装箱数 Quantity	10SETS
净重(只) NW(SETS)	1KGS	泡沫包装 Foam Packing	410x385X650mm

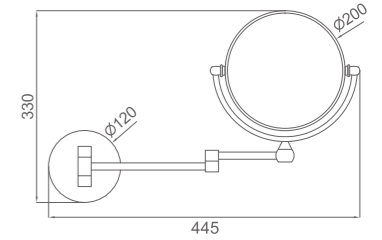

HSY-1003

镜面尺寸 Mirror Size	Ø200 L420xH325mm	毛重(箱) GW(CTN)	14KGS
镜面厚度 Mirror Thickness	20mm	装箱数 Quantity	10SETS
净重(只) NW(SETS)	1KGS	泡沫包装 Foam Packing	410x385X650mm

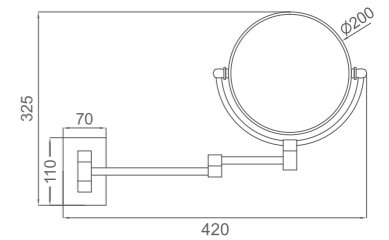

HSY-1004

镜面尺寸 Mirror Size	Ø215 L470xH387mm	毛重(箱) GW(CTN)	19KGS
镜面厚度 Mirror Thickness	55mm	装箱数 Quantity	10SETS
净重(只) NW(SETS)	1.5KGS	泡沫包装 Foam Packing	475x420X630mm

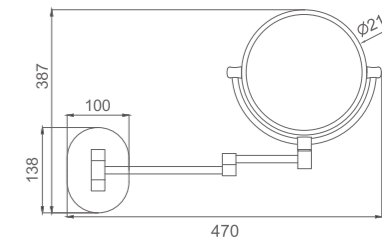

HSY-1005

镜面尺寸 Mirror Size	Ø215 L470xH340mm	毛重(箱) GW(CTN)	19KGS
镜面厚度 Mirror Thickness	55mm	装箱数 Quantity	10SETS
净重(只) NW(SETS)	1.5KGS	泡沫包装 Foam Packing	475x420X630mm

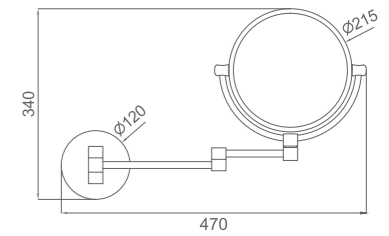



注:
本页产品三款后盖(台阶, 扁平, 圆弧)
Remark:
Frame back options (Normal , Flat , Arc)

HSY-1006



镜面尺寸 Mirror Size	Ø215 L445xH215mm
镜面厚度 Mirror Thickness	23mm
净重(只) NW(SETS)	1.15KGS
毛重(箱) GW(CTN)	15.5KGS
装箱数 Quantity	10SETS
泡沫包装 Foam Packing	720x300X590mm

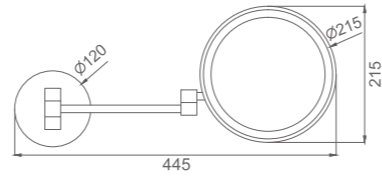

HSY-1010



镜面尺寸 Mirror Size	Ø215 L445xH215mm
镜面厚度 Mirror Thickness	23mm
净重(只) NW(SETS)	1.42KGS
毛重(箱) GW(CTN)	18.2KGS
装箱数 Quantity	10SETS
泡沫包装 Foam Packing	720x300X590mm

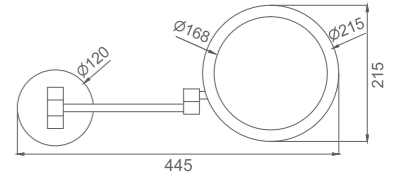

HSY-1007

TOUCH SENSER SWITCH 镜面触摸
IN MIRROR SHEET 开关



镜面尺寸 Mirror Size	Ø215 L445xH215mm
镜面厚度 Mirror Thickness	23mm
净重(只) NW(SETS)	1.15KGS
毛重(箱) GW(CTN)	15.5KGS
装箱数 Quantity	10SETS
泡沫包装 Foam Packing	720x300X590mm

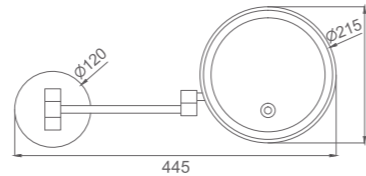

HSY-1011



镜面尺寸 Mirror Size	Ø250 L462xH250mm
镜面厚度 Mirror Thickness	23mm
净重(只) NW(SETS)	1.73KGS
毛重(箱) GW(CTN)	21.3KGS
装箱数 Quantity	10SETS
泡沫包装 Foam Packing	720x300X590mm

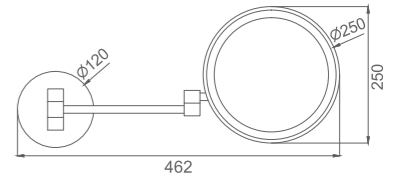

HSY-1008

TOUCH SENSER SWITCH 触摸开关



镜面尺寸 Mirror Size	Ø215 L445xH215mm
镜面厚度 Mirror Thickness	23mm
净重(只) NW(SETS)	1.15KGS
毛重(箱) GW(CTN)	15.5KGS
装箱数 Quantity	10SETS
泡沫包装 Foam Packing	720x300X590mm

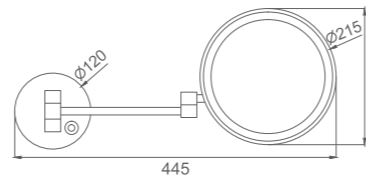

HSY-1012



镜面尺寸 Mirror Size	Ø250 L462xH250mm
镜面厚度 Mirror Thickness	23mm
净重(只) NW(SETS)	1.73KGS
毛重(箱) GW(CTN)	21.3KGS
装箱数 Quantity	10SETS
泡沫包装 Foam Packing	720x300X590mm

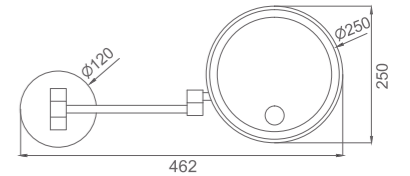

HSY-1009



镜面尺寸 Mirror Size	Ø215 L420xH215mm
镜面厚度 Mirror Thickness	23mm
净重(只) NW(SETS)	1.15KGS
毛重(箱) GW(CTN)	15.5KGS
装箱数 Quantity	10SETS
泡沫包装 Foam Packing	720x300X590mm

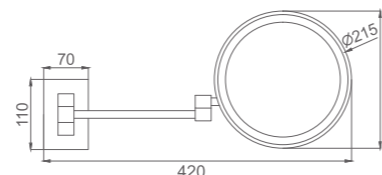

HSY-1013



镜面尺寸 Mirror Size	Ø215 L350xH325mm
镜面厚度 Mirror Thickness	55mm
净重(只) NW(SETS)	1.4KGS
毛重(箱) GW(CTN)	18KGS
装箱数 Quantity	10SETS
泡沫包装 Foam Packing	830x420X590mm

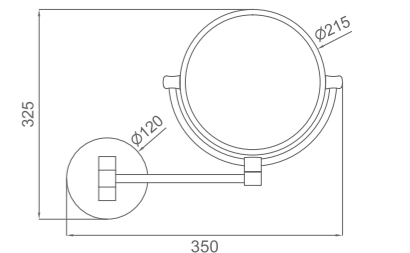

HSY-1014



镜面尺寸 Mirror Size L215xW215mm
L435xH215mm
镜面厚度 Mirror Thickness 23mm
净重(只) NW(SETS) 1.64KGS
毛重(箱) GW(CTN) 20.4KGS
装箱数 Quantity 10SETS
泡沫包装 Foam Packing 720x300X590mm

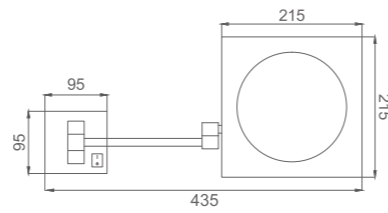

HSY-1018



镜面尺寸 Mirror Size L215xW215mm
L420xH215mm
镜面厚度 Mirror Thickness 23mm
净重(只) NW(SETS) 1.5KGS
毛重(箱) GW(CTN) 19KGS
装箱数 Quantity 10SETS
泡沫包装 Foam Packing 720x300X590mm

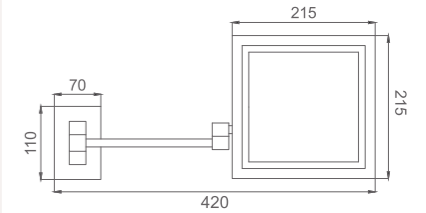

HSY-1015



镜面尺寸 Mirror Size L215xW215mm
L435xH215mm
镜面厚度 Mirror Thickness 23mm
净重(只) NW(SETS) 1.64KGS
毛重(箱) GW(CTN) 20.4KGS
装箱数 Quantity 10SETS
泡沫包装 Foam Packing 720x300X590mm

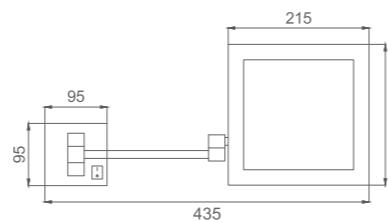

HSY-1019



镜面尺寸 Mirror Size L215xW215mm
L448xH215mm
镜面厚度 Mirror Thickness 23mm
净重(只) NW(SETS) 1.5KGS
毛重(箱) GW(CTN) 19KGS
装箱数 Quantity 10SETS
泡沫包装 Foam Packing 720x300X590mm

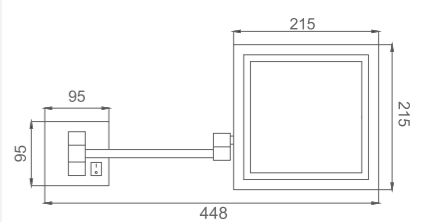

HSY-1016



镜面尺寸 Mirror Size L215xW215mm
L435xH230mm
镜面厚度 Mirror Thickness 10mm
净重(只) NW(SETS) 1KGS
毛重(箱) GW(CTN) 14KGS
装箱数 Quantity 10SETS
泡沫包装 Foam Packing 720x300X590mm

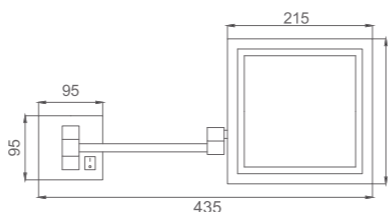

HSY-1020



镜面尺寸 Mirror Size L215xW215mm
L420xH215mm
镜面厚度 Mirror Thickness 23mm
净重(只) NW(SETS) 1.5KGS
毛重(箱) GW(CTN) 19KGS
装箱数 Quantity 10SETS
泡沫包装 Foam Packing 720x300X590mm

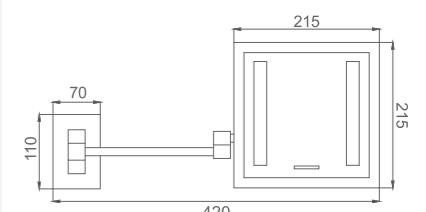

HSY-1017



镜面尺寸 Mirror Size L200xW200mm
L438xH200mm
镜面厚度 Mirror Thickness 23mm
净重(只) NW(SETS) 1.5KGS
毛重(箱) GW(CTN) 19KGS
装箱数 Quantity 10SETS
泡沫包装 Foam Packing 720x300X590mm

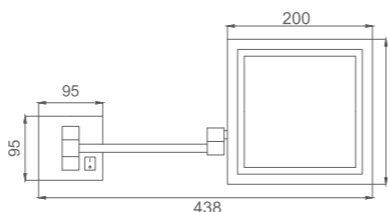

HSY-1021



镜面尺寸 Mirror Size L215xW215mm
L420xH215mm
镜面厚度 Mirror Thickness 23mm
净重(只) NW(SETS) 1.5KGS
毛重(箱) GW(CTN) 19KGS
装箱数 Quantity 10SETS
泡沫包装 Foam Packing 720x300X590mm

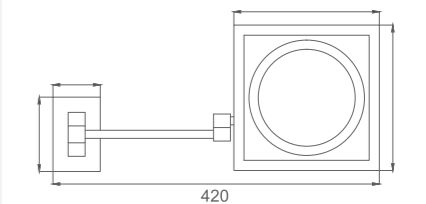

HSY-1022



镜面尺寸
Mirror Size L215xW215mm
L339xH475mm
镜面厚度
Mirror Thickness 23mm
净重(只)
NW(SETS) 2KGS
毛重(箱)
GW(CTN) 18KGS
装箱数
Quantity 6SETS
泡沫包装
Foam Packing 500x500X520mm

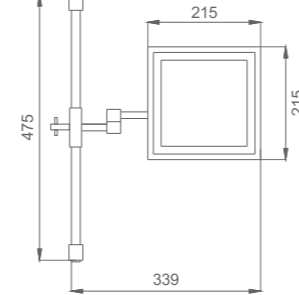

HSY-1026



镜面尺寸
Mirror Size L200xW200mm
L438xH200mm
镜面厚度
Mirror Thickness 2mm
净重(只)
NW(SETS) 1.15KGS
毛重(箱)
GW(CTN) 15.5KGS
装箱数
Quantity 10SETS
泡沫包装
Foam Packing 720x300X590mm

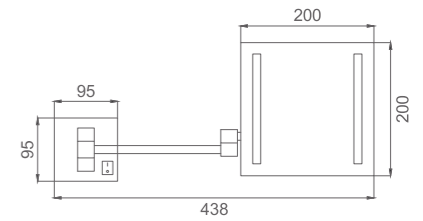

HSY-1023



镜面尺寸
Mirror Size $\varnothing 200$
L348xH400mm
镜面厚度
Mirror Thickness 23mm
净重(只)
NW(SETS) 1.62KGS
毛重(箱)
GW(CTN) 14.7KGS
装箱数
Quantity 6SETS
泡沫包装
Foam Packing 500x500X520mm

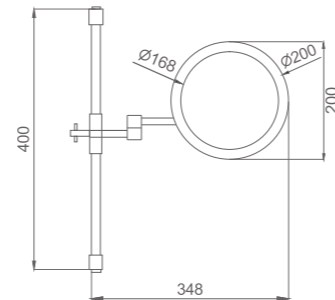

HSY-1027



镜面尺寸
Mirror Size $\varnothing 230$
L455xH230mm
镜面厚度
Mirror Thickness 2mm
净重(只)
NW(SETS) 1.15KGS
毛重(箱)
GW(CTN) 15.5KGS
装箱数
Quantity 10SETS
泡沫包装
Foam Packing 720x300X590mm

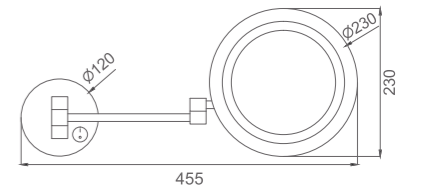

HSY-1024



镜面尺寸
Mirror Size $\varnothing 200$
L348xH400mm
镜面厚度
Mirror Thickness 23mm
净重(只)
NW(SETS) 1.89KGS
毛重(箱)
GW(CTN) 16.3KGS
装箱数
Quantity 6SETS
泡沫包装
Foam Packing 500x500X520mm

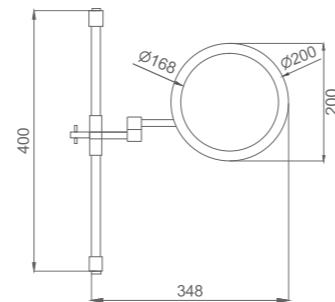

HSY-1028



镜面尺寸
Mirror Size L220xW160mm
L413xH220mm
镜面厚度
Mirror Thickness 2mm
净重(只)
NW(SETS) 1KGS
毛重(箱)
GW(CTN) 14KGS
装箱数
Quantity 10SETS
泡沫包装
Foam Packing 720x300X590mm

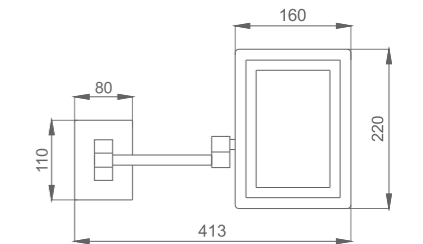

HSY-1025



镜面尺寸
Mirror Size L200xW200mm
L420xH325mm
镜面厚度
Mirror Thickness 20mm
净重(只)
NW(SETS) 1.16KGS
毛重(箱)
GW(CTN) 15.6KGS
装箱数
Quantity 10SETS
珍珠棉包装
EPE Packing 475x420X630mm

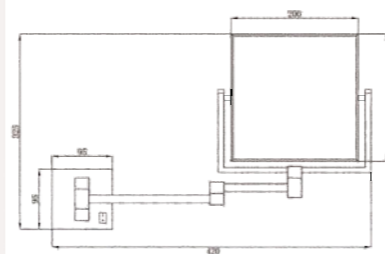

HSY-1029



镜面尺寸
Mirror Size $\varnothing 230$
L465xH230mm
镜面厚度
Mirror Thickness 5mm
净重(只)
NW(SETS) 1.1KGS
毛重(箱)
GW(CTN) 15KGS
装箱数
Quantity 10SETS
泡沫包装
Foam Packing 720x300X590mm

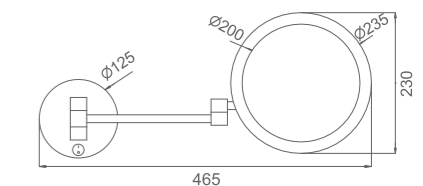

HSY-1030



镜面尺寸 Mirror Size	Ø215 L450xH215mm
镜面厚度 Mirror Thickness	5mm
净重(只) NW(SETS)	1.1KGS
毛重(箱) GW(CTN)	15KGS
装箱数 Quantity	10SETS
泡沫包装 Foam Packing	720x300X590mm

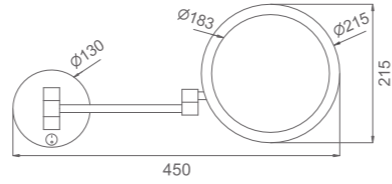

HSY-1034



镜面尺寸 Mirror Size	Ø230 L400xH230mm
镜面厚度 Mirror Thickness	2mm
净重(只) NW(SETS)	1.25KGS
毛重(箱) GW(CTN)	14.5KGS
装箱数 Quantity	10SETS
泡沫包装 Foam Packing	720x300X590mm

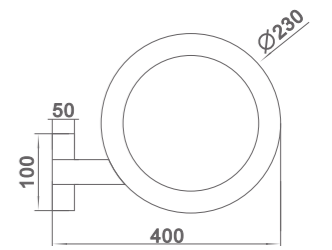

HSY-1031



镜面尺寸 Mirror Size	Ø200 L445xH330mm
镜面厚度 Mirror Thickness	18mm
净重(只) NW(SETS)	1KGS
毛重(箱) GW(CTN)	14KGS
装箱数 Quantity	10SETS
泡沫包装 Foam Packing	410x390X650mm

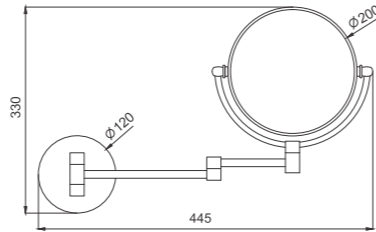

HSY-1035

PROXIMITY SENSOR 距离感应
AUTO OFF 延时关闭



镜面尺寸 Mirror Size	Ø230 L450xH230mm
镜面厚度 Mirror Thickness	2mm
净重(只) NW(SETS)	1.15KGS
毛重(箱) GW(CTN)	15.5KGS
装箱数 Quantity	10SETS
泡沫包装 Foam Packing	720x300X590mm

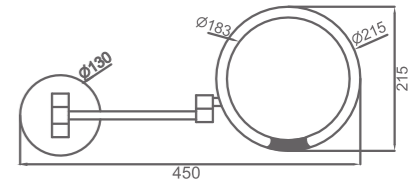

HSY-1032



镜面尺寸 Mirror Size	Ø200 L425xH293mm
镜面厚度 Mirror Thickness	10mm
净重(只) NW(SETS)	0.86KGS
毛重(箱) GW(CTN)	11.74KGS
装箱数 Quantity	10SETS
珍珠棉包装 EPE Packing	380x370X620mm

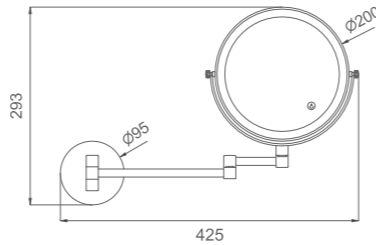

HSY-1036



镜面尺寸 Mirror Size	L220xW160mm L330xH220mm
镜面厚度 Mirror Thickness	2mm
净重(只) NW(SETS)	1KGS
毛重(箱) GW(CTN)	14KGS
装箱数 Quantity	10SETS
泡沫包装 Foam Packing	720x300X590mm

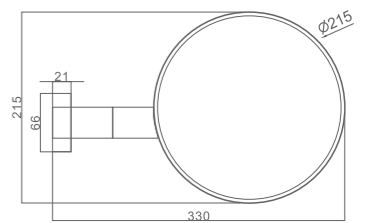

HSY-1033



镜面尺寸 Mirror Size	Ø230 L400xH315mm
镜面厚度 Mirror Thickness	10mm
净重(只) NW(SETS)	0.86KGS
毛重(箱) GW(CTN)	11.74KGS
装箱数 Quantity	10SETS
泡沫包装 Foam Packing	380x370X620mm

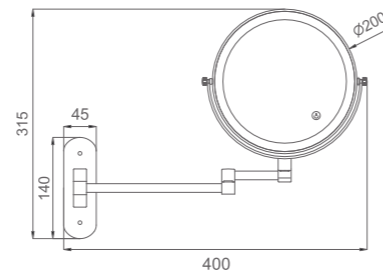

HSY-1037



镜面尺寸 Mirror Size	Ø230 L400xH230mm
镜面厚度 Mirror Thickness	5mm
净重(只) NW(SETS)	1.1KGS
毛重(箱) GW(CTN)	15KGS
装箱数 Quantity	10SETS
泡沫包装 Foam Packing	720x300X590mm

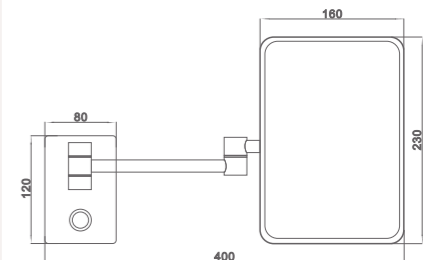



材料：铜，不锈钢
颜色：铬，鍍金，青古铜，仿古，ORB，拉丝镍，红古铜，玫瑰金，枪黑，喷漆
倍数：一面正常，另一面放大2/3/5/7/10倍
镜面尺寸：8/8.5英寸
高度：350-380mm
灯光颜色：LED 白色6000K，黄色3000K，双色，黄色普通灯泡
供电方式：LED 110-240V 插头，4只AA电池，充电电池
 普通灯泡 110-240V 插头
开关：船型开关，旋转开关，金属触摸开关，镜面触摸，调光开关，拉线开关
插头：欧式插头，英式插头，美式插头，澳规插头，巴西插头，意大利插头
功能：化妆美容，刮胡须，礼品赠品
适应范围：酒店，家具，展柜，卫浴建材，浴室，卧室，美容院
认证说明：CE，RoHS，RCM 等等

Material : Brass , Stainless steel
Color : Chrome ,Gold ,Bronze ,Antique Copper ,ORB ,Nickel ,Red Bronze ,Rose Gold ,Black
Magnification : 1x & 2x/3x/5x/7x/10x
Mirror frame : 8/8.5inch
Handle length : 350-380mm
Light Color : LED White6000K , Yellow3000K , Double color , Bulb
Power supply : LED 110-240v Plug , 4Pcs AABattery operated , Recharged Battery
 Bulb 110-240v Plug
Switch : Boat switch , Stick-rotary switch , Touch-sensor switch ,
 Dimmer switch ,Pull String ect
Plug : EU , BS , US , AU , BRA , SA , IT Plugs ect
Function : Cosmetic , Shaving , Gift ect
Range : Hospility , Furniture , Bathroom , Bedroom ect
Certificate : CE , RoHS , RCM ect



Desktop LED Mirror

台式带灯

清晰的设计极具个性，
 精心设计的细节反映出公司
 的制造理念，即始终注重对
 当今生活的诠释和贴近。

The clean design characterized
 by high personality and carefully
 planned details reflects the
 productive philosophy of a company
 always able to interpret and comply
 with current life style.

Contracted.

HSY-2001



镜面尺寸 Mirror Size	Ø200 H355xW230mm
镜面厚度 Mirror Thickness	20mm
净重(只) NW(SETS)	0.8KGS
毛重(箱) GW(CTN)	13.6KGS
装箱数 Quantity	10SETS
珍珠棉包装 EPE Packing	830x420X590mm

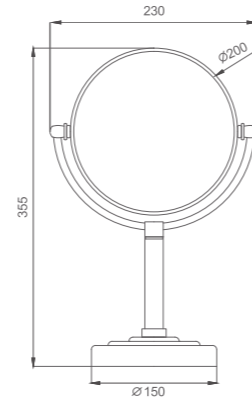

HSY-2002



镜面尺寸 Mirror Size	Ø200 H355xW230mm
镜面厚度 Mirror Thickness	20mm
净重(只) NW(SETS)	0.8KGS
毛重(箱) GW(CTN)	13.6KGS
装箱数 Quantity	10SETS
珍珠棉包装 EPE Packing	830x420X590mm

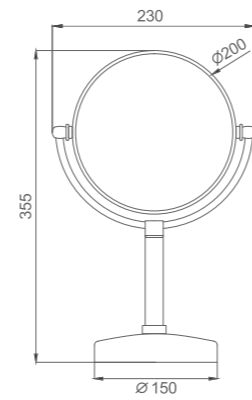

HSY-2003

TOUCH SENSER SWITCH 触摸开关



镜面尺寸 Mirror Size	Ø200 H355xW230mm
镜面厚度 Mirror Thickness	20mm
净重(只) NW(SETS)	0.8KGS
毛重(箱) GW(CTN)	13.6KGS
装箱数 Quantity	10SETS
珍珠棉包装 EPE Packing	830x420X590mm

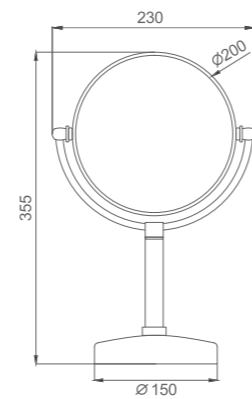

HSY-2004



镜面尺寸 Mirror Size	Ø200 H355xW230mm
镜面厚度 Mirror Thickness	20mm
净重(只) NW(SETS)	0.7KGS
毛重(箱) GW(CTN)	12.6KGS
装箱数 Quantity	10SETS
珍珠棉包装 EPE Packing	830x420X590mm

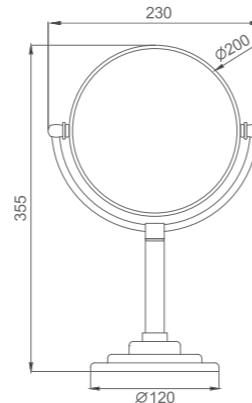

HSY-2005



镜面尺寸 Mirror Size	Ø215 H380xW245mm
镜面厚度 Mirror Thickness	55mm
净重(只) NW(SETS)	1.6KGS
毛重(箱) GW(CTN)	21.6KGS
装箱数 Quantity	10SETS
泡沫包装 Foam Packing	935x435X645mm

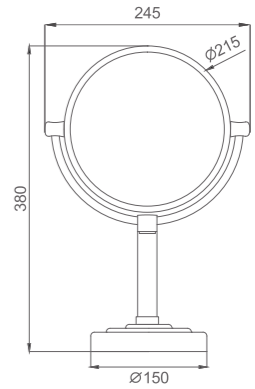

HSY-2006



镜面尺寸 Mirror Size	Ø200 H335xW200mm
镜面厚度 Mirror Thickness	23mm
净重(只) NW(SETS)	1.45KGS
毛重(箱) GW(CTN)	20.1KGS
装箱数 Quantity	10SETS
泡沫包装 Foam Packing	935x435X645mm

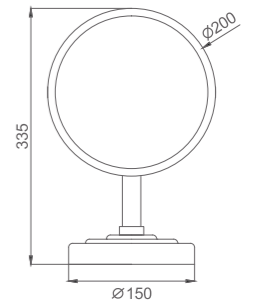

HSY-2007



镜面尺寸 Mirror Size	Ø200 H335xW200mm
镜面厚度 Mirror Thickness	23mm
净重(只) NW(SETS)	1.45KGS
毛重(箱) GW(CTN)	20.1KGS
装箱数 Quantity	10SETS
泡沫包装 Foam Packing	935x435X645mm

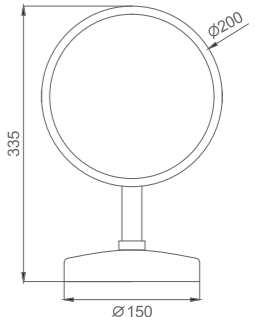

HSY-2008



镜面尺寸 Mirror Size	Ø200 H350xW200mm
镜面厚度 Mirror Thickness	23mm
净重(只) NW(SETS)	1.45KGS
毛重(箱) GW(CTN)	20.1KGS
装箱数 Quantity	10SETS
泡沫包装 Foam Packing	935x435X645mm

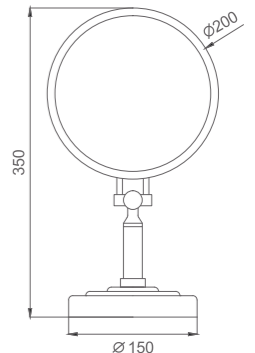

HSY-2009

ACRYLIC 亚克力



镜面尺寸 Mirror Size	∅215 H368xW215mm
镜面厚度 Mirror Thickness	23mm
净重(只) NW(SETS)	1.7KGS
毛重(箱) GW(CTN)	22.6KGS
装箱数 Quantity	10SETS
泡沫包装 Foam Packing	935x435X645mm

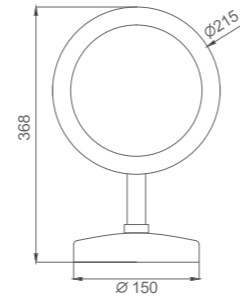

HSY-2010

ACRYLIC 亚克力



镜面尺寸 Mirror Size	L215xW215mm H350xW215mm
镜面厚度 Mirror Thickness	23mm
净重(只) NW(SETS)	1.7KGS
毛重(箱) GW(CTN)	22.6KGS
装箱数 Quantity	10SETS
泡沫包装 Foam Packing	935x435X645mm

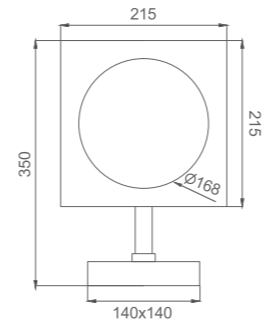

HSY-2011



镜面尺寸 Mirror Size	L215xW215mm H350xW215mm
镜面厚度 Mirror Thickness	23mm
净重(只) NW(SETS)	1.88KGS
毛重(箱) GW(CTN)	24.4KGS
装箱数 Quantity	10SETS
泡沫包装 Foam Packing	935x435X645mm

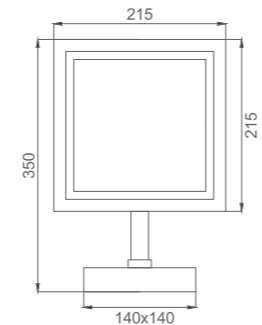

HSY-2012



镜面尺寸 Mirror Size	L200xW200mm H350xW230mm
镜面厚度 Mirror Thickness	20mm
净重(只) NW(SETS)	1.52KGS
毛重(箱) GW(CTN)	19.2KGS
装箱数 Quantity	10SETS
珍珠棉包装 EPE Packing	830x420X590mm

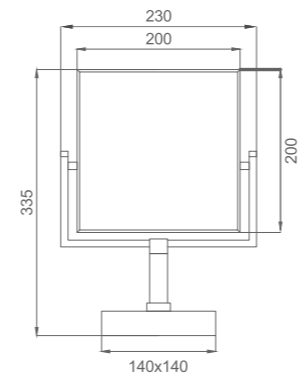

HSY-2013



镜面尺寸 Mirror Size	L220xW160mm H350xW160mm
镜面厚度 Mirror Thickness	2mm
净重(只) NW(SETS)	0.85KGS
毛重(箱) GW(CTN)	12.5KGS
装箱数 Quantity	10SETS
珍珠棉包装 EPE Packing	830x420X590mm

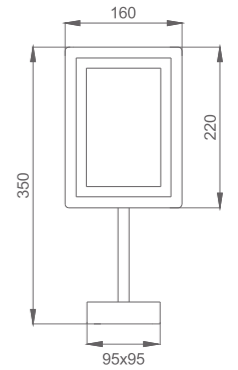

HSY-2014



镜面尺寸 Mirror Size	∅200 H350xW420mm
镜面厚度 Mirror Thickness	10mm
净重(只) NW(SETS)	1KGS
毛重(箱) GW(CTN)	14.4KGS
装箱数 Quantity	10SETS
泡沫包装 Foam Packing	405x395X57mm

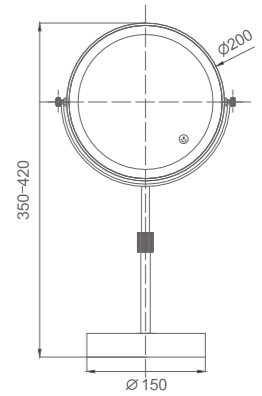

HSY-2015



镜面尺寸 Mirror Size	∅200 H355xW230mm
镜面厚度 Mirror Thickness	18mm
净重(只) NW(SETS)	1.2KGS
毛重(箱) GW(CTN)	15KGS
装箱数 Quantity	10SETS
泡沫包装 Foam Packing	935x435X645mm

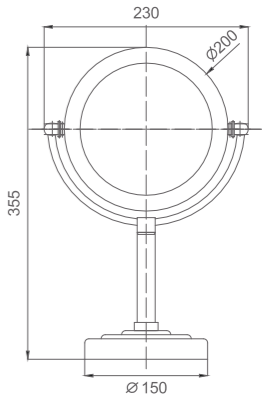

HSY-2016

PROXIMITY SENSOR 距离感应
AUTO OFF 延时关闭



镜面尺寸 Mirror Size	∅215 H368xW215mm
镜面厚度 Mirror Thickness	23mm
净重(只) NW(SETS)	1.7KGS
毛重(箱) GW(CTN)	22.6KGS
装箱数 Quantity	10SETS
泡沫包装 Foam Packing	935x435X645mm

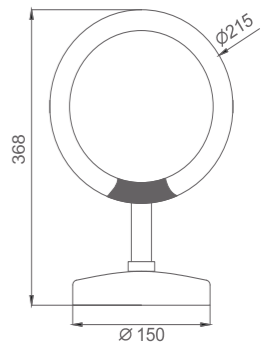

材料：铜，不锈钢
颜色：铬，镀金，青古铜，仿古，ORB，拉丝镍，红古铜，玫瑰金，枪黑，喷漆
倍数：一面正常，另一面放大 2/3/5/7/10倍
镜面尺寸：6/7/8英寸
双杆长度：210-300mm
功能：化妆美容，刮胡须，礼品赠品
适应范围：酒店，家具，展柜，卫浴建材，浴室，卧室，美容院

Material : Brass , Stainless steel
Color : Chrome ,Gold ,Bronze ,Antique Copper ,ORB ,Nickel ,Red Bronze ,Rose Gold ,Black
Magnification : 1x & 2x/3x/5x/7x
Mirror frame : 6/7/8inch
Handle length : 210-300mm
Function : Cosmetic , Shaving , Gift ect
Range : Hospility , Furniture , Bathroom , Bedroom ect



清晰的设计极具个性，精心设计的细节反映出公司的制造理念，
即始终注重对当今生活的诠释和贴近。

The clean design characterized by high personality and carefully
planned details reflects the productive philosophy of a company always
able to interpret and comply with current life style.

MIRROR THICKNESS
镜面厚度 16MM

HSY-3001



镜面尺寸/Mirror Size
Ø150 **Ø200**
 L385xH215mm L400xH265mm
 净重(只)/NW(SETS)
 0.52KGS 0.7KGS
 毛重(箱)/GW(CTN)
 14.1KGS 18.3KGS
 装箱数/Quantity
 20SETS 20SETS
 普通包装/Normal Packing
 450x240X470mm 390x310X620mm
 泡沫包装/Foam Packing
 590x350X700mm 590x350X700mm

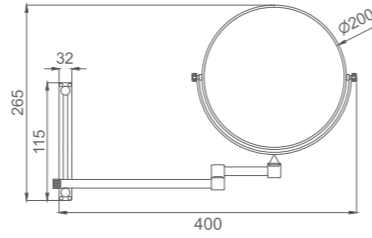

HSY-3002



镜面尺寸/Mirror Size
Ø150 **Ø200**
 L390xH255mm L400xH305mm
 净重(只)/NW(SETS)
 0.52KGS 0.7KGS
 毛重(箱)/GW(CTN)
 14.1KGS 18.3KGS
 装箱数/Quantity
 20SETS 20SETS
 普通包装/Normal Packing
 480x310X480mm 390x310X620mm
 泡沫包装/Foam Packing
 590x350X700mm 590x350X700mm

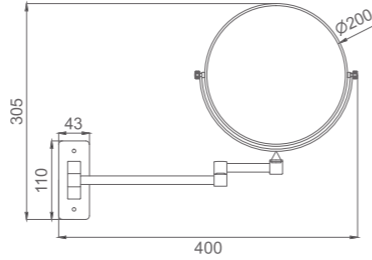

HSY-3003



镜面尺寸/Mirror Size
Ø150 **Ø200**
 L390xH248mm L425xH298mm
 净重(只)/NW(SETS)
 0.54KGS 0.72KGS
 毛重(箱)/GW(CTN)
 14.5KGS 18.7KGS
 装箱数/Quantity
 20SETS 20SETS
 普通包装/Normal Packing
 480x310X480mm 390x310X620mm
 泡沫包装/Foam Packing
 590x350X700mm 590x350X700mm

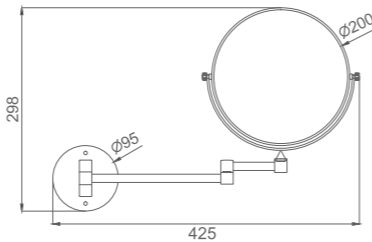

HSY-3004



镜面尺寸/Mirror Size
Ø150 **Ø200**
 L390xH255mm L400xH305mm
 净重(只)/NW(SETS)
 0.49KGS 0.67KGS
 毛重(箱)/GW(CTN)
 13.5KGS 17.7KGS
 装箱数/Quantity
 20SETS 20SETS
 普通包装/Normal Packing
 480x310X480mm 390x310X620mm
 泡沫包装/Foam Packing
 590x350X700mm 590x350X700mm

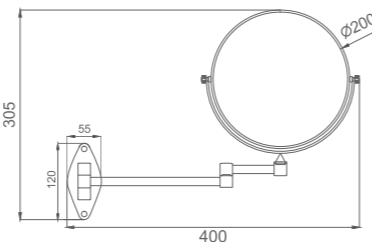

HSY-3005



镜面尺寸/Mirror Size
Ø150 **Ø200**
 L395xH263mm L405xH313mm
 净重(只)/NW(SETS)
 0.52KGS 0.7KGS
 毛重(箱)/GW(CTN)
 14.1KGS 18.3KGS
 装箱数/Quantity
 20SETS 20SETS
 普通包装/Normal Packing
 480x310X480mm 390x310X620mm
 泡沫包装/Foam Packing
 590x350X700mm 590x350X700mm

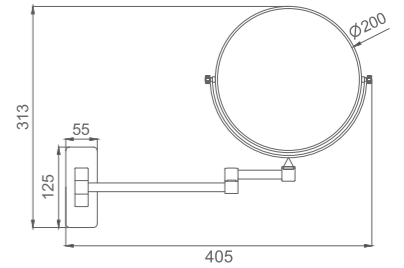

HSY-3006



镜面尺寸/Mirror Size
Ø150 **Ø200**
 L390xH248mm L425xH298mm
 净重(只)/NW(SETS)
 0.54KGS 0.72KGS
 毛重(箱)/GW(CTN)
 14.5KGS 18.7KGS
 装箱数/Quantity
 20SETS 20SETS
 普通包装/Normal Packing
 480x310X480mm 390x310X620mm
 泡沫包装/Foam Packing
 590x350X700mm 590x350X700mm

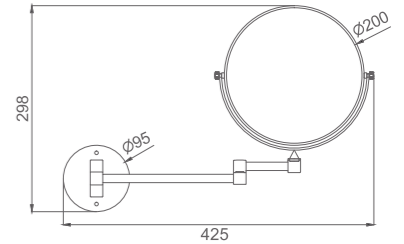

HSY-3007



镜面尺寸/Mirror Size
Ø150 **Ø200**
 L390xH270mm L400xH320mm
 净重(只)/NW(SETS)
 0.48KGS 0.66KGS
 毛重(箱)/GW(CTN)
 13.3KGS 17.5KGS
 装箱数/Quantity
 20SETS 20SETS
 普通包装/Normal Packing
 480x310X480mm 390x310X620mm
 泡沫包装/Foam Packing
 590x350X700mm 590x350X700mm

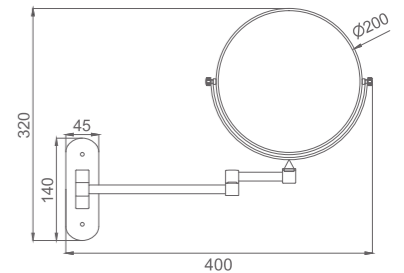

HSY-3008



镜面尺寸/Mirror Size
Ø150 **Ø200**
 L385xH225mm L400xH275mm
 净重(只)/NW(SETS)
 0.64KGS 0.82KGS
 毛重(箱)/GW(CTN)
 16.5KGS 20.7KGS
 装箱数/Quantity
 20SETS 20SETS
 普通包装/Normal Packing
 480x310X480mm 390x310X620mm
 泡沫包装/Foam Packing
 590x350X700mm 590x350X700mm

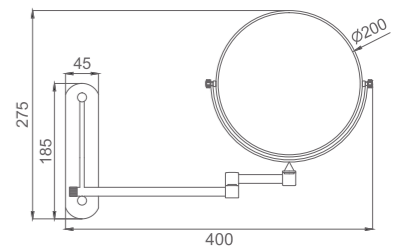

HSY-3009



镜面尺寸/Mirror Size
 Ø150 Ø200
 L390xH270mm L405xH320mm
 净重(只)/NW(SETS)
 0.48KGS 0.66KGS
 毛重(箱)/GW(CTN)
 13.3KGS 17.5KGS
 装箱数/Quantity
 20SETS 20SETS
 普通包装/Normal Packing
 480x310X480mm 390x310X620mm
 泡沫包装/Foam Packing
 590x350X700mm 590x350X700mm

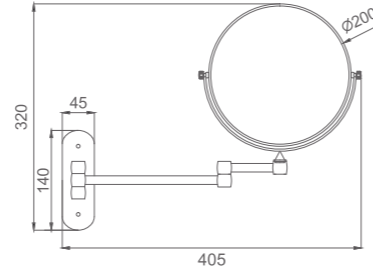

HSY-3010



镜面尺寸/Mirror Size
 Ø150 Ø200
 L420xH248mm L435xH298mm
 净重(只)/NW(SETS)
 0.54KGS 0.72KGS
 毛重(箱)/GW(CTN)
 14.5KGS 18.7KGS
 装箱数/Quantity
 20SETS 20SETS
 普通包装/Normal Packing
 480x310X480mm 390x310X620mm
 泡沫包装/Foam Packing
 590x350X700mm 590x350X700mm

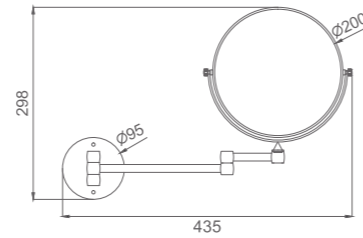

HSY-3011



镜面尺寸/Mirror Size
 Ø150 Ø200
 L188-445mm L213-470mm
 H340-360mm H390-410mm
 净重(只)/NW(SETS)
 0.68KGS 0.86KGS
 毛重(箱)/GW(CTN)
 16.6KGS 20.9KGS
 装箱数/Quantity
 20SETS 20SETS
 普通包装/Normal Packing
 450x240X470mm 480x310X480mm
 泡沫包装/Foam Packing
 590x350X700mm 590x350X700mm

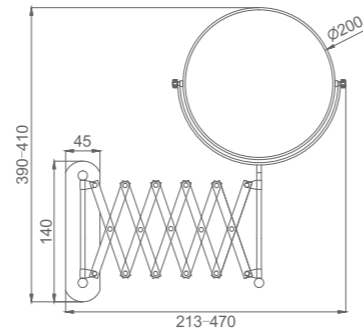

HSY-3012



镜面尺寸/Mirror Size
 Ø150 Ø200
 L185-440mm L210-465mm
 H340-360mm H390-410mm
 净重(只)/NW(SETS)
 0.61KGS 0.76KGS
 毛重(箱)/GW(CTN)
 15.2KGS 18.2KGS
 装箱数/Quantity
 20SETS 20SETS
 普通包装/Normal Packing
 450x240X470mm 450x240X470mm
 泡沫包装/Foam Packing
 590x350X700mm 590x350X700mm

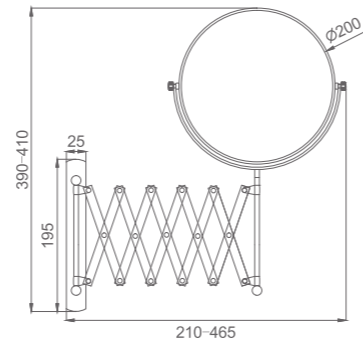

HSY-3013



镜面尺寸/Mirror Size
 Ø150 Ø200
 L415xH210mm L400xH260mm
 净重(只)/NW(SETS)
 0.52KGS 0.7KGS
 毛重(箱)/GW(CTN)
 13.4KGS 18.3KGS
 装箱数/Quantity
 20SETS 20SETS
 普通包装/Normal Packing
 450x350X700mm 390x310X620mm
 泡沫包装/Foam Packing
 590x350X700mm 590x350X700mm

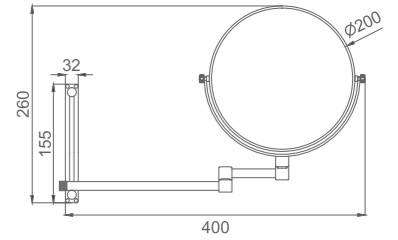

HSY-3014



镜面尺寸/Mirror Size
 Ø150 Ø200
 L390xH250mm L400xH300mm
 净重(只)/NW(SETS)
 0.46KGS 0.64KGS
 毛重(箱)/GW(CTN)
 12.9KGS 17.1KGS
 装箱数/Quantity
 20SETS 20SETS
 普通包装/Normal Packing
 480x310X480mm 390x310X620mm
 泡沫包装/Foam Packing
 590x350X700mm 590x350X700mm

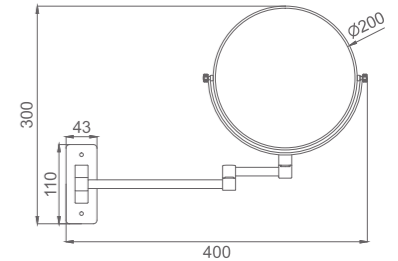

HSY-3015



镜面尺寸/Mirror Size
 Ø150 Ø200
 L415xH243mm L425xH293mm
 净重(只)/NW(SETS)
 0.5KGS 0.68KGS
 毛重(箱)/GW(CTN)
 13.7KGS 17.9KGS
 装箱数/Quantity
 20SETS 20SETS
 普通包装/Normal Packing
 480x310X480mm 390x310X620mm
 泡沫包装/Foam Packing
 590x350X700mm 590x350X700mm

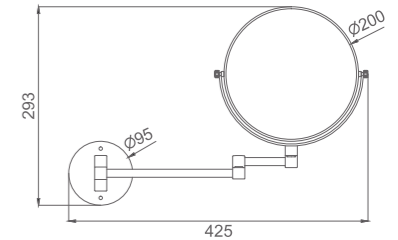

HSY-3016



镜面尺寸/Mirror Size
 Ø150 Ø200
 L392xH265mm L400xH315mm
 净重(只)/NW(SETS)
 0.6KGS 0.78KGS
 毛重(箱)/GW(CTN)
 15.7KGS 19.9KGS
 装箱数/Quantity
 20SETS 20SETS
 普通包装/Normal Packing
 480x310X480mm 390x310X620mm
 泡沫包装/Foam Packing
 590x350X700mm 590x350X700mm

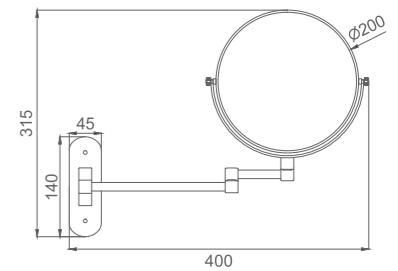

HSY-3017



镜面尺寸
Mirror Size **∅200**
L430xH315mm

净重(只)
NW(SETS) 0.9KGS

毛重(箱)
GW(CTN) 12KGS

装箱数
Quantity 10SETS

泡沫包装
Foam Packing 380x370X620mm

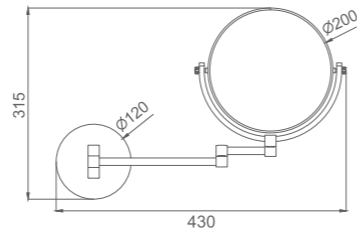

HSY-3018



镜面尺寸
Mirror Size **∅200**
L395xH278mm

净重(只)
NW(SETS) 0.8KGS

毛重(箱)
GW(CTN) 11KGS

装箱数
Quantity 10SETS

泡沫包装
Foam Packing 380x370X620mm

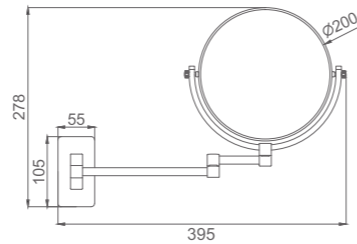

HSY-3019



镜面尺寸
Mirror Size **∅200**
L395xH325mm

净重(只)
NW(SETS) 0.86KGS

毛重(箱)
GW(CTN) 11.6KGS

装箱数
Quantity 10SETS

泡沫包装
Foam Packing 380x370X620mm

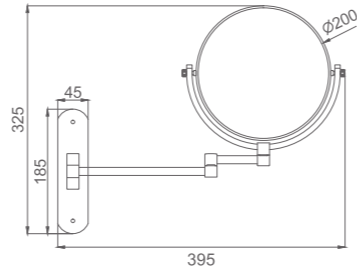

HSY-3020



镜面尺寸
Mirror Size **∅200**
L409xH284mm

净重(只)
NW(SETS) 0.76KGS

毛重(箱)
GW(CTN) 10.6KGS

装箱数
Quantity 10SETS

泡沫包装
Foam Packing 380x370X620mm

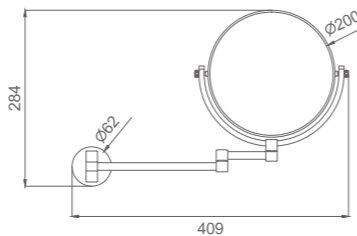

HSY-3021



镜面尺寸
Mirror Size **∅200**
L300xH250mm

净重(只)
NW(SETS) 0.7KGS

毛重(箱)
GW(CTN) 18KGS

装箱数
Quantity 20SETS

普通包装
Normal Packing 480x310X480mm

泡沫包装
Foam Packing 590x350X700mm

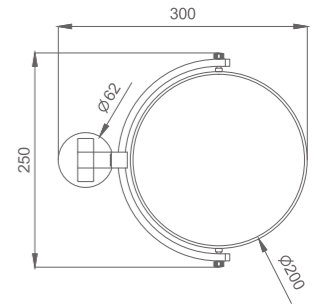

HSY-3022



镜面尺寸
Mirror Size **∅200**
H500xW200mm

净重(只)
NW(SETS) 0.7KGS

毛重(箱)
GW(CTN) 18KGS

装箱数
Quantity 20SETS

普通包装
Normal Packing 565x475X490mm

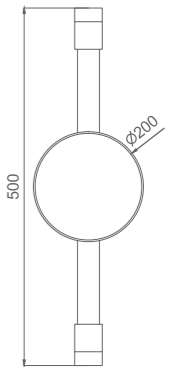

HSY-3023



镜面尺寸
Mirror Size **∅200**
L475xH250mm

净重(只)
NW(SETS) 1.1KGS

毛重(箱)
GW(CTN) 16KGS

装箱数
Quantity 10SETS

普通包装
Normal Packing 380x370X620mm

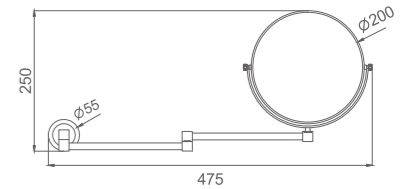

HSY-3024



镜面尺寸
Mirror Size **∅110**
L415xH140mm

净重(只)
NW(SETS) 0.6KGS

毛重(箱)
GW(CTN) 15.7KGS

装箱数
Quantity 20SETS

普通包装
Normal Packing 450x240X470mm

泡沫包装
Foam Packing 590x350X700mm

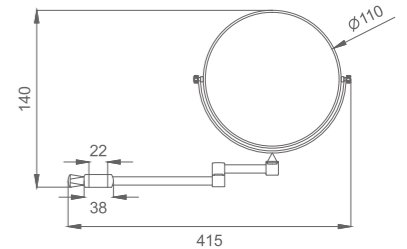

HSY-3025

304 SUS 不锈钢



镜面尺寸
Mirror Size **Ø190**
L405xH298mm

净重(只)
NW(SETS) 0.72KGS

毛重(箱)
GW(CTN) 18.7KGS

装箱数
Quantity 20SETS

泡沫包装
Foam Packing 590x350X700mm

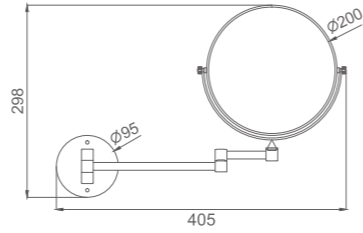

HSY-3026

ALUMINUM 铝



镜面尺寸
Mirror Size **Ø200**
L405xH298mm

净重(只)
NW(SETS) 0.5KGS

毛重(箱)
GW(CTN) 13.7KGS

装箱数
Quantity 20SETS

泡沫包装
Foam Packing 590x350X700mm

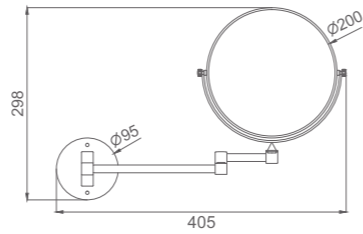

HSY-3027



镜面尺寸/Mirror Size
Ø150 **Ø200**

净重(只)/NW(SETS)
0.3KGS 0.4KGS

毛重(箱)/GW(CTN)
10KGS 12KGS

装箱数/Quantity
20SETS 20SETS

普通包装/Normal Packing
450x240X470mm 450x240X470mm

泡沫包装/Foam Packing
590x350X700mm 590x350X700mm

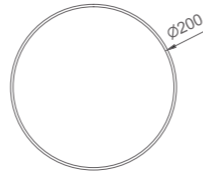

HSY-3028



镜面尺寸
Mirror Size **Ø150**
W258mm

净重(只)
NW(SETS) 0.3KGS

毛重(箱)
GW(CTN) 16KGS

装箱数
Quantity 40SETS

普通包装
Normal Packing 380x310X380mm

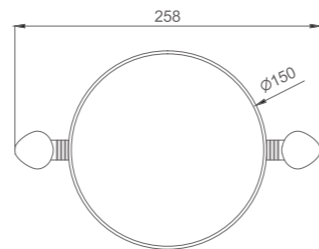

HSY-3029



镜面尺寸
Mirror Size **Ø168**
L369xH168mm

净重(只)
NW(SETS) 0.7KGS

毛重(箱)
GW(CTN) 12KGS

装箱数
Quantity 10SETS

珍珠棉包装
EPE Packing 380x370X620mm

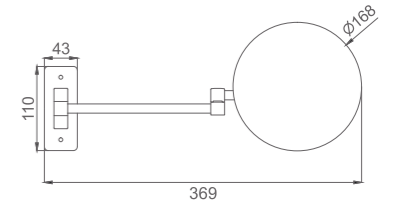

HSY-3030



镜面尺寸
Mirror Size **Ø168**
L369xH168mm

净重(只)
NW(SETS) 0.7KGS

毛重(箱)
GW(CTN) 12KGS

装箱数
Quantity 10SETS

珍珠棉包装
EPE Packing 380x370X620mm

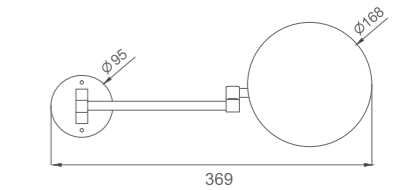

HSY-3031



镜面尺寸
Mirror Size **Ø168**
L369xH168mm

净重(只)
NW(SETS) 0.7KGS

毛重(箱)
GW(CTN) 12KGS

装箱数
Quantity 10SETS

珍珠棉包装
EPE Packing 380x370X620mm

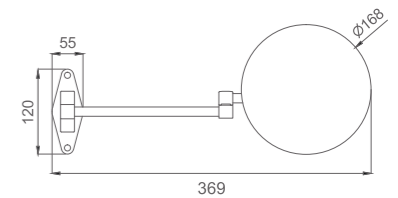

HSY-3032



镜面尺寸
Mirror Size **Ø168**
L369xH168mm

净重(只)
NW(SETS) 0.7KGS

毛重(箱)
GW(CTN) 12KGS

装箱数
Quantity 10SETS

珍珠棉包装
EPE Packing 380x370X620mm

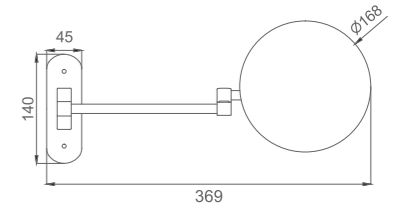

HSY-3033



镜面尺寸
Mirror Size L212xW132mm
L350xH212mm

净重(只)
NW(SETS) 0.7KGS

毛重(箱)
GW(CTN) 12KGS

装箱数
Quantity 10SETS

珍珠棉包装
EPE Packing 380x370X620mm

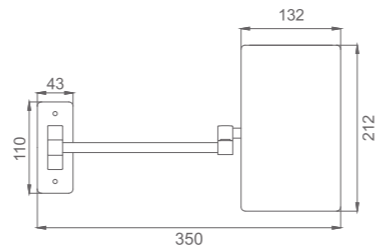

HSY-3034

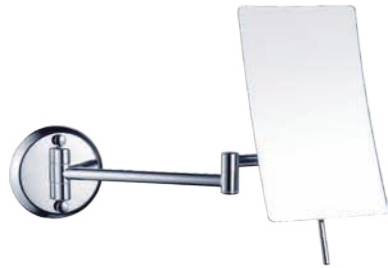

镜面尺寸
Mirror Size L212xW132mm
L350xH212mm

净重(只)
NW(SETS) 0.7KGS

毛重(箱)
GW(CTN) 12KGS

装箱数
Quantity 10SETS

珍珠棉包装
EPE Packing 380x370X620mm

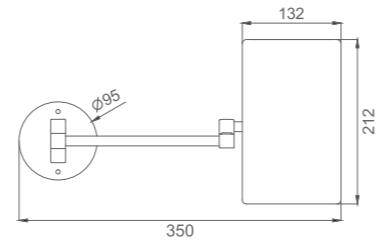

HSY-3035



镜面尺寸
Mirror Size L212xW132mm
L350xH212mm

净重(只)
NW(SETS) 0.7KGS

毛重(箱)
GW(CTN) 12KGS

装箱数
Quantity 10SETS

珍珠棉包装
EPE Packing 380x370X620mm

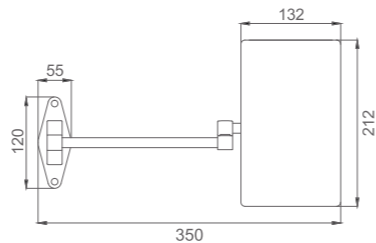

HSY-3036



镜面尺寸
Mirror Size L212xW132mm
L350xH212mm

净重(只)
NW(SETS) 0.7KGS

毛重(箱)
GW(CTN) 12KGS

装箱数
Quantity 10SETS

珍珠棉包装
EPE Packing 380x370X620mm

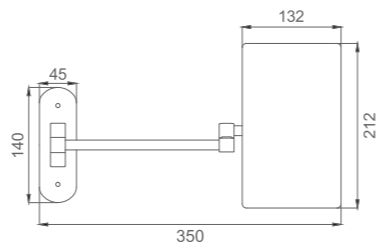

HSY-3037



镜面尺寸/Mirror Size
Ø150 L265xH190mm **Ø200** L290xH240mm

净重(只)/NW(SETS)
0.42KGS 0.6KGS

毛重(箱)/GW(CTN)
12.1KGS 16.8KGS

装箱数/Quantity
20SETS 20SETS

普通包装/Normal Packing
480x310X480mm 390x310X620mm

泡沫包装/Foam Packing
590x350X700mm 590x350X700mm

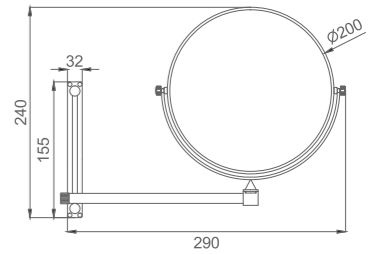

HSY-3038



镜面尺寸/Mirror Size
Ø150 L280xH235mm **Ø200** L305xH285mm

净重(只)/NW(SETS)
0.42KGS 0.6KGS

毛重(箱)/GW(CTN)
12.1KGS 16.8KGS

装箱数/Quantity
20SETS 20SETS

普通包装/Normal Packing
480x310X480mm 390x365X540mm

泡沫包装/Foam Packing
590x350X700mm 590x350X700mm

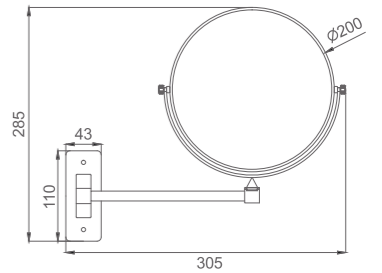

HSY-3039



镜面尺寸/Mirror Size
Ø150 L305xH228mm **Ø200** L330xH278mm

净重(只)/NW(SETS)
0.44KGS 0.62KGS

毛重(箱)/GW(CTN)
12.5KGS 17.2KGS

装箱数/Quantity
20SETS 20SETS

普通包装/Normal Packing
480x310X480mm 390x365X540mm

泡沫包装/Foam Packing
590x350X700mm 590x350X700mm

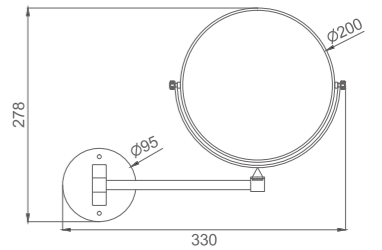

HSY-3040



镜面尺寸/Mirror Size
Ø150 L275xH205mm **Ø200** L300xH255mm

净重(只)/NW(SETS)
0.54KGS 0.72KGS

毛重(箱)/GW(CTN)
14.5KGS 18.7KGS

装箱数/Quantity
20SETS 20SETS

普通包装/Normal Packing
480x310X480mm 390x365X540mm

泡沫包装/Foam Packing
590x350X700mm 590x350X700mm

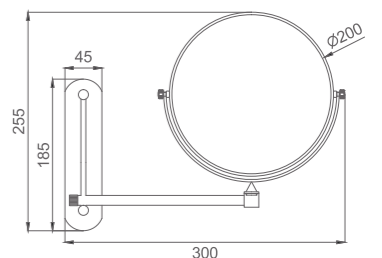

HSY-3041



镜面尺寸/Mirror Size
 Ø150 Ø200
 L285xH250mm L310xH300mm
 净重(只)/NW(SETS)
 0.48KGS 0.66KGS
 毛重(箱)/GW(CTN)
 13.3KGS 17.5KGS
 装箱数/Quantity
 20SETS 20SETS
 普通包装/Normal Packing
 480x310x480mm 390x365x540mm
 泡沫包装/Foam Packing
 590x350x700mm 590x350x700mm

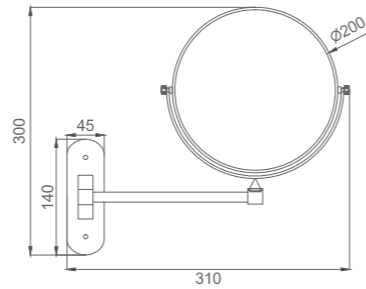

HSY-3042



镜面尺寸/Mirror Size
 Ø150 Ø200
 L305xH228mm L330xH278mm
 净重(只)/NW(SETS)
 0.44KGS 0.62KGS
 毛重(箱)/GW(CTN)
 12.5KGS 17.2KGS
 装箱数/Quantity
 20SETS 20SETS
 普通包装/Normal Packing
 480x310x480mm 390x365x540mm
 泡沫包装/Foam Packing
 590x350x700mm 590x350x700mm

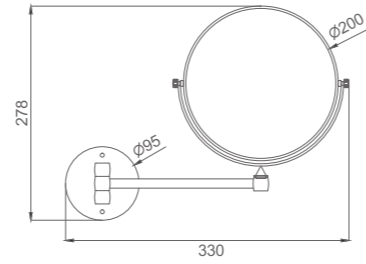

HSY-3043



镜面尺寸
 Mirror Size Ø200
 L372xH290mm
 净重(只)
 NW(SETS) 0.62KGS
 毛重(箱)
 GW(CTN) 16.4KGS
 装箱数
 Quantity 20SETS
 普通包装
 Normal Packing 395x365x540mm

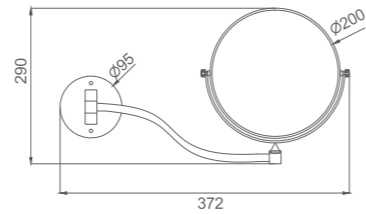

HSY-3044



镜面尺寸
 Mirror Size Ø200
 L372xH290mm
 净重(只)
 NW(SETS) 0.62KGS
 毛重(箱)
 GW(CTN) 16.4KGS
 装箱数
 Quantity 20SETS
 普通包装
 Normal Packing 395x365x540mm

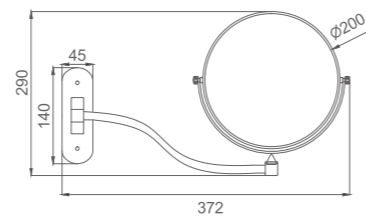

HSY-3045



镜面尺寸
 Mirror Size Ø200
 L345xH295mm
 净重(只)
 NW(SETS) 0.8KGS
 毛重(箱)
 GW(CTN) 11KGS
 装箱数
 Quantity 10SETS
 普通包装
 Normal Packing 590x350x360mm

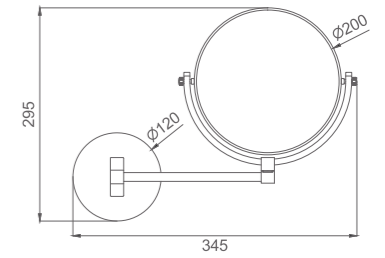

HSY-3046



镜面尺寸
 Mirror Size Ø200
 L310xH258mm
 净重(只)
 NW(SETS) 0.7KGS
 毛重(箱)
 GW(CTN) 10KGS
 装箱数
 Quantity 10SETS
 普通包装
 Normal Packing 590x350x360mm

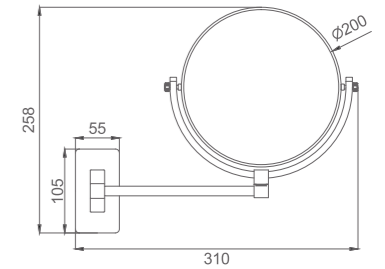

HSY-3047



镜面尺寸
 Mirror Size Ø200
 L305xH310mm
 净重(只)
 NW(SETS) 0.76KGS
 毛重(箱)
 GW(CTN) 10.6KGS
 装箱数
 Quantity 10SETS
 普通包装
 Normal Packing 590x350x360mm

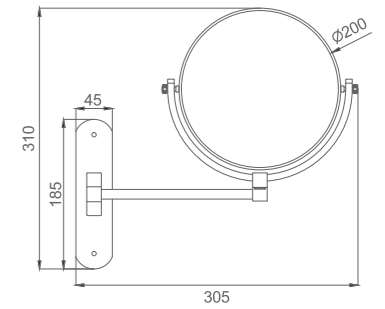

HSY-3048



镜面尺寸
 Mirror Size Ø200
 L375xH295mm
 净重(只)
 NW(SETS) 1.3KGS
 毛重(箱)
 GW(CTN) 18KGS
 装箱数
 Quantity 10SETS
 普通包装
 Normal Packing 590x350x360mm

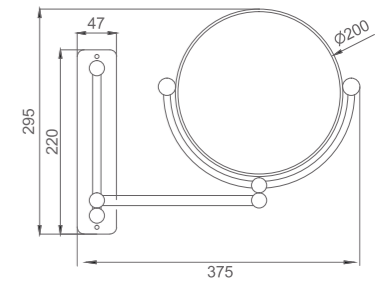

HSY-3049



镜面尺寸 Mirror Size	Ø200 L600xH295mm
净重(只) NW(SETS)	1.3KGS
毛重(箱) GW(CTN)	17KGS
装箱数 Quantity	10SETS
普通包装 Normal Packing	590x350x360mm

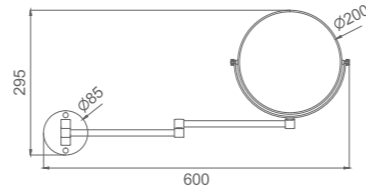

HSY-3050



镜面尺寸 Mirror Size	Ø200 L355xH265mm
净重(只) NW(SETS)	0.8KGS
毛重(箱) GW(CTN)	12KGS
装箱数 Quantity	10SETS
普通包装 Normal Packing	590x350x360mm

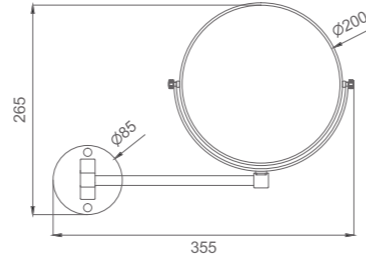

HSY-3051



镜面尺寸 Mirror Size	L150xW200mm L280xH285mm
净重(只) NW(SETS)	0.66KGS
毛重(箱) GW(CTN)	18KGS
装箱数 Quantity	20SETS
普通包装 Normal Packing	390x365x540mm
泡沫包装 Foam Packing	590x350x700mm

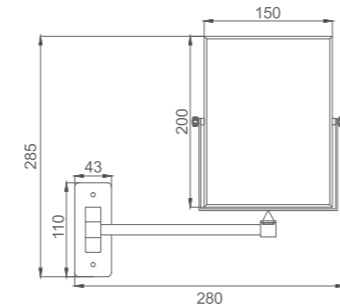

HSY-3052



镜面尺寸 Mirror Size	L150xW200mm L380xH305mm
净重(只) NW(SETS)	0.76KGS
毛重(箱) GW(CTN)	19.5KGS
装箱数 Quantity	20SETS
普通包装 Normal Packing	390x310x620mm
泡沫包装 Foam Packing	590x350x700mm

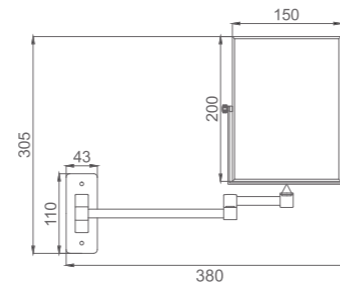

HSY-3053



镜面尺寸 Mirror Size	L150xW200mm L405xH298mm
净重(只) NW(SETS)	0.8KGS
毛重(箱) GW(CTN)	20.3KGS
装箱数 Quantity	20SETS
普通包装 Normal Packing	390x310x620mm
泡沫包装 Foam Packing	590x350x700mm

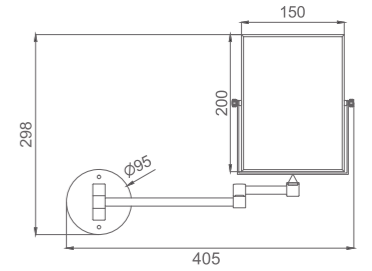

HSY-3054



镜面尺寸 Mirror Size	L150xW200mm L385xH320mm
净重(只) NW(SETS)	0.86KGS
毛重(箱) GW(CTN)	21.5KGS
装箱数 Quantity	20SETS
普通包装 Normal Packing	390x310x620mm
泡沫包装 Foam Packing	590x350x700mm

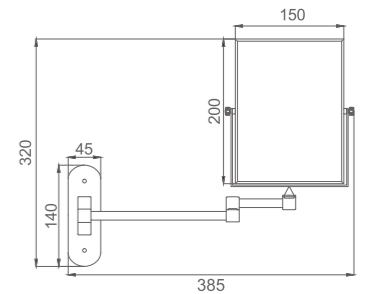

HSY-3055



镜面尺寸 Mirror Size	L150xW200mm L210-470xH390-410mm
净重(只) NW(SETS)	0.96KGS
毛重(箱) GW(CTN)	22.9KGS
装箱数 Quantity	20SETS
普通包装 Normal Packing	480x310x480mm
泡沫包装 Foam Packing	590x350x700mm

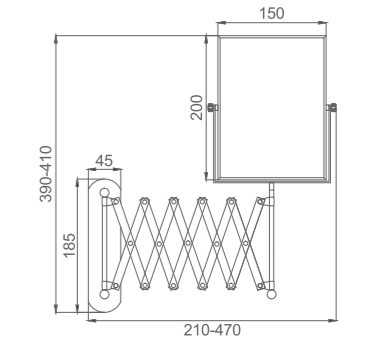

HSY-3056



镜面尺寸 Mirror Size	L150xW200mm L210-470xH390-410mm
净重(只) NW(SETS)	0.86KGS
毛重(箱) GW(CTN)	20.9KGS
装箱数 Quantity	20SETS
普通包装 Normal Packing	480x310x480mm
泡沫包装 Foam Packing	590x35x700mm

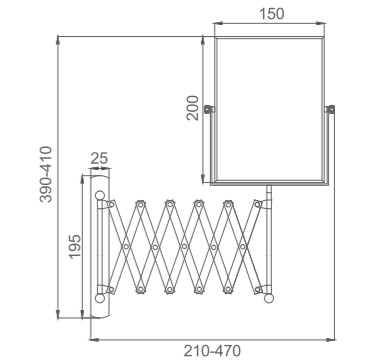



材料：铜，不锈钢
颜色：铬，镀金，青古铜，仿古，ORB，拉丝镍，红古铜，玫瑰金，枪黑，喷漆
倍数：一面正常 另一面放大2/3/5/7/10倍
镜面尺寸：6/7/8英寸
高度：200-350mm
功能：化妆美容，刮胡须，礼品赠品
适应范围：酒店，家具，展柜，卫浴建材，浴室，卧室，美容院

Material : Brass , Stainless steel
Color : Chrome ,Gold ,Bronze ,Antique Copper ,ORB ,Nickel ,Red Bronze ,Rose Gold ,Black
Magnification : 1x & 2x/3x/5x/7x
Mirror frame : 6/7/8inch
Handle length : 200-350mm
Function : Cosmetic , Shaving , Gift ect
Range : Hospility , Furniture , Bathroom , Bedroom ect

Desktop Cosmetic Mirror 台式无灯



To absorb and purify the artistic soul of china and the western with simplicity, and breakthrough of traditional design to demonstrate the spirit of combination and present sense of stability and affluence.

The clean design characterized by high personality and carefully planned details reflects the productive philosophy of a company always able to interpret and comply with current life style.

DESKTOP

Cosmetic Mirror 台式无灯



HSY-4001-1

MIRROR THICKNESS
镜面厚度 16MM

HSY-4001

镜面尺寸/Mirror Size	
Ø150 H290mm	Ø200 H340mm
净重(只)/NW(SETS) 0.5KGS	0.66KGS
毛重(箱)/GW(CTN) 7KGS	8.7KGS
装箱数/Quantity 10SETS	10SETS
普通包装/Normal Packing 450x240x470mm	480x310x480mm
泡沫包装/Foam Packing 375x355x505mm	770x405x575mm

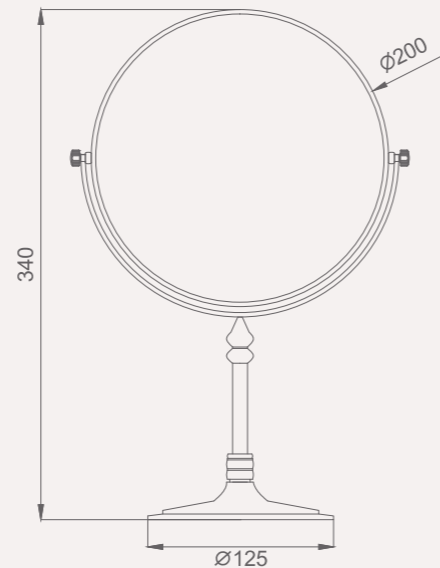

HSY-4002 HSY-4002-1



镜面尺寸/Mirror Size	
Ø150 H300mm	Ø200 H350mm
净重(只)/NW(SETS) 0.53KGS	0.71KGS
毛重(箱)/GW(CTN) 14.3KGS	17.9KGS
装箱数/Quantity 10SETS	10SETS
普通包装/Normal Packing 535x340x490mm	640x340x490mm
泡沫包装/Foam Packing 395x405x575mm	770x405x575mm

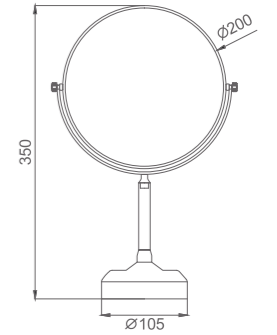

HSY-4003



镜面尺寸/Mirror Size	
Ø150 H300mm	Ø200 H350mm
净重(只)/NW(SETS) 0.78KGS	0.96KGS
毛重(箱)/GW(CTN) 20.1KGS	23.3KGS
装箱数/Quantity 10SETS	10SETS
普通包装/Normal Packing 480x310x480mm	480x245x325mm
泡沫包装/Foam Packing 395x405x575mm	395x405x575mm

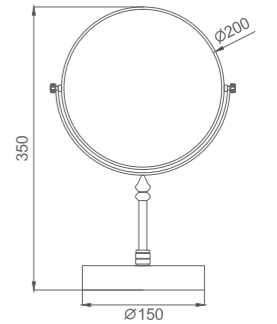

HSY-4004



镜面尺寸/Mirror Size	
Ø150 H290mm	Ø200 H340mm
净重(只)/NW(SETS) 0.47KGS	0.62KGS
毛重(箱)/GW(CTN) 13.4KGS	16.4KGS
装箱数/Quantity 20SETS	20SETS
普通包装/Normal Packing 480x310x480mm	480x310x480mm
泡沫包装/Foam Packing 590x350x705mm	590x350x705mm

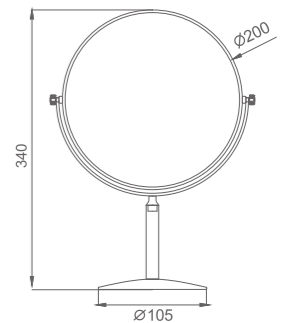

HSY-4005



镜面尺寸/Mirror Size	
Ø150 H300mm	Ø200 H350mm
净重(只)/NW(SETS) 0.59KGS	0.76KGS
毛重(箱)/GW(CTN) 15.8KGS	19.2KGS
装箱数/Quantity 10SETS	10SETS
普通包装/Normal Packing 480x310x480mm	480x310x480mm
泡沫包装/Foam Packing 395x405x575mm	395x405x575mm

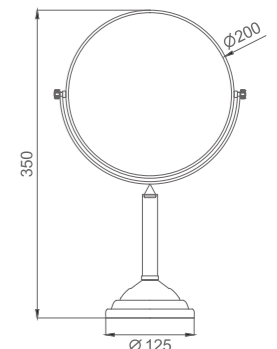

HSY-4006



镜面尺寸/Mirror Size
 Ø150 Ø200
 H300-370mm H350-420mm
 净重(只)/NW(SETS)
 0.8KGS 0.98KGS
 毛重(箱)/GW(CTN)
 19.7KGS 23.9KGS
 装箱数/Quantity
 10SETS 10SETS
 普通包装/Normal Packing
 480x310X480mm 480x310X480mm
 泡沫包装/Foam Packing
 395x405x575mm 395x405x575mm

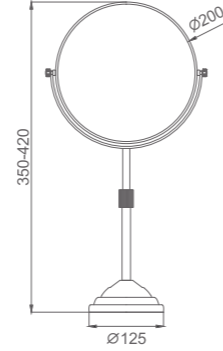

HSY-4007



镜面尺寸/Mirror Size
 Ø150 Ø200
 H300-370mm H350-420mm
 净重(只)/NW(SETS)
 0.58KGS 0.76KGS
 毛重(箱)/GW(CTN)
 15.3KGS 19.5KGS
 装箱数/Quantity
 10SETS 10SETS
 普通包装/Normal Packing
 480x310X480mm 480x310X480mm
 泡沫包装/Foam Packing
 395x405x575mm 395x405x575mm

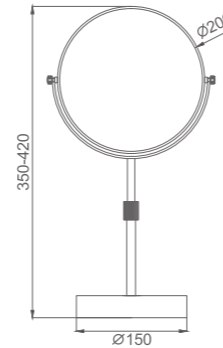

HSY-4008



镜面尺寸/Mirror Size
 Ø150 Ø200
 H300mm H350mm
 净重(只)/NW(SETS)
 0.68KGS 0.86KGS
 毛重(箱)/GW(CTN)
 17.3KGS 20.9KGS
 装箱数/Quantity
 10SETS 10SETS
 普通包装/Normal Packing
 480x310X480mm 480x310X480mm
 泡沫包装/Foam Packing
 395x405x575mm 395x405x575mm

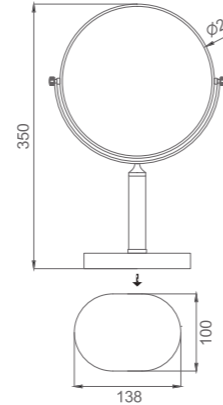

HSY-4009



镜面尺寸/Mirror Size
 Ø150 Ø200
 H300mm H350mm
 净重(只)/NW(SETS)
 0.82KGS 1KGS
 毛重(箱)/GW(CTN)
 20.1KGS 14KGS
 装箱数/Quantity
 10SETS 10SETS
 普通包装/Normal Packing
 480x310X480mm 430x315X320mm
 泡沫包装/Foam Packing
 395x405x575mm 395x405x575mm

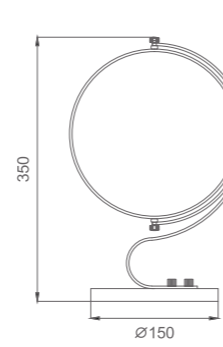

HSY-4010



镜面尺寸
 Mirror Size Ø200
 H350mm
 净重(只)
 NW(SETS) 0.96KGS
 毛重(箱)
 GW(CTN) 14.6KGS
 装箱数
 Quantity 10SETS
 泡沫包装
 Foam Packing 395x405X575mm

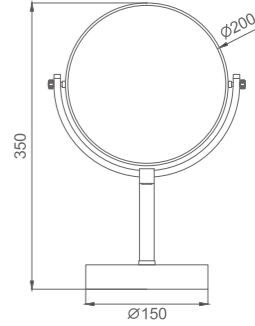

HSY-4011



镜面尺寸
 Mirror Size Ø200
 H350mm
 净重(只)
 NW(SETS) 1.04KGS
 毛重(箱)
 GW(CTN) 15.4KGS
 装箱数
 Quantity 10SETS
 泡沫包装
 Foam Packing 395x405X575mm

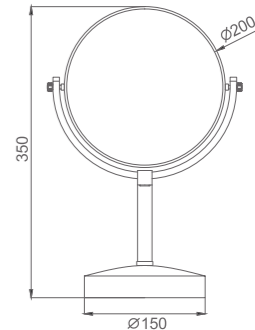

HSY-4012



镜面尺寸
 Mirror Size Ø200
 H350mm
 净重(只)
 NW(SETS) 0.7KGS
 毛重(箱)
 GW(CTN) 12KGS
 装箱数
 Quantity 10SETS
 泡沫包装
 Foam Packing 395x405X575mm

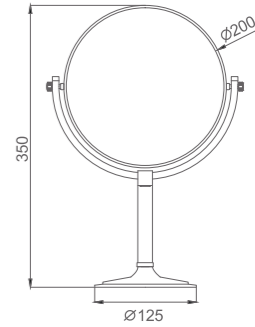

HSY-4013



镜面尺寸
 Mirror Size Ø140
 H300mm
 净重(只)
 NW(SETS) 0.45KGS
 毛重(箱)
 GW(CTN) 14KGS
 装箱数
 Quantity 20SETS
 普通包装
 Normal Packing 610x310X625mm

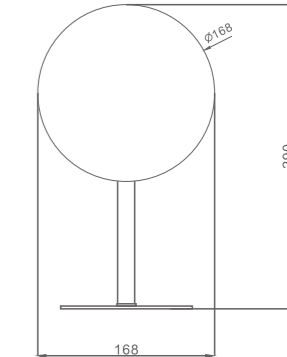

HSY-4014



镜面尺寸
Mirror Size **Ø200** H300mm

净重(只)
NW(SETS) 1.45KGS

毛重(箱)
GW(CTN) 17.5KGS

装箱数
Quantity 10SETS

普通包装
Normal Packing 630x350X360mm

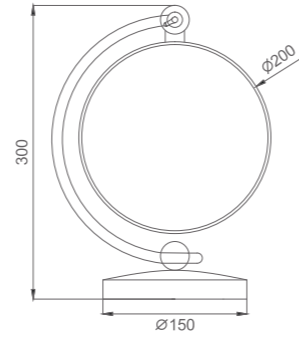

HSY-4015



镜面尺寸/Mirror Size
Ø150 H250mm **Ø200** H300mm

净重(只)/NW(SETS)
0.54KGS 0.72KGS

毛重(箱)/GW(CTN)
15.8KGS 19.4KGS

装箱数/Quantity
20SETS 20SETS

普通包装/Normal Packing
440x350x530mm 440x350x530mm

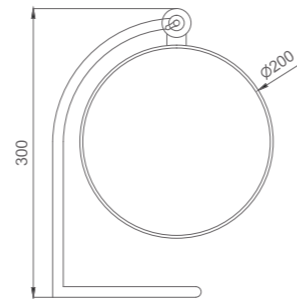

HSY-4016



镜面尺寸/Mirror Size
Ø150 H200mm **Ø200** H250mm

净重(只)/NW(SETS)
0.36KGS 0.54KGS

毛重(箱)/GW(CTN)
11.2KGS 14.8KGS

装箱数/Quantity
20SETS 20SETS

普通包装/Normal Packing
450x240X470mm 450x240X470mm

泡沫包装/Foam Packing
590x350X700mm 590x350X700mm

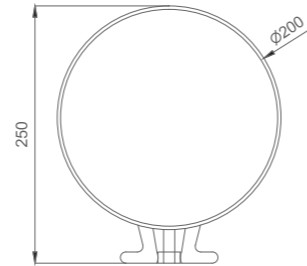

HSY-4017



镜面尺寸/Mirror Size
Ø75 H100mm **Ø150** H200mm

净重(只)/NW(SETS)
0.11KGS 0.42KGS

毛重(箱)/GW(CTN)
16KGS 11.4KGS

装箱数/Quantity
40SETS 20SETS

普通包装/Normal Packing
315x240X245mm 450x240X470mm

泡沫包装/Foam Packing
590x350X700mm

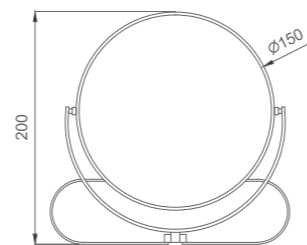

HSY-4018



镜面尺寸
Mirror Size **Ø150** H190xW180mm

净重(只)
NW(SETS) 0.52KGS

毛重(箱)
GW(CTN) 14.4KGS

装箱数
Quantity 20SETS

普通包装
Normal Packing 410x390X420mm

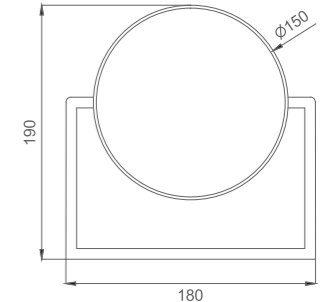

HSY-4019



镜面尺寸
Mirror Size **Ø200** H220mm

净重(只)
NW(SETS) 0.76KGS

毛重(箱)
GW(CTN) 19.2KGS

装箱数
Quantity 20SETS

普通包装
Normal Packing 410x390X420mm

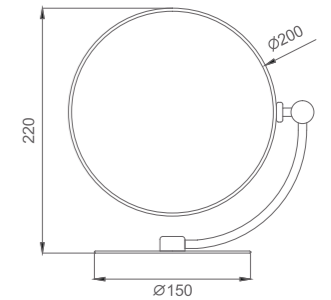

HSY-4020



镜面尺寸
Mirror Size **Ø200** H250mm

净重(只)
NW(SETS) 0.53KGS

毛重(箱)
GW(CTN) 14.6KGS

装箱数
Quantity 20SETS

普通包装
Normal Packing 640x340X490mm

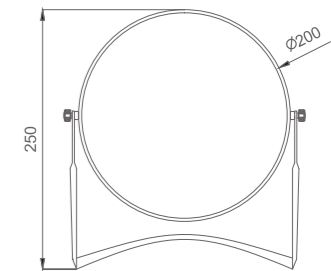

HSY-4021



镜面尺寸
Mirror Size **Ø150** H180mm

净重(只)
NW(SETS) 0.52KGS

毛重(箱)
GW(CTN) 14.4KGS

装箱数
Quantity 20SETS

普通包装
Normal Packing 410x390X420mm

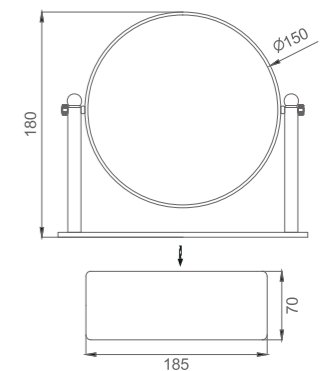

HSY-4022



镜面尺寸
Mirror Size **Ø200**
H250mm

净重(只)
NW(SETS) 0.52KGS

毛重(箱)
GW(CTN) 14.4KGS

装箱数
Quantity 20SETS

普通包装
Normal Packing 410x390x420mm

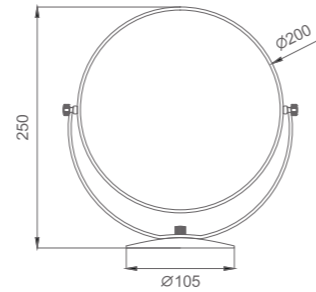

HSY-4023



镜面尺寸/Mirror Size
Ø150 **Ø200**
H220mm H260mm

净重(只)/NW(SETS)
0.46KGS 0.64KGS

毛重(箱)/GW(CTN)
12.2KGS 16.5KGS

装箱数/Quantity
20SETS 20SETS

普通包装/Normal Packing
450x240x470mm 480x310x480mm

泡沫包装/Foam Packing
590x350x700mm 590x350x700mm

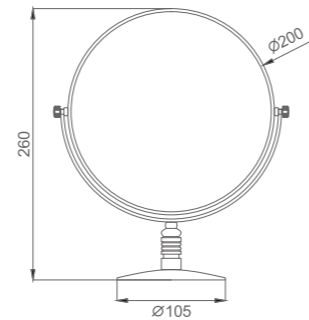

HSY-4024



镜面尺寸/Mirror Size
Ø150 **Ø200**
H220mm H260mm

净重(只)/NW(SETS)
0.38KGS 0.56KGS

毛重(箱)/GW(CTN)
10.6KGS 14.9KGS

装箱数/Quantity
20SETS 20SETS

普通包装/Normal Packing
450x240x470mm 480x310x480mm

泡沫包装/Foam Packing
590x350x700mm 590x350x700mm

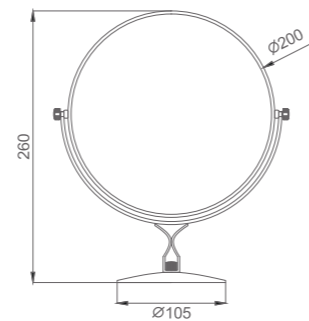

HSY-4025



镜面尺寸/Mirror Size
Ø150 **Ø200**
H220mm H260mm

净重(只)/NW(SETS)
0.5KGS 0.68KGS

毛重(箱)/GW(CTN)
13.7KGS 17.3KGS

装箱数/Quantity
20SETS 20SETS

普通包装/Normal Packing
480x310x480mm 480x310x480mm

泡沫包装/Foam Packing
770x405x575mm 770x405x575mm

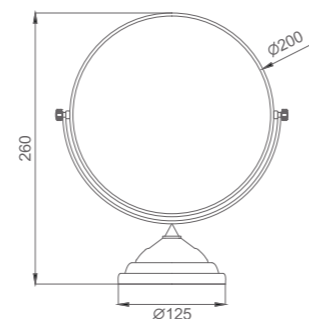

HSY-4026



镜面尺寸/Mirror Size
Ø150 **Ø200**
H220mm H260mm

净重(只)/NW(SETS)
0.5KGS 0.68KGS

毛重(箱)/GW(CTN)
13.7KGS 17.3KGS

装箱数/Quantity
20SETS 20SETS

普通包装/Normal Packing
610x310x540mm 760x410x620mm

泡沫包装/Foam Packing
590x350x700mm 590x350x700mm

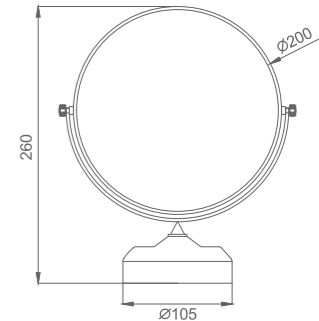

HSY-4027



镜面尺寸
Mirror Size L150xW200mm
H280mm

净重(只)
NW(SETS) 0.67KGS

毛重(箱)
GW(CTN) 17.1KGS

装箱数
Quantity 20SETS

普通包装
Normal Packing 480x310x480mm

泡沫包装
Foam Packing 770x405x575mm

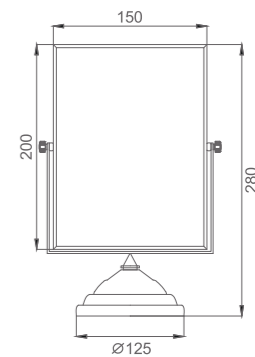

HSY-4028



镜面尺寸
Mirror Size L150xW200mm
H270mm

净重(只)
NW(SETS) 0.96KGS

毛重(箱)
GW(CTN) 14.6KGS

装箱数
Quantity 10SETS

普通包装
Normal Packing 590x350x360mm

泡沫包装
Foam Packing 395x405x575mm

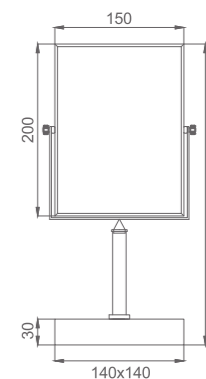

HSY-4029



镜面尺寸
Mirror Size L150xW200mm
H280mm

净重(只)
NW(SETS) 0.66KGS

毛重(箱)
GW(CTN) 17.2KGS

装箱数
Quantity 20SETS

珍珠棉包装
EPE Packing 590x350x700mm

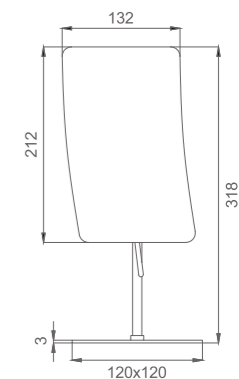

HSY-4030



镜面尺寸 Mirror Size L150xW200mm
H350mm
净重(只) NW(SETS) 1.2KGS
毛重(箱) GW(CTN) 17KGS
装箱数 Quantity 10SETS
普通包装 Normal Packing 590x350X360mm
泡沫包装 Foam Packing 395x405X575mm

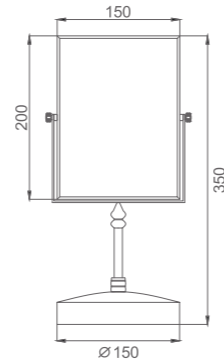

HSY-4031



镜面尺寸 Mirror Size L150xW200mm
H350mm
净重(只) NW(SETS) 0.8KGS
毛重(箱) GW(CTN) 13KGS
装箱数 Quantity 10SETS
普通包装 Normal Packing 590x350X360mm
泡沫包装 Foam Packing 395x405X575mm

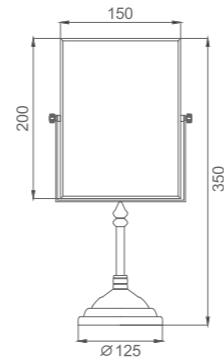

HSY-4032



镜面尺寸 Mirror Size L150xW200mm
H350mm
净重(只) NW(SETS) 0.92KGS
毛重(箱) GW(CTN) 14.2KGS
装箱数 Quantity 10SETS
普通包装 Normal Packing 590x350X360mm
泡沫包装 Foam Packing 395x405X575mm

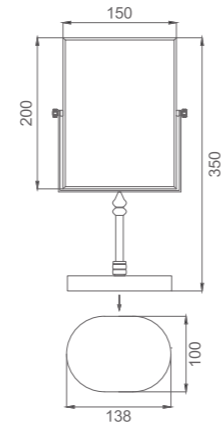

HSY-4033



镜面尺寸 Mirror Size L150xW200mm
H350mm
净重(只) NW(SETS) 1KGS
毛重(箱) GW(CTN) 15KGS
装箱数 Quantity 10SETS
普通包装 Normal Packing 590x350X360mm
泡沫包装 Foam Packing 395x405X575mm

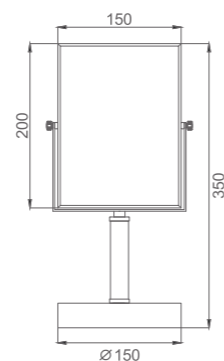

SOAP DISPENSER

皂液器系列

清晰的设计极具个性，
精心设计的细节反映出公司
的制造理念，始终注重对
当今生活的诠释和贴近。

The clean design characterized
by high personality and carefully
planned details reflects the
productive philosophy of a company
always able to interpret and comply
with current life style.

HSY-5001		尺寸/容量 Size/Volume	190x64x70mm 500ml	
		净重(只) NW(SETS)	0.18KGS	
		毛重(箱) GW(CTN)	11.6KGS	
		装箱数 Quantity	50SETS	
		普通包装 Normal Packing	430X378X420mm	

HSY-5002		尺寸/容量 Size/Volume	190x120x70mm 500ml	
		净重(只) NW(SETS)	0.48KGS	
		毛重(箱) GW(CTN)	10.8KGS	
		装箱数 Quantity	24SETS	
		普通包装 Normal Packing	455X350X425mm	

HSY-5003		尺寸/容量 Size/Volume	190x120x70mm 500mlx2	
		净重(只) NW(SETS)	0.48KGS	
		毛重(箱) GW(CTN)	13.9KGS	
		装箱数 Quantity	24SETS	
		普通包装 Normal Packing	442X343X480mm	

HSY-5004		尺寸/容量 Size/Volume	86x76x191mm 500ml	
		净重(只) NW(SETS)	0.24KGS	
		毛重(箱) GW(CTN)	17.6KGS	
		装箱数 Quantity	60SETS	
		普通包装 Normal Packing	445X400X625mm	

HSY-5005		尺寸/容量 Size/Volume	86x153x191mm 500ml x2	
		净重(只) NW(SETS)	0.48KGS	
		毛重(箱) GW(CTN)	17.8KGS	
		装箱数 Quantity	30SETS	
		普通包装 Normal Packing	445X400X625mm	

HSY-5006		尺寸/容量 Size/Volume	227x180x80mm 500ml	
		净重(只) NW(SETS)	0.22KGS	
		毛重(箱) GW(CTN)	18.8KGS	
		装箱数 Quantity	60SETS	
		普通包装 Normal Packing	600X490X480mm	

HSY-5007		尺寸/容量 Size/Volume	190x64x70mm 500ml x2	
		净重(只) NW(SETS)	0.44KGS	
		毛重(箱) GW(CTN)	18.8KGS	
		装箱数 Quantity	30SETS	
		普通包装 Normal Packing	600X490X480mm	

HSY-6001		尺寸 Size	∅92xTH200mm	
		净重(只) NW(SETS)	0.2KGS	
		毛重(箱) GW(CTN)	23.4KGS	
		装箱数 Quantity	100SETS	
		普通包装 Normal Packing	495x315X395mm	

HSY-6002		尺寸 Size	L93xW93xTH35mm	
		净重(只) NW(SETS)	0.2KGS	
		毛重(箱) GW(CTN)	23.4KGS	
		装箱数 Quantity	100SETS	
		普通包装 Normal Packing	495x315X395mm	

HSY-6003		尺寸 Size	L86xW86xTH45mm	
		净重(只) NW(SETS)	0.2KGS	
		毛重(箱) GW(CTN)	23.4KGS	
		装箱数 Quantity	100SETS	
		普通包装 Normal Packing	495x315X395mm	

包装尺寸对应表

Packing size corresponding to the table

外箱尺寸/SIZE	内盒尺寸/INNER BOX	装箱数/QTY	包装方式/PACKING
315x240x245mm	115x115x25mm	10SETS	普通Normal
380x310x380mm	185x180x30mm	40SETS	普通Normal
390x310x620mm	305x300x35mm	20SETS	普通Normal
395x365x540mm	350x260x35mm	20SETS	普通Normal
410x390x420mm	200x190x80mm	20SETS	普通Normal
430x315x320mm	305x300x35mm	10SETS	普通Normal
440x350x530mm	195x23x60mm	20SETS	普通Normal
450x240x470mm	225x225x45mm	20SETS	普通Normal
480x310x480mm	300x230x45mm	20SETS	普通Normal
500x500x520mm	500x235x160mm	6SETS	普通Normal
535x340x490mm	260x235x65mm	20SETS	普通Normal
565x475x490mm	220x220x115mm	20SETS	普通Normal
610x310x625mm	300x150x120mm	20SETS	普通Normal
630x350x360mm	345x335x55mm	10SETS	普通Normal
640x340x490mm	310x235x65mm	20SETS	普通Normal
610x310x540mm	120x150x260mm	20SETS	普通Normal
760x410x620mm	200x150x300mm	20SETS	普通Normal
380x370x620mm	295x355x70mm	10SETS	普通Normal 泡沫Foam 珍珠棉 EPE
395x405x575mm	395x275x75mm	10SETS	泡沫Foam
410x385x650mm	380x315x75mm	10SETS	泡沫Foam
475x420x630mm	400x305x90mm	10SETS	泡沫Foam
590x350x360mm	345x335x55mm	10SETS	泡沫Foam 普通Normal
590x350x700mm	345x335x55mm	20SETS	泡沫Foam
720x300x590mm	285x285x140mm	10SETS	泡沫Foam
770x405x575mm	395x275x75mm	20SETS	泡沫Foam
830x420x590mm	405x285x165mm	10SETS	泡沫Foam 珍珠棉 EPE
935x435x645mm	425x310x185mm	10SETS	泡沫Foam
580x400x520mm	395x255x115mm	10SETS	珍珠棉 EPE