

# SOLDERLESS TERMINALS

Nylon Insulated • Our Finest

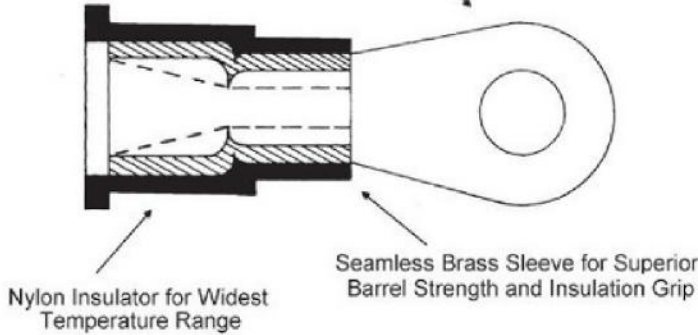





## Nylon Insulated with Insulation Grip

Highest Grade Electrolytic  
Copper Body...Tin Plated to  
Resist Corrosion





- Superior vibration resistance with insulated grip
- Superior barrel strength
- Constructed to meet the highest military and industrial standards

## 22-18 Gauge Wire Range (Red)

Actual Size	Stud Size	Part No.	Unit Pkg.
	#4 - #6	12149	25
	#8 - #10	12150	25
	#12 - 1/4"	17041	50
	#8 - #10	12163	25
	#4 - #6	12164	25
	Butt Connector	5791 16487	50 1000

## 16-14 Gauge Wire Range (Blue)

Actual Size	Stud Size	Part No.	Unit Pkg.
	#4 - #6	9052	25
	#8 - #10	9055	25
	#12 - 1/4"	9056	25

## 16-14 Gauge Wire Range (Blue)

Actual Size	Stud Size	Part No.	Unit Pkg.
	1/4" - 5/16"	9057	25
	5/16" - 3/8"	9058	25
	#4 - #6	9059	25
	#8 - #10	9060	25
	#8 - #10	9064	25
	Butt Connector	5792 16488	50 1000
	1/4" Female Quick Connect	12148	25
	1/4" Male Quick Connect	12147	25

## 12-10 Gauge Wire Range (Yellow)

Actual Size	Stud Size	Part No.	Unit Pkg.
	#8 - #10	12151	25
	#12 - 1/4"	12152	25
	5/16" - 3/8"	12153	25
	#8 - #10	12162	25
	Butt Connector	5793 16489	50 500

# SOLDERLESS TERMINALS

Vinyl Insulated • Copper • Electro Tin Plated

For an assortment of Solderless Terminals see the Fix-Kits in the green pages

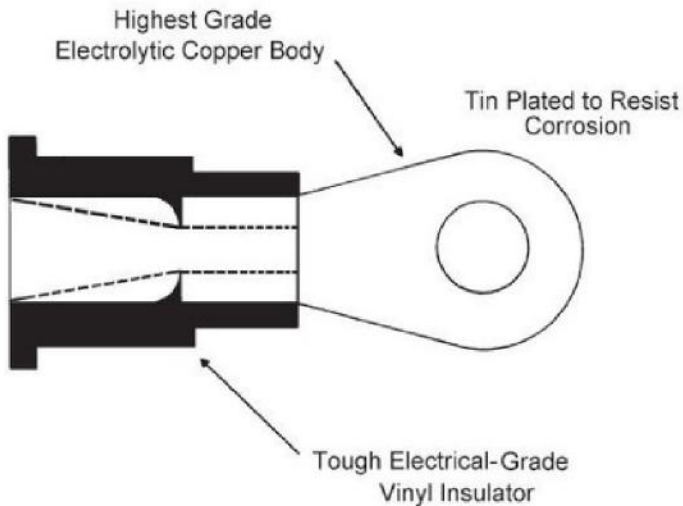



- Funnel barrel for easy wire insertion
- Friction groove in barrel resists wire pullout
- Heat treated for maximum strength







## 22-18 Gauge Wire Range (Red)

Actual Size	Stud Size	Part No.	Unit Pkg.
	#4 - #6	5021	100
	#8 - #10	5023	100
	#12 - 1/4"	17040	50
	#4 - #6	5033	100
	#8 - #10	5034	100
	#4 - #6	5038	100
	Butt Connector	5047 16484	100 1000
	Closed End Butt Connector 22-14 Ga.	9065	100





## 16-14 Gauge Wire Range (Blue)

Actual Size	Stud Size	Part No.	Unit Pkg.
	#4 - #6	5024	100
	#8 - #10	5026	100

## 16-14 Gauge Wire Range (Blue)

Actual Size	Stud Size	Part No.	Unit Pkg.
	#12 - 1/4"	5027	100
	5/16" - 3/8"	12144	25
	#4 - #6	5035	100
	#8 - #10	5036	100
	#8 - #10	5040	100
	Butt Connector	5048 16485	100 1000
	Closed End Butt Connector 16-10 Ga.	5072	100

## 12-10 Gauge Wire Range (Yellow)





Actual Size	Stud Size	Part No.	Unit Pkg.
	#8 - #10	5028	100
	#12 - 1/4"	5029	100
	1/4" - 5/16"	5030	100
	5/16" - 3/8"	5031	100
	7/16" - 1/2"	5032	100

# SOLDERLESS TERMINALS

Vinyl Insulated • Copper - Electro Tin Plated

For an assortment of Solderless Terminals see the Fix-Kits in the green pages

## 12-10 Gauge Wire Range (Yellow)

Actual Size	Stud Size	Part No.	Unit Pkg.
	#8 - #10	5037	100
	#8 - #10	5041	100
	Butt Connector	5049 16486	100 500
	3-Way Connector	5056	25



## 8 Gauge Wire Range (Red)

Actual Size	Stud Size	Part No.	Unit Pkg.
	#12 - 1/4"	17042	25
	1/4" - 5/16"	17043	25
	5/16" - 3/8"	17044	25
	7/16" - 1/2"	17045	15
	Butt Connector	17037	10

## 6 Gauge Wire Range (Blue)

Actual Size	Stud Size	Part No.	Unit Pkg.
	#12 - 1/4"	17046	15
	1/4" - 5/16"	17047	15
	5/16" - 3/8"	17048	15
	7/16" - 1/2"	17049	10
	Butt Connector	17038	10

## 4 Gauge Wire Range (Yellow)

Actual Size	Stud Size	Part No.	Unit Pkg.
	5/16" - 3/8"	17052	10
	Butt Connector	17039	10

# SOLDERLESS TERMINALS

## Quick-Connect Terminals

1/4" Female Terminals Vinyl Insulated

Actual Size	Wire Size	Part No.	Unit Pkg.
 Red	22-18 Ga.	12155	25
 Blue	16-14 Ga.	5068	100
 Yellow	12-10 Ga.	12157	25

## Quick-Connect Terminals

Fully Insulated Nylon  
Mating 1/4" Quick-Connects

Actual Size	Wire Size	Part No.	Unit Pkg.
	22-18 Ga. Female Red	11827	50
	22-18 Ga. Male Red	11828	50
	16-14 Ga. Female Blue	11606	50
	16-14 Ga. Male Blue	11605	50
	12-10 Ga. Female	11829	25
	12-10 Ga. Male Yellow	11830	25



## Quick-Connect Terminals

1/4" Male Tabs • Vinyl Insulated

Actual Size	Wire Size	Part No.	Unit Pkg.
 Red	22-18 Ga.	12154	25
 Blue	16-14 Ga.	5067	100
 Yellow	12-10 Ga.	12156	25



## Quick-Connect Terminals

.187 (3/16") Sizes • Vinyl Insulated

Actual Size	Wire Size	Part No.	Unit Pkg.
	22-18 Ga. Male	17462	25
	22-18 Ga. Female	12159	25
	16-14 Ga. Male, Blue	12165	25
	16-14 Ga. Female, Blue	8781	50

## Piggyback Terminals

1/4" Female • Fully Insulated Nylon

Actual Size	Wire Range	Part No.	Unit Pkg.
	22-18 Ga. 1/4" Tab Std. Barrel Red	19298	15
	16-14 Ga. 1/4" Tab Std. Barrel Blue	19299	15



## Fully Insulated Tap Disconnect

Mates with 11828, 11605 & 11830

Wire Range	Part No.	Unit Pkg.
22-18 Ga. (Red)	12791	10
18-14 Ga. (Blue)	12161	10
12 Ga. (Yellow)	14898	100
	12792	10

Fully insulated connectors are for tapping into a line without stripping the insulation. No special tools are required.

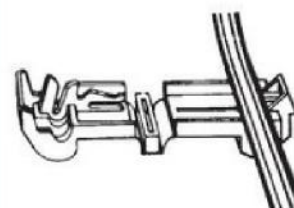

Place wire to be tapped in locating notch. Then close with pliers.

Complete connection with fully insulated male terminal:  
11828 (22-18 Ga.),  
11605 (16-14 Ga.) or  
11830 (12 Ga.)

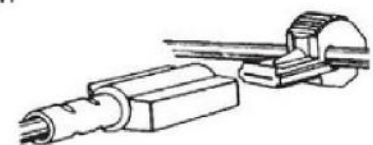

# SOLDERLESS TERMINALS



**12158**  
Vinyl Insulated  
Specialty Terminal  
Wire Range: 1/4" Tab  
Gauge: 16-14  
UNIT PACKAGE: 25



**17686**  
Mini Fuse Blade Type Fuse Tap  
For tapping "hot side" of  
mini fuse type fuse block  
Refer to page 234  
UNIT PACKAGE: 50



**14474**  
Blade Type Fuse Tap  
For tapping "hot side" of fuse block  
Refer to page 173  
UNIT PACKAGE: 25



**11405**  
Fuse Block Accessory Clip  
For add-on electrical equipment  
UNIT PACKAGE: 50

# SNAP PLUGS AND CONNECTORS

## Snap Plugs • 22-18 Gauge Universal • .157" Diameter

Actual Size	Description	Part No.	Unit Pkg.
	Vinyl Insulated	<b>11604</b>	50
	Insulated Crimp-on Female	<b>10720</b>	10

Mates with 11604

## Snap Plugs • 16-14 Gauge Universal • .157" Diameter Use with 10719 Connector

Actual Size	Description	Part No.	Unit Pkg.
	Vinyl Insulated	<b>5063</b>	100
	Nylon Insulated	<b>12146</b>	25

## Snap Plugs • 16-14 Gauge Ford (American & Lucas) • .176" Dia. Use with 11602 Connector

Actual Size	Description	Part No.	Unit Pkg.
	Vinyl Insulated	<b>5062</b>	100

## Fully Insulated Crimp-On Female (.157")

Actual Size	Description	Part No.	Unit Pkg.
	Nylon	<b>10719</b>	10
	16-14 Ga.	<b>17494</b>	25

Mates with 5063 & 12146

## Fully Insulated Crimp-on Female (.176")

Actual Size	Description	Part No.	Unit Pkg.
	Nylon	<b>11602</b>	25
	16-14 Ga.	<b>17493</b>	50

Mates with 5062 & 12145

## Snap Plug Tap-Disconnect Use Universal Snap Plugs (left column)

Actual Size	Description	Part No.	Unit Pkg.
	18-14 Ga.	<b>10319</b>	10



## Dual Male-Female Adapter

Actual Size	Description	Part No.	Unit Pkg.
	Converts .250" x .032" Male Tab to 2 Male Tabs	<b>8009</b>	100
	Converts .250" x .032" Male Tab to 2 Male Tabs	<b>8788</b>	25

# KRIMP & SEAL TERMINALS

Special polyolefin tubing when heated terminal shrinks with a 3-1 ratio to completely seal entire connection, making penetration by any foreign material impossible.







## 24-22 Gauge Wire Range (Clear)

Actual Size	Wire Size	Part No.	Unit Pkg.
	Butt Connector	21317	10





## 22-18 Gauge Wire Range (Red)

Actual Size	Wire Size	Auveco Part No.	Unit Pkg.
	#6	13656	10
	#10	13657	10
	Butt Connector	13659 19258	10 25
	.250" Female	13660	10
	.250" Male	13661	10
	#10	13658	10







## 16-14 Gauge Wire Range (Blue)

Actual Size	Wire Size	Part No.	Unit Pkg.
	#6	13662	10
	#10	13663	10
	1/4"	13664	10
	5/16"	13665	10
	3/8"	13666	10
	Butt Connection	13669 19259	10 25

## 16-14 Gauge Wire Range (Blue)

Actual Size	Wire Size	Part No.	Unit Pkg.
	.157"	13681	10
Mates with 13682			
	.157"	13682	10
Mates with 13681			
	.250"	13670	10
	.250"	13671	10
	.250" Female	13672 19260	10 25
	.250" Male	13673 19261	10 25

## 12-10 Gauge Wire Range (Yellow)

Actual Size	Wire Size	Part No.	Unit Pkg.
	#10	13674	10
	1/4"	13675	10
	3/8"	13676	10
	Butt Connector	13678 19262	10 25
	#10	13677	10
	.250" Female	13679	10
	.250" Male	13680	10

# SEALED CRIMP & SOLDER TERMINALS & CONNECTORS

Crimped for mechanical reliability, soldered for superior strength and conductivity, and sealed with heat shrink tubing for maximum durability.

### Crimp Connector

- Crimp indicators show where the installation tool should be positioned
- Wire-stops in butt connectors prevent over-insertion of the wire
- Window in the connector allows for visual inspection & solder to flow into

### Solder

- Flux coating to clean metal surfaces
- Low-temperature solder alloy for ease of installation
- Pre-measured solder to provide the right amount of solder ensuring a solid termination







### Heat Shrink Tubing

- Adhesive lined polyolefin to seal the connection
- Translucent tubing to allow for visual inspection

## 24-22 Gauge Wire Range (Clear)

Actual Size	Wire Size	Part No.	Unit Pkg.
	Butt Connector	<b>21002</b>	10





## 20 - 18 Gauge Wire Range (Red)

Actual Size	Wire Size	Part No.	Unit Pkg.
	#8	<b>21260</b>	10
	#10	<b>21261</b>	10
	1/4"	<b>21262</b>	10
	5/16"	<b>21263</b>	10
	3/8"	<b>21264</b>	10
	1/4" Female Slip-On	<b>21278</b>	10
	1/4" Male Slip-On	<b>21279</b>	10
	Butt Connector	<b>21003</b>	10
	24 - 22 Ga. to 20 - 18 Ga. Step down butt connector	<b>21275</b>	10

## 16 - 14 Gauge Wire Range (Blue)





Actual Size	Wire Size	Part No.	Unit Pkg.
	#8	<b>21265</b>	10
	#10	<b>21266</b>	10
	1/4"	<b>21267</b>	10
	5/16"	<b>21268</b>	10
	3/8"	<b>21269</b>	10
	1/4" Female Slip-On	<b>21280</b>	10
	1/4" Male Slip-On	<b>21281</b>	10
	Butt Connector	<b>21004</b>	10
	20-18 Ga. to 16-14 Ga. Step down butt connector	<b>21276</b>	10

## 12 - 10 Gauge Wire Range (Yellow)

Actual Size	Wire Size	Part No.	Unit Pkg.
	#8	<b>21270</b>	10
	#10	<b>21271</b>	10
	1/4"	<b>21272</b>	10
	5/16"	<b>21273</b>	10

# TERMINALS & CONNECTORS

## Sealed Crimp & Solder Terminals Continued 12 - 10 Gauge Wire Range (Yellow)

Actual Size	Wire Size	Part No.	Unit Pkg.
	3/8"	21274	10
	1/4" Female Slip-On	21282	10
	1/4" Male Slip-On	21283	10
	Butt Connector	21005	10
	16-14 Ga. to 12-10 Ga. Step down butt connector	21277	10

## Moisture Resistant Nylon Insulated Butt Connectors

Protect electrical connections from corrosive environments: road chemicals, salt spray, etc. Insert wire and crimp twice (electrical and mechanical) at each end. No need for heat or chemicals.

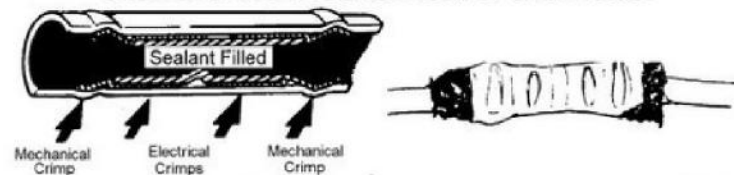

Part No.	Wire Range	Color	Unit Pkg.
13683	22-18 Ga.	Red	10
13684	16-14 Ga.	Blue	10
13685	12-10 Ga.	Yellow	10

## Heat-Shrinkable, Solder-Type Closed-End Connector

Heat-shrinkable thermoplastic sleeve containing a spiral wound copper insert that is fitted with a pre-fluxed solder band. Easy installation: Insert stripped wires, then twist slightly. Twisting causes the copper insert to tightly grip, compress and hold the wires together. Apply heat.



**18716**

Insulated & Sealed Closed-End Connector

Color Code: Green



Wire Range: 22-14 Gauge

Minimum Combination: 3 22 Gauge







Maximum Combination: 1 14 Gauge & 1 22 Gauge

UNIT PACKAGE: 10

## Solderless Terminals Non-Insulated 22-18 Gauge Wire Range

Actual Size	Wire Size	Part No.	Unit Pkg.
	#4-#6	5000	100
	#8-#10	5002	100
	Butt Connector	5044	100

## 16-14 Gauge Wire Range

Actual Size	Wire Size	Part No.	Unit Pkg.
	#4-#6	5003	100
	#8-#10	5005	100
	#12-1/4"	5006	100
	#4-#6	5014	100
	#8-#10	5015	100
	Butt Connector	5045	100

## 16-14 Gauge Wire Range High Temperature





Actual Size	Wire Size	Part No.	Unit Pkg.
	#8-#10	17491	50
	#12-1/4"	17492	50
	.187" Female	10724	25
	1/4" Female	5066	100
	1/4" Male	17490	50



# SOLDERLESS TERMINALS

Non-Insulated

## 12-10 Gauge Wire Range

Actual Size	Wire Size	Part No.	Unit Pkg.
	#8-#10	5007	100
	#12-1/4"	5008	100
	5/16"	5009	100
	3/8"	5010	100
	Butt Connector	5046	100

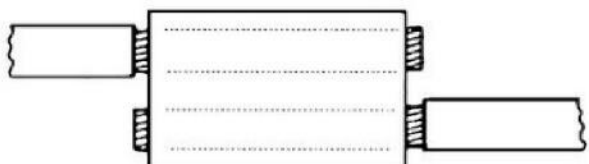

## Parallel Connectors (Fusible Link Connectors)

Actual Size	Wire Size	Part No.	Unit Pkg.
	16-14 Ga.	12630	100
	12-10 Ga.	12631	50





Parallel Connectors Proper Wire Insertion



## Splice Clips

Actual Size	Wire Size	Part No.	Unit Pkg.
	Max. of 3 #16 Ga.	18952	50
	Max of 3 #12 Ga.	22341	25





## 8 Gauge Wire Range

Actual Size	Wire Size	Auveco Part No.	Unit Pkg.
	1/4"	15158	25
	5/16"	15159	25



## 8 Gauge Wire Range

Actual Size	Wire Size	Part No.	Unit Pkg.
	3/8"	15160	25
	1/2"	15161	25

## 6 Gauge Wire Range

Actual Size	Wire Size	Part No.	Unit Pkg.
	1/4"	15162	25
	5/16"	15163	25
	3/8"	15164	25
	1/2"	15165	25

## 4 Gauge Wire Range

Actual Size	Wire Size	Part No.	Unit Pkg.
	1/4"	15166	10
	5/16"	15167	10
	3/8"	15168	10

# SOLDERLESS TERMINALS

## Tap Splice Electrical Connectors



Make quick, reliable pre-insulated tap splices, in-line splices, pass-through connections and pigtail connections without stripping, twisting, soldering or using special tools.

Easy to use:

- Open the connector making sure the piercing barb is clear of the wire channels.
- Insert unstripped wires in the proper channels.
- Use pliers to squeeze down the piercing barb until the top is flush with the connector body.
- Close the hinged cover so it locks securely.

Part No.	Wire Size	Color	Unit Pkg.
17036	22-18 Ga.	Red	25
9481	18-14 Ga.	Blue	25
14896	18-14 Ga.	Blue	100
14897	18-14 Ga.	Blue	500



### 10385 Tan

Heavy duty self-stripping connector designed for 14, 16, 18 gauge wire connected on to 10 or 12 gauge automotive wire. Ideal for over the road equipment where tap, in-line, and pigtail splices are required.

UNIT PACKAGE: 10



### 10386 Yellow

Designed exclusively for 10 or 12 gauge splicing on heavy duty vehicle wiring. Tap, in-line, and pigtail splices made quick and easy with this self-stripping connector.

UNIT PACKAGE: 10



### 10319

Bullet receptacle connector for use with 18-14 gauge wire.



Place wire to be tapped into connector channel, snap body together and lock into place with pliers.

UNIT PACKAGE: 10

## Moisture-Resistant Tap Connector

Tap connector with patented application system forces protective gel around the wire and element, providing a moisture-resistant barrier to destructive substances such as salt water and other corrosive environments. Withstands continuous operating temperatures of -40°C to 75°C (-40°F to 167°F).

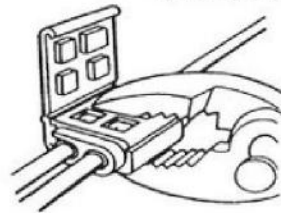

Part No.	Wire Size	Color	Unit Pkg.
17360	18-14 Ga.	Blue	50

## Electrical Connectors



Fully insulated connector for tapping into a line without stripping the insulation. No special tools are required.

Place wire to be tapped in locating notch. Then close with pliers.

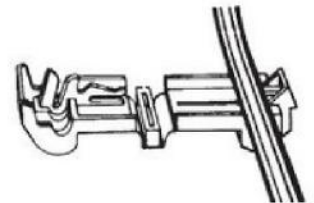

insulated male terminal:  
11828 (22-18 Gauge),  
11605 (16-14 Gauge) or  
11830 (12 Gauge)

Part No.	Wire Size	Color	Unit Pkg.
12791	22-18 Ga.	Red	10
12161	18-14 Ga.	Blue	10
14898	18-14 Ga.	Blue	100
12792	12 Ga.	Yellow	10



### 14920 With Sealant

Self-stripping connector for making 2 or 3 wire pigtail connections with a wire range of 22-14 gauge.

Simply insert 2 or 3 unstripped wires completely into the connector. Hold a crimping tool perpendicular to the wires and make the connection by driving the cap down. For use to 600V maximum.

UNIT PACKAGE: 10

# O.E.M. SHELLS

GM Weather Pack Series • *Photos not actual size*



**15949**  
(12010996)  
Nylon

Single Cavity Shroud  
Mates with 15950

UNIT PACKAGE: 25



**15953**  
(12010717)  
Nylon

Triple Cavity Shroud  
Mates with 15954

UNIT PACKAGE: 15



**18147**  
(12015798)  
Nylon

4 Cavity Square Tower  
Mates with 18148

UNIT PACKAGE: 5



**15950**  
(12015791)  
Nylon

Single Cavity Tower  
Mates with Auveco 15949

UNIT PACKAGE: 25



**15954**  
(12015793)  
Nylon

Triple Cavity Tower  
Mates with 15953

UNIT PACKAGE: 15



**18148**  
(12015024)  
Nylon

4 Cavity Square Shroud  
Mates with 18147

UNIT PACKAGE: 5



**15951**  
(12010973)  
Nylon

Double Cavity Shroud  
Mates with 15952

UNIT PACKAGE: 25



**18145**  
(12015797)  
Nylon

4 Cavity Flat Tower  
Mates with 18146

UNIT PACKAGE: 5



**18149**  
(12034342)  
Nylon

5 Cavity Round Tower  
Mates with 18150

UNIT PACKAGE: 2



**15952**  
(12015792)  
Nylon

Double Cavity Tower  
Mates with 15951

UNIT PACKAGE: 25



**18146**  
(12010974)  
Nylon

4 Cavity  
Flat Shroud  
Mates with 18145

UNIT PACKAGE: 5



**18150**  
(12065158)  
Nylon

5 Cavity  
Round Shroud  
Mates with 18149

UNIT PACKAGE: 5



**18151**  
(12015799)  
Nylon

6 Cavity Flat Tower  
Mates with 18152

UNIT PACKAGE: 3

# O.E.M. SHELLS

GM Weather Pack Series • *Photos not actual size*



**18152**

(12010975)

Nylon

6 Cavity Flat Shroud  
Mates with 18151

UNIT PACKAGE: 5

**14462**

(12014012)



Weather Pack Terminal Extractor Tool  
Designed for extracting Weather Pack terminals from their connector housing. Slide the hollow shaft of the tool over the retention barbs of the terminal. Then pull the terminal out of its shell.

UNIT PACKAGE: 1

# O.E.M. TERMINALS

GM Weather Pack Series

Male Terminals are used with Shrouds • Female Terminals are used with Towers



**20747**

(GM: 12089307)

Tin Plated

Gauge: 24-22  
Mates with 20748

UNIT PACKAGE: 15



**15937**

(12010182, 12124580)

Tin Plated

Gauge: 16-14  
Mates with 15948

UNIT PACKAGE: 50



**20748**

(GM: 12020801)

Tin Plated

Gauge: 24-22  
Mates with 20747

UNIT PACKAGE: 15



**18325**

(12089306, 12124587)

Tin Plated

Gauge: 12  
20 Amp Max.  
Mates with 18324

UNIT PACKAGE: 25



**14151**

(12034051, 12089188)

Tin Plated

Gauge: 20-18  
Mates with 14150

UNIT PACKAGE: 50



**18324**

(12015917, 12124581)

Tin Plated

Gauge: 12  
20 Amp Max.  
Mates with 18325

UNIT PACKAGE: 25



**14150**

(12033674, 12089040)

Tin Plated

Gauge: 20-18  
Mates with 14151

UNIT PACKAGE: 50



**20749**

(GM: 12015899)

Red Silicone

Cable Seal  
Use with 20747 & 20748

UNIT PACKAGE: 25



**15948**

(12010085, 12089305)

Tin Plated

Gauge: 16-14  
Mates with 15937

UNIT PACKAGE: 50



**14152**

(12015323)

Green Silicone

Cable seal  
Use with 14150, 14151, 15937 & 15948

UNIT PACKAGE: 50

## O.E.M. TERMINALS

GM Weather Pack Series

Male Terminals are used with Shrouds • Female Terminals are used with Towers



**18326**  
(12010293)  
Gray Silicone

Use with 14 Gauge GPT & Cross-Link  
Polyethylene Primary Wire

UNIT PACKAGE: 25



**14154**  
(12014837)

Gauge: 20-18  
Set of 14151 and 14152

UNIT PACKAGE: 25 Sets



**20618**  
(12015193)  
Blue Silicone

Use with **18324 & 18325**

UNIT PACKAGE: 25

**15921**



Repair Lead Gauge: 20-18  
Gauge Wire: 10" of 18

UNIT PACKAGE: 5



**15955**  
(12010300)  
Silicone

Cavity Plug

Used to plug empty cavities in connector shell

UNIT PACKAGE: 25

**15922**



Repair Lead Gauge: 20-18  
Gauge Wire: 10" of 18

UNIT PACKAGE: 5



**14153**  
(12014836)

Gauge: 20-18  
Set of 14150 & 14152

UNIT PACKAGE: 25 Sets

## O.E.M. TERMINALS



**15957**  
(2965142)  
Tin Plated

Gauge: 16-14  
Insulated with shell 8777  
Mates with terminal 15956

UNIT PACKAGE: 25



**8776**  
(2962987)  
Tin Plated

Gauge: 16-14  
Insulated with shell 8775  
Mates with terminal 8774

UNIT PACKAGE: 50



**15956**  
(2971962)  
Tin Plated

Gauge: 16-14  
Insulated with shell 8775  
Mates with terminal 15957

UNIT PACKAGE: 25



**17002**  
(8917283;12015878)  
Tin Plated  
Copper

Gauge: 12-10  
Insulated with shell 8775

UNIT PACKAGE: 25



**8774**  
(2084421,2962447)  
Unplated Brass

Gauge: 16-14  
Insulated with shell 8777  
Mates with terminal 8776

UNIT PACKAGE: 50



**8775**  
(2962984)

Insulates 8776 and 15956  
Mates with shell 8777

UNIT PACKAGE: 25

## O.E.M. TERMINALS



**8777**  
(2962448)

Insulates 8774 and 15957  
Mates with shell 8775

UNIT PACKAGE: 25

### GM Micro - Pack Terminals



**14883**  
(12020757)  
Tin Plated

Gauge: 20-18

UNIT PACKAGE: 10



**15924**  
(12040902)  
Tin Plated

Gauge: 22

UNIT PACKAGE: 50

### GM Pack-Con I Series Terminals



**11948**  
(8900524, 12020320)  
Tin Plated

Gauge: 16-14  
Mates with 15935

UNIT PACKAGE: 25



**15935**  
(12020347)

Gauge: 16-14  
Mates with 11948

UNIT PACKAGE: 50

### GM Pack-Con H.D. I Series Terminals



**15960**  
(12033817)  
Tin Plated

Gauge: 12-10

UNIT PACKAGE: 25

### GM Pack-Con III Series Terminals



**18650**  
(12020321)  
Brass

Gauge: 16-14

UNIT PACKAGE: 25

### GM Metri-Pack 150 Series Terminals



**18653**  
(12045773)  
Tin Plated

Gauge: 20-18

UNIT PACKAGE: 25



**15498**  
(12047581)  
Tin Plated

Gauge: 20-18  
Mates with 15497

UNIT PACKAGE: 25



**15497**  
(12047680)  
Tin Plated

Gauge: 20-18  
Mates with 15498

UNIT PACKAGE: 25



**18654**  
(12048074)  
Tin Plated

Gauge: 20-18

UNIT PACKAGE: 25



**15499**  
(GM: 12047767; Chry: 4368618)  
Tin Plated

Gauge: 20-16

UNIT PACKAGE: 25



**20212**  
(12129484)  
Tin Plated

Gauge: 18-16

UNIT PACKAGE: 15



**20213**  
(12129373)  
Tin Plated

Gauge: 22-20

UNIT PACKAGE: 15

# O.E.M. TERMINALS

## GM Metri-Pack 150.2 Pull to Seat



**20214**  
(12124075)  
Tin Plated

Gauge: 18-16

UNIT PACKAGE: 15



**20215**  
(12124076)  
Tin Plated

Gauge: 22-20

UNIT PACKAGE: 15

## GM Metri-Pack 150.1 Series Terminal



**16806**  
(12052922, 12089340)

Gauge: 20-18  
Not for use with 150.2 Series

UNIT PACKAGE: 25

## GM 56 Series Terminal



**18690**  
(2973215)  
Tin Plated

Two Gauge Leads: 16-14  
Or One Gauge Lead: 12  
Fits 5/16" Male Tab

UNIT PACKAGE: 25

## GM 59 Series Terminal



**18651**  
(2973216)  
Tin Plated

Gauge: 16-14  
Blade Size: 5/16"

UNIT PACKAGE: 25

## GM Metri-Pack 280 Series Terminal



**18659**  
(12129497)  
Tin Plated

Gauge: 16-14  
Mates with 18658

UNIT PACKAGE: 25



**14880**  
(12020116)  
Tin Plated

Gauge: 16-14  
Mates with 14881

UNIT PACKAGE: 25

## GM Metri-Pack 280 Series Terminal



**15946**  
(12034047)  
Tin Plated

Gauge: 20-18  
Mates with 15947

UNIT PACKAGE: 50



**18658**  
(12129493)  
Tin Plated

Gauge: 16-14  
Mates with 18659

UNIT PACKAGE: 25



**14881**  
(12015857)  
Tin Plated

Gauge: 16-14  
Mates with 14880

UNIT PACKAGE: 25



**15947**  
(12034046)  
Tin Plated

Gauge: 20-18  
Mates with 15946

UNIT PACKAGE: 50



**20216**  
(12015858)  
Tin Plated

Gauge: 12-10

UNIT PACKAGE: 15



**20220**  
(12186456)  
Tin Plated

Gauge: 14-12  
Mates with 20226

UNIT PACKAGE: 15



**20226**  
(12092344)  
Tin Plated

Gauge: 14-12  
Mates with 20220

UNIT PACKAGE: 15

## O.E.M. TERMINALS

## GM Metri-Pack 280 Series Terminal



**20221**  
(12186457)  
Tin Plated

Gauge: 18-16  
Mates with 20227

UNIT PACKAGE: 15



**20227**  
(12092345)  
Tin Plated

Gauge: 18-16  
Mates with 20221

UNIT PACKAGE: 15

## GM Metri-Pack 280 Series Tangless



**20217**  
(12110842)  
Tin Plated

Gauge: 14-12  
Used without cable seal

UNIT PACKAGE: 15



**20222**  
(12110845)  
Tin Plated

Gauge: 14-12  
Used with cable seal

UNIT PACKAGE: 15



**20223**  
(12129409)  
Tin Plated

Gauge: 16-14  
Used with cable seal

UNIT PACKAGE: 15



**20218**  
(12110844)  
Tin Plated

Gauge: 18-16  
Used without cable seal

UNIT PACKAGE: 15



**20224**  
(12110847)  
Tin Plated

Gauge: 18-16  
Used with cable seal

UNIT PACKAGE: 15

## GM Metri-Pack 280 Series Tangless



**20219**  
(12110843)  
Tin Plated

Gauge: 22-20  
Used without Cable seal

UNIT PACKAGE: 15



**20225**  
(12110846)  
Tin Plated

Gauge: 22-20  
Used with cable seal

UNIT PACKAGE: 15

## GM Metri-Pack 280 Fuel Injector



**20230**  
(12103360)  
Tin Plated

Gauge: 22-20

UNIT PACKAGE: 15

## GM Metri-Pack 480 Series



**15939**  
(12020120)  
Tin Plated

Gauge: 16-14  
Blade Width: 3/16"  
Mates with 15938

UNIT PACKAGE: 25



**15938**  
(12015861)  
Tin Plated

Gauge: 16-14  
Mates with 15939

UNIT PACKAGE: 25

## GM Metri-Pack 630 Series



**15944**  
(12020126)  
Tin Plated

Gauge: 16-14  
Blade Width: 1/4"  
Mates with 15945

UNIT PACKAGE: 50



# O.E.M. TERMINALS

## GM Metri-Pack 630 Series



**15945**

(12015870)  
Tin Plated

Gauge: 16-14  
Mates with 15944

UNIT PACKAGE: 50

## GM Metri-Pack 630 Pull to Seat



**20231**

(12066614)  
Tin Plated

Gauge: 16-14

UNIT PACKAGE: 15

## GM Micro-Pack 100 W Series Terminals



**20209**

(12084912)  
Gold/Nickel Plated

Gauge: 18  
Mates with Auveco 20211

UNIT PACKAGE: 10



**20211**

(12160551)  
Gold/Nickel Plated

Gauge: 18  
Mates with 20209

UNIT PACKAGE: 10



**20210**

(12084913)  
Gold/Nickel Plated

Gauge: 22-20

UNIT PACKAGE: 10

## Ford Wedgelock Pin Type Terminals



**20475**

(E7EB-14461-BA)  
Tin Plated

Gauge: 20-18  
Diameter Pin: .060"

UNIT PACKAGE: 25

## Ford Wedgelock Pin Type Terminals



**14887**

(D1AB-14461-AA)

Gauge: 20-18  
Diameter Pin: .110"  
Mates with 14888

UNIT PACKAGE: 25



**14888**

(D1AB-14488-CA)

Gauge: 20-18  
Diameter Pin: .110"  
Mates with Auveco 14887

UNIT PACKAGE: 25

## Ford Miniature Pin Type Terminals



**18853**

(E3VB-14461-AA)

Gauge: 20-18  
Diameter Pin: .062"  
Reference A-9

UNIT PACKAGE: 25

## Ford Mini Block Terminals



**16342**

(E7EB-14421-EA)

Gauge: 20-18  
Blade Width: 1/8"  
Mates with 16344

UNIT PACKAGE: 25



**16344**

(E7EB-14474-CA)

Gauge: 20-18  
For 1/8" Blade  
Mates with 16342

UNIT PACKAGE: 25

## Ford Standard Box Terminals



**16348**

(E8EB-14474-VA)  
Tin Plated

Gauge: 16-14  
For 3/16" Blade

UNIT PACKAGE: 25



**14889**

(D8BB-14474-BA, D3AB-14474-DA)

Gauge: 20-18

UNIT PACKAGE: 25

# O.E.M. TERMINALS

## Ford Terminals



**20815**

(D20B-14421-BB)

Gauge: 20-18  
Blade Width: 3/16"

Replaces **14890**

UNIT PACKAGE: 25



**20816**

(D5AB-14474-FA, D3AZ-14474-G)

Gauge: 20-18  
Replaces **14891**

UNIT PACKAGE: 25

## Chrysler Quick Connect Terminals



**16349**

(3843386)

Gauge: 16-14  
Blade Width: 1/4"

UNIT PACKAGE: 25

## Chrysler Terminals



**16801**

(7368261)

Gauge: 20-18  
Diameter Pin: 3/32"  
Male

UNIT PACKAGE: 25



**16804**

(4304729)

Gauge: 24-18  
Double Cantilever Spring Terminal  
Used with P.C. board connections & general purpose

UNIT PACKAGE: 25

# UNIVERSAL TERMINALS



**14892**

(GM: 2965470;  
Ford: C5AB-14474-B;  
Chry: 2096466)  
Unplated Brass

Gauge: 20-18  
Female: 1/4"

UNIT PACKAGE: 25



**17115**

(GM: 2962953;  
Ford: C2TB-14462A;  
Chry: 2096454)  
Bare Copper

Gauge: 12-10  
Stud Size: 3/8" (10mm)

UNIT PACKAGE: 25



**15504**

(GM: 2965580;  
Ford: C1SF-14474-A;  
Chry: 2096467)  
Unplated Brass

Gauge: 14-12  
Female: 1/4"

UNIT PACKAGE: 25



**21401**

(GM: 2984172;  
Ford: C8AB-14463N;  
Chry: 4274166)  
Tin Plated

Gauge: 16-14  
Stud Size: 1/4" (6.3mm)  
Locking Type

UNIT PACKAGE: 10

## MATE-N-LOCK TERMINALS

Commonly used in cellular phone and communication equipment installations, office machines and machine controls.



### 18855

Tin Plated Brass

Gauge: 20-14  
Diameter Pin: .084"  
Single Retention Barb  
Mates with 18856

UNIT PACKAGE: 25



### 18856

Tin Plated Brass

Gauge: 20-14  
Diameter Pin: .084"  
Single Retention Barb  
Mates with 18855

UNIT PACKAGE: 25



### 18857

Tin Plated Brass

Gauge: 20-14  
Diameter Pin: .084"  
Dual Retention Barbs  
Mates with 18858

UNIT PACKAGE: 25



### 18858

Tin Plated Brass

Gauge: 20-14  
Diameter Pin: .084"  
Dual Retention Barbs  
Mates with 18857

UNIT PACKAGE: 25

## Terminal Extractor Picks



*Photo not actual size*

Used to release most GM, Ford and Chrysler OEM terminals from their insulating shells. Not suitable for round, pin-type terminals.

### 14884

(12012000)

Narrow Blade (.050")

UNIT PACKAGE: 1

### 14885

(8913369)

Wide Blade (.090")

UNIT PACKAGE: 1

### 20583

(12094429)

Micro Terminal Extractor Pick

.035" Wide Blade used to release: 150 Metri-Pack, 280 Metri-Pack, 280 Tangless, 280 Bus Bar, 630 Pull to Seat, GT 150, GT 280, Wedge Base Light Socket terminals and indexing Candelabra Bayonet Double Contact Light Socket terminals.

UNIT PACKAGE: 1

## CRIMPING & CUTTING TOOLS

### 20901

Electrical Connector Separator

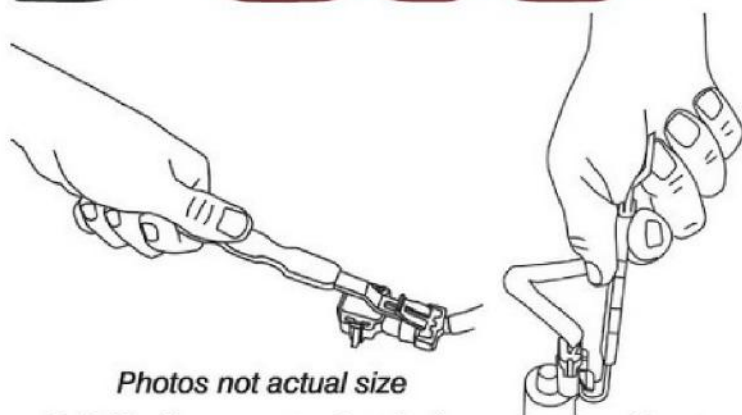

*Photos not actual size*

Quickly disconnects electrical connectors without damage. Simply engage the tool tip behind the connector locking clip and then pull or push to disconnect. The tool is double-ended to fit different access angles. Works on Weather Pack and other automotive electrical connectors.

UNIT PACKAGE: 1

### 15035

Self-Adjusting  
Wire Stripper/Crimping Tool



*Photos not actual size*

The quick and easy way to strip wire. Unique steel jaws self-adjust to strip any 26 - 10 gauge wire. Only light handle pressure is needed to make wire stripping fast and easy.

Crimps insulated and non-insulated 22 - 10 gauge and 7mm/8mm terminals

Also features precision machined blade for cutting wire sharp and smooth.

Overall Length: 8-1/4"

UNIT PACKAGE: 1

# CRIMPING & CUTTING TOOLS

*Photos not actual size*

## 21424

Wire Stripper for recessed areas



This specially designed, narrow profile tool provides easy access to limited and hard-to-reach areas.

Strips 22-12 gauge single or multiple-stranded conductor wire and automatically adjusts to the wire size. The tool has an adjustable strip length gauge and built in wire cutter.  
Lightweight and easy to use

UNIT PACKAGE: 1

## Open Barrel Terminal Crimping Tool For O.E.M. Terminals



## 16004

Duplicates factory crimps on open barrel terminals used in automotive, computer and control applications. Features five machined and hardened crimp stations for 14 to 24 gauge wire terminations. Parallel jaws eliminate faulty crimps.  
Overall Length: 8-1/2"

UNIT PACKAGE: 1

### Insulation Crimp:

Crimp Station A for 14-18 Gauge  
Crimp Station B for 20-24 Gauge

### Stripped Wire Crimp:

Crimp Station C for 14-16 Gauge  
Crimp Station D for 18-20 Gauge  
Crimp Station E for 22-24 Gauge

## 7711



Cuts and strips 22-8 gauge wire. Crimps insulated and non-insulated solderless terminals in sizes from 22-10 gauge.  
Overall Length: 9"

UNIT PACKAGE: 1

## 20751

(GM: 12014254)



Weather Pack Crimping Tool designed specifically to crimp only Weather Pack 20-18 Gauge & 16-14 Gauge Weather Pack seals and terminals in one cycle. Ratchet mechanism ensures completion of cycle.

UNIT PACKAGE: 1

## 20750

Micro Crimper  
30-16 Gauge  
Best for 24-20 Gauge



### Insulation Crimp:

Crimp Station A for 20-16 Gauge  
Crimp Station B for 30-22 Gauge

### Stripped Wire Crimp:

Use Crimp Station C for 18-16 Gauge  
Use Crimp Station D for 22-20 Gauge  
Use Crimp Station E for 30-24 Gauge

UNIT PACKAGE: 1

## 20752

(GM: 12085270)



20-14 Gauge  
Crimps most sealed GM terminals  
Ratchet mechanism ensures completion of crimp cycle

### Seal Crimp:

Crimp Station 1 for 150 Series Metri-Pack Seals  
Crimp Station 3 for 480 & 630 Series Metri-Pack Seals  
Crimp Station 5 for Weather Pack & 280 Series Metri-Pack Seals

### Stripped Wire Crimp:

Crimp Station 2 for 20-18 Gauge  
Crimp Station 4 for 16-14 Gauge

UNIT PACKAGE: 1

# CONNECTORS

## Twist-Type Wire Connectors



Color: Gray

Joins 18 & 16 Gauge Wires  
Minimum of 2 #18 Gauge Wires  
Maximum of 2 #16 Gauge Wires

**10378:** UNIT PACKAGE: 25  
**15204:** UNIT PACKAGE: 100

Color: Blue



Joins 18-14 Gauge Wires  
Minimum of 2 #18 Gauge Wires  
Maximum of 3 #16 Gauge Wires

**10379:** UNIT PACKAGE: 25  
**15205:** UNIT PACKAGE: 100

Color: Orange



Joins 18-14 Gauge Wires  
Minimum of 2 #18 Gauge Wires  
Maximum of 3 #16 Ga &  
1 #18 Gauge Wires

**10380:** UNIT PACKAGE: 25  
**15206:** UNIT PACKAGE: 100

Color: Yellow



Joins 18-12 Gauge Wires  
Minimum of 1 #14 Gauge &  
1 #18 Gauge Wires  
Maximum of 2 #14 Gauge &  
3 #16 Gauge Wires

**10381:** UNIT PACKAGE: 25  
**15207:** UNIT PACKAGE: 100

Color: Red



Joins 18-10 Gauge Wires  
Minimum of 1 #12 Gauge &  
2 #18 Gauge Wires  
Maximum of 2 #10 Gauge &  
1 #12 Gauge Wires

**10382:** UNIT PACKAGE: 25  
**15208:** UNIT PACKAGE: 100

## Twist-Type Wire Connectors

Combines both the wide range and torque of wing-style connectors with a new flexible skirt that provides over-strip protection without taking additional space in the electrical box.



**18312**

Orange & Blue

Joins from two 22 gauge  
to two 12 gauge wires

UNIT PACKAGE: 25

## Wing Twist-Type Wire Connectors



Color: Blue

Joins 14-6 Ga. Wires  
Minimum of 1 #10 Ga. & 1  
#12 Ga. Wires  
Maximum of 1 #6 Ga. & 2  
#8 Ga.

**10384** UNIT PACKAGE: 25  
**15209** UNIT PACKAGE: 50

**15705**

Yellow



Joins 22-12 Ga. Wires  
Minimum of 2 #18 Ga. Wires  
Maximum of 2 #12 Ga. Wires

UNIT PACKAGE: 50

**15706**

Red



Joins 20-8 Ga. Wires  
Minimum of 2 #16 Ga. Wires  
Maximum of 4 #12 Ga. Wires

UNIT PACKAGE: 50

## CIRCUIT TESTER

**20818**

*Photo not actual size*



Computer Safe Automotive Logic Probe

This circuit tester with its high impedance feature draws less than 7 milliamps to protect all vehicle circuits including computerized engine and body controls, sensitive electronic sensors, microprocessors, electronic ignition components and air bags. Instructions included.

For 6, 12 and 24 volt systems  
Insulated probe has an exposed length of 3-3/8"  
Includes Protect-A-Terminal® Probe Adapter to prevent  
damage to electrical connectors  
6 feet of heavy duty, 18 gauge dual leads with large  
battery clips for easy hook-up.

UNIT PACKAGE: 1

# CIRCUIT TESTER AND WIRE LOOM

**20819**

*Photo not actual size*



**Heavy Duty Circuit Tester**

An excellent quality electrical circuit tester for checking 6 and 12 volt systems. It's made to last! Has a heavy duty battery clip. 5 feet of tough, flexible, heavily insulated rubber coated wire is retained in a spring supported strain-relief design that withstands the most rugged use.

**UNIT PACKAGE: 1**

**For Troubleshooting  
DC Primary Circuits  
on 6 & 12 Volt  
Vehicles**



*Photo not actual size*

**16420**

**Use to Check:**  
Lighting Systems  
Wipers  
Horn  
Electric Clock,  
Windows, Locks  
Fuses  
Relays

**Features:**

- 4 Feet of Wire
- Mechanical Strain Relief
- Impact & Chemical Resistant Housing
- 8" Long Probe/Housing
- Super Sharp Probe, Tempered to Last
- 2" Long Alligator Clip

**UNIT PACKAGE: 1**

## WIRE LOOM

Split Flexible Tubing • Maximum Temperature of 345°F



I.D. 1/4" - O.D. 3/8"  
Nylon 6 - Black

**14197:** 10' Length  
**14201:** 50' Length (Bulk)



I.D. 3/8" - O.D. 9/16"  
Nylon 6 - Black

**14198:** 10' Length  
**14202:** 50' Length (Bulk)



I.D. 1/2" - O.D. 11/16"  
Nylon 6 - Black

**14199:** 10' Length  
**14203:** 50' Length (Bulk)



I.D. 5/8"  
O.D. 13/16"  
Nylon 6  
Black

**20536:**  
50' Length



I.D. 3/4" - O.D. 15/16"  
Nylon 6 - Black

**14200:**  
10' Length  
**14204:**  
50' Length (Bulk)



I.D. 1"  
O.D. 1-1/8"  
Nylon 6  
Black

**18194:**  
25' Length

# PRIMARY AND FUSIBLE WIRE

*Photos not actual size*



## Primary Wire

Standard PVC Insulation (SE/GPT Type)  
Suitable for most automotive applications.  
Free of stripping, abrasion resistant,  
meets most O.E.M. vehicle standards

UNIT PACKAGE: 1 Roll

The lower the gauge number, the thicker the wire  
(i.e. 10 gauge is thicker than 16 gauge)

Gauge	Stranding	Outer Diameter	Part No.				Length
			Red	White	Black	Blue	
18	16 x 30	.092	20486	20487	20488	20489	45 Ft.
16	19 x 29	.104	20490	20491	20492	20493	35 Ft.
12	19 x 25	.142	20494	20495	20496	20497	15 Ft.
10	19 x 23	.175	20498	20499	20500	20501	10 Ft.

### 25 Foot Spool

Gauge	Stranding	Outer Diameter	Part No.					
			Red	White	Black	Blue	Green	Yellow
14	19 x 27	.117	12419	12420	12421	12422	15239	15240

### 100 Foot Spool

Gauge	Stranding	Outer Diameter	Part No.						
			Red	White	Black	Blue	Green	Yellow	Brown
20	10 x 30	.085	21339	21340	21341	21342	21343	21344	21345
18	16 x 30	.092	12423	12424	12425	12426	12427	12428	15256
16	19 x 29	.104	12429	12430	12431	12432	12433	12434	15257
14	19 x 27	.117	12435	12436	12437		12439	12440	15258
12	19 x 25	.142	12441	12442	12443	12444	15259	15260	
10	19 x 23	.175	12445		12447	12448		15263	

## Spooled Fusible Link Wire

The lower the gauge number, the thicker the wire (i.e. 10 Ga. is thicker than 16 Ga.)



A fusible link is a special section of low tension cable installed by an OEM and designed to open a circuit when subjected to extreme current overload. Its purpose is to minimize wiring system damage when such an overload accidentally occurs in those circuits protected by the fusible link. A short circuit causes the fusible link to act as an element in a "slow-blow" fuse. A fusible link is not intended to be used in place of a fuse but only where a fuse cannot be economically employed. Our fusible line wire meets the requirements of SE J-156 and the insulation has the characteristics as listed for EAE, SE J-1128 Type SXL. The vehicle manufacturer should be consulted about questions on fusible link length and size. General practice has been for a fusible link to be 4 gauges smaller than the circuit wire.

*Example:* if the circuit wire is 12 gauge, use a 16 gauge fusible link.

Final determination should be based on O.E.M. application.

*Note:* Extreme care should be taken to always replace a fusible link with then same gauge and length as installed by the manufacturer.

Part No.	Gauge	Color	Length	Replaces	Unit Pkg.
15372	14	Orange	25 Ft.	GM: 6292995	1 Spool
20484	8	Black or Rust	25 Ft.		1 Spool

\*Color may vary at manufacturer's option

# FUSIBLE LINKS

*Photos not actual size*



**Universal Fusible Links**

Part No.	Gauge	Length	Replaces	Unit Pkg.
12627	18	9"	Chry: 3843392 & other 18 Ga. links	5
12628	16	9"	GM: 6292996, 8903489 Ford D3AZ-14526-E & other 16 Ga. links	5
12629	14	9"	GM: 6292995, 8903488 Ford D3AZ-14526D & other 14 Ga. links	5
17465	12	9"	GM: 6293923	5
17464	10	9"	GM: 12077140	5

## TEST CLIPS



Type 1

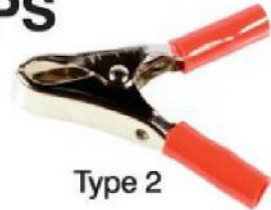

Type 2

Part No.	Type	Description	Unit Pkg.
20478	1	10 Amp, Alligator Clip, Nickel Plated, 2" Long	5
16969	2	10 Amp, Red Insulation, 2-1/4" Long	5
16970	2	10 Amp, Black Insulation, 2-1/4" Long	5
16971	2	1 Each of 16969 & 16970	1 Pair
16972	2	30 Amp, Red Insulation, 3" Long	5
16973	2	30 Amp, Black Insulation, 3" Long	5
16974	2	1 Each of 16972 & 16973	1 Pair
16975	2	50 Amp, Red Insulation, 3" Long	5
16976	2	50 Amp, Black Insulation, 3" Long	5
16977	2	1 Each of 16975 & 16976	1 Pair

## BATTERY CABLE & TERMINALS



**Battery Cable**

Bare Copper Standard Conductor, covered with tough black Polyvinyl Chloride insulation. The thick jacket is easy to strip, resistant to moisture, weather, oil and acids.

Part No.	Gauge	Stranding	O.D.	Unit Pkg.
11392	4	70 x 22.5	.380	25' Roll
13850	1/0	133 x 21	.530	25' Roll
13851	2/0	133 x 20	.590	25' Roll



**Universal Battery Terminal**

**9948**

For Positive & Negative Posts  
Cable Range 8 thru 2/0 AWG

UNIT PACKAGE: 2

### Solderless Battery Cable Terminals



Tin Plated Copper

Part No.	Cable Size	Post Size	Unit Pkg.
11360	No. 6 AWG	Universal	2
11361	No. 4 AWG	Universal	2
11362	No. 1 AWG	Positive	2
11363	No. 1 AWG	Negative	2
11364	No. 1/0 AWG	Positive	2
11365	No. 1/0 AWG	Negative	2
11366	No. 2/0 AWG	Positive	2
11367	No. 2/0 AWG	Negative	2
15858	No. 3/0 AWG	Positive	2

### Marine Battery Terminals

Lead Plated Brass Terminal  
Nickel Plated Grade 2 Steel Wing Nut  
Zinc Plated Grade 2 Steel Bolt & Nut



**8772**

For Positive Posts  
Stud: 3/8"-16

UNIT PACKAGE: 5



**8773**

For Negative Posts  
Stud: 5/16"-18

UNIT PACKAGE: 5



# BATTERY CABLE & TERMINALS

*Photos not actual size*

## Engine Ground & Bonding Strap



**19499**

Replacement for body to engine block straps. Solves light dimming problems by grounding charging system. Also reduces radio noise. Copper braided wire with tin-plated brass ring terminals.

Length: 8"

Gauge: 10

Stud Size Ring Terminal: 5/16" - 3/8"

UNIT PACKAGE: 2



## Universal Side Mount Battery Cable Terminal

**12975**

Fits all small diameter cables - both positive and negative.

UNIT PACKAGE: 2



## All Lead Terminal

**10808**

Zinc Plated Steel

Bolt & Nuts

Stud: 5/16"-18

Universal Positive & Negative

UNIT PACKAGE: 2

# COMPRESSION BATTERY CABLE TERMINALS

All clamps and lugs are made of cast copper • All clamps, lugs and fasteners are tin plated

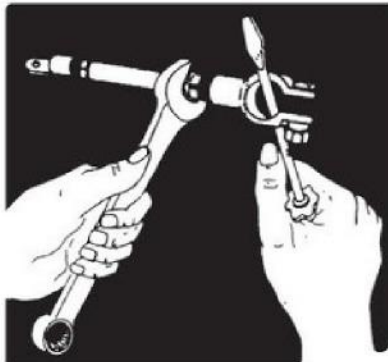

Assemble with common hand tools.

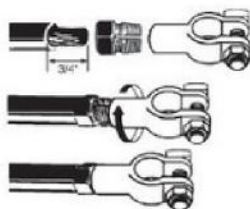

### Three Easy Steps

- Strip 3/4" of insulation from the end of the cable. Insert bared wire into the compression nut.
- Thread terminal on compression nut.
- Grip compression nut with wrench and turn the terminal until the compression nut seats. With larger gauges you may want to hold the terminal in a vise



## Straight Clamp

Part No.	Cable Gauge	Description.	Color	Unit Pkg.
15603	4	Pos.	Gray	2
15605	1&2	Pos.	Green	2
15606	1/0	Neg.	Black	2
15607	1/0	Pos.	Black	2
15608	2/0	Neg.	Orange	2
15609	2/0	Pos.	Orange	2
15610	3/0	Neg.	Purple	2
15611	3/0	Pos.	Purple	2

## Heavy Wall Copper Lug



Part No.	Cable Gauge	Hole Size	Color	Unit Pkg.
15618	4	3/8"	Gray	2
15619	1&2	3/8"	Green	2
15620	1/0	3/8"	Black	2
15621	1/0	1/2"	Black	2
15622	2/0	3/8"	Orange	2
15625	3/0	1/2"	Purple	2



## Stud/Side Terminal

Part No.	Cable Gauge	Color	Unit Pkg.
15628	1/0	Black	2



## Compression Nut



Part No.	Cable Gauge	Color	Unit Pkg.
15632	2/0	Orange	5

# BATTERY TERMINALS & TOOLS

*Photos not actual size*



**Copper Battery Cable Lugs**

Part No.	Cable Size	Stud Size	Unit Pkg.
5794	4 Ga.	3/8"	25
5796	1/0 Ga.	3/8"	25
11467	2/0 Ga.	1/2"	10

Use 7996 Crimping Tool



**Butt Connector (Double Flared)**

Pure Copper with Tin Plating

Applications: Field or shop splicing of battery cables and welding cables.

Part No.	Cable Size	Length	Unit Pkg.
11729	2/0 Ga.	1-3/4"	5



**11083**

(8917444)  
Zinc

Battery Side Terminal Bolt  
Thread Size: 3/8"-16  
Overall Length: 1-1/8"  
GM

UNIT PACKAGE: 10



**19199**

(12004188)  
Zinc

Battery Side Terminal Bolt  
Thread Size: 3/8"-16  
Overall Length: 1-3/4"  
GM

UNIT PACKAGE: 5



**13816**

Stainless Steel

Battery Hold Down Nuts  
Thread Size: 3/8-16  
Overall Length: 18/8

UNIT PACKAGE: 4



**Battery Terminal Bolt & Nut**

Zinc Chromate

Part No.	Size	Unit Pkg.
3186	5/16"-18 x 1-1/4" Bolt w/Collared Nut	100
8003	5/16"-18 x 1-1/4" Bolt W/Hex Nut	50
14974	5/16"-18 x 1-1/4" Bolt Only	50
14975	5/16"-18 Collared Nut Only	50

**Heavy Duty Battery Cable Terminal Ends for Stud-Type Batteries**

For Auto, Truck, Marine and H.D. Equipment



**Single Barrel**

Copper/Plated  
Stud Size: 3/8

Part No.	Cable Size	Unit Pkg.
13810	1/0	2
13811	2/0	2



**Double Barrel**

Copper/Plated  
Stud Size: 3/8

Part No.	Cable Size	Unit Pkg.
13814	2/0	1

## Suggested Terminal Assemblies

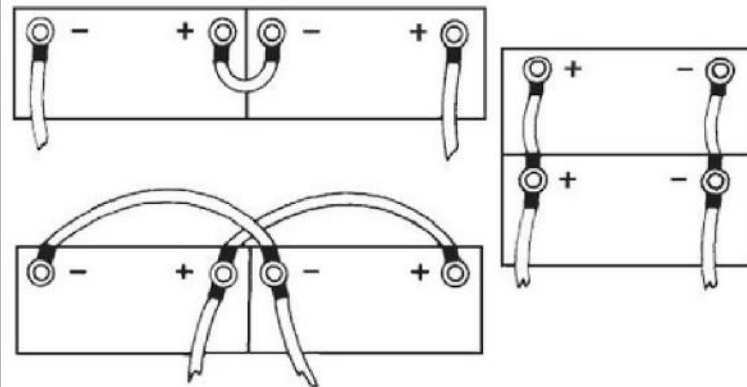

**20899**

Side Terminal Battery Cleaner

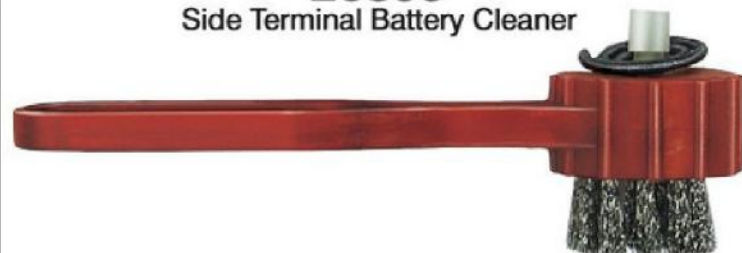

Coil spring cutters polish the battery contacts while the stainless steel brushes clean the cable terminals.

UNIT PACKAGE: 1

# BATTERY TERMINAL TOOLS

*Photos not actual size*



**20898**  
Battery Brush

Cleans dirt and corrosion from post type battery terminals and cable clamps. Made of heavy duty stainless steel wire. Case is made of high impact plastic that will not weaken in cleaning solutions.

UNIT PACKAGE: 1

**3M Vinyl Electrical Tape**  
*Made in U.S.A.*



.007" Thick x 3/4" Wide x 60 Ft. Long

**16527:** Unit Package: 5 Rolls  
**16578:** Unit Package: 15 Rolls

General purpose vinyl insulating tape with excellent resistance to abrasion, moisture, alkalis, acid, copper corrosion and varying weather conditions. Can be used as a primary electrical insulation for all wire and cable splices rated up to 600 volts.

**Linerless Self-Bonding Rubber Tape**



**14389**

.030" Thick x 3/4" Wide x 15ft. Long

UNIT PACKAGE: 1 Roll

Replace heat shrink tubing with a safe, tight, long-lasting seal that withstands temperature extremes from -50° to 300°F. No heat guns or open flames needed. No paper liner to mess with.

Tape is stretched when applied and retains its elasticity to ensure a tight seal at all points. The tape is unaffected by salt spray and common automotive fluids. As long as it is stretched when it is applied, it will not unravel after application due to its self-bonding characteristics.

**15039**  
Anti-Corrosion  
Protectant

A non-drying coating protectant, formulated especially for battery terminals and other exposed electrical connections.

UNIT PACKAGE: 1 8oz. Can

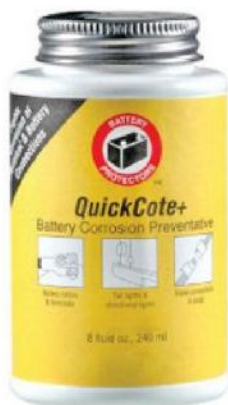

**7996**

Crimps cable range  
Gauge: 8 to 4/0  
Use with vise or hammer

UNIT PACKAGE: 1



## CIRCUIT BREAKERS

Automatic Re-Set



Type 1



Type 2



Type 3

Part No.	Type	Specifications	Unit Pkg.
<b>15046</b>	1	30 Amps at 12 Volts	5
<b>18518</b>	2	10 Amps at 12 Volts	2
<b>18519</b>	2	15 Amps at 12 Volts	2
<b>18520</b>	2	20 Amps at 12 Volts	2
<b>18521</b>	2	30 Amps at 12 Volts	2
<b>18522</b>	2	40 Amps at 12 Volts	2
<b>15048</b>	3	30 Amps at 12 Volts	5
<b>15049</b>	3	40 Amps at 12 Volts	5

# HEAT SHRINK TUBING

Made in the U.S.A. • *Photos not actual size*



## Black Thin Wall Heat Shrink Tubing

- 2 to 1 Shrink Ratio
- Cross linked Polyolefin
- Highly Flame Retardant (VW-1)

Part No.	Size	Pre-Shrink I.D.	Post-Shrink I.D.	Length	Unit Pkg.
18693	3/64"	.046"	.023"	6"	25
18694	1/16"	.063"	.031"	6"	25
18695	3/32"	.093"	.046"	6"	25
18696	1/8"	.125"	.062"	6"	25
18697	3/16"	.187"	.093"	6"	25
18698	1/4"	.250"	.125"	6"	25
18699	3/8"	.375"	.187"	6"	15
18700	1/2"	.500"	.250"	6"	15
18701	3/4"	.750"	.375"	6"	10
18702	1"	1.00"	.500"	6"	10
18703	1-1/2"	1.50"	.750"	6"	5



## Adhesive Lined Heat Shrink Tubing

- 4.5 to 1 Shrink Ratio
- Cross linked, Semi-Rigid Polyolefin Outer Jacket
- Hot-Melt Adhesive Inner Wall adheres to all major types of Wire
- Environmentally Seals & Insulates
- Meets O.E.M. Specs: Ford: ESB M99 D56 A1 Chrysler: MS-DB56

Part No.	Pre-Shrink I.D.	Post-Shrink I.D.	Length	Color	Unit Pkg.
18705	.225"	.050"	3-1/2"	Black	10
18706	.293"	.065"	3-1/2"	Black	10
18707	.427"	.095"	3-1/2"	Black	10
18708	.700"	.175"	3-1/2"	Black	5



## Adhesive Lined Dual Wall Self-Sealing Heat Shrink Tubing

- 3 to 1 Shrink Ratio
- Excellent Insulating, Abrasion-Resisting & Strain Relief Properties
- Provides Waterproofing & Environmental Protection

Part No.	Size	Pre-Shrink I.D.	Post-Shrink I.D.	Length	Color	Unit Pkg.
16665	22-14 Gauge	.188"	.062"	12"	Black	4
16666	12-10 Gauge	.250"	.083"	12"	Black	4
18733	14-10 Gauge	.400"	.150"	6"	Black	4
19102	14-10 Gauge	.400"	.150"	6"	Black	25
18734	14-10 Gauge	.400"	.150"	6"	Red	4
19103	14-10 Gauge	.400"	.150"	6"	Red	25
18735	8-1 Gauge	.750"	.220"	6"	Black	4
19104	8-1 Gauge	.750"	.220"	6"	Black	25
18736	8-1 Gauge	.750"	.220"	6"	Red	4
19105	8-1 Gauge	.750"	.220"	6"	Red	25
18737	2-4/0 Gauge	1.100"	.375"	6"	Black	4
19106	2-4/0 Gauge	1.100"	.375"	6"	Black	25
18738	2-4/0 Gauge	1.100"	.375"	6"	Red	4
19107	2-4/0 Gauge	1.100"	.375"	6"	Red	25



## 18887

Six inch lengths of black thin wall, cross linked polyolefin, heat shrink tubing in a durable translucent polypropylene box. The tubing has 2:1 shrink ratio.

## Heat Shrink Tubing Kit

Part No.	Qty.	Pre-Shrink Size	Post-Shrink I.D.	I.D.
18697	36	3/16"	.187"	.093"
18698	24	1/4"	.250"	.125"
18699	12	3/8"	.375"	.187"
18700	6	1/2"	.500"	.250"
18701	4	3/4"	.750"	.375"
18702	4	1"	1.00"	.500"

UNIT PACKAGE: 1

# FUSE HOLDERS & ACCESSORIES

*Photos not actual size*

**12592**  
Nylon



Glass Tube Fuse Puller  
UNIT PACKAGE: 1

**12079**  
Nylon



Moulded In-Line Fuse Holder with 8" of 18 Gauge Wire  
Use with Auveco 1/4" x 1-1/4" Glass Tube Fuses  
Up to and including 20 Amps

UNIT PACKAGE: 3

**11618**  
Nylon



Fuse Assembly with 30 Amp Fuse Included  
12 Gauge Wire  
UNIT PACKAGE: 5

**18103**



Tests ATO® (Blade Type) and Mini-Fuses.  
Now you can make sure the fuse is good before installing it.

Also functions as a fuse puller.  
40 Amp maximum

UNIT PACKAGE: 1

**12359**



In-Line Fuse Holder  
Accommodates all ATO/ATC fuses from 3-30 Amps  
Heavy Duty Hard Shell Construction  
10" Loop of 14 Gauge Wire  
UNIT PACKAGE: 3

**14055**



In-Line Fuse Holder  
Accommodates all ATO/ATC fuses from 3-30 Amps  
Heavy Duty Hard Shell Construction  
10" Loop of 12 Gauge Wire  
UNIT PACKAGE: 3

**12363**



In-Line Fuse Holder

Accommodates all ATO/ATC fuses from 3 thru 20 Amps.  
Comes with two 4" 16 Gauge Wire Leads.

UNIT PACKAGE: 5

**20789**



In-Line Mini Fuse Holder

30 Amp Maximum  
12 Gauge Wire

Use with **Mini Fuses 16351-16360**  
Replaces **17648**  
Fuse NOT Included

UNIT PACKAGE: 3

**12977**

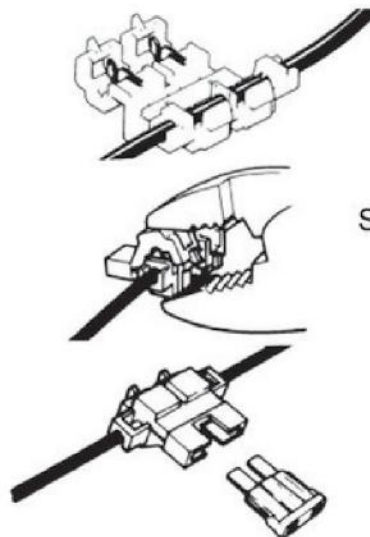

Self-Stripping Fuse Holder

Mates with most plug-in blade type fuses found in late-model domestic and some import cars.  
For 18-14 gauge copper wire.

32 volts maximum  
20 amp maximum with 14 gauge wire  
10 amp maximum with 16 gauge wire  
7.5 amp maximum with 18 gauge wire

UNIT PACKAGE: 5

# FUSES & FUSE HOLDERS

*Photos not actual size*

## Sealed Fuse Holders For ATM Mini® Fuses



**20206**

20, 25 & 30 Amp Capacity  
10" Long 12 Gauge Cross-Linked Polyethylene Leads  
Fuse NOT Included

UNIT PACKAGE: 1



**20207**

2-15 Amp Capacity  
10" Long 16 Gauge Cross-Linked Polyethylene Leads  
Fuse NOT Included

UNIT PACKAGE: 1

## High Power Sealed Fuse Holder

**20320**

For ATC & ATO Fuses  
40 Amp Capacity  
12" Long 10 Gauge 105 Strand  
EZ Flex Wire Leads  
Fuse NOT Included

UNIT PACKAGE: 1

## Environmentally Sealed Blade Type Fuse Holder

Also used as Fuel Pump Fuse Holder on GM Vehicles



**13686**

(GM: 12101917; Delco: PT-189)

UNIT PACKAGE: 1

Electrical system protection for fleets, construction equipment, aircraft service vehicles, outdoor power equipment and marine installations.

Resistant to moisture, salt spray and engine compartment fluids. Withstands 50g physical shock. Operating temperature range from -40° to 125°C.

- Nylon Body with Latching Cap
- Silicone Rubber Seals at Wires and Cap
- 12 Gauge SE/GPT Wire Leads
- 3 to 30 Amp Capacity - Type ATC/ATO Fuses
  - 5" Long Wire Leads
  - Fuses NOT included

## Low Profile JCase Fuses



Part No.	Amp Rating	Color	Unit Pkg.
21472	20	Blue	3
21473	25	White	3
21474	30	Pink	3
21106	40	Green	3
21475	50	Red	3
21476	60	Yellow	3

## PAL™ (Pacific Auto Link) Fuses



Type 1

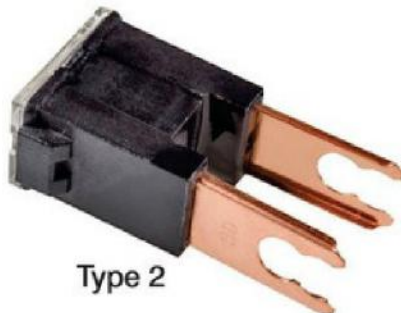

Type 2



Type 3



Type 4

Part No.	Type	Amp Rating	Color	Unit Pkg.
20560	1	20	Blue	1
15926	1	30	Pink	1
15927	1	40	Green	1
19294	1	50	Red	3
15928	1	60	Yellow	1
15929	2	30	Pink	1
15930	2	60	Yellow	1
15931	2	80	Black	1
15932	3	30	Pink	1
15933	3	40	Green	1
19295	3	80	Black	2
19296	3	100	Blue	2
20551	4	20	Blue	2
20552	4	30	Pink	2
20553	4	40	Green	2
20554	4	50	Red	2
20555	4	60	Yellow	2

# FUSES & ACCESSORIES

*Photos not actual size*

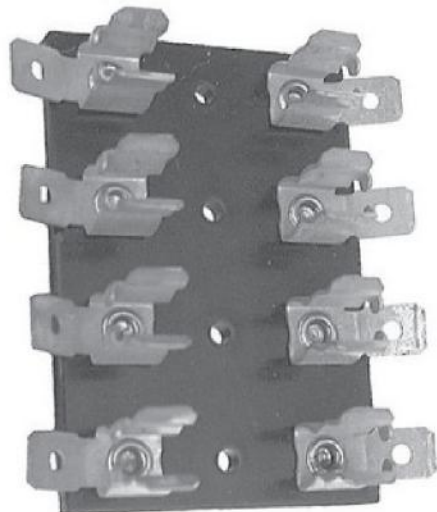

## 13445

Four Gang Fuse Block

Size: 2-7/16" x 2-15/16" x 3/4"

For use with SFE-20 Amp. fuse or any 3 AG series fuse. Phosphor bronze fuse clips. Brass screws

UNIT PACKAGE: 1

## Terminal/Junction Blocks



For marine and exposed applications. Brass nickel plated terminal links and binding head terminal screws. Moisture repellent molded ABS base with protective insulator barrier strips. 20 Amp rating.

## 13446

4 Gang (Circuits)

Size: 3-1/4" x 1-5/16" x 5/8"

UNIT PACKAGE: 1

## 13447

6 Gang (Circuits)

Size 3-3/8" x 1-1/8" x 9/16"

UNIT PACKAGE: 1

## 13449

10 Gang (Circuits)

Size: 5-1/8" x 1-1/8" x 9/16"

UNIT PACKAGE: 1



## 14474

Blade Type Fuse Tap

A quick, easy alternative to direct wiring when tapping the "hot side" of the fuse block. The blade type fuse tap is made of sturdy brass and is engineered for quick connect and disconnect of accessories such as C.B. radios, hand-held lights, etc.

UNIT PACKAGE: 25

Installation can be completed in three steps:

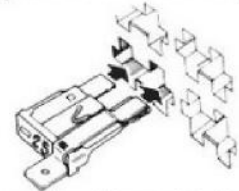

1. Use a test probe to locate the "hot side" of the circuit in the fuse block. Then snap the tap over the corresponding "hot side" blade of the fuse. Insert the fuse into the fuse block.

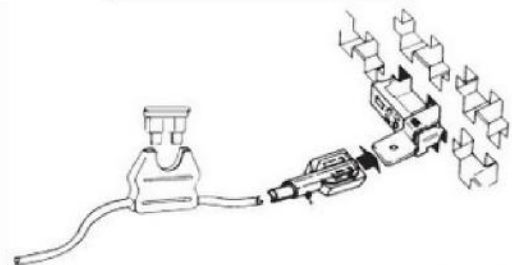

2. Crimp one end of an in-line fuse holder (with the fuse installed) to a fully insulated nylon .250" female quick-connect terminal. Attach the other fuse holder lead to the accessory wire.

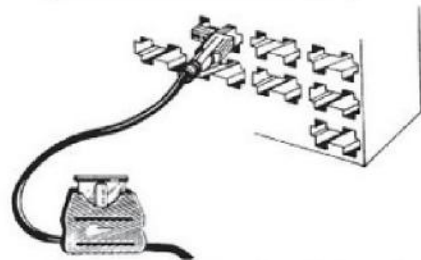

3. Complete the connection by sliding the female quick-connect terminal onto protruding tab of the tap.



## 17686

Mini Fuse Blade Type Fuse Tap

"Tapping" fuse blocks equipped with Mini® Fuses are no Problem!

Now there's a quick, easy alternative to direct wiring for tapping the "hot side" of mini fuse style fuse blocks. The blade type fuse tap is made of .016" thick sturdy brass with a .187" (3/16") wide tab. It is engineered for quick connect and disconnect of accessories.

UNIT PACKAGE: 50

Installation can be complete in 3 steps:

1. Locate "hot side" of circuit in fuse block with a test probe. Slide the tap onto corresponding "hot side" blade of fuse.

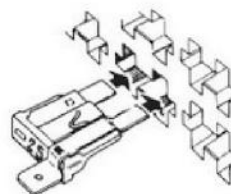

2. Insert the fuse into the fuse block

3. Crimp one end of an in-line fuse holder (with the fuse installed) to the appropriate Auveco female connector 8781 (16-14 Ga.) or 12159 (22-18 Ga.). Attach the other fuse holder lead to the accessory wire.

Slide the female connector onto protruding tab of the tap.

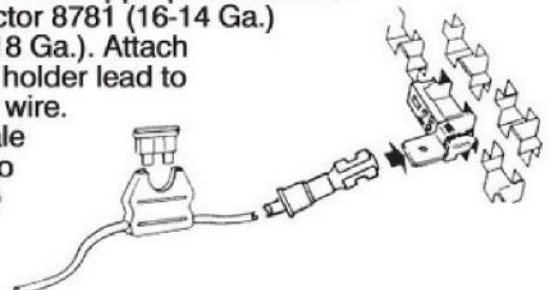

## ATC®/ATO® (Blade Type) Fuses



Unit Pkg.	Part No.	Unit Pkg.	Amp Rating	Color
5		25		
	12534	12548	3	Violet
	12535	12549	4	Pink
	12536	12550	5	Tan
	12537	12551	7-1/2	Brown
	12538	12552	10	Red
	12539	12553	15	Blue
	12540	12554	20	Yellow
	12541	12555	25	White
	12542	12556	30	Green

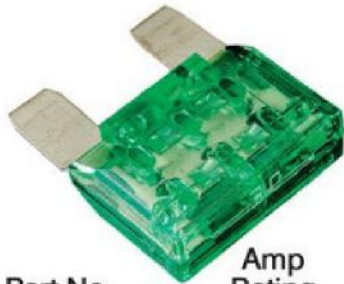

## Maxi™ Fuses

Part No.	Amp Rating	Color	Unit Pkg.
15505	20	Yellow	2
15506	30	Green	2
15507	40	Orange	2
15508	50	Red	2
15509	60	Blue	2



## Low Profile Mini Fuses

Part No.	Amp Rating	Color	Unit Pkg.
21602	5	Tan	5
21603	7.5	Brown	5
21436	10	Red	5
21437	15	Blue	5
21166	20	Yellow	5
21438	25	Clear	5
21604	30	Green	5

## Mega® Fuses



Part No.	Amp Rating	Unit Pkg.
21598	40	2
21599	60	2
21600	80	2
18986	100	2
18987	125	2
18988	150	2
18989	175	2
18990	200	2
22118	250	2
22119	300	2
22120	500	2

## FUSES



## Glass Tube Fuses

Part No.	Size	Amp	Code	Unit Pkg.
18981	1/4" x 1-1/4"	2	AGC-2	5
17625	1/4" x 1-1/4"	3	AGC-3	5
17626	1/4" x 1-1/4"	5	AGC-5	10
17627	1/4" x 1-1/4"	7.5	AGC-7.5	10
12545	1/4" x 1-1/4"	10	AGC-10	5
12546	1/4" x 1-1/4"	15	AGC-15	5
18982	1/4" x 1-1/4"	20	AGC-20	5
12543	1/4" x 1-1/4"	20	SFE-20	5
18983	1/4" x 1-1/4"	25	AGC-25	5
12544	1/4" x 1-7/16"	30	SFE-30	5
12547	1/4" x 1-1/4"	30	AGC-30	5



## Mini® Fuses

Part No.	Amp Rating	Color	Unit Pkg.
16351	2	Gray	5
16352	3	Purple	5
16353	4	Pink	5
16354	5	Tan	5
16355	7.5	Brown	5
16356	10	Red	5
16357	15	Blue	5
16358	20	Yellow	5
16359	25	White	5
16360	30	Green	5



## Micro Fuses 2 Blades

Part No.	Amp Rating	Color	O.E.M No.	Unit Pkg.
21828	5	Tan	GM: 19209790	5
21829	7.5	Brown	GM: 19209791	5
21830	10	Red	GM: 19209792	5
21831	15	Blue	GM: 19209793	5
21832	20	Yellow	GM: 19209794	5
21833	25	Natural	GM: 19209795	5
21834	30	Green	GM: 19209796	5



## Micro Fuses 3 Blades

Part No.	Amp Rating	Color	O.E.M No.	Unit Pkg.
21749	5	Tan	Ford: DG9Z-14526-N GM: 19209797	2
21750	7.5	Brown	Ford: DG9Z-14526-S GM: 19209798	2
21751	10	Red	Ford: DG9Z-14526-P GM: 19209799	2
21752	15	Blue	Ford: DG9Z-14526-R GM: 19119304	2



# GM SOCKET ASSEMBLY & HARNESS CONNECTORS

Use with butt connectors on pages 205-211 • *Photos not actual size*



**9905**

(Chry: 2496279; GM: 2973932;  
AMC: 3509575; IHC: 374985C1)

Instrument Panel Socket for 5/8" Hole  
Bulb No. 158, 194, 194A  
GM, Chrysler, AMC & International

UNIT PACKAGE: 10



**12237**

(Chry: 3744750; GM: 12004311,  
25015169; Ford: C80Z-13711A)

Instrument Panel Socket for 1/2" Hole  
Bulb No. 158, 194, 194A  
GM, Ford & Chrysler

UNIT PACKAGE: 2



**9883**

(GM: 6298886,  
6298892, 6298935;  
Ford: D0DZ-15A434B)

Side Marker Assembly  
Bulb No. 158, 194, 194A  
GM & Ford

UNIT PACKAGE: 5



**11441**

Instrument Panel and  
Marker Lights  
Bulb No. 158, 194, 194A  
GM & Ford

UNIT PACKAGE: 10



**11166**

(GM: 6294015, 8901283, 8918527;  
Ford: D40Z-13410E,  
D7AZ-13412A, D7FZ-13412A)

Side Marker and  
License Plate Lights  
Bulb No. 158, 194, 194A  
GM & Ford

UNIT PACKAGE: 1



**13540**

(8912750)

Side Marker, License,  
Parking & Tail Lights  
Bulb No. 158, 194, 194A  
GM

UNIT PACKAGE: 1

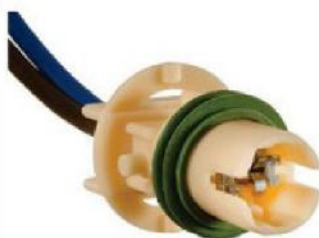

**17108**

(12083007)

Marker Light Pigtail  
Bulb No. 24  
GM 1988-On

UNIT PACKAGE: 1



**18924**

(12083460)

Rear Side Marker Lights  
Bulb No. 158, 194, 194A  
GM 1985-On

UNIT PACKAGE: 1



**13549**

(12001470)

Side Marker, License,  
Tail & Stop Lights  
Bulb No. 158, 194, 194A  
GM

UNIT PACKAGE: 1

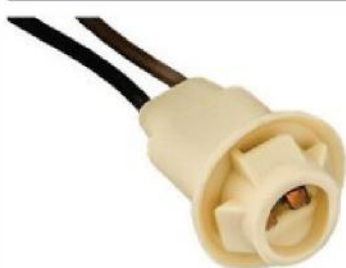

**13558**

(6298892, 6298886)

Side Marker Assembly  
Bulb No. 158, 194, 194A  
GM

UNIT PACKAGE: 1



**8755**

(2978302)

License Plate, Back-Up  
& Instrument Panel Lights  
For 1-1/8" Hole  
Bulb No. 63, 67, 81, 87, 89, 93,  
209, 1003, 1073, 1129, 1133 & 1141  
GM

UNIT PACKAGE: 10



**8759**

Signal, Park, Stop  
& Tail Lights  
For 3/4" Hole  
Bulb No. 198, 1016,  
1034, 1154 & 1157  
GM

UNIT PACKAGE: 5

# GM SOCKET ASSEMBLY & HARNESS CONNECTORS

Use with butt connectors on pages 205-211 • *Photos not actual size*



**8756**

(2974309)

Signal, Park, Stop & Tail Lights  
For 1-1/8" Hole  
Bulb No. 198, 1016, 1034, 1154 & 1157  
GM

UNIT PACKAGE: 10



**13544**

(12003878, 8904251)

Back-up, Cornering  
& Turn Signal  
Bulb No. 1156  
GM

UNIT PACKAGE: 1



**8754**

Weatherproof Signal,  
Park, Stop & Tail Lights  
For 3/4" Hole  
Bulb No. 198, 1016, 1034, 1154 & 1157  
GM

UNIT PACKAGE: 5



**11446**

(8902487, 8903283,  
8907701 & 8909908)

Stop & Tail Lights  
Bulb No. 1157  
GM

UNIT PACKAGE: 5



**8750**

(2974309, 2983540,  
6299087 & 8912698)

Signal, Park, Stop & Tail Lights  
Bulb No. 1034, 1154 & 1157  
GM

UNIT PACKAGE: 5



**11154**

(8903202, 8914822)

Park, Stop & Tail Lights  
Bulb No. 1034,  
1154 & 1157  
GM

UNIT PACKAGE: 1



**11157**

(AMC: 4486948;  
GM: 2983540, 8912698;  
6299087)

Signal, Park, Stop  
& Tail Lights  
Bulb No. 1034,  
1154 & 1157  
GM & AMC

UNIT PACKAGE: 1



**11475**

(8903202, 8914822)

Park, Stop & Tail Lights  
Bulb No. 1034, 1154 & 1157  
GM

UNIT PACKAGE: 5



**11156**

(GM: 5963268,  
8904437, 8909518;  
IHC: 57172C91)

Back-up & Cornering  
Bulb No. 1156  
GM & IHC

UNIT PACKAGE: 1



**21006**

(15306157)

White Shell, Natural Insert

Daytime Running Lights  
& Turn Signal  
Bulb No. 3156 & 4156  
GM 1999 - On

UNIT PACKAGE: 1



**11476**

(8903203, 8914823)

Park, Stop & Tail Lights  
Bulb No. 1157  
GM

UNIT PACKAGE: 5



**17175**

(12076946)

Ivory Shell

Stop, Tail, Turn &  
Parking Lights  
Bulb No. 3057 & 3157  
GM 1988-On

UNIT PACKAGE: 1

# GM SOCKET ASSEMBLY & HARNESS CONNECTORS

Use with butt connectors on pages 205-211 • *Photos not actual size*



**13543**  
(8919916,12013813)

Park, Stop &  
Tail Lights  
Bulb No. 1157  
GM

UNIT PACKAGE: 1



**16585**  
(12083005)

Signal, Park, Stop & Tail Lights  
Dual Filament Wedge Base  
Bulb No. 3057  
GM

UNIT PACKAGE: 1



**16586**  
(12083006)

Signal, Park, Stop &  
Tail Lights  
Dual Filament Wedge Base  
Bulb No. 3057  
GM

UNIT PACKAGE: 1



**18923**  
(12027133)

Back-Up Lights  
GM 1982-On

UNIT PACKAGE: 1



**12600**  
(GM: 12003759;  
AMC: 812893)

90° Pigtail &  
Socket Assembly  
Bulb No. 1016, 1034,  
1154 & 1157  
GM & AMC

UNIT PACKAGE: 1



**13545**  
(12003758)

Tail Lights  
Single Contact  
Bulb No. 87, 93 & 1156  
GM

UNIT PACKAGE: 1



**13546**  
(12003757)

Signal & Park Lights  
Bulb No. 198 & 2057  
GM

UNIT PACKAGE: 1



**17172**  
(12083680)  
Black Shell

Stop, Tail, Turn  
& Parking Lights  
Bulb No. 3057 & 3157  
GM: 1989-On

UNIT PACKAGE: 1



**17173**  
(12083689)  
Ivory Shell

Stop, Tail, Turn  
& Parking Lights  
Bulb No. 3057 & 3157  
GM 1990-On

UNIT PACKAGE: 1



**17174**  
(12085330)  
Brown Shell

Back-Up Lights  
Bulb No. 2456 & 3156  
GM 1990-On

UNIT PACKAGE: 1



**14918**  
(12048369)

Headlight Socket Assembly  
for High-Low 9004 & 9007  
Halogen Bulb  
GM, Ford & Imports

UNIT PACKAGE: 1



**16174**

Headlight Socket Assembly  
For Low Beam 9006  
Halogen Bulb  
Single Indexing Groove  
GM, Ford, AMC & Imports

UNIT PACKAGE: 4

# GM SOCKET ASSEMBLY & HARNESS CONNECTORS

Use with butt connectors on pages 205-211 • *Photos not actual size*



**16175**  
(GM: 12101898)

Headlight Socket Assembly  
For High Beam 9005  
Halogen Bulb  
Two Indexing Grooves  
GM, Ford, AMC & Imports

UNIT PACKAGE: 4



**16967**  
(12101906)

Heater Blower connector  
pigtail on GM 1985-On.  
Can also be used as  
an ATO/ATC Fuse Holder.  
Features two 9" long 12 gauge  
GXL wire leads.

UNIT PACKAGE: 1



**17114**  
(12085496)

Direct Ignition Throttle  
Body Injection Pigtail  
GM 1987-On

UNIT PACKAGE: 2



**17112**

Not Supplied By O.E.M.  
Distributor Module Pigtail  
Used on GM distributor  
module 1987466  
on 6 cylinder 2.8 engines  
1985-On

UNIT PACKAGE: 1



**18916**  
(12085483)

Ignition Module, Crankshaft  
Coolant Sensor & Power  
Steering Pressure Switch  
Harness Connector  
GM 1986-On

UNIT PACKAGE: 1



**18870**  
(12101855)

Direct Ignition  
Vehicle Speed Sensor  
Harness Connector  
GM  
1987-On

UNIT PACKAGE: 1



**18867**  
(12101880)

Direct Ignition  
Harness Connector  
GM  
1987-On

UNIT PACKAGE: 1



**18318**  
(12101857)

Air Divert Valve  
Harness Connector  
GM 1994-87

UNIT PACKAGE: 1



**18320**  
(12101856)

Air Switch Valve  
Harness Connector  
GM 1993-91

UNIT PACKAGE: 1



**18524**  
(12085497)

MAP Mass Air Flow Sensor  
Harness Connector  
GM with 2.8 Eng &  
Sequential Fuel Injection  
1989-85

UNIT PACKAGE: 1



**18868**  
(12085495)

Mass Air Flow Sensor  
Harness Connector  
GM 1988-On

UNIT PACKAGE: 1



**16694**  
(12043215, 12085498)

Cornering & Fog Light Socket  
for 881 & H11 Halogen Bulbs  
GM

UNIT PACKAGE: 1

# GM SOCKET ASSEMBLY & HARNESS CONNECTORS

Use with butt connectors on pages 205-211 • *Photos not actual size*

## 21490

(GM: 12102664,88862264)  
(Ford: 1U2Z-14S411-YA)

Fog & Front Lights, Power  
Steering & Oil Pressure Switch  
Harness Connector  
GM 2005 - 1986  
Ford 2004 - 1995  
Jeep Eagle 1994

UNIT PACKAGE: 1

## 17110

(12102747)

Windshield Washer Pump,  
Low Coolant Sensor  
Harness Connector  
GM Cars & Trucks 1992-87

UNIT PACKAGE: 1

## 17111

(12116958)

Horn Harness Connector  
Fits Horns 1999160, 1999161,  
10456327 and 10456328  
GM 1988-On

UNIT PACKAGE: 1

## 21212

(88988609)

Window Motor Regulator  
Harness Connector  
Two 12 Gauge  
10" Long Leads  
GM 1995 - On

UNIT PACKAGE: 1

## 16693

(12046624, 12102620)

Replacement harness  
connector used with  
1985-on GM Manifold

Air Temperature Sensors including 25036751.  
Features two 9" long 18 gauge wire leads.

UNIT PACKAGE: 1

## 18917

(12085538)

Camshaft Sensor  
Harness Connector  
Buick, Olds & Pontiac  
1992-86

UNIT PACKAGE: 1

## 18925

(25117765)

E.F.I. Fuel Pump  
Harness Connector  
GM with Fuel Pump in  
Gas Tank 1995-88

UNIT PACKAGE: 1

## 19891

(Not Available from O.E.M.)

Windshield Wiper Motor  
Harness Connector  
GM 1994 - 86

UNIT PACKAGE: 1

## 17109

(12085525, 12085527,  
12085528, 12101895,  
12117361)

3 Wire Alternator Harness Connector  
Two 18 gauge and one 12 gauge leads  
Can be used to replace two wire and single wire  
harness connectors by taping (do NOT cut) the  
appropriate unused leads.  
GM 1986-On

UNIT PACKAGE: 1

## 21220

(GM: 88987187)

Headlight Socket  
Harness Connector for  
H9 Halogen Bulb  
(Auveco Bulb No. BH9)

GM, Audi, Mazda, Mini-Cooper, Porsche,  
Volkswagen & Volvo

UNIT PACKAGE: 1

## 17113

(12101937)

A.C. Compressor  
Clutch Harness Connector  
GM Cars & APV 1989-On

UNIT PACKAGE: 1

## 16514

(12085503)

Replacement harness  
connector used on GM V-5 Air  
Conditioning Compressor Pressure Cut-off Switches.  
Fits GM low Pressure Switch 6551946 and others.  
Index slot is at three o'clock position  
Features two 9" long 18 gauge wire leads

UNIT PACKAGE: 1

# GM SOCKET ASSEMBLY & HARNESS CONNECTORS

Use with butt connectors on pages 205-211 • *Photos not actual size*



**18527**  
(12102748)

Throttle Position Sensor  
Harness Connector  
GM 1994-90

UNIT PACKAGE: 1



**14580**  
(12102621)

Radiator Fan Sensor Switch  
Harness Connector  
Fits electric cooling fan switches:  
3040674, 14043275 and 14043276  
GM 1980-On

UNIT PACKAGE: 1



**18674**  
(12126451)

Coolant Temperature  
Sensor Harness Connector  
Fits Sensor 10232601 & 25037203  
GM 1987-On

UNIT PACKAGE: 1



**17107**  
(12117385)

Oxygen Sensor  
Connector Pigtail  
Fits the Following Oxygen Sensors:

8990469 (AC-Delco AFS13P)  
8990625 (AC-Delco AFS15P)  
8990741 (AC-Delco AFS16P)  
10042186 (AC-Delco 213-15)  
25105107 (AC-Delco AFS20)  
25105901 (AC-Delco AFS21)  
25106073 (AC-Delco AFS22)  
Most GM Models 1982-On

UNIT PACKAGE: 1



**16962**  
(Not Supplied by O.E.M.)

Harness Connector used with GM  
Mixture Control Solenoid Kits:  
17067343, 17067344 and  
17111102 on  
2 & 4 barrel Rochester  
Varajet Carburetors.  
GM cars and trucks 1980-On

UNIT PACKAGE: 1



**19882**  
(12085485)

Back-Up Light Switch &  
Speed Sensor Harness Connector  
Used with Switch 23049569,  
PT107 & IACV Motor  
GM 1971-On

UNIT PACKAGE: 1



**16965**  
(12085507)  
Gray

Air Conditioner Pressure  
Switch Harness Connector  
Used on GM vehicles  
(28 models) 1988-84

UNIT PACKAGE: 1



**17198**  
(Not Supplied by O.E.M.)

Throttle Position Sensor  
Harness Connector  
Fits Sensor 17078051,  
17078448 & 17078481 on  
2 & 4 Barrel Rochester Carburetors  
GM 1990-80

UNIT PACKAGE: 1



**16964**  
(12085502)  
Green

Manifold Absolute Pressure  
(MAP) Harness Connector.  
Fits GM MAP Sensor 6137039  
on GM vehicles (38 models)  
1982-on

UNIT PACKAGE: 1



**17199**  
(12085533)

Transmission  
Converter Clutch  
Harness Connector

3 Wires (Cavity "C" is not wired)  
GM 1990-84

UNIT PACKAGE: 1

# GM SOCKET ASSEMBLY & HARNESS CONNECTORS

Use with butt connectors on pages 205-211 • *Photos not actual size*



**18918**  
(12085506)

Fuel Injection  
Idle Air Control Valve,  
Stoplight Switch & Torque  
Converter Clutch Valve  
Harness Connector  
GM 1985 - On

UNIT PACKAGE: 1



**16968**  
(12085491)

Fuel Injector  
Solenoid Harness Connector  
Fits GM Multi-Port Fuel  
Injector 1711799 on 2.8  
and 3.1 liter engines  
(27 models) 1986 - On  
Fits Fuel Injectors on Ford,  
Chrysler & Imports (Bosch)

UNIT PACKAGE: 1



**17463**  
(12102568)

Fuel Injector Connector for  
TBI (Throttle Body Injector)  
Systems  
All GM (Including  
Trucks) 1978 - On

UNIT PACKAGE: 1



**17690**  
(12101903)

Washer Fluid Sensor  
Harness Connector  
Also used on Back-Up  
Light Switch & A.C. Compressor Switch  
GM 1985-On

UNIT PACKAGE: 5



**19556**  
(12117354)

Harness Connector  
Brake Light Switch 25529862  
GM: Camaro, Caprice,  
Century, Firebird, Lumina APV,  
K,S, & T Truck, Silhouette &  
Trans Sport 1991 - On

UNIT PACKAGE: 1



**18525**  
(Not Supplied by O.E.M.)

Tail Light  
Harness Connector  
GM Full Size Pick-Up  
Trucks 1995 - 88

UNIT PACKAGE: 1



**11444**

Voltage Regulator  
Pigtail  
GM

UNIT PACKAGE: 10



**21033**  
(88953358)

Harness Connector  
For Blower Motor Resistors 89019088, 89019089 &  
89019100 and Various Relays, Switches & Actuators  
8" Leads

GM Cars and Light & Medium Duty Trucks 1990 - On

UNIT PACKAGE: 1



**21542**  
(GM: 88953358)

Harness Connector with Seven 12 Gauge, 12" Leads  
For Blower Motor Resistors 89019088, 89019089 &  
89019100 and Various Relays, Switches & Actuators  
GM Cars and Light & Medium Duty Trucks 1990 - On

UNIT PACKAGE: 1



**19554**  
(12101927)

Harness Connector Headlight  
and Ignition Switches  
15693540, 10471139,  
1070881, 26693547 & 15693548  
GM: Astro, Safari, C, K, S, T Trucks,  
Kodiak & Grand Am 1990-On

UNIT PACKAGE: 1



**11440**  
(GM: 2962510)

Air Conditioner Blower Relay  
Harness Connector  
18 Gauge Wire  
GM, AMC & Chrysler

UNIT PACKAGE: 10

# GM SOCKET ASSEMBLY & HARNESS CONNECTORS

Use with butt connectors on pages 205-211 • *Photos not actual size*



**11443**  
(6294493)

Alternator Harness  
Connector with  
Transistorized Alternators  
GM

UNIT PACKAGE: 10



**17691**  
(12101909)

Alternator Harness Connector  
Two 16 Gauge Leads  
Fits Delcotron Models  
10-SI, 12-SI, 15-SI & 27-SI  
with Internal Voltage Regulator  
GM 1980-71

UNIT PACKAGE: 5



**11442**  
(2977373)

Alternator Harness  
Connector with External  
Voltage Regulators  
GM 1977-62

UNIT PACKAGE: 10



**13547**  
(2977373)

Alternator Extender  
Harness Connector with  
Female Connector  
GM 1974-62

UNIT PACKAGE: 2



**13548**  
(6294493)

Alternator Extender  
Harness Connector with  
Female Connector  
GM 1971-On

UNIT PACKAGE: 2



**11436**

Dimmer Switch  
Harness Connector  
GM

UNIT PACKAGE: 10



**19555**  
(12102757)

Harness Connector  
Headlight Dimmer Switch  
GM Most Models  
1990-On

UNIT PACKAGE: 1



**18871**  
(12101939)

Harness Connector for  
Cooling Fan, Fuel Pump,  
Starter Interrupt Relay &  
Fan Control Switch  
Cadillac 1988-On

UNIT PACKAGE: 1



**18530**

(Not Supplied by O.E.M.)

Headlight Switch  
Harness Connector  
Fits Switch 1995217  
GM 1991-68

UNIT PACKAGE: 1



**9884**

(916638, 916581)  
Plastic

Amber Lens  
Front Fender Marker  
Lamp Assembly  
Use with Auveco 9883  
GM

UNIT PACKAGE: 1



**9885**

(916638, 916581)  
Plastic

Clear Lens  
Front Fender Marker  
Lamp Assembly  
Use with Auveco 9883  
GM

UNIT PACKAGE: 1



**9916**

(916632)  
Plastic

Red Lens  
Rear Quarter Marker  
Lamp Assembly  
Use with Auveco 9883  
GM

UNIT PACKAGE: 1



# FORD SOCKET ASSEMBLY & HARNESS CONNECTORS

Use with butt connectors on pages 205-211 • *Photos not actual size*



**12237**

(Chry: 3744750; GM: 12004311,  
25015169; Ford: C80Z-13711A)

Instrument Panel Socket for 1/2" Hole  
Bulb No. 194  
GM, Ford & Chrysler

UNIT PACKAGE: 2



**13533**

(D3AZ-13410B, D5DZ-13410A)

Rear Lights  
Bulb No. 1157  
Ford

UNIT PACKAGE: 1



**9883**

(GM: 6298886, 6298892, 6298935;  
Ford: D0DZ-15A434B)

Side Marker Assembly  
Bulb No. 158, 194, 194A  
GM & Ford

UNIT PACKAGE: 5



**13535**

(D3AZ-13410A)

Signal, Stop & Tail Lights  
Bulb No. 1156  
Ford

UNIT PACKAGE: 1



**11441**

Instrument Panel and  
Marker Lights  
Bulb No. 158, 194, 194A  
GM & Ford

UNIT PACKAGE: 10

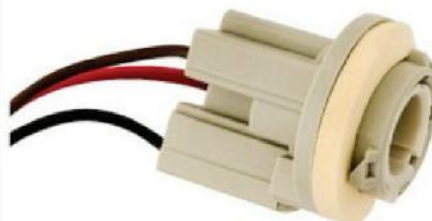

**14133**

(D4LY-13410-A)

Tail & Stop Lights  
Bulb No. 1157  
Ford

UNIT PACKAGE: 1



**11166**

(GM: 6294015,  
8901283, 8918527;  
Ford: D40Z-13410E,  
D7AZ-13412A, D7FZ-13412A)

Side Marker &  
License Plate Lights  
Bulb No. 158, 194, 194A  
GM & Ford

UNIT PACKAGE: 1



**14131**

(D3AZ-13410-E)

Back-up/Cornering Lights  
Bulb No. 1141  
Ford

UNIT PACKAGE: 1



**8761**

License Plate & Instrument  
Panel Lights  
For 5/8" Hole  
Bulb No. 51, 53, 55, 57 & 57X  
Ford

UNIT PACKAGE: 10



**14128**

(D40Z-13234-A)

Signal & Parking Lights  
Bulb No. 1157  
Ford

UNIT PACKAGE: 1



**13537**

(D1AZ-13410B)

Stop & Tail Lights  
with one Ground Male  
Blade Terminal  
Bulb No. 1034, 1154 & 1157  
Ford

UNIT PACKAGE: 1



**14132**

(D3AZ-13410-G)

Tail & Stop lights  
Bulb No. 1157  
Ford

UNIT PACKAGE: 1



**14135**

(D1FZ-13234-A)

Parking Lights  
Bulb No. 1157  
Ford

UNIT PACKAGE: 1

## FORD SOCKET ASSEMBLY & HARNESS CONNECTORS

Use with butt connectors on pages 205-211 • *Photos not actual size*



**14130**

(D4ZZ-13234-A)

Signal & Parking Lights  
Bulb No. 1157  
Ford

UNIT PACKAGE: 1



**20837**

(Not Supplied by O.E.M.)

Stop & Tail Light  
Three 20 Gauge  
Wire Leads  
Uses 2458, 3057 &  
3157 Wedge Type Bulbs  
Ford 1987 - On

UNIT PACKAGE: 1



**20848**

(Not Supplied by O.E.M.)

Rear Light Assembly  
Harness Connector  
Four 18 Gauge Wire Leads  
Ford F250 thru F750 without Pick Up Box 1999 - On

UNIT PACKAGE: 1



**21210**

(Not Available from O.E.M.)

Universal Headlight Harness Connector  
Two 18 Gauge 6" Long Leads  
For H7 Halogen Bulbs  
Ford, Audi, BMW, Hyundai,  
Kia, Mazda, Mercedes,  
Mini Cooper, Saab & Subaru

UNIT PACKAGE: 1



**16174**

Headlight Socket Assembly  
For Low Beam 9006  
Halogen Bulb  
Single Indexing Groove  
GM, Ford, AMC & Imports

UNIT PACKAGE: 4



**16175**

(GM: 12101898)

Headlight Socket Assembly  
For High Beam 9005  
Halogen Bulb  
Two Indexing Grooves  
GM, Ford, AMC & Imports

UNIT PACKAGE: 4



**21490**

(GM: 12102664, 88862264)  
(Ford: 1U2Z-14S411-YA)

Fog & Front Lights,  
Power Steering & Oil Pressure  
Switch Harness Connector  
GM 2005 - 1986  
Ford 2004 - 1995  
Jeep Eagle 1994

UNIT PACKAGE: 1



**14918**

(12048369)

Headlight Socket Assembly  
For High-Low 9004 &  
9007 Halogen Bulb  
GM, Ford & Imports

UNIT PACKAGE: 1

## HAVE YOU VISITED US ONLINE?

[www.faccfasteners.com](http://www.faccfasteners.com)

**FACCA | FASTENERS**



**19890**

(Not Available from O.E.M.)

Back-Up Light Switch  
Harness Connector  
Fits Switches  
C9TZ-15520C & SW-849  
Ford Trucks & T-Bird 1967-On

UNIT PACKAGE: 1



**19125**

(Not Supplied by O.E.M.)

Stop, Tail, Turn & Parking Lights  
Plugs into Light Socket Base  
For Double Filament  
Wedge Type Bulbs  
Ford Ranger, Explorer & Econoline  
1991-On

UNIT PACKAGE: 1

# FORD SOCKET ASSEMBLY & HARNESS CONNECTORS

Use with butt connectors on pages 205-211 • *Photos not actual size*



**22184**

(Ford: F1TZ-13411-A;  
GM: 88860592)

Park, Stop & Turn Signal  
Lights Socket Base  
Bulb No. 3157  
Three Terminals  
Black Housing  
90° Angle Base

**Use with 19125**  
Ford Cars &  
Trucks 1994 - On

UNIT PACKAGE: 1



**20547**

(Not Supplied by O.E.M.)

Multi-Function Switch  
Harness Connector  
Fits 13K359 Switches E8DZ-B,  
E8ZZ-B, E9DZ-A,B,C, E90Y-D,  
E9SZ-B,D,E & F0ZZ-A,B  
Ford Taurus, Sable, T-Bird, Cougar  
and Continental 1993 - 86

UNIT PACKAGE: 1

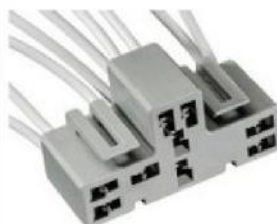

**20548**

(Not Supplied by O.E.M.)

Multi-Function Switch  
Harness Connector  
Fits 13K359 Switches E8DZ-B,  
E8ZZ-B, E9DZ-A, B, C, E90Y-D,  
E9SZ-B, D, E & F0ZZ-A, B  
Ford Taurus, Sable, T-Bird, Cougar and  
Continental 1993 - 86

UNIT PACKAGE: 1



**19126**

(Not Supplied by O.E.M.)

Back-Up Lights Plugs into  
Light Socket Base  
For Single Filament  
Wedge Type Bulbs  
Ford Ranger, Explorer &  
Econoline 1991-On

UNIT PACKAGE: 1



**20246**

(Not Supplied by O.E.M.)

Multi-Function Switch  
Repair Harness  
Eleven 18 Gauge Leads  
Aerostar, E Van, Expedition,  
Mustang, Navigator, Sable,  
Taurus & Windstar 1992 - On

UNIT PACKAGE: 1



**18463**

(Not Supplied by O.E.M.)

Headlight Switch  
Harness Connector  
Fits Headlight Switches  
E6DZ-11654A & F2DZ-11654A  
Ford Taurus & Mercury Sable  
with Rotary Knob 1994-86

UNIT PACKAGE: 1



**20550**

(Not Supplied by O.E.M.)

Multi-Function Switch  
Harness Connector  
Fits 13K359 Switches  
F1AZ-A, B, F1DZ-B, F1LY-B,  
F10Y-D, F1VY-C, F3TZ-B, F3UZ-C,  
F4ZZ-AA, F58Z-A, F5AZ-A, F5TZ-B, F65Z-AA, F6DZ-A,  
F75Z-AB,AC,BA, F77Z-AA, F79Z-CA & F85Z-AA  
Ford Aerostar, Bronco, Continental, Cougar,  
Expedition, Explorer, F Pick-Ups, Mark Series,  
Mountaineer, Mustang, Navigator, Ranger, Sable,  
T-Bird, Taurus, Town Car & Windstar 1990 - On

UNIT PACKAGE: 1



**17624**

(Not Supplied by O.E.M.)

Headlight Switch Assembly  
Harness Connector  
Fits Instrument Panel  
Headlight Switch  
E7TZ-11654-C  
Ford Trucks: F150, F250, F350  
& Bronco 1991-87

UNIT PACKAGE: 1



**18673**

(Not Supplied by O.E.M.)

Multi-Function Switch  
Harness Connector  
(Turn Signal & Windshield Wiper)  
Fits Switch E9DZ-13K359-A, B, C,  
E8ZZ-13K359-B & F0ZZ-13K359-A  
Ford Mustang 1993-87  
Taurus & Sable 1989-86

UNIT PACKAGE: 1



**18464**

(Not Supplied by O.E.M.)

Turn Signal Switch  
Harness Connector  
Fits Switch E7FZ-13341-A  
Ford Tempo, Topaz, EXP, LN7,  
Capri, Mustang, LTD, Marquis,  
Escort & Lynx 1994-85

UNIT PACKAGE: 1

# FORD SOCKET ASSEMBLY & HARNESS CONNECTORS

Use with butt connectors on pages 205-211 • *Photos not actual size*

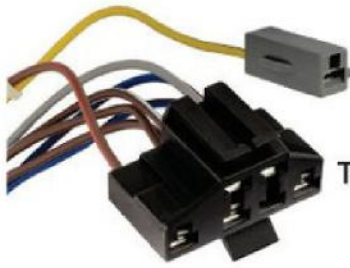

## 17623

(Not Supplied by O.E.M.)

EEC IV Test Plug  
Repair Harness Connector  
Two Connectors with eight 18  
Gauge Leads  
Ford 1983-On

UNIT PACKAGE: 1



## 19581

(Not Supplied by O.E.M.)

EEC IV Test Plug  
Repair Harness Connector  
One 18 Gauge Wire Lead  
**Component of Auveco  
17623 Harness Connector**  
Ford 1983-On

UNIT PACKAGE: 5



## 19881

(Not Supplied by O.E.M.)

Ignition Switch  
Harness Connector  
Used with Switches  
D0TZ-11572A, SW944  
Ford Trucks: 100-900 Series  
1970-On

UNIT PACKAGE: 1



## 20853

(Not Supplied by O.E.M.)

Ignition Coil  
Harness Connector  
Two 16 Gauge Wire Leads  
Fits Coils F7TZ-12029-CC &  
1L2Z-12029-AA  
Ford Cars & Lt. Duty Trucks  
1999 - On

UNIT PACKAGE: 1



## 20172

(Not Supplied by O.E.M.)

EEC Relay Harness Connector  
Used with Relay E3AZ-12A646-A  
Two 18 Gauge Wire Leads,  
Two 16 Gauge Wire Leads &  
One 14 Gauge Wire lead  
Ford Cars & Trucks 1981-On

UNIT PACKAGE: 1



## 20844

(Not Supplied by O.E.M.)

Electronic  
Ignition Module  
Harness Connector  
Four 16 Gauge Wire Leads  
Fits Modules  
F2PZ-12A199-AA, DY683  
Ford 1975 - On

UNIT PACKAGE: 1



## 20841

(Not Supplied by O.E.M.)

Electronic  
Ignition Module  
Harness Connector  
Four 18 Gauge Wire Leads  
Fits Module F2PZ-12A199-AA, DY683  
Ford Cars & Lt. Trucks 1985 - 75  
700 Series & Larger 1991 - 75

UNIT PACKAGE: 1



## 17684

(Not Supplied by O.E.M.)

Ignition Switch  
Harness Connector  
Fits Ignition Switch  
E6FZ-11572A  
Ford 1992-80

UNIT PACKAGE: 1



## 18676

(E6DZ-14A411-A)

Ignition Switch  
Harness Connector  
Fits Switch E7DZ-11572-A  
Ford Taurus, Sable &  
Lincoln Continental  
1986-On

UNIT PACKAGE: 1



## 18214

(Not Supplied by O.E.M.)

Ignition Module  
Harness Connector  
Fits Ignition Module  
E8TZ-12A297A  
Ford Ranger: 1995-88

UNIT PACKAGE: 1

# FORD SOCKET ASSEMBLY & HARNESS CONNECTORS

Use with butt connectors on pages 205-211 • *Photos not actual size*



**18217**

(E5ZZ-12A209A)

Ignition Module &  
Neutral Safety Switch  
Harness Connector  
For E.E.C. IV Ignition 1995-83  
Ford Neutral Safety Switch  
E80Z-7A247-A 1988-On

UNIT PACKAGE: 1



**18819**

(Not Supplied by O.E.M.)

Heater & Air Conditioner  
Blower Switches  
Harness Connector  
Fits most Ford Switches with  
Base Number 19986  
1973-On

UNIT PACKAGE: 1



**19623**

(Not Supplied by O.E.M.)

Ignition Control Module Harness  
For Modules F1AZ,  
F4SZ-12072A & F5SZ-12072AA  
Wire Gauge: 5 of 18 & 7 of 16  
8" Leads

Ford: Full Size Trucks & Vans, T-Bird,  
Cougar Lincoln Town & Mark 1991 - On

UNIT PACKAGE: 1



**19582**

(Not Supplied by O.E.M.)

Harness Connector for  
Heater Blower Motor &  
Radiator Cooling Fan Motor  
**Replaces** ..... **18213**  
Ford Truck & Vans 1986-82  
Ford 4-Cylinder Engine  
1979-On

UNIT PACKAGE: 5

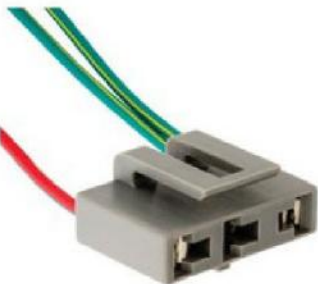

**17661**

(Not Supplied by O.E.M.)

Electronic Ignition Coil  
Harness Connector  
Fits Coil E73Z-12029A  
Ford 1986-On

UNIT PACKAGE: 1

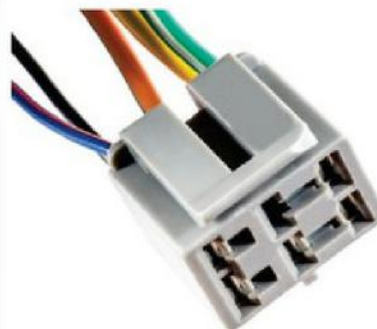

**19883**

(Not Supplied by O.E.M.)

Blower Motor Switch  
Harness Connector  
Used with Switch  
E83Z-19986A, YH-481  
Tempo & Topaz 1994-88

UNIT PACKAGE: 1



**20839**

(Not Supplied by O.E.M.)

Coil to Ignition  
Harness Connector  
Two 18 Gauge Wire Leads  
Ford 1977 - On

UNIT PACKAGE: 10



**19887**

(Not Supplied by O.E.M.)

Auxiliary Blower Switch  
Harness Connector  
Fits Switch F2UZ-19986C, YH-538  
Ford Vans E150/350 1992-On

UNIT PACKAGE: 1



**17620**

(Not Supplied by O.E.M.)

Air Conditioning Blower  
Motor Resistor Assembly  
Harness Connector  
Fits Resistor Assembly  
E7TZ-19A706-A  
Ford Trucks 1983 - On

UNIT PACKAGE: 1



**20849**

(Not Supplied by O.E.M.)

Blower Motor Switch  
Harness Connector  
Five 16 Gauge Wire Leads  
Fits Switches D0HZ-19986-A, YH411  
Ford Heavy Duty Trucks 1989 - 1968

UNIT PACKAGE: 1

# FORD SOCKET ASSEMBLY & HARNESS CONNECTORS

Use with butt connectors on pages 205-211 • *Photos not actual size*



## 17598

(Not Supplied by O.E.M.)

Air Conditioning Clutch  
Cycling Pressure Switch  
Harness Connector  
Fits Switch E35Y-19E561-A  
Ford 1980-On

UNIT PACKAGE: 1



## 20843

(F81Z-19D887-AA, WPT-169,  
1U2Z-14S411-AEA)

A/C Clutch Cycling  
Pressure Switch  
Harness Connector  
Four 16 Gauge Wire Leads  
Fits Switches F5VY-19E561-A,  
F3AZ-19D594-C,  
F5TZ-19D594-AA & YH-592  
Ford 1990 - On

UNIT PACKAGE: 1



## 17617

(Not Supplied by O.E.M.)  
Gray

Engine Cooling Fan  
Motor Switch  
Harness Connector  
Fits Switch E43Z-8B607-A  
Ford 1984-On

UNIT PACKAGE: 1



## 17618

(Not Supplied by O.E.M.)  
Black

Engine Cooling Fan  
Motor Switch  
Harness Connector  
Fits Switches E5SZ-8B607-A &  
E4FZ-8B607-A  
Ford 1984-On

UNIT PACKAGE: 1



## 19661

(Not Supplied by O.E.M.)

Blower Motor Resistor  
Harness Connector  
Fits Resistors F1CZ-19A706-A  
& F7CZ-19A706-AA  
One Connector has one each of  
8" Long 20 Gauge, 16 Gauge, 14  
Gauge & 12 Gauge GXL Wire Leads.  
The other Connector has one 8" Long  
12 Gauge GXL Wire Lead.  
Ford Escort & Tracer 1991-On

UNIT PACKAGE: 1



## 22185

(Ford: 1U2Z-14S411-BHA,  
WPT-153)

Blower Motor Resistor  
Harness Connector  
Two 10 Gauge &  
Three 20 Gauge  
TXL Wire Leads  
Ford, Lincoln &  
Mercury 2011 - 1991

UNIT PACKAGE: 1



## 20277

(Not Supplied by O.E.M.)

Heater/Air Conditioner  
Fan Speed Switch  
Harness Connector  
Two 12 Gauge, one 14 Gauge &  
One 16 Gauge Leads  
Fits Switches E6DZ-A, E9SZ-A,  
F2DZ-A & F2UZ-19986A,B

Ford Cougar, E Van, Mustang, Sable,  
Taurus & T-Bird 1986 - On

UNIT PACKAGE: 1



## 20852

(Not Supplied by O.E.M.)

Radiator Cooling  
Motor & Resistor  
Harness Connector  
Two 12 Gauge Leads  
For Resistor F5RZ-8L603-AC &  
Motors F8RZ-8C607-GC, GE, RF28, RF76 & RF81  
Ford Contour, Mystique & Cougar 1995 - On

UNIT PACKAGE: 1



## 20549

(Not Supplied by O.E.M.)

Radiator Cooling Fan Motor  
Harness Connector  
Fits Fan & Shroud Assemblies  
F4DZ-8C607B &  
F5CA-8C607A  
Ford Contour, Continental,  
Escort, Mystique,  
Sable & Taurus 1997 - 90

UNIT PACKAGE: 1



## 17619

(E4FZ-8C290-A)

Engine Cooling Fan  
Harness Connector  
Wiring Kit  
Ford 4 Cylinder  
(2.3 Engine)  
with Air Conditioning  
1983-On

UNIT PACKAGE: 1

# FORD SOCKET ASSEMBLY & HARNESS CONNECTORS

Use with butt connectors on pages 205-211 • *Photos not actual size*



## 17598

(Not Supplied by O.E.M.)

Air Conditioning Clutch  
Cycling Pressure Switch  
Harness Connector  
Fits Switch E35Y-19E561-A  
Ford 1980-On

UNIT PACKAGE: 1



## 20843

(F81Z-19D887-AA, WPT-169,  
1U2Z-14S411-AEA)

A/C Clutch Cycling  
Pressure Switch  
Harness Connector  
Four 16 Gauge Wire Leads  
Fits Switches F5VY-19E561-A,  
F3AZ-19D594-C,  
F5TZ-19D594-AA & YH-592  
Ford 1990 - On

UNIT PACKAGE: 1



## 17617

(Not Supplied by O.E.M.)  
Gray

Engine Cooling Fan  
Motor Switch  
Harness Connector  
Fits Switch E43Z-8B607-A  
Ford 1984-On

UNIT PACKAGE: 1



## 17618

(Not Supplied by O.E.M.)  
Black

Engine Cooling Fan  
Motor Switch  
Harness Connector  
Fits Switches E5SZ-8B607-A &  
E4FZ-8B607-A  
Ford 1984-On

UNIT PACKAGE: 1



## 19661

(Not Supplied by O.E.M.)

Blower Motor Resistor  
Harness Connector  
Fits Resistors F1CZ-19A706-A  
& F7CZ-19A706-AA  
One Connector has one each of  
8" Long 20 Gauge, 16 Gauge, 14  
Gauge & 12 Gauge GXL Wire Leads.  
The other Connector has one 8" Long  
12 Gauge GXL Wire Lead.  
Ford Escort & Tracer 1991-On

UNIT PACKAGE: 1



## 22185

(Ford: 1U2Z-14S411-BHA,  
WPT-153)

Blower Motor Resistor  
Harness Connector  
Two 10 Gauge &  
Three 20 Gauge  
TXL Wire Leads  
Ford, Lincoln &  
Mercury 2011 - 1991

UNIT PACKAGE: 1



## 20277

(Not Supplied by O.E.M.)

Heater/Air Conditioner  
Fan Speed Switch  
Harness Connector  
Two 12 Gauge, one 14 Gauge &  
One 16 Gauge Leads  
Fits Switches E6DZ-A, E9SZ-A,  
F2DZ-A & F2UZ-19986A,B

Ford Cougar, E Van, Mustang, Sable,  
Taurus & T-Bird 1986 - On

UNIT PACKAGE: 1

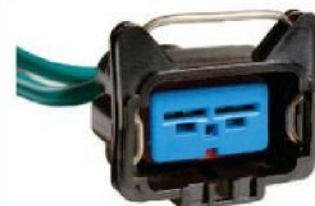

## 20852

(Not Supplied by O.E.M.)

Radiator Cooling  
Motor & Resistor  
Harness Connector  
Two 12 Gauge Leads  
For Resistor F5RZ-8L603-AC &  
Motors F8RZ-8C607-GC, GE, RF28, RF76 & RF81  
Ford Contour, Mystique & Cougar 1995 - On

UNIT PACKAGE: 1



## 20549

(Not Supplied by O.E.M.)

Radiator Cooling Fan Motor  
Harness Connector  
Fits Fan & Shroud Assemblies  
F4DZ-8C607B &  
F5CA-8C607A  
Ford Contour, Continental,  
Escort, Mystique,  
Sable & Taurus 1997 - 90

UNIT PACKAGE: 1



## 17619

(E4FZ-8C290-A)

Engine Cooling Fan  
Harness Connector  
Wiring Kit  
Ford 4 Cylinder  
(2.3 Engine)  
with Air Conditioning  
1983-On

UNIT PACKAGE: 1

# FORD SOCKET ASSEMBLY & HARNESS CONNECTORS

Use with butt connectors on pages 205-211 • *Photos not actual size*



**20846**  
(F4VY-14A411-S)

Starter Solenoid  
In-line Repair  
Harness Connector  
12 Gauge Wire Lead  
Ford & Lincoln Town Car  
1997 - 91

UNIT PACKAGE: 1



**20845**  
(Not Supplied by O.E.M.)

Cam Shaft &  
Crank Shaft Sensors  
Harness Connector  
Two 18 Gauge Leads  
Fits Sensors F0CZ-6B288-A,  
F1AZ-6B288-A, F1AZ-6C315-A  
& XC3Z-6B288-AA  
Ford 1991 - On

UNIT PACKAGE: 1



**19076**  
(Not Supplied by O.E.M.)

Master Cylinder,  
Door Jamb Switch  
& Power Mirror  
Harness Connector  
Ford 1987-On

UNIT PACKAGE: 1



**19880**  
(Not Supplied by O.E.M.)

Transmission Gear Shift  
Position Sensor  
Harness Connector  
Eight Wire Leads

Used with Switch F5TZ-7A247  
on Ford Trucks with E 4 OD Transmission,  
RWD 1989-84 and E, F & U Series 1989-On

UNIT PACKAGE: 1



**19157**  
(Not Supplied by O.E.M.)

Variable Speed Sensor  
Harness Connector  
For Speed Sensors with  
Ford Base No. 9E731  
Ford 1993-On

UNIT PACKAGE: 1



**19004**  
(F2PZ-14A464C,  
F4UB-14A464A)

Transmission MLP Sensor  
Harness Connector  
E150/350, F250/350 &  
U150 (Bronco)  
1990-On

UNIT PACKAGE: 1



**19813**  
(D1AZ-13410-A)

Power Brake  
Harness Connector  
Ford 1965-On

UNIT PACKAGE: 10



**20840**  
(Not Supplied by O.E.M.)

Glow Plug Pass thru  
at Valve Cover Gasket  
Harness Connector  
Two 16 Gauge & Three 18 Gauge Wire Leads  
Ford E350, F250-F550SD  
& Excursion 7.3 Diesel 1996 - On

UNIT PACKAGE: 1



**20561**  
(Not Supplied by O.E.M.)

Brake Light Switch  
Harness Connector  
Fits Switches YF1Z-13480-AA  
& YF1Z-13480BA  
Ford, Lincoln  
& Mercury 2000 - On  
Ford Explorer & Mercury  
Mountaineer 1999 - 98

UNIT PACKAGE: 1

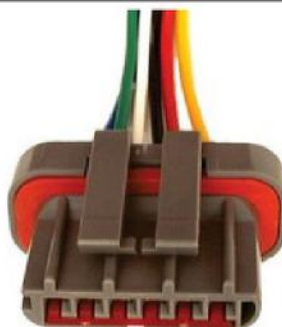

**19885**  
(F4PZ-14A411C)

Windshield Wiper Motor  
Harness Connector  
For New Single Connector  
Replacement Motors  
(6 Positions)  
Ford 1987-On

UNIT PACKAGE: 1



## FORD SOCKET ASSEMBLY & HARNESS CONNECTORS

Use with butt connectors on pages 205-211 • *Photos not actual size*



**18668**

(Not Supplied by  
O.E.M.)

In-Tank Fuel Pump  
&  
Sending Unit  
Connector  
Ford 1985 - On



UNIT PACKAGE: 5



**20851**

(1U2Z-14S411-TA, WPT118)

Alternator Harness Connector  
Three 14 Gauge  
Wire Leads  
Ford 1996 - On

UNIT PACKAGE: 1



**20838**

(Not Supplied by O.E.M.)

Alternator Harness Connector  
Two 16 Gauge Wire Leads  
100 Amp Alternator  
Ford 1990 - 75

UNIT PACKAGE: 10



**17659**

(Not Supplied by O.E.M.)

Voltage Regulator Plug  
Harness Connector  
Sable, Taurus, Tempo  
& Topaz with  
Internal Voltage Regulator  
1986 - On

UNIT PACKAGE: 1



**11445**

Voltage Regulator  
Harness Connector  
Ford

UNIT PACKAGE: 10



**11437**

Dimmer Switch  
Harness Connector  
Ford & Chrysler

UNIT PACKAGE: 10



**13644**

Right Angle Pigtail  
General Purpose  
11-1/2" Wire Lead for .160 Stud  
Ford

UNIT PACKAGE: 10

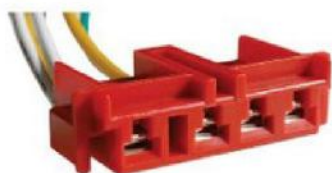

**20850**

(Not Supplied by O.E.M.)

Voltage Regulator  
Harness Connector  
Four 14 Gauge & two 18 Gauge Wire Leads  
Fits Voltage Regulator F0PZ-10316-A  
Ford 1975 - On

UNIT PACKAGE: 10



**18218**

(Not Supplied by O.E.M.)

Alternator Harness Connector  
Ford Aerostar, Tempo, Topaz,  
Taurus & Sable with  
6 Cylinder Engine & 75 Amp  
Alternator 1989-On  
4 Cylinder Engine 1985-On

UNIT PACKAGE: 1

# CHRYSLER SOCKET ASSEMBLY & HARNESS CONNECTORS

Use with butt connectors on pages 205-211 • *Photos not actual size*



## 12237

(Chry: 3744750; GM: 12004311,  
25015169; Ford: C80Z-13711A)

Instrument Panel Socket for 1/2" Hole  
Bulb No. 158, 194, 194A  
GM, Ford & Chrysler

UNIT PACKAGE: 2



## 9905

(Chry: 2496279; GM: 2973932;  
AMC: 3509575; IHC: 374985C1)

Instrument Panel Socket  
For 5/8" Hole  
Bulb No. 194  
GM, Chrysler, AMC & International

UNIT PACKAGE: 10



## 13541

(3588314)

Side Marker Assembly  
Bulb No. 194, 194A  
Chrysler

UNIT PACKAGE: 2



## 13542

(3513686, 4055028)

Side Marker Assembly  
Bulb No. 194, 194A  
Chrysler

UNIT PACKAGE: 2



## 12598

(3764865, 3843245,  
4124721, 4163003)

Single Contact  
with Ground  
Bulb No. 87, 93,  
1073, 1141 & 1156  
Chrysler

UNIT PACKAGE: 1



## 12599

(3764863)

Double Contact with Ground  
Bulb No. 1034, 1154 & 1157  
Chrysler

UNIT PACKAGE: 1



## 13233

(3843432)

Signal & Park Lights  
Bulb No. 198, 1016, 1034,  
1154 & 1157  
Chrysler

UNIT PACKAGE: 1



## 20389

(Not Supplied by O.E.M.)

Signal, Stop, Tail &  
Turn Lights  
Bulb No. 1157  
Chrysler including Trucks  
1992 - 89

UNIT PACKAGE: 1



## 12600

(GM: 12003759;  
AMC: 812893)

90° Pigtail &  
Socket Assembly  
Bulb No. 1016, 1034,  
1154 & 1157  
GM & AMC

UNIT PACKAGE: 1



## 18921

(4636360)

Signal, Park &  
Back-Up Lights  
Chrysler 1993-88

UNIT PACKAGE: 1



## 18920

(4636362)

Back-Up Lights  
Chrysler 1990-On

UNIT PACKAGE: 1



## 11157

(AMC: 4486948;  
GM: 8912698, 6299087)

Signal, Park, Stop &  
Tail Lights  
Bulb No. 1034,  
1154 & 1157  
GM & AMC

UNIT PACKAGE: 1

# CHRYSLER SOCKET ASSEMBLY & HARNESS CONNECTORS

Use with butt connectors on pages 205-211 • *Photos not actual size*

## 16174

Headlight Socket Assembly  
For Low Beam 9006  
Halogen Bulb  
Single Indexing Groove  
GM, Ford, AMC & Imports

UNIT PACKAGE: 4



## 11438

Temperature Sending Unit  
Harness Connector  
GM  
Voltage Regulator  
Harness Connector  
Chrysler

UNIT PACKAGE: 10

## 16175

(GM: 12101898)

Headlight Socket Assembly  
For High Beam 9005  
Halogen Bulb  
Two Indexing Grooves  
GM, Ford, AMC & Imports

UNIT PACKAGE: 4



## 11440

(GM: 2962510)

Air Conditioner  
Blower Relay  
Harness Connector  
18 Gauge Wire  
GM, AMC & Chrysler

UNIT PACKAGE: 10

## 21490

(GM: 12102664, 88862264  
Ford: 1U2Z-14S411-YA)

Fog & Front Lights, Power  
Steering & Oil Pressure Switch  
Harness Connector  
GM 2005 - 1986  
Ford 2004 - 1995  
Jeep Eagle 1994

UNIT PACKAGE: 1



## 16968

(12085491)

Fuel Injector  
Solenoid Harness Connector  
Fits GM Multi-Port Fuel  
Injector 1711799 on 2.8  
and 3.1 liter engines  
(27 models) 1986 - On  
Fits Fuel Injectors on Ford,  
Chrysler & Imports (Bosch)

UNIT PACKAGE: 1



## 11437

Dimmer Switch  
Harness Connector  
Ford & Chrysler

UNIT PACKAGE: 10



# IMPORT CAR HARNESS CONNECTORS

Use with butt connectors on pages 205-211 • *Photos not actual size*



**21210**  
(Not Supplied by O.E.M.)

Universal Headlight Harness Connector  
For H7 Halogen Bulbs  
Two 18 Gauge 6" Long Leads  
Ford, Audi, BMW, Hyundai,  
Kia, Mazda, Mercedes, Mini  
Cooper, Saab & Subaru

UNIT PACKAGE: 1



**21220**  
(GM: 88987187)

Headlight Socket  
Assembly  
For H9 Halogen Bulb  
GM, Audi, Mazda,  
Mini-Cooper, Porsche,  
Volkswagen & Volvo

UNIT PACKAGE: 1



**16174**

Headlight Socket Assembly  
For Low Beam 9006  
Halogen Bulb  
Single Indexing Groove  
GM, Ford, AMC & Imports

UNIT PACKAGE: 4



**14918**  
(12048369)

Headlight Socket  
Assembly  
For High-Low 9004 &  
9007 Halogen Bulb  
GM, Ford & Imports

UNIT PACKAGE: 1



**16175**  
(GM: 12101898)

Headlight Socket Assembly  
For High Beam 9005  
Halogen Bulb  
Two Indexing Grooves  
GM, Ford, AMC & Imports

UNIT PACKAGE: 4



**16968**  
(12085491)

Fuel Injector  
Solenoid Harness Connector  
Fits GM Multi-Port Fuel  
Injector 1711799 on 2.8  
and 3.1 liter engines  
(27 models) 1986 - On  
Fits Fuel Injectors on Ford,  
Chrysler & Imports (Bosch)

UNIT PACKAGE: 1

## UNIVERSAL SOCKET ASSEMBLY & HARNESS CONNECTORS

Use with butt connectors on pages 139-147 • *Photos not actual size*



**5219**

Pigtail Connector  
Single Small Wire  
Lead - 12" Long  
For Sockets Housing  
Miniature Lights

UNIT PACKAGE: 10



**5221**

Pigtail Connector  
Double Wire  
Lead - 12" Long  
Aligned Ears  
For Sockets Housing  
Double Contact Lights

UNIT PACKAGE: 10



**5220**

Pigtail Connector  
Single Large Wire  
Lead - 12" Long  
For Sockets Housing  
Single Contact Lights

UNIT PACKAGE: 10



**8763**  
(13235-A)

Weatherproof Covered Neoprene  
Signal, Park, Stop & Tail Lights  
Bulb No. 198, 1016, 1034,  
1154 & 1157

UNIT PACKAGE: 10

## UNIVERSAL SOCKET ASSEMBLY & HARNESS CONNECTORS

Use with butt connectors on pages 205-211 • *Photos not actual size*



### 8764

Single Contact License Plate Lights  
For 7/8"-1-1/8" Holes  
Bulb No. 63, 67, 87, 89, 93, 97, 209,  
1003, 1073, 1129, 1133, 1141 & 1156

UNIT PACKAGE: 5



### 5226

Universal Signal, Park,  
Stop & Tail Lights  
For 7/8" to 1-1/8" Hole  
Bulb No. 198, 1016,  
1034, 1154 & 1157

UNIT PACKAGE: 10



### 5225

Pigtail Connector  
Three Wire Sealed Beam  
12" Long - Molded

UNIT PACKAGE: 10



### 13554

Shielded License/Utility Light  
Sealed Socket Assembly  
with Chrome Plastic Shield  
14" Sealed Plastic Boot  
28" Lead with Male Spade Terminal  
Bulb Included-Mounts in 1-1/4" Hole

UNIT PACKAGE: 1



### 11439

Headlight & Flasher  
For all cars using 3 prong  
sealed Headlight Bulbs 4002,  
3, 5, 5040, 2, 5400, 2,  
40, 421, 6006, 12 & 13  
Also fits 2 & 3 Prong Flashers

UNIT PACKAGE: 10



### 16968

(12085491)

Fuel Injector  
Solenoid Harness Connector  
Fits GM Multi-Port Fuel  
Injector 1711799 on 2.8  
and 3.1 liter engines  
(27 models) 1986 - On  
Fits Fuel Injectors on Ford,  
Chrysler & Imports (Bosch)

UNIT PACKAGE: 1



### 13559

Headlight & Flasher  
For all cars using 2 prong  
Sealed Headlight  
Bulb No. 4001

UNIT PACKAGE: 3



### 16966

Three terminal Flasher connector pigtail  
designed specifically for heavy duty  
thermal and electronic flashers with  
variable and fixed loads - single  
and alternating flash patterns.  
Features three 10" long 14  
gauge GXL wire leads.

UNIT PACKAGE: 2



### 9901

Pigtail Connector  
Single Wire Lead  
16 Gauge - 12" Long  
Receptacle for use wherever there is a  
junction of two or more wires; such as behind an  
instrument panel or in an engine compartment.  
**Use with Auveco 9900**

UNIT PACKAGE: 20



### 9900

Pigtail Connector  
Single Wire Lead  
16 Gauge - 12" Long  
Snap plug for use wherever there is a  
junction of two or more wires; such as behind an  
instrument panel or in an engine compartment.  
**Use with Auveco 9901**

UNIT PACKAGE: 20



### 8770

2 Way Harness Connector  
7-1/2" Leads - 18 Gauge  
For Automotive, Truck and Marine  
Use where a double harness is required  
Also used on Trailers and Farm Implements

UNIT PACKAGE: 5



### 8768

3-Way Harness Connector  
7-1/2" Leads  
Color Coded Wire Automotive  
For Truck and Marine  
Use where a Triple Harness is required  
**Use with Auveco 8769**

UNIT PACKAGE: 5

**UNIVERSAL SOCKET ASSEMBLY & HARNESS CONNECTORS**Use with butt connectors on pages 205-211 • *Photos not actual size***8769**

3-Way Harness Connector  
7-1/2" Leads  
Color Coded Wire  
For Automotive, Truck and Marine  
Use where a Triple Harness is required  
**Use with Auveco 8768**

UNIT PACKAGE: 5

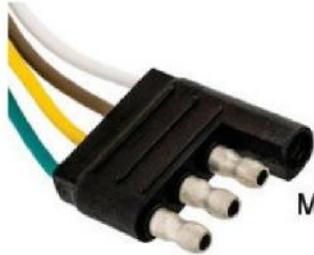
**10222**

4 Way Harness Connector  
12" Leads - 18 Gauge  
For Automotive, Truck, Trailer,  
Marine and Farm Implement Use  
**Use with Auveco 10223**

UNIT PACKAGE: 5

**10223**

4 Way Harness Connector  
12" Leads - 18 Gauge  
For Automotive, Truck, Trailer,  
Marine and Farm Implement Use  
**Use with Auveco 10222**

UNIT PACKAGE: 5

**10782**

4 Way Harness Connector  
48" Wire Leads - 18 Gauge  
For Automotive, Truck, Trailer,  
Marine and Farm Implement Use  
**Use with Auveco 10783**

UNIT PACKAGE: 2

**10783**

4 Way Harness Connector  
48" Wire Leads - 18 Gauge  
For Automotive, Truck, Trailer,  
Marine and Farm Implement Use  
**Use with Auveco 10782**

UNIT PACKAGE: 2

**11434**

Six Way Trailer Connector  
6 Color Coded Wire Leads  
For Trailer Application (Male)  
**Use with Auveco 11435**

UNIT PACKAGE: 5

**11435**

Six Way Trailer Connector  
6 Color Coded Wire leads  
For Trailer Application  
(Female)  
**Use with Auveco 11434**

UNIT PACKAGE: 5

**13634**

Complete 4-Way Trailer Connector  
Polarized four prong  
Chrome plated die cast housing  
2-hole flange mounting  
1-13/16" on centers  
Mounting bracket available

UNIT PACKAGE: 1 Set

**13639**

6-Way Trailer  
Connector Plug

UNIT PACKAGE: 1

**13636**

Complete 6-Way Trailer Connector  
Assembly consists of  
13639 plug and 13640 socket.  
Specifically designed for  
Recreational Vehicles  
Die cast plug housing is  
chrome plated and socket is a  
one piece plastic molded unit  
complete with plated spring  
loaded cover and a special  
moisture and dust-proof boot.

UNIT PACKAGE: 1 Set

**13643**

Universal Bracket  
For use with 13634 and  
13640 trailer connectors.  
Designed to fit under  
trailer high ball  
Heavy gauge zinc plated steel

UNIT PACKAGE: 2

# MINIATURE BULBS

Wagner Miniature Bulbs • *Photos not actual size*



Type 1



Type 2



Type 3



Type 4



Type 5



Type 7



Type 9



Type 10



Type 11



Type 12



Type 14



Type 15



Type 16



Type 18



Type 19



Type 20



Type 21

Part No.	Type	Replaces Bulb No.	Unit Pkg.
18472	4	1445	10
18473	14	1449	10
18474	5	1815	10
18475	18	3156NA	10
18476	7	3157NA-SA	10
18477	15	3357	10
18478	15	3357NA	10
18479	15	3157SA	10
19206	16	7440	2
19207	16	7443	2
19208	3	1295NA	10
20282	4	55	10
20283	4	63	10
20284	2	73	10
20285	2	161	10
20286	2	192	10
20287	19	222	10
20289	11	562	10
20291	10	904	10
20292	12	68	10
20294	10	922	10

Part No.	Type	Replaces Bulb No.	Unit Pkg.
20295	1	1638	10
20296	20	3496	10
20298	2	3652	10
20299	9	11005	10
20300	9	11006	10
20585	1	1176	10
20587	7	3457	10
20588	7	3457NA	10
20589	5	17131	10
20590	21	17171	10
20591	2	17177	10
20593	1	17916	10
20620	7	4157LL	2
20621	7	4157NALL	2
20681	1	1142	10
20859	7	3757NALL	2

A - Amber (Darker)  
 LL - Long Life  
 NA - Natural Amber (Lighter)  
 SA - Special Application

# WAGNER HALOGEN LIGHT BULBS

*Photos not actual size*



## 16896

9004/HB1 Bulb  
High-Low Beam in Single Headlight  
Assemblies  
Volts: 12-18  
Watts: 25-65

Use with **Socket 14918**

UNIT PACKAGE: 1



## 18662

9007/HB5 Bulb  
High-Low Beam  
Volts: 12.8  
Watts: 55-65

Use with **Socket 14918**

UNIT PACKAGE: 1



## 16897

9005/HB3 Bulb  
High Beam in Dual Headlight Assemblies  
Volts: 12.8  
Watts: 65

Use with **Socket 16175**

UNIT PACKAGE: 1



## 16898

9006/HB4 Bulb  
Low Beam in Dual Headlight Assemblies  
Volts: 12.8  
Watts: 55

Use with **Socket 16174**

UNIT PACKAGE: 1



## 20683

886 Bulb

UNIT PACKAGE: 1



## 20595

881 Bulb

UNIT PACKAGE: 1



## 18661

9003/HB2 Bulb  
High-Low Beam  
Volts: 12.0  
Watts: 55-60

Use with **Socket 5225**

UNIT PACKAGE: 1



## 20601

1260/H4 Bulb

UNIT PACKAGE: 1



## 20596

885 Bulb

UNIT PACKAGE: 1



## 20599

893 Bulb

UNIT PACKAGE: 1



## 19209

2040 Bulb  
Center Grille  
Mercury Sable and Villager

UNIT PACKAGE: 1



## 20598

891 Bulb

UNIT PACKAGE: 1



## 20600

1255/H3 Bulb

UNIT PACKAGE: 1



## BULB NUMBER TO WAGNER BULB NUMBER

Bulb No.	No.	Bulb No.	No.	Bulb No.	No.
H3	20600	881	20595	2057NA	16908
H4	20601	885	20596	2357	17999
HB1	16896	886	20683	2357NA	18000
HB2	18661	891	20598	2396	17998
HB3	16897	893	20599	3057	16915
HB4	16898	904	20291	3057NA	16916
HB5	18662	906	16922	3155	17997
PR2	16927	912	18008	3156	17996
24	18017	916	18006	3156NA	18475
24NA	18018	916NA	18007	3157	16917
37	18465	921	18005	3157NA	18001
53	16914	922	20294	3157NA-SA	18476
55	20282	1003	16918	3157SA	18479
57	16910	1004	16920	3357	18477
63	20283	1034	16925	3357NA	18478
67	16905	1073	18004	3457	20587
68	20292	1076	18469	3457NA	20588
73	20284	1141	16923	3496	20296
74	18016	1142	20681	3652	20298
89	16911	1155	18470	3757NALL	20859
90	18015	1156	16904	4157LL	20620
93	16926	1156NA	17597	4157NALL	20621
97	16912	1157	16899	7440	19206
158	18014	1157NA	16901	7443	19207
161	20285	1176	20585	9003/HB2	18661
168	16921	1255/H3	20600	9004/HB1	16896
192	20286	1260/H4	20601	9005/HB3	16897
193	18013	1295NA	19208	9006/HB4	16898
194	16902	1445	18472	9007/HB5	18662
194NA	18012	1449	18473	11005	20299
198	16924	1638	20295	11006	20300
199	18466	1815	18474	12100	17995
211-2	16913	1816	16919	13050	17994
212-2	18011	1889	18003	17131	20589
222	20287	1891	18002	17171	20590
293	18467	1893	16909	17177	20591
561	18010	1895	16906	17916	20593
562	20289	2040	19209		
631	18468	2057	16907		

### Halogen Bulb Industry Standard Number to Auveco Harness Connector Number

Halogen Bulb No.	Harness No.	Halogen Bulb No.	Harness No.	Halogen Bulb No.	Harness No.
880	21490	898	16694	H8	16694
881	16694	899	21490	H9	21220
884	21490	9003	11439	H10	16175
885	21490	9004	14918	H11	16694
886	16694	9005	16175	H12	16175
889	16694	9006	16174	HB1	14918
890	21490	9007	14918	HB2	11439
892	21490	9055	16175	HB3	16175
893	21490	H4	11439	HB4	16174
894	16694	H7	21210		
896	16694				

# HIGH PERFORMANCE IMPORTED MINIATURE BULBS

*Photos not actual size*



Part No.	Type	Replaces Bulb No.	Unit Pkg.	Part No.	Type	Replaces Bulb No.	Unit Pkg.
B24	13	24	10	B2825	2	2825	10
B24A	13	24A	10	B2827	2	2827	10
B53	4	53	10	B3057	15	3057	10
B57	4	57	10	B3057A	15	3057A	10
B67	4	67	10	B3156	18	3156	10
B67A	4	67A	10	B3156A	18	3156A	10
B68	12	68	10	B3157	15	3157	10
B89	4	89	10	B3157A	15	3157A	10
B97	4	97	10	B3357	15	3357	10
B168	2	168	10	B3357A	15	3357A	10
B194	2	194	10	B3457	15	3457	10
B194-100	2	194	100	B3457A	15	3457A	10
B194A	2	194A	10	B3893	5	3893	10
B906	10	906	10	B4114K	15	4114K	10
B906A	10	906A	10	B4157	15	4157	10
B912	10	912	10	B4157K	15	4157K	10
B916	10	916	10	B5007	5	5007	10
B916A	10	916A	10	B5008	5	5008	10
B921	10	921	10	B6411	9	6411	10
B921A	10	921A	10	B6413	9	6413	10
B1141	3	1141	10	B6418	9	6418	10
B1156	3	1156	10	B6438	9	6438	10
B1156A	3	1156A	10	B6461	9	6461	10
B1157	1	1157	10	B7225	1	7225	10
B1157A	1	1157A	10	B7440	22	7440	10
B1893	5	1893	10	B7440A	22	7440A	10
B1895	4	1895	10	B7443	16	7443	10
B2057	1	2057	10	B7443A	16	7443A	10
B2057A	1	2057A	10	B7505	22	7505	10
B2357	1	2357	10	B7506	3	7506	10
B2357A	1	2357A	10	B7507	3	7507	10
B2721	2	2721	10	B7515	16	7515	10
B2722	2	2722	10	B7528	1	7528	10
B2821	2	2821	10				

# HIGH PERFORMANCE IMPORTED HALOGEN BULBS

*Photos not actual size*



**B880**

880 Bulb

UNIT PACKAGE: 1



**B890**

890 Bulb

UNIT PACKAGE: 1



**B881**

881 Bulb

UNIT PACKAGE: 1



**B891**

891 Bulb

UNIT PACKAGE: 1



**B884**

884 Bulb

UNIT PACKAGE: 1



**B893**

893 Bulb

UNIT PACKAGE: 1



**B885**

885 Bulb

UNIT PACKAGE: 1



**B894**

894 Bulb

UNIT PACKAGE: 1



**B886**

886 Bulb

UNIT PACKAGE: 1



**B896**

896 Bulb

UNIT PACKAGE: 1



**B889**

889 Bulb

UNIT PACKAGE: 1



**B899**

899 Bulb

UNIT PACKAGE: 1

# HIGH PERFORMANCE IMPORTED HALOGEN BULBS

*Photos not actual size*



## B9004

9004/HB1 Bulb  
High-Low Beam in  
Single Headlight Assemblies  
Volts: 12-18  
Watts: 25-65

Use with **Socket 14918**

UNIT PACKAGE: 1



## BD2C

D2C Bulb

UNIT PACKAGE: 1



## B9005

9005/HB3 Bulb  
High Beam in  
Dual Headlight Assemblies  
Volts: 12.8  
Watts: 65

Use with **Socket 16175**

UNIT PACKAGE: 1



## BD2R

D2R Bulb

UNIT PACKAGE: 1



## B9006

9006/HB4 Bulb  
Low Beam in  
Dual Headlight Assemblies  
Volts: 12.8  
Watts: 55

Use with **Socket 16174**

UNIT PACKAGE: 1



## BD2S

D2S Bulb

UNIT PACKAGE: 1



## B9007

9007/HB5 Bulb  
High-Low Beam  
Volts: 12.8  
Watts: 55-65

Use with **Socket 14918**

UNIT PACKAGE: 1



## BH1

H1 Bulb

UNIT PACKAGE: 1



## BD1S

D1S Bulb

UNIT PACKAGE: 1



## B64150ULT

H1LL/ 64150ULT Bulb

UNIT PACKAGE: 1

# HIGH PERFORMANCE IMPORTED HALOGEN BULBS

*Photos not actual size*



**BH3**

H3/12V 55W Bulb

UNIT PACKAGE: 1



**B64210ULT**

H7LL/ 64210ULT Bulb

UNIT PACKAGE: 1



**B64193**

H4/ 64193 Bulb

UNIT PACKAGE: 1



**BH9**

H9 Bulb

UNIT PACKAGE: 1



**B64193ULT**

H4LL/ 64193ULT Bulb

UNIT PACKAGE: 1



**BH10**

H10/9145 Bulb

UNIT PACKAGE: 1



**B64132**

H6W/ 64132 Bulb

UNIT PACKAGE: 10



**B64113**

H10W/ 64113 Bulb

UNIT PACKAGE: 10



**BH7**

H7 Bulb

UNIT PACKAGE: 1



**BH11**

H11 Bulb

UNIT PACKAGE: 1



**BH13**

H13/9008 Bulb

UNIT PACKAGE: 1

# HIGH PERFORMANCE IMPORTED BULBS

## Bulb Number to Auveco's High Performance Imported Bulb Number

Halogen Bulb No.	No.	Halogen Bulb No.	No.	Halogen Bulb No.	No.
24	B24	1157A	B1157A	7440A	B7440A
24A	B24A	1893	B1893	7443	B7443
53	B53	1895	B1895	7443A	B7443A
57	B57	2057	B2057	7505	B7505
67	B67	2057A	B2057A	7506	B7506
67A	B67A	2357	B2357	7507/Amber	B7507
68	B68	2357A	B2357A	7515	B7515
89	B89	2721	B2721	7528	B7528
97	B97	2722	B2722	9004	B9004
168	B168	2821	B2821	9005	B9005
194	B194	2825	B2825	9006	B9006
194A	B194A	2827/Amber	B2827	9007	B9007
880	B880	3057	B3057	9008	BH13
881	B881	3057A	B3057A	9145	BH10
884	B884	3156	B3156	D1S	BD1S
885	B885	3156A	B3156A	D2C	BD2C
886	B886	3157	B3157	D2R	BD2R
889	B889	3157A	B3157A	D2S	BD2S
890	B890	3357	B3357	H1	BH1
891	B891	3357A	B3357A	H1LL	B64150ULT
893	B893	3457	B3457	H3	BH3
894	B894	3457A	B3457A	H4	B64193
896	B896	3893	B3893	H4LL	B64193ULT
899	B899	4114K	B4114K	H6W	B64132
906	B906	4157	B4157	H7	BH7
906A	B906A	4157K	B4157K	H7LL	B64210ULT
912	B912	5007	B5007	H9	BH9
916	B916	5008	B5008	H10	BH10
916A	B916A	6411	B6411	H10W	B64113
921	B921	6413	B6413	H11	BH11
921A	B921A	6418	B6418	H13	BH13
1141	B1141	6438	B6438	HB1	B9004
1156	B1156	6461	B6461	HB3	B9005
1156A	B1156A	7225	B7225	HB4	B9006
1157	B1157	7440	B7440	HB5	B9007

## Bulb Number to Auveco's Premium Imported Bulb Number

Bulb No.	No.	Bulb No.	No.
24NA	20702	1893	20715
89	20705	2040	20717
168	20706	2357	20720
880	20854	2357NA	20721
881	20855	3057	20722
885	20856	3457	20728
889	20857	3457NA	20729
916NA	20712	3496	20730

NA- Natural Amber (Lighter)

# PREMIUM IMPORTED MINIATURE BULBS

*Photos not actual size*



Type 1



Type 2



Type 4



Type 5



Type 7



Type 10



Type 13



Type 20



Type 23

Part No.	Type	Replaces Bulb No.	Unit Pkg.
20702	13	24NA	10
20705	4	89	10
20706	2	168	10
20712	10	916NA	10
20715	5	1893	10
20720	1	2357	10
20721	1	2357NA	10
20722	7	3057	10
20728	23	3457	10
20729	23	3457NA	10
20730	20	3496	10

# PREMIUM IMPORTED HALOGEN BULBS



**20855**

881 Bulb

UNIT PACKAGE: 1



**20717**

2040 Bulb  
Center Grille  
Mercury Sable and Villager

UNIT PACKAGE: 1

All items available in bulk quantities.

Call customer service  
**1-800-354-9816**  
for a price quote



**20857**

889 Bulb

UNIT PACKAGE: 1



**20856**

885 Bulb

UNIT PACKAGE: 1



**20854**

880 Bulb

UNIT PACKAGE: 1

# SWITCHES

*Photos not actual size*

## Push-Pull Switches



### 13552

Marine Switch  
3 Position "Off-On-On"  
First 'On' position energizes one circuit.  
In second "On" position both circuits are energized.  
Mounting stem 1-1/4" long. 3/8" diameter.  
Brass hex back-up nut, brass washer, chrome plated  
brass face nut and chrome plated knob.  
15 Amps @ 12 Volts

UNIT PACKAGE: 1



### 12077

Push-Pull Switch  
Heavy Duty  
2 position "Off-On" switch with 2 Screw Terminals.  
25 Amps @ 6 Volts; 15 Amps @ 12 Volts

UNIT PACKAGE: 1



**Push Button Switch**  
Heavy Duty Construction

### 12078

Horn Button

UNIT PACKAGE: 1

## TOGGLE & ROCKER SWITCHES



### 13555

Brass

S.P. S.T. Toggle Switch  
"Off-On"  
Mounting Stem 3/8" long  
Diameter: 7/16" with  
7/16" x 28 threads  
Rating: 35 Amps @ 6 Volts  
20 Amps @ 12 Volts

UNIT PACKAGE: 1



### 13630

S.P. S.T. Toggle Switch "Off-On"  
Phenolic Housing  
Mounting Stem 15/32" long  
Diameter: 15/32"  
2 Screw Terminals  
Bat Handle  
Rating: 15 Amps 125 Volts AC  
10 Amps 250 Volts AC  
3/4 HP 120-240 Volts AC

UNIT PACKAGE: 1



### 13632

D.P. D.T. Toggle Switch  
"On-Off-On"  
Phenolic Housing  
Mounting Stem 15/32" long  
Diameter: 15/32"  
6 Screw Terminals  
Rating: 15 Amps 125 Volts AC  
10 Amps 250 Volts AC  
3/4 HP 120-240 Volts AC

UNIT PACKAGE: 1



### 13631

S.P. D.T. Toggle Switch "On-Off-On"  
Phenolic Housing  
Mounting Stem 15/32" long  
15/32" Diameter  
3 Screw Terminals  
Bat Handle  
Rating: 15 Amps 125 Volts AC  
10 Amps 250 Volts AC  
3/4 HP 120-240 Volts AC

UNIT PACKAGE: 1



# TOGGLE & ROCKER SWITCHES

*Photos not actual size*



## 13629

S.P. S.T. Toggle Switch "Off-On"  
Two 6" Wire Leads  
Nickel plated "Off-On" indicator  
plate assembled  
Mounting Stem 3/8" long  
Diameter: 15/32" diameter  
Bat handle  
Rating: 15 Amps 12 Volts DC  
6 Amps 125 Volts AC

UNIT PACKAGE: 1



## 12076

Chrome Plated Handle

Heavy Duty Toggle Switch  
2 Position "On-Off"  
Stem Diameter: 15/32"  
Low Voltage -High Amp Application  
Rating: 35 Amps @ 6-12 Volts DC

UNIT PACKAGE: 1



## 13556

Toggle Switch  
2 Positions "On-Off"  
For lights, blower, pump, etc.  
Black plastic paddle and  
locking ring with level seal  
and knurled cap nut

Sealed to resist water penetration.  
Fits panels up to 1/4" thick  
Requires 15/32" Mounting Hole  
Rating: 20 Amps @ 12 Volts D.C. with  
1/4" spade terminals

UNIT PACKAGE: 1

## 13514

Black Molded Bat Handle



Heavy Duty S.P. D.T. Toggle Switch  
3 Position "On-Off-On"  
3 Blade Terminals  
Spring loaded for positive snap action  
Includes bezel nut and collar  
Fits in 1/2" diameter hole  
Rating: 16 Amps @12 Volts

UNIT PACKAGE: 1



## Illuminated Toggle Switches

2 Position "Off-On"  
Handle illuminated in 'On' position  
With bezel nut and back-up collar  
for mounting in 1/2" hole.  
Rating: 20 Amps @ 12 Volts

Auveco Part No.	Color
13523	Red illuminated toggle
13524	Green illuminated toggle
12236	Amber illuminated toggle

UNIT PACKAGE: 1



## Illuminated Rocker Switches

2 Position "Off-On"  
Rocker illuminated in 'On' position  
Snaps into 1" x 1/2"  
rectangular hole  
Rating: 20 Amps. @ 12 Volts

Terminal Coding:  
1 -Power  
2 -Accessory  
3 -Ground

Auveco Part No.	Color
12234	Red illuminated rocker
13529	Green illuminated rocker
13530	Amber illuminated rocker
13531	Blue illuminated rocker

UNIT PACKAGE: 1



## 13528

Non-illuminated Rocker Switch  
2 position "Off-On"  
Fits 1-1/8" x 7/16" rectangular hole  
Rating: 20 Amps @ 12 Volts

UNIT PACKAGE: 1



## Illuminated Toggle Switch Mounting Panel

## 12233

1-1/8" x 7/16" Hole  
Use with Auveco 12234,  
13529, 13530 & 13531

UNIT PACKAGE: 1

# TOGGLE SWITCHES

*Photos not actual size*

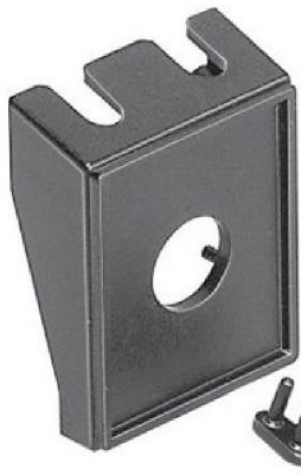

## Illuminated Toggle Mounting Panel

**12235**

1/2" Hole Diameter

UNIT PACKAGE: 1



## Indicator Lamps

Has wire leads for easy installation  
Mounts into 1/2" hole  
12 Volt application  
Installs in Auveco  
Mounting Panel 12235

Auveco  
Part No.

Color

20477	Red Lens
13520	Green Lens
13521	Amber Lens
13522	Blue Lens

UNIT PACKAGE: 1

# WIRE LOOM CLIPS



**1340**

Wire Loom Clips  
Clamping  
Diameter: 1/4"

UNIT PACKAGE: 100



**1341**

Wire Loom Clips  
Clamping Diameter: 3/16"

UNIT PACKAGE: 100



**3758**

Wire Loom Clips  
Clamping Diameter: 3/8"

UNIT PACKAGE: 100



**14388**

(145525)

Heavy Duty  
Frame Wiring Clip  
Clamping Diameter: 3/16"  
Fits panels from .030"-.230"

UNIT PACKAGE: 50



**9864**

(372741-S100)

General Purpose  
Wire Loom Clip

UNIT PACKAGE: 100

# ROUTING CLIPS



## Nylon Cable Clips

Part No.	Cable Size	Screw Size	Unit Pkg.
13939	3/16"	#8-10	50
13944	1/2"	#8-10	50



**13937**

Nylon Spring Clip

Width: 3/8"  
Overall Length: 1-5/16"  
Thickness: .060  
Use with #8 Screw

UNIT PACKAGE: 50



## Nylon Tubing & Hose Clips Adhesive Backed

Part No.	Range	Unit Pkg.
10057	5/32" to 1/4"	10
10058	5/16" to 1/2"	10
10059	9/16" to 3/4"	10



## Cable Clips for Co-Ax Cable

Polyethylene clips with corrosion  
resistant galvanized steel nail.

**15854**

Cable Diameter: 3/16"-9/32"  
Nail Length: 1"

UNIT PACKAGE: 50

# CABLE CONNECTOR & ROUTING CLIPS



## Strain-Relief Cable Connector

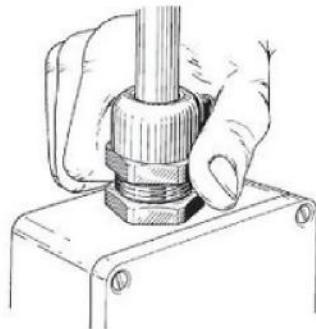

Photo not actual size

Reliable, liquid-tight, nylon strain-relief cable connector for quick and easy installation. They do not have to be disassembled before using. Simply insert a cable into the connector, tighten the cap nut and the cable is automatically fixed, centered, sealed and strain relieved.

### 15851

Wire Diameter: .236" - .472"  
 Thread: 1/2" NPT  
 Thread Length (Bottom): .512"  
 Hex: .945"

UNIT PACKAGE: 5



## Routing Clips

A quick, economical method of fastening wires, tubes, hoses or rods from 1/4" to 1" diameter to metal, plastic or any other surface ranging from 1/32" to 1/8" thickness. Clips are molded of durable black nylon plastic. They snap into 1/4" diameter holes and are held firmly in place by flexible "snubber tips" which compensate for variation in wall thickness.

Part No.	Tube/Hose Wire Outside Dia.	Clip Overall Height	Clip Height Above Panel	Unit Pkg.
14529	1/4"	27/32"	7/16"	25
14530	3/8"	29/32"	15/32"	25
14531	1/2"	1-1/16"	5/8"	25
14532	5/8"	1-3/16"	3/4"	25
14533	3/4"	1-5/16"	7/8"	25

## Wire Loom Routing Clips

Black Nylon • Also called split flexible tubing, convoluted conduit or wiring harness



Type 1

Type 2

Type 3

Type 4

Type 5

Part No.	Type	For Conduit Size		GM No.	Unit Pkg.
		I.D.	O.D.		
19440	3	1/4"	3/8"	12040984	15
19795	4	1/4"	3/8"	12015631	15
14544	1	11/32"	1/2"	8911473	25
20397*	6	10mm	13mm	12160858	15
20471	4	10mm	13mm	8905794	15
14545	1	13/32"	19/32"	8911497	25
14546	1	1/2"	11/16"	8911472	25
19851	5	1/2"	11/16"	12040983	15
14547	1	3/4"	1"	3816659	25
				8917320	
20665	7	19mm	24mm	12160374	15
16941	2	1"	1-9/32"	12015983	25

\*Gray Nylon



Type 6

Type 7

## CABLE & HARNESS STRAPS



**8550**  
Black Nylon, 2-1/4" Long  
UNIT PACKAGE: 25

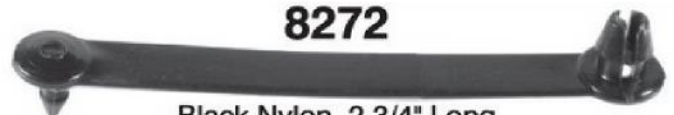

**8272**  
Black Nylon, 2-3/4" Long  
For 1/4" Hole in .093" Thick Metal  
UNIT PACKAGE: 50



**8273**  
Black Nylon, 2-3/4" Long  
For 1/4" Hole in 115" Thick Metal  
UNIT PACKAGE: 50

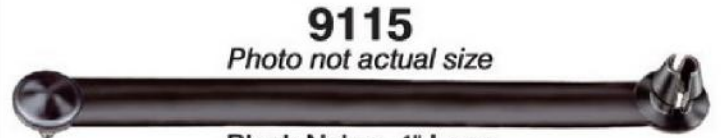

**9115**  
*Photo not actual size*  
Black Nylon, 4" Long  
UNIT PACKAGE: 50



**3690**  
*Photo not actual size*  
Natural Nylon, 3-1/2" Long  
UNIT PACKAGE: 100



**14376**  
(Mazda: 9928-90-753)  
Black Nylon, 110mm (4-3/8") Long, Releasable,  
Max. Bundle Diameter: 25mm (1"), Fits into 7mm Hole  
UNIT PACKAGE: 15



**20654**  
(Mercedes: 001-997-42-90)  
Black Nylon 120mm (4-3/4") Long,  
Fits into 8mm Hole  
UNIT PACKAGE: 10



**5879**  
Natural Nylon, 5" Long  
UNIT PACKAGE: 25



**14284**  
(Honda: 90669-671-000,  
90669-671-003;  
Toyota: 90463-10337)  
Aqua Nylon, 110mm (5-5/16") Long, Max. Bundle Diameter: 23mm (7/8"), Fits into 6mm Hole  
UNIT PACKAGE: 15

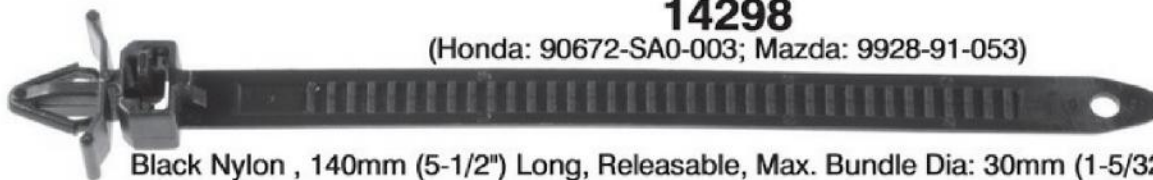

**14298**  
(Honda: 90672-SA0-003; Mazda: 9928-91-053)  
Black Nylon, 140mm (5-1/2") Long, Releasable, Max. Bundle Dia: 30mm (1-5/32"), Fits into 7mm Hole  
UNIT PACKAGE: 25

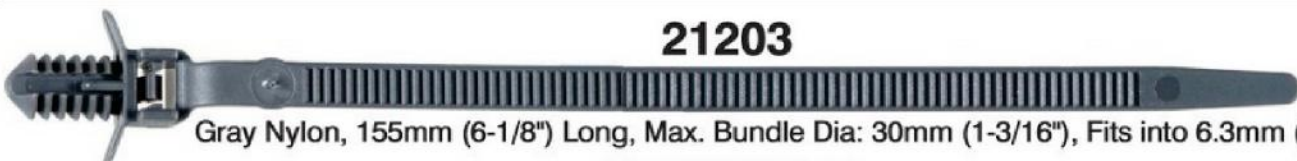

**21203**  
Gray Nylon, 155mm (6-1/8") Long, Max. Bundle Dia: 30mm (1-3/16"), Fits into 6.3mm (1/4") Hole  
UNIT PACKAGE: 25

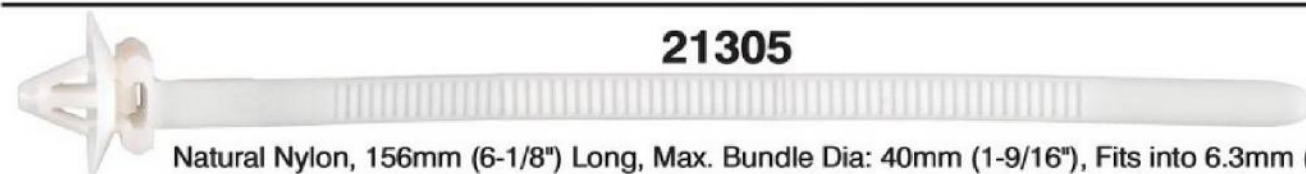

**21305**  
Natural Nylon, 156mm (6-1/8") Long, Max. Bundle Dia: 40mm (1-9/16"), Fits into 6.3mm (1/4") Hole  
UNIT PACKAGE: 25

## CABLE & HARNESS STRAPS

**20655**

(Mercedes: 114-997-02-90)

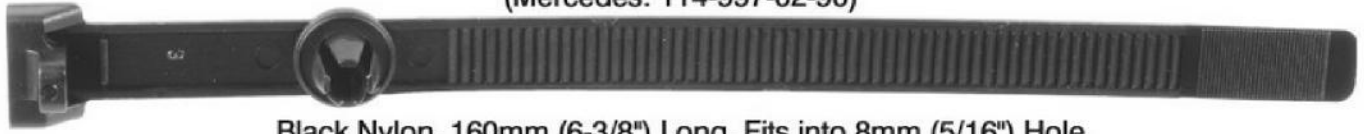

Black Nylon, 160mm (6-3/8") Long, Fits into 8mm (5/16") Hole

UNIT PACKAGE: 10

**21355**



Black Nylon, 160mm (6-3/8") Long, Max. Bundle Diameter: 36mm (1-13/32"), Fits into 7mm Hole

UNIT PACKAGE: 25

**10649**

(GM: 3816659, 19130464)



Black Nylon, 6-1/2" Long

UNIT PACKAGE: 10

**21553**

(Toyota: 82711-12200) • *Photo not actual size*



Black Nylon, 170mm (6-3/4") Long, Max. Bundle Dia.: 40mm (1-9/16"), Fits into 13mm (1/2") Hole

UNIT PACKAGE: 25

**21310**



Black Nylon, 174MM (6-15/16") Long, Max. Bundle Diameter: 40mm (1-9/16"), Fits into 13mm (1/2") Hole

UNIT PACKAGE: 25

**20380**

*Photo not actual size*

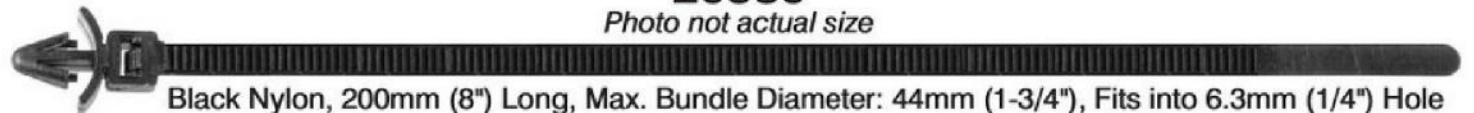

Black Nylon, 200mm (8") Long, Max. Bundle Diameter: 44mm (1-3/4"), Fits into 6.3mm (1/4") Hole

UNIT PACKAGE: 25

**21259**

(Nissan: 24225-89960)  
*Photo not actual size*



Black Nylon, 200mm (8") Long, Max. Bundle Diameter: 55mm (2-3/16"), Fits into 8mm (5/16") Hole

UNIT PACKAGE: 25

# CABLE & HARNESS STRAPS

*Photos not actual size*

## Self-Clamping Natural Nylon Straps

Reusable



Part No.	Tensile Strength	Strap Length	Max Bundle Dia.	Width	Unit Pkg.
10217	18 lb.	3-7/8"	3/4"	3/32"	10
9637	50 lb.	14-7/8"	4"	3/16"	10
10218	120 lb.	14-1/2"	4"	9/32"	10

## Black Nylon Cable Ties Self Clamping



Part No.	Tensile Strength	Length	Width	Unit Pkg.
15144	18 lb.	4"	3/32"	100
15196	18 lb.	4"	3/32"	1000
15145	30 lb.	5-1/2"	1/8"	100
15197	30 lb.	5-1/2"	1/8"	1000
15146	50 lb.	7"	3/16"	50
15198	50 lb.	7"	3/16"	1000
15147	50 lb.	11"	3/16"	50
15199	50 lb.	11"	3/16"	500
15753	50 lb.	14"	3/16"	25
15148	120 lb.	14"	5/16"	25
15200	120 lb.	14"	5/16"	500

## Natural Nylon Cable Ties Self Clamping



Auveco Part No.	Tensile Strength	Length	Width	Unit Pkg.
11953	18 lb.	3"	3/32"	50
11954	18 lb.	4"	3/32"	50
14836	18 lb.	4"	3/32"	100
15188	18 lb.	4"	3/32"	1000
11955	30 lb.	5"	1/8"	50
14837	30 lb.	5"	1/8"	100
15189	30 lb.	5"	1/8"	1000
11956	50 lb.	7"	5/32"	25
14838	50 lb.	7"	5/32"	50
15190	50 lb.	7"	5/32"	1000
11957	50 lb.	11"	5/32"	25
14839	50 lb.	11"	5/32"	50
15191	50 lb.	11"	5/32"	500
15754	50 lb.	14"	5/32"	25
11958	120 lb.	14"	9/32"	10
14840	120 lb.	14"	9/32"	25
15192	120 lb.	14"	9/32"	500

## Black Nylon Cable Ties Self-Clamping with Mounting Hole



Part No.	Tensile Strength	Length	Screw Hole Size	Width	Unit Pkg.
15150	50 lb.	7-1/2"	#10	3/16"	50
15202	50 lb.	7-1/2"	#10	3/16"	250
15151	120 lb.	14-3/4"	#14	5/16"	25
15203	120 lb.	14-3/4"	#14	5/16"	200

## Natural Nylon Cable Ties Self-Clamping with Mounting Hole



Part No.	Tensile Strength	Length	Screw Hole Size	Width	Unit Pkg.
11961	50 lb.	7"	#10	5/32"	50
15194	50 lb.	7"	#10	5/32"	250
11963	120 lb.	13"	#14	9/32"	10



**14568**  
Cable Tie Tool



1. Feed Cable Tie in tool head, pull trigger to tension



2. Hold trigger tension and twist tool 1/2 turn.

A light-weight, durable hand tool that's perfect for installing cable ties. The tool works on 18 pound, 30 pound, 40 pound, and 50 pound tensile rated cable ties. Length: 6-1/4". Made of rugged plastic.

UNIT PACKAGE: 1

## Cable Tie Mount with Adhesive

Uses a #6 flat head screw or 1/8" flat head rivet. Features a 4 way insertion and accepts 18, 30, and 50 pound cable ties. 1" x 1" Adhesive backing



**12361**  
Natural Nylon

UNIT PACKAGE: 10



**16001**  
Black Nylon

UNIT PACKAGE: 10