



**FURNISYS**  
Functional Furniture Systems

## Brand Overview

Workstation and Workbenches  
Cabinets and Storage Sytem  
[www.furnisys.co.in](http://www.furnisys.co.in)

# Our Story

## 2018 — The Beginning:

We entered under the brand name **FURNACE** into the workspace furniture industry, creating customized solutions for education and manufacturing sectors, and served over 104+ satisfied clients.

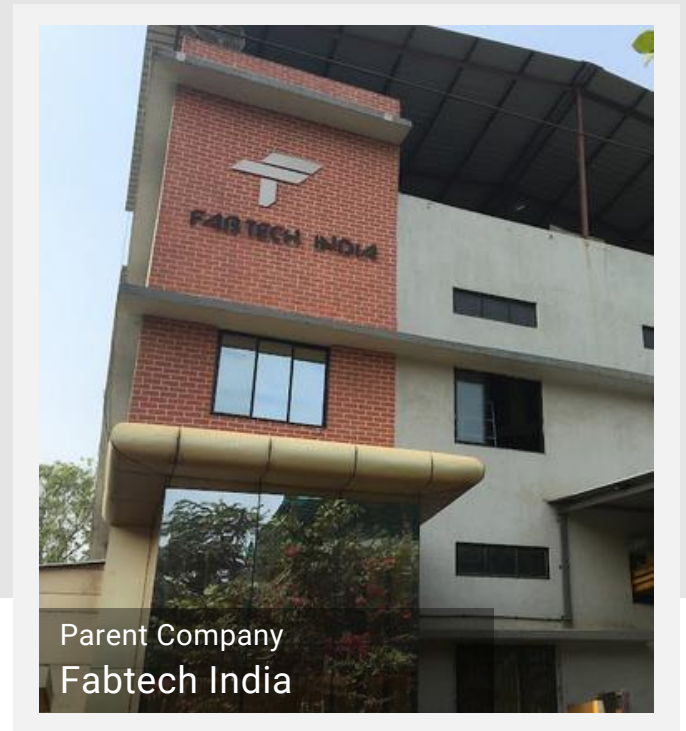

## Manufacturing



Workbenches



Lockers



Storage System



Compactors

## Education & Training



Bio Lab



Chemistry Lab



Physics Lab

## Today — The Evolution:

As work environments evolved, **FURNACE** transformed into **FURNISYS** — a brand that delivers custom solutions but also modular, configurable, and scalable systems for companies moving towards standardization, adapting seamlessly across industries and applications.

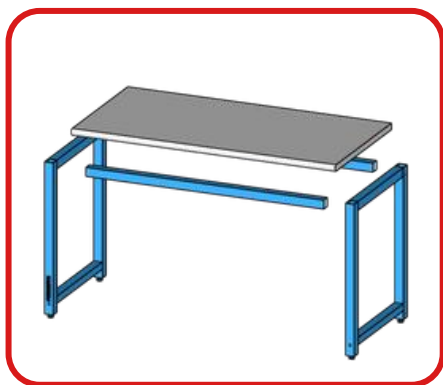
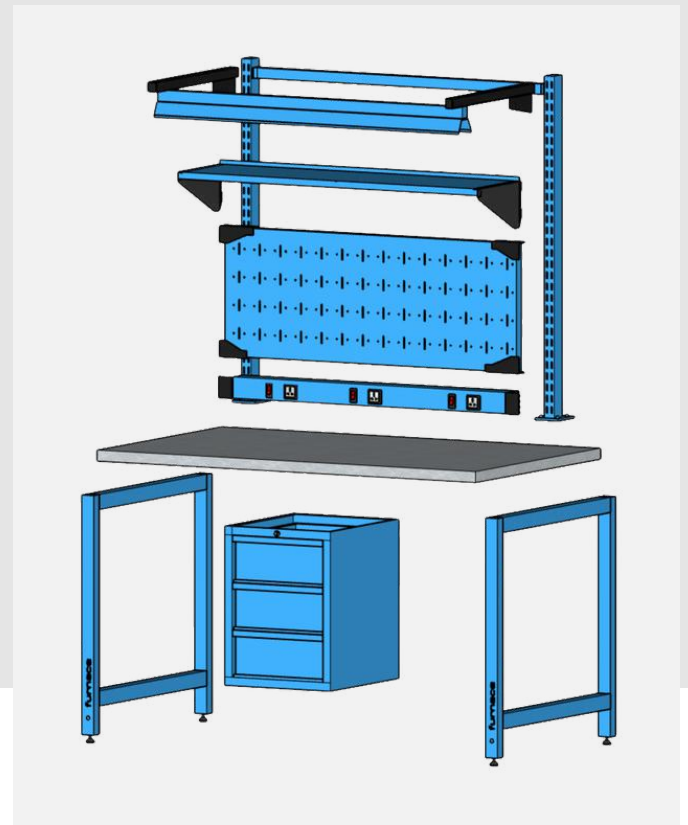

### Modular by Design

Built for scalability and smart investment - modules expand or reconfigure effortlessly as operations grow.

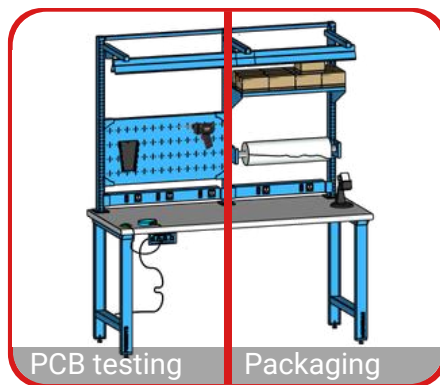

### Configurable for Every Application

Tailored to every environment - from precise educational setups to efficient manufacturing zones, ensuring a cohesive workspace ecosystem.



### Flexible & Adaptable

Engineered for change - easily aligns with new processes, technologies, or layouts for long-term value and relevance.

# Manufacturing Infra:

Furnisys delivers end-to-end manufacturing in a 22,000 sq. ft. state-of-the-art facility in Navi Mumbai, covering precise material cutting, CNC bending, selective welding, advanced chemical pre-treatment, high-quality powder coating, meticulous assembly, rigorous inspection, and seamless installation, ensuring robust, modular workspace solutions with superior quality and fast lead times.



# Our Value Chain

## Product/ Program

Defines and governs the system, what we build, why it exists, and how it scales.

---

## Sales/ Marketing

Connects the system to real applications and the right customers.

---

## Design

Designs and governs the system.

---

## Manufacturing

Builds with consistency, quality, and repeatability at scale.

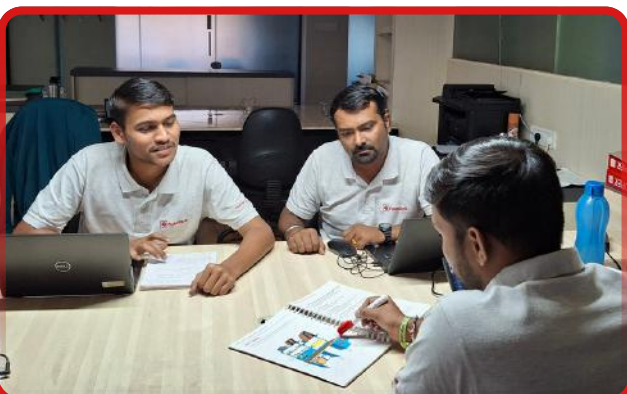
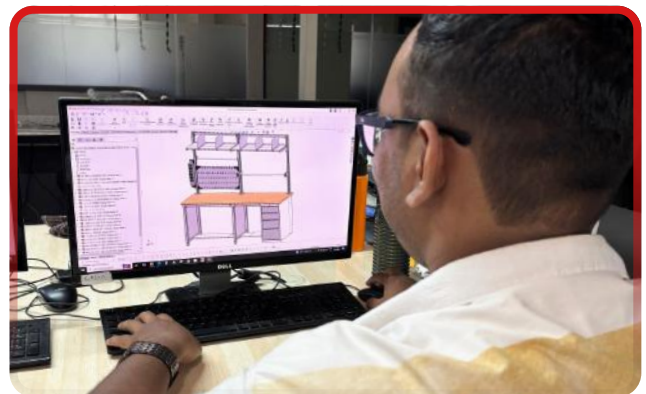



# SOLUTIONS



**Manufacturing**



**Metalworking**



**Construction**



**Healthcare**



**Education & Training**



**Power Generation**



**Oil, Gas & Mining**



**Jobsite Solutions**



**Agriculture & Outdoor**



**Aerospace & Aviation**



**Automotive & Agricultural Dealers**



**Museums, Libraries & Archives**

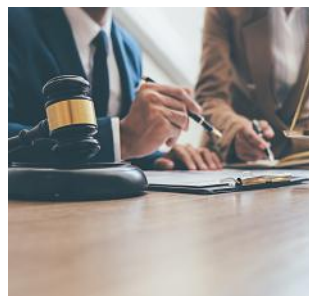

**Government, Military & Law Enforcement**

A workshop or garage setting. On the left, a black metal tool rack is mounted on the wall, holding various tools like wrenches, sockets, and pliers. Below the rack is a workbench with a white top and several drawers. Some drawers are open, showing tools and supplies inside. To the right, a large black rolling tool chest with multiple drawers is visible. The floor is covered with a patterned carpet. The ceiling has recessed lighting.

# PRODUCTS

**WORK  
SYSTEM**

Workbenches  
Link System  
Flexi System

**STORAGE  
SYSTEM**

Base Cabinet  
Mobile Cabinet

# WORKBENCHES

Furnisys offers a diverse range of workbenches designed to bring a perfect balance amongst environmental and operational within a manufacturing workspace. Each of these workbenches can be expanded and converted into a Work Station using the Link Uprighter System.

## Base Series

All purpose workbench series designed to functionally serve your basic workspace needs.

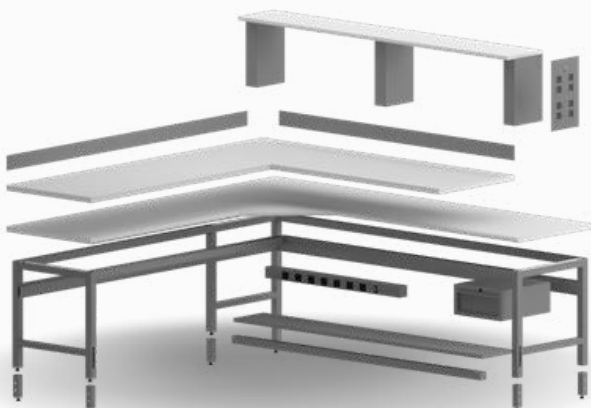

## Scitec Series

An adaptable workbench series designed for diverse technical environment.

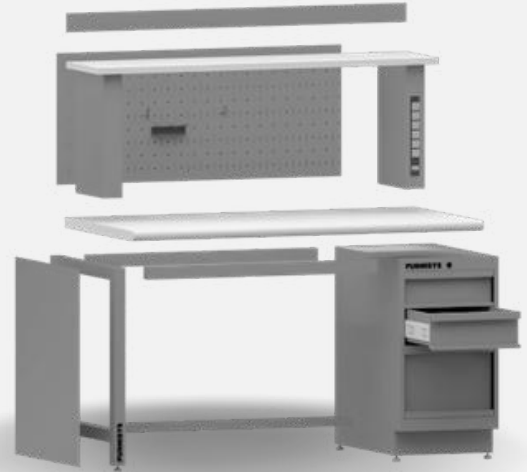

## Pro Series

An industrial grade workbench series designed to withstand rough work environments.



# LINK SYSTEM

A functional system consisting of uprighters, auxiliary workstands, ancillary trolleys, and flow racks. The uprighters are designed to integrate seamlessly with the Base, Pro, Scitec, and Pack Workbench Series, as well as any existing workbench at the buyer's end. The auxiliary stands, ancillary trolleys, and flow racks can be utilized independently or integrated with each other, providing enhanced flexibility and support for diverse operational needs.

## Uprighter

Enhance the efficiency of any of our workbenches by integrating the link uprighter system with it. Link Uprighter can also be independently used by fixing it to a wall.

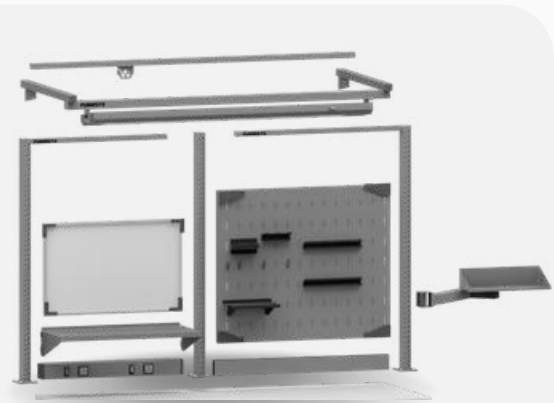

## Work Stand

Seamlessly integrate it into your production, assembly, or repair workspace. It's the ideal solution for securely holding or transporting all your Work-in-Progress (WIP) inventory, including parts, tools, and equipment.

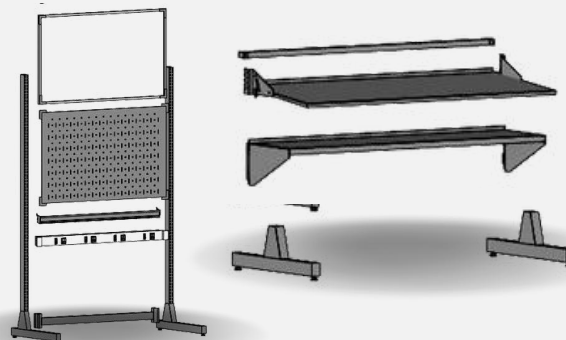

## Trolley

A space-saving, cost-effective solution for efficient material transport. Its self-sufficient frame accommodates various accessories and a functional worksurface, maximizing utility while minimizing footprint.

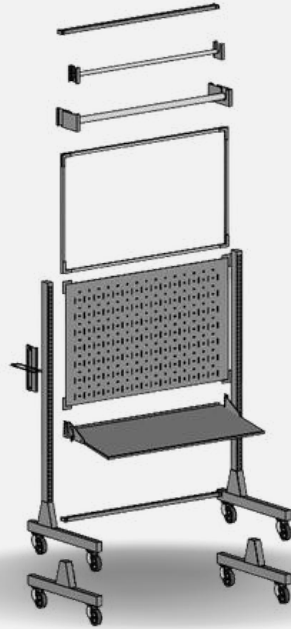

## Flow Rack

Link Flow Racks is a functional material handling solution to feed parts for picking, kitting and assembly operations. Having a gravity based part feeding mechanism helps reduce the need for helpers.

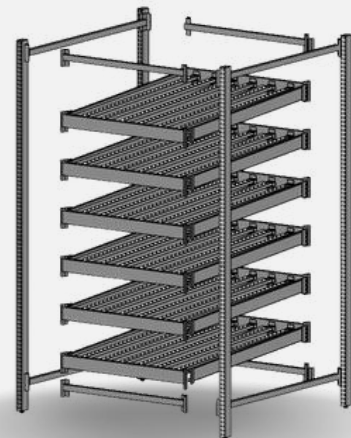

# FLEXI SYSTEM

The most flexible independent work system, designed to seamlessly transition into various product ranges from Workbench, Carts to Flow Racks. Its unique micro and macro slot system enables maximum configurations and eases cross-product integration within its ecosystem.

## Work Station

Flexi Workstations is our most flexible workstation series which can not only easily adapt to a user's present needs but also reconfigure to cater the user's future needs. The flexibility behind these workstations can help achieve the maximum productivity per square foot.

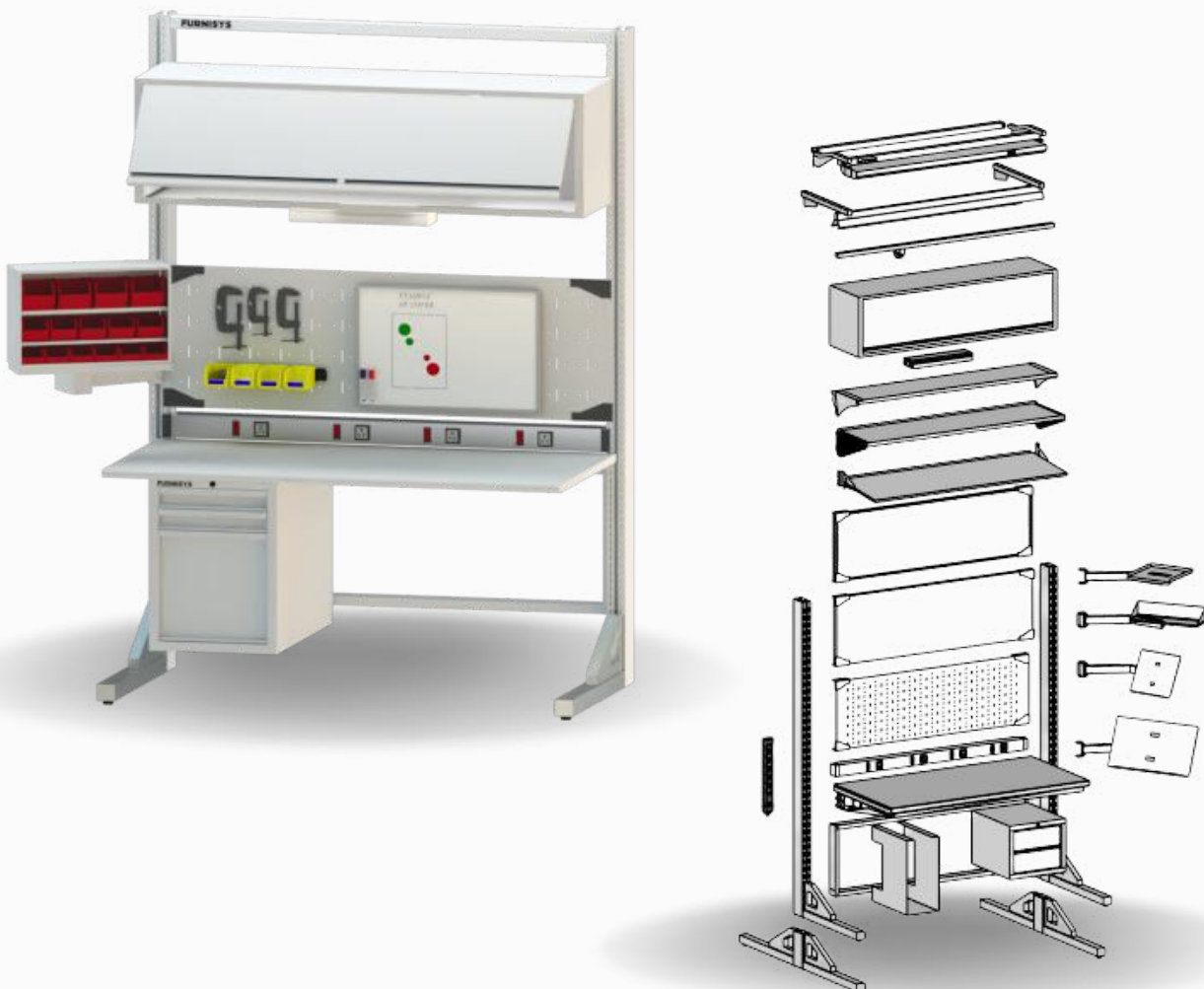

## Universal Cart

Flexi Universal Cart flexible can be used for organizing, storing and moving part, tools and equipment around various departments. All of the accessories on the flexi workstations can be interchangeable with Flexi Universal Cart.

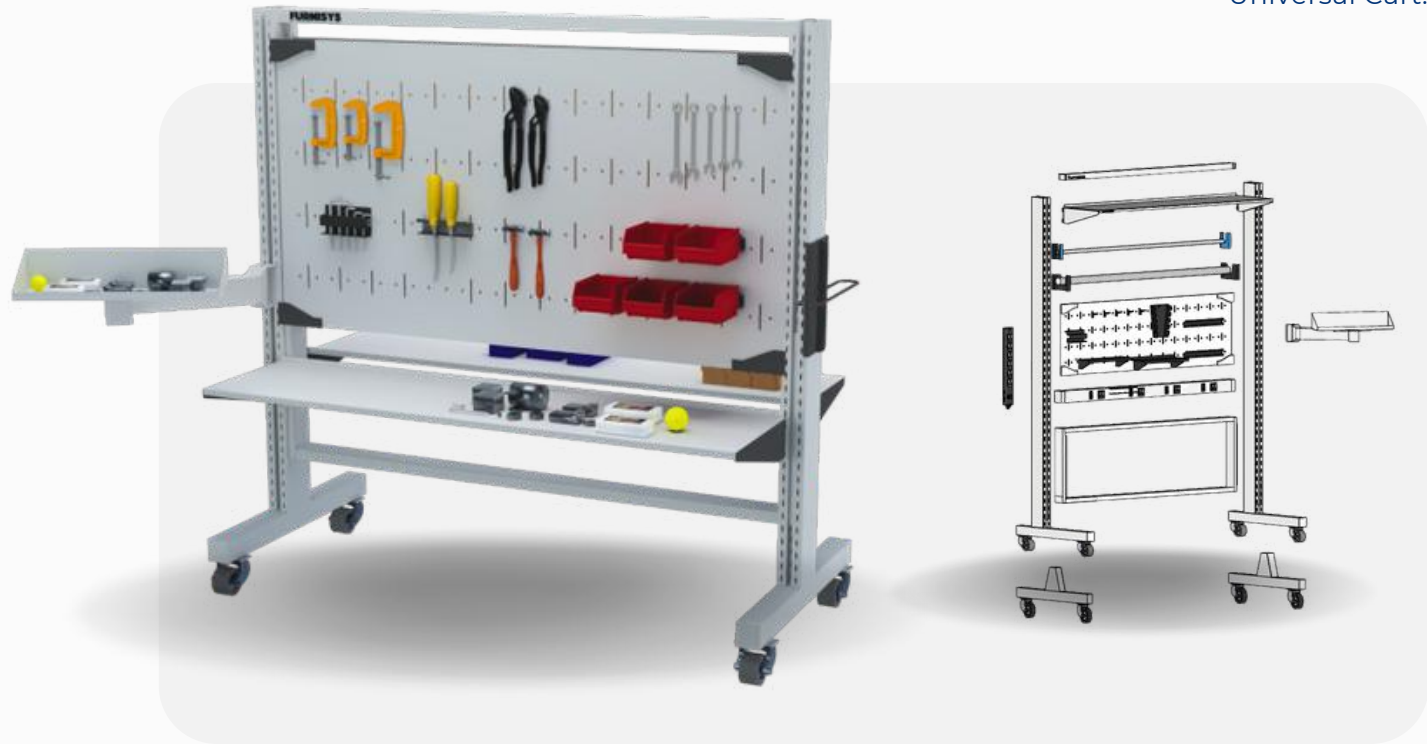

## Flow Rack

Flow racks can be used to stage and deliver parts utilizing gravity, reducing material handling time and costs. Bins or totes are loaded on flow rack frames from the rear, and as operators remove one from the front, a new bin glides forward on rollers.



# STORAGE SYSTEM

Furnisys cabinet range is designed to achieve complete organization of parts, tools and equipment. Our extensive range enables maximised use of the cubic capacity of the space.

## Base Cabinet

Furnisys offers an extensive range of cabinets with multiple size and drawer options. Its heavy duty construction enables them to withstand heavy storage needs.



## Mobile Cabinet

Furnisys mobile cabinets can be used in cases when a workflow would require storage plus mobility.

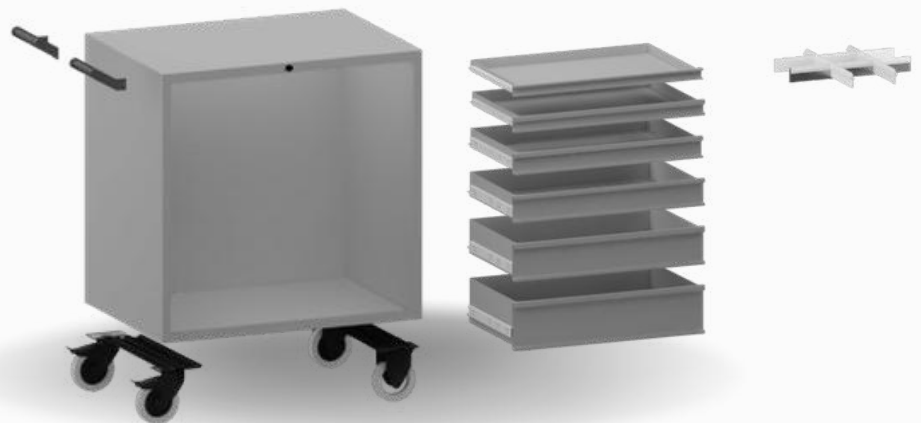

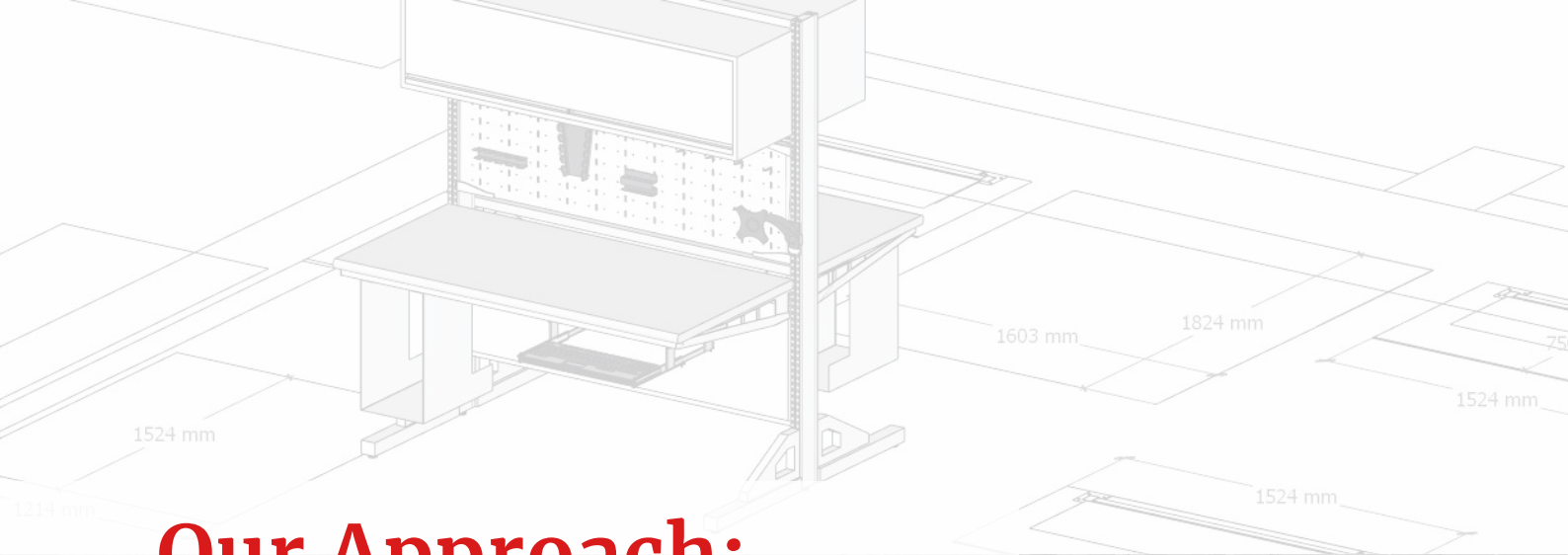

## Our Approach:





## Free Consultation

- Talk with our technical experts
- ROI analysis and justification
- Product configuration, project alignment, and budget planning

## Planning Competency

- Techno-commercials delivered within 48 hours\*
- 3D and 2D Product Visuals
- 2D Space Visuals

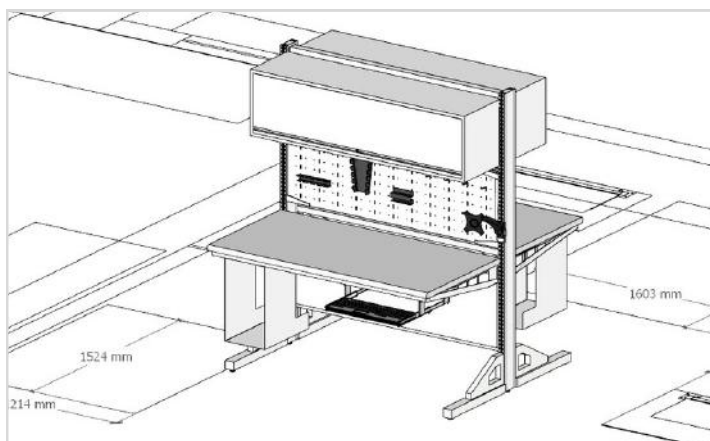

## Efficient Delivery

- Manufactured within 4 weeks\*
- Engineered and manufactured in-house

## Professional Installation

- The Perfect Finish
- Easy to follow assembly instructions
- Self-assembly Friendly



# Photo Gallery:

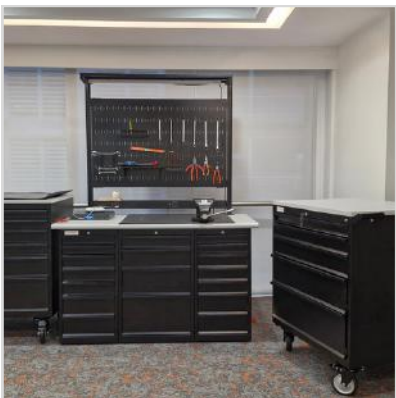
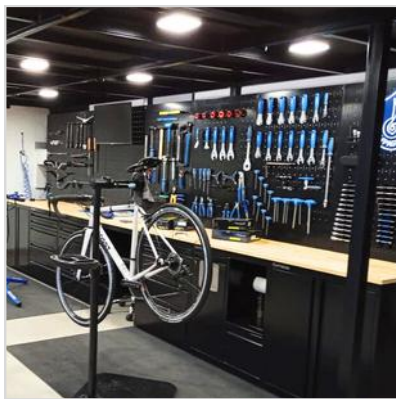
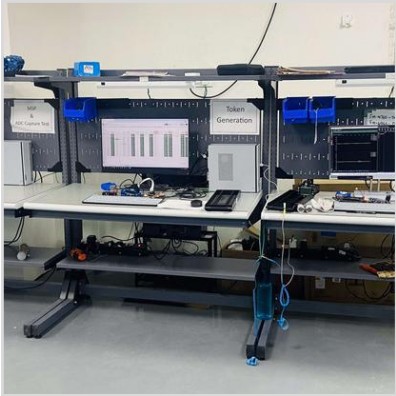

# Clientele:

adani™



Smith+Nephew

SHIMANO®



LIEBHERR



KOHLER®



Dräger



KOHLI





Scan to explore product literature

   / FURNISYS.CO.IN



**FURNISYS**  
Functional Furniture Systems

 [enquiry@furnisys.co](mailto:enquiry@furnisys.co)

 [www.furnisys.co.in](http://www.furnisys.co.in)

 + 91 7045763012

 Fabtech India, EL-21 TTC Industrial  
Area, Mahape, Navi Mumbai - 400 710

[www.furnisys.co.in](http://www.furnisys.co.in)