

MADE TO ORDER PRODUCT GUIDE

OAKSTREETMFG.COM

(877) 465-4344



Table Tops - Made to Order

The Oak Street Advantage

With the latest manufacturing equipment and state of the art automation processes, Oak Street has the capabilities to handle any project - large or small.

Oak Street firmly believes in innovation, advancing technology and automation, which allows our manufacturing capabilities and product offerings to increase and improve while reducing costs.

- 20+ table top styles
- 25 common size offerings
 - Unlimited custom size capabilities
- 20+ in-house stain options with endless custom stain capabilities
- Unmatched precision and consistency
- Industry standard lead times
- Customizations are endless - from large to small



FREE FREIGHT!

on Table Tops using:

PINNACLE
DECORATIVE LAMINATES

150+ decors to choose from!

3mm PVC



Fortress



Inlay



Overlay



Retro T-Mold



Rubber T-Mold



- Free freight applies to table top portion of order only.
- Promotion length subject to cease without warning.

- Pinnacle Decorative Laminates brand laminate must be used.
- Table top portion of order must exceed \$1,000 to be eligible.

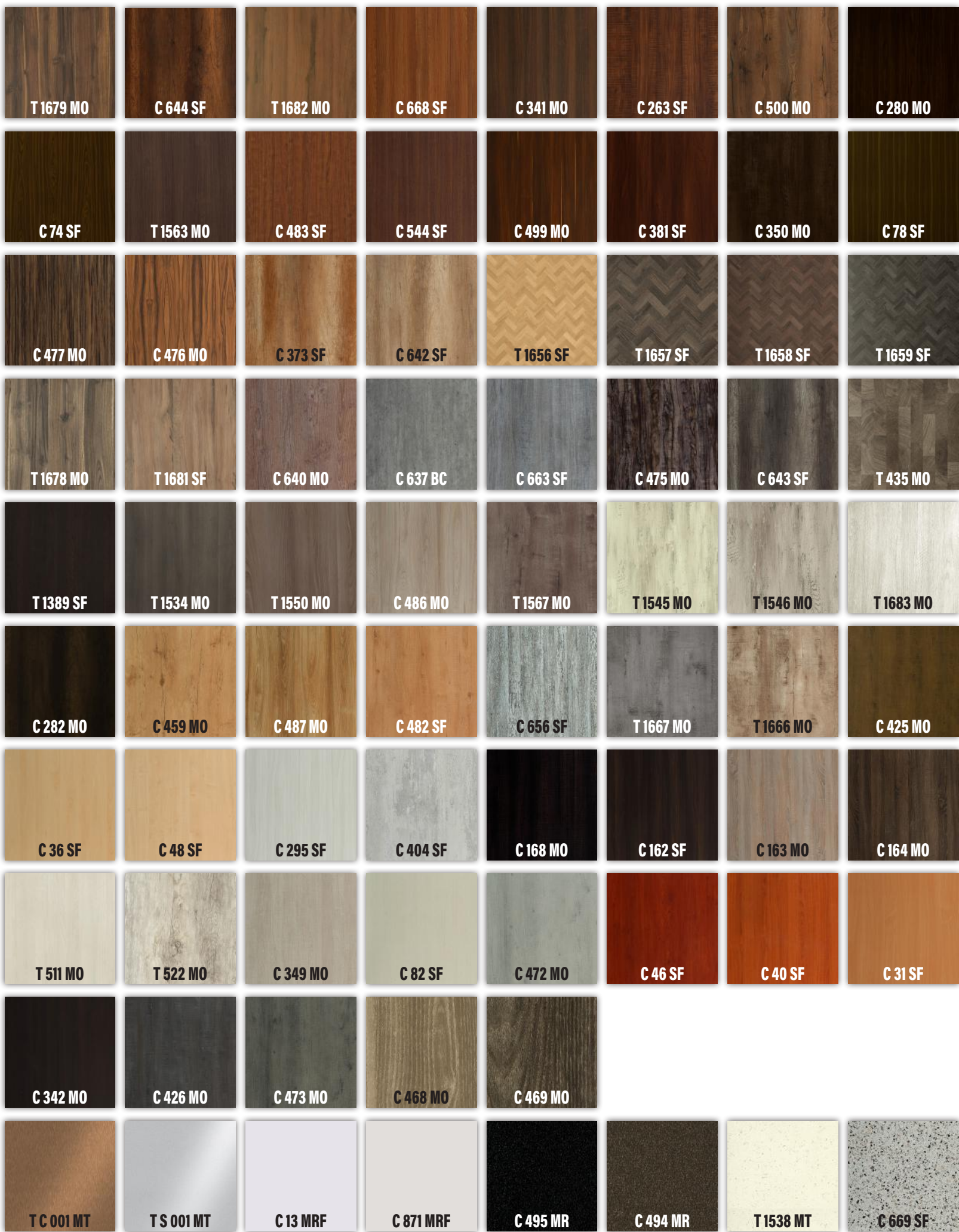



Definitions of finish code suffixes are as follows:

- SF - standard/matte finish
- MO - wood grain finish
- MR - gloss finish
- SM - satin finish
- LN - tweed finish
- LM - slate finish
- OR - concrete finish
- CZ+PM - diamond finish
- MRF - flecked gloss finish
- CC - fiber finish
- GM - linen finish
- BC - stone finish
- MT - metallic finish
- NM - no marks finish



Backwoods



Roble



Smoked Oak



Barn Wood Gray



Stormy Skies

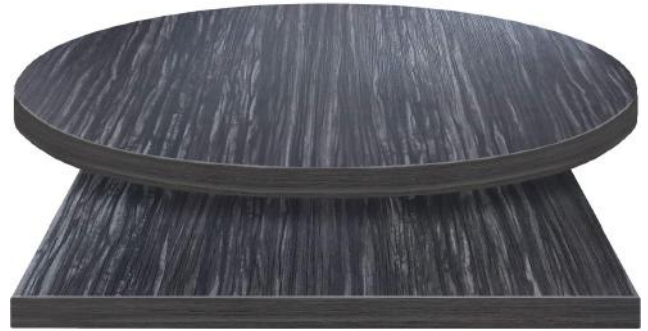

Gun Powder



Natural Bamboo



Roble



Smoked Oak



Barn Wood Gray



Stormy Skies



Gun Powder



Natural Bamboo





- Particle board construction with durable laminate top
- Specialty laminate has the look & feel of wood grain
- BW1 tops: 1-1/8" nominal thickness
- BW2 tops: 1-1/8" nominal core + 7/8" nominal dropped edge = 2" overall edge thickness
- Coordinating 3mm thick PVC edge
- Each top created & hand finished to order
- For indoor use only | All tops boxed
- Table tops over 48" subject to a crate fee per pallet (fee/service optional on 3rd party shipments)

ADDITIONAL INFORMATION

- Non-standard sizes carry a setup fee per size
- Orders with less than 4 tops incur a small order fee
- Pre-drilled tops for Oak Street bases available for an upcharge per table

Smoked Oak



Roble



Gun Powder



Stormy Skies



Barn Wood Gray



Natural Bamboo



Table Size	BW1 Part #	Approx. Weight	BW2 Part #	Approx. Weight
24" x 24"	BW1-2424	15 lbs	BW2-2424	17 lbs
24" x 30"	BW1-2430	18 lbs	BW2-2430	21 lbs
24" x 42"	BW1-2442	25 lbs	BW2-2442	29 lbs
24" x 48"	BW1-2448	29 lbs	BW2-2448	33 lbs
24" x 60"	BW1-2460	36 lbs	BW2-2460	42 lbs
24" x 72"	BW1-2472	43 lbs	BW2-2472	50 lbs
24" x 96"	BW1-2496	57 lbs	BW2-2496	66 lbs
30" x 30"	BW1-3030	22 lbs	BW2-3030	26 lbs
30" x 42"	BW1-3042	31 lbs	BW2-3042	36 lbs
30" x 48"	BW1-3048	36 lbs	BW2-3048	42 lbs
30" x 60"	BW1-3060	44 lbs	BW2-3060	52 lbs
30" x 72"	BW1-3072	53 lbs	BW2-3072	62 lbs
30" x 96"	BW1-3096	71 lbs	BW2-3096	83 lbs
36" x 36"	BW1-3636	32 lbs	BW2-3636	37 lbs
36" x 48"	BW1-3648	43 lbs	BW2-3648	50 lbs
36" x 60"	BW1-3660	53 lbs	BW2-3660	62 lbs
36" x 72"	BW1-3672	64 lbs	BW2-3672	74 lbs
42" x 42"	BW1-4242	44 lbs	BW2-4242	51 lbs
48" x 48"	BW1-4848	57 lbs	BW2-4848	66 lbs
24" Round	BW1-24R	12 lbs	BW2-24R	13 lbs
30" Round	BW1-30R	18 lbs	BW2-30R	21 lbs
36" Round	BW1-36R	25 lbs	BW2-36R	30 lbs
42" Round	BW1-42R	34 lbs	BW2-42R	40 lbs
48" Round	BW1-48R	45 lbs	BW2-48R	52 lbs



Roble



Barn Wood Gray





3mm



Table Size	Part #	Approx. Weight
24" x 24"	3MM2424	23 lbs
24" x 30"	3MM2430	28 lbs
24" x 42"	3MM2442	40 lbs
24" x 48"	3MM2448	45 lbs
24" x 60"	3MM2460	56 lbs
24" x 72"	3MM2472	68 lbs
24" x 96"	3MM2496	90 lbs
30" x 30"	3MM3030	35 lbs
30" x 42"	3MM3042	49 lbs
30" x 48"	3MM3048	56 lbs
30" x 60"	3MM3060	70 lbs
30" x 72"	3MM3072	84 lbs
30" x 96"	3MM3096	112 lbs
36" x 36"	3MM3636	51 lbs
36" x 48"	3MM3648	68 lbs
36" x 60"	3MM3660	84 lbs
36" x 72"	3MM3672	101 lbs
42" x 42"	3MM4242	69 lbs
48" x 48"	3MM4848	90 lbs
24" Round	3MM24R	18 lbs
30" Round	3MM30R	28 lbs
36" Round	3MM36R	40 lbs
42" Round	3MM42R	54 lbs
48" Round	3MM48R	71 lbs
60" Round	3MM60R	110 lbs

- 1-1/4" thick, 45 lb industrial grade particle board with high-pressure laminate
- Edged with 3mm PVC
- List pricing based on Tier 1 Pinnacle & standard Formica -58 & -43 finish laminates - upcharge for Wilsonart & Tier 2+ Pinnacle & Formica laminates
- ALSO OFFERING in-house laminate options with matching 3mm edge (standard list pricing - no upcharge!) - *shown above*
- In-house solid color 3mm edge include: white, taupe, smoke, nubian brown & black - *shown below*
- Custom matching laminates & matching edges available for an upcharge
- For indoor use only | All tops boxed

ADDITIONAL INFORMATION

- Non-standard sizes carry a setup fee per size
- Orders with less than 4 tops incur a small order fee
- Pre-drilled tops for Oak Street bases available for an upcharge per table
- Table tops over 48" subject to a crate fee per pallet (fee/service optional on 3rd party shipments)

Nubian Brown

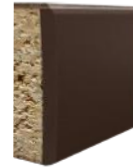

Taupe



Black



Smoke



White





3mm

Table Tops - Made to Order



Formica Planked Urban Oak
9312-58

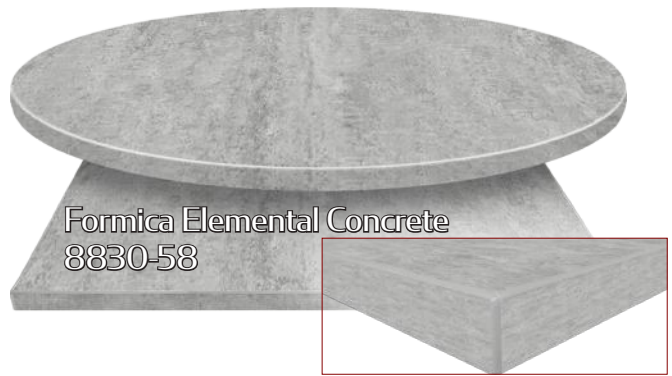

Formica Elemental Concrete
8830-58



Formica Black Walnut
3485-58



Formica Carrara Bianco
6696-58



Formica Natural Maple (shown)
756-58

More laminate options available -
view at bit.ly/osmlaminates

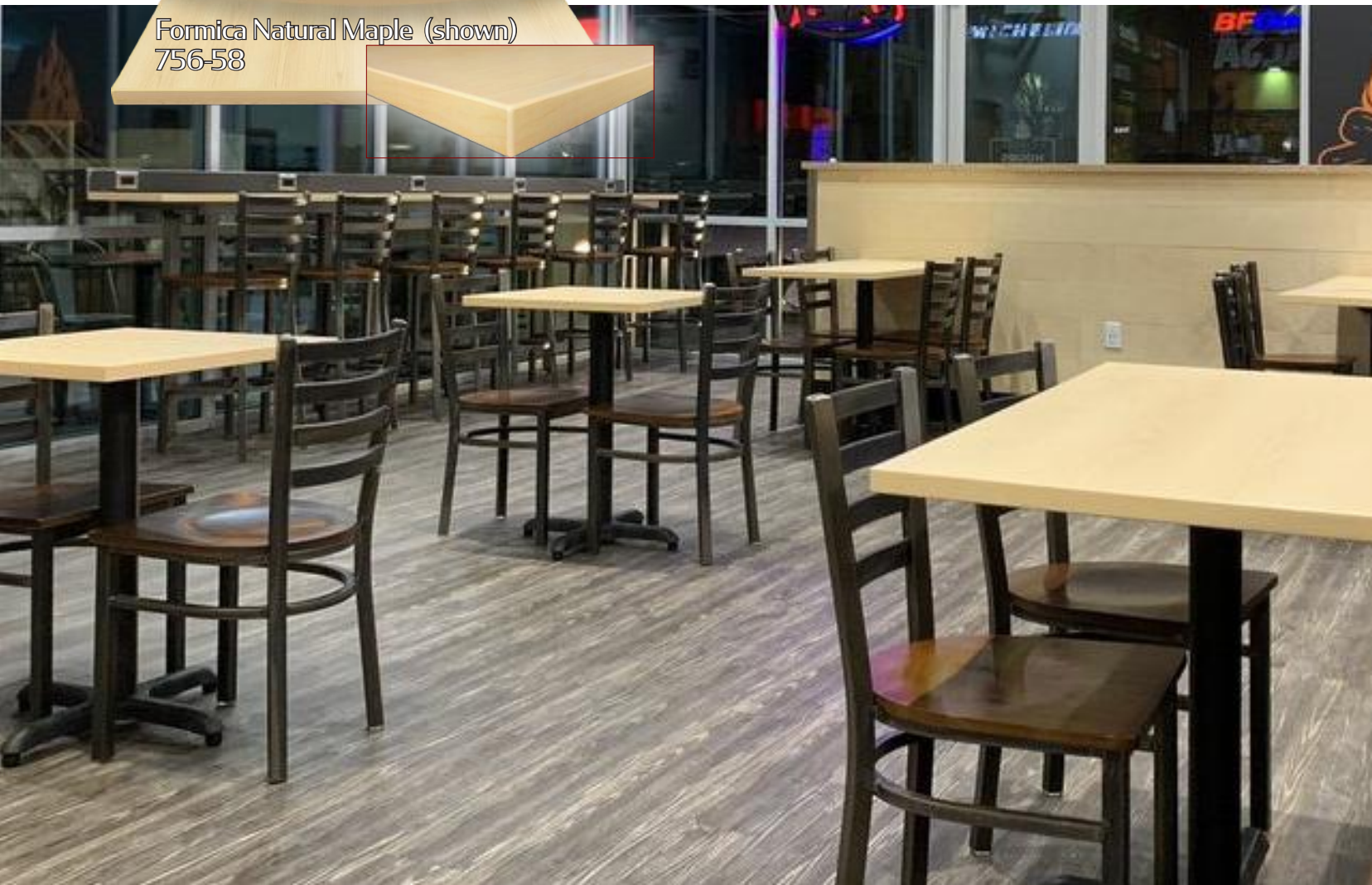

Complementary Laminates + Edges



HW Smoke
Rubber T-Mold



Smoke
3mm PVC

B-Brown
Rubber T-Mold



Nubian Brown
3mm PVC

It's recommended to order samples of laminate & edge choice prior to order.

The images are a representation only & are not intended to provide a perfect match to the actual product.

PINNACLE DECORATIVE LAMINATES

Laminates shown are complementary to the associated edge color options.

Any available laminate can be ordered with any edge color option.

HW Taupe
Rubber T-Mold



Taupe
3mm PVC

White
Rubber T-Mold



White
3mm PVC



Complementary Laminates + Edges

Black Rubber T-Mold



Pinnacle CZ+PM 1177
Black Diamond



Pinnacle C 641 MR
Ashen Marble



Pinnacle C 495 MR
Black Pearl

HW Brown Rubber T-Mold



Pinnacle C 659 SF
Oxidized Slate



Pinnacle T 1567 MO
White River Birch



Pinnacle C 305 SF
Espresso Twist



Black 3mm PVC



Pinnacle C 637 BC
Brooklyn Light



Pinnacle C 687 LM
Mandu Slate



Pinnacle T S 001 MT
Steel Metallic



Pinnacle C 164 MO
Rustic Oak



Pinnacle C 462 MR
Mocha Marble



Pinnacle C 642 SF
Vintage Oak

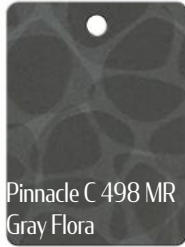

Pinnacle C 498 MR
Gray Flora



Pinnacle T 1667 MO
Delta Willow

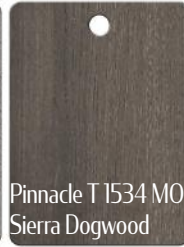

Pinnacle T 1534 MO
Sierra Dogwood



Pinnacle C 477 MO
Locust Wood



Pinnacle T 1666 MO
Coronado Oak



Pinnacle T 1657 SF
Engelmann Spruce

It's recommended to order samples of laminate & edge choice prior to order.

The images are a representation only & are not intended to provide a perfect match to the actual product.

PINNACLE DECORATIVE LAMINATES

Laminates shown are complementary to the associated edge color options.

Any available laminate can be ordered with any edge color option.

HW Platinum Rubber T-Mold



Pinnacle C 404 SF
Snow Painted Metal



Pinnacle T 1538 MT
Flecked Quartz



Pinnacle C 671 MR
Copper Slate

HW Greystone Rubber T-Mold



Pinnacle T 669 SF
Maremma



Pinnacle T 529 SM
Dove Herringbone



Pinnacle T 522 MO
Ponderosa Pine



Pinnacle C 478 GM
Light Crystal Concrete



Pinnacle C 480 SF
Gray Washed Tweed



Pinnacle C 656 SF
Montpelier



Pinnacle C 469 MO
Potent Ash



Pinnacle C 537 SF
Light Filament



Pinnacle C 494 MR
Gray Pearl



Pinnacle C 13 MRF
Frost Pearl



Pinnacle T 1546 MO
Shawnee Beech



Pinnacle T 1214 SF
Modern Marble



Pinnacle C 541 SF
Khadim Twist



Pinnacle C 479 GM
Dark Crystal Concrete



Pinnacle C 461 MR
Ashen Marble

T-Mold



- 1-1/4" thick, 45 lb industrial grade particle board with high-pressure laminate
- 3" radius corners standard
- Edged with high-quality rubber t-mold in choice of in-house colors (shown below)
- List pricing based on Tier 1 Pinnacle & standard Formica -58 & -43 finish laminates - upcharge for Wilsonart & Tier 2+ Pinnacle & Formica laminates
- Additional laminates, including Nevamar & Pionite available for an upcharge
- For indoor use only | All tops boxed

More laminate options available - view at bit.ly/osmlaminates



Pinnacle C 659 SF Oxidized Slate laminate* - HW Brown t-mold edge
* Tier 1 laminate



Pinnacle C 99 SF Slate Gray laminate* - Black t-mold edge
* Tier 1 laminate



Pinnacle C 538 SF Dark Filament laminate* - HW Taupe t-mold edge
* Tier 1 laminate



Pinnacle C 404 SF Snow Painted Metal laminate* - HW Smoke t-mold edge
* Tier 1 laminate



Pinnacle C 656 SF Montpelier laminate* - HW Platinum t-mold edge
* Tier 1 laminate



Pinnacle C 469 MO Potent Ash laminate* - HW Greystone t-mold edge
* Tier 1 laminate



Table Size	Part #	Approx. Weight
24" x 24"	CTM2424	23 lbs
24" x 30"	CTM2430	28 lbs
24" x 42"	CTM2442	40 lbs
24" x 48"	CTM2448	45 lbs
24" x 60"	CTM2460	56 lbs
24" x 72"	CTM2472	68 lbs
24" x 96"	CTM2496	90 lbs
30" x 30"	CTM3030	35 lbs
30" x 42"	CTM3042	49 lbs
30" x 48"	CTM3048	56 lbs
30" x 60"	CTM3060	70 lbs
30" x 72"	CTM3072	84 lbs
30" x 96"	CTM3096	112 lbs
36" x 36"	CTM3636	51 lbs
36" x 48"	CTM3648	68 lbs
36" x 60"	CTM3660	84 lbs
36" x 72"	CTM3672	101 lbs
42" x 42"	CTM4242	69 lbs
48" x 48"	CTM4848	90 lbs
24" Round	CTM24R	18 lbs
30" Round	CTM30R	28 lbs
36" Round	CTM36R	40 lbs
42" Round	CTM42R	54 lbs
48" Round	CTM48R	71 lbs
60" Round	CTM60R	110 lbs



Retro T-Mold

- 1-1/4" thick, 45 lb industrial grade particle board with high-pressure laminate
- 3" radius corners standard
- Edged with high-quality rubber rippled t-mold in metallic silver (shown below)
- List pricing based on Tier 1 Pinnacle & standard Formica -58 & -43 finish laminates - upcharge for Wilsonart & Tier 2+ Pinnacle & Formica laminates
- Additional laminates, including Nevamar & Pionite available for an upcharge
- For indoor use only | All tops boxed



Table Tops - Made to Order



More laminate options available -
view at bit.ly/osmlaminates

Table Size	Part #	Approx. Weight
24" x 24"	RT2424	23 lbs
24" x 30"	RT2430	28 lbs
24" x 42"	RT2442	40 lbs
24" x 48"	RT2448	45 lbs
24" x 60"	RT2460	56 lbs
24" x 72"	RT2472	68 lbs
24" x 96"	RT2496	90 lbs
30" x 30"	RT3030	35 lbs
30" x 42"	RT3042	49 lbs
30" x 48"	RT3048	56 lbs
30" x 60"	RT3060	70 lbs
30" x 72"	RT3072	84 lbs
30" x 96"	RT3096	112 lbs
36" x 36"	RT3636	51 lbs
36" x 48"	RT3648	68 lbs
36" x 60"	RT3660	84 lbs
36" x 72"	RT3672	101 lbs
42" x 42"	RT4242	69 lbs
48" x 48"	RT4848	90 lbs
24" Round	RT24R	18 lbs
30" Round	RT30R	28 lbs
36" Round	RT36R	40 lbs
42" Round	RT42R	54 lbs
48" Round	RT48R	71 lbs
60" Round	RT60R	110 lbs

Darkwash



- Reclaimed look with consistent performance
- Oak faced veneer stained in choice of stain/color then distressed and lastly a clear coat finish is applied
- CDE tops: 1-1/8" nominal thickness
- CDP tops: 1-1/8" nominal core + 7/8" nominal dropped edge = 2" overall edge thickness
- Edge profile options: Waterfall, Eased or Bullnose
- For indoor use only
- All tops boxed
- Table tops over 48" subject to a crate fee per pallet (fee/service optional on 3rd party shipments)



ADDITIONAL INFORMATION

- Non-standard sizes carry a setup fee per size
- Orders with less than 4 tops incur a small order fee
- Pre-drilled tops for Oak Street bases available for an upcharge per table

Walnut Dye



Black Dye



Table Size	~1-1/8" Part #	Approx. Weight	~2" Part #	Approx. Weight
24" x 24"	CDE2424	15 lbs	CDP2424	17 lbs
24" x 30"	CDE2430	18 lbs	CDP2430	21 lbs
24" x 42"	CDE2442	25 lbs	CDP2442	29 lbs
24" x 48"	CDE2448	29 lbs	CDP2448	33 lbs
24" x 60"	CDE2460	36 lbs	CDP2460	42 lbs
24" x 72"	CDE2472	43 lbs	CDP2472	50 lbs
24" x 96"	CDE2496	57 lbs	CDP2496	66 lbs
30" x 30"	CDE3030	22 lbs	CDP3030	26 lbs
30" x 42"	CDE3042	31 lbs	CDP3042	36 lbs
30" x 48"	CDE3048	36 lbs	CDP3048	42 lbs
30" x 60"	CDE3060	44 lbs	CDP3060	52 lbs
30" x 72"	CDE3072	53 lbs	CDP3072	62 lbs
30" x 96"	CDE3096	71 lbs	CDP3096	83 lbs
36" x 36"	CDE3636	32 lbs	CDP3636	37 lbs
36" x 48"	CDE3648	43 lbs	CDP3648	50 lbs
36" x 60"	CDE3660	53 lbs	CDP3660	62 lbs
36" x 72"	CDE3672	64 lbs	CDP3672	74 lbs
42" x 42"	CDE4242	44 lbs	CDP4242	51 lbs
48" x 48"	CDE4848	57 lbs	CDP4848	66 lbs
24" Round	CDE24R	12 lbs	CDP24R	13 lbs
30" Round	CDE30R	18 lbs	CDP30R	21 lbs
36" Round	CDE36R	25 lbs	CDP36R	30 lbs
42" Round	CDE42R	34 lbs	CDP42R	40 lbs
48" Round	CDE48R	45 lbs	CDP48R	52 lbs

 Please be aware that the rustic construction of this product lends itself to small voids. Because these hardwood veneers are a product of nature, each piece will have a variation in how it accepts the finishing process.



Eased



Bullnose



Waterfall





Whitewash

Table Tops - Made to Order

Black Dye Whitewash



Traditional Mahogany Whitewash



Clear Coat Whitewash



Eased

Bullnose

Waterfall

- Reclaimed look with consistent performance
- Each top created and hand finished to order
- Oak faced veneer stained in choice of stain/color then whitewashed & lastly a clear coat finish is applied
- WWE tops: ~1-1/8" thickness
- WWP tops: ~1-1/8" core + ~7/8" dropped edge = ~2" overall edge thickness
- Edge profile options: Waterfall, Eased or Bullnose (shown pg. 50)
- For indoor use only
- All tops boxed
- Table tops over 48" subject to a crate fee per pallet (fee/service optional on 3rd party shipments)

ADDITIONAL INFORMATION

- Non-standard sizes carry a setup fee per size
- Orders with less than 4 tops incur a small order fee
- Pre-drilled tops for Oak Street bases available for an upcharge



Please be aware that the rustic construction of this product lends itself to small voids.

Because these hardwood veneers are a product of nature, each piece will have a variation in how it accepts the finishing process.



Table Size	~1-1/8" Part #	Approx. Weight	~2" Part #	Approx. Weight
24" x 24"	WWE2424	15 lbs	WWP2424	17 lbs
24" x 30"	WWE2430	18 lbs	WWP2430	21 lbs
24" x 42"	WWE2442	25 lbs	WWP2442	29 lbs
24" x 48"	WWE2448	29 lbs	WWP2448	33 lbs
24" x 60"	WWE2460	36 lbs	WWP2460	42 lbs
24" x 72"	WWE2472	43 lbs	WWP2472	50 lbs
24" x 96"	WWE2496	57 lbs	WWP2496	66 lbs
30" x 30"	WWE3030	22 lbs	WWP3030	26 lbs
30" x 42"	WWE3042	31 lbs	WWP3042	36 lbs
30" x 48"	WWE3048	36 lbs	WWP3048	42 lbs
30" x 60"	WWE3060	44 lbs	WWP3060	52 lbs
30" x 72"	WWE3072	53 lbs	WWP3072	62 lbs
30" x 96"	WWE3096	71 lbs	WWP3096	83 lbs
36" x 36"	WWE3636	32 lbs	WWP3636	37 lbs
36" x 48"	WWE3648	43 lbs	WWP3648	50 lbs
36" x 60"	WWE3660	53 lbs	WWP3660	62 lbs
36" x 72"	WWE3672	64 lbs	WWP3672	74 lbs
42" x 42"	WWE4242	44 lbs	WWP4242	51 lbs
48" x 48"	WWE4848	57 lbs	WWP4848	66 lbs
24" Round	WWE24R	12 lbs	WWP24R	13 lbs
30" Round	WWE30R	18 lbs	WWP30R	21 lbs
36" Round	WWE36R	25 lbs	WWP36R	30 lbs
42" Round	WWE42R	34 lbs	WWP42R	40 lbs
48" Round	WWE48R	45 lbs	WWP48R	52 lbs

Whitewash

Woodland



- 1" red oak faced table top finished with a 1-5/8" solid wood dropped edge
- Available in any in-house stain or color (custom stain available for an upcharge) - specify stain
 - Some sizes stocked in Clear Coat & Dark Walnut - see Quick Ship Tops
- Custom and/or non-standard sizes available for an upcharge per size & lead time
- Eased edge profile | For indoor use only | All tops boxed

ADDITIONAL INFORMATION

- Non-standard sizes carry a setup fee per size
- Orders with less than 4 tops incur a small order fee
- Pre-drilled tops for Oak Street bases available for an upcharge per table
- Table tops over 48" subject to a crate fee per pallet (fee/service optional on 3rd party shipments)



Table Size	Part #	Approx. Weight
24" x 24"	WDL2424	15 lbs
24" x 30"	WDL2430	18 lbs
24" x 42"	WDL2442	25 lbs
24" x 48"	WDL2448	29 lbs
24" x 60"	WDL2460	36 lbs
24" x 72"	WDL2472	43 lbs
24" x 96"	WDL2496	57 lbs
30" x 30"	WDL3030	22 lbs
30" x 42"	WDL3042	31 lbs
30" x 48"	WDL3048	36 lbs
30" x 60"	WDL3060	44 lbs
30" x 72"	WDL3072	53 lbs
30" x 96"	WDL3096	71 lbs
36" x 36"	WDL3636	32 lbs
36" x 48"	WDL3648	43 lbs
36" x 60"	WDL3660	53 lbs
36" x 72"	WDL3672	64 lbs
42" x 42"	WDL4242	44 lbs
48" x 48"	WDL4848	57 lbs
36" Round	WDL36R	25 lbs
42" Round	WDL42R	34 lbs
48" Round	WDL48R	45 lbs
60" Round	WDL60R	70 lbs





- The look of solid wood with consistent, uniform strength.
- Resistant to warping, cracking & splitting
- Engineered wood panels available in Oak facing
- Available in any in-house stain or color (custom stain available for an upcharge)
- Custom and/or non-standard sizes available for an upcharge per size
- EEO tops: 1-1/8" nominal thickness
- EPO tops: 1-1/8" nominal core + 7/8" nominal dropped edge = 2" overall edge thickness
- Edge profile options: Waterfall, Eased or Bullnose | For indoor use only | All tops boxed



Table Size	1" Oak Part #	Approx. Weight	2" Oak Part #	Approx. Weight
24" x 24"	EE02424	15 lbs	EPO2424	17 lbs
24" x 30"	EE02430	18 lbs	EPO2430	21 lbs
24" x 42"	EE02442	25 lbs	EPO2442	29 lbs
24" x 48"	EE02448	29 lbs	EPO2448	33 lbs
24" x 60"	EE02460	36 lbs	EPO2460	42 lbs
24" x 72"	EE02472	43 lbs	EPO2472	50 lbs
24" x 96"	EE02496	57 lbs	EPO2496	66 lbs
30" x 30"	EE03030	22 lbs	EPO3030	26 lbs
30" x 42"	EE03042	31 lbs	EPO3042	36 lbs
30" x 48"	EE03048	36 lbs	EPO3048	42 lbs
30" x 60"	EE03060	44 lbs	EPO3060	52 lbs
30" x 72"	EE03072	53 lbs	EPO3072	62 lbs
30" x 96"	EE03096	71 lbs	EPO3096	83 lbs
36" x 36"	EE03636	32 lbs	EPO3636	37 lbs
36" x 48"	EE03648	43 lbs	EPO3648	50 lbs
36" x 60"	EE03660	53 lbs	EPO3660	62 lbs
36" x 72"	EE03672	64 lbs	EPO3672	74 lbs
42" x 42"	EE04242	44 lbs	EPO4242	51 lbs
48" x 48"	EE04848	57 lbs	EPO4848	66 lbs
24" Round	EE024R	12 lbs	EPO24R	13 lbs
30" Round	EE030R	18 lbs	EPO30R	21 lbs
36" Round	EE036R	25 lbs	EPO36R	30 lbs
42" Round	EE042R	34 lbs	EPO42R	40 lbs
48" Round	EE048R	45 lbs	EPO48R	52 lbs
60" Round	EE060R	70 lbs	EPO60R	81 lbs



Fortress



- 1-1/8" nominal core edged in 2" hot rolled, clear coat II gauge steel with exposed fasteners
- Random buffed edge
- Laminate list pricing includes up to Tier 3 Pinnacle, Formica & Wilsonart laminates
- For indoor use only
- Table tops over 48" subject to a crate fee per pallet (fee/service optional on 3rd party shipments)
- Fortress Wood features Oak faced veneer stained in any in-house stain or color
- All tops boxed



Fortress Laminate



Formica 3485-58 Black Walnut laminate*
*Tier 1 laminate

Fortress Wood



American Walnut on Oak

Formica 6477-58 Seasoned Planked Elm laminate*
*Tier 1 laminate

Fortress Darkwash



Walnut Dye

Fortress Whitewash



Black

Black Dye

Clear Coat

Table Size	Laminate Part #	Wood Part #	Darkwash Part #	Whitewash Part #	Approx. Weight
24" x 24"	FT2424-L	FT2424-E	FT2424-CD	FT2424-WW	20 lbs
24" x 30"	FT2430-L	FT2430-E	FT2430-CD	FT2430-WW	24 lbs
24" x 42"	FT2442-L	FT2442-E	FT2442-CD	FT2442-WW	34 lbs
24" x 48"	FT2448-L	FT2448-E	FT2448-CD	FT2448-WW	39 lbs
24" x 60"	FT2460-L	FT2460-E	FT2460-CD	FT2460-WW	48 lbs
24" x 72"	FT2472-L	FT2472-E	FT2472-CD	FT2472-WW	58 lbs
24" x 96"	FT2496-L	FT2496-E	FT2496-CD	FT2496-WW	77 lbs
30" x 30"	FT3030-L	FT3030-E	FT3030-CD	FT3030-WW	30 lbs
30" x 42"	FT3042-L	FT3042-E	FT3042-CD	FT3042-WW	42 lbs
30" x 48"	FT3048-L	FT3048-E	FT3048-CD	FT3048-WW	48 lbs
30" x 60"	FT3060-L	FT3060-E	FT3060-CD	FT3060-WW	60 lbs
30" x 72"	FT3072-L	FT3072-E	FT3072-CD	FT3072-WW	72 lbs
30" x 96"	FT3096-L	FT3096-E	FT3096-CD	FT3096-WW	96 lbs
36" x 36"	FT3636-L	FT3636-E	FT3636-CD	FT3636-WW	44 lbs
36" x 48"	FT3648-L	FT3648-E	FT3648-CD	FT3648-WW	58 lbs
36" x 60"	FT3660-L	FT3660-E	FT3660-CD	FT3660-WW	72 lbs
36" x 72"	FT3672-L	FT3672-E	FT3672-CD	FT3672-WW	87 lbs
42" x 42"	FT4242-L	FT4242-E	FT4242-CD	FT4242-WW	59 lbs
48" x 48"	FT4848-L	FT4848-E	FT4848-CD	FT4848-WW	77 lbs
30" Round	FT30R-L	FT30R-E	FT30R-CD	FT30R-WW	24 lbs
36" Round	FT36R-L	FT36R-E	FT36R-CD	FT36R-WW	34 lbs
42" Round	FT42R-L	FT42R-E	FT42R-CD	FT42R-WW	47 lbs
48" Round	FT48R-L	FT48R-E	FT48R-CD	FT48R-WW	61 lbs
60" Round	FT60R-L	FT60R-E			95 lbs





Boardwalk



Rich Earth



Storm Gray



Dove Gray



Dark Walnut



Black Dye with Stain

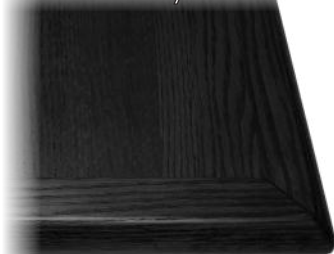

- The look of a solid wood core with consistent uniform strength resistant to warping, cracking & splitting
- 1-1/8" nominal engineered oak faced core with 1-1/4" solid oak edge
- Available in any in-house stain or color (custom stain available for an upcharge)
- Custom and/or non-standard sizes available for an upcharge per size
- Edge profile options: Waterfall, Eased or Bullnose (shown pg. 54)
- For indoor use only | All tops boxed

ADDITIONAL INFORMATION

- Non-standard sizes carry a setup fee per size
- Orders with less than 4 tops incur a small order fee
- Pre-drilled tops for Oak Street bases available for an upcharge per table
- Table tops over 48" subject to a crate fee per pallet (fee/service optional on 3rd party shipments)



Due to the nature of the product, clear coats may experience some discoloration over time.

Table Size	Part #	Approx. Weight
24" x 24"	SMW2424	23 lbs
24" x 30"	SMW2430	28 lbs
24" x 42"	SMW2442	40 lbs
24" x 48"	SMW2448	45 lbs
24" x 60"	SMW2460	56 lbs
24" x 72"	SMW2472	68 lbs
24" x 96"	SMW2496	90 lbs
30" x 30"	SMW3030	35 lbs
30" x 42"	SMW3042	49 lbs
30" x 48"	SMW3048	56 lbs
30" x 60"	SMW3060	70 lbs
30" x 72"	SMW3072	84 lbs
30" x 96"	SMW3096	112 lbs
36" x 36"	SMW3636	51 lbs
36" x 48"	SMW3648	68 lbs
36" x 60"	SMW3660	84 lbs
36" x 72"	SMW3672	101 lbs
42" x 42"	SMW4242	69 lbs
48" x 48"	SMW4848	90 lbs
24" Round	SMW24R	18 lbs
30" Round	SMW30R	28 lbs
36" Round	SMW36R	40 lbs
42" Round	SMW42R	54 lbs
48" Round	SMW48R	71 lbs
60" Round	SMW60R	110 lbs

American Walnut



Timber



Autumn Haze



Traditional Cherry



Traditional Mahogany



Clear Coat



Overlay



- 1-1/4" thick, 45 lb industrial grade particle board with high-pressure laminate
- Edged with 3mm solid wood in Oak, Poplar or Maple stained in any in-house stain or color (custom stain available for an upcharge)
- Edge profile option: Eased
- List pricing based on Tier 1 Pinnacle & standard Formica -58 & -43 finish laminates - upcharge for Wilsonart & Tier 2+ Pinnacle & Formica laminates
- Additional laminates, including Nevamar & Pionite available for an upcharge
- For indoor use only | All tops boxed

ADDITIONAL INFORMATION

- Non-standard sizes carry a setup fee per size
- Orders with less than 4 tops incur a small order fee
- Pre-drilled tops for Oak Street bases available for an upcharge per table
- Table tops over 48" subject to a crate fee per pallet (fee/service optional on 3rd party shipments)



Table Size	Part #	Approx. Weight
24" x 24"	OLWE2424	23 lbs
24" x 30"	OLWE2430	28 lbs
24" x 42"	OLWE2442	40 lbs
24" x 48"	OLWE2448	45 lbs
24" x 60"	OLWE2460	56 lbs
24" x 72"	OLWE2472	68 lbs
24" x 96"	OLWE2496	90 lbs
30" x 30"	OLWE3030	35 lbs
30" x 42"	OLWE3042	49 lbs
30" x 48"	OLWE3048	56 lbs
30" x 60"	OLWE3060	70 lbs
30" x 72"	OLWE3072	84 lbs
30" x 96"	OLWE3096	112 lbs
36" x 36"	OLWE3636	51 lbs
36" x 48"	OLWE3648	68 lbs
36" x 60"	OLWE3660	84 lbs
36" x 72"	OLWE3672	101 lbs
42" x 42"	OLWE4242	69 lbs
48" x 48"	OLWE4848	90 lbs
24" Round	OLWE24R	18 lbs
30" Round	OLWE30R	28 lbs
36" Round	OLWE36R	40 lbs
42" Round	OLWE42R	54 lbs
48" Round	OLWE48R	71 lbs
60" Round	OLWE60R	110 lbs

Pinnacle T 1389 SF Dixie Juniper laminate* -
Black edge stain
** Tier 1 laminate*



Pinnacle C 40 SF Oxford Cherry laminate* -
Cherry edge stain
** Tier 1 laminate*



Pinnacle C 644 SF Knotty Oak laminate* -
American Walnut edge stain
** Tier 1 laminate*



Pinnacle T 1656 SF Green Mountain Maple laminate* -
Clear Coat edge finish
** Tier 1 laminate*



Pinnacle T 1681 SF Modoc Poplar laminate* -
Rich Earth edge stain
** Tier 1 laminate*



Pinnacle C 668 SF Sumatra Teak laminate* -
Timber edge stain
** Tier 1 laminate*



Pinnacle C 643 SF Vintage Pine laminate* -
Boardwalk edge stain
** Tier 1 laminate*



Pinnacle C 263 SF Blush Rosewood laminate* -
Chestnut edge stain
** Tier 1 laminate*





Inlay

Table Tops - Made to Order

- 1-1/4" thick, 45 lb industrial grade particle board with high-pressure laminate
- Edged with 1-1/2" nominal wood in Oak or Maple stained in any in-house stain or color (custom stain available for an upcharge)
- Edge profile options: Waterfall, Eased or Bullnose
- List pricing based on Tier 1 Pinnacle & standard Formica -58 & -43 finish laminates - upcharge for Wilsonart & Tier 2+ Pinnacle & Formica laminates
- Additional laminates, including Nevamar & Pionite available for an upcharge
- For indoor use only | All tops boxed

ADDITIONAL INFORMATION

- Non-standard sizes carry a setup fee per size
- Orders with less than 4 tops incur a small order fee
- Pre-drilled tops for Oak Street bases available for an upcharge per table
- Table tops over 48" subject to a crate fee per pallet (fee/service optional on 3rd party shipments)

 Due to the nature of the product, clear coats may experience some discoloration over time.

More laminate options available - view at bit.ly/osmlaminates

Table Size	Part #	Approx. Weight
24" x 24"	INLY2424	23 lbs
24" x 30"	INLY2430	28 lbs
24" x 42"	INLY2442	40 lbs
24" x 48"	INLY2448	45 lbs
24" x 60"	INLY2460	56 lbs
24" x 72"	INLY2472	68 lbs
24" x 96"	INLY2496	90 lbs
30" x 30"	INLY3030	35 lbs
30" x 42"	INLY3042	49 lbs
30" x 48"	INLY3048	56 lbs
30" x 60"	INLY3060	70 lbs
30" x 72"	INLY3072	84 lbs
30" x 96"	INLY3096	112 lbs
36" x 36"	INLY3636	51 lbs
36" x 48"	INLY3648	68 lbs
36" x 60"	INLY3660	84 lbs
36" x 72"	INLY3672	101 lbs
42" x 42"	INLY4242	69 lbs
48" x 48"	INLY4848	90 lbs
24" Round	INLY24R	18 lbs
30" Round	INLY30R	28 lbs
36" Round	INLY36R	40 lbs
42" Round	INLY42R	54 lbs
48" Round	INLY48R	71 lbs
60" Round	INLY60R	110 lbs



Formica 9309-58 Star Dune laminate* -
American Walnut edge stain
* Tier 1 laminate



Pinnacle C11 SF Black laminate* -
Autumn Haze edge stain
* Tier 1 laminate



Formica 9527-58 Black Shalestone laminate* -
Black edge stain
* Tier 1 laminate



Formica 6223-58 Venetian Gold Granite laminate* -
Graystone edge stain
* Tier 1 laminate



Formica 8958-58 Bubble Art laminate* -
Rich Earth edge stain
* Tier 1 laminate



Pinnacle C30 SF Royal Blue laminate* -
American Walnut edge stain
* Tier 1 laminate



Formica 3692-58
Labrador Granite laminate* -
Clear Coat edge finish
* Tier 1 laminate



Eased

Bullnose

Waterfall

Inlay

Solid Wood Plank



- Kiln dried, random width planks (approx. 4") glued in continuous pattern
- Edge profiles: Rolled, Eased, Bullnose, Beveled, Reverse Beveled & Ogee
- Available in the 10 stain options (shown below) - please call for stain samples
- Custom and/or non-standard sizes available for an upcharge per size
- For indoor use only | All tops boxed

ADDITIONAL INFORMATION

- Stain match available for an upcharge
- Pre-drilled tops for Oak Street bases available for an upcharge per table
- 3" radius corners, angle cuts & custom cuts available for an upcharge per table
- Orders with less than 4 tops incur a small order fee
- Tops over 48" subject to a crate fee per pallet (fee/service optional on 3rd party shipments)



Oak has a neutral color with a distinct red undertone and prominent wavy grain patterns.



Ash is lighter in color than oak with a beige/light brown hue and smooth to the touch.
Ash is the preferred wood species due to its higher level of performance.



Maple is light in color with a reddish tint. Its fine, even grain gives a consistent appearance and allows for a smooth finish.

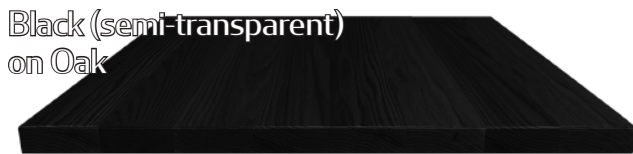
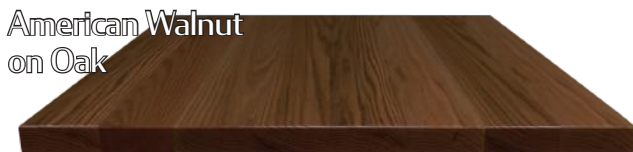
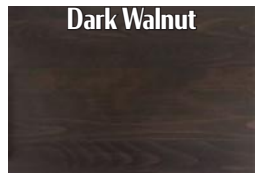
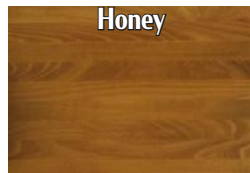
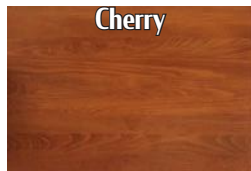
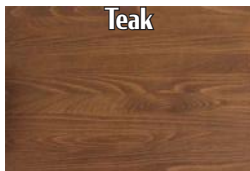



Solid Wood Plank

Table Tops - Made to Order

Table Size	1-1/4" Oak Part #	1-1/4" Ash Part #	1-1/4" Maple Part #	1-1/4" Weight	1-3/4" Oak Part #	1-3/4" Ash Part #	1-3/4" Maple Part #	1-3/4" Weight
24" x 24"	PE02424	PEA2424	PEM2424	28 lbs	PPO2424	PPA2424	PPM2424	28 lbs
24" x 30"	PE02430	PEA2430	PEM2430	34 lbs	PPO2430	PPA2430	PPM2430	35 lbs
24" x 36"	PE02436	PEA2436	PEM2436	41 lbs	PPO2436	PPA2436	PPM2436	42 lbs
24" x 42"	PE02442	PEA2442	PEM2442	48 lbs	PPO2442	PPA2442	PPM2442	49 lbs
24" x 48"	PE02448	PEA2448	PEM2448	55 lbs	PPO2448	PPA2448	PPM2448	56 lbs
24" x 60"	PE02460	PEA2460	PEM2460	68 lbs	PPO2460	PPA2460	PPM2460	70 lbs
24" x 72"	PE02472	PEA2472	PEM2472	82 lbs	PPO2472	PPA2472	PPM2472	84 lbs
24" x 84"	PE02484	PEA2484	PEM2484	95 lbs	PPO2484	PPA2484	PPM2484	98 lbs
24" x 96"	PE02496	PEA2496	PEM2496	109 lbs	PPO2496	PPA2496	PPM2496	112 lbs
30" x 30"	PE03030	PEA3030	PEM3030	43 lbs	PPO3030	PPA3030	PPM3030	44 lbs
30" x 36"	PE03036	PEA3036	PEM3036	51 lbs	PPO3036	PPA3036	PPM3036	53 lbs
30" x 42"	PE03042	PEA3042	PEM3042	60 lbs	PPO3042	PPA3042	PPM3042	61 lbs
30" x 48"	PE03048	PEA3048	PEM3048	68 lbs	PPO3048	PPA3048	PPM3048	70 lbs
30" x 60"	PE03060	PEA3060	PEM3060	85 lbs	PPO3060	PPA3060	PPM3060	87 lbs
30" x 72"	PE03072	PEA3072	PEM3072	102 lbs	PPO3072	PPA3072	PPM3072	105 lbs
30" x 84"	PE03084	PEA3084	PEM3084	119 lbs	PPO3084	PPA3084	PPM3084	122 lbs
30" x 96"	PE03096	PEA3096	PEM3096	136 lbs	PPO3096	PPA3096	PPM3096	139 lbs
36" x 36"					PPO3636	PPA3636	PPM3636	63 lbs
36" x 42"					PPO3642	PPA3642	PPM3642	73 lbs
36" x 48"					PPO3648	PPA3648	PPM3648	84 lbs
36" x 60"					PPO3660	PPA3660	PPM3660	105 lbs
36" x 72"					PPO3672	PPA3672	PPM3672	125 lbs
36" x 84"					PPO3684	PPA3684	PPM3684	146 lbs
36" x 96"					PPO3696	PPA3696	PPM3696	167 lbs
42" x 42"					PPO4242	PPA4242	PPM4242	86 lbs
48" x 48"					PPO4848	PPA4848	PPM4848	112 lbs
60" x 60"					PPO6060	PPA6060	PPM6060	174 lbs
18" Round	PE018R	PEA18R	PEM18R	12 lbs	PPO18R	PPA18R	PPM18R	13 lbs
24" Round	PE024R	PEA24R	PEM24R	22 lbs	PPO24R	PPA24R	PPM24R	22 lbs
30" Round	PE030R	PEA30R	PEM30R	34 lbs	PPO30R	PPA30R	PPM30R	35 lbs
36" Round					PPO36R	PPA36R	PPM36R	50 lbs
42" Round					PPO42R	PPA42R	PPM42R	67 lbs
48" Round					PPO48R	PPA48R	PPM48R	88 lbs
54" Round					PPO54R	PPA54R	PPM54R	111 lbs
60" Round					PPO60R	PPA60R	PPM60R	137 lbs
36" x 36" Flip					PPO3636	PPA3636	PPM3636	
51" Round					FLIP51R	FLIP51R	FLIP51R	119 lbs
42" x 42" Flip					PPO4242	PPA4242	PPM4242	
60" Round					FLIP60R	FLIP60R	FLIP60R	157 lbs

It is the customer's/user's responsibility to maintain a 30% humidity level to accommodate solid wood. Most restaurants will need supplemental humidity equipment.



Solid Wood Plank

Solid Wood Butcher Block



- Kiln dried, uniform width staves (approx. 3/4") face glued in continuous pattern
- Edge profiles: Rolled, Eased, Bullnose, Beveled, Reverse Beveled & Ogee
- Available in the 10 stain options (shown below) - please call for stain samples
- Custom and/or non-standard sizes available for an upcharge per size
- For indoor use only | All tops boxed

ADDITIONAL INFORMATION

- Stain match available for an upcharge
- Pre-drilled tops for Oak Street bases available for an upcharge per table
- 3" radius corners, angle cuts & custom cuts available for an upcharge per table
- Orders with less than 4 tops incur a small order fee
- Tops over 48" subject to a crate fee per pallet (fee/service optional on 3rd party shipments)



Oak has a neutral color with a distinct red undertone and prominent wavy grain patterns.



Ash is lighter in color than oak with a beige/light brown hue and smooth to the touch.
Ash is the preferred wood species due to its higher level of performance.



Maple is light in color with a reddish tint. Its fine, even grain gives a consistent appearance and allows for a smooth finish.

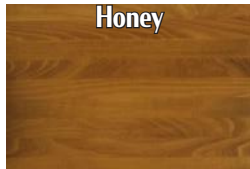
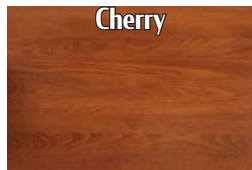
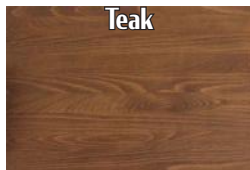

Clear Coat on Oak



American Walnut on Oak



Slate Gray on Oak



Honey on Oak



Solid Wood Butcher Block

Table Tops - Made to Order

Table Size	1-1/2" Oak Part #	1-1/2" Ash Part #	1-1/2" Maple Part #	1-1/2" Weight	1-3/4" Oak Part #	1-3/4" Ash Part #	1-3/4" Maple Part #	1-3/4" Weight
24" x 24"	BE02424	BEA2424	BEM2424	28 lbs	BPO2424	BPA2424	BPM2424	28 lbs
24" x 30"	BE02430	BEA2430	BEM2430	34 lbs	BPO2430	BPA2430	BPM2430	35 lbs
24" x 36"	BE02436	BEA2436	BEM2436	41 lbs	BPO2436	BPA2436	BPM2436	42 lbs
24" x 42"	BE02442	BEA2442	BEM2442	48 lbs	BPO2442	BPA2442	BPM2442	49 lbs
24" x 48"	BE02448	BEA2448	BEM2448	55 lbs	BPO2448	BPA2448	BPM2448	56 lbs
24" x 60"	BE02460	BEA2460	BEM2460	68 lbs	BPO2460	BPA2460	BPM2460	70 lbs
24" x 72"	BE02472	BEA2472	BEM2472	82 lbs	BPO2472	BPA2472	BPM2472	84 lbs
24" x 84"	BE02484	BEA2484	BEM2484	96 lbs	BPO2484	BPA2484	BPM2484	98 lbs
24" x 96"	BE02496	BEA2496	BEM2496	109 lbs	BPO2496	BPA2496	BPM2496	112 lbs
30" x 30"	BE03030	BEA3030	BEM3030	43 lbs	BPO3030	BPA3030	BPM3030	44 lbs
30" x 36"	BE03036	BEA3036	BEM3036	51 lbs	BPO3036	BPA3036	BPM3036	53 lbs
30" x 42"	BE03042	BEA3042	BEM3042	60 lbs	BPO3042	BPA3042	BPM3042	61 lbs
30" x 48"	BE03048	BEA3048	BEM3048	68 lbs	BPO3048	BPA3048	BPM3048	70 lbs
30" x 60"	BE03060	BEA3060	BEM3060	85 lbs	BPO3060	BPA3060	BPM3060	87 lbs
30" x 72"	BE03072	BEA3072	BEM3072	102 lbs	BPO3072	BPA3072	BPM3072	105 lbs
30" x 84"	BE03084	BEA3084	BEM3084	119 lbs	BPO3084	BPA3084	BPM3084	122 lbs
30" x 96"	BE03096	BEA3096	BEM3096	136 lbs	BPO3096	BPA3096	BPM3096	139 lbs
36" x 36"	BE03636	BEA3636	BEM3636	62 lbs	BPO3636	BPA3636	BPM3636	63 lbs
36" x 42"	BE03642	BEA3642	BEM3642	72 lbs	BPO3642	BPA3642	BPM3642	73 lbs
36" x 48"	BE03648	BEA3648	BEM3648	82 lbs	BPO3648	BPA3648	BPM3648	84 lbs
36" x 60"	BE03660	BEA3660	BEM3660	102 lbs	BPO3660	BPA3660	BPM3660	105 lbs
36" x 72"	BE03672	BEA3672	BEM3672	123 lbs	BPO3672	BPA3672	BPM3672	125 lbs
36" x 84"	BE03684	BEA3684	BEM3684	143 lbs	BPO3684	BPA3684	BPM3684	146 lbs
36" x 96"	BE03696	BEA3696	BEM3696	164 lbs	BPO3696	BPA3696	BPM3696	167 lbs
42" x 42"	BE04242	BEA4242	BEM4242	84 lbs	BPO4242	BPA4242	BPM4242	86 lbs
48" x 48"	BE04848	BEA4848	BEM4848	109 lbs	BPO4848	BPA4848	BPM4848	112 lbs
60" x 60"	BE06060	BEA6060	BEM6060	170 lbs	BPO6060	BPA6060	BPM6060	174 lbs
18" Round	BE018R	BEA18R	BEM18R	13 lbs	BPO18R	BPA18R	BPM18R	13 lbs
24" Round	BE024R	BEA24R	BEM24R	22 lbs	BPO24R	BPA24R	BPM24R	22 lbs
30" Round	BE030R	BEA30R	BEM30R	34 lbs	BPO30R	BPA30R	BPM30R	35 lbs
36" Round	BE036R	BEA36R	BEM36R	49 lbs	BPO36R	BPA36R	BPM36R	50 lbs
42" Round	BE042R	BEA42R	BEM42R	66 lbs	BPO42R	BPA42R	BPM42R	67 lbs
48" Round	BE048R	BEA48R	BEM48R	86 lbs	BPO48R	BPA48R	BPM48R	88 lbs
54" Round	BE054R	BEA54R	BEM54R	109 lbs	BPO54R	BPA54R	BPM54R	111 lbs
60" Round	BE060R	BEA60R	BEM60R	134 lbs	BPO60R	BPA60R	BPM60R	137 lbs
36" x 36" Flip	BE03636	BEA3636	BEM3636	62 lbs	BPO3636	BPA3636	BPM3636	63 lbs
51" Round	FLIP51R	FLIP51R	FLIP51R	119 lbs	FLIP51R	FLIP51R	FLIP51R	119 lbs
42" x 42" Flip	BE04242	BEA4242	BEM4242	84 lbs	BPO4242	BPA4242	BPM4242	86 lbs
60" Round	FLIP60R	FLIP60R	FLIP60R	170 lbs	FLIP60R	FLIP60R	FLIP60R	174 lbs

It is the customer's/user's responsibility to maintain a 30% humidity level to accommodate solid wood. Most restaurants will need supplemental humidity equipment.

Pecan on Oak



Solid Wood Butcher Block

Button Top - Slimline Metal Frame Swivel Barstool

* MADE TO ORDER *



13-1/4" | 21"

- Double rung chrome frame
- Non-marring glides included (GL2129)
- Stackable: No



15-3/4" | 21-1/4"

- Premium black powder coat wrinkle finish (including footing)
- 1.2mm steel frame; 1-1/4" tubing; 100% welded frame & footing
- Non-marring glides included (GL2160-WHITE)
- Stackable: No



15-3/4" | 21-1/4"

- Premium black powder coat wrinkle finish (including footing & seat ring)
- 1.2mm steel frame; 1-1/4" tubing; 100% welded frame & footing
- Non-marring glides included (GL2160-WHITE)
- Stackable: No



15-3/4" | 21-1/4"

- Premium clear coat finish (including footing)
- 1.2mm steel frame; 1-1/4" tubing; 100% welded frame & footing
- Non-marring glides included (GL2160-CLEAR)
- Stackable: No

Button Top - Slimline Metal Frame Swivel Barstool

Chrome Seat Ring

Black Seat Ring

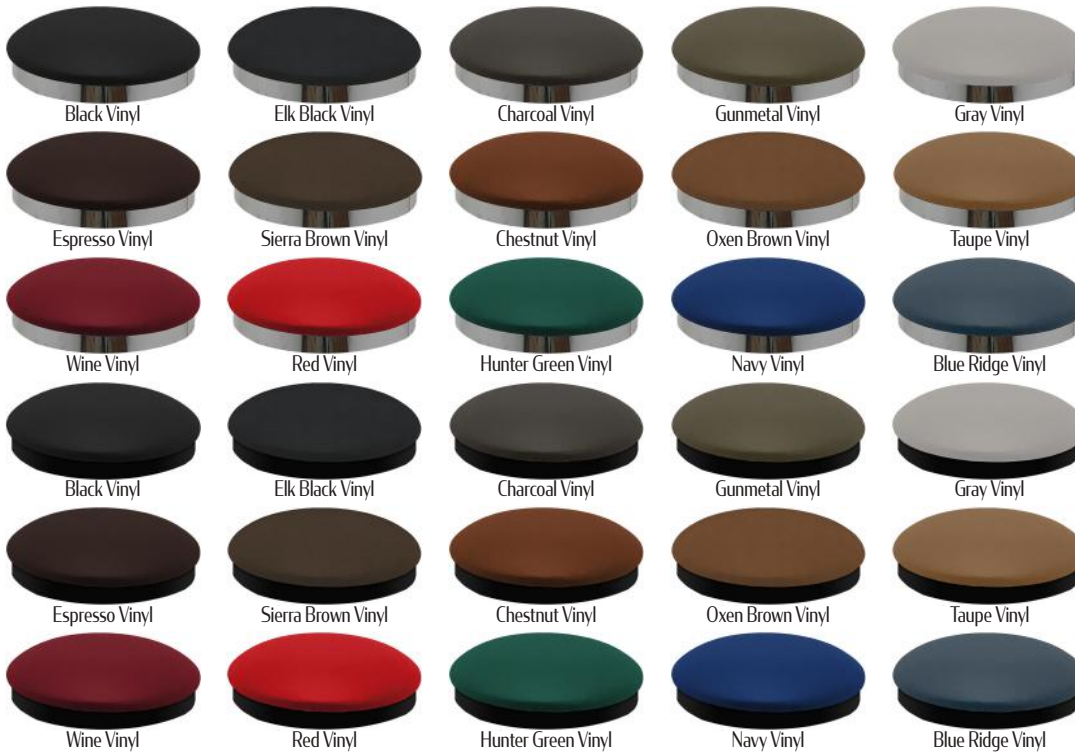

- Slimline Button Tops feature high-density foam on plywood core wrapped in quality fabric-backed, commercial grade vinyl
- Overall height of barstool on all frame styles: 30" (excl. counter height)
- Heavy-duty flat swivel attached to all frame styles
- Button Top seat ships unattached - simple seat attachment required
- Button Top Dimensions:

- Accent ring on seat bottom: 15-1/2" Diameter x 1-1/2" H

Slimline Button Top	Black Vinyl	Wine Vinyl	Red Vinyl	Navy Vinyl	Hunter Green Vinyl	Gray Vinyl	Chestnut Vinyl	Espresso Vinyl	Black Vinyl	Sierra Brown Vinyl	Oxen Brown Vinyl	Charcoal Vinyl	Gunmetal Vinyl	Taupe Vinyl	Blue Ridge Vinyl	Approx. Weight
Black Powder Coat Swivel Frame w/ Black Seat Ring	SL1117-B-BLK	SL1117-B-WINE	SL1117-B-RED	SL1117-B-NAVY	SL1117-B-HG	SL1117-B-GRAY	SL1117-B-CST	SL1117-B-ESP	SL1117-B-EB	SL1117-B-SB	SL1117-B-OB	SL1117-B-CC	SL1117-B-GM	SL1117-B-TPE	SL1117-B-BR	20 lbs
Black Powder Coat Swivel Frame w/ Chrome Seat Ring	SL1117-BLK	SL1117-WINE	SL1117-RED	SL1117-NAVY	SL1117-HG	SL1117-GRAY	SL1117-CST	SL1117-ESP	SL1117-EB	SL1117-SB	SL1117-OB	SL1117-CC	SL1117-GM	SL1117-TPE	SL1117-BR	20 lbs
Clear Coat Swivel Frame w/ Chrome Seat Ring	SL1117-CCS-BLK	SL1117-CCS-WINE	SL1117-CCS-RED	SL1117-CCS-NAVY	SL1117-CCS-HG	SL1117-CCS-GRAY	SL1117-CCS-CST	SL1117-CCS-ESP	SL1117-CCS-EB	SL1117-CCS-SB	SL1117-CCS-OB	SL1117-CCS-CC	SL1117-CCS-GM	SL1117-CCS-TPE	SL1117-CCS-BR	20 lbs
Double Rung Chrome Swivel Frame w/ Chrome Seat Ring	SL1131-BLK	SL1131-WINE	SL1131-RED	SL1131-NAVY	SL1131-HG	SL1131-GRAY	SL1131-CST	SL1131-ESP	SL1131-EB	SL1131-SB	SL1131-OB	SL1131-CC	SL1131-GM	SL1131-TPE	SL1131-BR	20 lbs
Black Powder Coat Counter Height Swivel Frame w/ Black Seat Ring	SLO117-B-BLK	SLO117-B-WINE	SLO117-B-RED	SLO117-B-NAVY	SLO117-B-HG	SLO117-B-GRAY	SLO117-B-CST	SLO117-B-ESP	SLO117-B-EB	SLO117-B-SB	SLO117-B-OB	SLO117-B-CC	SLO117-B-GM	SLO117-B-TPE	SLO117-B-BR	19 lbs
Black Powder Coat Counter Height Swivel Frame w/ Chrome Seat Ring	SLO117-BLK	SLO117-WINE	SLO117-RED	SLO117-NAVY	SLO117-HG	SLO117-GRAY	SLO117-CST	SLO117-ESP	SLO117-EB	SLO117-SB	SLO117-OB	SLO117-CC	SLO117-GM	SLO117-TPE	SLO117-BR	19 lbs
Clear Coat Counter Height Swivel Frame w/ Chrome Seat Ring	SLO117-CCS-BLK	SLO117-CCS-WINE	SLO117-CCS-RED	SLO117-CCS-NAVY	SLO117-CCS-HG	SLO117-CCS-GRAY	SLO117-CCS-CST	SLO117-CCS-ESP	SLO117-CCS-EB	SLO117-CCS-SB	SLO117-CCS-OB	SLO117-CCS-CC	SLO117-CCS-GM	SLO117-CCS-TPE	SLO117-CCS-BR	19 lbs

Button Top Bolt Down Pedestal Barstool

Bolt Down Pedestal Seating



- Pedestals have a black powder coat finish & feature a 2.5mm steel column with a 4.5mm mounting plate
- All welded joints - nothing to fail
- Heavy-duty flat swivel attached to frame
- All button top seat options feature quality fabric-backed, commercial-grade vinyl
- Button tops ship unattached - simple seat attachment required

For COUNTER HEIGHT
Slimline bolt down pedestals,
use **SL7117** for the part number - same pricing.

For CHAIR HEIGHT
Slimline bolt down pedestals,
use **SL5117** for the part number - same pricing.

SL6117 - Slimline Button Top Pedestals (Bar Height)



All spec sheets are available in
AutoQuotes or online at
www.oakstreetmfg.com

Custom vinyl or upholstered seat options available.
Visit <http://bit.ly/vinyl-upholstery-fabric> for available options!

Button Top Bolt Down Pedestals	Black Vinyl	Wine Vinyl	Red Vinyl	Navy Vinyl	Hunter Green Vinyl	Gray Vinyl	Chestnut Vinyl	Espresso Vinyl	Elk Black Vinyl	Sierra Brown Vinyl	Oxen Brown Vinyl	Charcoal Vinyl	Gunmetal Vinyl	Blue Ridge Vinyl	Approx. Weight	
Slimline w/ chrome ring	SL6117-BLK	SL6117-WINE	SL6117-RED	SL6117-NAVY	SL6117-HG	SL6117-GRAY	SL6117-CST	SL6117-ESP	SL6117-EB	SL6117-SB	SL6117-OB	SL6117-CC	SL6117-GM	SL6117-TPE	SL6117-BR	28 lbs
Slimline w/ black ring	SL6117-B-BLK	SL6117-B-WINE	SL6117-B-RED	SL6117-B-NAVY	SL6117-B-HG	SL6117-B-GRAY	SL6117-B-CST	SL6117-B-ESP	SL6117-B-EB	SL6117-B-SB	SL6117-B-OB	SL6117-B-CC	SL6117-B-GM	SL6117-B-TPE	SL6117-B-BR	28 lbs



Button Top Bolt Down Pedestal Barstool

Recommended Booth Layouts



End booth spacing is wider to keep symmetrical dimensions between inner booths

End booth spacing is wider to keep symmetrical dimensions between inner booths

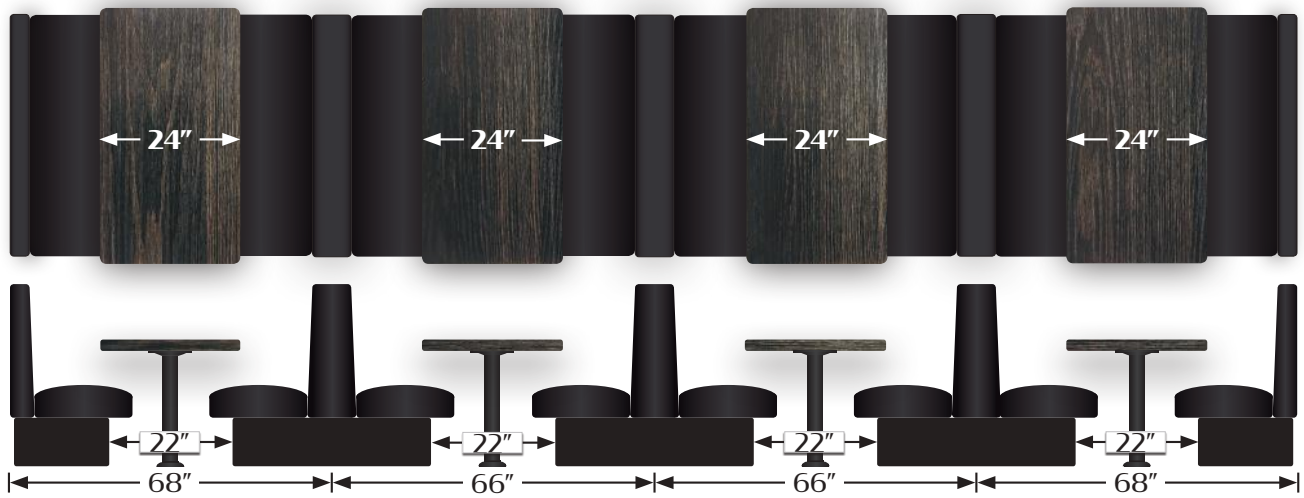

End booth spacing is wider to keep symmetrical dimensions between inner booths

End booth spacing is wider to keep symmetrical dimensions between inner booths

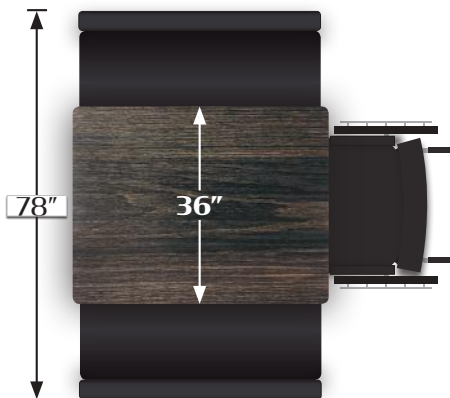

If seeking an ADA compliant accessible booth, a table top with a minimum width of 36" would accommodate the required clear floor area of 30" x 48".

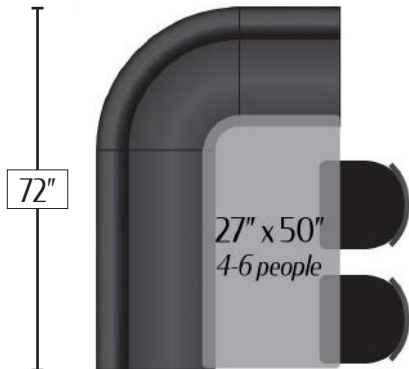
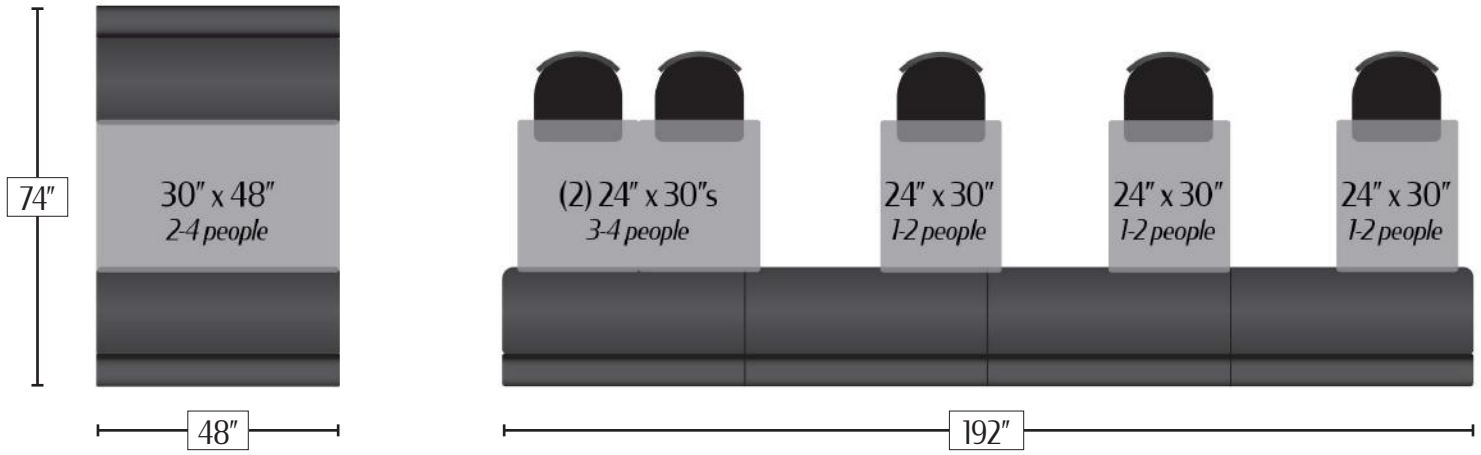

Determining the best layout for your restaurant can be difficult. Oak Street Manufacturing is here to help!

1. Determine your restaurant's available square footage & local regulations that must be followed.
2. Choose the sizing & quantities of tables & booths needed to set up your restaurant's layout.

It's important, as the restaurant owner or decision maker, to plan for every aspect of your restaurant's layout. The booth layout must be considered when planning the overall restaurant layout to ensure compliance with local regulations is still being met. One must not overlook maintaining:

- Standard aisle widths for guests & wait staff
- Emergency exit accessibility
- ADA compliance for wheelchair accessibility

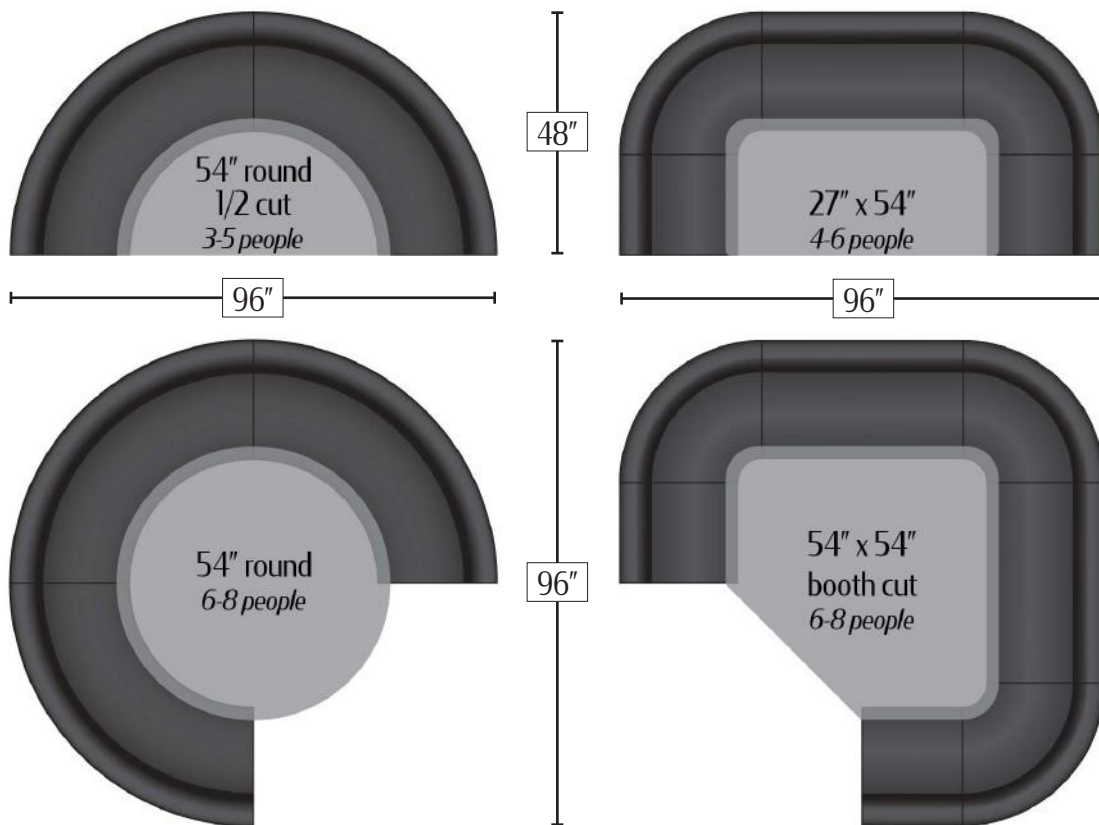

Oak Street Manufacturing's recommended booth layouts are guidelines for traditional spacing in most applications (spacing & setup can vary depending on the size desired & the space available - use as a general principle).

Booths & Benches Made to Order

The Oak Street Advantage

Vinyl/Upholstered Booths



All Oak Street vinyl booth seats are reversible & removable - prolonging the life of seat & making it easier to clean.



All Oak Street vinyl booths feature independent seat backs that are bolted, not glued or stapled to base - adding strength & durability.



Oak Street vinyl booth frames are more durable than competitors. 48+ screws & bolts are used in assembly.



All Oak Street booth seats & backs feature fully sculpted, springless foam. No springs to break, sag or squeak.



All Oak Street vinyl booths feature metal edge brackets are used in base corners - adding strength & durability.



All Oak Street vinyl booth ends are finished for endless room reconfiguration possibilities.



All Oak Street booth seats & backs feature slip sheets over seat foam allow vinyl or upholstery to recover after use - reducing wear.



All Oak Street vinyl booths feature a superior one-step black vinyl toekick glued with forEVA glue process & edged with poly protective corners or ultra durable steel toekick.

- Finished ends & backs standard on booths up to & including 72" lengths.
- Independent base disperses stress on seat back.
- Consistent seat back framing from single to double booths - without a concave wood back & thin layer of foam. Our backs are straight with extra thick foam contoured to the specific shape needed for extra cushion.
- Booths ship with nylon glides.

For custom vinyl, upholstery or fabric, visit:

bit.ly/vinyl-upholstery-fabric

In-House Booth Vinyls

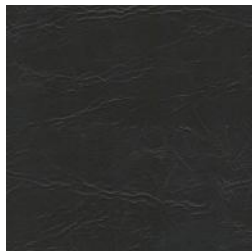

Elk Black

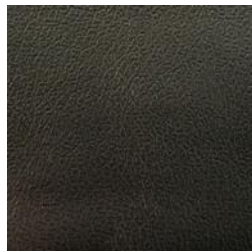

Black



Charcoal



Gunmetal



Gray

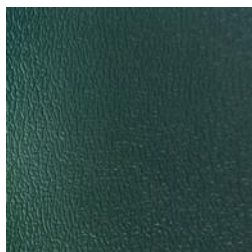

Hunter Green

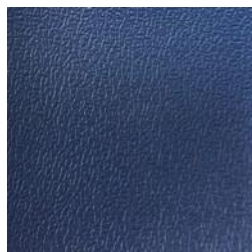

Navy



Blue Ridge

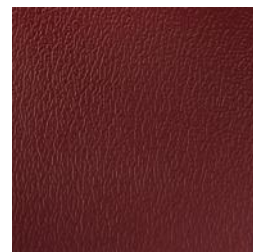

Wine



Red

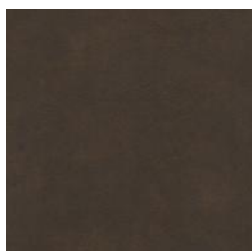

Sierra Brown



Espresso



Chestnut



Oxen Brown

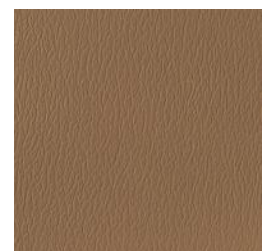

Taupe

Upgrades: Steel Booth Bases

Booths & Benches Made to Order



1-tier



2-tier



Upgrade your traditional booth base to a **steel booth base!**

- More durable - eliminate scuffs & tears from customers getting in and out; also fewer warranty or freight issues
- Easy to maintain - can be touched up (if necessary) with a simple can of spray paint
- Same plywood seat base design to accommodate our simple removable & reversible seat
- Available for single & double booths
- Available in 1-tier (shown upper left) and 2-tier (shown upper right)
- Robust 18 gauge steel construction
- Standard color: black, but custom colors* are available

* - Custom colors & other non-standard modifications subject to an upcharge - contact your Oak Street Account Manager for specifics

Upgrades: Steel Booth Bases

Upgrades: Freight Saver Booths

Save \$\$\$ In Under 3 Minutes & 5 Steps!



BOOTHS SHIP KNOCKDOWN TO SAVE HUGE ON FREIGHT. ASSEMBLY IS QUICK & EASY!

- Oak Street's freight saver design booths have 8 threaded inserts in seat back for superior strength.
- Bolts are then used to securely anchor seat backs to toekicks



Upgrades: Freight Saver Booths

Save \$\$\$ In Under 3 Minutes & 5 Steps!

Booths & Benches Made to Order

Upgrades: Freight Saver Booths

- Set seat back and toekick on their side. Toekick sits on included 3/4" piece of plywood to ensure proper spacing.



- Using drill driver & 1/2" bit socket, tighten 8 bolts (included) through toekick into threaded inserts in seat back.



- Set booth down and attach seat.
- Assembly is complete!



Ambrose [AM] - Top stitched seams with updated pillow back
Hamilton [HM] - Ambrose w/ wood legs
Morley [MR] - Ambrose w/ black steel legs
Grove [GR] - Ambrose w/ brushed aluminum legs
Clark [CL] - Ambrose w/ black steel legs
Waterloo [WL] - Clark w/ wood legs
Ankeny [AN] - Clark w/ black steel legs
Davenport [DP] - Clark w/ brushed aluminum legs
Worthing [WR] - Clark w/ extra thick 1" seat
Edinburgh [ED] - Clark w/ brushed aluminum legs
Onslow [ON] - Worthing w/ black steel legs
Langworthy [LG] - Worthing w/ brushed aluminum legs
Lons [LS] - Worthing w/ laminate privacy panel
Marion [MR] - Lons w/ black steel legs
Bettendorf [BE] - Lons w/ brushed aluminum legs
Cornell [CR] - top & side cap construction w/ welting
Albion [AL] - Cornell w/ black steel legs
Ames [AMES] - Cornell w/ black steel legs
Garner [GAR] - Cornell w/ brushed aluminum legs
Ottumwa [OT] - Cornell w/ extra thick 1" seat
Clinton [CLIN] - Ottumwa w/ black steel legs
Lake [LAKE] - Ottumwa w/ black steel legs
Burlington [BRIN] - Ottumwa w/ brushed aluminum legs
Simpson [SMIP] - Cornell w/ wood top & side cap
Elkworth [EL] - Simpson w/ wood legs
Newton [NEW] - Simpson w/ brushed aluminum legs
Anamosa [ANAM] - Simpson w/ brushed aluminum legs
Waukege [WAKE] - Simpson w/ extra thick 1" seat
Albion [ALB] - Waukege w/ wood legs
Waldorf [WD] - Waukege w/ black steel legs
Waldorf [WD] - Cornell w/ vertical channelback
Hale [HALE] - Waldorf w/ wood legs
Fairley [FAIR] - Waldorf w/ black steel legs
Alton [ALTON] - Waldorf w/ brushed aluminum legs
Adel [ADEL] - Waldorf w/ extra thick 1" seat
Agapey [AGAPY] - Alton w/ black steel legs
Allden [ALDEN] - Alton w/ brushed aluminum legs
Newton [NEW] - Alton w/ wood legs
Slater [SLAT] - Alton w/ black steel legs
Collins [COL] - Alton w/ brushed aluminum legs
Callan [CALL] - Alton w/ extra thick 1" seat
Callan [CALL] - Alton w/ black steel legs
Callan [CALL] - Callan w/ brushed aluminum legs
Burt [BURT] - Callan w/ brushed aluminum legs
Luther [LU] - Cornell w/ horizontal channelback
Libanon [LIB] - Luther w/ wood legs
Hudson [HUD] - Luther w/ brushed aluminum legs
Clare [CLAR] - Luther w/ extra thick 1" seat
Bannum [BANUM] - Clare w/ wood legs
Doon [DOON] - Clare w/ brushed aluminum legs
Irwin [IR] - Luther w/ wood top & side cap
Palo [PALO] - Irwin w/ wood legs
Agapey [AGAPY] - Irwin w/ black steel legs
Burt [BURT] - Irwin w/ extra thick 1" seat
Perry [PERRY] - Irwin w/ extra thick 1" seat
Ringside [RIST] - Perry w/ wood legs
Riverside [RIV] - Perry w/ black steel legs
Drake [DRAK] - Cornell w/ GT headrail
Benson [BEN] - Drake w/ wood legs
Lakota [LAK] - Drake w/ black steel legs
Marion [MARION] - Drake w/ brushed aluminum legs
Callan [CALL] - Drake w/ extra thick 1" seat
Gilman [GIL] - Eldon w/ wood legs
Gladsbrook [GBK] - Eldon w/ black steel legs
Goldford [GFD] - Eldon w/ brushed aluminum legs
Victory [VIC] - Eldon w/ wood top & side cap
Quincy [QUIN] - Victor w/ black steel legs
Jesup [JESU] - Victor w/ brushed aluminum legs
Yale [YALE] - Victor w/ extra thick 1" seat
Lowden [LDN] - Victor w/ extra thick 1" seat
Lowden [LDN] - Victor w/ black steel legs
Massena [MAS] - Lowden w/ black steel legs
Mingo [MING] - Lowden w/ brushed aluminum legs
Union Station [US] - unitized steel frame with vinyl seat & back
Pacific [PAC] - Union Station with outdoor components

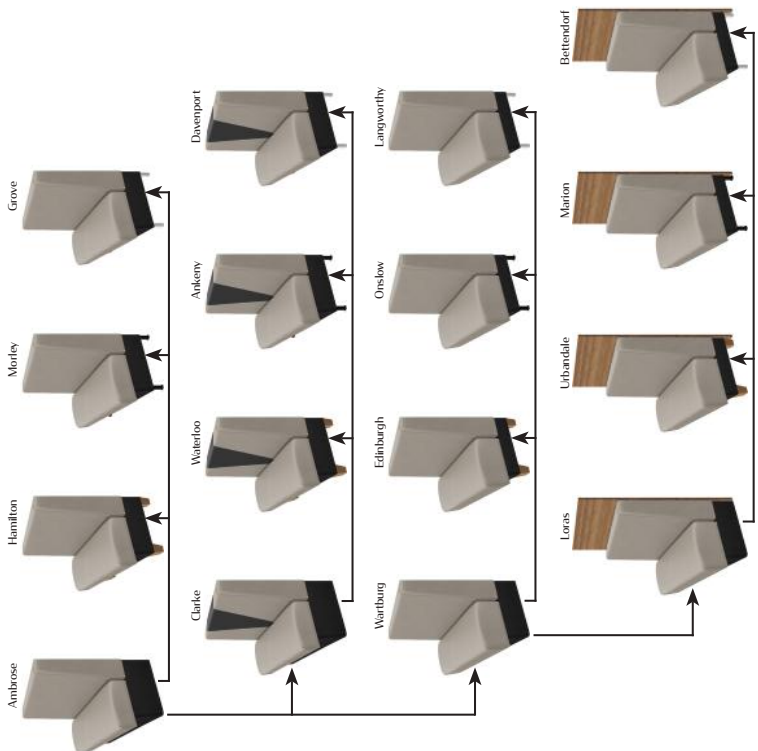

Tiered Vinyl / Upholstery: **DOUGLASS FABRICS** **Stinson**

In-House Vinyls

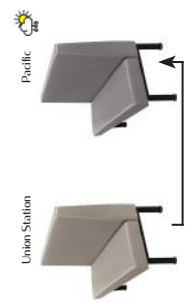
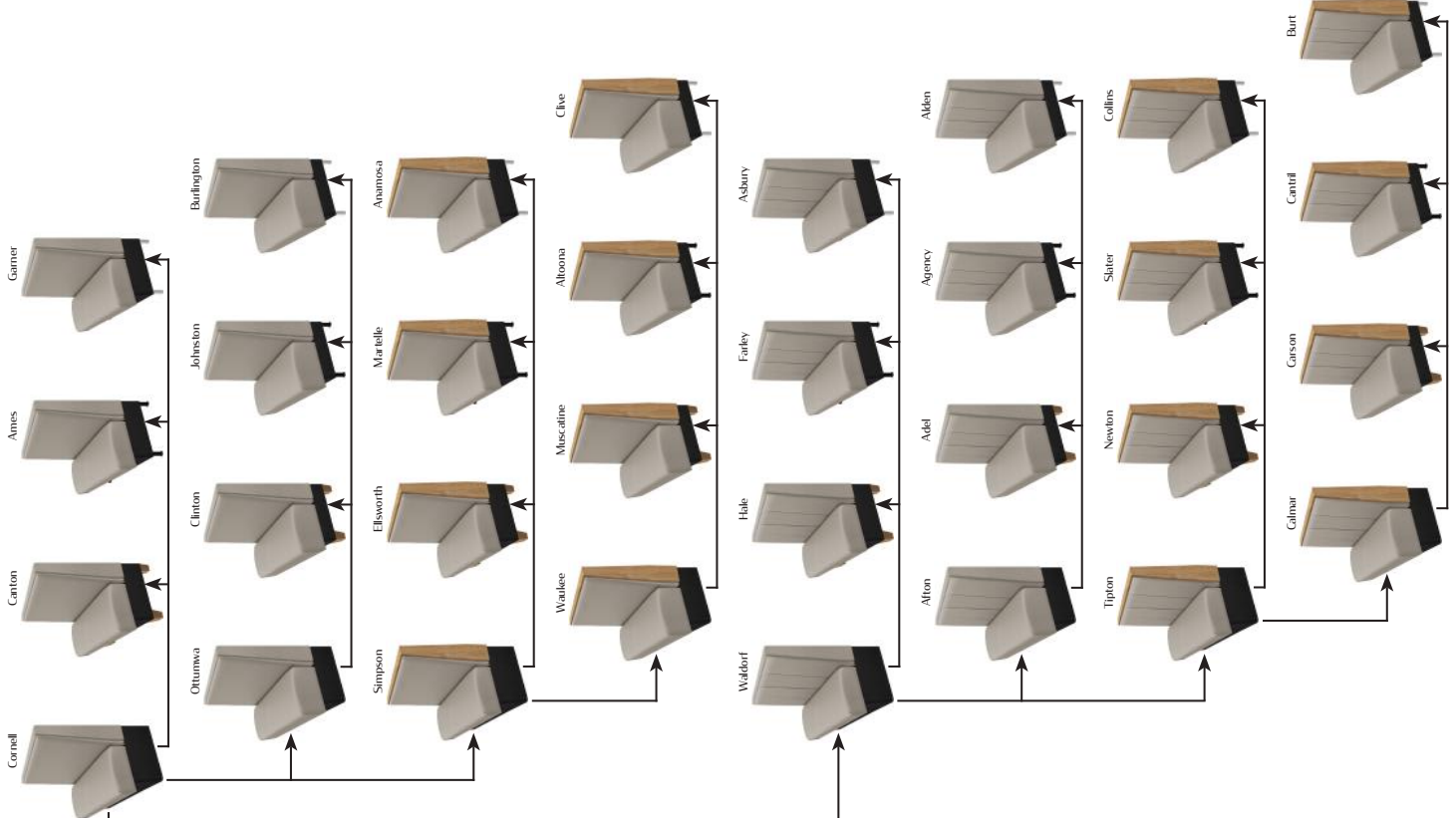

In-House Stains / Finishes

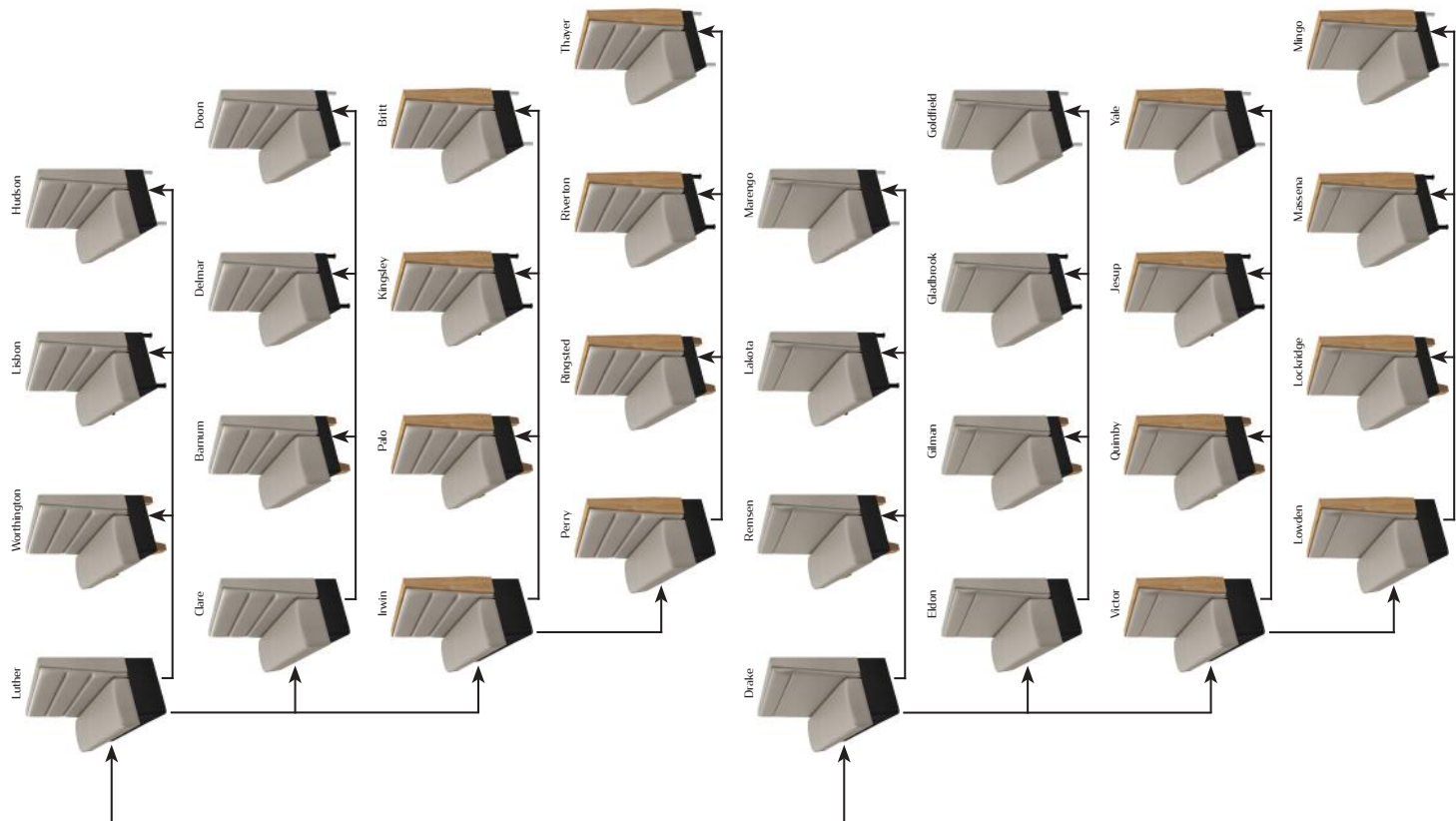
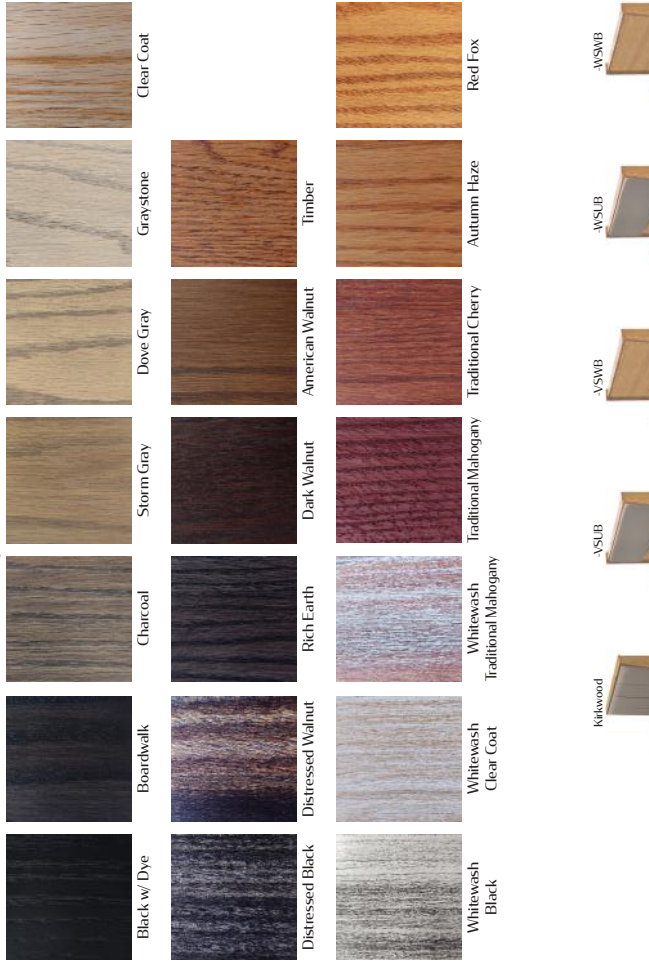

Kirkwood [RW] - wood frame construction stainable in choice of house or custom stain. Vertic of chamfered on seat back.

Shepard [SHEP] - heavy-duty oak engineered wood panels stainable in choice of house or custom stain. Available in 4 configurations - vinyl seat & back (ASLUB), vinyl seat/wood back (VSWB), wood seat/vinyl back (WSUB), wood seat & back (WSWB).

Baldwin [BN] - stainable birch engineered wood frame construction. Vinyl upholstered seat & back split into equal sections. Booths "Z" have additional sections.

Reclaimed [RW] - stainable heavy-duty oak engineered wood panels then distressed for a reclaimed look. Wick-mount Antique Bourbon Pine laminate on seat, seat back, front toiseck, & back safer (single booths split into 4 equal panels). Available in 4 configurations - vinyl seat & back (ASLUB), vinyl seat/wood back (VSWB), wood seat/vinyl back (WSUB), wood seat & back (WSWB).

Morningside [MS] - laminate side panels, seat, seat back & front upholstered in vinyl. Available in 4 configurations - vinyl seat & back (ASLUB), vinyl seat/adjustable steel legs. Seat back in choice of house or cut to order vinyl/upholstery.

Artstocrat [AST] - heavy-duty oak engineered wood panels stainable in choice of house or custom stain. Available in 4 configurations - vinyl seat & back (ASLUB), vinyl seat/wood back (VSWB), wood seat/vinyl back (WSUB), wood seat & back (WSWB).

Cascade [CS] - unitized steel frame with oak engineered wood planks on seat & back stainable in any house or custom stain.

Durango [DRN] - uniquely routed heavy-duty oak engineered wood panels stainable in choice of house or custom stain. Available in 4 configurations - vinyl seat & back (ASLUB), vinyl seat/wood back (VSWB), wood seat/vinyl back (WSUB), wood seat & back (WSWB).

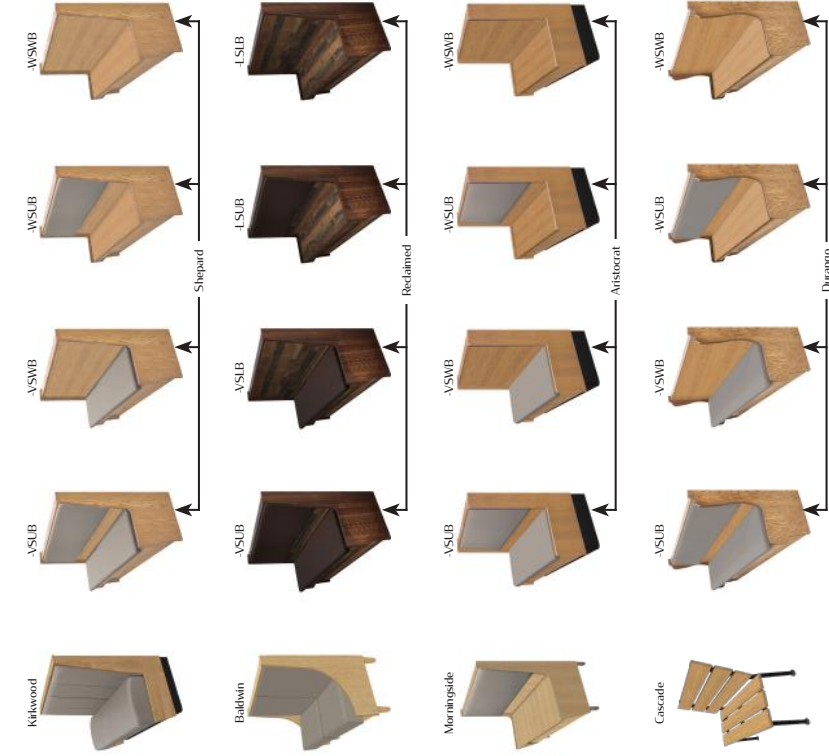

In-House Vinyls

Shown on Ambrose booths



Tiered Vinyls / Upholstery



More options available online

bit.ly/vinyl-upholstery-fabric



Tiered Vinyls / Upholstery

More options available online



Seat & Back:
Stinson Avant
Camel AV124
Tier 1



Seat & Back:
Stinson Avant
Tuscany AV303
Tier 1



Seat & Back:
Stinson Avant
Sand AV122
Tier 1



Seat & Back:
Stinson Avant
Parchment AV123
Tier 1



Seat & Back:
Stinson Avant
Bisque AV131
Tier 1



Seat & Back:
Stinson Avant
Putty AV129
Tier 1



Seat & Back:
Stinson Avant
Taupe AV132
Tier 1



Seat & Back:
Stinson Avant
Bone AV130
Tier 1



Seat & Back:
Stinson Avant
Alabaster AV128
Tier 1



Seat & Back:
Stinson Avant
Adobe White AV127
Tier 1



Seat & Back:
Stinson Avant
Espresso AV121
Tier 1



Seat & Back:
Stinson Avant
Mocha AV120
Tier 1



Seat & Back:
Stinson Avant
Carafe AV309
Tier 1



Seat & Back:
Stinson Avant
Chestnut AV117
Tier 1



Seat & Back:
Stinson Avant
Bronze AV155
Tier 1



Seat & Back:
Stinson Avant
Oak AV138
Tier 1



Seat & Back:
Stinson Avant
Gingersnap AV114
Tier 1



Seat & Back:
Stinson Avant
British Tan AV113
Tier 1



Seat & Back:
Stinson Avant
Cinnamon AV119
Tier 1



Seat & Back:
Stinson Avant
Terra Cotta AV118
Tier 1



Seat & Back:
Stinson Avant
Midnight AV211
Tier 1



Seat & Back:
Stinson Avant
Graphite AV142
Tier 1



Seat & Back:
Stinson Avant
Shale AV311
Tier 1



Seat & Back:
Stinson Avant
Gunmetal AV125
Tier 1



Seat & Back:
Stinson Avant
Greystone AV139
Tier 1



Seat & Back:
Stinson Avant
Pewter AV306
Tier 1



Seat & Back:
Stinson Avant
Dove AV133
Tier 1



Seat & Back:
Stinson Avant
Gray Moss AV157
Tier 1



Seat & Back:
Stinson Avant
Sun Yellow AV101
Tier 1



Seat & Back:
Stinson Avant
Mandarin Orange AV116
Tier 1



Seat & Back:
Stinson Spirit
Abyss 64038
Tier 1



Seat & Back:
Stinson Spirit
Storm 64032
Tier 1



Seat & Back:
Stinson Spirit
Graphite 64027
Tier 1



Seat & Back:
Stinson Spirit
Breeze 64028
Tier 1



Seat & Back:
Stinson Spirit
Mist 64020
Tier 1



Seat & Back:
Stinson Spirit
Post 64037
Tier 1



Seat & Back:
Stinson Spirit
Twig 64025
Tier 1



Seat & Back:
Stinson Spirit
Quarry 64022
Tier 1



Seat & Back:
Stinson Spirit
Driftwood 64033
Tier 1



Seat & Back:
Stinson Spirit
Ivory 64021
Tier 1



Seat & Back:
Stinson Spirit
Nocturne 64031
Tier 1



Seat & Back:
Stinson Spirit
Turquoise 64023
Tier 1



Seat & Back:
Stinson Spirit
Fern 64027
Tier 1



Seat & Back:
Stinson Spirit
Gold 64024
Tier 1



Seat & Back:
Stinson Spirit
Blaze 64029
Tier 1



Seat & Back:
Stinson Spirit
Rust 64030
Tier 1



Seat & Back:
Stinson Spirit
Cherry 64034
Tier 1



Seat & Back:
Stinson Spirit
Cordovan 64035
Tier 1



Seat & Back:
Stinson Spirit
Blackberry 64036
Tier 1



Seat & Back:
Stinson Spirit Plus
Adobe White 5641-990
Tier 1



Seat & Back:
Douglass Patriot Plus
Dark Aqua 5641-380
Tier 1



Seat & Back:
Douglass Patriot Plus
Yew Green 5641-640
Tier 1



Seat & Back:
Douglass Patriot Plus
Forest 5641-633
Tier 1



Seat & Back:
Douglass Patriot Plus
Aqua Grey 5641-300
Tier 1



Seat & Back:
Douglass Patriot Plus
Cypress 5641-634
Tier 1



Seat & Back:
Douglass Patriot Plus
Granny Smith 5641-657
Tier 1



Seat & Back:
Douglass Patriot Plus
Sage 5641-603
Tier 1



Seat & Back:
Douglass Patriot Plus
Eucalyptus 5641-681
Tier 1



Seat & Back:
Douglass Patriot Plus
Dove 5641-229
Tier 1



Seat & Back:
Douglass Patriot Plus
Concrete 5641-105
Tier 1



Seat & Back:
Douglass Patriot Plus
Aubergine 5641-851
Tier 1



Seat & Back:
Douglass Patriot Plus
Purple Grey 5641-816
Tier 1



Seat & Back:
Douglass Patriot Plus
Mulberry 5641-814
Tier 1



Seat & Back:
Douglass Patriot Plus
Mocha 5641-424
Tier 1



Seat & Back:
Douglass Patriot Plus
Chestnut 5641-440
Tier 1



Seat & Back:
Douglass Patriot Plus
Sable 5641-410
Tier 1



Seat & Back:
Douglass Patriot Plus
Putty 5641-134
Tier 1



Seat & Back:
Douglass Patriot Plus
Lark 5641-106
Tier 1



Seat & Back:
Douglass Patriot Plus
Sand 5641-970
Tier 1



Seat & Back:
Douglass Patriot Plus
Oatmeal 5641-161
Tier 1



Seat & Back:
Douglass Patriot Plus
Burgundy 5641-810
Tier 1



Seat & Back:
Douglass Patriot Plus
Port 5641-815
Tier 1



Seat & Back:
Douglass Patriot Plus
Bordeaux 5641-880
Tier 1



Seat & Back:
Douglass Patriot Plus
Ruby 5641-812
Tier 1



Seat & Back:
Douglass Patriot Plus
Berry 5641-811
Tier 1



Seat & Back:
Douglass Patriot Plus
Paprika 5641-830
Tier 1



Seat & Back:
Douglass Patriot Plus
Terra Cotta 5641-740
Tier 1



Seat & Back:
Douglass Patriot Plus
American Beauty 5641-884
Tier 1



Seat & Back:
Douglass Patriot Plus
Salsa 5641-832
Tier 1



Seat & Back:
Douglass Patriot Plus
Orange Kist 5641-760
Tier 1



Seat & Back:
Douglass Patriot Plus
Deep Phoenician 5641-859
Tier 1



Seat & Back:
Douglass Patriot Plus
Midnight Blue 5641-360
Tier 1



Seat & Back:
Douglass Patriot Plus
Imperial Blue 5641-372
Tier 1



Seat & Back:
Douglass Patriot Plus
Sapphire 5641-371
Tier 1



Seat & Back:
Douglass Patriot Plus
Royal 5641-370
Tier 1



Seat & Back:
Douglass Patriot Plus
Colonial Blue 5641-310
Tier 1



Seat & Back:
Douglass Patriot Plus
Sea 5641-648
Tier 1



Seat & Back:
Douglass Patriot Plus
Grotto 5641-374
Tier 1



Seat & Back:
Douglass Patriot Plus
Peacock 5641-627
Tier 1



Seat & Back:
Douglass Patriot Plus
Space Blue 5641-344
Tier 1

Ambrose Top stitched seams with updated pillow back



48" L x 42" H singles & doubles
stocked in black in-house vinyl
Std. lengths: 24", 30", 44", 48", 60", 72", 84", 96" -
over 96" considered a banquette. Std. heights: 42", 36".

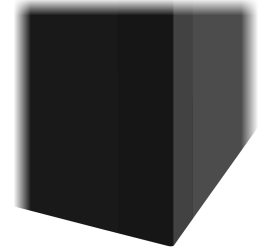

Available with vinyl (L) or steel (R) toe-kick

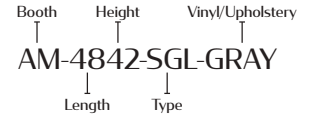

Hamilton Ambrose w/ wood legs



Std. lengths: 24", 30", 44", 48", 60", 72", 84", 96" -
over 96" considered a banquette. Std. heights: 42", 36".



Stainable in any in-house stain
3.625" W x 3.625" D (top) / 2.5" W x 2.5" D (bottom) x 4" H

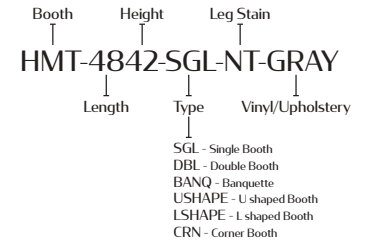

All Oak Street vinyl booth seats are reversible & removable - prolonging the life of seat & making it easier to clean.

Grove Ambrose w/ brushed aluminum legs



Std. lengths: 24", 30", 44", 48", 60", 72", 84", 96" -
over 96" considered a banquette. Std. heights: 42", 36".



1.5" W x 1.5" D x 4" H

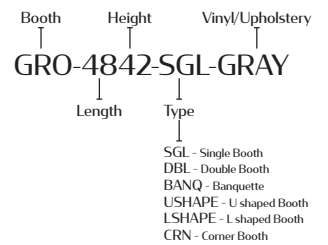

All Oak Street vinyl booths feature independent seat backs that are bolted, not glued or stapled to base - adding strength & durability.

Morley Ambrose w/ black steel legs



Std. lengths: 24", 30", 44", 48", 60", 72", 84", 96" -
over 96" considered a banquette. Std. heights: 42", 36".



1.5" W x 1.5" D x 4" H

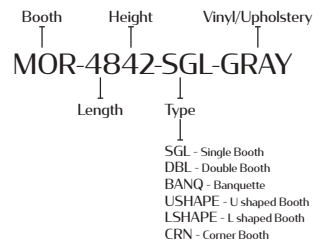

Oak Street vinyl booth frames are more durable than competitors. 48+ screws & bolts are used in assembly.



Clarke Ambrose with 'V' accent panel on seat back



All Oak Street vinyl booths feature metal edge brackets are used in base corners - adding strength & durability.

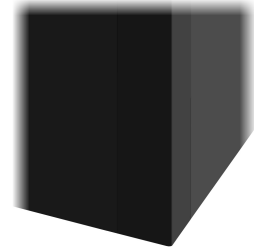
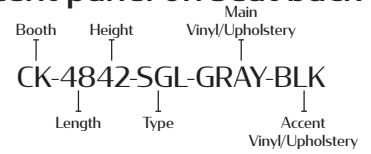

Available with vinyl (L) or steel (R) toekick



Booths & Benches Made to Order



Waterloo Clarke w/ wood legs

Std. lengths: 24", 30", 44", 48", 60", 72", 84", 96" - over 96" considered a banquette. Std. heights: 42", 36".



- SGL - Single Booth
- DBL - Double Booth
- BANQ - Banquette
- USHAPE - U shaped Booth
- LSHAPE - L shaped Booth
- CRN - Corner Booth



All Oak Street booth seats & backs feature slip sheets over seat foam allow vinyl or upholstery to recover after use - reducing wear.

Stainable in any in-house stain
3.625" W x 3.625" D (top) / 2.5" W x 2.5" D (bottom) x 4" H



Davenport Clarke w/ brushed aluminum legs

Std. lengths: 24", 30", 44", 48", 60", 72", 84", 96" - over 96" considered a banquette. Std. heights: 42", 36".

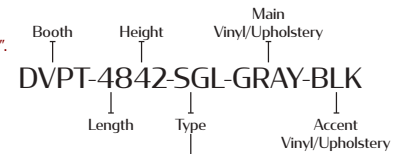

- SGL - Single Booth
- DBL - Double Booth
- BANQ - Banquette
- USHAPE - U shaped Booth
- LSHAPE - L shaped Booth
- CRN - Corner Booth



All Oak Street booth seats & backs feature fully sculpted, springless foam. No springs to break, sag or squeak.

1.5" W x 1.5" D x 4" H



Ankeny Clarke w/ black steel legs

Std. lengths: 24", 30", 44", 48", 60", 72", 84", 96" - over 96" considered a banquette. Std. heights: 42", 36".

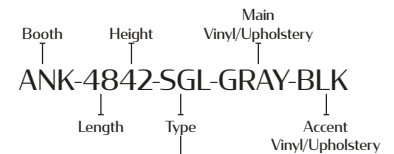

- SGL - Single Booth
- DBL - Double Booth
- BANQ - Banquette
- USHAPE - U shaped Booth
- LSHAPE - L shaped Booth
- CRN - Corner Booth



All Oak Street vinyl booth seats are reversible & removable - prolonging the life of seat & making it easier to clean.

1.5" W x 1.5" D x 4" H



Clarke - Waterloo - Davenport - Ankeny

Wartburg Ambrose w/ extra thick 11" seat



All Oak Street vinyl booth seats are reversible & removable - prolonging the life of seat & making it easier to clean.

Booth Height Vinyl/Upholstery
WART-4842-SGL-GRAY
 Length Type

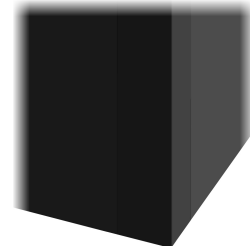
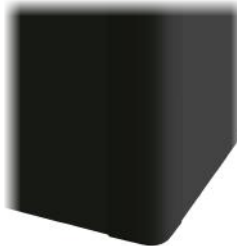

Available with vinyl (L) or steel (R) toe-kick

Edinburgh Wartburg w/ wood legs



Std. lengths: 24", 30", 44", 48", 60", 72", 84", 96" - over 96" considered a banquette. Std. heights: 42", 36".

Booth Height Leg Stain
EDIN-4842-SGL-NT-GRAY
 Length Type Vinyl/Upholstery



SGL - Single Booth
 DBL - Double Booth
 BANQ - Banquette
 USHAPE - U shaped Booth
 LSHAPE - L shaped Booth
 CRN - Corner Booth



All Oak Street vinyl booth ends are finished for endless room reconfiguration possibilities.

Stainable in any in-house stain
 3.625" W x 3.625" D (top) / 2.5" W x 2.5" D (bottom) x 4" H

Langworthy Wartburg w/ brushed aluminum legs



Std. lengths: 24", 30", 44", 48", 60", 72", 84", 96" - over 96" considered a banquette. Std. heights: 42", 36".

Booth Height Vinyl/Upholstery
LANG-4842-SGL-GRAY
 Length Type



SGL - Single Booth
 DBL - Double Booth
 BANQ - Banquette
 USHAPE - U shaped Booth
 LSHAPE - L shaped Booth
 CRN - Corner Booth



All Oak Street vinyl booths feature independent seat backs that are bolted, not glued or stapled to base - adding strength & durability.

1.5" W x 1.5" D x 4" H

Onslow Wartburg w/ black steel legs



Std. lengths: 24", 30", 44", 48", 60", 72", 84", 96" - over 96" considered a banquette. Std. heights: 42", 36".

Booth Height Vinyl/Upholstery
ONS-4842-SGL-GRAY
 Length Type



SGL - Single Booth
 DBL - Double Booth
 BANQ - Banquette
 USHAPE - U shaped Booth
 LSHAPE - L shaped Booth
 CRN - Corner Booth



Oak Street vinyl booth frames are more durable than competitors. 48+ screws & bolts are used in assembly.

1.5" W x 1.5" D x 4" H

(877) 465-4344

Loras Wartburg w/ laminate privacy panel



Choose from thousands of laminate options offered by:
PINNACLE DECORATIVE LAMINATES or **FORMICA**

Booth Height Vinyl/Upholstery
LS-4842-SGL-GRAY
 Length Type



Available with vinyl (L) or steel (R) toekick

Urbandale Loras w/ wood legs



Choose from thousands of laminate options offered by:
PINNACLE DECORATIVE LAMINATES or **FORMICA**

Booth Height Leg Stain
URB-4842-SGL-NT-GRAY
 Length Type Vinyl/Upholstery



SGL - Single Booth
 DBL - Double Booth
 BANQ - Banquette
 USHAPE - U shaped Booth
 LSHAPE - L shaped Booth
 CRN - Corner Booth

Std. lengths: 24", 30", 44", 48", 60", 72", 84", 96" - over 96" considered a banquette. Std. heights: 42", 36".

Indicate privacy panel laminate & PVC edge color at time of order

Stainable in any in-house stain
 3.625" W x 3.625" D (top) / 2.5" W x 2.5" D (bottom) x 4" H

Bettendorf Loras w/ brushed aluminum legs



Choose from thousands of laminate options offered by:
PINNACLE DECORATIVE LAMINATES or **FORMICA**

Booth Height Vinyl/Upholstery
BDF-4842-SGL-GRAY
 Length Type



SGL - Single Booth
 DBL - Double Booth
 BANQ - Banquette
 USHAPE - U shaped Booth
 LSHAPE - L shaped Booth
 CRN - Corner Booth

Std. lengths: 24", 30", 44", 48", 60", 72", 84", 96" - over 96" considered a banquette. Std. heights: 42", 36".

Indicate privacy panel laminate & PVC edge color at time of order

1.5" W x 1.5" D x 4" H

Marion Loras w/ black steel legs



Choose from thousands of laminate options offered by:
PINNACLE DECORATIVE LAMINATES or **FORMICA**

Booth Height Vinyl/Upholstery
MRN-4842-SGL-GRAY
 Length Type



SGL - Single Booth
 DBL - Double Booth
 BANQ - Banquette
 USHAPE - U shaped Booth
 LSHAPE - L shaped Booth
 CRN - Corner Booth

Std. lengths: 24", 30", 44", 48", 60", 72", 84", 96" - over 96" considered a banquette. Std. heights: 42", 36".

Indicate privacy panel laminate & PVC edge color at time of order

1.5" W x 1.5" D x 4" H

In-House Vinyls

Shown on Cornell booths

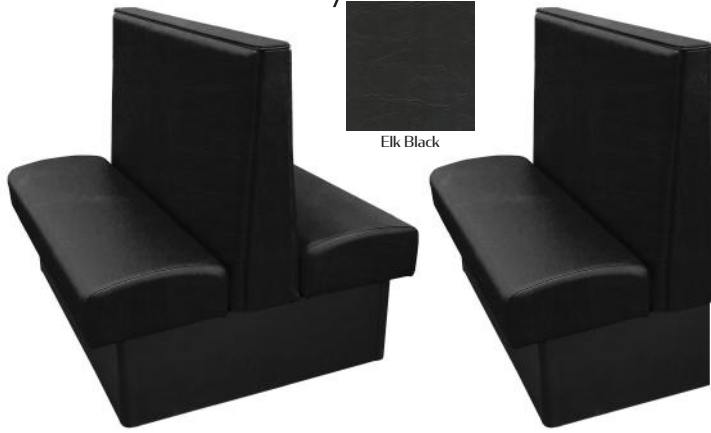

In-House Vinyls

Shown on Cornell booths

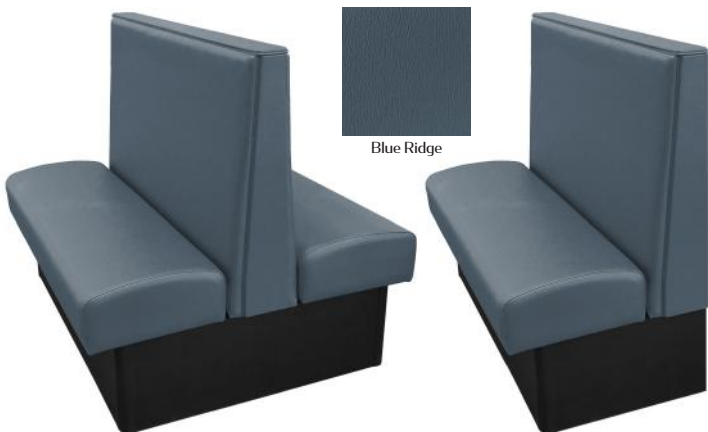
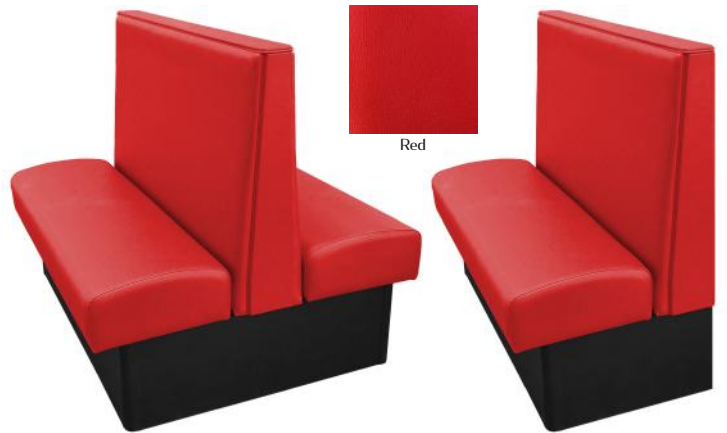

Looking for a unique vinyl/upholstery option?
Choose from thousands of vinyl & upholstery options offered by:

Stinson or  **DOUGLASS**
FABRICS

Browse the thousands of options &
order complimentary samples by visiting:
bit.ly/vinyl-upholstery-fabric

Cornell Top & side cap construction with welting



All Oak Street vinyl booths feature metal edge brackets are used in base corners - adding strength & durability.

Booth Height Vinyl/Upholstery
CR-4842-SGL-GRAY
 Length Type

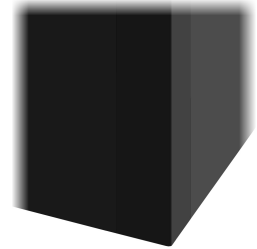

Available with vinyl (L) or steel (R) toe-kick

Canton Cornell w/ wood legs



Std. lengths: 24", 30", 44", 48", 60", 72", 84", 96" - over 96" considered a banquette. Std. heights: 42", 36".

Booth Height Leg Stain
CAN-4842-SGL-NT-GRAY
 Length Type Vinyl/Upholstery
 SGL - Single Booth
 DBL - Double Booth
 BANQ - Banquette
 USHAPE - U shaped Booth
 LSHAPE - L shaped Booth
 CRN - Corner Booth



Stainable in any in-house stain
 3.625" W x 3.625" D (top) / 2.5" W x 2.5" D (bottom) x 4" H



All Oak Street vinyl booth ends are finished for endless room reconfiguration possibilities.

Garner Cornell w/ brushed aluminum legs



Std. lengths: 24", 30", 44", 48", 60", 72", 84", 96" - over 96" considered a banquette. Std. heights: 42", 36".

Booth Height Vinyl/Upholstery
GAR-4842-SGL-GRAY
 Length Type
 SGL - Single Booth
 DBL - Double Booth
 BANQ - Banquette
 USHAPE - U shaped Booth
 LSHAPE - L shaped Booth
 CRN - Corner Booth



1.5" W x 1.5" D x 4" H



All Oak Street booth seats & backs feature fully sculpted, springless foam. No springs to break, sag or squeak.

Ames Cornell w/ black steel legs



Std. lengths: 24", 30", 44", 48", 60", 72", 84", 96" - over 96" considered a banquette. Std. heights: 42", 36".

Booth Height Vinyl/Upholstery
AMES-4842-SGL-GRAY
 Length Type
 SGL - Single Booth
 DBL - Double Booth
 BANQ - Banquette
 USHAPE - U shaped Booth
 LSHAPE - L shaped Booth
 CRN - Corner Booth



1.5" W x 1.5" D x 4" H



All Oak Street vinyl booth seats are reversible & removable - prolonging the life of seat & making it easier to clean.



Ottumwa Cornell w/ extra thick 11" seat



All Oak Street vinyl booths feature a superior one-step black vinyl toekick glued with for EVA glue process & edged with poly protective corners or ultra durable steel toekick.

Booth Height Vinyl/Upholstery
OTT-4842-SGL-GRAY
Length Type

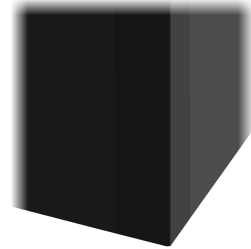

Available with vinyl (L) or steel (R) toekick



Clinton Ottumwa w/ wood legs

Std. lengths: 24", 30", 44", 48", 60", 72", 84", 96" - over 96" considered a banquette. Std. heights: 42", 36".

Booth Height Leg Stain
CLI-4842-SGL-NT-GRAY
Length Type Vinyl/Upholstery



Stainable in any in-house stain
3.625" W x 3.625" D (top) / 2.5" W x 2.5" D (bottom) x 4" H



All Oak Street booth seats & backs feature slip sheets over seat foam allow vinyl or upholstery to recover after use - reducing wear.



Burlington Ottumwa w/ brushed aluminum legs

Std. lengths: 24", 30", 44", 48", 60", 72", 84", 96" - over 96" considered a banquette. Std. heights: 42", 36".

Booth Height Vinyl/Upholstery
BRTN-4842-SGL-GRAY
Length Type



1.5" W x 1.5" D x 4" H



All Oak Street vinyl booth seats are reversible & removable - prolonging the life of seat & making it easier to clean.



Johnston Ottumwa w/ black steel legs

Std. lengths: 24", 30", 44", 48", 60", 72", 84", 96" - over 96" considered a banquette. Std. heights: 42", 36".

Booth Height Vinyl/Upholstery
JTN-4842-SGL-GRAY
Length Type



1.5" W x 1.5" D x 4" H



Oak Street vinyl booth frames are more durable than competitors. 48+ screws & bolts are used in assembly.

Booths & Benches Made to Order

Ottumwa - Clinton - Burlington - Johnston

Simpson Cornell w/ wood top & side cap



All Oak Street vinyl booth seats are reversible & removable - prolonging the life of seat & making it easier to clean.

Booth Height Stain
SIMP-4842-SGL-NT-GRAY
 Length Type Vinyl/Upholstery

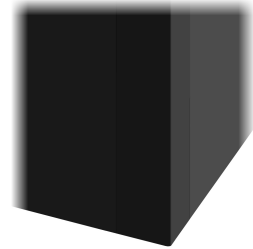

Available with vinyl (L) or steel (R) toe kick

Ellsworth Simpson w/ wood legs



Std. lengths: 24", 30", 44", 48", 60", 72", 84", 96" - over 96" considered a banquette. Std. heights: 42", 36".

Booth Height Stain
EL-4842-SGL-NT-GRAY
 Length Type Vinyl/Upholstery

SGL - Single Booth
 DBL - Double Booth
 BANQ - Banquette
 USHAPE - U shaped Booth
 LSHAPE - L shaped Booth
 CRN - Corner Booth



All Oak Street vinyl booth ends are finished for endless room reconfiguration possibilities.

Stainable in any in-house stain
 3.625" W x 3.625" D (top) / 2.5" W x 2.5" D (bottom) x 4" H

Anamosa Simpson w/ brushed aluminum legs



Std. lengths: 24", 30", 44", 48", 60", 72", 84", 96" - over 96" considered a banquette. Std. heights: 42", 36".

Booth Height Stain
ANA-4842-SGL-NT-GRAY
 Length Type Vinyl/Upholstery

SGL - Single Booth
 DBL - Double Booth
 BANQ - Banquette
 USHAPE - U shaped Booth
 LSHAPE - L shaped Booth
 CRN - Corner Booth



All Oak Street vinyl booths feature a superior one-step black vinyl toe kick glued with for EVA glue process & edged with poly protective corners or ultra durable steel toe kick.

1.5" W x 1.5" D x 4" H

Martelle Simpson w/ black steel legs



Std. lengths: 24", 30", 44", 48", 60", 72", 84", 96" - over 96" considered a banquette. Std. heights: 42", 36".

Booth Height Stain
MAR-4842-SGL-NT-GRAY
 Length Type Vinyl/Upholstery

SGL - Single Booth
 DBL - Double Booth
 BANQ - Banquette
 USHAPE - U shaped Booth
 LSHAPE - L shaped Booth
 CRN - Corner Booth



All Oak Street vinyl booths feature metal edge brackets are used in base corners - adding strength & durability.

1.5" W x 1.5" D x 4" H

(877) 465-4344



Waukee Simpson w/ extra thick 11" seat



All Oak Street booth seats & backs feature fully sculpted, springless foam. No springs to break, sag or squeak.

Booth Height Stain
WKE-4842-SGL-NT-GRAY
Length Type Vinyl/Upholstery

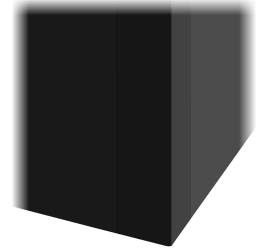

Available with vinyl (L) or steel (R) toekick



Muscatine Waukee w/ wood legs

Std. lengths: 24", 30", 44", 48", 60", 72", 84", 96" - over 96" considered a banquette. Std. heights: 42", 36".

Booth Height Stain
MCT-4842-SGL-NT-GRAY
Length Type Vinyl/Upholstery



Stainable in any in-house stain
3.625" W x 3.625" D (top) / 2.5" W x 2.5" D (bottom) x 4" H



All Oak Street vinyl booth seats are reversible & removable - prolonging the life of seat & making it easier to clean.



Clive Waukee w/ brushed aluminum legs

Std. lengths: 24", 30", 44", 48", 60", 72", 84", 96" - over 96" considered a banquette. Std. heights: 42", 36".

Booth Height Stain
CLV-4842-SGL-NT-GRAY
Length Type Vinyl/Upholstery



1.5" W x 1.5" D x 4" H



Oak Street vinyl booth frames are more durable than competitors. 48+ screws & bolts are used in assembly.



Altoona Waukee w/ black steel legs

Std. lengths: 24", 30", 44", 48", 60", 72", 84", 96" - over 96" considered a banquette. Std. heights: 42", 36".

Booth Height Stain
ALT-4842-SGL-NT-GRAY
Length Type Vinyl/Upholstery



1.5" W x 1.5" D x 4" H



All Oak Street vinyl booths feature independent seat backs that are bolted, not glued or stapled to base - adding strength & durability.

Booths & Benches Made to Order

Waukee - Muscatine - Clive - Altoona

Waldorf Cornell w/ vertical channelback



All Oak Street vinyl booths feature a superior one-step black vinyl toe kick glued with for EVA glue process & edged with poly protective corners or ultra durable steel toe kick.

Booth Height Vinyl/Upholstery
WD-4842-SGL-GRAY
 Length Type



Available with vinyl (L) or steel (R) toe kick

Hale Waldorf w/ wood legs



Std. lengths: 24", 30", 44", 48", 60", 72", 84", 96" - over 96" considered a banquette. Std. heights: 42", 36".

Booth Height Leg Stain
HALE-4842-SGL-NT-GRAY
 Length Type Vinyl/Upholstery



Stainable in any in-house stain
 3.625" W x 3.625" D (top) / 2.5" W x 2.5" D (bottom) x 4" H



All Oak Street vinyl booth ends are finished for endless room reconfiguration possibilities.

Asbury Waldorf w/ brushed aluminum legs



Std. lengths: 24", 30", 44", 48", 60", 72", 84", 96" - over 96" considered a banquette. Std. heights: 42", 36".

Booth Height Vinyl/Upholstery
ASB-4842-SGL-GRAY
 Length Type



1.5" W x 1.5" D x 4" H



All Oak Street vinyl booth seats are reversible & removable - prolonging the life of seat & making it easier to clean.

Farley Waldorf w/ black steel legs



Std. lengths: 24", 30", 44", 48", 60", 72", 84", 96" - over 96" considered a banquette. Std. heights: 42", 36".

Booth Height Vinyl/Upholstery
FAR-4842-SGL-GRAY
 Length Type



1.5" W x 1.5" D x 4" H



All Oak Street booth seats & backs feature slip sheets over seat foam allow vinyl or upholstery to recover after use - reducing wear.



Afton Waldorf w/ extra thick 11" seat



All Oak Street vinyl booth seats are reversible & removable - prolonging the life of seat & making it easier to clean.

Booth Height Vinyl/Upholstery
AFT-4842-SGL-GRAY
Length Type

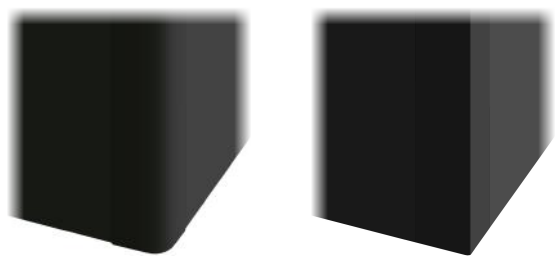

Available with vinyl (L) or steel (R) toe-kick



Adel Afton w/ wood legs

Std. lengths: 24", 30", 44", 48", 60", 72", 84", 96" - over 96" considered a banquette. Std. heights: 42", 36".

Booth Height Leg Stain Vinyl/Upholstery
ADL-4842-SGL-NT-GRAY
Length Type
SGL - Single Booth
DBL - Double Booth
BANQ - Banquette
LSHAPE - L shaped Booth
CRN - Corner Booth



Stainable in any in-house stain
3.625" W x 3.625" D (top) / 2.5" W x 2.5" D (bottom) x 4" H



All Oak Street vinyl booths feature metal edge brackets are used in base corners - adding strength & durability.



Alden Afton w/ brushed aluminum legs

Std. lengths: 24", 30", 44", 48", 60", 72", 84", 96" - over 96" considered a banquette. Std. heights: 42", 36".

Booth Height Vinyl/Upholstery
ALDN-4842-SGL-GRAY
Length Type
SGL - Single Booth
DBL - Double Booth
BANQ - Banquette
LSHAPE - L shaped Booth
CRN - Corner Booth



1.5" W x 1.5" D x 4" H



All Oak Street vinyl booths feature independent seat backs that are bolted, not glued or stapled to base - adding strength & durability.



Agency Afton w/ black steel legs

Std. lengths: 24", 30", 44", 48", 60", 72", 84", 96" - over 96" considered a banquette. Std. heights: 42", 36".

Booth Height Vinyl/Upholstery
AGCY-4842-SGL-GRAY
Length Type
SGL - Single Booth
DBL - Double Booth
BANQ - Banquette
LSHAPE - L shaped Booth
CRN - Corner Booth



1.5" W x 1.5" D x 4" H



Oak Street vinyl booth frames are more durable than competitors. 48+ screws & bolts are used in assembly.

Tipton Waldorf w/ wood top & side cap



All Oak Street booth seats & backs feature fully sculpted, springless foam. No springs to break, sag or squeak.

Booth | Height | Stain
TIP-4842-SGL-NT-GRAY
 Length | Type | Vinyl/Upholstery

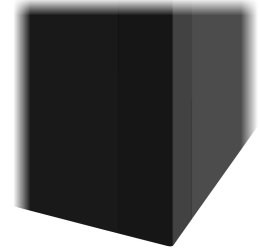

Available with vinyl (L) or steel (R) toekick

Newton Tipton w/ wood legs



Std. lengths: 24", 30", 44", 48", 60", 72", 84", 96" - over 96" considered a banquette. Std. heights: 42", 36".

Booth | Height | Stain
NEW-4842-SGL-NT-GRAY
 Length | Type | Vinyl/Upholstery

SGL - Single Booth
 DBL - Double Booth
 BANQ - Banquette
 USHAPE - U shaped Booth
 LSHAPE - L shaped Booth
 CRN - Corner Booth



All Oak Street vinyl booth seats are reversible & removable - prolonging the life of seat & making it easier to clean.

Stainable in any in-house stain
 3.625" W x 3.625" D (top) / 2.5" W x 2.5" D (bottom) x 4" H

Collins Tipton w/ brushed aluminum legs



Std. lengths: 24", 30", 44", 48", 60", 72", 84", 96" - over 96" considered a banquette. Std. heights: 42", 36".

Booth | Height | Stain
COL-4842-SGL-NT-GRAY
 Length | Type | Vinyl/Upholstery

SGL - Single Booth
 DBL - Double Booth
 BANQ - Banquette
 USHAPE - U shaped Booth
 LSHAPE - L shaped Booth
 CRN - Corner Booth



All Oak Street booth seats & backs feature slip sheets over seat foam allow vinyl or upholstery to recover after use - reducing wear.

1.5" W x 1.5" D x 4" H

Slater Tipton w/ black steel legs



Std. lengths: 24", 30", 44", 48", 60", 72", 84", 96" - over 96" considered a banquette. Std. heights: 42", 36".

Booth | Height | Stain
SLA-4842-SGL-NT-GRAY
 Length | Type | Vinyl/Upholstery

SGL - Single Booth
 DBL - Double Booth
 BANQ - Banquette
 USHAPE - U shaped Booth
 LSHAPE - L shaped Booth
 CRN - Corner Booth



All Oak Street vinyl booths feature a superior one-step black vinyl toekick glued with for EVA glue process & edged with poly protective corners or ultra durable steel toekick.

1.5" W x 1.5" D x 4" H



Calmar Tipton w/ extra thick 11" seat



All Oak Street vinyl booths feature metal edge brackets are used in base corners - adding strength & durability.

Booth Height Stain
CLMR-4842-SGL-NT-GRAY
Length Type Vinyl/Upholstery

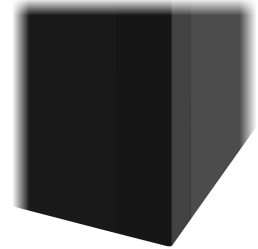

Available with vinyl (L) or steel (R) toekick



Carson Calmar w/ wood legs

Std. lengths: 24", 30", 44", 48", 60", 72", 84", 96" - over 96" considered a banquette. Std. heights: 42", 36".

Booth Height Stain
CSN-4842-SGL-NT-GRAY
Length Type Vinyl/Upholstery

SGL - Single Booth
DBL - Double Booth
BANQ - Banquette
USHAPE - U shaped Booth
LSHAPE - L shaped Booth
CRN - Corner Booth



Oak Street vinyl booth frames are more durable than competitors. 48+ screws & bolts are used in assembly.

Stainable in any in-house stain
3.625" W x 3.625" D (top) / 2.5" W x 2.5" D (bottom) x 4" H



Burt Calmar w/ brushed aluminum legs

Std. lengths: 24", 30", 44", 48", 60", 72", 84", 96" - over 96" considered a banquette. Std. heights: 42", 36".

Booth Height Stain
BURT-4842-SGL-NT-GRAY
Length Type Vinyl/Upholstery

SGL - Single Booth
DBL - Double Booth
BANQ - Banquette
USHAPE - U shaped Booth
LSHAPE - L shaped Booth
CRN - Corner Booth



All Oak Street vinyl booth seats are reversible & removable - prolonging the life of seat & making it easier to clean.

1.5" W x 1.5" D x 4" H



Cantril Calmar w/ black steel legs

Std. lengths: 24", 30", 44", 48", 60", 72", 84", 96" - over 96" considered a banquette. Std. heights: 42", 36".

Booth Height Stain
CTL-4842-SGL-NT-GRAY
Length Type Vinyl/Upholstery

SGL - Single Booth
DBL - Double Booth
BANQ - Banquette
USHAPE - U shaped Booth
LSHAPE - L shaped Booth
CRN - Corner Booth



All Oak Street vinyl booth ends are finished for endless room reconfiguration possibilities.

1.5" W x 1.5" D x 4" H

Luther Cornell w/ horizontal channelback



All Oak Street vinyl booth seats are reversible & removable - prolonging the life of seat & making it easier to clean.

Booth Height Vinyl/Upholstery
LU-4842-SGL-GRAY
 Length Type

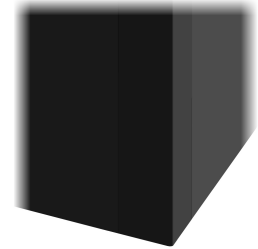

Available with vinyl (L) or steel (R) toekick

Worthington Luther w/ wood legs



Std. lengths: 24", 30", 44", 48", 60", 72", 84", 96" - over 96" considered a banquette. Std. heights: 42", 36".

Booth Height Leg Stain
WOR-4842-SGL-NT-GRAY
 Length Type Vinyl/Upholstery



Stainable in any in-house stain
 3.625" W x 3.625" D (top) / 2.5" W x 2.5" D (bottom) x 4" H



All Oak Street booth seats & backs feature slip sheets over seat foam allow vinyl or upholstery to recover after use - reducing wear.

Hudson Luther w/ brushed aluminum legs



Std. lengths: 24", 30", 44", 48", 60", 72", 84", 96" - over 96" considered a banquette. Std. heights: 42", 36".

Booth Height Vinyl/Upholstery
HUD-4842-SGL-GRAY
 Length Type



1.5" W x 1.5" D x 4" H



All Oak Street vinyl booths feature independent seat backs that are bolted, not glued or stapled to base - adding strength & durability.

Lisbon Luther w/ black steel legs



Std. lengths: 24", 30", 44", 48", 60", 72", 84", 96" - over 96" considered a banquette. Std. heights: 42", 36".

Booth Height Vinyl/Upholstery
LIS-4842-SGL-GRAY
 Length Type



1.5" W x 1.5" D x 4" H



All Oak Street booth seats & backs feature fully sculpted, springless foam. No springs to break, sag or squeak.



All Oak Street vinyl booth ends are finished for endless room reconfiguration possibilities.

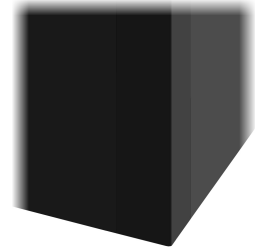

Available with vinyl (L) or steel (R) toe kick

Clare Luther w/ extra thick 11" seat

Booth Height Vinyl/Upholstery
CLR-4842-SGL-GRAY
 Length Type

Booths & Benches Made to Order



Std. lengths: 24", 30", 44", 48", 60", 72", 84", 96" - over 96" considered a banquette. Std. heights: 42", 36".



Stainable in any in-house stain
 3.625" W x 3.625" D (top) / 2.5" W x 2.5" D (bottom) x 4" H

Barnum Clare w/ wood legs

Booth Height Leg Stain Vinyl/Upholstery
BNM-4842-SGL-NT-GRAY
 Length Type
 SGL - Single Booth
 DBL - Double Booth
 BANQ - Banquette
 USHAPE - U shaped Booth
 LSHAPE - L shaped Booth
 CRN - Corner Booth



All Oak Street vinyl booths feature metal edge brackets are used in base corners - adding strength & durability.



Std. lengths: 24", 30", 44", 48", 60", 72", 84", 96" - over 96" considered a banquette. Std. heights: 42", 36".



1.5" W x 1.5" D x 4" H

Doon Clare w/ brushed aluminum legs

Booth Height Vinyl/Upholstery
DOON-4842-SGL-GRAY
 Length Type
 SGL - Single Booth
 DBL - Double Booth
 BANQ - Banquette
 USHAPE - U shaped Booth
 LSHAPE - L shaped Booth
 CRN - Corner Booth



All Oak Street vinyl booths feature a superior one-step black vinyl toe kick glued with for EVA glue process & edged with poly protective corners or ultra durable steel toe kick.



Std. lengths: 24", 30", 44", 48", 60", 72", 84", 96" - over 96" considered a banquette. Std. heights: 42", 36".



1.5" W x 1.5" D x 4" H

Delmar Clare w/ black steel legs

Booth Height Vinyl/Upholstery
DMR-4842-SGL-GRAY
 Length Type
 SGL - Single Booth
 DBL - Double Booth
 BANQ - Banquette
 USHAPE - U shaped Booth
 LSHAPE - L shaped Booth
 CRN - Corner Booth



All Oak Street vinyl booth seats are reversible & removable - prolonging the life of seat & making it easier to clean.

Clare - Barnum - Doon - Delmar

Irwin Luther w/ wood top & side cap



All Oak Street vinyl booths feature independent seat backs that are bolted, not glued or stapled to base - adding strength & durability.

Booth Height Stain
IR-4842-SGL-NT-GRAY
 Length Type Vinyl/Upholstery

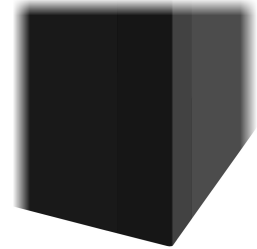

Available with vinyl (L) or steel (R) toe-kick

Palo Irwin w/ wood legs



Std. lengths: 24", 30", 44", 48", 60", 72", 84", 96" - over 96" considered a banquette. Std. heights: 42", 36".



Stainable in any in-house stain
 3.625" W x 3.625" D (top) / 2.5" W x 2.5" D (bottom) x 4" H

Booth Height Stain
PLO-4842-SGL-NT-GRAY
 Length Type Vinyl/Upholstery
 SGL - Single Booth
 DBL - Double Booth
 BANQ - Banquette
 USHAPE - U shaped Booth
 LSHAPE - L shaped Booth
 CRN - Corner Booth



All Oak Street vinyl booth seats are reversible & removable - prolonging the life of seat & making it easier to clean.

Britt Irwin w/ brushed aluminum legs



Std. lengths: 24", 30", 44", 48", 60", 72", 84", 96" - over 96" considered a banquette. Std. heights: 42", 36".



1.5" W x 1.5" D x 4" H

Booth Height Stain
BRT-4842-SGL-NT-GRAY
 Length Type Vinyl/Upholstery
 SGL - Single Booth
 DBL - Double Booth
 BANQ - Banquette
 USHAPE - U shaped Booth
 LSHAPE - L shaped Booth
 CRN - Corner Booth



All Oak Street booth seats & backs feature fully sculpted, springless foam. No springs to break, sag or squeak.

Kingsley Irwin w/ black steel legs



Std. lengths: 24", 30", 44", 48", 60", 72", 84", 96" - over 96" considered a banquette. Std. heights: 42", 36".



1.5" W x 1.5" D x 4" H

Booth Height Stain
KGY-4842-SGL-NT-GRAY
 Length Type Vinyl/Upholstery
 SGL - Single Booth
 DBL - Double Booth
 BANQ - Banquette
 USHAPE - U shaped Booth
 LSHAPE - L shaped Booth
 CRN - Corner Booth



Oak Street vinyl booth frames are more durable than competitors. 48+ screws & bolts are used in assembly.



Perry Irwin w/ extra thick 11" seat

All Oak Street vinyl booths feature a superior one-step black vinyl toekick glued with for EVA glue process & edged with poly protective corners or ultra durable steel toekick.

Booth Height Stain
PRY-4842-SGL-NT-GRAY
Length Type Vinyl/Upholstery

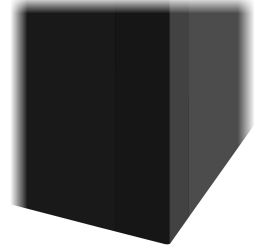

Available with vinyl (L) or steel (R) toekick



Std. lengths: 24", 30", 44", 48", 60", 72", 84", 96" - over 96" considered a banquette. Std. heights: 42", 36".

Ringsted Perry w/ wood legs

Booth Height Stain
RST-4842-SGL-NT-GRAY
Length Type Vinyl/Upholstery

SGL - Single Booth
DBL - Double Booth
BANQ - Banquette
USHAPE - U shaped Booth
LSHAPE - L shaped Booth
CRN - Corner Booth



All Oak Street booth seats & backs feature slip sheets over seat foam allow vinyl or upholstery to recover after use - reducing wear.

Stainable in any in-house stain
3.625" W x 3.625" D (top) / 2.5" W x 2.5" D (bottom) x 4" H



Std. lengths: 24", 30", 44", 48", 60", 72", 84", 96" - over 96" considered a banquette. Std. heights: 42", 36".

Thayer Perry w/ brushed aluminum legs

Booth Height Stain
TYR-4842-SGL-NT-GRAY
Length Type Vinyl/Upholstery

SGL - Single Booth
DBL - Double Booth
BANQ - Banquette
USHAPE - U shaped Booth
LSHAPE - L shaped Booth
CRN - Corner Booth



All Oak Street vinyl booth seats are reversible & removable - prolonging the life of seat & making it easier to clean.

1.5" W x 1.5" D x 4" H



Std. lengths: 24", 30", 44", 48", 60", 72", 84", 96" - over 96" considered a banquette. Std. heights: 42", 36".

Riverton Perry w/ black steel legs

Booth Height Stain
RTN-4842-SGL-NT-GRAY
Length Type Vinyl/Upholstery

SGL - Single Booth
DBL - Double Booth
BANQ - Banquette
USHAPE - U shaped Booth
LSHAPE - L shaped Booth
CRN - Corner Booth



All Oak Street vinyl booth ends are finished for endless room reconfiguration possibilities.

1.5" W x 1.5" D x 4" H

Drake Cornell w/ 6" headroll



All Oak Street vinyl booth seats are reversible & removable - prolonging the life of seat & making it easier to clean.

Booth Height Vinyl/Upholstery
DRK-4842-SGL-GRAY
 Length Type

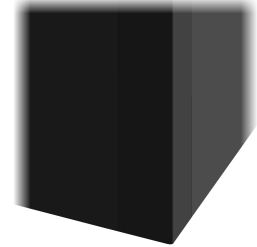

Available with vinyl (L) or steel (R) toe-kick

Remsen Drake w/ wood legs



Std. lengths: 24", 30", 44", 48", 60", 72", 84", 96" - over 96" considered a banquette. Std. heights: 42", 36".

Booth Height Leg Stain
REM-4842-SGL-NT-GRAY
 Length Type Vinyl/Upholstery
 SGL - Single Booth
 DBL - Double Booth
 BANQ - Banquette
 USHAPE - U shaped Booth
 LSHAPE - L shaped Booth
 CRN - Corner Booth



Oak Street vinyl booth frames are more durable than competitors. 48+ screws & bolts are used in assembly.

Stainable in any in-house stain
 3.625" W x 3.625" D (top) / 2.5" W x 2.5" D (bottom) x 4" H

Marengo Drake w/ brushed aluminum legs



Std. lengths: 24", 30", 44", 48", 60", 72", 84", 96" - over 96" considered a banquette. Std. heights: 42", 36".

Booth Height Vinyl/Upholstery
MRGO-4842-SGL-GRAY
 Length Type
 SGL - Single Booth
 DBL - Double Booth
 BANQ - Banquette
 USHAPE - U shaped Booth
 LSHAPE - L shaped Booth
 CRN - Corner Booth



All Oak Street vinyl booths feature independent seat backs that are bolted, not glued or stapled to base - adding strength & durability.

1.5" W x 1.5" D x 4" H

Lakota Drake w/ black steel legs



Std. lengths: 24", 30", 44", 48", 60", 72", 84", 96" - over 96" considered a banquette. Std. heights: 42", 36".

Booth Height Vinyl/Upholstery
LAK-4842-SGL-GRAY
 Length Type
 SGL - Single Booth
 DBL - Double Booth
 BANQ - Banquette
 USHAPE - U shaped Booth
 LSHAPE - L shaped Booth
 CRN - Corner Booth



All Oak Street vinyl booths feature metal edge brackets are used in base corners - adding strength & durability.

1.5" W x 1.5" D x 4" H



All Oak Street booth seats & backs feature slip sheets over seat foam allow vinyl or upholstery to recover after use - reducing wear.

Booth Height Vinyl/Upholstery
ELD-4842-SGL-GRAY
 Length Type

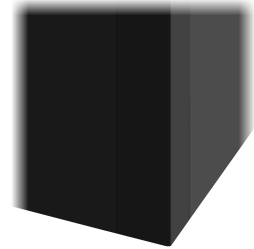

Available with vinyl (L) or steel (R) toe kick



Std. lengths: 24", 30", 44", 48", 60", 72", 84", 96" - over 96" considered a banquette. Std. heights: 42", 36".



Gilman Eldon w/ wood legs

Booth Height Leg Stain
GIL-4842-SGL-NT-GRAY
 Length Type Vinyl/Upholstery

SGL - Single Booth
 DBL - Double Booth
 BANQ - Banquette
 USHAPE - U shaped Booth
 LSHAPE - L shaped Booth
 CRN - Corner Booth



All Oak Street vinyl booth seats are reversible & removable - prolonging the life of seat & making it easier to clean.

Stainable in any in-house stain
 3.625" W x 3.625" D (top) / 2.5" W x 2.5" D (bottom) x 4" H



Std. lengths: 24", 30", 44", 48", 60", 72", 84", 96" - over 96" considered a banquette. Std. heights: 42", 36".



Goldfield Eldon w/ brushed aluminum legs

Booth Height Vinyl/Upholstery
GFD-4842-SGL-GRAY
 Length Type

SGL - Single Booth
 DBL - Double Booth
 BANQ - Banquette
 USHAPE - U shaped Booth
 LSHAPE - L shaped Booth
 CRN - Corner Booth



All Oak Street booth seats & backs feature fully sculpted, springless foam. No springs to break, sag or squeak.

1.5" W x 1.5" D x 4" H



Std. lengths: 24", 30", 44", 48", 60", 72", 84", 96" - over 96" considered a banquette. Std. heights: 42", 36".



Gladbrook Eldon w/ black steel legs

Booth Height Vinyl/Upholstery
GBK-4842-SGL-GRAY
 Length Type

SGL - Single Booth
 DBL - Double Booth
 BANQ - Banquette
 USHAPE - U shaped Booth
 LSHAPE - L shaped Booth
 CRN - Corner Booth



All Oak Street vinyl booth ends are finished for endless room reconfiguration possibilities.

1.5" W x 1.5" D x 4" H

Victor Drake w/ wood top & side cap



All Oak Street vinyl booths feature independent seat backs that are bolted, not glued or stapled to base - adding strength & durability.

Booth Height Stain
VTR-4842-SGL-NT-GRAY
 Length Type Vinyl/Upholstery

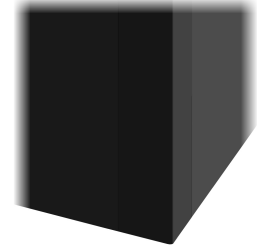

Available with vinyl (L) or steel (R) toe kick

Quimby Victor w/ wood legs



Std. lengths: 24", 30", 44", 48", 60", 72", 84", 96" - over 96" considered a banquette. Std. heights: 42", 36".

Booth Height Stain
QBY-4842-SGL-NT-GRAY
 Length Type Vinyl/Upholstery

SGL - Single Booth
 DBL - Double Booth
 BANQ - Banquette
 USHAPE - U shaped Booth
 LSHAPE - L shaped Booth
 CRN - Corner Booth



Oak Street vinyl booth frames are more durable than competitors. 48+ screws & bolts are used in assembly.

Stainable in any in-house stain
 3.625" W x 3.625" D (top) / 2.5" W x 2.5" D (bottom) x 4" H

Yale Victor w/ brushed aluminum legs



Std. lengths: 24", 30", 44", 48", 60", 72", 84", 96" - over 96" considered a banquette. Std. heights: 42", 36".

Booth Height Stain
YALE-4842-SGL-NT-GRAY
 Length Type Vinyl/Upholstery

SGL - Single Booth
 DBL - Double Booth
 BANQ - Banquette
 USHAPE - U shaped Booth
 LSHAPE - L shaped Booth
 CRN - Corner Booth



All Oak Street vinyl booth seats are reversible & removable - prolonging the life of seat & making it easier to clean.

1.5" W x 1.5" D x 4" H

Jesup Victor w/ black steel legs



Std. lengths: 24", 30", 44", 48", 60", 72", 84", 96" - over 96" considered a banquette. Std. heights: 42", 36".

Booth Height Stain
JSP-4842-SGL-NT-GRAY
 Length Type Vinyl/Upholstery

SGL - Single Booth
 DBL - Double Booth
 BANQ - Banquette
 USHAPE - U shaped Booth
 LSHAPE - L shaped Booth
 CRN - Corner Booth



All Oak Street vinyl booths feature a superior one-step black vinyl toe kick glued with EVA glue process & edged with poly protective corners or ultra durable steel toe kick.

1.5" W x 1.5" D x 4" H



Lowden Victor w/ extra thick 11" seat



All Oak Street vinyl booths feature metal edge brackets are used in base corners - adding strength & durability.

Booth Height Stain
LDN-4842-SGL-NT-GRAY
Length Type Vinyl/Upholstery

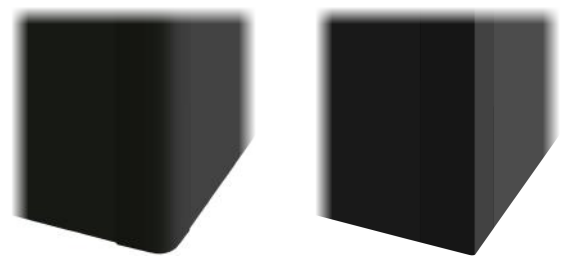

Available with vinyl (L) or steel (R) toekick



Lockridge Lowden w/ wood legs

Std. lengths: 24", 30", 44", 48", 60", 72", 84", 96" - over 96" considered a banquette. Std. heights: 42", 36".

Booth Height Stain
LKRK-4842-SGL-NT-GRAY
Length Type Vinyl/Upholstery



Stainable in any in-house stain
3.625" W x 3.625" D (top) / 2.5" W x 2.5" D (bottom) x 4" H



All Oak Street booth seats & backs feature fully sculpted, springless foam. No springs to break, sag or squeak.



Mingo Lowden w/ brushed aluminum legs

Std. lengths: 24", 30", 44", 48", 60", 72", 84", 96" - over 96" considered a banquette. Std. heights: 42", 36".

Booth Height Stain
MING-4842-SGL-NT-GRAY
Length Type Vinyl/Upholstery



1.5" W x 1.5" D x 4" H



All Oak Street vinyl booth ends are finished for endless room reconfiguration possibilities.



Massena Lowden w/ black steel legs

Std. lengths: 24", 30", 44", 48", 60", 72", 84", 96" - over 96" considered a banquette. Std. heights: 42", 36".

Booth Height Stain
MAS-4842-SGL-NT-GRAY
Length Type Vinyl/Upholstery



1.5" W x 1.5" D x 4" H



All Oak Street vinyl booth seats are reversible & removable - prolonging the life of seat & making it easier to clean.

Booths & Benches Made to Order

Lowden - Lockridge - Mingo - Massena

Union Station Unitized steel frame with vinyl seat & back



Std. lengths: 24", 30", 44", 48", 60", 72", 84", 96" - over 96" considered a banquette. Std. heights: 42", 36".

1.5" square 16 gauge unitized steel frame

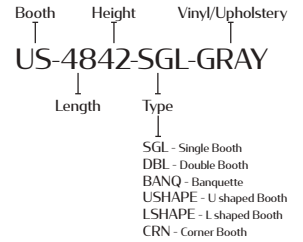

All Oak Street vinyl booth seats are reversible & removable - prolonging the life of seat & making it easier to clean.

Pacific Union Station with outdoor components



- Marine-grade vinyl with exterior-grade plywood core & closed-cell foam
- In-house outdoor vinyls include: Ocean Night, Foggy Morning, Silk & Sandy Beach
- Tier 1 pricing includes Futura Caprina Island & Palm Island marine vinyls
- Tier 2 pricing includes Spradling Seabreeze, Beluga & Zander marine vinyls
- Sunbrella outdoor upholstery also available - please contact your Oak Street Account Manager for pricing

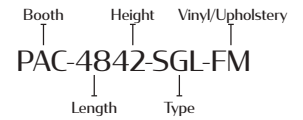

1.5" square 16 gauge exterior powder coated steel frame

2" non-marring metalpoly glides

Reef Exterior powder coated steel frame with arm rests, vinyl seat & back



- Marine-grade vinyl with exterior-grade plywood core & closed-cell foam
- In-house outdoor vinyls include: Ocean Night, Foggy Morning, Silk & Sandy Beach
- Tier 1 pricing includes Futura Caprina Island & Palm Island marine vinyls
- Tier 2 pricing includes Spradling Seabreeze, Beluga & Zander marine vinyls
- Sunbrella outdoor upholstery also available - please contact your Oak Street Account Manager for pricing



1.5" square 16 gauge exterior powder coated steel frame

2" non-marring metalpoly glides

In-House Outdoor Vinyls



Foggy Morning



Silk



Sandy Beach



Ocean Night

Tier 1 outdoor vinyls: bit.ly/outdoor-tier1

Tier 2 outdoor vinyls: bit.ly/outdoor-tier2

Sunbrella upholstery: bit.ly/os-sunbrella

Allen



- 1.5" square 16 gauge unitized steel frame
- Black powder coat finish
- 2" non-marring metalpoly glides



- 1.5" square 16 gauge unitized steel frame
- Harvest clear coat finish
- 2" non-marring metalpoly glides

- Frame height: 12"
- Cushion height: 6"
- Overall height: 18"
- Frame width: 15.25"
- Cushion width: 16.75"

Bench Vinyl/Upholstery
ALL48-GRAY-BLK
 Length Frame Finish
 BLK - Black powder coat
 H - Harvest clear coat

Std. lengths: 24", 30", 44", 48", 60", 72", 84", 96" - over 96" considered a banquette.

Looking for a unique seating option?

Choose from thousands of vinyl/upholstery options offered by:

Stinson OR **DOUGLASS FABRICS**
 Browse the thousands of options and order complimentary samples by visiting:
bit.ly/vinyl-upholstery-fabric

Wyoming



Available in:
 Engineered oak base stainable in any in-house stain or color (shown in clear coat finish)



Also available in:
 High-pressure laminate base - choice of Pinnacle, Formica or Wilsonart (shown in Pinnacle Modern Marble T 1214 SF)

- Base height: 16"
- Cushion height: 2.5"
- Overall height: 18.5"
- Base width: 15"
- Cushion width: 18"

Bench Vinyl/Upholstery
WY-48-GRAY-NT
 Length Base Finish
 Please indicate stain code if selecting engineered wood base or laminate code if selecting laminate base

Std. lengths: 24", 30", 44", 48", 60", 72", 84", 96" - over 96" considered a banquette.

Choose from thousands of laminate options offered by:

PINNACLE DECORATIVE LAMINATES OR **FORMICA**

Olin



- One-step black vinyl toe kick
- Fully sculpted, springless seat



Std. lengths: 24", 30", 44", 48", 60", 72", 84", 96" - over 96" considered a banquette.

- Base height: 11.5"
- Cushion height: 7.5"
- Overall height: 19"
- Frame width: 14.75"
- Cushion width: 17.25"

Bench Vinyl/Upholstery
OLIN-48-GRAY
 Length



Available with vinyl (L) or steel (R) toe kick

Briar



- One-step black vinyl toe kick
- Wood legs stainable in any in-house stain or color
- Fully sculpted, springless seat



Std. lengths: 24", 30", 44", 48", 60", 72", 84", 96" - over 96" considered a banquette.

- Base height: 11.5" (includes 4" wood legs)
- Cushion height: 7.5"
- Overall height: 19"
- Frame width: 14.75"
- Cushion width: 17.25"

Bench Leg Stain Vinyl/Upholstery
BRI-48-NT-GRAY
 Length

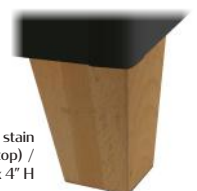

Stainable in any in-house stain
 3.625" W x 3.625" D (top) /
 2.5" W x 2.5" D (bottom) x 4" H

Zearing



SV - Standard vinyl



WD - Wood



BA - Brushed aluminum



BM - Black metal



SS - Stainless steel



Shown in: Blue Ridge in-house vinyl

- Wood frame with high-density foam wrapped in commercial-grade, fabric-backed vinyl/upholstery
- Available with standard vinyl wrapped base, wood legs, brushed aluminum legs, black metal legs or stainless steel legs

Bench Vinyl/Upholstery
ZRG-SS-GRAY
 Leg/Base Type

- Overall height: 17.75"
- Leg/base height: 4"
- Cushion width/depth: 18"
- Cushion height: 13.75"

Dimensions Vinyl/Upholstered Booths

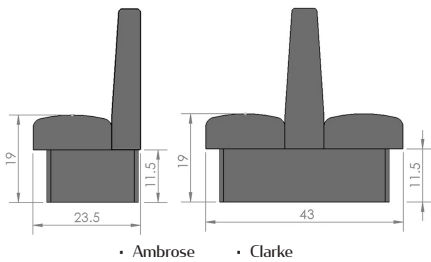

• Ambrose • Clarke

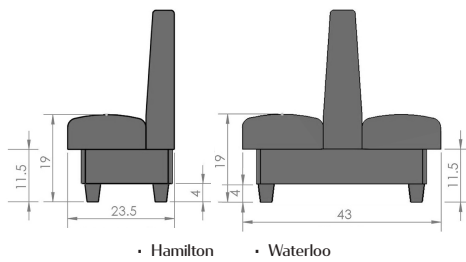

• Hamilton • Waterloo

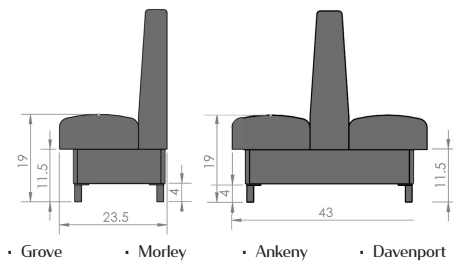

• Grove • Morley • Ankeny • Davenport

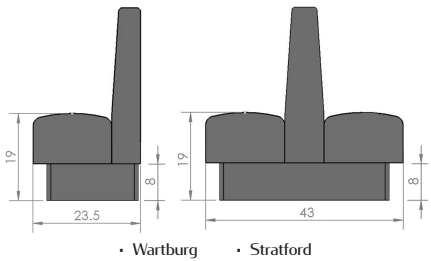

• Wartburg • Stratford



• Edinburgh • Arcadia

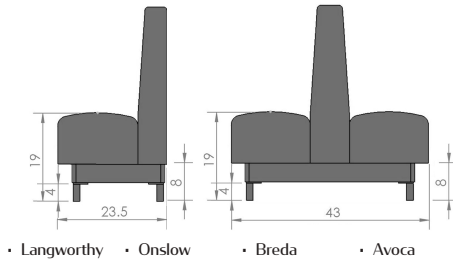

• Langworthy • Onslow • Breda • Avoca

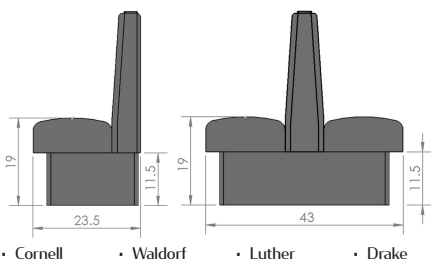

• Cornell • Waldorf • Luther • Drake
• Simpson • Tipton • Irwin • Victor

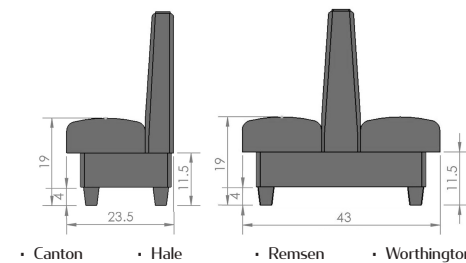

• Canton • Hale • Remsen • Worthington
• Ellsworth • Newton • Quimby • Palo

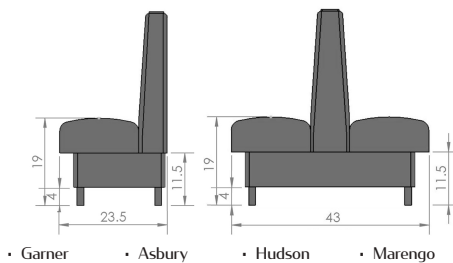

• Garner • Asbury • Hudson • Marengo
• Ames • Farley • Lisbon • Lakota
• Anamosa • Collins • Britt • Yale
• Martelle • Slater • Kingsley • Jesup

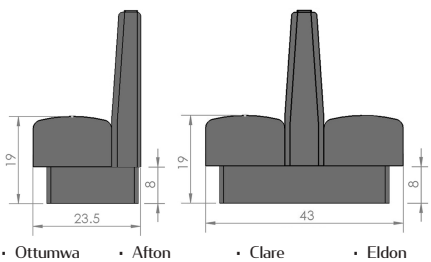

• Ottumwa • Afton • Clare • Eldon
• Waukee • Calmar • Perry • Lowden

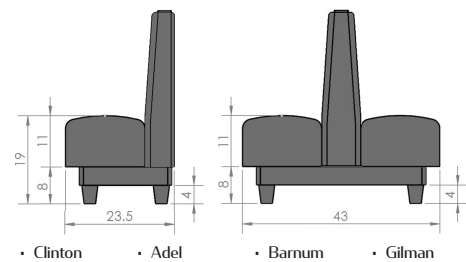

• Clinton • Adel • Barnum • Gilman
• Muscatine • Carson • Ringsted • Lockridge

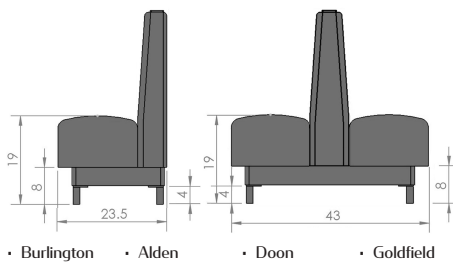

• Burlington • Alden • Doon • Goldfield
• Johnston • Agency • Delmar • Gladbrook
• Clive • Burt • Thayer • Mingo
• Altoona • Conrill • Riverton • Massena

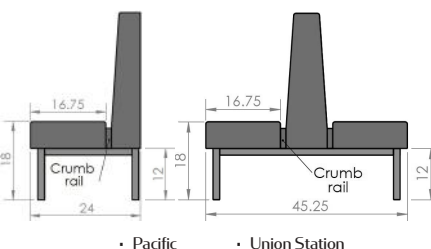

• Pacific • Union Station

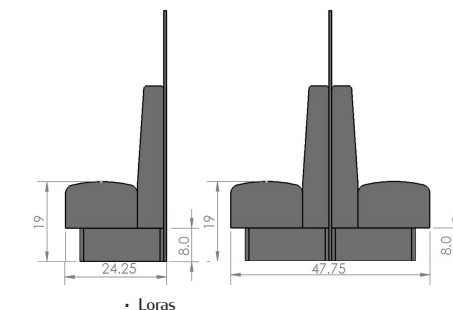

• Loras

Dimensions Vinyl/Upholstered Booths

Booths & Benches Made to Order

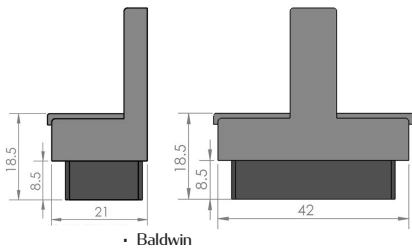

• Baldwin

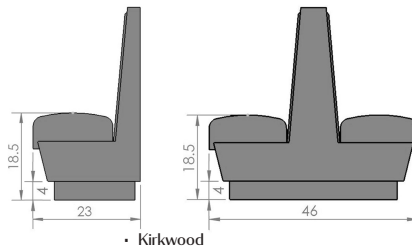

• Kirkwood

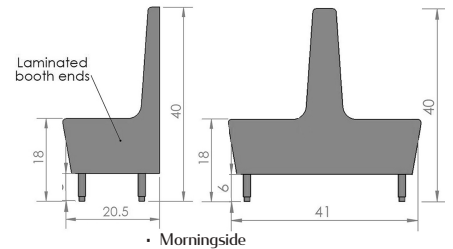

• Morningside

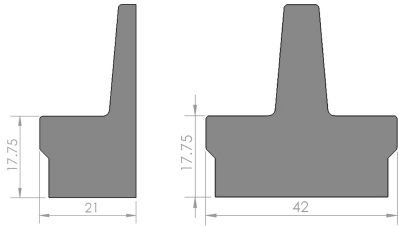

• Shepard

• Reclaimed

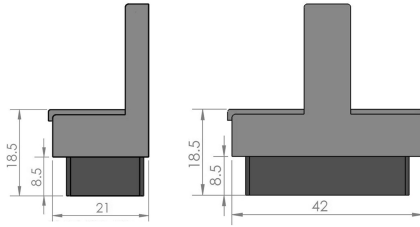

• Aristocrat

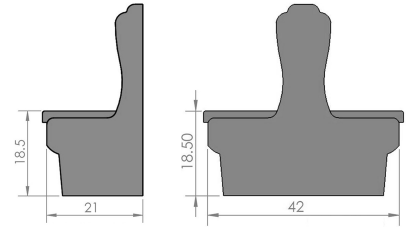

• Durango

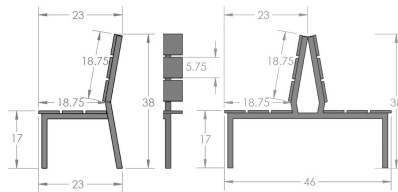

• Cascade



No springs to break, sag or squeak. Our seats have fully sculpted, springless foam.



Seats are reversible & removable - prolonging the life of seat & making it easier to clean.



Both booth ends are finished for endless room reconfiguration possibilities.



Independent seat backs are bolted, not glued or stapled to base - adding strength & durability.*

* - Not on Morningside, Shepard, Reclaimed or Durango



Slip sheets over seat foam allow vinyl or upholstery to recover after use - reducing wear.



Our frame is more durable than competitors. 48+ screws & bolts are used in assembly.



Superior one-step black vinyl toe kick glued with for EVA glue process & edged with poly protective corners.*

* - Not on Morningside, Shepard, Reclaimed or Durango



Metal edge brackets are used in base corners - adding strength & durability.

Dimensions Wood/Laminate Booths & Benches

Dimensions Benches



• Olin

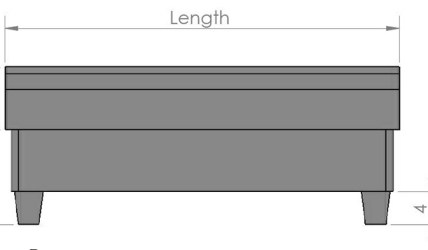
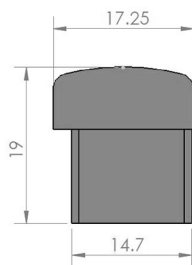

• Briar

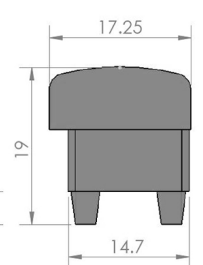

• Wyoming

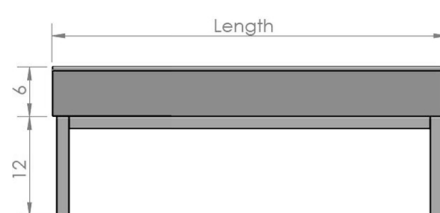
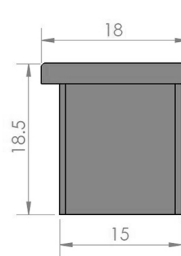

• Allen

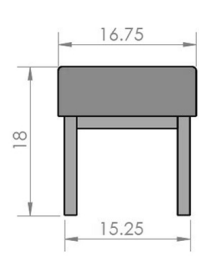

Kirkwood



Available with vinyl (T) or steel (B) toe kick



Kirkwood booth seats are reversible & removable - prolonging the life of seat & making it easier to clean.

Booth Height Stain
KW-4842-SGL-NT-GRAY
 Length Type Vinyl/Upholstery

- Oak engineered wood frame stainable in any in-house stain
- Both booth ends finished for endless room reconfiguration
- Fully sculpted, springless seat & back - features vertical channelback
- Std. lengths: 24", 30", 44", 48", 60", 72", 84", 96" - over 96" considered a banquette.
- Std. heights: 42", 36".

Baldwin



Std. lengths: 24", 30", 44", 48", 60", 72", 84", 96" - over 96" considered a banquette. Std. heights: 42", 36".



1.875" W x 1.875" D x 6" H

Booth Height Stain
BN-4842-SGL-NT-GRAY
 Length Type Vinyl/Upholstery

- Birch (Oak available) engineered wood frame stainable in any in-house stain or color
- Booths 72" or less in length have 2 cushions; Booths 72" or more in length have additional cushions
- Fully sculpted, springless seat & back

Morningside



Std. lengths: 24", 30", 44", 48", 60", 72", 84", 96" - over 96" considered a banquette. Std. height: 40"

Indicate laminate selection at time of order



1.5" Dia. x 6" H

Booth Height Vinyl/Upholstery
MG-4840-SGL-GRAY
 Length Type

- Europly engineered wood construction covered in choice of laminate
 - Edges stained in choice of in-house stain
 - Seat edge features coordinating PVC
- Engineered wood top cap stained in choice of stain

Cascade



Std. lengths: 24", 30", 44", 48", 60", 72", 84", 96" - over 96" considered a banquette. Std. height: 38".

1.5" square 16 gauge unitized steel frame



Black

Harvest

2" non-marring metalpoly glides

Booth Height Stain
CS-4838-SGL-NT
 Length Type
 SGL - Single Booth
 DBL - Double Booth
 BANQ - Banquette
 USHAPE - U shaped Booth
 LSHAPE - L shaped Booth
 CRN - Corner Booth

- 5.75" engineered Oak planks stainable in any in-house stain or color
- Unitized steel frame provides superior strength



Aristocrat

Booth Height Model Vinyl/Upholstery
 ARST-4842-SGL-VSUB-NT-GRAY
 Length Type Stain

SGL - Single Booth
 DBL - Double Booth
 BANQ - Banquette
 LSHAPE - L shaped Booth
 USHAPE - U shaped Booth
 CRN - Corner Booth

- Oak engineered wood frame stainable in any in-house stain
- Both booth ends finished for endless room reconfiguration
- 2" fully sculpted, springless cushion(s) *except -WSWB*
- Base wrapped in one-step black vinyl toekick with poly protective corners

Standard lengths: 24", 30", 44", 48", 60", 72", 84", 96" - over 96" considered a banquette. Standard heights: 42", 36".



Shepard

Booth Height Model Vinyl/Upholstery
 SHEP-4842-SGL-VSUB-NT-GRAY
 Length Type Stain

SGL - Single Booth
 DBL - Double Booth
 BANQ - Banquette
 LSHAPE - L shaped Booth
 USHAPE - U shaped Booth
 CRN - Corner Booth

- Oak engineered wood frame stainable in any in-house stain
- Both booth ends finished for endless room reconfiguration
- 1.75" fully sculpted, springless cushion(s) *except -WSWB*
- Standard unfinished back panel - optional oak veneer finished back available *upcharge*

Standard lengths: 24", 30", 44", 48", 60", 72", 84", 96" - over 96" considered a banquette. Standard heights: 42", 36".



Reclaimed

Booth Height Model Vinyl/Upholstery
 RW-4842-SGL-VSUB-DWA-GRAY
 Length Type Stain

SGL - Single Booth
 DBL - Double Booth
 BANQ - Banquette
 LSHAPE - L shaped Booth
 USHAPE - U shaped Booth
 CRN - Corner Booth

- Oak engineered wood top/side caps stainable in any in-house stain
- Both booth ends finished for endless room reconfiguration
- 1.75" fully sculpted, springless cushion(s) *except -WSWB*
- Wilsonart Antique Bourbon Pine 8215-12 on front toekick, seat, seat back & back (single booths with *optional* finished back)

Standard lengths: 24", 30", 44", 48", 60", 72", 84", 96" - over 96" considered a banquette. Standard heights: 42", 36".



Durango

Booth Height Model Vinyl/Upholstery
 DRN-4842-SGL-VSUB-NT-GRAY
 Length Type Stain

SGL - Single Booth
 DBL - Double Booth
 BANQ - Banquette
 LSHAPE - L shaped Booth
 USHAPE - U shaped Booth
 CRN - Corner Booth

- Oak engineered wood frame stainable in any in-house stain
- Both booth ends finished for endless room reconfiguration
- 1.75" fully sculpted, springless cushion(s) *except -WSWB*
- Standard unfinished back panel - optional oak veneer finished back available *upcharge*

Waste Receptacles

*** Made To Order ***

C8530 - Waste Receptacle



Black Walnut



Natural Maple



Storm Teakwood



White Ash

C8540 - Waste Receptacle



Planked Urban Oak



Prestige Walnut



Elemental Concrete



Planked Deluxe Pear

C8560 - Waste Receptacle



Carrara Bianco

DPI MD 6009 - Black Trash Liner



- 25 gallon capacity
- Dimensions: 18" W x 18" D x 26" H
- Approx. weight: 14 lbs

- Custom casework is available in any of our 9 in-house laminate options with matching 3mm edging or custom laminate options (upcharge)
 - C8530 dimensions: 21-5/8" W x 22-1/8" D x 44-1/8" H; 36-5/8" H to emptying area. Tray shelf dimensions: 19-5/8" W x 10" D
 - C8540 dimensions: 22" W x 22" D x 44" H with 3" backsplash
 - C8560 dimensions: 42" W x 22" D x 44" H with 3" backsplash
 - Also includes 2 adjustable shelves in second bay
- Units feature sturdy metal base
- Units ship assembled
- Subject to manufacturer lead times
- Requires DPI MD 6009 trash liner (sold separately - shown right)



- 3/4" top with high-pressure laminate edged in 2mm PVC - In-house options include 5 solid color (black, brown, smoke gray, taupe & white) or 8 laminate-matched (Planked Deluxe Pear, Black Walnut, Elemental Concrete, Natural Maple, White Ash, Storm Teakwood, Planked Urban Oak, Prestige Walnut). Additional laminate-matching 2mm PVC may also be available - check for details (upcharge).
- 3/4" side/back paneling also high-pressure laminate with 2mm PVC (details above)
- Sturdy metal base with solid 16 gauge metal floor
- Round brushed aluminum legs or removable magnetic toe kick
- Adjustable shelving
- **Customizable sizing, doors, tops, etc. - add cold wells, hot wells, sneeze guards, pizza pans, & more! Contact us for your customized quote!**
- Pricing based on standard Tier 1 Pinnacle, Wilsonart & Formica laminates
- Features removable side paneling that can be replaced if damaged!
- Specify if you want back panels, left/right panels finished or unfinished based on your needs

When ordering, specify:

- Desired dimensions (Height, Depth & Width)
 - Table top laminate & edge color
 - Side paneling laminate & edge color
 - Yes or no to optional magnetic toe kick
 - If doors are to be added - if so, amount of doors needed
 - Finished or unfinished side/back panels need finished with laminate, ie.:
 - Front facing - left side: unfinished; Front facing - right side: finished
- Contact us for a customized quote with any additional accessories (cold wells, hot wells, sneeze guards, pizza pans, etc.)



Upgrade to stainless steel tops (upcharge)!



Harvest Community Table Base

*** Made To Order ***

- Hot rolled 2" x 2" square 14 gauge steel
- Mig welded & polished smooth
- Clear coat finish standard -
Black sandtex finish available
- 1-1/4" nylon glide with a 3/8" x 1" threaded end
- An excellent option for adding or replacing community tables - **customizable for your specific sizing needs**
- Now available to ship knockdown! Simple leg to frame assembly required. Save on freight! Specify choice at time of order.



 Due to the nature of the product, clear coats may experience some discoloration over time.



Harvest Frame +
Fortress with E*Wood -
Black stain with dye



Harvest Frame +
Backwoods -
Smoked Oak



Harvest Frame +
Darkwash -
Black stain with dye

Popular Sizes	Harvest Base Only Part #	Base Approx. Weight
30" x 60" - Standard height	CB3060STD-D	59 lbs
30" x 60" - Bar height	CB3060BAR-D	67 lbs
30" x 72" - Standard height	CB3072STD-D	63 lbs
30" x 72" - Bar height	CB3072BAR-D	72 lbs
30" x 96" - Standard height	CB3096STD-D	72 lbs
30" x 96" - Bar height	CB3096BAR-D	80 lbs
36" x 72" - Standard height	CB3672STD-D	67 lbs
36" x 72" - Bar height	CB3672BAR-D	76 lbs
36" x 96" - Standard height	CB3696STD-D	76 lbs
36" x 96" - Bar height	CB3696BAR-D	85 lbs



FREIGHT INFORMATION

Please utilize the following freight information as a guideline for the freight process when ordering with Oak Street Manufacturing. Should any issues or concerns arise, please contact your Oak Street Manufacturing Account Manager by email or phone at (877) 465-4344.

Delivery

If a delivery date is not scheduled for your order, you must accept the shipment when the delivery truck arrives. Failure to accept the shipment will result in additional storage, re-consignment, and/or return shipping fees that will be billed back to you.

Liftgate Service

- If liftgate service is needed, you must specify it at time of order.
- If liftgate service is requested, you will be charged for liftgate service regardless if it's utilized or not.

HOW TO PROPERLY ACCEPT FREIGHT SHIPMENTS

Rights & Responsibilities

- It is your right & responsibility to inspect your order at time of delivery.
- It is your right & responsibility to note & describe damage on the BOL (Bill of Lading).
- It is your right & responsibility to also require the driver to sign the BOL that indicates damage.
- It is your right to refuse an entire shipment if damage is discovered (if desired).
- It is your responsibility to take care of all trash items associated with your shipment, e.g. pallets, banding, shrink wrap, etc. It is not the driver's responsibility to take care of the trash items & does not have to take those items with them.
- It is your responsibility to unload your shipment from the end of the driver's truck. It is the driver's responsibility to get your shipment to the end of the truck. It is not the responsibility of the driver to take your shipment off the truck.

Inspecting & Documenting Damage

It is important, in the event of an issue, to carefully follow the instructions below to ensure your shipping claim can be resolved:

All freight companies are required to allow you up to 15-30 minutes to inspect your delivery for damage or missing parts. This means you should make a complete inspection of your shipment to check for dents, cracks or broken parts. We highly recommend opening each box regardless of how it looks to inspect for damage that may not be obvious.

In the event your order is damaged (major or minor), it should be noted by writing the word "DAMAGED" on both the driver copy and your copy of the BOL (Bill of Lading), along with a description of the damage. Items missing from your order need to be written down as "ORDER INCOMPLETE".

It is critical that the driver also sign & initial both copies of the BOL if any damage is present. By noting damage on the driver's copy, this ensures there is written proof that damage was noted at the time of shipping. By having the driver sign your copy, this ensures you have proof that the driver signed in your presence.

Oak Street Manufacturing will assist as best we can in damage claims, but cannot be liable for any shipments that were accepted without a notation of damage on the shipping receipt. Be sure to keep a copy of the receipt, as this will be vital in processing a shipping claim. Photographs of the damage are extremely helpful as well to ensure successful processing of your claim. Any and all information regarding shipping damage should be sent immediately to your Oak Street Manufacturing Account Manager so we may assist you.

Failure to properly report damage will release Oak Street Manufacturing from all liability regarding shipping damage, so please document & inform us as soon as possible by telephone and/or email.

Terms & Conditions

TERMS & CONDITIONS

Orders will not be scheduled or entered into production until an account has been established or made current. Accounts past due are subject to finance charges of 1.5% per month (18% annually) or the maximum rate allowed by law. Credit terms are subject to change without notice. Customers will be liable for any costs incurred if the account is placed for collection. Returned checks are subject to a \$25 returned check charge. As an alternative to opening a credit account, the following payment terms are available:

- Credit card - MasterCard, Visa, American Express or Discover
- Wire transfers
- ACH payments
- Cash in advance - full payment for product & freight before shipping orders
- Proforma - a 50% deposit is required to begin production with the remaining balance due prior to the shipment of the order.

Oak Street Manufacturing operates on a made-to-order basis, therefore all credit requirements must be satisfied before the order can be scheduled into production.

NEW ACCOUNTS

To apply for an open account, complete the Oak Street Manufacturing credit application, found online at www.oakstreetmfg.com. All accounts must provide tax exempt documentation for the resale of restaurant furniture to receive dealer pricing or ship orders.

PRICING

All prices are subject to change without notice. All prices are in US dollars.

ESTIMATES & QUOTES

All estimates & quotes are good for 30 days from quote date unless otherwise noted.

PURCHASE ORDERS

All purchase orders must be submitted in writing via fax, mail or email. Each purchase order must be on company letterhead and bear the buyer's name. To avoid duplication of a faxed order, do not mail a confirming copy. A verification of approval is necessary. Dealers are responsible for providing the acknowledgment, signing & returning before production begins. Please note that the estimated lead time begins after all approvals are received.

DEPOSITS & PREPAYMENTS

For customers with open terms, all custom purchase orders over \$5,000 will require a 50% deposit. For prepay customers, all customer product purchase orders will require prepayment in full. Order will process on receipt of deposit or payment. Any custom orders placed on hold during the production process will result in additional lead time.

BILLING

Invoices will be emailed to customers within 48 hours of shipment unless otherwise requested.

MINIMUM ORDER FEES

All custom laminate table top orders in quantities less than 4 will be charged a small order fee. All solid wood table top orders in quantities less than 5 will be charged a small order fee.

SAMPLES

Samples are available for a 50% discount + freight cost for applicable warehouse locations.

MATCHING ORDERS

When matching a previous shipment, detailed information must be stated on the new purchase order. Please include a customer's original purchase order, Oak Street's original invoice number, sales order number & approximate ship date. Some necessary materials may no longer be available. If matching a previous order is impossible due to unavailable materials, the customer will be notified.

PRODUCT SPECIFICATIONS

Designs & specifications are subject to change without notice. All weights are approximate. Dimension & drawings are nominal. Standard colors & finishes are subject to change without notice.

IMAGE DISCLAIMER

Oak Street Manufacturing does our best to represent all products, including product colors, accurately, but the color calibration of computer monitors, printers, etc., can vary considerably. The images used in this catalog and on our website, social media pages, etc. are a close representation of our actual products & their colors. Due to photographic reproduction limitations, exact color fidelity is difficult to obtain. Actual samples should always be viewed before making a final decision, especially if color accuracy or matching is key to your decision.

ORDER CHANGES

Should circumstances require a change or cancellation of an order during production, a substantial service charge will be levied according to the order status at the time.

CANCELLATIONS

Custom orders cannot be canceled once a purchase order is received & materials have been ordered.

CALIFORNIA PROPOSITION 65

California's Proposition 65 entitles California consumers to special warnings for certain products that contain chemicals above certain threshold levels.

The general Proposition 65 notice is as follows: WARNING: This product contains chemicals known to the State of California to cause cancer and birth defects or other reproductive harm.

Proposition 65 notice for wood products is as follows: WARNING: Drilling, sawing, sanding or machining wood products generates wood dust, a substance known to the State of California to cause cancer. Use a respirator or other safeguards to avoid inhaling wood dust.

STORAGE FEES

Completed orders that require a delay in shipment of 7 business days or more will be subject to a storage fee of up to 10% of the order total per week.

SHORTAGE OF GOODS

The customer must note any shortage of cartons or products on the delivery receipt BEFORE accepting delivery from the freight company. Oak Street Manufacturing affirms all products are inspected & the number of pieces being shipped is noted on the freight Bill of Lading. If the customer does not inspect & note any shortages on the delivery receipt, Oak Street Manufacturing is not responsible for replacing shorted items until a freight claim has been issued & approved by the freight company. If the customer needs items immediately, the items will be replaced at the customer's expense. Oak Street Manufacturing will reimburse those expenses when the freight claim is approved.

RETURNED GOODS

No merchandise can be returned without Oak Street Manufacturing's return authorization. If return authorization is granted, the authorization number must be shown on the outside of the carton. A copy of the related invoice must be included & returned within 30 days of the date of the related invoice. Return authorizations will not be issued after 30 days from the original date of invoice. Merchandise must be shipped prepaid in new & unused condition, not damaged & in the original carton or packaging. All authorized returns are subject to a 25% restocking fee. Customer deductions from the related invoice will not be honored & those amounts will be considered past due. Credit memos will be mailed or faxed & can be deducted from a future invoice. Return authorization numbers expire 30 days after being issued.

Terms & Conditions

BACKORDERS

Oak Street Manufacturing will notify customers of backordered items. Customers will have the option to cancel backordered items if they will delay the shipping of an in-house order. If customers choose to have items ship upon arrival, the items will be shipped at customer's expense.

OUTDOOR USE

All products intended for indoor use only unless specifically labeled as outdoor furniture, granite tops or DuraFinish table bases. Placement of indoor furniture outdoors nullifies all warranties.

TRACKING SHIPMENTS

To track shipments, contact your Oak Street Manufacturing Account Manager for tracking numbers, freight company telephone number & website.

PREFERRED CARRIERS

Oak Street Manufacturing's preferred carriers are: FedEx Ground, Midwest Motor Express, YRC Freight, NM Transfer, R&L Carriers, Estes Express, Old Dominion, Panama Transfer & USF.

FREIGHT CLAIMS

The recipient has the right to inspect all shipments before signing any bill of lading. In the event an order arrives damaged, incomplete or overstated, the customer is required to make the appropriate notations on the delivery receipt BEFORE the bill of lading is signed. Please note all boxes leave Oak Street damaged-free. Products in boxes with damage are re-boxed. Report any product or quantity discrepancies to the carrier and to Oak Street Manufacturing immediately and note issue of bill of lading to allow for inspection and prompt issue resolution. When freight claim issues arise with a customer's designated carriers, the customer is responsible for filing freight claims. In the case of concealed damages, the customer is responsible for contacting either the carrier upon discovery of the damage or shortage of goods. Oak Street Manufacturing will not be held responsible for any concealed damage claims.

FREIGHT

Due to a large volume of outbound freight, Oak Street Manufacturing has been able to negotiate outstanding freight programs with our primary LTL AND FULL TRUCK LOAD freight carriers. Freight will be prepaid and added unless the dealer specifies differently. The customer is responsible for providing detailed and correct destination shipping information. Additional charges due to incorrect or insufficient shipping information will be billed to the customer. Third party billing and drop shipping is available upon request. Please have personnel on hand to receive shipments. Drivers are not obligated to assist in the unloading of product. It is the driver's responsible to get the freight to the rear of the trailer only. Inside or life gate delivery is not included but available upon request FOR AN ADDITIONAL CHARGE. To ensure the best freight rates and shipping safety, some items ship with simple assembly required. Oak Street Manufacturing will schedule pick-ups according to the manufacturing schedule and customer delivery needs, but is not responsible for freight estimated transit times. Guaranteed delivery dates are available for a charge. Freight quotes are estimates only based on fuel surcharges and discounts on the date of the estimate. Oak Street Manufacturing will determine the best freight call to ship all products. Will call pick-ups may be made at ANY Oak Street Manufacturing FACILITY - Please clearly note WILL CALL on the purchase order. The customer will be notified once the shipment is available.

SCHEDULED DELIVERY

Ship date estimates are shown on all sales order acknowledgments. Our best efforts are made to schedule each order based on the customer's requirements. Shipment of an order may be delayed if credit terms have not been satisfied or the account is not current. The scheduled ship date is subject to change due to weather, strikes, accidents, material availability and other factors beyond Oak Street Manufacturing's control. Guaranteed delivery dates available for additional freight charge.

PRINTED MATERIAL

Oak Street Manufacturing is not responsible for typographical or printing errors in our catalog. All such errors are subject to correction. Due to the catalog printing process, colors shown may not be exact.

COLLECTION COSTS

By placing a purchase order with Oak Street Manufacturing, all customers agree to become responsible for any collection costs associated with invoices that go past payment terms.

WARRANTY

All Oak Street Manufacturing products are warranted for indoor use with the exception of outdoor furniture and granite table tops when paired with Oak Street outdoor bases. Oak Street Manufacturing warrants all of its products and their components shall be free of defects in material and workmanship for 12 months from the date of purchase with the exception of swivels and vinyls (see below). If any of these products is found to be defective in material or workmanship during the first 12 months after original purchase date and if the product or component has been properly installed and maintained by purchaser, Oak Street Manufacturing will, at its option, replace or repair the product or component only without charge. Any off-site warranty repair must be pre-approved by Oak Street BEFORE repair work begins in order to receive reimbursement. This warranty policy does not include installation or freight of warranty items. This warranty does not apply to modified products or to those damaged by accident, abuse, neglect or misuse. When customers supplied its own vinyl or fabrics, or chooses unfinished products, there is no Oak Street Manufacturing warranty. The extent of Oak Street Manufacturing's liability is limited to the purchase price of the product sold. In no event will Oak Street Manufacturing be liable for injury, loss or damage, whether direct, consequential or incidental, to persons or property arising out of the purchaser's care or neglect. This warranty does not cover any items which have been in storage, freight damaged, improperly cared for or abused, neglected or misused.

SWIVEL WARRANTY

Oak Street Manufacturing warrants import swivels for 90 days from the date of purchase. Domestic swivels are warranted for one year from date of purchase. If swivels are found to be defective in material or workmanship during their warranted period after original purchase date and if the product or component has been properly installed and maintained by purchaser, Oak Street Manufacturing will, at its option, replace the swivel only without charge. This warranty policy does not include installation or freight of warranty items. This warranty does not apply to modified products or to those damaged by accident, abuse, neglect or misuse.

VINYL & UPHOLSTERY WARRANTY

Oak Street Manufacturing's warranty covers only manufacturer's flaws in vinyl and upholstery. Oak Street Manufacturing's warranty does not cover damage or decreased performance caused by punctures, tears, excessive wear or color loss of any kind. Oak Street Manufacturing disclaims all liability for damage due to fabrication, installation or other labor related costs. When a customer supplies its own vinyl or upholstery, there is no warranty by Oak Street Manufacturing.

SOLID WOOD, E*WOOD & PROWOOD TABLE TOP WARRANTY

Finished products are warranted only to the original customer and only against defects in workmanship for a period of one year from the date of invoice. Oak Street Manufacturing's liability and the customer's sole remedy for any breach of such warranty, breach of contract or negligence regarding a product is limited to the purchase price of the product. We are not responsible for any incidental or consequential damages incurred as a result of defective product such as re-installation costs or breach of contract, nor are we responsible for special or punitive damages. This warranty does not apply to any unfinished products, mineral oil products, or customer's own materials used in manufacturing product. We provide no warranty for such products. Placement of glass sheets or vinyl coverings over the tabletop surface will also void the warranty. Except where noted, our products are not intended for outdoor use and no warranty is made with respect to goods used outdoors which are not intended for use outdoors. Even where our products are designed for outdoor use, our warranty is limited solely to defects in workmanship for a period of one year from the date of invoice. We do not warrant or represent that the products satisfy and fire code, other fire standard, or any other standard. This warranty does not cover any items which has been in storage, freight damaged, improperly cared for or abused, neglected or misused, nor does it cover any item repaired by someone other than one of our employees unless previously authorized by us in writing. We have the option of repairing or replacing any defective item. All claims under the above warranty must be made not later than the earlier of (A) a reasonable period after discovery of any condition that may lead to a claim (not to exceed 30 days) or (B) the date which is one year from the date of our invoice and for the product. It is the customer/user's responsibility to maintain a 30% humidity level to accommodate Solid Wood, E*Wood and ProWood tops.

Oak Street Manufacturing's written warranties above are in lieu of all other expressed or implied warranties and we expressly disclaim any and all implied warranties of merchantability or fitness for a particular purpose. There are no warranties which extend beyond the description of the product list.

Recommended Chair & Table Setup

Operation Type	Space Per Seat (Sq. Ft.)
School Lunchroom / Cafeteria	9 - 12
Banquet Room	10 - 11
Table Service - Minimum	11 - 14
Business or College Cafeteria	12 - 15
Table Service - Maximum (Hotels, Clubs, etc.)	15 - 18
Commercial Cafeteria	16 - 18
Counter Service Restaurant	18 - 20

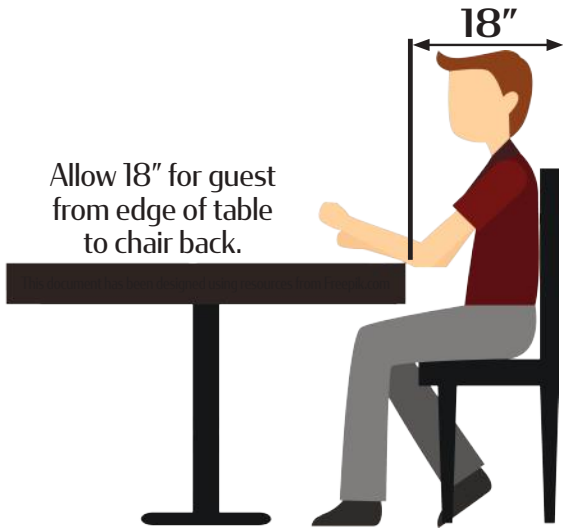

Lateral Seating:

Allow between 24" - 30" between guests.

NOTE: Armchairs & oversized chairs may require additional space between guests.

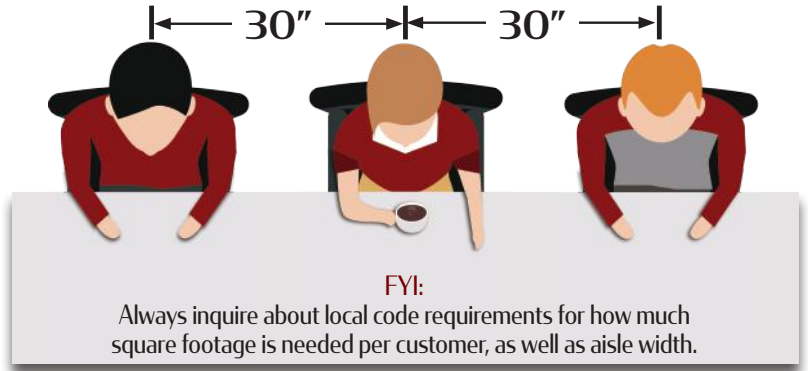

Square Tables (Chairs Back to Back):

Allow 42" between tables.

This provides approximately 6" for guests to push out.

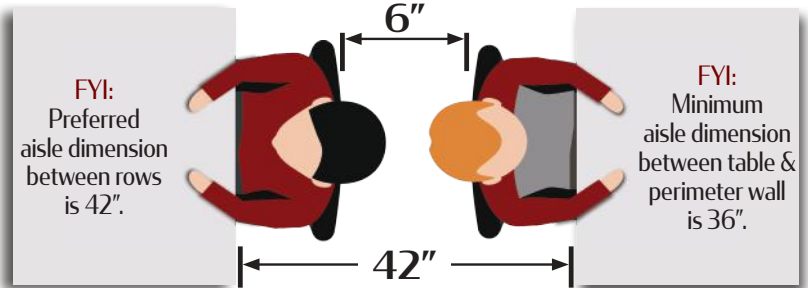

Square Tables (Chairs Back to Back - with Service Aisle):

Allow 62" between tables.

This provides approximately 26" for service aisle.

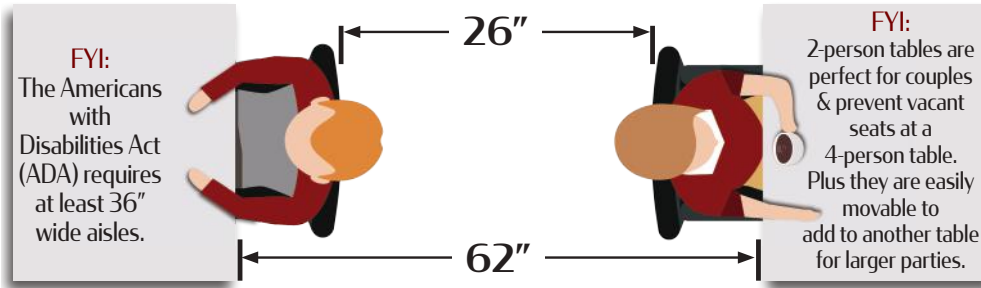

Square Tables (Diagonal Setup):

Allow 24" between table corners for customer access.

Allow 30" between table corners for customer access & narrow service aisle.

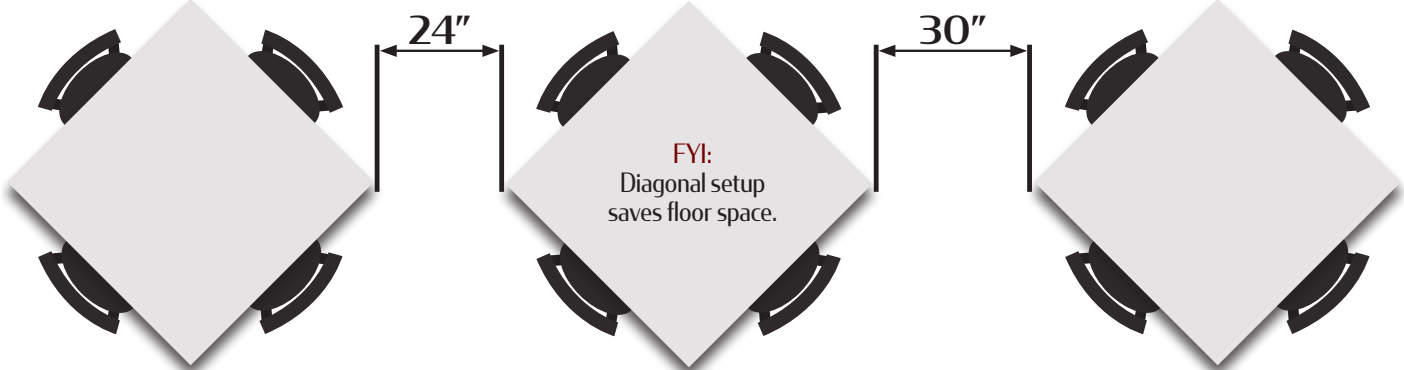

Seating Capacity Per Table Size

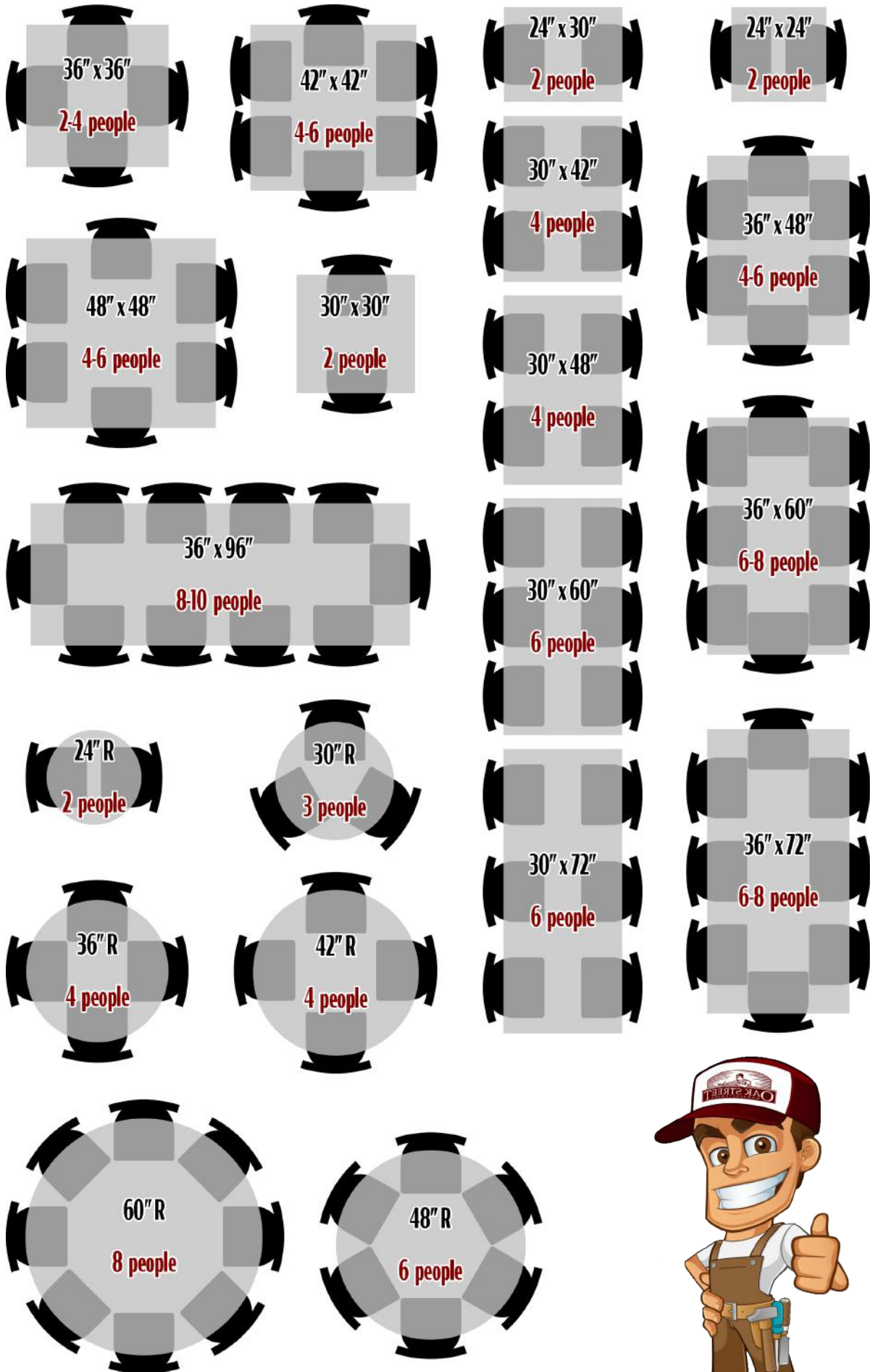

ADA Rules & Guidelines



The Americans with Disabilities Act is a Federal civil rights law that prohibits the exclusion of people with disabilities from everyday activities, such as enjoying a meal at a restaurant.

Establishment Requirements

- 5% of all tables (dining, banquet and bar), or at least 1 (if less than 20 tables), must be wheelchair accessible.
NOTE: If you have a bar or outdoor area in your restaurant, it must be counted separately, in the same way.
- If it is not readily achievable to provide the minimal number of accessible tables in all areas where fixed tables are provided, then services must be provided in another accessible location.
NOTE: Alternative locations must be available for all customers and not just people with disabilities. It is illegal to segregate people with disabilities in one area by designating it as an accessible area to be used only by people with disabilities.

ADA complaint tables must meet the following criteria:

- A surface height of no less than 28" and no more than 34" above the floor.
- A minimum knee clearance of 27" (preferred knee clearance is 29" to accommodate larger electric wheelchairs) between the floor and the underside of the table.
- A clear floor area of 30" x 48" is provided at each accessible seating location.
- Knee clearance extends at least 19" under the table.

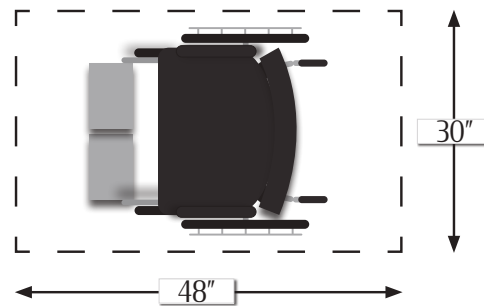
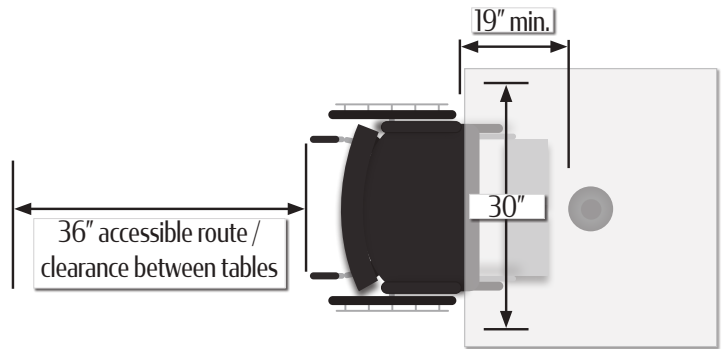
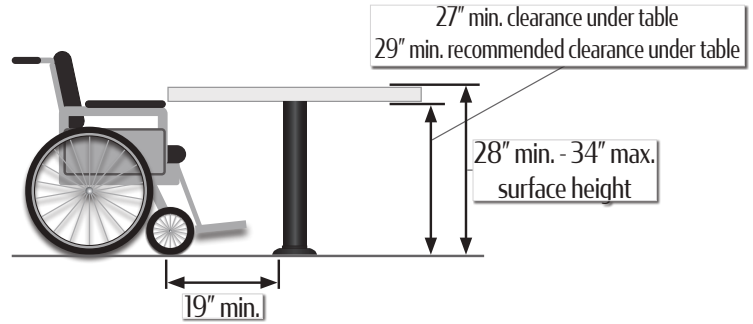

Oak Street Manufacturing has a variety of high-quality table base options to ensure your ADA compliance. **Bolt down table bases, cantilever wall mount table bases and T-bases** are the best options. These table bases offer a small footprint and allow you to meet ADA compliance without using excessively large table tops.

Bolt down table bases work well when you don't want to have a table against a wall and want the flexibility to switch between using chairs or making space for wheelchair accessibility.

Bolt down table bases have a small plate welded to the bottom of the tube, which is anchored to the floor and covered with a small dust cover. Bolt down bases have a footprint of approximately 8" - 11" in diameter.

NOTE: Bolt down bases shouldn't be spaced more than 36" apart.

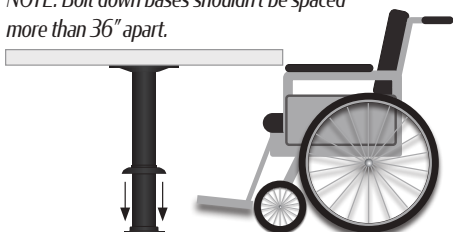

Cantilever wall mount table bases are a great option because they use little to no floor space (depending on the size).

Our 21" Cantilever wall mount table base (Part No.: CANTILEVER-21) accommodates table sizes up to 30".

Our 27.5" Cantilever wall mount table base* (Part No.: CANTILEVER-27.5) accommodates table sizes 30" to 48" without the use of a pin leg or 48"+, but requires installing a pin leg (SSB-PIN).

* - Requires special wall construction.

T-Bases use little space and are simple to install. Our T-Bases are constructed of stamped steel for unparalleled strength and stability.

IMPORTANT: Ensure your table size can accommodate a minimum floor space of 30" between the two T-Bases to maintain ADA compliance.

ADA compliant 5" x 22" T-Bases available with 3" ADA standard height tube (Part No.: B522-ADA).

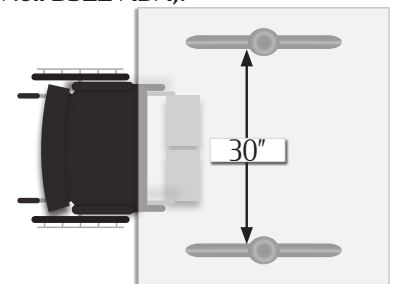

Laminate Care Instructions

CLEANING TIPS

Please see notes of caution below before attempting cleaning

1. To clean the laminate table top surface, use a damp cloth or sponge & a mild soap or detergent. Rinse thoroughly with warm water & wipe dry
2. Difficult stains, such as coffee or tea can be removed using a mild household cleaner/detergent & a soft bristled brush, repeating as necessary.
3. If a stain persists, use a paste of baking soda & water - apply with a soft bristled brush. Light scrubbing for 10 to 20 strokes should remove most stains. Although baking soda is a low abrasive, excessive scrubbing or exerting too much force could damage the decorative surface, especially if it has a gloss finish.
4. Stubborn stains that resist any of the above cleaning methods may require the use of undiluted household bleach or nail polish remover. Apply the bleach or nail polish remover to the stain & let stand no longer than 2 minutes. Rinse thoroughly with warm water & wipe dry. This step may be repeated if the stain appears to be going away & the color of the laminate has not been affected. WARNING: Prolonged exposure of the laminate surface to bleach will cause discoloration.
5. Hot pans & heat-producing appliances (such as electric skillets), when set directly upon countertops, can mar the product's beauty. Always use a heat shield, hot pad or trivet.

RECOMMENDED CLEANERS

- Windex®
- Glass Plus®
- Fantastik®
- Mr. Clean®
- Formula 409®
- Isopropyl Alcohol (Isopropanol)

DAMAGING CLEANERS

Cleaners that can cause damage to the laminate surface include, but are not limited to:

- Hydrochloric Acid
- Muriatic Acid
- Hydrogen Chloride
- Sulfuric Acid
- Oleic Acid
- Oil of Vitriol
- Oleum
- Hydrofluoric Acid
- Rust Remover
- Phosphoric Acid
- Sodium Hydroxide
- Caustic Soda
- Caustic Lye
- Soda Lye
- Pumice (abrasive)

NOTES OF CAUTION

1. Prolonged exposure of the laminate surface to acetone or bleach will cause discoloration. Always rinse laminate surface after cleaning. Failure to rinse after cleaning can cause damage, even if only a small amount of cleaning solution remains on the surface. A dry residue may be invisible, however moisture from cups or drinks can reactivate it and result in permanently etched scars or stains over time.
2. Acidic or abrasive cleaners can damage laminate surfaces – do not use them.
3. Drain cleaners containing lye will permanently damage the laminate surface. If you spill drain cleaner, wipe it up immediately and rinse several times with water.
4. Hair, textile and food dyes can cause permanent stains. If dye is spilled, wipe up immediately with dish washing detergent or an all-purpose cleaner.
5. Never place pots or dishes directly from the oven or burner on an unprotected laminate surface; such extreme heat can cause cracking or blistering.
6. Do not work with oven cleaners on an unprotected laminate top. Wipe spills away promptly and rinse several times with water.
7. Rust removers contain harsh chemicals which will quickly cause permanent damage. If a spill occurs, wipe off all residue immediately, wash thoroughly with soapy water and rinse several times.
8. Steel wool and other abrasive pads will damage the laminate surface. Do not use them for cleaning and do not store steel wool pads on your laminate; the metal can rust and leave stains.
9. Toilet bowl cleaners contain harsh chemicals that can cause permanent damage. If spills occur, wipe up immediately, wash the surface with soapy water and rinse several times.
10. Remember, sharp objects can damage the surface of any laminate: marring its beauty and lowering wear and stain resistance. Although high-pressure laminates are somewhat resistant to scratching, the surface can be damaged even under normal use. Laminate may need occasional dusting depending on where it is used. To keep the surface beautiful, use an oil free furniture spray. Remember to clean the spray off several times a year to prevent build up. Furniture polish may also help hide fine scratching in the surface.

Vinyl/Upholstery Care Instructions

MAINTENANCE / GENERAL RECOMMENDATIONS

Clean and maintain your furniture regularly. Cleaning frequency depends on use. We recommend using a professional furniture cleaning service.

Always test cleaning solutions and methods in an inconspicuous area of the furniture before proceeding. Treat spills and stains promptly. The longer the stain remains, the more difficult it will be to remove. Clean spots or stains from the edge of the stain working toward the center.

For regular cleaning and maintenance, remove excess soil with a damp, non-abrasive cloth. Use a solution of mild liquid soap and water. Rinse with clean water and dry.

STAIN TREATMENT / DISINFECTION

For more difficult stains or to disinfect, use a mixture of no more than 10% bleach and 90% water. **Always** rinse with clean water and dry. **Never** use full strength bleach to clean this material or any other coated fabric.

If stain persists, allow the diluted bleach solution to puddle on the affected area or apply with a clean, soaked cloth for approximately 30 minutes. Rinse with water-dampened cloth to remove any remaining bleach residue.

We do not recommend the use of hard surface cleaners; however, the following cleaners / disinfectants have been tested for use on this material, diluted per manufacturer's instructions: CaviWipes™, Virex® II 256, Virox® 5.

If these cleaners / disinfectants are used, the material **must** be rinsed with clean water and dried with a clean cloth following application. Failure to rinse thoroughly with clean water and to pat dry may lead to cleaner buildup and cause surface deterioration (cracking, blisters, peeling, discoloration, etc.).

Do **not** use cleaners marked "for hard non-porous surfaces only" unless indicated above. Such use may cause surface deterioration (cracking, blisters, peeling, discoloration, etc.).

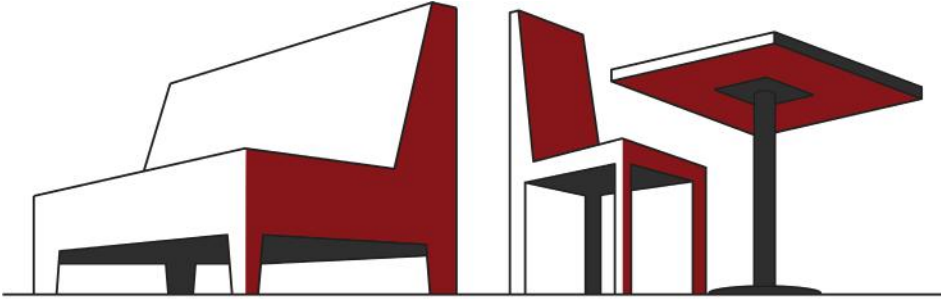

MADE TO ORDER **PRODUCT GUIDE**

OAKSTREETMFG.COM

(877) 465-4344



@OAKSTREETMFG



OSM0424