



NEVER STOP *dreaming*

SPRING / SUMMER 2024

LEGAMI
MILANO







The mark of responsible forestry

Products bearing the FSC® logo are supplied as certified



Index

1	OUR POSITIVE IMPACT	PAGE 4
2	BIKEAHOLIC Ride safe Bike accessories	PAGE 13 page 14 page 16
3	BODY & SOUL Have fun & take it easy Relax & take it easy Enjoy & take it easy	PAGE 25 page 26 page 28 page 30
4	CUTIE BEAUTY Beauty accessories Face & body	PAGE 33 page 34 page 36
5	EXTRAORDINARY STATIONERY Writing tools Writing accessories Bags, cases and organisers Desk accessories Paper world Bookmarks Notebooks & journals	PAGE 53 page 54 page 84 page 97 page 98 page 110 page 115 page 119
6	HOME SWEET HOME Eat & drink Decor Home accessories	PAGE 147 page 148 page 169 page 189
7	LET'S CELEBRATE Greetings and gift wrap Party accessories	PAGE 195 page 196 page 219
8	LOL Anti-stress Fun	PAGE 229 page 230 page 232
9	ON THE GO Beverage Bags & Co Food	PAGE 245 page 246 page 250 page 251
10	PARTNERS IN STYLE Bags, cases and organisers Style accessories	PAGE 255 page 256 page 267
11	SOS Reading accessories Save the day Stay safe Smoking accessories	PAGE 277 page 278 page 282 page 292 page 294
12	STAR TECH Phone accessories Tablet+laptop+pc accessories Audio	PAGE 295 page 296 page 315 page 326
13	TO TRAVEL IS TO LIVE Travel accessories Bags, cases and organisers	PAGE 333 page 334 page 342
14	VINTAGE MEMORIES Learn & explore Vintage objects Games	PAGE 349 page 350 page 352 page 354
15	WONDERLAND Decor Family fun Growing up	PAGE 371 page 372 page 376 page 380
16	PRE-ASSORTED DISPLAYS	PAGE 382
17	DISPLAYS ON DEMAND	PAGE 385
18	PRE-ASSORTED PACKS	PAGE 391
19	CONTACTS	PAGE 395



WE ARE A BENEFIT CORPORATION

We have adopted a virtuous business model to strike a balance between profit and sustainability

“In 2023, we reached a new target: we became a **Benefit Corporation**, an innovative way of doing business **centred not only around profit, but also objectives linked to protecting environment and promoting sustainability.**

We are proud to be **one of the first companies in our sector** to have obtained this denomination. For us, it represents yet another step towards creating shared value in a responsible way”.

Alberto Fassi
CEO, Founder & Dreamer



Learn more about how
we became a Benefit
Corporation





OUR FIRST SUSTAINABILITY REPORT

Our commitment to a positive impact on the environment and people

In 2023, in advance of European deadlines, we presented **our first Sustainability Report**, a transparent and complete report on actions taken and future projects, with the aim of improving our ESG impact:

Environmental

- Carbon Footprint
- Life Cycle Assessments
- Eco-friendly packaging
- Product recycling

Social

- Employees' development and well-being
- Sustainable supply chain
- Customer health and safety
- Projects in schools for the most vulnerable pupils

Governance

- Customer satisfaction
 - Code of Ethics to be promoted within the company
-

Learn more about our
Sustainability Report



CARBON NEUTRAL SINCE 2021



We have zeroed our CO₂ emissions for the third year in a row

Every year, together with Rete Clima, **we calculate the annual** greenhouse gas emissions generated by all our operations.

This year, we zeroed our climate impact thanks to emissions reduction measures and 4 **offsetting projects**:

- Over 38,000 tonnes of CO₂ reduced/year thanks to a plant generating **wind energy in India**;
- Around 900,000 tonnes of CO₂ avoided/year with a plant for generating **solar energy in India**;
- Over 300,000 tonnes of CO₂ reduced/year with photovoltaic systems generating **solar energy in China**;
- 7.5 million tonnes of CO₂ reduced/year with a **protection and conservation programme** for 150,000 hectares of forest in Indonesia.

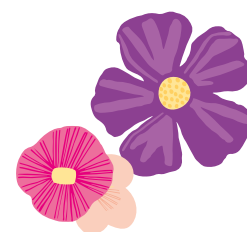

LEGAMI DREAMLAND PROTECTED NATURE RESERVE

Our reserve to protect nature and improve air quality



Three hectares with 2,600 plants and shrubs, 40 native tree species and 250 m² of wetland, with the goal of **tackling the loss of biodiversity and urban natural capital, reducing global warming and helping improve air quality.** A one-of-a-kind initiative, Dreamland is **an area open to flora and fauna that will play an active role in building a sustainable future.** The geographical area where Legami is based has borne the brunt of outdated, self-destructive development and land use decisions, and **we want to change this.**

The Dreamland project has allowed us to go beyond zeroing all our corporate emissions, making us a **Climate Plus** company. We are creating an environmental and social “plus” for the entire country.



CLIMATE PLUS



WE'RE MAKING A SUSTAINABLE IMPACT ON THE PLANET

We work with our customers every day towards a positive impact on the environment

To meet our energy needs we have equipped our headquarters with **solar panels**, and we only purchase **certified green energy** derived from renewable sources.

We guarantee the **traceability of the paper and wood** used along the entire production chain of our products with **FSC® certified paper**.

We have developed guidelines for **boutiques** with a **low environmental impact**. We have replaced all the shopping bags in our stores with **compostable bags** or bags made with **materials derived from sugar cane**, like Green-PE, and our receipts are made from **recyclable paper**.

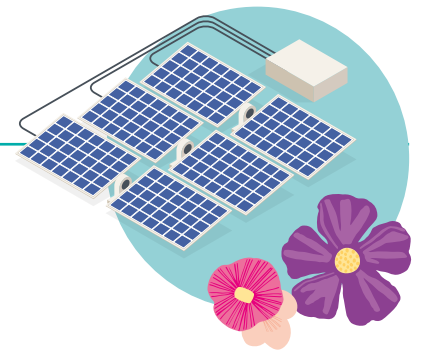

THE MARK OF RESPONSIBLE FORESTRY

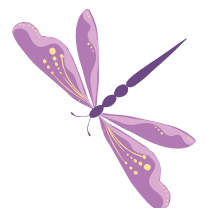

OUR COMMITMENT TO THE WELL-BEING OF PEOPLE

We are committed to our communities and projects close to our hearts

We have mapped the suppliers responsible for **90%** of our turnover, and we carry out regular checks so that we only collaborate with those who respect international ethical and social principles.

We have supported **CESVI** and the House of Smiles Programme for over 15 years. The non-profit offers safe spaces for children in rundown suburbs in Italy and across the world.

We support our community with local social projects: we are a **Gold Sponsor of the Serie A1 Volley Bergamo women's volleyball team** and we support **Teatro Donizetti**, one of our city's historic institutions.



© CESVI/Gianluigi Guercia





Legami Universe

A WORLD FOR EVERY OCCASION,
WAITING TO BE DISCOVERED

Our worlds are populated by imaginative, colourful, cheerful and fun objects with one goal: stimulate and make people feel good and experience positive thoughts in their everyday lives.

New and original products designed to warm the heart, make people smile, and provide a few minutes of happiness, all at an affordable cost. These products bring joy to gift givers and gift getters.



**DISCOVER
WHAT'S NEW IN 2024!**



BIKEAHOLIC *Ride in Style*

Make your bicycle special and unique

BIKE LOCK

Ø 1.4 cm, L 75 cm

LOCK WITH NUMBER COMBINATION

- Customisable 4-number combination
- Material: ABS, zinc, polyester exterior, PVC, metal interior

LUCCHETTO CON COMBINAZIONE NUMERICA

- Combinazione a 4 numeri personalizzabile
- Materiale: ABS, zinco, esterno in poliestere, PVC, interno in metallo

CADENAS À COMBINAISON NUMÉRIQUE

- Combinaison à 4 chiffres personnalisable
- Matériau : ABS, zinc, extérieur en polyester, PVC, intérieur en métal

CANDADO CON COMBINACIÓN NUMÉRICA

- Combinación de 4 números personalizable
- Material: ABS, cinc, exterior de poliéster, PVC, interior de metal

FAHRRAD-ZAHLENSCHLOSS

- Frei wählbare Kombination aus 4 Ziffern
- Material: ABS, Zink, außen Polyester, PVC, innen Metall

PACKAGING

- carded
- L 14 x H 21 x W 3.5 cm
- **SOLD X 4**



FLORA
BIL0002



8 054117 627928



FLASH
BIL0003



8 054117 627935



DAISY
BIL0004



8 052694 010232

13-IN-1 BIKE MULTI TOOL

L 8.8 x H 2.5 x W 4.5 cm

BIKE MULTI TOOL

- 13 tools in 1 to make repairs or adjustments during bike rides
- Material: beechwood and metal

ATTREZZO MULTIFUNZIONE PER BICICLETTA

- 13 attrezzi in 1 per effettuare riparazioni o regolazioni durante le uscite in bici
- Materiale: legno di faggio e metallo

OUTIL MULTIFUNCTION POUR VÉLO

- 13 outils en 1 pour effectuer des réparations ou des réglages pendant les sorties vélo
- Matériau : bois de hêtre et métal

HERRAMIENTA MULTIFUNCIÓN PARA BICICLETA

- 13 herramientas en 1 para realizar reparaciones o ajustes durante las salidas en bici
- Material: madera de haya y metal

FAHRRAD-MULTIFUNKTIONSWERKZEUG

- 13 Werkzeuge in 1, um beim Fahrradfahren Reparaturen oder Einstellungen vorzunehmen
- Material: Buchenholz und Metall

PACKAGING

carded
L 9.4 x H 17.4 x W 2.7 cm
SOLD X 4

BMT0001

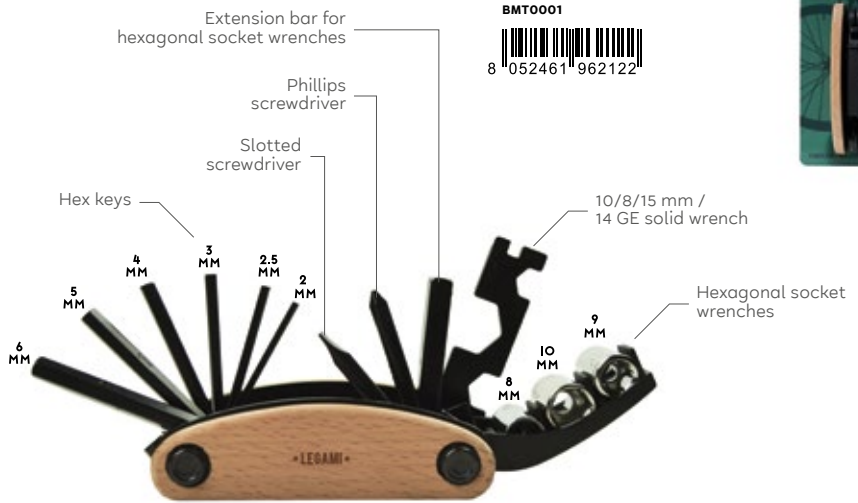

BIKE REPAIR KIT

BICYCLE REPAIR KIT

- The kit contains: 2 metal levers, 6 assorted patches, 1 x 10 cc tube of rubber cement, 1 scraper, 1 wax crayon, 1 piece of chalk

KIT RIPARAZIONE PER BICICLETTA

- Il kit contiene: 2 leve in metallo, 6 pezze assortite, 1 tubetto mastiche 10 cc, 1 raschietto, 1 pastello a cera, 1 gessetto

KIT DE RÉPARATION POUR VÉLO

- Le kit contient : 2 démonte-pneus en métal, 6 rustines assorties, 1 tube de colle de 10 cc, 1 grattoir, 1 pastel à la cire, 1 craie

KIT REPARACIÓN DE BICICLETA

- El kit contiene: 2 palancas de metal, 6 parches variados, 1 tubo de masilla de 10 cc, 1 raspador, 1 lápiz de cera, 1 tiza

FAHRRADREPARATUR-SET

- Das Set enthält: 2 Metallhebel, 6 nach Größen sortierte Flicker, 1 Tube Kitt 10 cc, 1 Schaber, 1 Wachsstift, 1 Kreide

PACKAGING

tin box
L 12.7 x H 2.2 x W 4.2 cm

DISPLAY

material: cardboard
L 13.5 x H 15 x W 18 cm
12 PCS

BRKKIT1



BIKE PUMP

Ø 3 cm, L 30 cm

BICYCLE PUMP

- Material: plastic and metal

POMPA PER BICICLETTA

- Materiale: plastica e metallo

POMPE À VÉLO

- Matériau : plastique et métal

BOMBA PARA BICICLETA

- Material: plástico y metal

FAHRRADPUMPE

- Material: Kunststoff und Metall

* While stock lasts

PACKAGING

cardboard box
L 32 x H 3.6 x W 3.6 cm

DISPLAY

material: cardboard
L 33.5 x H 18 x W 12 cm
9 PCS

PUMKIT1



FRONT BIKE LIGHT

L 2 x H 7 x W 2.2 cm
(without silicone attachment)

FRONT BIKE LIGHT

- Suitable for all sizes of handlebars
- 4 light modes: on, fast flash, flashing and slow flash
- IP44: splash and rain resistant; dust resistant
- Material: ABS, silicone

LUCE ANTERIORE PER BICI

- Adatta a tutte le misure di manubrio
- 4 modalità di luce: fissa, pulsante lenta, lampeggiante, alternata rapida
- IP44: resistente agli schizzi d'acqua e alla pioggia; resistente alla polvere
- Materiale: ABS, silicone

PHARE AVANT POUR VÉLO

- Adaptée à toutes les tailles de guidon
- 4 modes d'éclairage : fixe, clignotement lent, clignotement, clignotement rapide
- IP44 : protégée contre la pluie et les éclaboussures d'eau ; protégée contre la poussière
- Matériau : ABS, silicone

LUZ DELANTERA PARA BICI

- Adecuada para cualquier medida del manillar
- 4 modalidades de luz: fija, intermitente lenta, intermitente, intermitente rápida
- IP44: resistente a las salpicaduras de agua y a la lluvia; resistente al polvo
- Material: ABS, silicona

FAHRRAD-FRONTLICHT

- Geeignet für alle Lenkergrößen
- 4 Licht-Modi: stetig leuchtend, langsames Blinklicht, Blinklicht, schnelles Blinklicht
- IP44: spritzwasserdicht und regenfest; staubgeschützt
- Material: ABS, Silikon

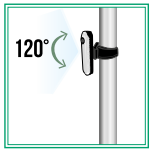

Angle of visibility



Adjustable tilt

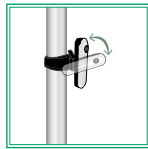

Use both horizontally and vertically

PACKAGING

window box
L 7 x H 8 x W 4.3 cm
SOLD X 6

BLF0001



8 054320 561170



USB rechargeable.
USB charging
cable included



Lumens



Up to 12 hours



Water resistant

**REAR BIKE LIGHT**

L 2 x H 7 x W 2.2 cm
(without silicone attachment)

REAR BIKE LIGHT

- Suitable for all sizes of handlebars
- 4 light modes: on, fast flash, flashing and slow flash
- IP44: splash and rain resistant; dust resistant
- Material: ABS, silicone

LUCE POSTERIORE PER BICI

- Adatta a tutte le misure di manubrio
- 4 modalità di luce: fissa, pulsante lenta, lampeggiante, alternata rapida
- IP44: resistente agli schizzi d'acqua e alla pioggia; resistente alla polvere
- Materiale: ABS, silicone

LAMPE ARRIÈRE POUR VÉLO

- Adaptée à toutes les tailles de guidon
- 4 modes d'éclairage : fixe, clignotement lent, clignotement, clignotement rapide
- IP44 : protégée contre la pluie et les éclaboussures d'eau ; protégée contre la poussière
- Matériau : ABS, silicone

LUZ TRASERA PARA BICI

- Adecuada para cualquier medida del manillar
- 4 modalidades de luz: fija, intermitente lenta, intermitente, intermitente rápida
- IP44: resistente a las salpicaduras de agua y a la lluvia; resistente al polvo
- Material: ABS, silicona

FAHRRAD-RÜCKLICHT

- Geeignet für alle Lenkergrößen
- 4 Licht-Modi: stetig leuchtend, langsames Blinklicht, Blinklicht, schnelles Blinklicht
- IP44: spritzwasserdicht und regenfest; staubgeschützt
- Material: ABS, Silikon

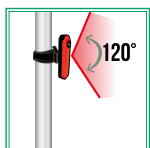

Angle of visibility

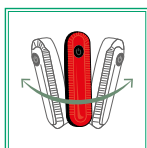

Adjustable tilt

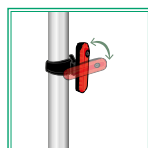

Use both horizontally and vertically

PACKAGING

window box
L 7 x H 8 x W 4.3 cm
SOLD X 6

BLR0001



8 054320 561163



USB rechargeable.
USB charging
cable included



Lumens



Up to 12 hours



Water resistant



BIKE LIGHT SET

L 3.3 x H 1.2 x W 4 cm
(without silicone attachment)

SET OF 2 LED LIGHTS FOR BIKES

- Suitable for all sizes of handlebars
- 3 light modes: on, fast flash and slow flash
- Material: silicone

SET DI 2 LUCI LED PER BICI

- Adatto a tutte le misure di manubrio
- 3 modalità di luce: fissa, pulsante veloce e pulsante lento
- Materiale: silicone

SET DE 2 LAMPES LED POUR VÉLO

- Adapté à toutes les tailles de guidon
- 3 modes d'éclairage : fixe, clignotement rapide et clignotement lent
- Matériau : silicone

SET DE 2 LUCES LED PARA LA BICI

- Adecuado para cualquier medida del manillar
- 3 modalidades de luz: fija, intermitente rápida e intermitente lenta
- Material: silicona

SET MIT 2 LED-FAHRRADLEUCHTEN

- Geeignet für alle Lenkergrößen
- 3 Licht-Modi: stetig leuchtend, schnelles und langsames Blinklicht
- Material: Silikon

PACKAGING

PET box
L 8.2 x H 4.8 x W 6.5 cm



DISPLAY

material: cardboard
L 17.5 x H 20 x W 20 cm

12 PCS

SBLKIT1



8 051128 751420



4 x CR2032 batteries (included)



Red rear light

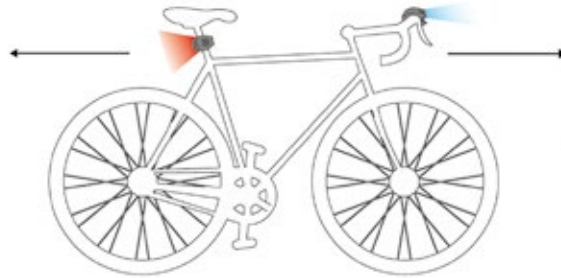

White front light

BIKE PHONE HOLDER

L 7.5 x H 13.5 cm

ADJUSTABLE PHONE HOLDER FOR BIKE

- Material: silicone

PORTA CELLULARE PER BICICLETTA REGOLABILE

- Materiale: silicone

SUPPORT RÉGLABLE POUR TÉLÉPHONE PORTABLE POUR VÉLO

- Matériau : silicone

SOPORTE DE TELÉFONO MÓVIL REGULABLE PARA BICICLETA

- Material: silicona

VERSTELLBARE FAHRRAD-HANDYHALTERUNG

- Material: Silikon

PACKAGING

clamshell
L 11 x H 18 x W 5.5 cm

SOLD X 4

BIKE0001



8 052783 617090

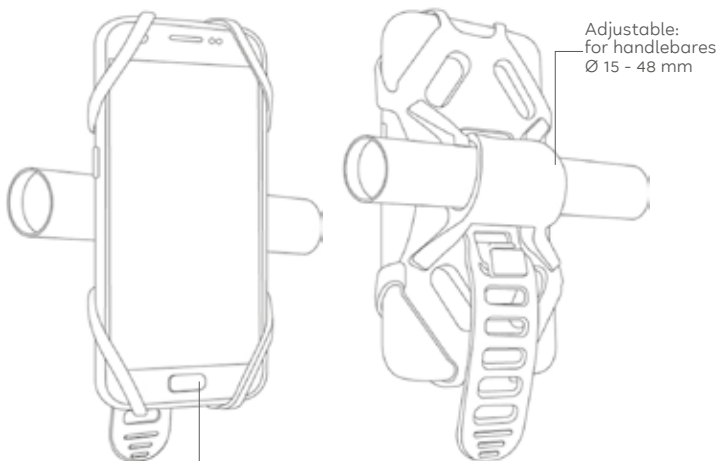

Adjustable:
for handlebars
Ø 15 - 48 mm

Adapts to most smartphones
Screen size: MIN - MAX: 4.7"-6"



BIKE HORN

L 17.5 cm

BICYCLE HORN

- Material: metal, silicone

CAMPANELLO A TROMBETTA PER BICICLETTA

- Materiale: metallo, silicone

KLAXON POUR VÉLO EN FORME DE TROMPETTE

- Matériau : métal, silicone

BOCINA PARA BICICLETA

- Material: metal, silicona

FAHRRADHUPE

- Material: Metall, Silikon

PACKAGING

window box
L 17.5 x H 10.7 x W 6.5 cm
SOLD X 2



SILVER
BIHA0001



8 056304 485274



ICE CREAM
BIHO0011



8 056304 485229



TRAVEL
BIHO0013



8 056304 485243



SPACE
BIHO0016



8 051739 307689



PANDA
BIHO0017



8 051739 307696



UNICORN
BIHO0020



8 051739 307726



DAISY
BIHO0021



8 052694 010201



DINO
BIHO0022



8 052694 010218



SKULL
BIHO0023



8 052694 010225

BIKE BELL

Ø 5.5 cm, H 3 cm

BICYCLE BELL
• Material: metal

CAMPANELLO PER BICICLETTA
• Materiale: metallo

* While stock lasts

SONNETTE POUR VÉLO
• Matériau : métal

TIMBRE PARA BICICLETA
• Material: metal

FAHRRADKLINGEL
• Material: Metall

PACKAGING
carded
L 8.5 x H 11 x W 6 cm
SOLD X 2



LADYBUG
DR10011



SKULL
DR10017



TRAVEL
DR10027 *



SPACE
DR10029



PANDA
DR10030 *



BEE
DR10031 *



UNICORN
DR10033



DAISY
DR10034



TIGER
DR10035



RIDE WITH STYLE

NEW

L 12 x H 16 cm

REFLECTIVE BICYCLE STICKERS

- 2 sheets x 20 3M stickers
- Easy to apply, resistant to sunlight and water
- Removable
- Material: PVC, 3M adhesive

STICKERS RIFLETTENTI PER BICICLETTA

- 2 fogli x 20 stickers 3M
- Facili da applicare, resistenti al sole e all'acqua
- Rimovibili
- Materiale: PVC, adesivo 3M

STICKERS RÉFLÉCHISSANTS POUR VÉLO

- 2 feuilles x 20 stickers 3M
- Faciles à appliquer, résistants au soleil et à l'eau
- Amovibles
- Matériau : PVC, adhésif 3M

PEGATINAS REFLECTANTES PARA BICICLETA

- 2 folios x 20 pegatinas 3M
- Fáciles de colocar y quitar, resistentes al sol y al agua
- Desprendibles
- Material: PVC, adhesivo 3M

REFLEKTIERENDE FAHRRADAUFKLEBER

- 2 Blätter mit 20 3M-Stickers
- Leicht aufzukleben, sonnen- und wasserbeständig
- Abziehbar
- Material: PVC, 3M-Klebstoff



PACKAGING

cardboard envelope
L 13,5 x H 19 x W 0,3 cm

SOLD X 6

UNICORN

BST0001



8 052694 010065



PACKAGING

cardboard envelope
L 13,5 x H 19 x W 0,3 cm

SOLD X 6

SPACE

BST0002



8 052694 010072

PIMP YOUR BIKE!

L MAX 7 x H MAX 5 x W 0.5 cm

SET OF 30 BICYCLE SPOKE DECORATIONS

- Easy to clip on and remove
- The standard clip size is suitable for most bicycle spokes
- Material: PET

SET DI 30 DECORAZIONI PER I RAGGI DELLA BICICLETTA

- Facili da agganciare e da rimuovere
- Con clip di dimensione standard: si adatta alla maggior parte dei raggi delle biciclette
- Materiale: PET

SET DE 30 DÉCORATIONS POUR RAYONS DE VÉLO

- Faciles à fixer et à enlever
- Avec clip de dimension standard : adaptés à la plupart des rayons de vélo
- Matériau : PET

SET DE 30 ADORNOS PARA LOS RADIOS DE LA BICICLETA

- Fáciles de enganchar y de quitar
- Con clip de tamaño estándar: se adapta a la mayor parte de los radios de las bicicletas
- Material: PET

SET MIT 30 DEKORATIONEN FÜR DIE FAHRRADESPEICHEN

- Einfach zu befestigen und wieder zu entfernen
- Mit Clips in Standardgröße: passen an fast alle Fahrradspeichen
- Material: PET



PACKAGING

carded
L 13 x H 20 x W 3.2 cm

SOLD X 4

UNICORN
WSD0001



8 053610 784404



PACKAGING

carded
L 13 x H 20 x W 3.2 cm

SOLD X 4

SPACE
WSD0002



8 053610 784411

RIDE & SHINE



L 5 x H 5 x W 1.6 cm (BKS0001)
L 5 x H 7.5 x W 1.6 cm (BKS0002)

SET OF 2 BICYCLE SPOKE LIGHTS

- Easy to clip on and remove
- The standard clip size is suitable for most bicycle spokes
- Material: polycarbonate

SET DI 2 LUCI PER I RAGGI DELLA BICICLETTA

- Facili da agganciare e da rimuovere
- Con clip di dimensione standard: si adatta alla maggior parte dei raggi delle biciclette
- Materiale: policarbonato

SET DE 2 LAMPES POUR RAYONS DE VÉLO

- Faciles à fixer et à enlever
- Avec clip de dimension standard : adapté à la plupart des rayons de vélo
- Matériau : polycarbonate

SET DE 2 LUCES PARA LOS RADIOS DE LA BICICLETA

- Fáciles de enganchar y de quitar
- Con clip de tamaño estándar: se adapta a la mayor parte de los radios de las bicicletas
- Material: policarbonato

UNIVERSAL

SET MIT 2 LICHTERN FÜR DIE FAHRRADSPEICHERN

- Einfach zu befestigen und wieder zu entfernen
- Mit Clips in Standardgröße: passen an fast alle Fahrradspeichen
- Material: Polycarbonat



2 x LR1130 batteries (included)

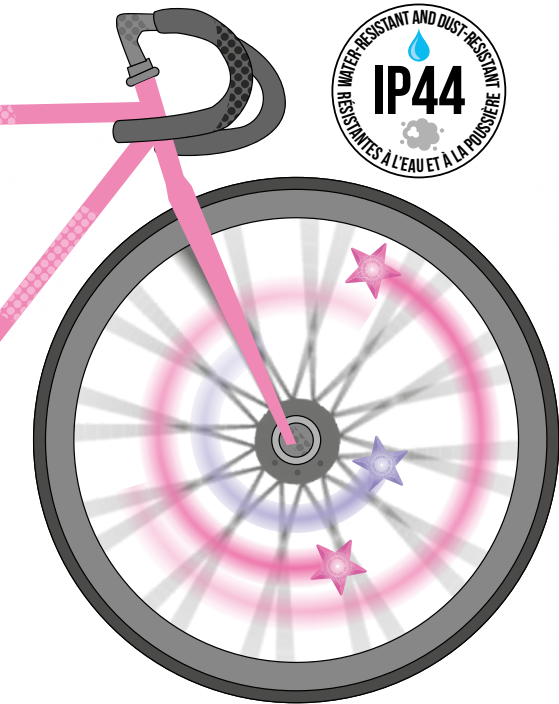

WHITE LIGHT



WHITE LIGHT



PACKAGING

carded
L 12.8 x H 15.6 x W 2 cm
SOLD X 6

UNICORN
BKS0001

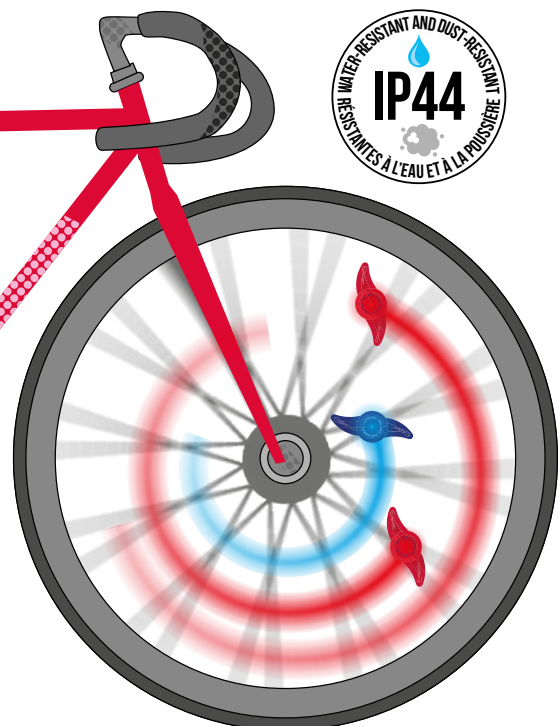

BLUE LIGHT



RED LIGHT



PACKAGING

carded
L 12.8 x H 15.6 x W 2 cm
SOLD X 6

SPACE
BKS0002



BIKE SEAT COVER

L 23 x H 26 cm

BIKE SEAT COVER

- Water repellent
- Elastic trim
- Universal fit
- Material: polyester

COPRISELLA PER BICI

- Idrorepellente
- Bordatura con elastico
- Vestibilità universale
- Materiale: poliester

COUVRE-SELLE DE VÉLO

- Hydrofuge
- Bord avec élastique
- Modèle universel
- Matériau : polyester

FUNDA PARA SILLÍN DE BICICLETA

- Hidrófuga
- Borde con elástico
- Ajuste universal
- Material: poliéster

SATTELÜBERZUG FÜR FAHRRÄDER

- Wasserabweisend
- Elastische Umrandung
- Universelle Passform
- Material: Polyester

PACKAGING

cardboard envelope
L 10,5 x H 15,5 x W 0,5 cm
SOLD X 4



TRAVEL
BSC0001



AFTER RAIN
BSC0002





BODY & SOUL *Take it Easy*

Restore your balance, replenish your well-being

LOVE YOURSELF

Ø 7.5 x H 28.5 cm

GOAL BOTTLE

- Lightweight and impact-resistant
- Hermetic seal
- Material: copolyester

BORRACCIA MOTIVAZIONALE

- Leggera e resistente agli urti
- Chiusura ermetica
- Materiale: copoliestere

GOURDE MOTIVATIONNELLE

- Légère et résistante aux chocs
- Fermeture hermétique
- Matériau : copolyester

CANTIMPLORA MOTIVACIONAL

- Ligera y resistente a los golpes
- Cierre hermético
- Material: copoliéster

MOTIVIERENDE TRINKFLASCHE

- Leicht und bruchfest
- Hermetischer Verschluss
- Material: Copolyester

SOLD X 4



Without lid and straw



SUNRISE VIBES

GBT0001



ENERGY BOOST

GBT0002



THE FIVE ELEMENTS

L 30 x H 5 cm

SET OF 5 FITNESS RESISTANCE BANDS

- 5 different levels of resistance: 4 kg, 7 kg, 9 kg, 12 kg, 15 kg
- Carry pouch included
- Material: TPE, polyester

SET DI 5 ELASTICI FITNESS

- 5 diverse resistenze: 4kg, 7kg, 9kg, 12kg, 15kg
- Custodia inclusa
- Materiale: TPE, poliester

SET DE 5 ÉLASTIQUES FITNESS

- 5 niveaux de résistance : 4 kg, 7 kg, 9 kg, 12 kg, 15 kg
- Sachet de rangement inclus
- Matériau : TPE, polyester

SET DE 5 ELÁSTICOS PARA FITNESS

- 5 resistencias distintas: 4 kg, 7 kg, 9 kg, 12 kg, 15 kg
- Bolsa incluida
- Material: TPE, poliéster

SET MIT 5 GYMNASTIKBÄNDERN

- 5 verschiedene Widerstandsniveaus: 4 kg, 7 kg, 9 kg, 12 kg, 15 kg
- Inklusive Hülle
- Material: TPE, Polyester

5 DIFFERENT RESISTANCE LEVELS

PACKAGING

cardboard box
L 9 x H 20 x W 3 cm

SOLD X 4

REB0001



Carry pouch included



PEACE OF MIND

L 9 x H 20 x W 9 cm

HEAD MASSAGER

- Contains 12 flexible metal arms
- Material: metal, PVC

MASSAGGIATORE PER LA TESTA

- 12 bracci in metallo flessibile
- Materiale: metallo, PVC

MASSEUR DE TÊTE

- 12 branches en métal flexible
- Matériau : métal, PVC

MASAJEADOR PARA LA CABEZA

- 12 brazos de metal flexible
- Material: metal, PVC

MASSAGEGERÄT FÜR DEN KOPF

- 12 flexible Metallarme
- Material: Metall, PVC

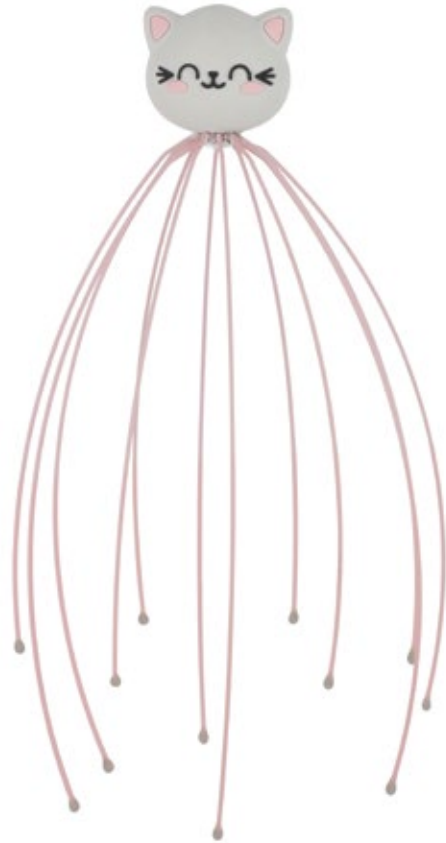

PACKAGING

cardboard box
L 6 x H 23 x W 6 cm

SOLD X 6

HEAD0002



HIMALAYAN SALT LAMP - MINI

Ø 7 cm, H 9.5 cm - 300/400 g

HIMALAYAN SALT LAMP

- Natural shape
- Light effect: colour therapy
- Material: Himalayan salt, plastic base

LAMPADA DI SALE DELL'HIMALAYA

- Forma naturale
- Effetto luminoso: cromoterapia
- Materiale: sale himalayano, base in plastica

LAMPE DE SEL DE L'HIMALAYA

- Forme naturelle
- Effet lumineux : chromothérapie
- Matériau : sel de l'Himalaya, base en plastique

LÁMPARA DE SAL DEL HIMALAYA

- Forma natural
- Efecto luminoso: cromoterapia
- Material: sal del Himalaya, base de plástico

HIMALAYA-SALZLAMPE

- Natürliche Form
- Lichteffect: Farbtherapie
- Material: Himalaya-Salz, Sockel aus Plastik

PACKAGING

cardboard box
L 8.5 x H 12 x W 8.5 cm

SOLD X 4

HSL0002

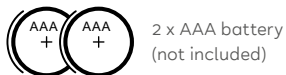

DIFFERENT CHROMOTHERAPY COLOURS
Possibility to choose between low or high mode



WARM CUDDLES

L MAX 29 x H MAX 26.5 x W 2 cm

HEAT PACK WITH LINSEED

- Removable cover with hook and loop closure
- Dual function: provides hot and cold relief
- Filler: 97% linseed, 3% dried lavender
- Cover material: 100% polyester; inner pack lining material: 100% cotton

CUSCINO TERMICO CON SEMI DI LINO

- Federa removibile con chiusura a strappo
- Doppia funzione: sollievo caldo e sollievo freddo
- Imbottitura: 97% semi di lino, 3% fiori di lavanda essiccati
- Materiale federa: 100% poliestere; materiale fodera cuscino interno: 100% cotone

BOUILLOTTE SÈCHE AUX GRAINES DE LIN

- Housse extérieure amovible, munie d'une fermeture à scratch
- Double fonction : apaisement chaud et froid
- Rembourrage : 97 % graines de lin, 3 % fleurs de lavande séchées
- Matériau de la housse extérieure : 100 % polyester; matériau de la housse intérieure de la bouillotte : 100 % coton

COJÍN TÉRMICO CON SEMILLAS DE LINO

- Funda extraíble con cierre de gancho y bucle
- Doble función: alivio con efecto caliente y frío
- Relleno: 97 % semillas de lino, 3 % flores secas de lavanda
- Material funda: 100 % poliéster; material forro cojín interno: 100 % algodón

THERMOKISSEN MIT LEINSAMEN

- Abnehmbarer Kissenbezug mit Klettverschluss
- Doppelfunktion: angenehm warm oder wohltuend kühl
- Füllung: 97 % Leinsamen, 3 % getrocknete Lavendelblüten
- Material Kissenbezug: 100 % Polyester; Material Innenfutter: 100 % Baumwolle

PACKAGING

window box
L MAX 31 x H MAX 31 x W MAX 3.5 cm
SOLD X 2



RAINBOW
WC0001



SLOTH
WC0002



PENGUIN
WC0003



AVOCADO
WC0004



HEART
WC0005



FITNESS TOWEL

L 45 x H 80 cm

FITNESS TOWEL

- Compact: takes up minimal space, light to carry
- Quick drying and ultra absorbent
- Zip pocket
- Elastic loop
- Material: 88% polyester, 12% polyamide

TELO FITNESS

- Compatto: minimo ingombro, leggero da trasportare
- Asciugatura rapida e ultra assorbente
- Con tasca zippata
- Con elastico
- Materiale: 88% poliestere, 12% poliammide

SERVIETTE DE FITNESS

- Compact : encombrement minimum, léger à transporter
- Séchage rapide et ultra absorbante
- Avec poche zippée
- Avec élastique
- Matériau : 88 % polyester, 12 % polyamide

TOALLA PARA FITNESS

- Compacta: ocupa el mínimo espacio y es ligera de transportar
- Secado rápido y ultraabsorbente
- Con bolsillo con cremallera
- Con elástico
- Material: 88 % poliéster, 12 % poliamida

FITNESSTUCH

- Kompakt: minimaler Platzbedarf, leicht zu transportieren
- Schnell trocknend und besonders saugfähig
- Mit Reißverschluss tasche
- Mit Gummiband
- Material: 88 % Polyester, 12 % Polyamid

PACKAGING

carded
L 20 x H 14,7 x W 4 cm
SOLD X 4



ZIP POCKET



TRAVEL
FTOW0001



STARS
FTOW0002



PANDA
FTOW0003

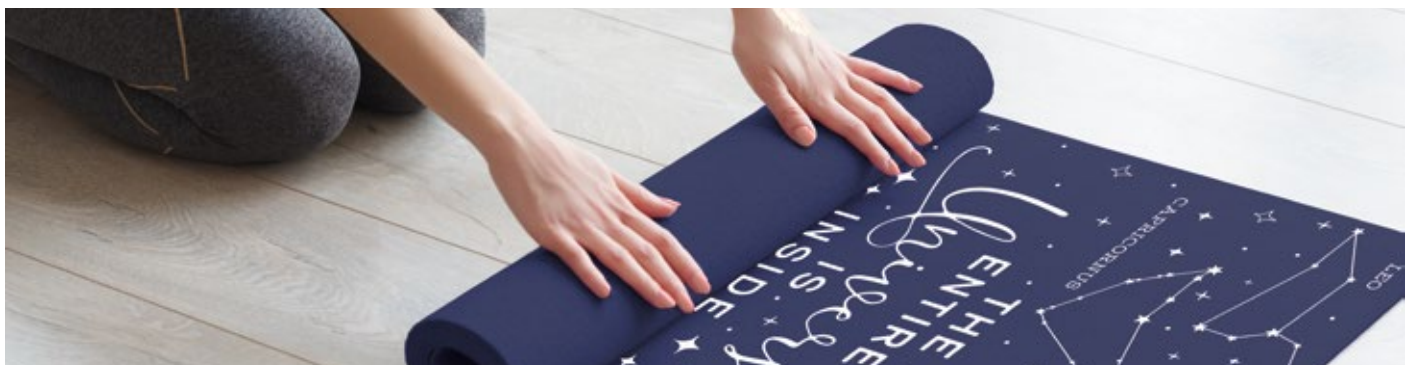

STRIKE A POSE

L 183 x H 61 x W 0,6 cm

FITNESS MAT

- Non-slip surface for better grip. 6 mm thick
- Easy to carry: strap included
- Material: PVC mat, polyester strap

TAPPETINO FITNESS

- Superficie antiscivolo per una maggiore presa. Spessore di 6 mm
- Facile da trasportare: tracolla inclusa
- Materiale: tappetino in PVC, tracolla in poliestere

TAPIS DE FITNESS

- Surface antidérapante pour une meilleure prise. Épaisseur de 6 mm
- Facile à transporter : bandoulière incluse
- Matériau : tapis en PVC, bandoulière en polyester

ESTERILLA PARA FITNESS

- Superficie antideslizante para obtener un mejor agarre. Espesor de 6 mm
- Fácil de transportar: correa incluida
- Material: esterilla de PVC, correa de poliéster

FITNESS-MATTE

- Rutschhemmende Oberfläche für guten Griff. 6 mm dick
- Einfach zu transportieren: Trageriemen inklusive
- Material: Matte aus PVC, Trageriemen aus Polyester

PACKAGING
belly band
L 43,5 x H 22 cm



DISPLAY
material: cardboard
L 28,5 x H 63 x W 28,5 cm
4 PCS

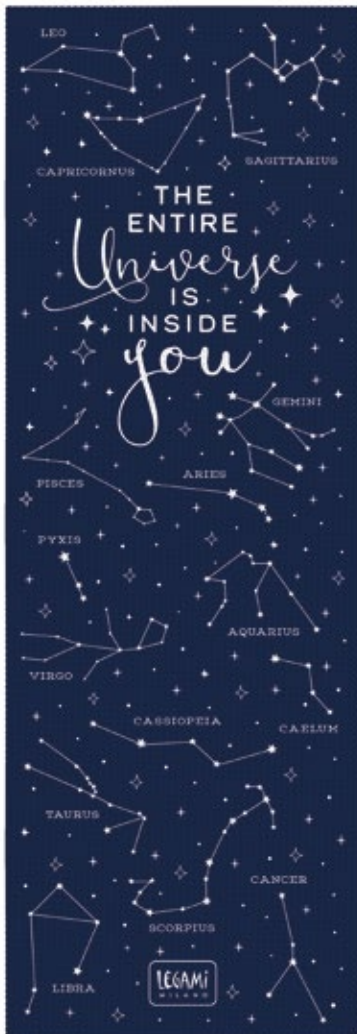

STARS
YGA0001



8 053610 781977



PANDA
YGA0002



8 053610 781984



RESERVED
YGA0003



8 053610 781991



CUTIE **BEAUTY** *Love Yourself*

Fill your beauty routine with cuteness

YOU LOOK PURRFECT!



Ø 17.5 x H 29.5 cm

MAKE-UP MIRROR WITH LIGHT

- 33 LED lights
- Dual power supply: 3 x AAA batteries (not included) and USB cable (included)
- ON/OFF/dimmer touch button
- Adjustable brightness and angle
- Storage tray at the base
- Material: glass, plastic

SPECCHIO DA TRUCCO CON LUCE

- 33 led
- Doppia alimentazione: 3x batterie AAA (non incluse) e cavo USB (incluso)
- Pulsante touch ON/OFF/dimmer
- Luminosità e inclinazione regolabili
- Base portaoggetti
- Materiale: vetro, plastica

MIROIR DE MAQUILLAGE LUMINEUX

- 33 LED
- Double alimentation : 3 piles AAA (non incluses) et câble USB (inclus)
- Bouton tactile ON/OFF/variableur
- Miroir inclinable, luminosité réglable
- Base porte-objets
- Matériau : verre, plastique

ESPEJO DE MAQUILLAJE CON LUZ

- 33 ledes
- Doble alimentación: 3x pilas AAA (no incluidas) y cable USB (incluido)
- Botón táctil ON/OFF/regulador
- Luminosidad e inclinación ajustables
- Base portaobjetos
- Material: vidrio, plástico

SCHMINKSPIEGEL MIT LICHT

- 33 LEDs
- Doppelte Stromversorgung: 3 Batterien Typ AAA (nicht inbegriffen) und USB-Kabel (inbegriffen)
- Berührungstaste ON/OFF/Dimmer
- Einstellbare Helligkeit und Neigung
- Sockel mit Ablageschale
- Material: Glas, Kunststoff

PACKAGING

cardboard box
L 20 x H 28.5 x
W 7.2 cm

SOLD X 4

DMR0001



Adjustable brightness

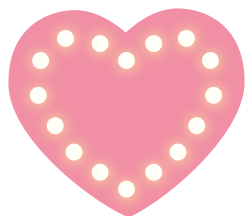

Cool white light



ON/OFF/
dimmer touch button

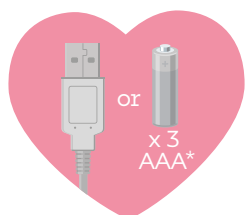

Dual power supply
*not included



HELLO BEAUTY

L 21 x H 19 x W 17 cm (handle included)

BEAUTY CASE

- Zip closure, inside pockets and elastic brush holder straps
- Material: polyester, PU

BEAUTY CASE

- Con chiusura a zip, tasche interne e fascette elastiche porta pennelli
- Materiale: poliestere, PU

TROUSSE DE MAQUILLAGE

- Avec fermeture éclair, poches internes et bandes élastiques porte-pinceaux
- Matériau : polyester, PU

NECESER

- Cierre con cremallera, bolsillos internos y bandas elásticas portapinceles
- Material: poliéster, PU

BEAUTYCASE

- Reißverschluss, Innentaschen und elastische Pinselhalter
- Material: Polyester, PU



PACKAGING

cardboard belly band
L 21 x H 21 x W 3 cm
SOLD X 3



STARS

BEB0003



FLOWERS

BEB0004



LIPS

BEB0005



MAKEUP QUEEN

L 18 x H 14 x W 10 cm

MAKEUP BAG

- With zip
- Material: metal, TPU

TROUSSE MAKEUP

- Con chiusura a zip
- Materiale: metallo, TPU

TROUSSE À MAQUILLAGE

- Avec fermeture éclair
- Matériau : métal, TPU

BOLSA PARA MAQUILLAJE

- Con cierre de cremallera
- Material: metal, TPU

SCHMINKTASCHE

- Mit Reißverschluss
- Material: Metall, TPU

SOLD X 3



STARS

BBT0001



FLOWERS

BBT0002



LIPS

BBT0003



BRUSH IT OFF!

L MAX 14 x H MAX 17 x W 1.5 cm

MAKE-UP BRUSH CLEANING PAD

- With suction cups on the back for a better grip on surfaces
- Different textures for cleaning different types of brushes
- Material: silicone

TAPPETINO PER LA PULIZIA DEI PENNELLI DA TRUCCO

- Con ventose sul retro per una maggiore aderenza alle superfici
- Diverse texture per pulire differenti tipologie di pennelli
- Materiale: silicone

TAPIS DE NETTOYAGE POUR PINCEAUX DE MAQUILLAGE

- Doté de ventouses à l'arrière pour une adhérence optimale aux surfaces
- Différentes textures pour nettoyer différents types de pinceaux
- Matériau : silicone

ALFOMBRILLA PARA LIMPIAR PINCELES DE MAQUILLAJE

- Con ventosas en la parte posterior para que se adhiera mejor a las superficies
- Diferentes texturas para limpiar distintos tipos de pinceles
- Material: silicona

REINIGUNGSPAD FÜR MAKE-UP-PINSEL

- Mit den Saugnäpfen an der Rückseite haftet das Pad auf glatten Flächen
- Verschiedene Texturen zum Reinigen verschiedenartiger Pinsel
- Material: Silikon

PACKAGING
cardboard box
L MAX 14.2 x H MAX 20
x W 1.7 cm
SOLD X 6



DEEP CLEANING

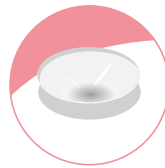

NON-SLIP SUCTION CUPS ON THE BACK



PANDA
PAD0001



8 052694 001698



DAISY
PAD0003



8 052694 002732



UNICORN
PAD0002



8 052694 001704

OH MY GLOW!

SET OF 4 MAKEUP BRUSHES

- The set contains: 1 powder brush, 1 foundation brush, 1 eyeshadow brush, 1 eyeliner brush
- Material: handle in ABS and aluminium, synthetic bristles

SET DI 4 PENNELLI PER IL TRUCCO

- Il set contiene: 1 pennello per polveri, 1 pennello per fondotinta, 1 pennello per ombretto, 1 pennello per eyeliner
- Materiale: manico in ABS e alluminio, setole in fibre sintetiche

SET DE 4 PINCEAUX DE MAQUILLAGE

- Le set contient : 1 pinceau poudre, 1 pinceau fond de teint, 1 pinceau fard à paupières, 1 pinceau eyeliner
- Matériau : manche en ABS et aluminium, poils en fibres synthétiques

SET DE 4 PINCELES DE MAQUILLAJE

- El set contiene: 1 pincel para polvo de maquillaje, 1 pincel para base de maquillaje, 1 pincel para sombra de ojos, 1 pincel para eyeliner
- Material: mango de ABS y aluminio, cerdas de fibra sintética

SET MIT 4 SCHMINKPINSELN

- Das Set enthält: 1 Pinsel für Pulver, 1 Pinsel für Foundation, 1 Pinsel für Lidschatten, 1 Pinsel für Eyeliner
- Material: Stiel aus ABS und Aluminium, Borsten aus Kunstfasern

* While stock lasts



EYES AND FACE



SUPER SOFT BRISTLES



CRUELTY FREE



VEGAN



TRAVEL SIZE



GOLD FOIL

PACKAGING
window box
L 11.5 x H 20.5 x W 2.5 cm

SOLD X 3

STARS

MUBS0001



8 054117 621667



HOLO PRINT

PACKAGING
window box
L 11.5 x H 20.5 x W 2.5 cm

SOLD X 3

FLOWERS

MUBS0002



8 054117 621674



POWDER BRUSH
Ø 1.4 cm, L 15 cm

FOUNDATION BRUSH
Ø 1.3 cm, L 14.5 cm

EYESHADOW BRUSH
Ø 0.6 cm, L 12.3 cm

EYELINER BRUSH
Ø 0.5, L 11.8 cm



PACKAGING
window box
L 11.5 x H 20.5 x W 2.5 cm

SOLD X 3

LIPS

MUBS0003 *



8 054117 621681



GOODBYE MAKEUP

L 12 x H MAX 22.5 x W 1 cm

MAKEUP REMOVER GLOVE

- In soft fabric, ideal for removing makeup
- Material: 100% polyester

GUANTO STRUCCANTE

- In morbido tessuto, ideale per rimuovere il trucco dal viso
- Materiale: 100% poliestere

GANT DÉMAQUILLANT

- En tissu doux, idéal pour retirer le maquillage du visage
- Matériau : 100 % polyester

GUANTE DESMAQUILLANTE

- De tejido suave, ideal para eliminar el maquillaje del rostro
- Material: 100 % poliéster

WABSCHMINKHANDSCHUH

- Aus weichem Stoff, ideal zum Abschminken
- Material: 100 % Polyester



1. Apply cleanser to your face

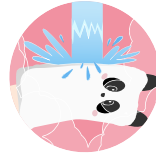

2. Wet the glove with warm water



3. Gently wipe the cloth over your face to remove impurities



4. Rinse!



PANDA
RGL0001



UNICORN
RGL0002



KITTY
RGL0003



PACKAGING
window box
L 9 x H 14 x W 3 cm
SOLD X 6

**CUTIE FRIENDS**

Ø 4 cm, H 6.5 cm

MAKEUP SPONGE

- Soft sponge for applying foundation and concealers
- Easy to use and soft to the touch
- Latex-free
- Material: PU

ÉPONGE À MAQUILLAGE

- Éponge douce pour l'application de fonds de teint et de correcteurs
- Facile à utiliser et douce au toucher
- Sans latex
- Matériau : PU

MAKE-UP-SCHWAMM

- Weicher Schwamm zum Auftragen von Foundation und Concealer
- Einfach anzuwenden und mit weicher Haptik
- Latexfrei
- Material: PU

PACKAGING

RPET box w/fabric loop
L 4 x H 8 x W 4 cm

SPUGNETTA MAKEUP

- Morbida spugnetta per l'applicazione di fondotinta e correttori
- Facile da utilizzare e morbida al tatto
- Priva di lattice
- Materiale: PU

ESPONJA DE MAQUILLAJE

- Suave esponja para la aplicación de la base de maquillaje y el corrector
- Fácil de utilizar y suave al tacto
- Sin látex
- Material: PU

DISPLAY

material: cardboard
L 8.5 x H 17 x W 17 cm
8 PCS

DINO**BBLKIT1**

8 051128 753257

**DISPLAY**

material: cardboard
L 8.5 x H 17 x W 17 cm
8 PCS

LLAMA
BBLKIT2



8 051128 753264

**DISPLAY**

material: cardboard
L 8.5 x H 17 x W 17 cm
8 PCS

AVOCADO**BBLKIT3**

8 051128 753271



NICE TO SEE YOU

L 6 x H 6 x W 1 cm

HANDBAG MIRROR

- Two mirrors, one of which is magnifying
- Ideal for your handbag and for travelling

SPECCHIETTO DA BORSETTA

- Due specchi, uno dei quali ingranditore
- Ideale per la borsetta e per il viaggio

MIROIR DE POCHE

- Deux miroirs, l'un des deux grandissant
- Idéal à emporter dans votre sac à main et en voyage

ESPEJO DE BOLSO

- Dos espejos, uno de ellos con aumento
- Ideal para llevarlo en el bolso y para los viajes

TASCHENSPIEGEL

- Zwei Spiegel, davon ein Vergrößerungsspiegel
- Ideal für die Handtasche und für Reisen



DISPLAY
material: cardboard
L 8.2 x H 13 x W 13.8 cm
6 PCS

TRAVEL
MIRKIT1



GOLD FOIL

DISPLAY
material: cardboard
L 8.2 x H 13 x W 13.8 cm
6 PCS

STARS
MIRKIT12



SILVER FOIL

DISPLAY
material: cardboard
L 8.2 x H 13 x W 13.8 cm
6 PCS

FLOWERS
MIRKIT13



DISPLAY
material: cardboard
L 8.2 x H 13 x W 13.8 cm
6 PCS

LIPS
MIRKIT14



SILVER FOIL

DISPLAY
material: cardboard
L 8.2 x H 13 x W 13.8 cm
6 PCS

UNICORN
MIRKIT15



BYE BYE FRIDA

L 5 x H 0.5 x W 0.6 cm

SET OF 4 MINI TWEEZERS

- 4 different tips for every need: flat tip, slant tip, pointed-slant tip, point tip
- Material: stainless steel

SET DI 4 MINI PINZETTE

- 4 punte differenti per ogni necessità: punta piatta, punta angolata, punta obliqua, punta appuntita
- Materiale: acciaio inossidabile

SET DE 4 MINI PINCES À ÉPILER

- 4 mors différents pour chaque besoin : mors plat, mors crabe, mors en biais, mors pointu
- Matériau : acier inoxydable

SET DE 4 MINI PINZAS

- 4 puntas diferentes para cada necesidad: punta plana, punta angularada, punta oblicua, punta fina
- Material: acero inoxidable

SET MIT 4 MINI-PINZETTEN

- 4 verschiedene Spitzen für jeden Bedarf: Spitze mit gerader Form, Spitze mit eckiger Form, Spitze mit schräger Form, Spitze mit spitz zulaufender Form
- Material: Edelstahl

PACKAGING

PVC bag
L 6.2 x H 16 x W 0.7 cm
SOLD X 6

TWE001



LOVE MY HAIR

L 23 x H 55 x W 3 cm

HAIR TURBAN TOWEL

- Super-absorbent
- With button
- Material: 85% polyester, 15% polyamide

ASCIUGAMANO A TURBANTE PER CAPELLI

- Super assorbente
- Con bottone
- Materiale: 85% poliestere, 15% poliammide

SERVIETTE TURBAN À CHEVEUX

- Super absorbante
- Avec bouton
- Matériau : 85 % polyester, 15 % polyamide

TOALLA EN FORMA DE TURBANTE PARA EL PELO

- Superabsorbente
- Con botón
- Material: 85 % poliéster, 15 % poliamida

TURBAN-HANDTUCH FÜR DIE HAARE

- Extrem saugfähig
- Mit Knopf
- Material: 85 % Polyester, 15 % Polyamid



**FRIZZ-FREE
& AMAZING HAIR**



**SUPER
ABSORBENT**

PACKAGING

window box
L 11 x H 16 x W 6.5 cm

SOLD X 6**PANDA**

HTW0001



8 052694 000905

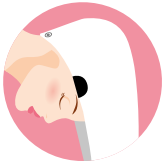

1. Position with button
at the nape.



2. Wrap hair.



3. Twist around the
head.



4. Secure with button
in loop.

**PACKAGING**

window box
L 11 x H 16 x W 6.5 cm

SOLD X 6**KITTY**

HTW0002



8 052694 000912



THE SHOWER MUST GO ON

Ø 37 cm, H 6 cm (Panda)
 Ø 37 cm, H 13 cm (Unicorn)

SHOWER CAP

- Reusable
- Elasticated opening
- Material: EVA

CUFFIA DA DOCCIA

- Riutilizzabile
- Bordo elastico
- Materiale: EVA

CHARLOTTE DE DOUCHE

- Réutilisable
- Bord élastique
- Matériau : EVA

GORRO DE DUCHA

- Reutilizable
- Borde elástico
- Material: EVA

DUSCHHAUBE

- Wiederverwendbar
- Gummibund
- Material: EVA



PACKAGING

window box
 L 9 x H 16.5 x W 5.5 cm
SOLD X 6

PANDA
SHC0001



PACKAGING

window box
 L 9 x H 16.5 x W 5.5 cm
SOLD X 6

UNICORN
SHC0002



ONE SIZE



ME TIME

L 24.5 x H 11 cm

HEADBAND

- Makes applying makeup or skin care products easy
- Material: 100% polyester

FASCIA PER CAPELLI

- Per una facile applicazione del trucco o dei prodotti cosmetici per il viso
- Materiale: 100% poliestere

BANDEAU POUR CHEVEUX

- Pour appliquer facilement le maquillage ou les produits cosmétiques pour le visage
- Matériau : 100 % polyester

BANDA PARA EL PELO

- Para una fácil aplicación del maquillaje o de productos cosméticos para el rostro
- Material: 100 % poliéster

HAARBAND

- Für ein problemloses Auftragen von Schminke und Gesichtspflegeprodukten
- Material: 100 % Polyester



Elastic headband

PACKAGING

window box
 L 9 x H 14 x W 3 cm
SOLD X 6

ONE SIZE



PANDA
BAN0001



UNICORN
BAN0002



KITTY
BAN0003



AMAZING HAIR

L 6.8 x H MAX 11.5 x W 4.1 cm

DETANGLING HAIRBRUSH

- With flexible bristles in different heights: reduces the risk of hair damage and breakage
- Material: plastic

SPAZZOLA DISTRICANTE PER CAPELLI

- Denti flessibili, di altezze differenti: riduce il rischio di danneggiamento e rottura dei capelli
- Materiale: plastica

BROSSE DÉMÊLANTE POUR CHEVEUX

- Dents flexibles, de différentes hauteurs : elle réduit le risque d'abîmer et de casser les cheveux
- Matériau : plastique

CEPILLO PARA DESENREDAR EL CABELLO

- Dientes flexibles con diferentes alturas: reduce el riesgo de dañar y romper el cabello
- Material: plástico

ENTWIRRENDE HAARBÜRSTE

- Flexible Borsten mit unterschiedlicher Höhe: Reduziert das Risiko für geschädigtes oder brüchiges Haar
- Material: Kunststoff



PACKAGING
window box
L 7 x H 11.5 x W 4.2 cm
SOLD X 4

UNICORN
BRU0001



8 052461 965987



PACKAGING
window box
L 7 x H 9 x W 4.2 cm
SOLD X 4

AVOCADO
BRU0003



8 052461 966007



PACKAGING
window box
L 7 x H 9 x W 4.2 cm
SOLD X 4

FLOWERS
BRU0004



8 052694 002121



NICE HAIR

Ø 6.5 cm, W 3 cm (closed)

HAIRBRUSH WITH MIRROR**SPAZZOLA CON SPECCHIO****BROSSE À CHEVEUX AVEC
MIROIR****CEPILLO CON ESPEJO****HAARBÜRSTE MIT SPIEGEL**

DISPLAY
material: cardboard
L 9 x H 17 x W 19 cm
4 PCS

UNICORN**HBKIT32**

DISPLAY
material: cardboard
L 9 x H 17 x W 19 cm
4 PCS

PANDA**HBKIT33**

DISPLAY
material: cardboard
L 9 x H 17 x W 19 cm
4 PCS

KOALA**HBKIT34**

DISPLAY
material: cardboard
L 9 x H 17 x W 19 cm
4 PCS

KITTY**HBKIT35**

HAIR WE ARE!

Ø 11.5 cm

SET OF 3 HAIR SCRUNCHIES

- Scrunchies. Satin-like fabric
- Material: satin

SET DI 3 ELASTICI PER CAPELLI

- Elastici arricciati. Tessuto effetto satinato
- Materiale: raso

SET DE 3 CHOUCOUS POUR CHEVEUX

- Élastiques froncés. Tissu effet satiné
- Matériau : satin

SET DE 3 COLETEROS

- Coleteros fruncidos. Tejido efecto satinado
- Material: raso

HAARGUMMIS IM 3ER-SET

- Gekräuselte Haargummis. Stoff mit Satin-Effekt
- Material: Satin

SOLD X 6

PACKAGING
cardboard belly band
L 11 x H 16 x W 6 cm

STARS
SCRU0001



8 053610 784954



PACKAGING
cardboard belly band
L 11 x H 16 x W 6 cm

FLOWERS
SCRU0002



8 053610 784961

**BOBBY PINS**

H 5.5 cm

HAIR PINS

- Set of 20 assorted hair pins
- Material: metal

FORCINE PER CAPELLI

- Set di 20 forcine assortite per capelli
- Materiale: metallo

ÉPINGLES À CHEVEUX

- Set de 20 épingles à cheveux assorties
- Matériau : métal

HORQUILLAS PARA EL PELO

- Set de 20 horquillas variadas para el pelo
- Material: metal

HAARNADELN

- Set mit 20 farblich sortierten Haarnadeln
- Material: Metall

* While stock lasts

PACKAGING
plastic jar
Ø 3 cm, H 7 cm

COLOURS:
gold pearl effect,
blue, pastel
green, pastel
pink, black pearl
effect

**DISPLAY**

material: cardboard
L 20 x H 16 x W 10 cm

18 PCS

PINSKIT1 *



8 051128 750140



NAP QUEEN

L 20.5 x H 10 x W 1 cm

SUPER SOFT!

SLEEP MASK

- Elastic strap that is practical, comfortable and adjustable
- Material: polyester

MASCHERINA DA NOTTE

- Elastico regolabile, pratico e comodo
- Materiale: poliestere

MASQUE DE SOMMEIL

- Sangle élastique, pratique, confortable et réglable
- Matériau : polyester

* While stock lasts

ANTIFAZ DE NOCHE

- Sujeción con elástico, práctico, cómodo y regulable
- Material: poliéster

SCHLAFMASKE

- Elastischer, praktischer, bequemer und verstellbarer Verschluss
- Material: Polyester

ADJUSTABLE



GOLD FOIL

PACKAGING

window box
L 10 x H 23 x W 1.8 cm



DISPLAY

material: cardboard
L 11.3 x H 31 x W 15.5 cm
7 PCS

TROPICAL

SEMKIT1



8 051128 754971



SILVER FOIL

PACKAGING

window box
L 10 x H 23 x W 1.8 cm



DISPLAY

material: cardboard
L 11.3 x H 31 x W 15.5 cr
7 PCS

STARS

SEMKIT2



8 051128 754988



PACKAGING

window box
L 10 x H 23 x W 1.8 cm



DISPLAY

material: cardboard
L 11.3 x H 31 x W 15.5 cm
7 PCS

CLOUD

SEMKIT5



8 051128 756388



* ONE MORE DESIGN ON PAGE 336

CHILL OUT

Ø MAX 7.5 cm

**REUSABLE COOLING EYE PADS**

- 2 eye pads with a soothing effect
- Ingredients: 90.5% water, 5% glycerin, 4.5% sodium polyacrylate, glitter
- Material: PVC

DISCHETTI OCCHI RINFRESCANTI E RIUTILIZZABILI

- 2 dischetti per occhi con effetto lenitivo
- Ingredienti: 90,5% acqua, 5% glicerina, 4,5% poliacrilato di sodio, glitter
- Materiale: PVC

DISQUES RAFFRAÎCHISSANTS ET RÉUTILISABLES POUR LES YEUX

- 2 disques pour les yeux avec un effet apaisant
- Ingrédients : 90,5 % d'eau, 5 % de glycérine, 4,5 % de polyacrylate de sodium, paillettes
- Matériau : PVC

DISCOS REFRESCANTES Y REUTILIZABLES PARA OJOS

- 2 discos para ojos con efecto calmante
- Ingredientes: 90,5 % agua, 5 % glicerina, 4,5 % poliacrilato de sodio, purpurina
- Material: PVC

WIEDERVERWENDBARE, ERFRISCHENDE AUGENPADS

- 2 Augenpads mit beruhigender Wirkung
- Inhaltsstoffe: 90,5 % Wasser, 5 % Glycerin, 4,5 % Natriumpolyacrylat, Glitter
- Material: PVC

**PACKAGING**

window box
w/fabric loop
L 16.6 x H 8.2 x W 1 cm

**DISPLAY**

material: cardboard
L 17.5 x H 14.5 x W 11.5 cm

10 PCS**PANDA****EYPKIT1****PACKAGING**

PET box
w/fabric loop
L 16.6 x H 8.2 x W 1 cm

**DISPLAY**

material: cardboard
L 17.5 x H 14.5 x W 11.5 cm

10 PCS**CUCUMBER****EYPKIT2****PACKAGING**

window box
w/fabric loop
L 16.6 x H 8.2 x W 1 cm

**DISPLAY**

material: cardboard
L 17.5 x H 14.5 x W 11.5 cm

10 PCS**DAISY****EYPKIT4**

CHILL OUT

L 19.5 x H MAX 11 cm

**GEL EYE MASK**

- Reusable mask with adjustable elastic
- Dual function: provides hot and cold relief
- Ingredients: 70% water, 25% glycerin, 5% sodium polyacrylate
- Material: PVC, polyester

MASCHERA GEL PER OCCHI

- Maschera riutilizzabile con elastico regolabile
- Doppia funzione: sollievo caldo e sollievo freddo
- Ingredienti: 70% acqua, 25% glicerina, 5% sodio poliacrilato
- Materiale: PVC, poliester

MASQUE EN GEL POUR LES YEUX

- Masque réutilisable avec élastique réglable
- Double fonction : apaisement chaud et froid
- Ingrédients : 70 % d'eau, 25 % de glycérine, 5 % de polyacrylate de sodium
- Matériau : PVC, polyester

ANTIFAZ DE GEL PARA LOS OJOS

- Antifaz reutilizable con elástico regulable
- Doble función: alivio con efecto caliente y frío
- Ingredientes: 70 % agua, 25 % glicerina, 5 % poliacrilato de sodio
- Material: PVC, poliéster

GELMASKE FÜR DIE AUGEN

- Wiederverwendbare Maske mit verstellbarem Gummiband
- Doppelfunktion: warme und kalte Erleichterung
- Inhaltsstoffe: 70 % Wasser, 25 % Glycerin, 5 % Natriumpolyacrylat
- Material: PVC, Polyester

**PACKAGING**window box
L 10.5 x H 22 x W 1.5 cm**DISPLAY**material: cardboard
L 11.5 x H 28 x W 12.5 cm**7 PCS****PANDA****EMKIT1****PACKAGING**window box
L 10.5 x H 22 x W 1.5 cm**DISPLAY**material: cardboard
L 11.5 x H 28 x W 12.5 cm**7 PCS****KITTY****EMKIT2****PACKAGING**PET box
L 9 x H 22 x W 1.5 cm**DISPLAY**material: cardboard
L 10 x H 28 x W 12.5 cm**7 PCS****DREAM BIG****EMKIT3****PACKAGING**window box
L 10.5 x H 22 x W 1.7 cm**DISPLAY**material: cardboard
L 11.5 x H 28 x W 12.5 cm**7 PCS****UNICORN****EMKIT4**

KEEP IN CONTACT

L 9 x H 3 x W 5 cm

CONTACT LENS HOLDER WITH MIRROR

- Contact lens holder (removable) inside the box
- Material: metal coated in PU with spring closure, velvet-covered interior

PORTA LENTI A CONTATTO CON SPECCHIETTO

- All'interno scatola porta lenti a contatto (removibile)
- Materiale: metallo rivestito in PU con chiusura a molla, rivestimento interno in velluto

ÉTUI À LENTILLES DE CONTACT AVEC MIROIR

- Il contient une petite boîte à lentilles de contact (amovible)
- Matériau : métal avec revêtement en PU et fermeture à ressort, revêtement intérieur en velours

ESTUCHE PARA LENTILLAS CON ESPEJO

- Contiene un portalentillas (extraíble)
- Material: metal revestido en PU con cierre de muelle, revestimiento interior de terciopelo

KONTAKTLINSENBOX MIT SPIEGEL

- Mit innerem Kontaktlinsehälter (herausnehmbar)
- Material: Metall mit PU-Beschichtung und Federverschluss, Innenfutter aus Samt



DISPLAY

material: cardboard
L 13.5 x H 16.5 x W 15 cm

8 PCS

HEDGEHOG

KCKIT2



8 051128 750102



DISPLAY

material: cardboard
L 13.5 x H 16.5 x W 15 cm

8 PCS

FLOWERS

KCKIT3



8 051128 750119



SMACK

Ø 2 cm, H 7.5 cm

NATURAL LIP BALM

- 75% natural ingredients
- Nourishing and protective

BURROCAO NATURALE

- 75% di ingredienti naturali
- Nutriente e protettivo

BAUME À LÈVRES NATUREL

- 75 % d'ingrédients naturels
- Nourissant et protecteur

SOLD X 4

BÁLSAMO LABIAL NATURAL

- 75 % de ingredientes naturales
- Nutritivo y protector

NATÜRLICHER LIPPENBALSAM

- 75 % natürliche Inhaltsstoffe
- Nährstoffreich und schützend



SMACK LIP BALM DISPLAY

Counter empty display on demand: MOQ 28 pcs
material: cardboard
L 19 x H 16.5 x W 10 cm

DISSMACK2



8 054117 620813

RASPBERRY
SMA0001

8 051070 270673

ALOE
SMA0002

8 051070 270680

COCONUT
SMA0004

8 051070 270703

VANILLA
SMA0005

8 051070 270710

CHERRY
SMA0006

8 051070 270727

CHOCOLATE
SMA0008

8 057093 533542

STRAWBERRY
SMA0009

8 057093 533559

MAGIC KISS

L 3.5 x H 3.8 x W 3.8 cm

LIP GLOSS

LUCIDALABBRA

BRILLANT À LÈVRES

BRILLO DE LABIOS

LIPGLOSS

 Sweet vanilla

DISPLAY
material: plastic
L 14 x H 15.5 x W 14 cm
24 PCS

KITTY

KLGKIT1



8 051128 756371

MAGIC KISS

L 4.5 x H 5.5 x W 4 cm

LIP GLOSS

LUCIDALABBRA

BRILLANT À LÈVRES

BRILLO DE LABIOS

LIPGLOSS

 Sweet vanilla

DISPLAY
material: plastic
L 14 x H 15.5 x W 14 cm
24 PCS

UNICORN

ULKITS



8 053610 782042

MAGIC KISS

L 3.5 x H 3.8 x W 3.8 cm

LIP GLOSS

LUCIDALABBRA

BRILLANT À LÈVRES

BRILLO DE LABIOS

LIPGLOSS

 Bubble gum

NEW



DISPLAY
material: plastic
L 14 x H 15.5 x W 14 cm
24 PCS

PANDA

PLGKIT1



8 052694 011567

BUT FIRST, NAILS!

L 10 x H 10,5 x W 2 cm

MANICURE KIT

- Contains: mini scissors, nail clippers, file, cuticle pusher
- Zip closure
- Material: PU case with fleece lining, stainless steel accessories

KIT MANICURE

- Contiene: forbicine, tagliaunghie, lima, spingicuticola
- Chiusura a zip
- Materiale: custodia in PU con interno in pile, accessori in acciaio inox

KIT MANUCURE

- Contient : des ciseaux à ongles, un coupe-ongle, une lime et un pousse cuticule
- Fermeture éclair
- Matériau : pochette en PU, intérieur en polaire, accessoires en acier inoxydable

KIT DE MANICURA

- Incluye: tijeras, cortaúñas, lima y empujacutículas
- Cierre con cremallera
- Material: estuche de PU con interior de forro polar, accesorios de acero inoxidable

MANIKÜRE-SET

- Inhalt: Nagelschere, Nagelknipser, Nagelfeile, Nagelhautschieber
- Reißverschluss
- Material: Etui aus PU mit Futter aus Fleece, Utensilien aus Edelstahl

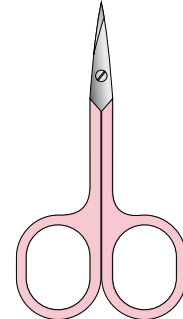
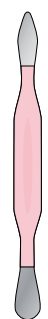
**STAINLESS STEEL****IDEAL FOR TRAVEL****NAIL CLIPPERS****MINI SCISSORS****FILE****CUTICLE PUSHER****PACKAGING**window box
L 13 x H 16 x W 4 cm**SOLD X 6****PANDA****MST0001**

8 052694 001728

**PACKAGING**window box
L 13 x H 16 x W 4 cm**SOLD X 6****KITTY****MST0002**

8 052694 001735



* ONE MORE DESIGN ON PAGE 337

NAILS BEFORE MALES

L 2 x H 18 x W 0.3 cm

SET OF 3 NAIL FILES

- 2 sides = 2 actions: coarse-grained back for filing; fine-grained front for refining
- Material: sandpaper, EVA, PS

SET DI 3 LIME PER UNGHIE

- 2 lati = 2 azioni: retro a grana grossa per limare; fronte a grana fine per rifinire
- Materiale: carta abrasiva, EVA, PS

SET DE 3 LIMES À ONGLES

- 2 faces = 2 actions : une face recto à gros grain pour limer ; une face verso à grain fin pour la finition
- Matériau : papier émeri, EVA, PS

SET DE 3 LIMAS DE UÑAS

- 2 lados = 2 acciones: lado de grano grueso para limar; lado de grano fino para pulir
- Material: papel de lija, EVA, PS

SET MIT 3 NAGELFEILEN

- 2 Seiten = 2 Funktionen: Rückseite mit grober Körnung zum Feilen; Vorderseite mit feiner Körnung zum Nachbearbeiten
- Material: Schleifpapier, EVA, PS

**PACKAGING**

PVC bag
L 9 x H 22.5 x W 0.4 cm
SOLD X 6

LLAMA

NFS0001



8 059174 832346

**PACKAGING**

PVC bag
L 9 x H 22.5 x W 0.4 cm
SOLD X 6

FLOWERS

NFS0003



8 052694 002138



LOVE AT FIRST WIPE

L 6 x H 10.5 x W 2.5 cm (pack size)

10 CLEANSING WET WIPES FOR HANDS AND FACE

- Plastic free
- Refreshing scented wet wipes for the hands and face in resealable packaging
- Made of viscose

10 SALVIETTINE DETERGENTI UMIDIFICATE PER MANI E VISO

- Senza plastica
- Salviettine umidificate rinfrescanti e profumate per le mani e il viso in confezione richiudibile
- In viscosa

10 LINGETTES NETTOYANTES HUMIDES POUR LES MAINS ET LE VISAGE

- Sans plastique
- Lingettes humides rafraîchissantes et parfumées pour les mains et le visage, dans un emballage refermable
- En viscose

10 TOALLITAS LIMPIADORAS HÚMEDAS PARA LAS MANOS Y EL ROSTRO

- Sin plástico
- Toallitas húmedas refrescantes y perfumadas para las manos y el rostro en envase recerrable
- De viscosa

10 REINIGENDE FEUCHTTÜCHER FÜR HÄNDE UND GESICHT

- Ohne Kunststoff
- Erfrischende und duftende Feuchttücher für Hände und Gesicht in einer wiederverschließbaren Verpackung
- Aus Viskose



Floral bloom

DISPLAYmaterial: cardboard
L 12 x H 16.5 x W 11.5 cm**12 PCS****DAISY****WIPKIT7**

8 052694 003173



*Plastic free: wording refers to the wipes.

* ONE MORE DESIGN ON PAGE 293

MIDNIGHT BATH

L 1.5 x H 1.5 cm - 30 g

HEART-SHAPED BATH CONFETTI

- Scented bath confetti soap for your tub
- Material: soap powder

CUORICINI DI SAPONE DA BAGNO

- Coriandoli di sapone profumato per vasca da bagno
- Materiale: polvere di sapone

PETITS CŒURS DE BAIN

- Confettis de savon parfumé pour le bain
- Matériau : poudre de savon

CORAZONES DE JABÓN

- Confeti de jabón perfumado para bañera
- Material: polvo de jabón

KLEINE SEIFENHERZEN

- Duftendes Seifenconfetti für die Badewanne
- Material: Seifenpulver

PACKAGING
window box
L 7 x H 7 x W 3.5 cm**DISPLAY**material: cardboard
L 15 x H 13 x W 11.5 cm**6 PCS****MIBAKIT2**

8 052694 005634





EXTRAORDINARY **STATIONERY**
Inspiring Everyday

Whether writing, drawing or taking notes, let your creativity flow

ERASABLE PEN

Ø 0.8 cm, H 15 cm

ERASABLE GEL PEN
• Thermosensitive ink

PENNA GEL CANCELLABILE
• Inchiostro termosensibile

STYLO À ENCRE GEL EFFAÇABLE
• Encre termosensible

BOLÍGRAFO DE GEL BORRABLE
• Tinta termosensible

LÖSCHBARER GELSTIFT
• Thermoempfindliche Tinte



BLACK INK

GIRAFFE
EPBLAKIT19

8 051128 756340

BLACK INK

CORGI
EPBLAKIT20

8 052694 002718

RED INK

TEDDY BEAR
EPREDKIT24

8 052694 003746

BLUE INK

HIPPO
EPBLUKIT28

8 052694 007973

BLACK INK

BEE
EPBLAKIT29

8 052694 007980

DISPLAY material: cardboard L 5 x H 14 x W 15.5 cm 30 PCS

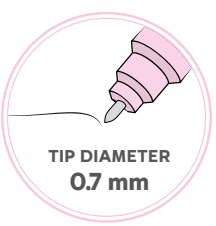

ERASABLE PEN SET

Ø 0.8 cm, H 15 cm

SET OF 3 ERASABLE GEL PENS

- Thermosensitive ink

SET DI 3 PENNE GEL CANCELLABILI

- Inchiostro termosensibile

SET DE 3 STYLOS GEL EFFAÇABLE

- Encre thermosensible

SET DE 3 BOLÍGRAFOS DE GEL BORRABLE

- Tinta termosensible

SET MIT 3 LÖSCHBAREN GELSTIFTEN

- Thermoempfindliche Tinte



PACKAGING

carded
L 10 x H 22 x 0.5 cm

3 PCS:

- 1 X EP0017, 1 X EP0018,
- 1 X EP0019



DISPLAY

material: cardboard
L 11 x H 32.5 x W 22.5 cm

12 PCS

EPSETKITS



Products not included

DISPLAYS ON DEMAND

ERASABLE PENS DISPLAY



Large counter empty display on demand:

MOQ 450 pcs

- 15 pockets
- material: acrylic
- L 29.3 x H 27.5 x W 18.5 cm

DISEP4



ERASABLE PEN REFILL SET DISPLAY

Small counter empty display on demand:

MOQ 80 pcs

- 2 hooks
- material: cardboard
- L 13 x H 27 x W 10 cm

DISREFEP



ERASABLE PEN REFILL SET

Ø 4 mm, H 13 cm



SET OF 3 REFILLS FOR ERASABLE GEL PEN
• Thermosensitive ink

SET DI 3 REFILL PER PENNA GEL CANCELLABILE
• Inchiostro termosensibile

SET DE 3 RECHARGES POUR STYLO À ENCRE GEL EFFAÇABLE
• Encre thermosensible

SET DE 3 RECARGAS PARA BOLÍGRAFO DE GEL BORRABLE
• Tinta termosensible

SET MIT 3 NACHFÜLLPACKUNG FÜR LÖSCHBAREN GELSTIFT
• Thermoempfindliche Tinte

SOLD X 10

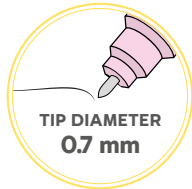

PACKAGING
carded
L 6 x H 18 x W 0.5 cm

REFEP0004
 8 052461 965901



PACKAGING
carded
L 6 x H 18 x W 0.5 cm

REFEP0005
 8 052461 965918



PACKAGING
carded
L 6 x H 18 x W 0.5 cm

REFEP0006
 8 052461 965925



PACKAGING
carded
L 6 x H 18 x W 0.5 cm

REFEP0007
 8 052461 965932



PACKAGING
carded
L 6 x H 18 x W 0.5 cm

REFEP0008
 8 052461 965949



PACKAGING
carded
L 6 x H 18 x W 0.5 cm

REFEP0009
 8 054117 621292



PACKAGING
carded
L 6 x H 18 x W 0.5 cm

REFEP0010
 8 054117 621308



PACKAGING
carded
L 6 x H 18 x W 0.5 cm

REFEP0011
 8 053610 782967

MAKE MISTAKES

Ø 1 cm, H 15.2 cm

3-COLOUR ERASABLE GEL PEN
• Thermosensitive ink

PENNA GEL CANCELLABILE 3 COLORI
• Inchiostro termosensibile

STYLO À ENCRE GEL EFFAÇABLE 3 COULEURS
• Encre termosensibile

BOLÍGRAFO DE GEL BORRABLE DE 3 COLORES
• Tinta termosensible

LÖSCHBARER, 3-FARBIGER GELSTIFT
• Thermoempfindliche Tinte

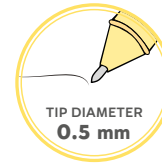

PACKAGING
carded
L 6 x H 21 x W 1.5 cm



DISPLAY
material: cardboard
L 14.8 x H 27.8 x W 13 cm
12 PCS

TRAVEL
TEPKITI



PACKAGING
carded
L 6 x H 21 x W 1.5 cm



DISPLAY
material: cardboard
L 14.8 x H 27.8 x W 13 cm
12 PCS

FLOWERS
TEPKITZ



MAKE MISTAKES REFILLS - For Legami 3-colour Erasable gel pens only

Ø 0.3 cm, H 9.5 cm

SET OF 4 REFILLS FOR 3-COLOUR ERASABLE GEL PEN
• Thermosensitive ink

SET DI 4 REFILL PER PENNA GEL CANCELLABILE 3 COLORI
• Inchiostro termosensibile

SET DE 4 RECHARGES POUR STYLO À ENCRE GEL EFFAÇABLE 3 COULEURS
• Encre termosensibile

SET DE 4 RECAMBIOS PARA BOLÍGRAFO DE GEL BORRABLE DE 3 COLORES
• Tinta termosensible

SET MIT 4 ERSATZMINEN FÜR LÖSCHBAREN, 3-FARBIGEN GELSTIFT
• Thermoempfindliche Tinte

PACKAGING
carded
L 6 x H 15.2 x W 0.4 cm



DISPLAY
material: cardboard
L 8 x H 22 x W 13 cm
12 PCS

REFTEPKITI

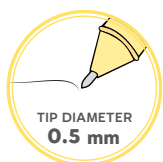

LOVELY FRIENDS

L 2 x H 14 cm

GEL PEN WITH ANIMAL DECORATION

- Mix and match decoration

PENNA GEL CON ANIMALETTO DECORATIVO

- Decorazione ricombinabile

STYLO À ENCRE GEL ORNÉ D'UN PETIT ANIMAL DÉCORATIF

- Décoration interchangeable

BOLÍGRAFO DE GEL CON ANIMAL DECORATIVO

- Decoración combinable

GELSTIFT MIT TIERDEKO

- Tier-Deko verschieden kombinierbar

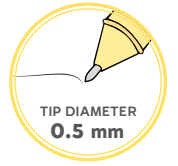

PANDA

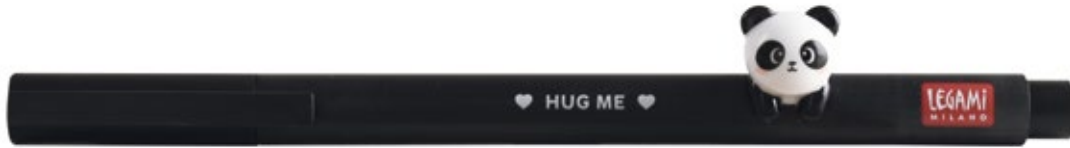

BLACK INK

KITTY



PINK INK

TEDDY BEAR



RED INK

KOALA



GREEN INK

SLOTH



BLUE INK

UNICORN



NEON PINK INK

DINO

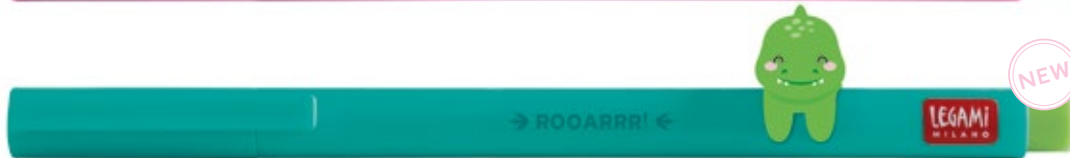

NEON GREEN INK

DISPLAY

material: cardboard

L 6.9 x H 19.5 x W 10.7 cm

15 PCS



PANDA

CPPKIT1



8 051128 756982

KITTY

CPPKIT2



8 051128 756999

TEDDY BEAR

CPPKIT3



8 051128 757002

KOALA

CPPKIT4



8 051128 757019

SLOTH

CPPKIT5



8 051128 757026

UNICORN

CPPKIT6



8 052694 005917

DINO

CPPKIT7



8 052694 005931

LOVELY FRIENDS REFILL SET

Ø 0.3 cm, H 9.5 cm



SET OF 2 REFILLS FOR GEL PEN LOVELY FRIENDS

SET DI 2 REFILL PER PENNA GEL LOVELY FRIENDS

SET DE 2 RECHARGES POUR STYLO À ENCRE GEL LOVELY FRIENDS

SET DE 2 RECARGAS PARA BOLÍGRAFO DE GEL LOVELY FRIENDS

SET MIT 2 ERSATZPATRONEN FÜR GELSTIFT LOVELY FRIENDS

SOLD X 10

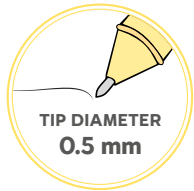

PACKAGING carded
L 6 x H 15.2 x W 0.4 cm

REFCPP0001



PACKAGING carded
L 6 x H 15.2 x W 0.4 cm

REFCPP0002



PACKAGING carded
L 6 x H 15.2 x W 0.4 cm

REFCPP0003



PACKAGING carded
L 6 x H 15.2 x W 0.4 cm

REFCPP0004



PACKAGING carded
L 6 x H 15.2 x W 0.4 cm

REFCPP0005



PACKAGING carded
L 6 x H 15.2 x W 0.4 cm

REFCPP0006



PACKAGING carded
L 6 x H 15.2 x W 0.4 cm

REFCPP0007



LOVELY FRIENDS REFILL SET DISPLAY

Small counter empty display on demand:
MOQ 70 pcs
• 2 hooks
• material: cardboard
• L 13 x H 27 x W 10 cm

DISREFCPP



MAGIC PEN

Ø 1.3 cm, H 15 cm

INVISIBLE INK PEN

- Dual tips: blue ink ballpoint tip and invisible ink tip
- With UV light for reading the invisible ink

PENNA CON INCHIOSTRO INVISIBILE

- Doppia punta: punta a sfera con inchiostro blu e punta con inchiostro invisibile
- Con luce UV per leggere l'inchiostro invisibile

STYLO À ENCRE INVISIBLE

- Double pointe : pointe à bille avec encre bleue et pointe à encre invisible
- Avec lumière UV pour lire l'encre invisible

BOLÍGRAFO DE TINTA INVISIBLE

- Doble punta: punta de esfera con tinta azul y punta con tinta invisible
- Con luz UV para leer la tinta invisible

STIFT MIT UNSICHTBARER TINTE

- Zwei Spitzen: Kugelschreiber mit blauer Tinte und unsichtbare Tinte
- Mit UV-Licht zum Lesen der unsichtbaren Tinte

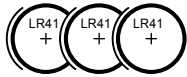

3 x LR41 batteries (included, non-replaceable)

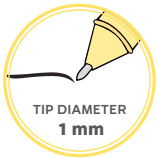

PACKAGING

carded
L 8 x H 21.5 x W 1.5 cm



DISPLAY

material: cardboard
L 17.1 x H 28 x W 12.5 cm
12 PCS

UNICORN

MINKIT1

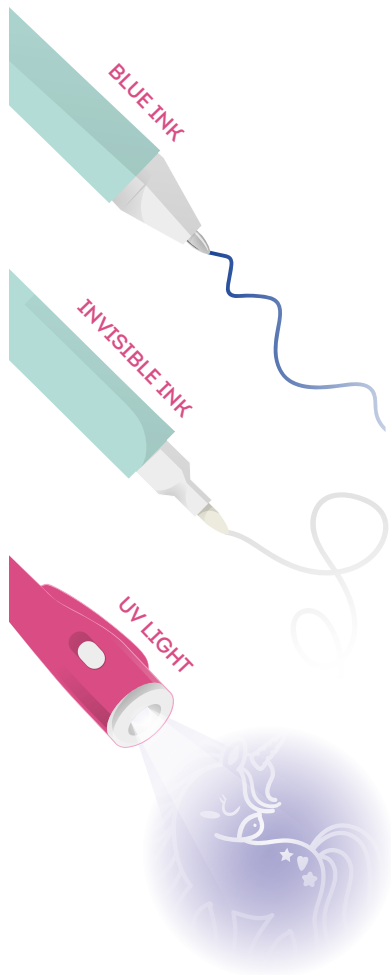

PACKAGING

carded
L 8 x H 21.5 x W 1.5 cm



DISPLAY

material: cardboard
L 17.1 x H 28 x W 12.5 cm
12 PCS

SPACE

MINKIT2



WRITING IS MAGIC

L 3.5 x H 20 cm

LIGHT-UP CAT BALLPOINT PEN

- Tap the cat on the table to make it light up

PENNA A SFERA CON GATTO LUMINOSO

- Battendo il gatto sul tavolo, s'illumina

STYLO A BILLE AVEC CHAT LUMINEUX

- Le chat s'allume quand on le tape contre la table

BOLÍGRAFO CON GATO LUMINOSO

- Se ilumina al presionar el gato contra la mesa

KUGELSCHREIBER MIT LEUCHTENDER KATZE

- Die Katze leuchtet auf, wenn du mit ihr auf den Tisch klopfst



3 x LR621 batteries
(included, non-replaceable)



DISPLAY

material: cardboard
L 9 x H 20 x W 9 cm

12 PCS

KITTY
KPKIT1



8 051128 756951

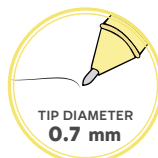

BLUE INK



WRITING IS MAGIC

L 3.5 x H 20 cm

LIGHT-UP UNICORN BALLPOINT PEN

- Knock the unicorn on the table and it lights up

PENNA A SFERA CON UNICORNO LUMINOSO

- Battendo l'unicorno sul tavolo, s'illumina

STYLO À BILLE AVEC LICORNE LUMINEUSE

- En battant la licorne sur la table, elle s'illumine

BOLÍGRAFO CON UNICORNIO LUMINOSO

- Golpea el unicornio en la mesa para iluminarlo

KUGELSCHREIBER MIT LEUCHTENDEM EINHORN

- Klopfen Sie das Einhorn auf den Tisch und es beginnt zu leuchten



3 x LR621 batteries
(included, non-replaceable)



DISPLAY

material: cardboard
L 9 x H 20 x W 9 cm

12 PCS

UNICORN
UPKIT1



8 051128 751949

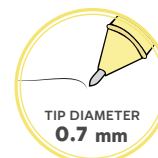

BLUE INK



WRITING IS MAGIC

L 3.5 x H 20 cm

LIGHT-UP HEART BALLPOINT PEN

- Tap the heart on the table to make it light up

PENNA A SFERA CON CUORE LUMINOSO

- Battendo il cuore sul tavolo, s'illumina

STYLO À BILLE AVEC CŒUR LUMINEUX

- Le cœur s'allume quand on le tape contre la table

BOLÍGRAFO CON CORAZÓN LUMINOSO

- Se ilumina al presionar el corazón contra la mesa

KUGELSCHREIBER MIT LEUCHTENDER HERZ

- Das Herz leuchtet auf, wenn du mit ihr auf den Tisch klopfst

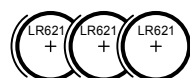

3 x LR621 batteries
(included, non-replaceable)



DISPLAY

material: cardboard
L 9 x H 20 x W 9 cm

12 PCS

HEART
HPLKIT1



8 052694 005245

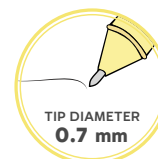

PINK INK



MINI MAGIC RAINBOW

Ø 2.3 cm, H 10 cm

MINI 4-COLOUR BALLPOINT PEN

MINI PENNA A SFERA 4 COLORI

MINI STYLO À BILLE 4 COULEURS

MINI BOLÍGRAFO DE ESFERA 4 COLORES

MINI-KUGELSCHREIBER MIT 4 FARBEN

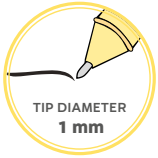

- PURPLE INK
- PINK INK
- GREEN INK
- BLUE INK

DISPLAY
material: cardboard
L 11 x H 19 x W 17 cm
24 PCS

UNICORN
MRPKIT1



- BLACK INK
- ORANGE INK
- GREEN INK
- BLUE INK

DISPLAY
material: cardboard
L 11 x H 19 x W 17 cm
24 PCS

DINO
MRPKIT2



MAGIC RAINBOW

Ø 1.4 cm, H 11 cm

6-COLOUR BALLPOINT PEN

PENNA A SFERA 6 COLORI

STYLO À BILLE 6 COULEURS

BOLÍGRAFO DE 6 COLORES

SECHSFARBIGER KUGELSCHREIBER

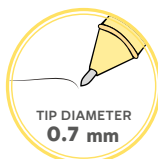

- BLACK INK
- RED INK
- PURPLE INK
- ORANGE INK
- GREEN INK
- BLUE INK

DISPLAY
material: cardboard
L 18.5 x H 19.5 x W 15 cm
24 PCS

SIXKIT2



CLICK&CLACK

Ø 1.2 cm, H 14 cm

**2-COLOUR
BALLPOINT PEN**

**PENNA A SFERA
A 2 COLORI**

**STYLO À BILLE
2 COULEURS**

**BOLÍGRAFO DE
2 COLORES**

**ZWEIFARBIGER
KUGELSCHREIBER**

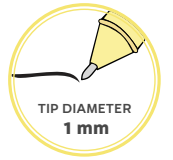

● BLACK INK
● PINK INK

DISPLAY
material: cardboard
L 7 x H 21.5 x W 13.5 cm
12 PCS

**FLAMINGO
CLICKKIT16**



8 051128 755114



● GREEN INK
● BLUE INK

DISPLAY
material: cardboard
L 7 x H 21.5 x W 13.5 cm
12 PCS

**KOALA
CLICKKIT19**



8 051128 755121



● AQUA INK
● PINK INK

DISPLAY
material: cardboard
L 7 x H 21.5 x W 13.5 cm
12 PCS

**LLAMA
CLICKKIT22**



8 051128 755152



● RED INK
● BLUE INK

DISPLAY
material: cardboard
L 7 x H 21.5 x W 13.5 cm
12 PCS

**SPACE
CLICKKIT23**



8 051128 755169



● PINK INK
● BLACK INK

DISPLAY
material: cardboard
L 7 x H 21.5 x W 13.5 cm
12 PCS

**PANDA
CLICKKIT24**



8 051128 755176



SHINE LIKE A DIAMOND

Ø 0.8 cm, H 10.8 cm

SET OF 6 GLITTER MINI GEL PENS

SET DI 6 MINI PENNE GEL GLITTERATE

SET DE 6 MINI STYLOS À ENCRE GEL PAILLETÉS

SET DE 6 MINIBOLÍGRAFOS DE GEL CON PURPURINA

SET MIT 6 GLITZERNDEN MINI-GELSTIFTEN

PACKAGING

window box
L 7.5 x H 13.2 x W 2 cm



DISPLAY

material: cardboard
L 15 x H 22 x W 13 cm
12 PCS

GGPKIT1

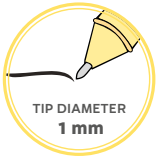

TWIST

Ø 1 cm, H 14.5 cm

SET OF 3 MULTICOLOURED GEL PENS

SET DI 3 PENNE GEL MULTICOLORE

SET DE 3 STYLOS À ENCRE GEL MULTICOLORE

SET DE 3 BOLÍGRAFOS DE GEL MULTICOLOR

SET MIT 3 GELSTIFTEN MIT BUNTER, FARBWECHELNDER MINE

PACKAGING

PET box w/hook
L 3.5 x H 17 x W 1.5 cm



DISPLAY

material: cardboard
L 7 x H 22 x W 9 cm
12 PCS

TWPKIT1

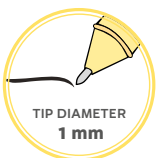

INITIAL PEN

Ø 0.7 cm, H 13.5 cm

BALLPOINT PEN

• Material: metal

PENNA A SFERA

• Materiale: metallo

STYLO À BILLE

• Matériau : métal

BOLÍGRAFO

• Material: metal

INDIVIDUAL DESIGNS: SOLD X 1

KUGELSCHREIBER
• Material: Metall

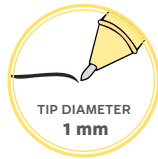

FIRST ORDER: MOQ 1 FULL ASSORTED DISPLAY (100 PCS)

material: acrylic
L 12.7 x H 14 x W 13.5 cm

ASSORTMENT:

- 6 PCS: A, E, L, M, S**
- 5 PCS: B, C, D, F, G, I, R**
- 4 PCS: N, O, P, T, V**
- 3 PCS: J - 2 PCS: H, K, W, Z**
- 1 PC: Q, U, X, Y**

ALPHAKIT1



BLACK INK



	ALPHA0001  8 052783 612118		ALPHA0002  8 052783 612125		ALPHA0003  8 052783 612132		ALPHA0004  8 052783 612149		ALPHA0005  8 052783 612156
	ALPHA0006  8 052783 612163		ALPHA0007  8 052783 612170		ALPHA0008  8 052783 612187		ALPHA0009  8 052783 612194		ALPHA0010  8 052783 612200
	ALPHA0011  8 052783 612217		ALPHA0012  8 052783 612224		ALPHA0013  8 052783 612231		ALPHA0014  8 052783 612248		ALPHA0015  8 052783 612255
	ALPHA0016  8 052783 612262		ALPHA0017  8 052783 612279		ALPHA0018  8 052783 612286		ALPHA0019  8 052783 612293		ALPHA0020  8 052783 612309
	ALPHA0021  8 052783 612316		ALPHA0022  8 052783 612323		ALPHA0023  8 052783 612330		ALPHA0024  8 052783 612347		ALPHA0025  8 052783 612354
	ALPHA0026  8 052783 612361								

SMART TOUCH

Ø 0.8 cm, H 9.6 cm

MINI TOUCHSCREEN PEN

MINI PENNA TOUCH

MINI STYLO TACTILE

MINIBOLÍGRAFO TÁCTIL

MINI-TOUCHSCREEN-STIFT

SOLD X 6

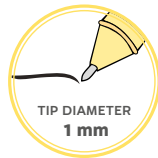

SMART TOUCH DISPLAY

Counter empty display on demand:
MOQ 24 pcs
material: cardboard
L 12.5 x H 18 x W 14.5 cm

DISPWT



REFILL TYPE: D1, AVAILABLE ON THE MARKET

BLACK INK

With touchscreen rubber tip



PWT0001 BLACK

8 051739 305289



PWT0002 PETROL BLUE

8 051739 305296



PWT0003 BLUE

8 051739 305302



PWT0004 PINK

8 051739 305319



PWT0005 PINK GRADIENT

8 052694 010416



PWT0006 BLUE GRADIENT

8 052694 011093

CACTUS PEN

Ø 1.4 cm, L 3 x H 15.2 cm

GEL PEN

PENNA GEL

STYLO À ENCRE GEL

BOLÍGRAFO DE GEL

GELSTIFT

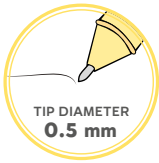

DISPLAY

material: PET and cardboard
L 11.8 x H 16.5 x W 10.7 cm

16 PCS

CTSKIT2



BLACK INK

WATERMELON PEN

L 2 x H 14.8 x W 1 cm

GEL PEN

PENNA GEL

STYLO À ENCRE GEL

BOLÍGRAFO DE GEL

GELSTIFT

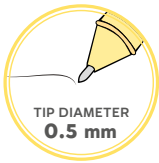

DISPLAY

material: PET and cardboard
L 10.8 x H 14 x W 10.7 cm

16 PCS

MELKIT2



BLACK INK

HELLO SUMMER

L 1.5 x H 16 x W 1 cm

GEL PEN

PENNA GEL

STYLO À ENCRE GEL

BOLÍGRAFO DE GEL

GELSTIFT

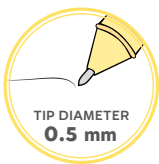

DISPLAY

material: PET and cardboard
L 10.8 x H 14 x W 10.5 cm

16 PCS

ICEKIT1



BLACK INK

HAPPINESS FOR EVERY DAY

Ø 0.6 cm, H 18.5 cm

SET OF 6 HB GRAPHITE PENCILS MADE FROM RECYCLED PAPER

- HB lead
- Every time you sharpen your pencil, you will get rainbow shavings

SET DI 6 MATITE HB IN CARTA RICICLATA

- Mina HB
- Temperando la matita si ottengono dei trucioli color arcobaleno

SET DE 6 CRAYONS À PAPIER HB EN PAPIER RECYCLÉ

- Mine HB
- En taillant le crayon, vous obtiendrez des copeaux couleur arc-en-ciel

SET DE 6 LÁPICES HB DE GRAFITO DE PAPEL RECICLADO

- Mina HB
- Al afilar el lápiz obtendrás virutas color arcoíris

SET MIT 6 HB-BLEISTIFTEN AUS RECYCLING-PAPIER

- HB-mine
- Beim Anspitzen des Bleistifts entstehen Späne in Regenbogenfarben



PACKAGING

cardboard box
L 4.8 x H 21.5 x W 1 cm



DISPLAY

material: cardboard
L 10.5 x H 25.5 x W 7.5 cm

12 PCS

RPSKIT1



LOVE AT FIRST WRITE

Ø 0.7 cm, H 18 cm

HEART-SHAPED PENCIL

- HB lead

MATITA A FORMA DI CUORE

- Mina HB

CRAYON EN FORME DE CŒUR

- Mine HB

LÁPIZ EN FORMA DE CORAZÓN

- Mina HB

BLEISTIFT IN HERZFORM

- HB-Mine

DISPLAY

material: cardboard
L 11.5 x H 23 x W 11 cm

24 PCS

HPKIT1

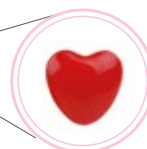

I USED TO BE A NEWSPAPER

Ø 0.7 cm, H 18.5 cm

PENCIL MADE FROM RECYCLED PAPER
• HB lead

MATITA IN CARTA RICICLATA
• Mina HB

CRAYON EN PAPIER RECYCLÉ
• Mine HB

LÁPIZ DE PAPEL RECYCLADO
• Mina HB

BLEISTIFT AUS RECYCLINGPAPIER
• HB-Mine

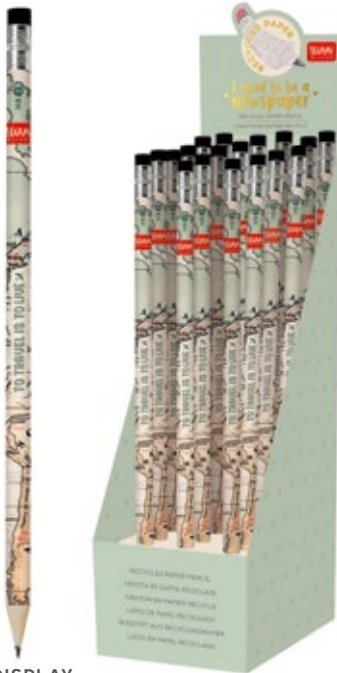

DISPLAY
material: cardboard
L 6 x H 24 x W 8.5 cm
18 PCS

TRAVEL
SCVKIT47



8 051128 756012



DISPLAY
material: cardboard
L 6 x H 24 x W 8.5 cm
18 PCS

GENIUS
SCVKIT50



8 051128 756029



DISPLAY
material: cardboard
L 6 x H 24 x W 8.5 cm
18 PCS

STARS
SCVKIT60



8 054117 621476



DISPLAY
material: cardboard
L 6 x H 24 x W 8.5 cm
18 PCS

BEE
SCVKIT68



8 054117 621490



DISPLAY
material: cardboard
L 6 x H 24 x W 8.5 cm
18 PCS

PANDA
SCVKIT69



8 054117 621513



DISPLAY
material: cardboard
L 6 x H 24 x W 8.5 cm
18 PCS

AVOCADO
SCVKIT70



8 054117 621537

SERIAL CHILLER

Ø 0.7 cm, H 18 cm

PENCIL WITH ERASER

- HB lead

MATITA CON GOMMA

- Mina HB

CRAYON AVEC GOMME

- Mine HB

LÁPIZ CON GOMA

- Mina HB

BLEISTIFT MIT RADIERGUMMI

- HB-Mine



DISPLAY

material: cardboard
L 15 x H 18 x W 14 cm

24 PCS

SLOKITI



8 051128 752137



KOALITY HUGS

Ø 0.7 cm, H 18 cm

PENCIL WITH SCENTED ERASER

- HB lead

MATITA CON GOMMA PROFUMATA

- Mina HB

CRAYON AVEC GOMME PARFUMÉE

- Mine HB

LÁPIZ CON GOMA PERFUMADA

- Mina HB

BLEISTIFT MIT RADIERGUMMI MIT DUFT

- HB-Mine



DISPLAY

material: cardboard
L 15 x H 18 x W 14 cm

24 PCS

KOAKITI



8 051128 754452



Vanilla



I LOVE BAMBOO

Ø 0.7 cm, H 18 cm

PENCIL WITH SCENTED ERASER

- HB lead

MATITA CON GOMMA PROFUMATA

- Mina HB

CRAYON AVEC GOMME PARFUMÉE

- Mine HB

LÁPIZ CON GOMA PERFUMADA

- Mina HB

BLEISTIFT MIT RADIERGUMMI MIT DUFT

- HB-Mine



DISPLAY

material: cardboard
L 15 x H 18 x W 14 cm

24 PCS

PANKITI



8 051128 752700



Vanilla



AFTER RAIN COMES THE RAINBOW

Ø 0.7 cm, H 19 cm

PENCIL WITH SCENTED ERASER

- HB lead

MATITA CON GOMMA PROFUMATA

- Mina HB

CRAYON AVEC GOMME PARFUMÉE

- Mine HB

LÁPIZ CON GOMA PERFUMADA

- Mina HB

BLEISTIFT MIT RADIERGUMMI MIT DUFT

- HB-Mine



DISPLAY

material: cardboard
L 15 x H 19 x W 14 cm

24 PCS

RAINKITI



Vanilla



UNICORN

Ø 0.7 cm, H 19 cm

PENCIL WITH ERASER

- HB lead

MATITA CON GOMMA

- Mina HB

CRAYON AVEC GOMME

- Mine HB

LÁPIZ CON GOMA

- Mina HB

BLEISTIFT MIT RADIERGUMMI

- HB-Mine



DISPLAY

material: cardboard
L 14 x H 19 x W 15 cm

24 PCS

UNIKITI



TO THE MOON AND BACK

Ø 0.7 cm, H 17.5 cm

STATIONERY SET

- Set of two scented erasers and an HB-lead pencil

SET DA SCRIVANIA

- Set di due gomme profumate e una matita con mina HB

SET DE PAPETERIE

- Set comprenant deux gommes parfumées et un crayon avec mine HB

SET DE ESCRITORIO

- Set de dos gomas perfumadas y un lápiz con mina HB

SCHREIBTISCHSET

- Set mit zwei Radiergummis mit duft und einem Bleistift mit HB-Mine

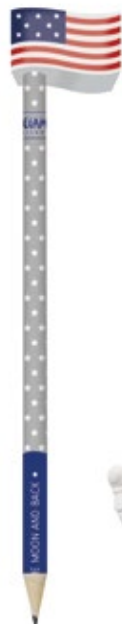

PACKAGING

carded
L 10 x H 22.6 x W 1.8 cm

Vanilla



DISPLAY

material: cardboard
L 11.5 x H 33.5 x W 22 cm

10 PCS

ASTROKIT1



LIFE IS BETTER IN...

Ø 1.2 cm, H 18 cm

JUMBO FLUORESCENT PENCIL

PASTELLO JUMBO FLUO

**CRAYON DE COULEUR
JUMBO FLUO**

**LÁPIZ JUMBO COLORES
FLUORESCENTES**

**FLUORESZIERENDER
JUMBO-BUNTSTIFT**

* While stock lasts



DISPLAY
material: PET
Ø 8 cm, H 17.5 cm
36 PCS

FLUKIT4 ORANGE *
8 051128 750683



JUMBO 2-COLOUR PENCIL

Ø 1 cm, H 17.5 cm

JUMBO 2-COLOUR PENCIL

PASTELLO JUMBO 2 COLORI

**CRAYON DE COULEUR
JUMBO BICOLORE**

LÁPIZ JUMBO 2 COLORES

ZWEIFARBIGER

FRONT

BACK

BLUE

RED



DISPLAY
material: PET
Ø 8 cm, H 17.5 cm
36 PCS

BIKIT7
8 051128 753080



BLACK PENCIL

Ø 1 cm, H 19.5 cm

PENCIL WITH ERASER

- HB lead

MATITA CON GOMMA

- Mina HB

CRAYON AVEC GOMME

- Mine HB

LÁPIZ CON GOMA

- Mina HB

BLEISTIFT MIT RADIERGUMMI

- HB-Mine



DISPLAY

material: PET
Ø 8 cm, H 19.5 cm

36 PCS

BPKIT1



OVER THE RAINBOW

Ø 1 cm, H 17.5 cm

**MULTICOLOUR PENCIL
CRAYON**

- 4-colour triangular pencil

PASTELLO MULTICOLORE

- Pastello triangolare
a 4 colori

CRAYON MULTICOLORE

- Crayon triangulaire
à 4 couleurs

LÁPIZ MULTICOLOR

- Lápiz triangular
de 4 colores

MULTICOLOUR-BUNTSTIFT

- Vierfarbiger Buntstift mit
dreieckigem Querschnitt

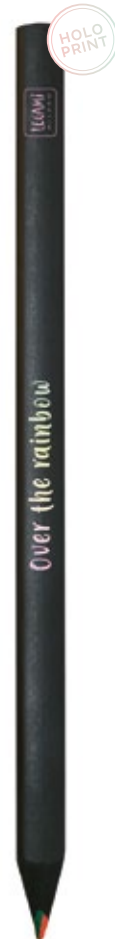

DISPLAY

material: PET
Ø 8 cm, H 17.5 cm

36 PCS

OVEKIT1



MEOW

Ø 1.2 cm, H 13 cm

MECHANICAL PENCIL

- Included HB lead 0.7 mm
- Ergonomic grip

PORTAMINE

- Mina 0,7 mm HB inclusa
- Impugnatura ergonomica

PORTE-MINE

- Mine 0,7 mm HB incluse
- Manche ergonomique

PORTAMINAS

- Mina HB de 0,7 mm incluida
- Mango ergonómico

MINENSCHREIBER

- Inklusive Mine 0,7 mm HB
- Ergonomischer Griff

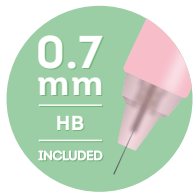

PACKAGING

carded
L 5.3 x H 18.5 x W 1.7 cm



DISPLAY

material: cardboard
L 12 x H 27.5 x W 19 cm

18 PCS

MEPEKIT1



Remove the cat's tail
to insert a new lead

MAGIC PENCIL

Ø 1 cm, H 18 cm (with cap)

MAGIC PENCIL

- Replaceable tip
- Cap and replacement tip included
- Material: graphite, metal

MATITA MAGICA

- Punta sostituibile
- Include una punta di ricambio e un cappuccio
- Materiale: grafite, metallo

CRAYON MAGIQUE

- Mine remplaçable
- Comprend une mine de rechange et un capuchon
- Matériau : graphite, métal

LÁPIZ MÁGICO

- Punta recambiable
- Incluye una punta de recambio y un tapón
- Material: grafito, metal

MAGISCHER BLEISTIFT

- Austauschbare Spitze
- Eine Ersatzspitze und eine Kappe inklusive
- Material: Graphit, Metall

PACKAGING

carded
L 8 x H 21.5 x W 1 cm



DISPLAY

material: cardboard
L 17 x H 27 x W 10.5 cm

12 PCS

NESKIT1



Writes 300 times more than a normal pencil



Easy to erase



No sharpening required

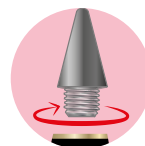

Replaceable tip

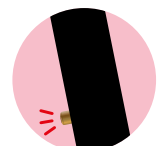

Metal insert to prevent rolling

LIVE COLOURFULLY

L 0.6 x H 17.6 x W 0.6 cm

SET OF 12 COLOURING PENCILS

- Durable lead
- Easy to sharpen
- Material: wood

SOLD X 6

PACKAGING

reusable PP box with hook
L 6 x H 15.2 x W 0.4 cm

SUNSET PALETTE

EV0001



SET DE 12 CRAYONS DE COULEUR

- Mine résistante
- Facile à tailler
- Matériau : bois

SET DE 12 LÁPICES DE COLORES

- Mina resistente
- Fáciles de afilar
- Material: madera

SET MIT 12 BUNTSTIFTEN

- Stabile Mine
- Sehr gut Anspitzfähig
- Material: Holz



PACKAGING

reusable PP box with hook
L 6 x H 15.2 x W 0.4 cm

OCEAN PALETTE

EV0002

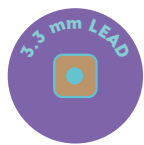

BRUSH MARKERS

Ø 1 cm, H 16.8 cm

SET OF 12 BRUSH MARKERS

- Flexible nylon fibre tip: for smooth lines and variable widths

SET DI 12 PENNARELLI CON PUNTA PENNELLO

- Punta flessibile in fibra di nylon: per tratti fluidi e larghezze variabili

SET DE 12 FEUTRES PINCEAUX

- Pointe flexible en fibre de nylon : pour des traits fluides et des largeurs variables

SET DE 12 ROTULADORES CON PUNTA DE PINCEL

- Punta flexible de fibra de nailon: para trazos fluidos y anchos variables

SET MIT 12 PINSELSTIFTEN

- Flexible Pinselspitze aus Nylonfaser: für saubere Striche mit unterschiedlicher Stärke

BRIGHT COLOURS



- | | | | | | | | | | | | |
|------|--------|------------|-------------|------------|-------------|------|--------|--------|-----|-------|-------|
| | | | | | | | | | | | |
| PINK | VIOLET | LIGHT BLUE | LIGHT GREEN | DARK GREEN | PETROL BLUE | BLUE | YELLOW | ORANGE | RED | BROWN | BLACK |

PACKAGING
reusable PP box w/hook
L 10 x H 19 x W 3 cm

SOLD X 6

BUMA0001



8 054320 561248



PASTEL COLOURS



- | | | | | | | | | | | | |
|-------|--------|-------|---------|-------|----------|-------|------|------|------------|------|-------|
| | | | | | | | | | | | |
| GREEN | YELLOW | PEACH | SKYBLUE | LILAC | SOFTPINK | CORAL | PINK | BLUE | AQUAMARINE | GREY | BEIGE |

PACKAGING
reusable PP box w/hook
L 10 x H 19 x W 3 cm

SOLD X 6

BUMA0002



8 052694 010423



TEDDY FRIENDS

Ø 1.4 cm, H 10.7 cm



SET OF 12 MARKERS

- Washable and non-toxic
- Anti-retraction tip for narrow and wide strokes

SET DI 12 PENNARELLI

- Lavabili e atossici
- Punta anti-rientro per tratti sottili e ampi

SET DE 12 FEUTRES

- Lavables et non toxiques
- Pointe bloquée pour des traits fins et larges

SET DE 12 ROTULADORES

- Lavables y no tóxicos
- Punta antirretracción para trazos sutiles y largos

SET MIT 12 FILZSTIFTEN

- Waschbar und ungiftig
- Eindrucksichere Spitze für schmale und breite Striche

PACKAGING

reusable PET box w/silicone handle
Ø 6.9 cm, H 15.5 cm
SOLD X 6

TDM0001



7 mm TIP



THIN & THICK LINES



WATER-BASED INK



NON-TOXIC



REUSABLE CASE



WASHABLE



BE BOLD



Ø 1.5 cm, H 14.5 cm

ACRYLIC MARKER

- Light-resistant
- Water-resistant. Guaranteed effect if left to dry for 4 hours
- Long-lasting
- Water-based pigment ink
- Suitable for most surfaces: paper, canvas, stone, glass, ceramic, plastic, fabric, wood, metal
- Non-toxic, odourless, clean lines with no smearing, does not bleed through paper

PENNARELLO ACRILICO

- Resistente alla luce
- Resistente all'acqua. Effetto garantito se lasciato asciugare 4 ore
- A lunga durata
- Inchiostro pigmentato a base d'acqua
- Adatto alla maggior parte delle superfici: carta, tela, pietra, vetro, ceramica, plastica, tessuto, legno, metallo
- Atossico, inodore, tratto preciso senza sbavature, non passa la carta

MARQUEUR ACRYLIQUE

- Résistant à la lumière
- Résistant à l'eau. Effet garanti après 4 heures de séchage
- Tenue longue durée
- Encre pigmentée à base d'eau
- Adapté à la plupart des surfaces : papier, toile, pierre, verre, céramique, plastique, tissu, bois, métal
- Non toxique, inodore, trait précis et sans bavure, ne traverse pas le papier

ROTULADOR ACRÍLICO

- Resistente a la luz
- Resistente al agua Efecto garantizado si se deja secar 4 horas
- De larga duración
- Tinta pigmentada a base de agua
- Apto para la mayoría de superficies: papel, lienzo, piedra, vidrio, cerámica, plástico, tejido, madera o metal
- No tóxico, inodoro, trazo preciso sin manchas, no traspasa el papel

ACRYLMARKER

- Lichtecht
- Wasserfest Für einen garantierten Effekt 4 Stunden trocknen lassen
- Langanhaltend
- Pigmentierte Tinte auf Wasserbasis
- Eignet sich für zahlreiche Oberflächen: Papier, Leinwand, Stein, Glas, Keramik, Plastik, Stoff, Holz, Metall
- Ungiftig, geruchlos, präzise ohne Verschmieren, färbt nicht durch

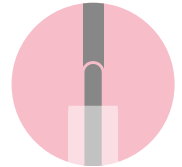

**ROUND TIP
LINE WIDTH:
0.9 - 2 mm**



**BLACK
ACMKIT1**

**WHITE
ACMKIT2**

**SILVER
ACMKIT3**

**GOLD
ACMKIT4**

**YELLOW
ACMKIT5**

**ORANGE
ACMKIT6**



DISPLAY
material:
cardboard
Ø 7 x H 15 cm
12 PCS



BE BOLD DISPLAY

Material: Cardboard
L 23,5 x H 26 X W 17 cm
12 pockets

**FULL ASSORTED DISPLAY
+ POP MATERIAL
1 KIT X DESIGN**

ACMPOP-GROUP



POP MATERIAL

WINDOWS DISPLAY
L 29,7 x H 42 cm

Order the full
assorted display
and you will receive
a window display.



Shake several
times

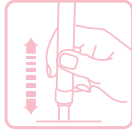

Press the tip onto
the paper several
times



Close lid tightly
and store
horizontally



RED
ACMKIT7



PINK
ACMKIT8



LILAC
ACMKIT9



AQUA
ACMKIT10



SKY BLUE
ACMKIT11



GREEN
ACMKIT12



3 IS BETTER THAN 1

Ø 3 cm, H 11 cm

3-IN-1 HIGHLIGHTER

• Material: plastic and TPE

EVIDENZIATORE 3 IN 1

• Materiale: plastica e TPE

SURLIGNEUR 3 EN 1

• Matériau : plastique et TPE

SUBRAYADOR 3 EN 1

• Material: plástico y TPE

TEXTMARKER 3 IN 1

• Material: Kunststoff und TPE



CHISEL TIP



WATER-BASED INK

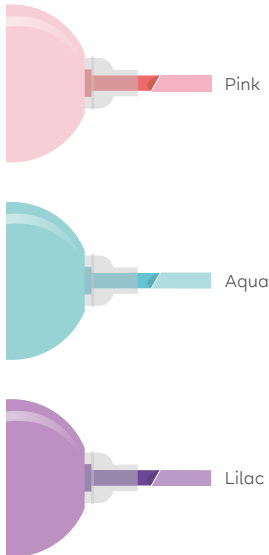

PACKAGING

PET box w/fabric loop
L 3 x H 11 x W 3 cm



DISPLAY

material: cardboard
L 14.2 x H 19.2 x W 11 cm

12 PCS

UNICORN
MUMAKIT1



8 051128 756746

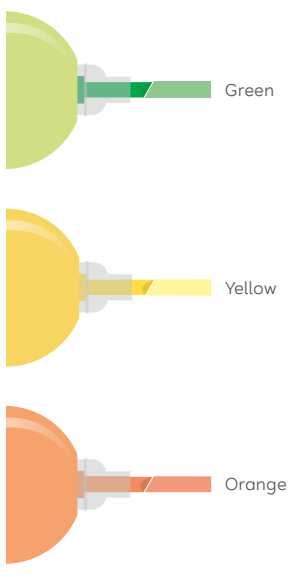

PACKAGING

PET box w/fabric loop
L 3 x H 11 x W 3 cm



DISPLAY

material: cardboard
L 14.2 x H 20 x W 11 cm

12 PCS

AVOCADO
MUMAKIT2



8 051128 756753



MEOW

L 1.3 x H 13.5 x W 1 cm

SET OF 6 DUAL-TIP PASTEL HIGHLIGHTERS

- Water-based ink
- Dual tip: 12 colours in total

SET DI 6 EVIDENZIATORI PASTELLO DOPPIA PUNTA

- Inchiostro a base di acqua
- Doppia punta: 12 colori in totale

SET DE 6 SURLIGNEURS PASTEL À DOUBLE POINTE

- Encre à l'eau
- Double pointe : 12 couleurs en tout

SET DE 6 SUBRAYADORES PASTEL DE DOBLE PUNTA

- Tinta a base de agua
- Doble punta: 12 colores en total

SET MIT 6 PASTELFARBENEN DOPPELSPITZEN-TEXTMARKERN

- Tinte auf Wasserbasis
- Zwei Spitzen: Insgesamt 12 Farben



PACKAGING
Window box
L 13.3 x H 18 x W 1.5 cm
SOLD X 6

MHL0001



CHISEL TIP



WATER-BASED INK

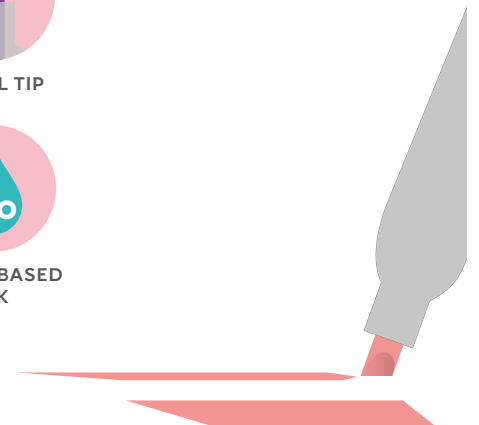

MAGIC HIGHLIGHTERS

Ø 1 cm, H 12.5 cm

SET OF 6 ERASABLE HIGHLIGHTERS

- Dual tip: 1 to highlight and 1 to erase

SET DI 6 EVIDENZIATORI CANCELLABILI

- A doppia punta: 1 per evidenziare e 1 per cancellare

SET DE 6 SURLIGNEURS EFFAÇABLES

- À double pointe : 1 pour surligner et 1 pour effacer

SET DE 6 SUBRAYADORES BORRABLES

- De doble punta: 1 para subrayar y 1 para borrar

SET MIT 6 LÖSCHBAREN TEXTMARKERN

- Mit zwei Spitzen: 1 zum Markieren und 1 zum Löschen

PACKAGING
window box
L 6.5 x H 15.5 x W 1.5 cm



CHISEL TIP

DISPLAY
material: cardboard
L 13.5 x H 22.6 x W 10 cm
12 PCS

EHKIT1



8 051128 756081

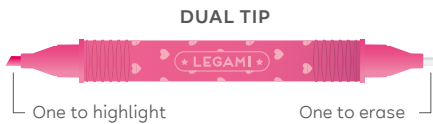

DUAL TIP

One to highlight

One to erase



YELLOW ORANGE PINK PURPLE LIGHT BLUE GREEN



CARRATE TEAM

Ø 2.7 cm, H 7.3 cm

SET OF 6 MINI HIGHLIGHTERS

SET DI 6 MINI EVIDENZIATORI

SET DE 6 MINI SURLIGNEURS

SET DE 6 MINI SUBRAYADORES

SET MIT 6 MINI-TEXTMARKERN

PACKAGING
window box
L 18 x H 11.6 x W 3 cm
SOLD X 6

HC0001



8 054117 628437



CHISEL TIP



PINK ORANGE YELLOW LILAC LIGHT GREEN LIGHT BLUE

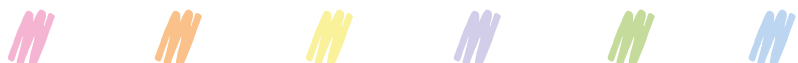

TEDDY'S MOOD

Ø 1 cm, H 7.5 cm

SET OF 6 MINI HIGHLIGHTERS

SET DI 6 MINI EVIDENZIATORI

SET DE 6 MINI SURLIGNEURS

SET DE 6 MINI SUBRAYADORES

SET MIT 6 MINI-TEXTMARKERN

PACKAGING

window box
L 6.8 x H 10.8 x W 1.2 cm



DISPLAY

material: cardboard
L 14 x H 17.2 x W 8 cm

12 PCS

MHKIT3



CHISEL TIP



PINK



PURPLE



LIGHT BLUE



GREEN



YELLOW



ORANGE



TEDDY'S STYLE

Ø 1 cm, H 7.5 cm

SET OF 6 MINI HIGHLIGHTERS

SET DI 6 MINI EVIDENZIATORI

SET DE 6 MINI SURLIGNEURS

SET DE 6 MINI SUBRAYADORES

SET MIT 6 MINI-TEXTMARKERN

PACKAGING

window box
L 6.8 x H 10.8 x W 1.2 cm



DISPLAY

material: cardboard
L 14 x H 17.2 x W 8 cm

12 PCS

MHKIT4



CHISEL TIP



YELLOW



PEACH



PINK



LILAC



LIGHT BLUE



LIGHT GREEN



PANTASTIC ERASER

L 1.7 x H 5 x W 1.5 cm

SCENTED ERASER

GOMMA PROFUMATA

GOMME PARFUMÉE

GOMA PERFUMADA

RADIERGUMMI MIT DUFT



PACKAGING
paper sleeve



DISPLAY

material: cardboard
L 11.2 x H 10 x W 9.6 cm

25 PCS

PANDA

GPKIT4



JELLY FRIENDS

L 2.2 x H 5 x W 1.6 cm

SCENTED ERASER

GOMMA PROFUMATA

GOMME PARFUMÉE

GOMA PERFUMADA

RADIERGUMMI MIT DUFT



PACKAGING
paper sleeve

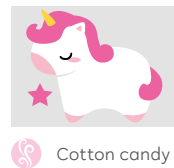

DISPLAY

material: cardboard
L 13.6 x H 10.5 x W 10.5 cm

36 PCS

UNICORN

GPKIT1



PACKAGING
paper sleeve

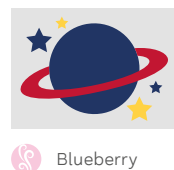

DISPLAY

material: cardboard
L 13.6 x H 10.5 x W 10.5 cm

36 PCS

SPACE

GPKIT2



PACKAGING
paper sleeve



DISPLAY

material: cardboard
L 13.6 x H 10.5 x W 10.5 cm

36 PCS

DINO

GPKIT3



FREE HUGS

L 3 x H 5 cm

SET OF 5 SCENTED ERASERS

SET DI 5 GOMME PROFUMATE

SET DE 5 GOMMES PARFUMÉES

SET DE 5 GOMAS PERFUMADAS

SET MIT 5 RADIERGUMMIS MIT DUFT

PACKAGING

window box
L 15.7 x H 7 x W 2.5 cm

SOLD X 6

CE0002



8 054117 628529



🌸 Strawberry

YUMMY YUMMY

L 2.7 x H 6 x W 2.8 cm

SET OF 3 SCENTED ERASERS

SET DI 3 GOMME PROFUMATE

SET DE 3 GOMMES PARFUMÉES

SET DE 3 GOMAS PERFUMADAS

SET MIT 3 RADIERGUMMIS MIT DUFT

PACKAGING

PET box w/fabric loop
L 8.5 x H 6 x W 3 cm

SOLD X 12

ERA0001



8 052461 964324



🌸 Grapes

🌸 Strawberry

🌸 Vanilla



OOPS!

Ø 1.4 cm, H 12.8 cm

ERASER PEN

GOMMA A FORMA DI PENNA

STYLO GOMME

PORTAGOMAS

RADIERSTIFT



DISPLAY
material: cardboard
L 7 x H 19.6 x W 13.5 cm
10 PCS

TRAVEL
ERPKIT1



8 051128 755732



Blueberry



DISPLAY
material: cardboard
L 7 x H 19.6 x W 13.5 cm
10 PCS

FLORA
ERPKIT2



8 051128 755749



Vanilla



DISPLAY
material: cardboard
L 7 x H 19.6 x W 13.5 cm
10 PCS

PANDA
ERPKIT3



8 051128 755756



Cotton candy



DISPLAY
material: cardboard
L 7 x H 19.6 x W 13.5 cm
10 PCS

SPACE
ERPKIT4



8 051128 755763



Blueberry



XOXO

Ø 2 cm, H 7.2 cm

SCENTED ERASER

GOMMA PROFUMATA

GOMME PARFUMÉE

GOMA PERFUMADA

RADIERGUMMI MIT DUFT



PANDA
Strawberry

DISPLAY
material: cardboard
L 8 x H 16 x W 17.5 cm
36 PCS

LIPKITPAN



8 051128 752335



UNICORN
Strawberry

DISPLAY
material: cardboard
L 8 x H 16 x W 17.5 cm
36 PCS

LIPKITUNI



8 051128 752328



MEOW

L 4.5 x H 4 x W 4.5 cm

SCENTED ERASER

GOMMA PROFUMATA

GOMME PARFUMÉE

GOMA PERFUMADA

RADIERGUMMI MIT DUFT

DISPLAY
material: PET
Ø 11.5 cm, H 16 cm
32 PCS

KTYKIT1

8 051128 756968



Strawberry

LET'S AVOCUDDLE

L 5 x H 3.7 x W 2 cm

ERASER

GOMMA

GOMME

GOMA

RADIERGUMMI

DISPLAY
material: PET
Ø 12 cm, H 14.5 cm
32 PCS

AVOKITI

8 051128 755411



WALNUT ERASER

L 4.5 x H 3 cm

ERASER

GOMMA

GOMME

GOMA

RADIERGUMMI

DISPLAY
material: PET
Ø 12 cm, H 14.5 cm
24 PCS

WALKIT4

8 051128 751444



FOOTBALL ERASER

Ø 3.5 cm

SCENTED ERASER

GOMMA PROFUMATA

GOMME PARFUMÉE

GOMA PERFUMADA

RADIERGUMMI MIT DUFT

DISPLAY
material: PET
Ø 12 cm, H 14.5 cm
32 PCS

FTBKITI

8 051128 750058



Vanilla

SOLAR SYSTEM

Ø MIN 0.8 cm - Ø MAX 3.5 cm

SET OF 9 ERASERS

SET DI 9 GOMME

SET DE 9 GOMMES

SET DE 9 GOMAS

SET MIT 9 RADIERGUMMIS

PACKAGING

carded

Ø 16.5 cm, W 2.5 cm

SOLD X 6

SES0001

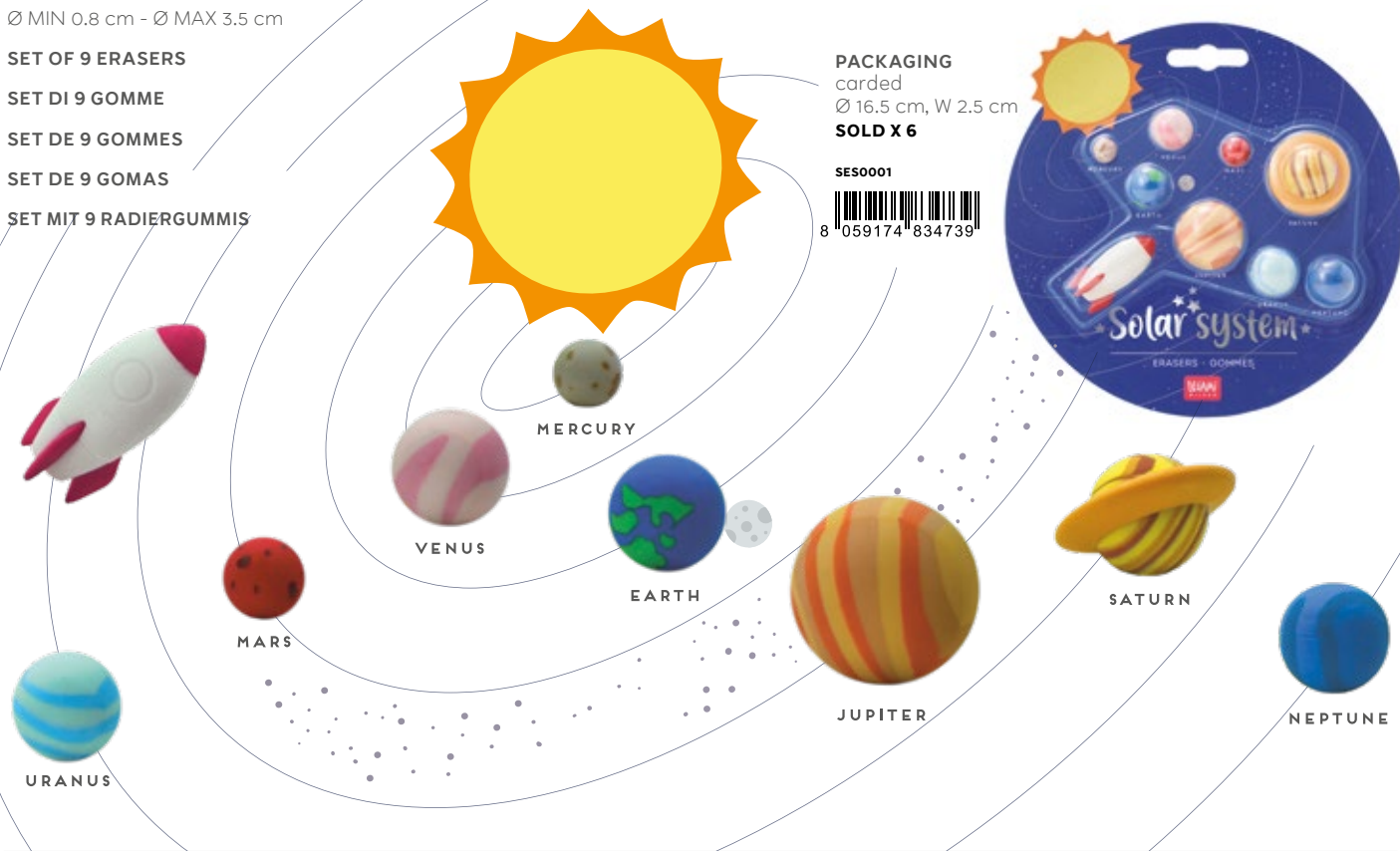

LOVE DISPENSER

L 4.5 x H 9.5 x W 4.5 cm

MINI ERASER DISPENSER

- 15 erasers with assorted graphics
- Material: TPR erasers, ABS distributor, PC clear container

MINI DISTRIBUTORE DI GOMME PER CANCELLARE

- 15 gomme con grafiche assortite
- Materiale: gomma in TPR, distributore in ABS, contenitore trasparente in PC

MINI DISTRIBUTEUR DE GOMMES

- 15 petites gommes aux motifs assortis
- Matériau : gomme en TPR, distributeur en ABS, réservoir transparent en PC

MINI DISPENSADOR DE GOMAS DE BORRAR

- 15 gomas con gráficos variados
- Material: gomas de TPR, dispensador de ABS, recipiente transparente de PC

MINI-RADIERGUMMISPENSER

- 15 Radiergummis mit verschiedenen Grafiken
- Material: Radiergummis aus TPR, Spender aus ABS, durchsichtiger Behälter aus PC



Turn the handle...



Discover the romantic message!



You can even refill the container

PACKAGING

carded

L 9 x H 22 x W 0.5 cm

SOLD X 12

MED0001



15 ERASERS

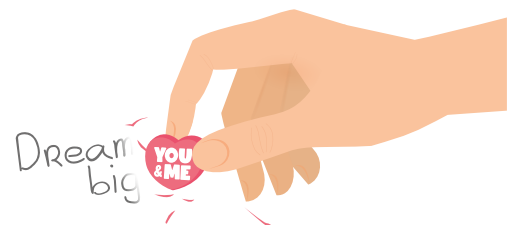

DREAM BIG

L 6 x H 10 x W 10 cm

DESKTOP PENCIL SHARPENER

- With container

TEMPERAMATITE A MANOVELLA

- Con contenitore

TAILLE-CRAYON À MANIVELLE

- Avec réservoir

SACAPUNTAS DE MANIVELA

- Con depósito

ANSPITZER MIT HANDKURBEL

- Mit Behälter



PACKAGING

cardboard box
L 10.5 x H 11 x W 6.5 cm

SOLD X 4

US0001



TO THE MOON AND BACK

L 8 x H 9.5 x W 8.5 cm

DESKTOP PENCIL SHARPENER

- Adjustable sharpening, removable tray

TEMPERAMATITE A MANOVELLA

- Affilatura regolabile, vassoio estraibile

TAILLE-CRAYON À MANIVELLE

- Aiguisage réglable, plateau amovible

SACAPUNTAS DE MANIVELA

- Afilado regulable, bandeja extraíble

ANSPITZER MIT HANDKURBEL

- Einstellbares Anspitzen, abnehmbares Behältnis



PACKAGING

cardboard box
L 8.5 x H 9.5 x W 8 cm

SOLD X 4

PSA0001

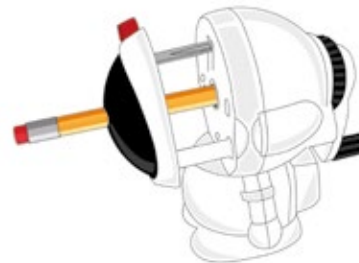

CAMERA PENCIL SHARPENER

L 7 x H 10 x W 11.5 cm

DESKTOP PENCIL SHARPENER

- Adjustable sharpening, removable tray

TEMPERAMATITE A MANOVELLA

- Affilatura regolabile, vassoio estraibile

TAILLE-CRAYON À MANIVELLE

- Aiguisage réglable, plateau amovible

SACAPUNTAS DE MANIVELA

- Afilado regulable, bandeja extraíble

ANSPITZER MIT HANDKURBEL

- Einstellbares Anspitzen, abnehmbares Behältnis



PACKAGING

cardboard box
L 11.8 x H 11 x W 7.2 cm

SOLD X 4

CPS0001

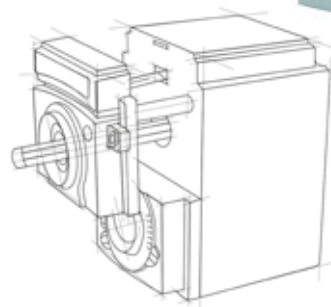

MEOW

L 4.5 x H 7 x W 3 cm

PENCIL SHARPENER WITH CONTAINER

- With two different sized holes

TEMPERINO CON CONTENITORE

- Con due fori di diverso diametro

TAILLE-CRAYONS AVEC RÉSERVOIR

- Avec deux trous de diamètre différent

SACAPUNTAS CON DEPÓSITO

- Con dos orificios de distinto diámetro

ANSPITZER MIT BEHÄLTER

- Mit zwei Löchern mit unterschiedlichem Durchmesser



DISPLAY
material: cardboard
L 14 x H 13.5 x W 12.7 cm
12 PCS

PSCATKIT1



LE TOUR DU MONDE

Ø 4.5 cm, H 5.5 cm

PENCIL SHARPENER

TEMPERINO

TAILLE-CRAYON

SACAPUNTAS

ANSPITZER

PACKAGING
cardboard box
L 4.5 x H 5.5 x W 4.5 cm



DISPLAY
material: cardboard
L 14.5 x H 18 x W 19 cm
12 PCS

TOURKIT1



ROARR

L 4.5 x H 5 x W 3 cm

PENCIL SHARPENER

TEMPERINO

TAILLE-CRAYON

SACAPUNTAS

ANSPITZER

DISPLAY
material: cardboard
L 20 x H 13 x W 15 cm
12 PCS

DINKIT1



LET'S AVOCUDDLE

L 4 x H 5.7 x W 3 cm

PENCIL SHARPENER WITH ERASER

TEMPERINO CON GOMMA

TAILLE-CRAYON AVEC GOMME

SACAPUNTAS CON GOMA

ANSPITZER MIT RADIERGUMMI

PACKAGING

cardboard box
L 4.2 x H 6 x W 3.3 cm



DISPLAY

material: cardboard
L 13.5 x H 15.5 x W 13.5 cm

12 PCS

PSAVOKIT1



MAGIC MUSHROOM

Ø 4.5 cm, H 5 cm

PENCIL SHARPENER WITH ERASER

TEMPERINO CON GOMMA

TAILLE-CRAYON AVEC GOMME

SACAPUNTAS CON GOMA

ANSPITZER MIT RADIERGUMMI

PACKAGING

cardboard box
L 5 x H 5.5 x W 5 cm



DISPLAY

material: cardboard
L 15.5 x H 17 x W 20.5 cm

12 PCS

MUSKIT12



TO THE MOON AND BACK

L 3 x H 6.4 x W 3 cm

PENCIL SHARPENER WITH ERASER

TEMPERINO CON GOMMA

TAILLE-CRAYON AVEC GOMME

SACAPUNTAS CON GOMA

ANSPITZER MIT RADIERGUMMI



PACKAGING

cardboard box
L 4.2 x H 6.5 x W 3.3 cm



DISPLAY

material: cardboard
L 13.5 x H 16.2 x W 13.5 cm

12 PCS

PSROKIT1



Blueberry



UNICORN SLURP

Ø 3 cm, H 6.5 cm

CORRECTION TAPE

- Excellent coverage
- Can be written on immediately
- Material: plastic

CORRETTORE A NASTRO

- Altamente coprente
- Subito riscrivibile
- Materiale: plastica

ROULEAU CORRECTEUR

- Parfaitement couvrant
- Réécriture immédiate
- Matériau : plastique

CINTA CORRECTORA

- Gran cobertura
- Se puede volver a escribir de inmediato
- Material: plástico

KORREKTUR-ROLLER

- Hochdeckend
- Sofort überschreibbar
- Material: Kunststoff

PACKAGING

carded
L 7,3 x H 12,5 x W 3,5 cm



DISPLAY

material: cardboard
L 15,7 x H 20,5 x W 15 cm
8 PCS

CTICEKIT1



MEOW

L 2.7 x H 5.8 x W 1.5 cm

CORRECTION TAPE

- Excellent coverage
- Can be written on immediately
- Material: plastic

CORRETTORE A NASTRO

- Altamente coprente
- Subito riscrivibile
- Materiale: plastica

ROULEAU CORRECTEUR

- Parfaitement couvrant
- Réécriture immédiate
- Matériau : plastique

CINTA CORRECTORA

- Gran cobertura
- Se puede volver a escribir de inmediato
- Material: plástico

KORREKTUR-ROLLER

- Hochdeckend
- Sofort überschreibbar
- Material: Kunststoff

PACKAGING

carded
L 6 x H 11 x W 1.7 cm



DISPLAY

material: cardboard
L 13,3 x H 16,5 x W 10 cm
12 PCS

CTCATKIT1 *



* While stock lasts

DECO TAPE

L 2.7 x H 11.5 x W 2 cm

DECORATION TAPE PEN

- Refillable: includes 2 decorative tapes (4 m x 6 mm) with different designs on a transparent background
- Retractable tip
- Material: plastic

PENNA A NASTRO PER DECORAZIONE

- Ricaricabile: include 2 nastri decorativi (4 m x 6 mm) con disegni differenti su sfondo trasparente
- Punta retrattile a scatto
- Materiale: plastica

STYLO DE RUBAN DÉCORATIF

- Rechargeable : 2 rubans décoratifs (4 m x 6 mm) avec des motifs différents sur fond transparent sont inclus
- Pointe rétractable grâce au bouton poussoir
- Matériau : plastique

BOLÍGRAFO CON CINTA PARA DECORAR

- Recargable: incluye 2 cintas decorativas (4 m x 6 mm) con diferentes diseños sobre un fondo transparente
- Punta retráctil a presión
- Material: plástico

DEKOBAND-STIFT

- Nachfüllbar: Enthält 2 Dekobänder (4 m x 6 mm) mit unterschiedlichen Designs auf transparentem Untergrund
- Spitze einziehbar per Schnappmechanismus
- Material: Kunststoff

8 m
2 X 4 m



2 DIFFERENT DESIGNS

PACKAGING
carded
L 8.5 x H 18.5 x
W 2.3 cm



DISPLAY
material: cardboard
L 19.5 x H 29 x W 16 cm
12 PCS



Click



Decorate



Change

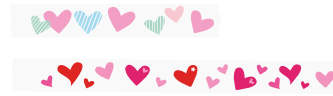

PENCIL CASES

CUTE!

L 20 x H 5 x W 3 cm

SOFT SILICONE PENCIL CASE

- Capacity: about 10 pens
- Dual use: opens up completely or opens up partially thanks to the silicone zip stopper flaps

ASTUCCIO IN MORBIDO SILICONE

- Capacità: circa 10 penne
- Doppio utilizzo: si apre completamente oppure si apre parzialmente grazie alle alette ferma cerniera in silicone

TROUSSE EN SILICONE SOUPLE

- Capacité : environ 10 stylos
- Double utilisation : elle peut s'ouvrir complètement ou partiellement, grâce aux ailettes en silicone de blocage de la fermeture éclair

ESTUCHE DE SILICONA BLANDA

- Capacidad: 10 bolígrafos aproximadamente
- Doble uso: se abre completamente o se abre parcialmente gracias a las aletas de bloqueo en silicona de la cremallera

FEDERMÄPPCHEN AUS WEICHEM SILIKON

- Bietet Platz für: ca. 10 Stifte
- Doppelte Verwendung: vollständige Öffnung oder teilweise Öffnung dank der Silikonflügel, die als Reißverschluss-Stopper dienen

PACKAGING
PET box w/hook
L 24.5 x H 5 x W 3 cm
SOLD X 4



Pens not included



Opens up partially thanks to the silicone zip stopper flaps



Opens up completely



PCS0002 AQUA



8 051739 306972



PCS0003 LILAC



8 051739 306989



PCS0004 PETROL BLUE



8 059174 833114

KAWAII

Ø 6.3 cm, H 18.5 cm

2-IN-1 SOFT SILICONE PENCIL CASE

- Dual use: pencil case and desktop pen holder
- Material: silicone

ASTUCCIO 2 IN 1 IN MORBIDO SILICONE

- Doppio utilizzo: astuccio e portapenne da tavolo
- Materiale: silicone

TROUSSE EN SILICONE SOUPLE 2-EN-1

- Double utilisation : trousse et pot à crayons de table
- Matériau : silicone

ESTUCHE DE SILICONA SUAVE 2 EN 1

- Doble uso: estuche y lapicero de mesa
- Material: silicona

2-IN-1 FEDERMÄPPCHEN AUS WEICHEM SILIKON

- Doppelte Verwendung: Federmäppchen und Stiftebox für den Tisch
- Material: Silikon

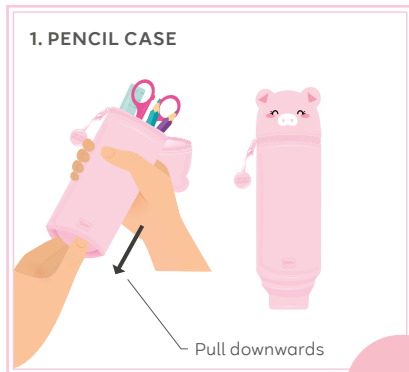

2-IN-1

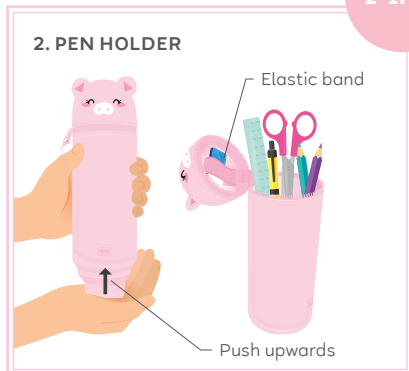

Pens not included



PANDA
KA0001



8 054117 620264



PIGGY
KA0002



8 054117 620271



TEDDY BEAR
KA0003



8 054117 620288





POP MATERIAL

WINDOWS DISPLAY
L 38 x H 44 cm

Order 4 pcs of each design and you will receive a window display

KAPOP-GROUP



PACKAGING

PET box w/hook
L 7.2 x H MAX 24 x W MAX 6.5 cm
SOLD X 4



UNICORN
KA0005



DINO
KA0006



BUNNY
KA0007



KITTY
KA0009



PENGUIN
KA0015



PENCIL CASE

L 19.5 x H 5.5 x W 5.5 cm

TRANSPARENT PENCIL CASE

- Zip closure
- Material: transparent TPU

ASTUCCIO TRASPARENTE

- Chiusura a zip
- Materiale: TPU trasparente

TROUSSE TRANSPARENTE

- Fermeture éclair
- Matériau : TPU transparente

ESTUCHE TRANSPARENTE

- Cierre con cremallera
- Material: TPU transparente

TRANSPARENTES FEDERMÄPPCHEN

- Reißverschluss
- Material: transparentes TPU

SOLD X 4



STARS
PC0019



PANDA
PC0023



TRAVEL
PC0024



FLOWERS
PC0025



KITTY
PC0026



GENIUS
PC0027



MY PENCIL CASE

L 22 x H 6 x W 6 cm

PENCIL CASE

- Zip closure
- Metal zip pull
- Material: RPET, polyester

TROUSSE

- Fermeture éclair
- Tirette en métal
- Matériau : RPET, polyester

FEDERMÄPPCHEN

- Reißverschluss
- Schiffchen aus Metall
- Material: RPET, Polyester

ASTUCCIO

- Chiusura a zip
- Puller in metallo
- Materiale: RPET, poliestere

ESTUCHE

- Cierre con cremallera
- Tirador de metal
- Material: RPET, poliéster

* While stock lasts

SOLD X 4



MAGIC
SPC0001



FLOWERS
SPC0002



FLASH
SPC0003



GENIUS
SPC0005



PETROL BLUE
SPC0006



BLACK
SPC0007



MY BACKPACK

BACKPACK

- Protective padded compartment for laptops max. 15" and tablets of similar dimensions
- Main compartment with zip closure and two zip pulls
- Side pocket for bottles. Front pocket with zip
- Padded shoulder straps, adjustable straps
- Padded base
- Material: RPET, polyester

ZAINO

- Scoperto protettivo e imbottito per laptop max 15" e tablet di simili dimensioni
- Scoperto principale con chiusura a zip e due puller
- Tasca laterale per borraccia. Tasca frontale con zip
- Spallacci imbottiti, cinghie regolabili
- Fondo imbottito
- Materiale: RPET, poliester

SAC À DOS

- Compartiment de protection matelassé pour ordinateur portable max 15" et tablette de la même dimension
- Compartiment principal doté d'une fermeture éclair et de deux tirettes
- Poche latérale pour une gourde. Poche avant avec fermeture éclair
- Bretelles matelassées, sangles réglables
- Fond matelassé
- Matériau : RPET, polyester

MOCHILA

- Compartimento protector y acolchado para portátil de hasta 15" y tablet de dimensiones similares
- Compartimento principal con cierre y dos tiradores
- Bolsillo lateral para cantimplora. Bolsillo frontal con cremallera
- Tirantes acolchados, correas ajustables
- Fondo acolchado
- Material: RPET, poliéster

RUCKSACK

- Das gepolsterte Laptop-Fach schützt Laptops bis 15 Zoll und Tablets in ähnlichen Größen
- Hauptfach mit Reißverschluss und zwei Schlfchen
- Seitentasche für Trinkflasche. Tasche auf der Vorderseite mit Reißverschluss
- Gepolsterte Schultergurte, verstellbare Riemen
- Gepolsterter Boden
- Material: RPET, Polyester



SOLD X 2



FLASH
BPK0003



PETROL BLUE
BPK0006



BLACK
BPK0007



Pens not included

DESK FRIENDS

L MAX 12.5 x H MAX 15 x W MAX 12 cm

CERAMIC PEN HOLDER

• Material: ceramic

PORTAPENNE IN CERAMICA

• Materiale: ceramica

POT À CRAYONS EN CÉRAMIQUE

• Matériau : céramique

PORTALÁPICES DE CERÁMICA

• Material: cerámica

STIFTEHALTER AUS KERAMIK

• Material: Keramik



PACKAGING

window box

L MAX 15.5 x H MAX 16.5 x W MAX 13.5 cm

SOLD X 2



SPACE
PHS0001



SHARK
PHS0002



CACTUS
PHS0003



SLOTH
PHS0004



DINO
PHS0005



RAINBOW
PHS0006



PANDA
PHS0007



CALENDAR AND DESK TIDY

L 12 x H 6 x W 7.5 cm

CALENDAR AND DESK TIDY

- Multi-purpose: perpetual calendar, base for phone, pen holder and business card holder
- Material: beechwood

CALENDARIO E PORTAOGGETTI DA SCRIVANIA

- Multiuso: calendario perpetuo, base per telefono, porta penna e porta biglietti da visita
- Materiale: legno di faggio

CALENDRIER ET ORGANISATEUR DE BUREAU

- Multifonctions : calendrier perpétuel, base pour téléphone portable, porte-stylo et porte-cartes de visite
- Matériau : bois de hêtre

CALENDARIO Y SOPORTE PARA OBJETOS DE ESCRITORIO

- Multiuso: calendario perpetuo, base para teléfono, soporte para bolígrafo y tarjetas de visita
- Material: madera de haya

SCHREIBTISCHKALENDER UND -BOX

- Vielzweckartikel: ewiger Kalender, Basis für das Telefon, Stifthalter und Visitenkartenhalter
- Material: Buchenholz



PACKAGING

cardboard box
L 12.5 x H 6.2 x W 8 cm
SOLD X 3

WOOD0001



Smartphone, pen and cards not included



BINDER CLIPS - MEDIUM

L 3.3 x H 4 cm

SET OF 6 METAL CLIPS

SET DI 6 CLIP IN METALLO

SET DE 6 CLIPS EN MÉTAL

SET DE 6 PINZAS DE METAL

SET MIT 6 METALLCLIPS

PACKAGING

cello sleeve w/cardboard
L 9 x H 21 cm

SOLD X 6

BCLIM0001

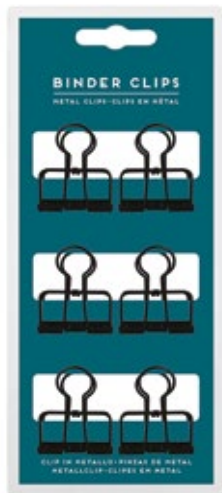

BINDER CLIPS - LARGE

L 5 x H 6.5 cm

SET OF 3 METAL CLIPS

SET DI 3 CLIP IN METALLO

SET DE 3 CLIPS EN MÉTAL

SET DE 3 PINZAS DE METAL

SET MIT 3 METALLCLIPS

PACKAGING

cello sleeve w/cardboard
L 9 x H 21 cm

SOLD X 6

BCLIL0001

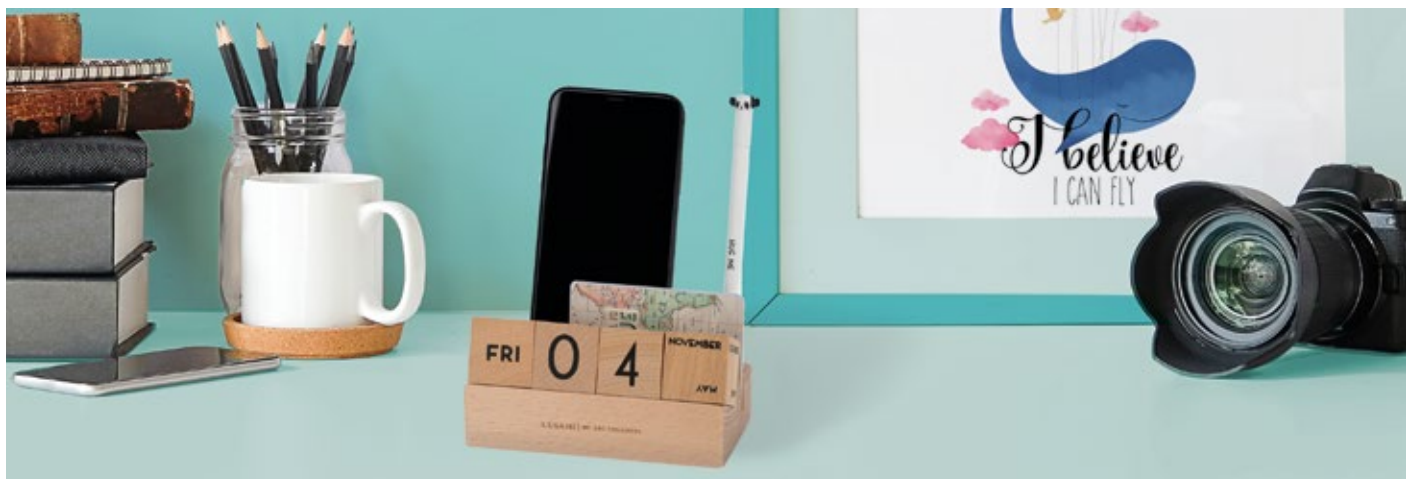
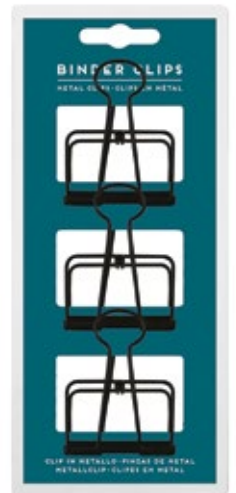

CALCOOLATOR

L 6 x H 12.5 x W 1.3 cm

CALCULATOR

- Two-way-power system: provides power even when there is no light
- Material: plastic

CALCOLATRICE

- Sistema Two-way-power: fornisce energia anche in situazioni di assenza di luce
- Materiale: plastica

CALCULATRICE

- Système d'alimentation Two-way-power : système en mesure d'alimenter la calculatrice même en l'absence de lumière
- Matériau : plastique

CALCULADORA

- Sistema Two-way-power: proporciona energia incluso en ausencia de luz
- Material: plástico

TASCHENRECHNER

- Die duale Stromversorgung stellt sicher, dass der Taschenrechner auch ohne Licht funktioniert
- Material: Kunststoff



1 x LR1130 battery (included)



PACKAGING
PVC box w/hook
L 6.5 x H 15 x W 1.5 cm



DISPLAY
material: cardboard
L 7 x H 22 x W 13.5 cm
8 PCS

FLORA
CAKIT1



PACKAGING
PVC box w/hook
L 6.5 x H 15 x W 1.5 cm



DISPLAY
material: cardboard
L 7 x H 22 x W 13.5 cm
8 PCS

GENIUS
CAKIT3



MAGICAL SHINE

Ø 2.3 cm, H 9.5 cm - 15 g

GLITTER GLUE STICK

- Water based
- Material: plastic

COLLA STICK CON GLITTER

- A base d'acqua
- Materiale: plastica

BÂTON DE COLLE À PAILLETES

- À base d'eau
- Matériau : plastique

PEGAMENTO EN BARRA CON PURPURINA

- A base de agua
- Material: plástico

KLEBESTIFT MIT GLITTER

- Auf Wasserbasis
- Material: Kunststoff



DISPLAY

material: cardboard
L 15 x H 10 x W 10 cm
24 PCS

GLUKIT2



HUG ME

Ø 2 cm, H 8.3 cm - 9 g

GLUE STICK

- Water based
- Material: plastic

COLLA STICK

- A base d'acqua
- Materiale: plastica

BÂTON DE COLLE

- À base d'eau
- Matériau : plastique

PEGAMENTO EN BARRA

- A base de agua
- Material: plástico

KLEBESTIFT

- Auf Wasserbasis
- Material: Kunststoff



DISPLAY

material: cardboard
L 14.2 x H 15 x W 9.5 cm
24 PCS

GLUKIT1



MEOW

L 2 x H 10 x W 1.8 cm

GLUE TAPE

- Adhesive tape with honeycomb structure, 3 metres long per side
- Material: plastic

COLLA A NASTRO

- Nastro adesivo con struttura a nido d'ape lungo 3 metri per lato
- Materiale: plastica

ROLLER DE COLLE

- Ruban adhésif avec structure en nid d'abeille de 3 mètres de long par côté
- Matériau : plastique

PEGAMENTO EN CINTA

- Cinta adhesiva con estructura de panel de abeja con una longitud de 3 metros por lado
- Material: plástico

KLEBEROLLER

- Kleberoller mit Wabenstruktur, Länge 3 Meter auf jeder Seite
- Material: Kunststoff

PACKAGING

carded
L 6.5 x H 16.5 x W 1.9 cm



DISPLAY

material: cardboard
L 14.5 x H 22 x W 10.5 cm
12 PCS

GLCATKIT1



Clean application



Solvent-free



Strong and permanent adhesion

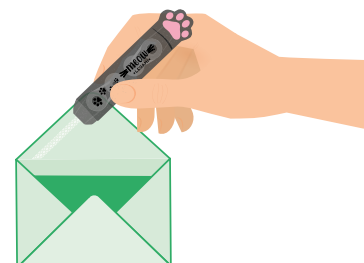

MINI STATIONERY SET

MINI STATIONERY SET

- The set includes 6 mini accessories: scissors, eraser, pagemarkers, adhesive tape with dispenser, stapler and staples

MINI SET DI CANCELLERIA

- Il set include 6 accessori in formato mini: forbici, gomma, segnapagina, nastro adesivo con dispenser, cucitrice e punti metallici

MINI SET DE PAPETERIE

- Le set comprend 6 accessoires de bureau en format mini : ciseaux, gomme, marque-pages, ruban adhésif avec dérouleur, agrafeuse et agrafes

MINI SET DE PAPELERÍA

- El set incluye 6 accesorios en formato mini: tijeras, goma, marcapáginas, cinta adhesiva con dispensador, grapadora y grapas

MINI-SCHREIBWARENSET

- Das Set enthält 6 Accessoires im Miniformat: Schere, Radiergummi, Seitenmarkierer, Klebeband mit Abrollgerät, Heftzange und Heftklammern

PACKAGING

reusable PP box w/hook
L 7 x H 10,5 x W 3 cm

DISPLAY

material: cardboard
L 9 x H 20 x W 18,5 cm

6 PCS

SETKIT1



Suitable for No. 10 staples



PACKAGING

reusable PP box w/hook
L 9,2 x H 10,2 x W 2,6 cm

DISPLAY

material: cardboard
L 11 x H 19,5 x W 18,5 cm

6 PCS

SETKIT2



Suitable for No. 10 staples



FOLLOW THE SKYLINE

L 20 x H MAX 5 cm

RULER

• Material: acrylic

RIGHELLO

• Materiale: acrilico

RÈGLE

• Matériau : acrylique

REGLA

• Material: acrílico

LINEAL

• Material: Acryl

✳ While stock lasts



PACKAGING

cello sleeve
w/cardboard
L 22.5 x H 7 cm



DISPLAY

material: cardboard
L 24 x H 9 x W 5.5 cm
12 PCS



ITALY



BERGAMO

SRKIT3



8 051128 752793



FIRENZE

SRKIT4



8 051128 752809



MILANO

SRKIT5 ✳



8 051128 752816



ROMA

SRKIT6



8 051128 752823



TORINO

SRKIT7



8 051128 752830



VENEZIA

SRKIT8



8 051128 752847



VERONA

SRKIT9



8 051128 752854



COMO

SRKIT14



8 051128 753165



NAPOLI

SRKIT15



8 051128 753172

WORLD



BARCELONA

SRKIT11



8 051128 752878



ISTANBUL

SRKIT17



8 051128 753196



LISBOA

SRKIT18



8 051128 753202

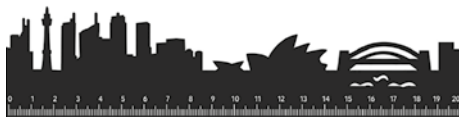

SYDNEY

SRKIT19



8 051128 753219



WIEN

SRKIT20



8 051128 753226

MEOW

L 15 cm

RULER

- Material: plastic

RIGHELLO

- Materiale: plastica

RÈGLE

- Matériau : plastique

REGLA

- Material: plástico

LINEAL

- Material: Kunststoff

**PACKAGING**

cello sleeve
w/cardboard
L 3 x H 21 x W 0.5 cm

**DISPLAY**

material: PET
Ø 9 cm, H 21 cm
20 PCS

RUCATKIT1

8 051128 755299

**BIBBIDI-BOBBIDI-BOO**

L 30 cm

ACRYLIC RULER**RIGHELLO IN ACRILICO****RÈGLE EN ACRYLIQUE****REGLA EN ACRÍLICO****LINEAL AUS ACRYL**

* While stock lasts

DISPLAY

material: PET
Ø 7.5 cm, H 14 cm
20 PCS

ARLKIT1

8 051128 752762

**FOLDING RULER**

L 30 cm (15 cm folded)

ALUMINIUM FOLDING RULER

- Dual use: measures in centimetres (30 cm) and degrees (180°)
- Material: aluminium

RIGHELLO PIEGHEVOLE IN ALLUMINIO

- Doppio utilizzo: misurazione in centimetri (30 cm) e in gradi (180°)
- Materiale: alluminio

RÈGLE PLIANTE EN ALUMINIUM

- Double usage : mesure en centimètres (30 cm) et mesure de degrés (180°)
- Matériau : aluminium

REGLA PLEGABLE DE ALUMINIO

- Doble uso: medición en centímetros (30 cm) y en grados (180°)
- Material: aluminio

KLAPPLINEAL AUS ALUMINIUM

- Doppelte Funktion: Zentimetermessen (30 cm) und Winkelmessen (180°)
- Material: Aluminium

PACKAGING

carded
L 8 x H 20.5 cm

**DISPLAY**

material: cardboard
L 9.5 x H 21 x W 14 cm
20 PCS

FRKIT2

8 051128 755565



HUG ME

L 3 x H 3.5 x W 6.3 cm

MINI STAPLER

- Built-in staple remover on the back
- 1,000 staples included

MINI CUCITRICE

- Levapunti incorporato sul retro
- 1000 punti inclusi

MINI AGRAFEUSE

- Ôte-agrafe intégré à l'arrière
- 1000 agrafes incluses

MINI GRAPADORA

- Quitagrapas incorporado en la parte trasera
- Incluye 1000 grapas

MINI-HEFTZANGE

- Auf der Rückseite integrierter Enthefter
- Inklusive 1000 Heftklammern



Suitable for No. 10 staples

PACKAGING

carded
L 12.4 x H 11.5 x W 3.2 cm
SOLD X 8

**PANDA
STAP0001**

8 058093 948794

**MEOW**

L 3.3 x H 4.5 x W 6.5 cm

MINI STAPLER

- Built-in staple remover on the back
- 1,000 staples included

MINI CUCITRICE

- Levapunti incorporato sul retro
- 1000 punti inclusi

MINI AGRAFEUSE

- Ôte-agrafe intégré à l'arrière
- 1000 agrafes incluses

MINI GRAPADORA

- Quitagrapas incorporado en la parte trasera
- Incluye 1000 grapas

MINI-HEFTZANGE

- Auf der Rückseite integrierter Enthefter
- Inklusive 1000 Heftklammern



Suitable for No. 12 staples (26/6)

PACKAGING

carded
L 12.2 x H 12 x W 3.5 cm
SOLD X 8

**KITTY
STAP0003**

8 054117 621889

**JUST MY TYPE**

L 3.7 x H 7.8 x W 2.5 cm

ROTATING STAMP WITH INK PAD

- 12 different messages
- Material: plastic handle, soft rubber stamp

**TIMBRO GIREVOLE CON TAMPONE
INCHIOSTRO**

- 12 diversi messaggi
- Materiale: manico in plastica, stampino in gomma morbida

TAMPON ROTATIF AVEC ENCREUR

- 12 messages différents
- Matériau : manche en plastique, timbre en caoutchouc souple

SELLO GIRATORIO CON TAMPÓN DE TINTA

- 12 mensajes distintos
- Material: mango de plástico, sello de goma blanda

DREHBARER STEMPEL MIT STEMPELKISSEN

- 12 verschiedene Nachrichten
- Material: Griff aus Kunststoff, Stempel aus weichem Gummi

PACKAGING
carded
L 11.5 x H 14 cm

**DISPLAY**

material: cardboard
L 15 x H 25 x W 20 cm
6 PCS

ROTKIT1

8 051128 751369



FOLLOW THE RAINBOW

L 13.5 x H 6.5 x W 4.5 cm

TAPE DISPENSER

- Includes one roll of colourful tape
- Material: plastic, metal

DISPENSER PER NASTRO ADESIVO

- Include un rotolo di nastro adesivo colorato
- Materiale: plastica, metallo

DÉROULEUR DE RUBAN ADHÉSIF

- Comprend un rouleau de ruban adhésif coloré
- Matériau : plastique, métal

DISPENSADOR DE CINTA ADHESIVA

- Incluye un rollo de cinta adhesiva de colores
- Material: plástico, metal

ABROLLGERÄT FÜR KLEBEBAND

- Inklusive einer Rolle mit buntem Klebeband
- Material: Kunststoff, Metall

PACKAGING

cardboard box
L 13.7 x H 7 x W 5.2 cm

SOLD X 4

RTD0001



Opens and closes



TAPE BY TAPE

Ø 4.5 cm, H MAX 3 cm

SET OF 5 PAPER STICKY TAPES

- Length: 5 metres

SET DI 5 NASTRI ADESIVI DI CARTA

- Lunghezza: 5 metri

SET DE 5 RUBANS ADHÉSIFS EN PAPIER

- Longueur : 5 mètres

SET DE 5 CINTAS ADHESIVAS DE PAPEL

- Longitud: 5 metros

SET MIT 5 PAPIER-KLEBEBÄNDERN

- Länge: 5 Meter

PACKAGING
window box
L 4.5 x H 10.5 x W 4.5 cm



DISPLAY
material: cardboard
L 9.5 x H 14.5 x W 14 cm
6 PCS

HEART TAPKITS



PACKAGING
window box
L 4.5 x H 10.5 x W 4.5 cm



DISPLAY
material: cardboard
L 9.5 x H 14.5 x W 14 cm
6 PCS

AVOCADO TAPKIT6



PACKAGING
window box
L 4.5 x H 10.5 x W 4.5 cm



DISPLAY
material: cardboard
L 9.5 x H 14.5 x W 14 cm
6 PCS

CUTE ANIMALS TAPKIT7



PACKAGING
window box
L 4.5 x H 10.5 x W 4.5 cm



DISPLAY
material: cardboard
L 9.5 x H 14.5 x W 14 cm
6 PCS

RAINBOW TAPKIT8



KEEP IN MIND

L 7 x H 8.4 x W 0.5 cm

ADHESIVE PAGEMARKES

- 30 writeable and removable adhesive strips per colour

SEGNAPAGINA ADESIVI

- 30 foglietti adesivi per colore, scrivibili e rimovibili

MARQUE-PAGES ADHÉSIFS

- 30 pièces autocollantes par couleur, inscriptibles et détachables

MARCAPÁGINAS ADHESIVOS

- 30 hojas adhesivas de cada color escribibles y separables

KLEBESEITENMARKIERER

- 30 Klebezettel pro Farbe, beschreibbar und ablösbar

PACKAGINGcarded
L 7 x H 12.7 cm**DISPLAY**material: cardboard
L 7.5 x H 20.8 x W 15.5 cm**12 PCS****FRUITS**

KIMKIT3



8 051128 754407

**PACKAGING**carded
L 7 x H 12.7 cm**DISPLAY**material: cardboard
L 7.5 x H 20.8 x W 15.5 cm**12 PCS****CUTE ANIMALS**

KIMKIT4



8 051128 754414

**TEENY-WEENY TAPE GUN**

L 8 x H 12 x W 3 cm

ADHESIVE TAPE GUN

- Includes one 18 mm x 25 m roll of adhesive tape
- Serrated cutting blade
- Ergonomic handle

DISPENSER PER NASTRO ADESIVO

- Include 1 rotolo di nastro adesivo 18 mm x 25 m
- Lama di taglio seghettata
- Impugnatura ergonomica

DÉROULEUR DE RUBAN ADHÉSIF

- Un rouleau de ruban adhésif 18 mm x 25 m inclus
- Lame de découpage dentelée
- Poignée ergonomique

DISPENSADOR DE CINTA ADHESIVA

- Incluye 1 rollo de cinta adhesiva 18 mm x 25 m
- Cuchilla de corte con dientes de sierra
- Empuñadura ergonómica

ABROLLGERÄT FÜR KLEBEBAND

- Inklusive 1 Klebebandrolle 18 mm x 25 m
- Gezackte Schneideklänge
- Ergonomischer Griff

PACKAGINGclamshell
L 14 x H 20.5 x W 4 cm**SOLD X 3**

MTG0002 YELLOW



8 051122 264117

MEOW

L 1.8 x H 8.5 x W 1 cm

MINI SCISSORS

- Small and compact
- Material: plastic, metal

MINI FORBICI

- Piccole e compatte
- Materiale: plastica, metallo

MINI CISEAUX

- Petits et compacts
- Matériau : plastique, métal

MINITIJERAS

- Pequeñas y compactas
- Material: plástico, metal

MINI-SCHERE

- Klein und kompakt
- Material: Kunststoff, Metall

PACKAGING

carded
L 6.5 x H 16.5 x W 1.4 cm



DISPLAY

material: cardboard
L 14.5 x H 21.3 x W 8.9 cm
12 PCS

MWSKIT1



8 051128 756784



CARRATE CUTTER

L 3.3 x H 8.2 x W 1.8 cm

MINI RETRACTABLE CUTTER

- Suitable for cutting any paper surface precisely
- Material: ABS, steel

MINI TAGLIERINO A SCOMPARSA

- Adatto per tagliare con precisione qualsiasi superficie cartacea
- Materiale: ABS, acciaio

MINI CUTTER ESCAMOTABLE

- Adapté pour couper avec précision n'importe quelle surface en papier
- Matériau : ABS, acier

MINICÚTER

- Apto para cortar con precisión cualquier superficie de papel
- Material: ABS, acero

EINKLAPPBARER MINI-CUTTER

- Geeignet, um jede Oberfläche aus Papier präzise zu schneiden
- Material: ABS, Stahl

PACKAGING

carded
L 8 x H 14.5 x W 2 cm



DISPLAY

material: cardboard
L 17.5 x H 22.5 x W 15.5 cm
12 PCS

RCUTKIT1



8 051128 754803



CUTTING LINE

L 6.5 x H 20 cm

STAINLESS STEEL SCISSORS

- Stainless steel blades guarantee exceptional durability and outstanding cutting performance

FORBICI IN ACCIAIO INOSSIDABILE

- Lame in acciaio inossidabile per garantire un'eccezionale durata e un'ottima prestazione di taglio

CISEAUX EN ACIER INOXYDABLE

- Lames en acier inoxydable pour garantir une durée exceptionnelle et une haute performance de coupe

TIJERAS EN ACERO INOXIDABLE

- Cuchillas en acero inoxidable para garantizar una excepcional duración y un óptimo resultado de corte

SCHERE AUS EDELSTAHL

- Die Klingen aus Edelstahl garantieren eine außergewöhnliche Dauerhaftigkeit und eine hervorragende Schneidleistung



Lined in soft rubber

PACKAGING

PP box w/hook
L 8 x H 22 x W 1 cm
SOLD X 4

SCIS0001



8 052783 618813



SMART NOTES

L 25 x H 17 cm

PAPER MOUSEPAD & NOTEPAD

- 55 tear-off sheets
- 80 g/m² paper

TAPPETINO PER IL MOUSE IN CARTA & BLOC-NOTES

- 55 fogli staccabili
- Carta 80 g/m²

TAPIS DE SOURIS EN PAPIER & BLOC-NOTES

- 55 feuilles détachables
- Papier 80 g/m²

ALFOMBRILLA DE PAPEL PARA RATÓN & BLOC DE NOTAS

- 55 hojas separables
- Papel 80 g/m²

MOUSEPAD AUS PAPIER & NOTIZBLOCK

- 55 abtrennbare Zettel
- Papier 80 g/m²



* While stock lasts

SOLD X 2



BOSS

SMANT0012 *



8 051739 307511



TRAVEL

SMANT0015



8 054320 566908



PANDA

SMANT0016



8 054320 566915



BEAUTIFUL DAY

SMANT0017 *



8 054320 566922



RAINBOW

SMANT0019 *



8 054320 566946

SMART PLANNING

L 34 x H 8 cm



DESK PLANNER

- 55 tear-off sheets
- 80 g/m² paper

PLANNING DA SCRIVANIA

- 55 fogli staccabili
- Carta 80 g/m²

AGENDA DE BUREAU

- 55 feuilles détachables
- Papier 80 g/m²

* While stock lasts

SOLD X 2

AGENDA DE ESCRITORIO

- 55 hojas separables
- Papel 80 g/m²

SCHREIBTISCHKALENDER

- 55 abtrennbare Zettel
- Papel 80 g/m²



PANDA

SMAPL20 *



8 054320 566984

HAPPY MEMO

L 9 x H 8.2 x W 9 cm

MEMO CUBE

- 700 white tear-off sheets
- 100 g/m² paper

BLOCCO NOTE

- 700 fogli bianchi staccabili
- Carta 100 g/m²

BLOC-MÉMO

- 700 feuilles blanches détachables
- Papier 100 g/m²

SOLD X 2

CUBO DE NOTAS

- 700 hojas blancas separables
- Papel 100 g/m²

NOTIZBLOCK

- 700 abtrennbare weiße Zettel
- Papier 100 g/m²



TRAVEL

HM0001



8 056304 485861

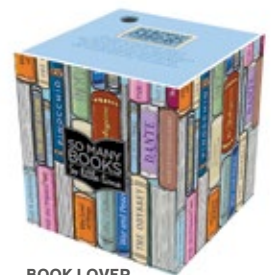

BOOK LOVER

HM0003



8 056304 485885

PAPER THOUGHTS

L 11 x H 19 cm / L 19 x H 11 cm

NOTEPAD

- 70 tear-off sheets
- 80 g/m² paper

BLOC-NOTES

- 70 fogli staccabili
- Carta 80 g/m²

BLOC-NOTES

- 70 feuilles détachables
- Papier 80 g/m²

BLOC DE NOTAS

- 70 hojas separables
- Papel 80 g/m²

NOTIZBLOCK

- 70 abtrennbare Zettel
- Papier 80 g/m²

* While stock lasts

SOLD X 3



TRAVEL
PT0014 *



8 054320 566830

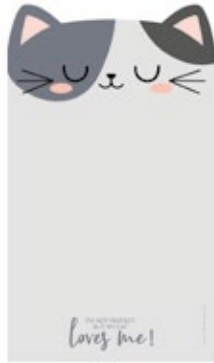

KITTY
PT0013



8 059174 834715



PANDA
PT0015



8 054320 566847



SLOTH
PT0017 *



8 054320 566861



RAINBOW
PT0019 *



8 054320 566885



BEAUTIFUL DAY
PT0008



8 058093 949180

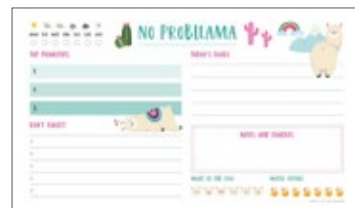

LLAMA
PT0011



8 059174 834692

SMART WEEK

L 34 x H 24 cm



DESK PLANNER

- 55 tear-off sheets
- 80 g/m² paper

PLANNING DA SCRIVANIA

- 55 fogli staccabili
- Carta 80 g/m²

AGENDA DE BUREAU

- 55 feuilles détachables
- Papier 80 g/m²

AGENDA DE ESCRITORIO

- 55 hojas separables
- Papel 80 g/m²

SCHREIBTISCHKALENDER

- 55 abtrennbare Zettel
- Papier 80 g/m²



SOLD X 2



TRAVEL
DW0001



8 051739 307566



PANDA
DW0005



8 054320 566991

TAKE NOTE

L 23 x H 32 x W 1.5 cm (closed)

CLIPBOARD FOLDER

- 1 pad of 40 sheets included (21.5 x 29.7 cm)
- Inside pocket to hold documents
- Material: metal, paper



CARTELLA PORTADOCUMENTI CON CLIP

- 1 blocco da 40 fogli incluso (21,5 x 29,7 cm)
- Taschina interna portadocumenti
- Materiale: metallo, carta

PORTE-DOCUMENTS AVEC PINCE

- 1 bloc de 40 feuilles inclus (21,5 x 29,7 cm)
- Poche intérieure porte-documents
- Matériau : métal, papier

CARPETA PORTADOCUMENTOS CON CLIP

- 1 bloc de 40 folios incluido (21,5 x 29,7 cm)
- Bolsillo interno portadocumentos
- Material: metal, papel

DOKUMENTENMAPPE MIT CLIP

- Inklusive 1 Block mit 40 Blättern (21,5 x 29,7 cm)
- Innentasche für Dokumente
- Material: Metall, Papier

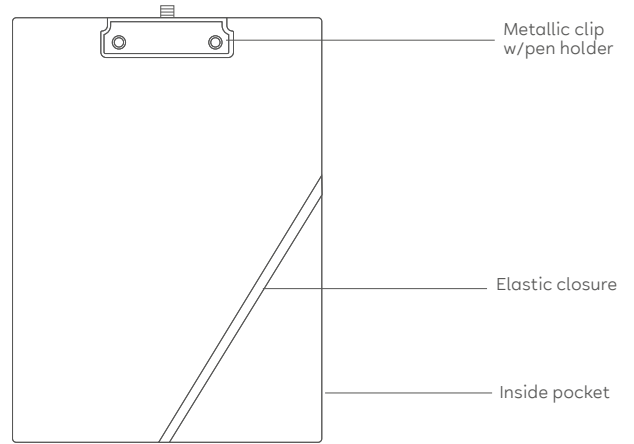

SOLD X 3

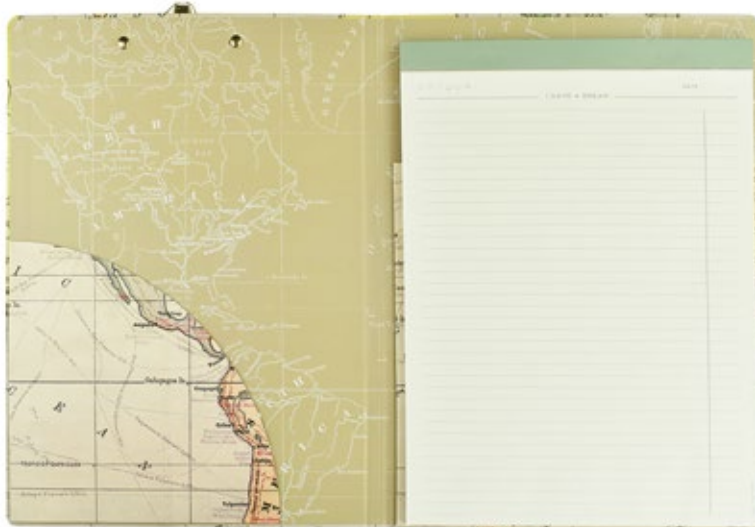

TRAVEL
CPF0001



8 052783 615584



STARS
CPF0005



8 054320 565024

YUMMY YUMMY

L 7 x H 10 x W 7 cm

MEMO SHEETS

- 250 tear-off sheets
- 70 g/m² paper

BLOCCHETTO MEMO

- 250 fogli staccabili
- Carta 70 g/m²

BLOC MÉMO

- 250 feuilles détachables
- Papier 70 g/m²

NOTAS RECORDATORIAS

- 250 hojas separables
- Papel 70 g/m²

NOTIZZETTEL

- 250 abtrennbare Zettel
- Papier 70 g/m²

**PACKAGING**cardboard box
L 7 x H 10 x W 7 cm**SOLD X 6****UNICORN**

MID0001

**PACKAGING**cardboard box
L 7 x H 10 x W 7 cm**SOLD X 6****KITTY**

MID0002

**RAINBOW THOUGHTS**

L 12 x H 6 x W 1,7 cm

ADHESIVE NOTEPAD

- 152 removable and repositionable sticky notes
- 19 sheets in each colour
- 80 g/m² paper

BLOC-NOTES ADESIVO

- 152 foglietti adesivi removibili e riposizionabili
- 19 foglietti per ogni colore
- Carta 80 g/m²

BLOC-NOTES ADHÉSIF

- 152 petites feuilles adhésives détachables et repositionnables
- 19 feuilles pour chaque couleur
- Papier 80 g/m²

BLOC DE NOTAS ADHESIVO

- 152 hojas adhesivas extraíbles y recolocables
- 19 hojas de cada color
- Papel 80 g/m²

HAFTNOTIZBLOCK

- 152 ablösbare und neu positionierbare Klebezettel
- 19 Blätter pro Farbe
- Papier 80 g/m²

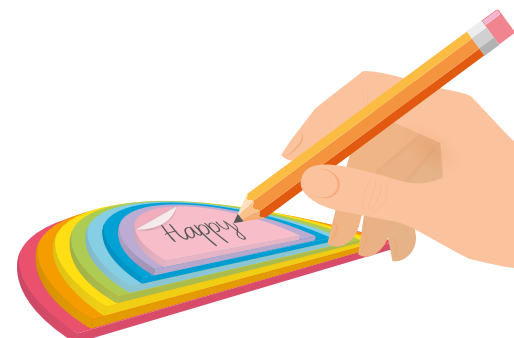
PACKAGINGwindow box
L 14 x H 10,8 x W 2 cm**DISPLAY**material: cardboard
L 14,6 x H 20,4 x W 18,3 cm**8 PCS****RSTKITI**

LOVELY NOTES

ADHESIVE NOTEPAD

- 100 removable and repositionable sticky notes
- 90 g/m² paper

BLOCCHETTO NOTE ADESIVO

- 100 foglietti adesivi removibili e riposizionabili
- Carta 90 g/m²

BLOC-NOTES ADHÉSIF

- 100 petites feuilles adhésives détachables et repositionnables
- Papier 90 g/m²

BLOC DE NOTAS ADHESIVO

- 100 hojas adhesivas extraíbles y recolocables
- Papel 90 g/m²

HAFTNOTIZBLOCK

- 100 ablösbare und neu positionierbare Klebezettel
- Papier 90 g/m²



L 7 x H 7.2 x W 1.2 cm

DISPLAY

material: cardboard
L 9 x H 14.7 x W 15 cm

12 PCS

HEART

HSSKIT1



8 051128 754766



L 4.5 x H 5.8 x W 1.2 cm

DISPLAY

material: cardboard
L 8.5 x H 14.5 x 15.5 cm

12 PCS

KITTY

ADKKIT1



8 052694 003876



MAGNETIC NOTEPAD

L 9.8 x H 12.7 x W 2.5 cm

MAGNETIC NOTEPAD

- 235 tear-off sheets
- 80 g/m² paper
- Material: paper, rigid cardboard backing, magnetic base

BLOC-NOTES MAGNETICO

- 235 fogli staccabili
- Carta 80 g/m²
- Materiale: carta, supporto in cartoncino rigido, base magnetica

BLOC-NOTES MAGNÉTIQUE

- 235 feuilles détachables
- Papier 80 g/m²
- Matériau : papier, support en carton rigide, base magnétique

BLOC DE NOTAS MAGNÉTICO

- 235 hojas separables
- Papel 80 g/m²
- Material: papel, soporte de cartón duro, base magnética

MAGNETISCHER NOTIZBLOCK

- 235 abtrennbare Zettel
- Papier 80 g/m²
- Material: Papier, Basis aus stabilem Karton, magnetische Basis



PACKAGING

shrink-wrapping w/hook
L 9.8 x H 14.7 x W 2.5 cm

SOLD X 6

MGN0T001



8 052461 962092



BOOKMARKS

BOOKMARK

L 4.7 x H 17.5 cm

BOOKMARK

- With elastic pagemarker, also useful for keeping your book closed

SEGNALIBRO

- Con elastico segnapagina, utile anche per tenere il libro chiuso

MARQUE-PAGE

- Marque-page avec élastique, également utile pour maintenir le livre fermé

MARCAPÁGINAS

- Con elástico marcapáginas, útil incluso para tener el libro cerrado

LESEZEICHEN

- Mit elastischem Seitenmarkierer, nützlich auch, um das Buch geschlossen zu halten

✳ While stock lasts

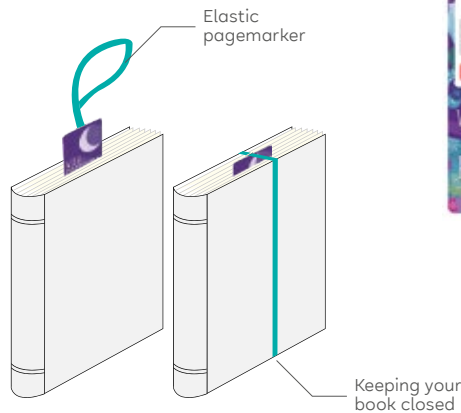

PACKAGING
cello sleeve w/hook
L 5.5 x H 19.5 cm
SOLD X 3



GOLD/SILVER
FOIL

BOOKMARKS DISPLAY

Counter empty display on demand:
14 hooks
(hook capacity: 12 pcs)
total capacity: 168 pcs
material: metal
Ø 23 cm, H 46 cm

DISWIRW



BOOK LOVER'S COLLECTION



DREAM CATCHER

SE0159 ✳



AIR BALLOON

SE0165



BOOK LOVER

Read to live

SE0166

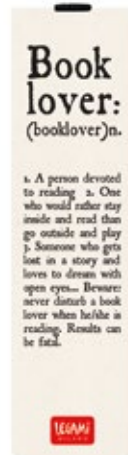

BOOK LOVER

SE0182



BOOK LOVER

Books

SE0184



PANDA

Free hugs

SE0196



ELEPHANT

SE0201 ✳

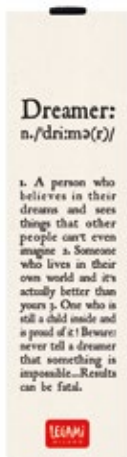

DREAMER

SE0206 ✳



ALICE
IN WONDERLAND

SE0208



LITTLE PRINCE

SE0209



PANDA

Need more books

SE0227



OWL

SE0228





LLAMA

SE0229



DINO

SE0230 *



SPACE

SE0232 *



RAINBOW

SE0234 *



KITTY

SE0235



DOGS

SE0236



STARS

SE0237 *



VINCENT VAN GOGH

SE0240



GUSTAV KLIMT

SE0241



CLAUDE MONET

SE0242



TRAVEL

SE0243



APHORISMS COLLECTION

ITALIAN MARKET



BOOK LOVER

Chi accumula libri

SE0084



ALICE IN WONDERLAND

SE0214





ARIES
SE0215



TAURUS
SE0216



GEMINI
SE0217



CANCER
SE0218



LEO
SE0219



VIRGO
SE0220



LIBRA
SE0221



SCORPIO
SE0222



SAGITTARIUS
SE0223



CAPRICORN
SE0224



AQUARIUS
SE0225



PISCES
SE0226



HUNGRY FOR BOOKS

L 11.5 x H 6.5 cm x W 1.3 cm

BOOKMARK

- Material: plastic

SEGNALIBRO

- Materiale: plastica

MARQUE-PAGE

- Matériau : plastique

MARCAPÁGINAS

- Material: plástico

LESEZEICHEN

- Material: Kunststoff

**PACKAGING**cardboard box
L 14.5 x H 11.5 x W 2.5 cm**DISPLAY**material: cardboard
L 15.5 x H 21.5 x W 19 cm**7 PCS****SHARKKIT1****NEVER STOP READING**

L 2.5 x H 4.5 cm

SET OF 4 MAGNETIC BOOKMARKS

- Material: paper, plastroferrite

SET DI 4 SEGNALIBRI MAGNETICI

- Materiale: carta, plastroferrite

SET DE 4 MARQUE-PAGES MAGNÉTIQUES

- Matériau : papier, plastroferrite

SET DE 4 MARCAPÁGINAS MAGNÉTICOS

- Material: papel, plastroferrita

SET MIT 4 MAGNETISCHEN LESEZEICHEN

- Material: Papier, Plastroferrit

**PACKAGING**cello sleeve
w/cardboard
L 8 x H 14.5 cm**DISPLAY**material: cardboard
L 8.5 x H 23 x W 15.5 cm**12 PCS****MBOOKKIT2**



MY NOTEBOOK

+ NOTEBOOKS & JOURNALS +



Contents



- 192 numbered pages
- 192 pagine numerate
- 192 pages numérotées
- 192 páginas numeradas
- 192 nummerierte Seiten

- Index
- Indice
- Index
- Índice
- Inhaltsverzeichnis

- Contacts list
- Rubrica
- Répertoire
- Agenda de contactos
- Telefonverzeichnis

- Page to record IDs & passwords
- Pagina per annotare id & password
- Page pour noter identifiants et mots de passe
- Página para nombres de usuario y contraseñas
- Seite zum Notieren von IDs & Passwörtern

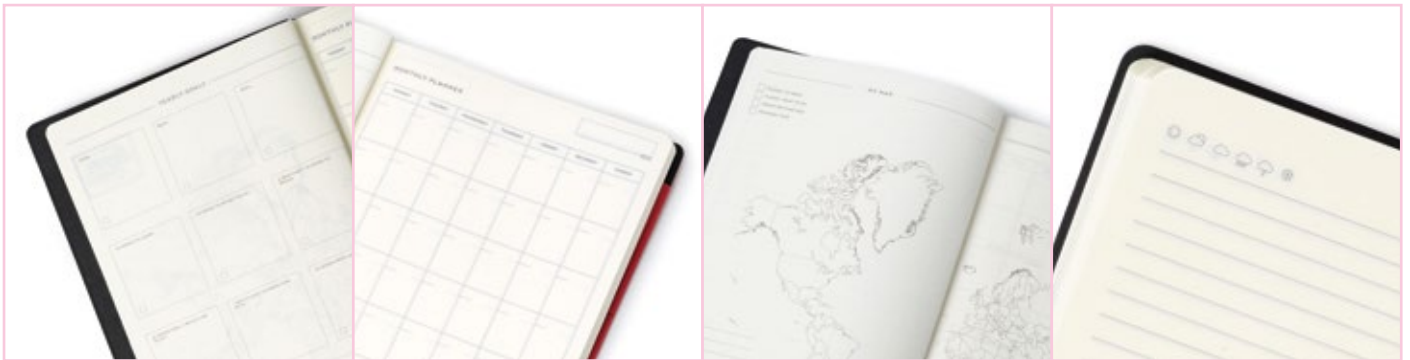

- Page for New Year's resolutions
- Pagina per i propositi del nuovo anno
- Page pour les bonnes résolutions du nouvel an
- Página para los propósitos de año nuevo
- Seite für die Vorsätze im neuen Jahr

- 12 pages with monthly planner
- 12 pagine con planner mensile
- 12 pages avec planner mensuel
- 12 páginas con agenda mensual
- 12 Seiten mit Monatsplaner

- Map to record your trips around the world
- Mappa per annotare i tuoi viaggi nel mondo
- Carte pour noter les voyages réalisés à travers le monde
- Mapa para anotar tus viajes por el mundo
- Landkarte, um Ihre in der Welt gemachten Reisen zu verzeichnen

- Fun icons to mark the daily weather
- Simpatiche icone per segnare il meteo del giorno
- Images sympathiques pour marquer la météo du jour
- Simpatícos iconos para indicar el tiempo meteorológico de cada día
- Sympathische Symbole zum Eintragen des Tageswetters

Colour chart

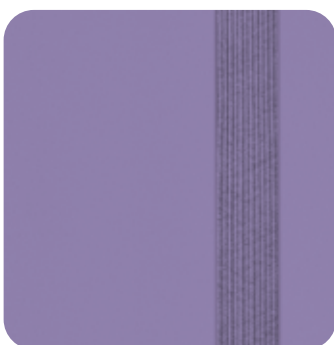

LAVENDER



BOUGAINVILLEA



RED PASSION



YELLOW FREESIA

Details



- Cover made of soft PU
- Copertina in morbido PU
- Couverture en PU doux au toucher
- Tapa en suave PU
- Cover aus weichem PU

- Elastic closure
- Elastico di chiusura
- Fermeture élastique
- Elástico de cierre
- Gummiband zum Verschließen

- Bookmark
- Segnalibro
- Marque-page
- Marcapáginas
- Lesezeichen-Band

- Rounded corners
- Angoli arrotondati
- Angles arrondis
- Esquinas redondeadas
- Abgerundete Ecken



- 90 g/m² ivory paper
- Carta avorio 90 g/m²
- Papier ivoire 90 g/m²
- Papel marfil 90 g/m²
- Elfenbeinfarbenes Papier 90 g/m²

- Pagemaker flap/pen holder
- Patella segnapagina/portapenna
- Rabat marque-page/porte-stylo
- Lengüeta marcapáginas/portabolígrafos
- Lasche als Lesezeichen/Stifthalter

- Back pocket
- Taschina finale
- Pochette mémos
- Bolsillo final
- Einschubtasche hinten

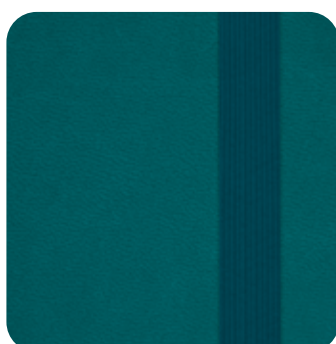
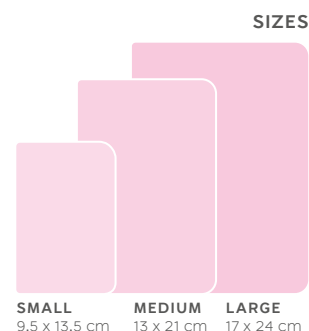

MALACHITE GREEN



GALACTIC BLUE



BLACK ONYX

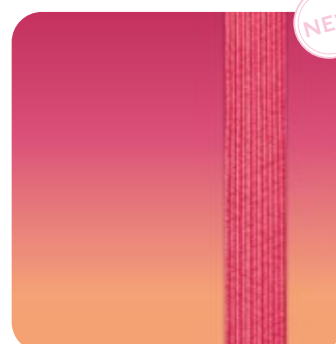

GOLDEN HOUR

GOLDEN HOUR

2024

LIMITED EDITION

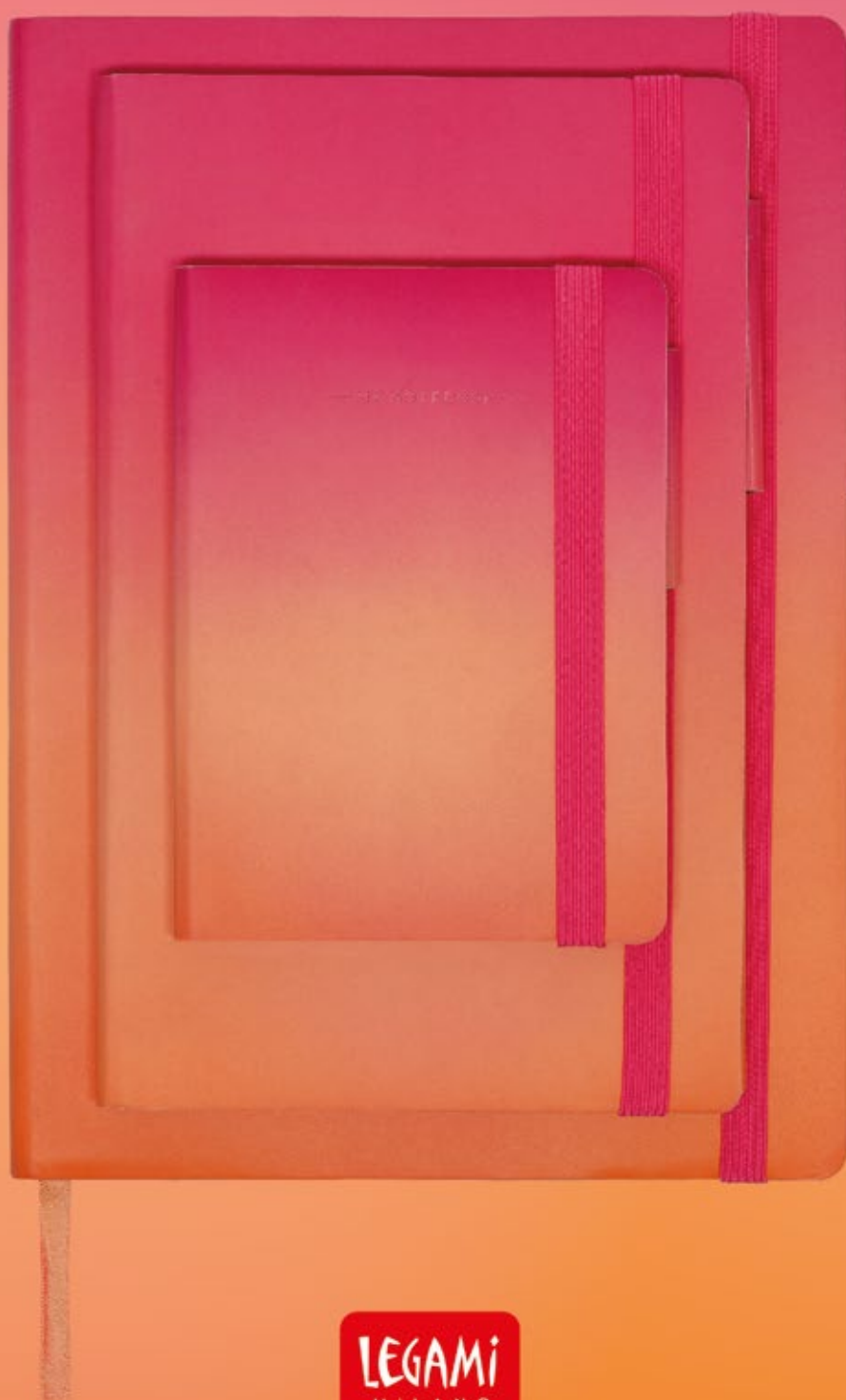

LEGAMI
MILANO

MY NOTEBOOK - SMALL

L 9.5 x H 13.5 cm

LINED NOTEBOOK

TACCUINO A RIGHE

CARNET LIGNÉ

CUADERNO DE RAYAS

LINIERTES NOTIZBUCH

SOLD X 3

PLAIN NOTEBOOK

TACCUINO BIANCO

CARNET BLANC

CUADERNO BLANCO

UNLINIERTES NOTIZBUCH

SOLD X 3



LINED
6 mm

GOLDEN HOUR LINED
MYNOT0254

8 052694 010737

GOLDEN HOUR PLAIN
MYNOT0255

8 052694 010744

MY NOTEBOOK - MEDIUM

L 13 x H 21 cm

LINED NOTEBOOK

TACCUINO A RIGHE

CARNET LIGNÉ

CUADERNO DE RAYAS

LINIERTES NOTIZBUCH

SOLD X 3

PLAIN NOTEBOOK

TACCUINO BIANCO

CARNET BLANC

CUADERNO BLANCO

UNLINIERTES NOTIZBUCH

SOLD X 3

DOTTED NOTEBOOK

TACCUINO A PUNTINI

CARNET POINTILLÉ

CUADERNO PUNTEADO

PUNKTKAIRETES NOTIZBUCH

SOLD X 3



LINED
6 mm

GOLDEN HOUR LINED
MYNOT0256

8 052694 010751

GOLDEN HOUR PLAIN
MYNOT0257

8 052694 010768

GOLDEN HOUR DOTTED
MYNOT0258

8 052694 010775

MY NOTEBOOK - LARGE

L 17 x H 24 cm

LINED NOTEBOOK

TACCUINO A RIGHE

CARNET LIGNÉ

CUADERNO DE RAYAS

LINIERTES NOTIZBUCH

SOLD X 3

PLAIN NOTEBOOK

TACCUINO BIANCO

CARNET BLANC

CUADERNO BLANCO

UNLINIERTES NOTIZBUCH

SOLD X 3



LINED
6 mm

GOLDEN HOUR LINED
MYNOT0259

8 052694 010782

GOLDEN HOUR PLAIN
MYNOT0260

8 052694 010799



PRESENTS

METALLIC COLLECTION

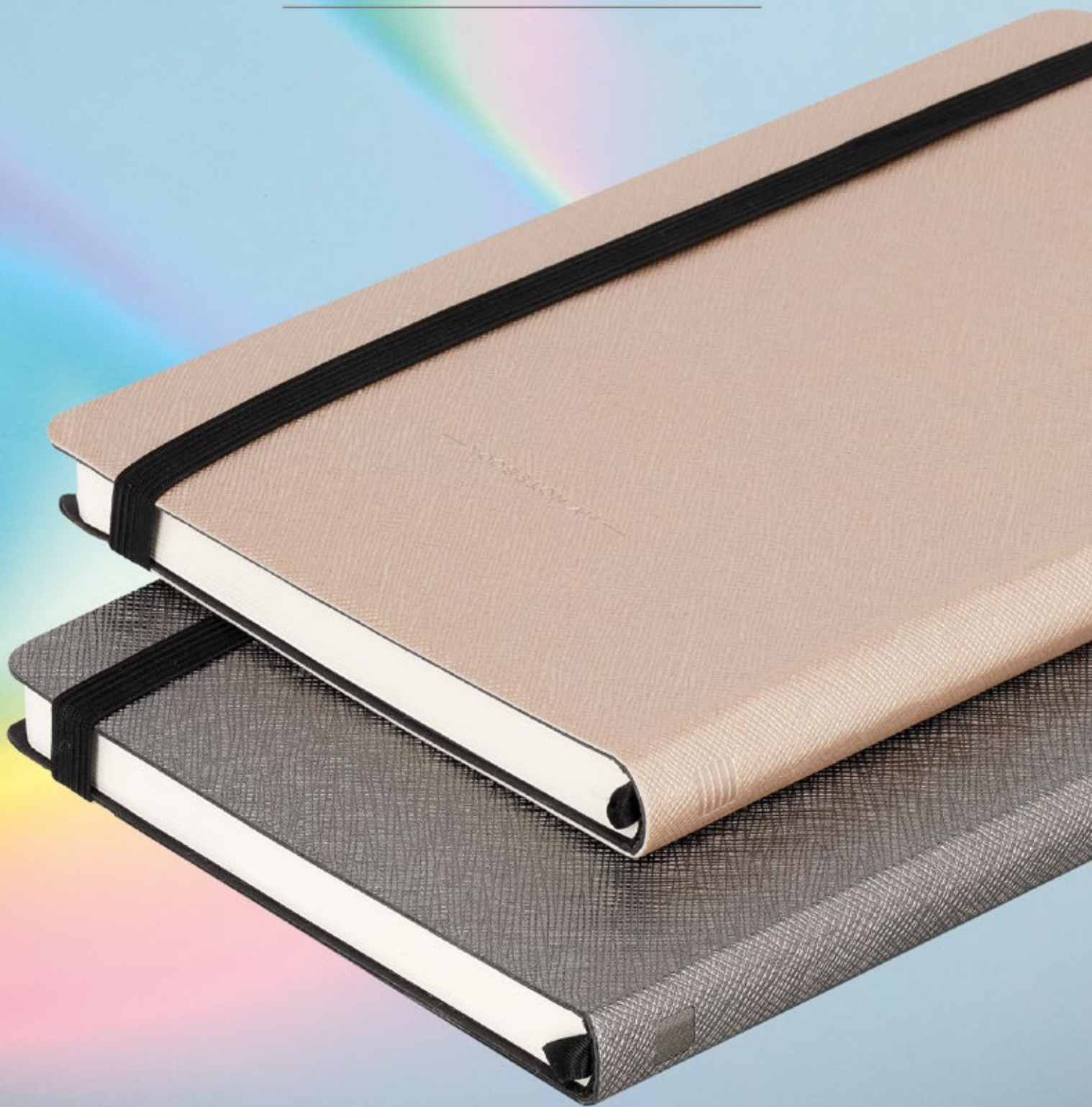

MY NOTEBOOK - MEDIUM

L 13 x H 21 cm

LINED NOTEBOOK

TACCUINO A RIGHE

CARNET LIGNÉ

CUADERNO DE RAYAS

LINIERTES NOTIZBUCH

SOLD X 3

LINED
6 mm

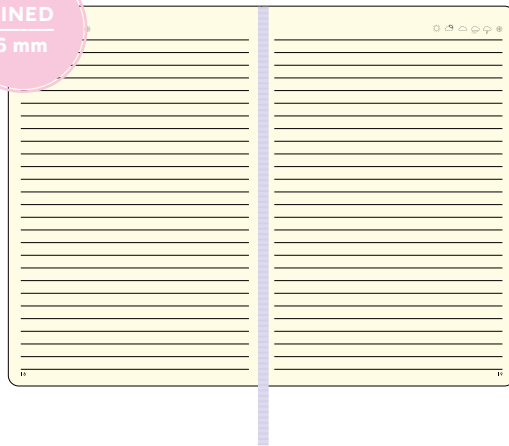

POP MATERIAL

WINDOW DISPLAY

L 48 x H 53 cm
Order 6 pcs of each color and you will receive a window display

MYNOT-MLMC-GROUP



8 051128 758436



GREY DIAMOND
MYNOT0223



8 053610 786446



ROSE GOLD
MYNOT0224



8 053610 786453



MY NOTEBOOK - SMALL

L 9.5 x H 13.5 cm

LINED NOTEBOOK

TACCUINO A RIGHE

CARNET LIGNÉ

CUADERNO DE RAYAS

LINIERTES NOTIZBUCH

SOLD X 3



LINED
6 mm

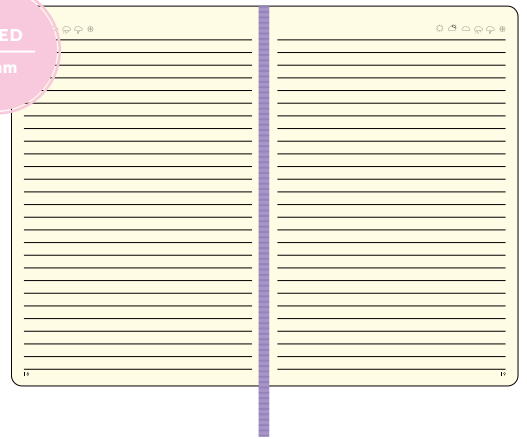

LAVENDER
MYNOT0201



BOUGAINVILLEA
MYNOT0202



RED PASSION
MYNOT0002



YELLOW FREESIA
MYNOT0204



MALACHITE GREEN
MYNOT0205



GALACTIC BLUE
MYNOT0206



BLACK ONYX
MYNOT0001



MY NOTEBOOK - SMALL

L 9.5 x H 13.5 cm

PLAIN NOTEBOOK

TACCUINO BIANCO

CARNET BLANC

CUADERNO BLANCO

UNLINIERTES NOTIZBUCH

SOLD X 3



PLAIN

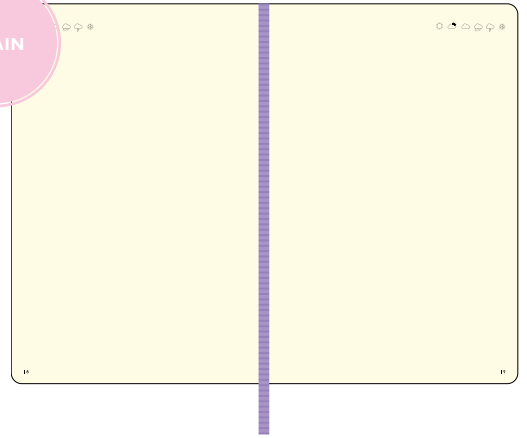

LAVENDER
MYNOT0208



BOUGAINVILLEA
MYNOT0209



RED PASSION
MYNOT0022



YELLOW FREESIA
MYNOT0211



MALACHITE GREEN
MYNOT0212



GALACTIC BLUE
MYNOT0213



BLACK ONYX
MYNOT0021



MY NOTEBOOK - MEDIUM

L 13 x H 21 cm

LINED NOTEBOOK

TACCUINO A RIGHE

CARNET LIGNÉ

CUADERNO DE RAYAS

LINIERTES NOTIZBUCH

SOLD X 3



LINED
6 mm

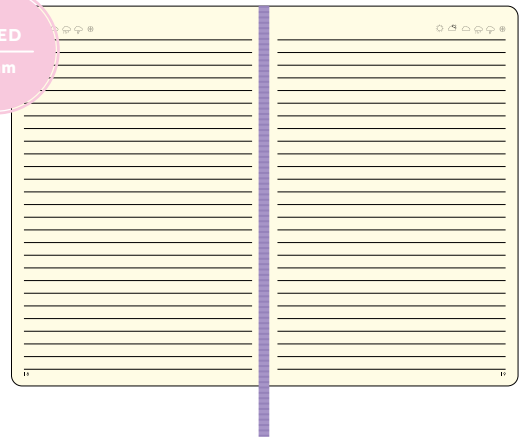

LAVENDER
MYNOT0215



BOUGAINVILLEA
MYNOT0216



RED PASSION
MYNOT0166



YELLOW FREESIA
MYNOT0218



MALACHITE GREEN
MYNOT0219



GALACTIC BLUE
MYNOT0220



BLACK ONYX
MYNOT0165



MY NOTEBOOK - MEDIUM

L 13 x H 21 cm

PLAIN NOTEBOOK

TACCUINO BIANCO

CARNET BLANC

CUADERNO BLANCO

UNLINIERTES NOTIZBUCH

SOLD X 3



PLAIN

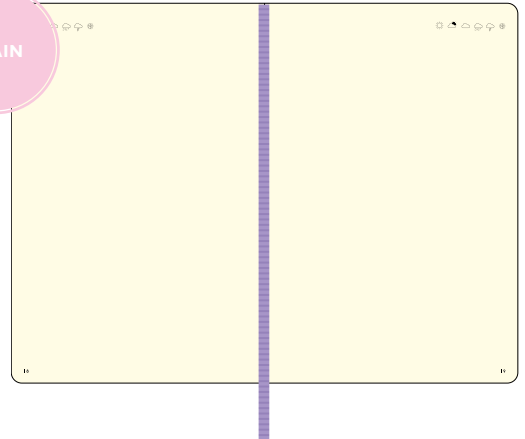

LAVENDER
MYNOT0225



BOUGAINVILLEA
MYNOT0226



RED PASSION
MYNOT0178



YELLOW FREESIA
MYNOT0228



MALACHITE GREEN
MYNOT0229



GALACTIC BLUE
MYNOT0230



BLACK ONYX
MYNOT0177



MY NOTEBOOK - MEDIUM

L 13 x H 21 cm

SQUARED NOTEBOOK

TACCUINO A QUADRETTI

CARNET QUADRILLÉ

CUADERNO DE CUADROS

KARIERTES NOTIZBUCH

SOLD X 3



SQUARED
5 mm

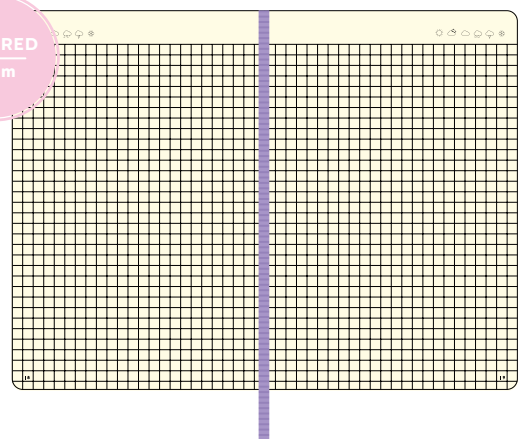

LAVENDER
MYNOT0237



YELLOW FREESIA
MYNOT0238



MALACHITE GREEN
MYNOT0239



MY NOTEBOOK - LARGE

L 17 x H 24 cm

LINED NOTEBOOK

TACCUINO A RIGHE

CARNET LIGNÉ

CUADERNO DE RAYAS

LINIERTES NOTIZBUCH

SOLD X 3

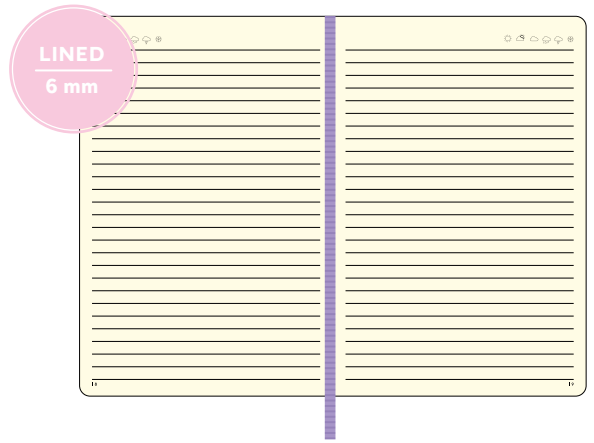

LAVENDER
MYNOT0240



BOUGAINVILLEA
MYNOT0241



RED PASSION
MYNOT0062



YELLOW FREESIA
MYNOT0243



MALACHITE GREEN
MYNOT0244



GALACTIC BLUE
MYNOT0245



BLACK ONYX
MYNOT0061



MY NOTEBOOK - LARGE

L 17 x H 24 cm

PLAIN NOTEBOOK

TACCUINO BIANCO

CARNET BLANC

CUADERNO BLANCO

UNLINIERTES NOTIZBUCH

SOLD X 3

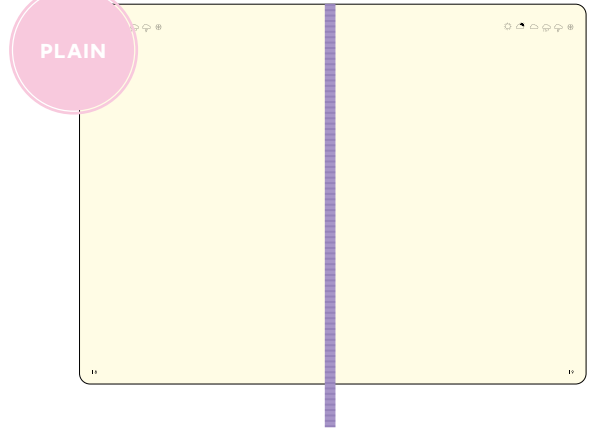

LAVENDER
MYNOT0247



BOUGAINVILLEA
MYNOT0248



RED PASSION
MYNOT0082



YELLOW FREESIA
MYNOT0250



MALACHITE GREEN
MYNOT0251



GALACTIC BLUE
MYNOT0252



BLACK ONYX
MYNOT0081





MY NOTEBOOK DOTTED

+ MEDIUM +

FULL CONTENTS AND TECHNICAL DETAILS ON PAGE 120-121:



FOR DOTTED NOTEBOOK ONLY

- Double bookmark
- Doppio segnalibro
- Double marque-page
- Doble marcapáginas
- Doppeltes Lesezeichen-Band

- 100 g/m² white paper
- Carta bianca 100 g/m²
- Papier blanc 100 g/m²
- Papel blanco 100 g/m²
- Weißes Papier 100 g/m²

- Cover made of soft PU
- Copertina in morbido PU
- Couverture en PU doux au toucher
- Tapa en suave PU
- Cover aus weichem PU

- Elastic closure
- Elastico di chiusura
- Fermeture élastique
- Elástico de cierre
- Gummiband zum Verschießen

MY NOTEBOOK - MEDIUM

L 13 x H 21 cm

- DOTTED NOTEBOOK
- TACCUINO A PUNTINI
- CARNET POINTILLÉ
- CUADERNO PUNTEADO
- PUNKTKAIRETES NOTIZBUCH
- SOLD X 3

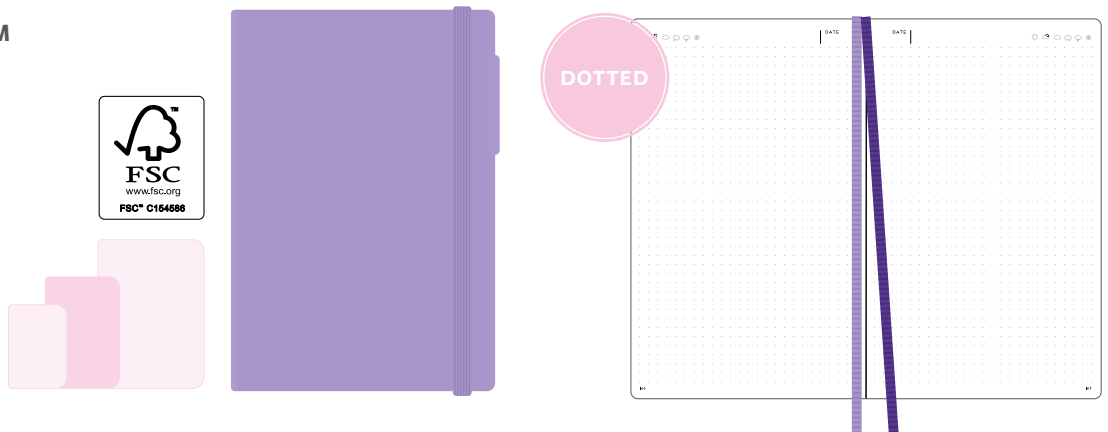

LAVENDER
MYNOT0232



8 053610 786538



BOUGAINVILLEA
MYNOT0233



8 053610 786545



YELLOW FREESIA
MYNOT0234



8 053610 786552



MALACHITE GREEN
MYNOT0235



8 053610 786569



GALACTIC BLUE
MYNOT0236



8 053610 786576

IRIDESCENT DREAM

2024
SPECIAL EDITION

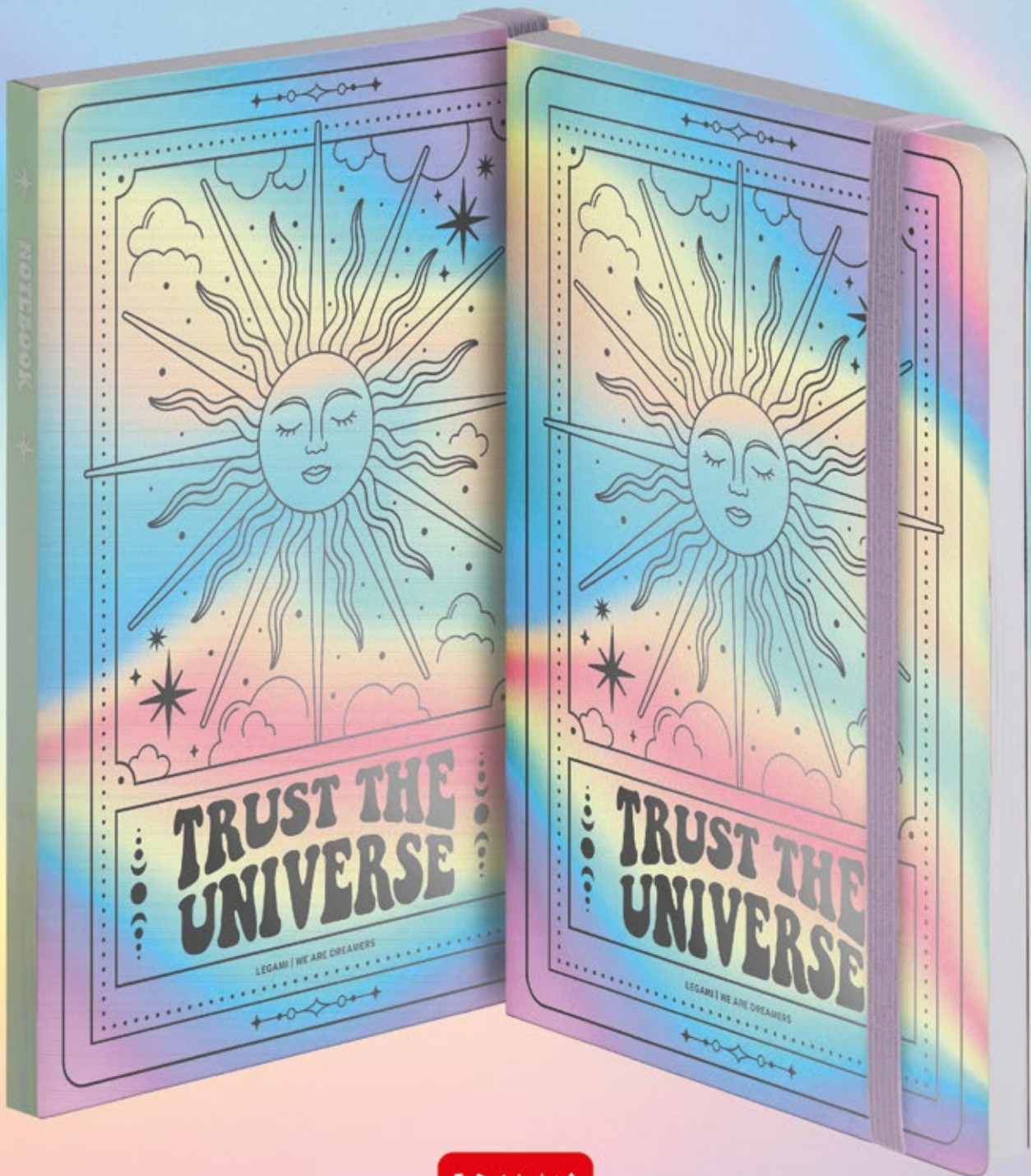

SPECIAL EDITION - TAROT



PHOTO NOTEBOOK

L 13 x H 21 cm

LINED NOTEBOOK

- 164 pages, back document pocket, last 24 pages tear-off

TACCUINO A RIGHE

- 164 pagine, taschina finale, ultime 24 pagine staccabili

CARNET LIGNÉ

- 164 pages, pochette mémos, 24 dernières pages détachables

CUADERNO DE RAYAS

- 164 páginas, bolsillo final, últimas 24 páginas separables

LINIERTES NOTIZBUCH

- 164 Seiten, Einschubtasche hinten, die letzten 24 Seiten sind heraustrennbar



120 g/m²
WHITE PAPER

MEDIUM - LINED
NOTP0110



SOLD X 3

QUADERNO

L 9 x H 13.5 cm (SMALL) - L 14.2 x H 21 cm (MEDIUM) - L 18.5 x H 24.8 cm (LARGE)

NOTEBOOK

- 80 pages (SMALL, MEDIUM)
- 100 pages (LARGE)
- Singer binding

QUADERNO

- 80 pagine (SMALL, MEDIUM)
- 100 pagine (LARGE)
- Rilegatura a punto Singer

CAHIER

- 80 pages (SMALL, MEDIUM)
- 100 pages (LARGE)
- Reliure par couture Singer

CUADERNO

- 80 páginas (SMALL, MEDIUM)
- 100 páginas (LARGE)
- Encuadernación con cosido Singer

HEFT

- 80 Seiten (SMALL, MEDIUM)
- 100 Seiten (LARGE)
- Singer-Fadenheftung

SOLD X 3



SMALL - LINED
A6NOT0042

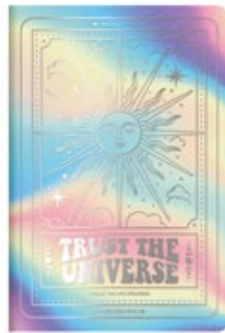

MEDIUM - LINED
A5NOT0077



MEDIUM - PLAIN
A5NOT0080

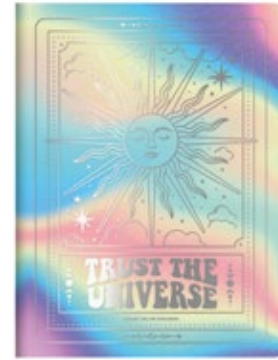

LARGE - LINED
B5NOT0049



100 g/m²
WHITE PAPER

SPIRAL NOTEPAD

L 7 x H 10 cm

LINED SPIRAL-BOUND NOTEPAD

- 220 pages

BLOCK-NOTES SPIRALATO A RIGHE

- 220 pagine

BLOC-NOTES LIGNÉ À SPIRALE

- 220 pages

BLOC DE NOTAS DE RAYAS CON ESPIRAL

- 220 páginas

LINIERTES NOTIZBLOCK MIT SPIRALBINDUNG

- 220 Seiten

SOLD X 3



MINI - LINED
MNOTS0024



80 g/m²
WHITE PAPER

SPIRAL NOTEBOOK

L 15 x H 21 cm (LARGE) - L 21 x H 29 cm (MAXI)

LINED SPIRAL-BOUND NOTEBOOK

- 160 pages

QUADERNO SPIRALATO A RIGHE

- 160 pagine

CAHIER LIGNÉ À SPIRALE

- 160 pages

CUADERNO DE RAYAS CON ESPIRAL

- 160 páginas

LINIERTES HEFT MIT SPIRALBINDUNG

- 160 Seiten

SOLD X 3

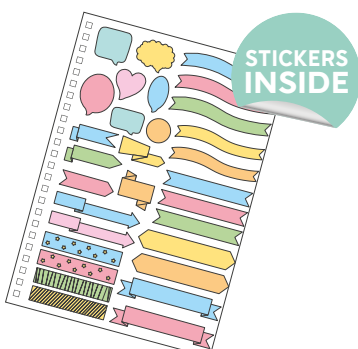

STICKERS
INSIDE



LARGE - LINED
A5NOTS0045



MAXI - LINED
A4NOTS0055



80 g/m²
WHITE PAPER

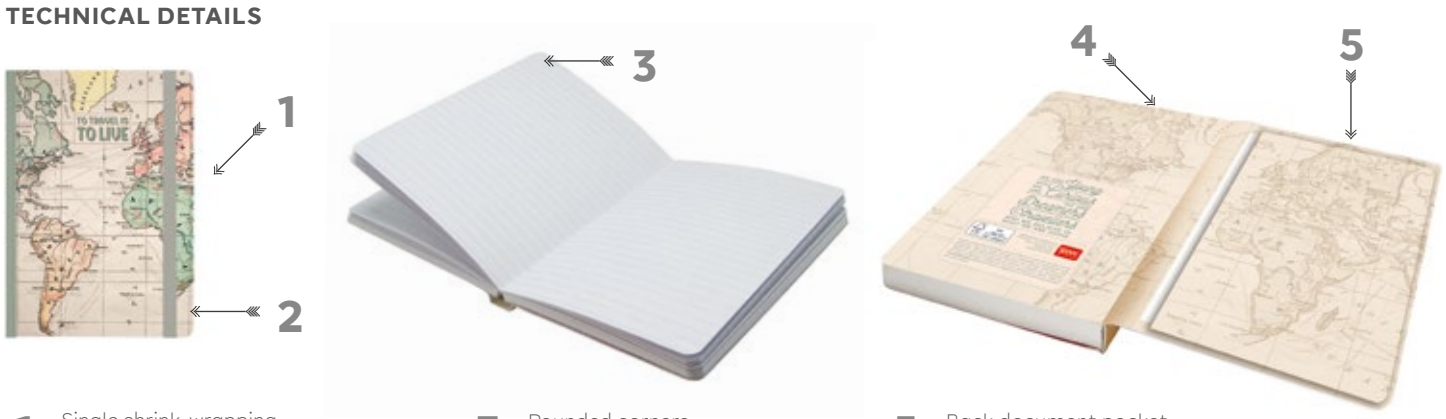

PHOTO NOTEBOOKS

+ NOTEBOOKS & JOURNALS +

LEGAMI
MILANO

TECHNICAL DETAILS



- 1** Single shrink-wrapping
Cellophanatura singola
Emballage sous cellophane individuel
Envoltura con celofán individual
Einzelne Zellophanverpackung
- 2** Elastic closure
Elastico di chiusura
Fermeture élastique
Elástico de cierre
Gummiband zum Verschließen

- 3** Rounded corners
Angoli arrotondati
Angles arrondis
Esquinas redondeadas
Abgerundete Ecken
- 4** Last pages tear-off
Ultime pagine staccabili
Dernières pages détachables
Páginas finales separables
Letzte Seiten heraustrennbar

- 5** Back document pocket
Taschina finale
Pochette mémos
Bolsillo final
Einschublasche hinten

PHOTO NOTEBOOK - MEDIUM

L 13 x H 21 cm

LINED NOTEBOOK

- 120 g/m² paper
- 164 pages, back document pocket, last 24 pages tear-off

TACCUINO A RIGHE

- Carta 120 g/m²
- 164 pagine, taschina finale, ultime 24 pagine staccabili

CARNET LIGNÉ

- Papier 120 g/m²
- 164 pages, pochette mémos, 24 dernières pages détachables

SOLD X 3

CUADERNO DE RAYAS

- Papel 120 g/m²
- 164 páginas, bolsillo final, últimas 24 páginas separables

LINIERTES NOTIZBUCH

- Papier 120 g/m²
- 164 Seiten, Einschublasche hinten, die letzten 24 Seiten sind heraustrennbar



GOLD/SILVER FOIL OR HOLO PRINT

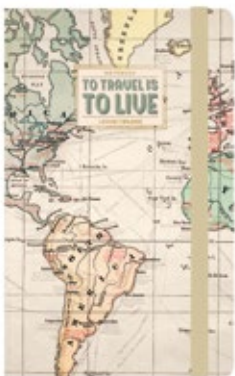
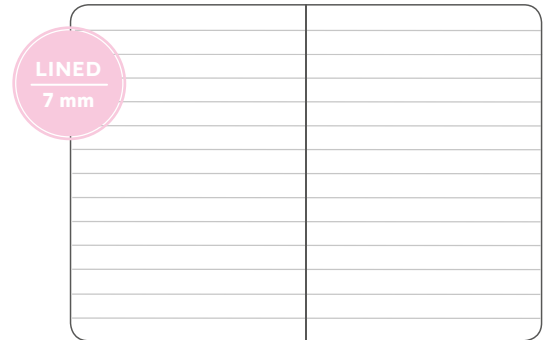

TRAVEL

NOTP0100



8 053610 786064



STARS

Written in the stars

NOTP0101



8 053610 786071



FLOWERS

NOTP0102



8 053610 786088



MAGIC

NOTP0103



8 053610 786095



GENIUS

NOTP0104



8 053610 786101



KITTY

NOTP0105



8 053610 786118



PANDA
Pantastic lilac

NOTP0106



8 053610 786125

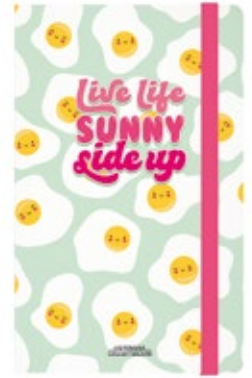

EGG

NOTP0107



8 053610 786132



BEE

NOTP0108



8 053610 786149



DAISY
Enjoy the little things

NOTP0109



8 053610 786156



UNICORN

NOTP0111



8 052694 010812

NEW

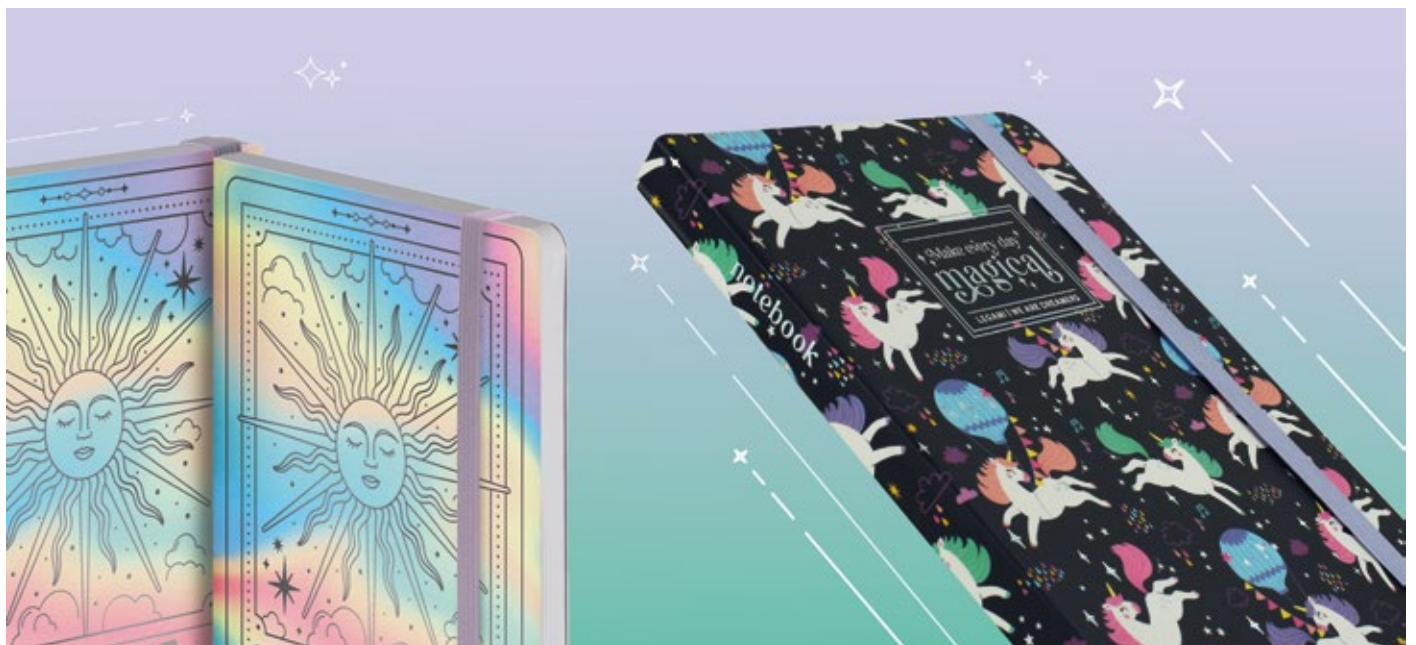



QUADERNO

+ NOTEBOOKS & JOURNALS +



GOLD/SILVER/RED FOIL
OR HOLO PRINT

QUADERNO - SMALL

L 9 x H 13.5 cm

LINED NOTEBOOK

- 100 g/m² white paper
- 80 pages
- Singer binding

QUADERNO A RIGHE

- Carta bianca 100 g/m²
- 80 pagine
- Rilegatura a punto Singer

CAHIER LIGNÉ

- Papier blanc 100 g/m²
- 80 pages
- Reliure par couture Singer

SOLD X 3

CUADERNO DE RAYAS

- Papel blanco 100 g/m²
- 80 páginas
- Encuadernación con cosido Singer

LINIERTES HEFT

- Weißes Papier 100 g/m²
- 80 Seiten
- Singer-Fadenheftung



LINED
7 mm

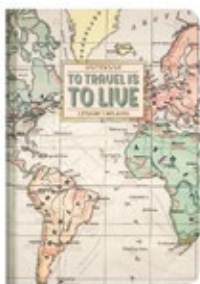

TRAVEL

A6NOT0013



8 051122 269723



DAISY

Today I choose happiness

A6NOT0025



8 054320 565208



HEART

A6NOT0031



8 053610 783216



STARS

Written in the stars

A6NOT0033



8 053610 787009

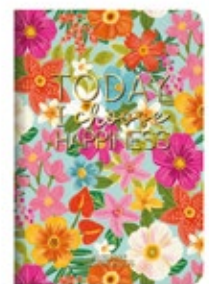

FLOWERS

A6NOT0034



8 053610 787016



MAGIC

A6NOT0035



8 053610 787023

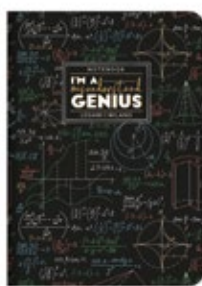

GENIUS

A6NOT0036



8 053610 787030



KITTY

A6NOT0037



8 053610 787047



PANDA

Pantastic lilac

A6NOT0038



8 053610 787054

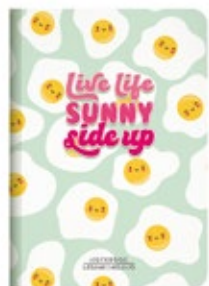

EGG

A6NOT0039



8 053610 787061



BEE

A6NOT0040



8 053610 787078



DAISY

Enjoy the little things

A6NOT0041



8 053610 787085



RED PANDA

A6NOT0043



8 052694 010836



UNICORN

A6NOT0044



8 052694 010843

GOLD/SILVER/RED FOIL
OR HOLO PRINT

QUADERNO - MEDIUM

L 14.2 x H 21 cm

LINED NOTEBOOK

- 100 g/m² white paper
- 80 pages
- Singer binding

QUADERNO A RIGHE

- Carta bianca 100 g/m²
- 80 pagine
- Rilegatura a punto Singer

CAHIER LIGNÉ

- Papier blanc 100 g/m²
- 80 pages
- Reliure par couture Singer

SOLD X 3

CUADERNO DE RAYAS

- Papel blanco 100 g/m²
- 80 páginas
- Encuadernación con cosido Singer

LINIERTES HEFT

- Weißes Papier 100 g/m²
- 80 Seiten
- Singer-Fadenheftung

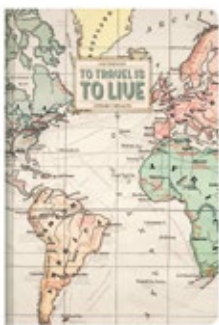
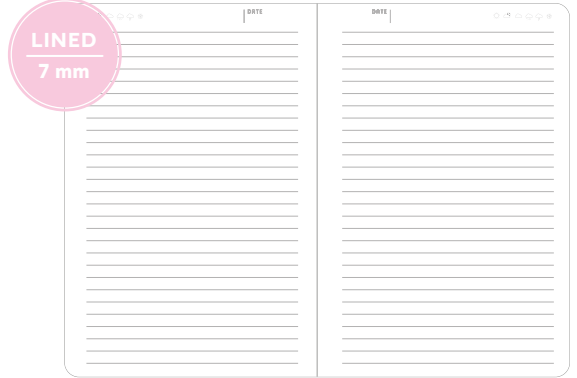
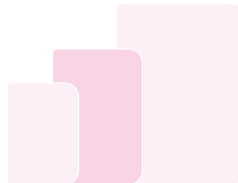

TRAVEL

A5NOT0013



8 051122 269761



DAISY

Today I choose happiness

A5NOT0042



8 054320 565284



HEART

A5NOT0056



8 053610 783223



STARS

Written in the stars

A5NOT0058



8 053610 787108



FLOWERS

A5NOT0059



8 053610 787115

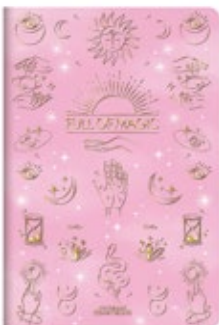

MAGIC

A5NOT0060



8 053610 787122



GENIUS

A5NOT0061



8 053610 787139



KITTY

A5NOT0062



8 053610 787146



PANDA

Pantastic lilac

A5NOT0063



8 053610 787153

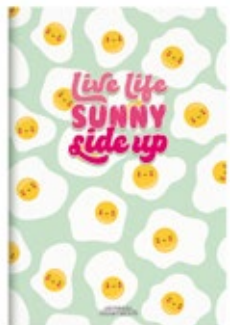

EGG

A5NOT0064



8 053610 787160



BEE

A5NOT0065



8 053610 787177

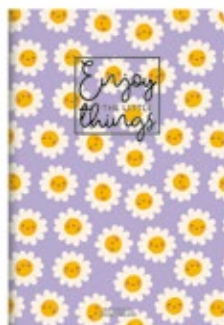

DAISY

Enjoy the little things

A5NOT0066



8 053610 787184



RED PANDA

A5NOT0078



8 052694 010874



UNICORN

A5NOT0079



8 052694 010881

GOLD/SILVER/RED FOIL
OR HOLO PRINT

QUADERNO - MEDIUM

L 14.2 x H 21 cm

PLAIN NOTEBOOK

- 100 g/m² white paper
- 80 pages
- Singer binding

QUADERNO BIANCO

- Carta bianca 100 g/m²
- 80 pagine
- Rilegatura a punto Singer

CAHIER BLANC

- Papier blanc 100 g/m²
- 80 pages
- Reliure par couture Singer

✳ While stock lasts

SOLD X 3

CUADERNO BLANCO

- Papel blanco 100 g/m²
- 80 páginas
- Encuadernación con cosido Singer

UNLINIERTES HEFT

- Weißes Papier 100 g/m²
- 80 Seiten
- Singer-Fadenheftung

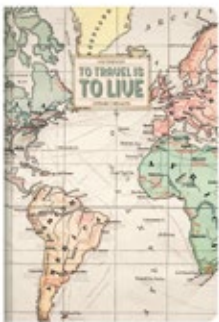
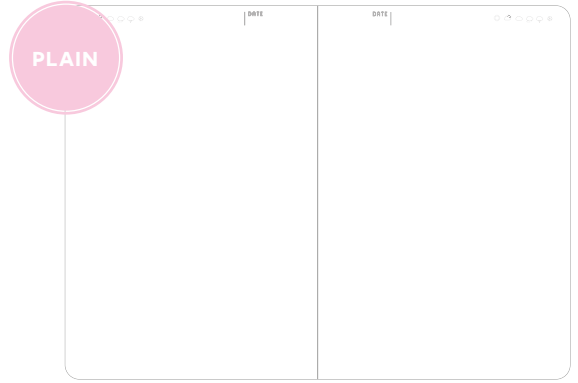
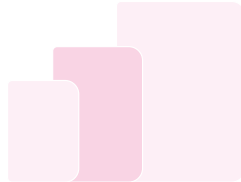

TRAVEL

A5NOT0023



8 051739 308075



FLORA

A5NOT0051 ✳



8 054320 565376



STARS

Written in the stars

A5NOT0068



8 053610 787207



FLOWERS

A5NOT0069



8 053610 787214



MAGIC

A5NOT0070



8 053610 787221



GENIUS

A5NOT0071



8 053610 787238



KITTY

A5NOT0072



8 053610 787245



PANDA

Pantastic lilac

A5NOT0073



8 053610 787252

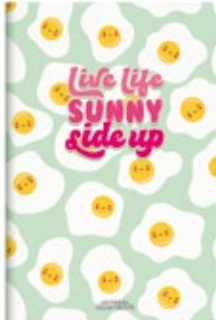

EGG

A5NOT0074



8 053610 787269



BEE

A5NOT0075



8 053610 787276

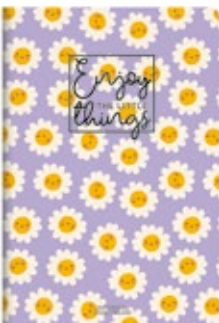

DAISY

Enjoy the little things

A5NOT0076



8 053610 787283



RED PANDA

A5NOT0081



8 052694 010904



UNICORN

A5NOT0082



8 052694 010911

GOLD/SILVER/RED FOIL
OR HOLO PRINT

QUADERNO - LARGE

L 18.5 x H 24.8 cm

LINED NOTEBOOK

- 100 g/m² white paper
- 100 pages
- Singer binding

QUADERNO A RIGHE

- Carta bianca 100 g/m²
- 100 pagine
- Rilegatura a punto Singer

CAHIER LIGNÉ

- Papier blanc 100 g/m²
- 100 pages
- Reliure par couture Singer

SOLD X 3

QUADERNO DE RAYAS

- Papel blanco 100 g/m²
- 100 páginas
- Encuadernación con cosido Singer

LINIERTES HEFT

- Weißes Papier 100 g/m²
- 100 Seiten
- Singer-Fadenheftung



TRAVEL

B5NOT0013



DAISY

Today I choose happiness

B5NOT0032



HEART

B5NOT0038



STARS

Written in the stars

B5NOT0040

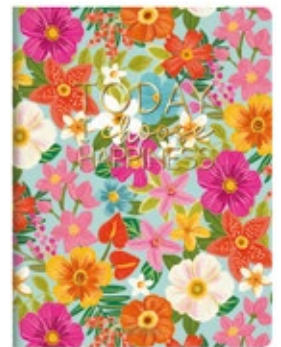

FLOWERS

B5NOT0041



MAGIC

B5NOT0042

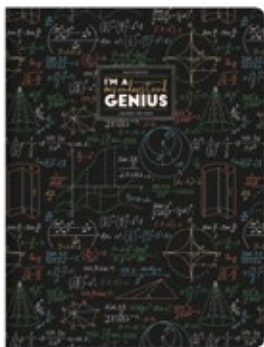

GENIUS

B5NOT0043



KITTY

B5NOT0044



PANDA

Pantastic lilac

B5NOT0045

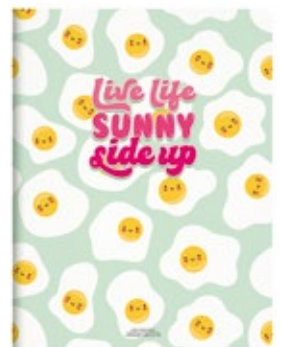

EGG

B5NOT0046



BEE

B5NOT0047



DAISY

Enjoy the little things

B5NOT0048



RED PANDA

B5NOT0050



UNICORN

B5NOT0051





SPIRAL NOTEBOOKS

+ NOTEBOOKS & JOURNALS +



GOLD/SILVER
FOIL

SPIRAL NOTEPAD - MINI

L 7 x H 10 cm

LINED SPIRAL-BOUND NOTEPAD

- 80 g/m² white paper
- 220 pages

BLOCK-NOTES SPIRALATO A RIGHE

- Carta bianca 80 g/m²
- 220 pagine

BLOC-NOTES LIGNÉ À SPIRALE

- Papier blanc 80 g/m²
- 220 pages

SOLD X 3

BLOC DE NOTAS DE RAYAS CON ESPIRAL

- Papel blanco 80 g/m²
- 220 páginas

LINIERTES NOTIZBLOCK MIT SPIRALBINDUNG

- Weißes Papier 80 g/m²
- 220 Seiten

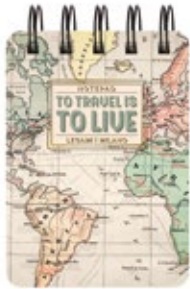
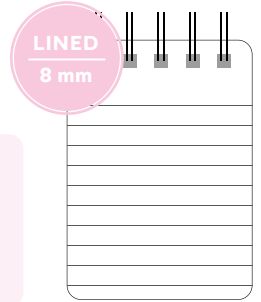
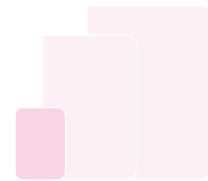

TRAVEL

MNOTS0002



8 058093 949241



STARS

Written in the stars

MNOTS0021



8 053610 786767



FLOWERS

MNOTS0022



8 053610 786774



KITTY

MNOTS0023



8 053610 786781



SPIRAL NOTEBOOK - LARGE



L 15 x H 21 cm

LINED SPIRAL-BOUND NOTEBOOK

- 160 pages
- 80 g/m² white paper
- Sticker sheet inside

QUADERNO SPIRALATO A RIGHE

- 160 pagine
- Carta bianca 80 g/m²
- 1 foglio di adesivi

CAHIER LIGNÉ À SPIRALE

- 160 pages
- Papier blanc 80 g/m²
- Contient 1 feuille d'autocollants

CUADERNO DE RAYAS CON ESPIRAL

- 160 páginas
- Papel blanco de 80 g/m²
- 1 hoja con pegatinas

LINIERTES HEFT MIT SPIRALBINDUNG

- 160 Seiten
- Weißes Papier 80 g/m²
- 1 Bogen mit Aufklebern

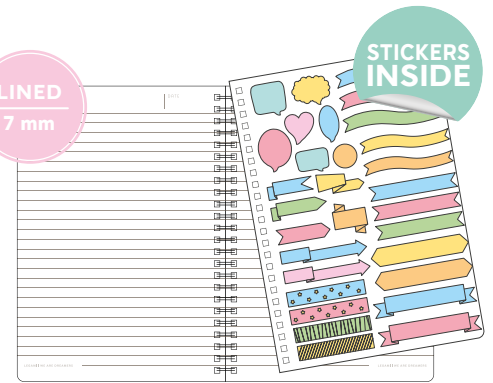

SOLD X 3



TRAVEL

A5NOTS0044



RED PANDA

A5NOTS0046



UNICORN

A5NOTS0047

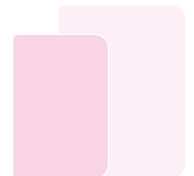

SPIRAL NOTEBOOK - MAXI



L 21 x H 29 cm

LINED SPIRAL-BOUND NOTEBOOK

- 160 pages
- 80 g/m² white paper
- Sticker sheet inside

QUADERNO SPIRALATO A RIGHE

- 160 pagine
- Carta bianca 80 g/m²
- 1 foglio di adesivi

CAHIER LIGNÉ À SPIRALE

- 160 pages
- Papier blanc 80 g/m²
- Contient 1 feuille d'autocollants

CUADERNO DE RAYAS CON ESPIRAL

- 160 páginas
- Papel blanco de 80 g/m²
- 1 hoja con pegatinas

LINIERTES HEFT MIT SPIRALBINDUNG

- 160 Seiten
- Weißes Papier 80 g/m²
- 1 Bogen mit Aufklebern



SOLD X 3



TRAVEL

A4NOTS0054



RED PANDA

A4NOTS0056



UNICORN

A4NOTS0057

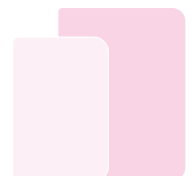

POP MATERIAL

WINDOW DISPLAY
L 29.7 x H 42 cm

Order the whole range of Large and Maxi Spiral Notebooks and you will receive a window display.

A4-A5NOTS-GROUP



GOLD/SILVER FOIL
OR HOLO PRINT

SPIRAL NOTEBOOK - LARGE

L 15.5 x H 21 cm

LINED SPIRAL-BOUND NOTEBOOK

- 100 g/m² white paper
- 200 tear-off pages
- Elastic closure and back document pocket

QUADERNO SPIRALATO A RIGHE

- Carta bianca 100 g/m²
- 200 pagine staccabili
- Elastico di chiusura e taschina finale

SOLD X 3

CAHIER LIGNÉ À SPIRALE

- Papier blanc 100 g/m²
- 200 pages détachables
- Fermeture élastique et pochette mémos

CUADERNO DE RAYAS CON ESPIRAL

- Papel blanco 100 g/m²
- 200 páginas separables
- Elástico de cierre y bolsillo final



LINED
7 mm

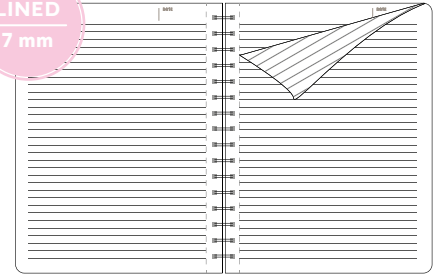

TRAVEL

A5NOTS0014



8 051739 307160



DAISY

Today I choose happiness

A5NOTS0028



8 054320 565529



STARS

Written in the stars

A5NOTS0035



8 053610 786804



FLOWERS

A5NOTS0036



8 053610 786811



MAGIC

A5NOTS0037



8 053610 786828



GENIUS

A5NOTS0038



8 053610 786835



KITTY

A5NOTS0039



8 053610 786842



PANDA

Pantastic lilac

A5NOTS0040



8 053610 786859

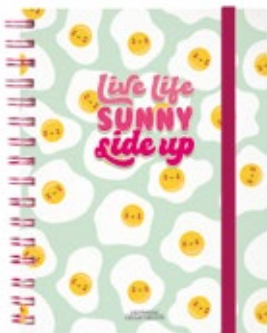

EGG

A5NOTS0041



8 053610 786866



BEE

A5NOTS0042



8 053610 786873



DAISY

Enjoy the little things

A5NOTS0043



8 053610 786880

GOLD/SILVER FOIL
OR HOLO PRINT

TRIO SPIRAL NOTEBOOK - MAXI

L 22 x H 29.5 cm

3-IN-1 SPIRAL-BOUND NOTEBOOK

- 100 g/m² white paper
- 204 tear-off pages: 68 lined, 68 squared, 68 dotted
- Elastic closure and back document pocket

QUADERNO SPIRALATO 3 IN 1

- Carta bianca 100 g/m²
- 204 pagine staccabili: 68 a righe, 68 a quadretti, 68 a puntini
- Elastico di chiusura e taschina finale

CAHIER À SPIRALE 3-EN-1

- Papier blanc 100 g/m²
- 204 pages détachables : 68 lignées, 68 à carreaux, 68 à pointillés
- Fermeture élastique et pochette mémos

* While stock lasts

SOLD X 3

CUADERNO CON ESPIRAL 3 EN 1

- Papel blanco 100 g/m²
- 204 páginas separables: 68 de rayas, 68 de cuadros, 68 de puntos
- Elástico de cierre y bolsillo final

3-IN-1 HEFT MIT SPIRALBINDUNG

- Weißes Papier 100 g/m²
- 204 heraustrennbare Seiten: 68 linierte, 68 karierte, 68 punktierte
- Gummiband zum Verschließen und Einschubtasche hinten

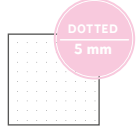
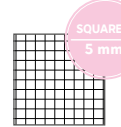
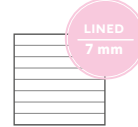
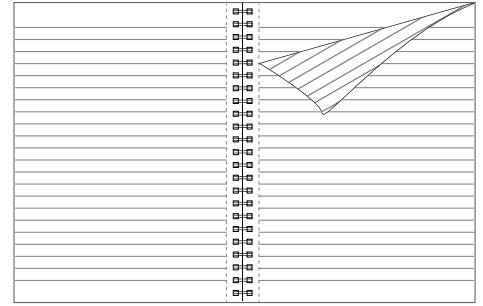

TRAVEL

A4NOTS0026



8 059174 834760



TROPICAL

A4NOTS0037 *



8 054320 565598



FLORA

A4NOTS0039 *



8 054320 565611



FLASH

A4NOTS0043



8 054320 565659



STARS

Written in the stars

A4NOTS0045



8 053610 786903



FLOWERS

A4NOTS0046



8 053610 786910



MAGIC

A4NOTS0047



8 053610 786927



GENIUS

A4NOTS0048



8 053610 786934



KITTY

A4NOTS0049



8 053610 786941



PANDA

Pantastic lilac

A4NOTS0050



8 053610 786958

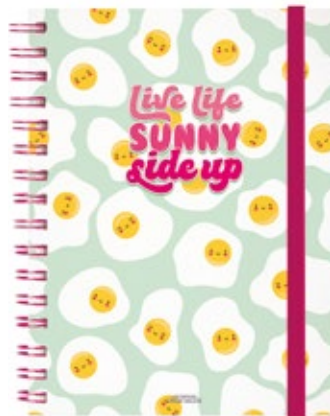

EGG

A4NOTS0051



8 053610 786965



BEE

A4NOTS0052



8 053610 786972



DAISY

Enjoy the little things

A4NOTS0053



8 053610 786989

DISPLAYS ON DEMAND

Products not included

NOTEBOOK FLOOR SPINNER DISPLAY

material: acrylic and wood
L 47.5 x H 185 x W 47.5 cm

1 SMALL SECTION:
• small: 48 pcs

SMALL:
H 17.3 cm

3 MEDIUM SECTIONS:
• medium: 120 pcs

MEDIUM:
H 23.8 cm

2 LARGE SECTIONS:
• large: 64 pcs

LARGE:
H 27.3 cm

TOTAL CAPACITY: 232 PCS



DISNOTGREY2



NOTEBOOK COUNTER DISPLAY

Counter empty display
on demand
material: cardboard
L 29.5 x H 28.5 x W 27 cm

DISDIAS



MEDIUM

MEDIUM

SMALL



COLOURS COLLECTION

MOQ: 30 pcs
(medium, small)

MEDIUM

SMALL

MINI
SPIRAL



PHOTO COLLECTION

MOQ: 30 pcs
(medium, small, mini spiral)



NOTEBOOK FLOOR DISPLAY

Floor empty display
on demand
material: cardboard, wooden base
L 58.5 x H 158 x W 39 cm

DISDIAM



SMALL

SMALL

MEDIUM

MEDIUM

MEDIUM

LARGE



COLOURS COLLECTION

MOQ:
• small: 60 pcs
• medium: 90 pcs
• large: 30 pcs

SMALL

MINI
SPIRAL

MEDIUM

LARGE
SPIRAL

LARGE

MAXI
SPIRAL



PHOTO COLLECTION

MOQ:
• small: 30 pcs
• mini spiral: 18 pcs
• medium: 30 pcs
• large spiral: 24 pcs
• large: 24 pcs
• maxi spiral: 21 pcs



HOME SWEET HOME
Create Your Happy Place

Make your home your own

SUPER CHEF

L 65.5 x H 84 cm (without loop)

APRON

- Front pocket
- Adjustable: pull the strap through the drawstring opening to achieve the perfect fit
- Material: 73% polyester, 16% cotton, 11% viscose

GREMBIULE

- Tasca frontale
- Regolabile: far scorrere il laccio nella coulisse per avere la misura desiderata
- Materiale: 73% poliestere, 16% cotone, 11% viscosa

TABLIER

- Poche avant
- Réglable: faire glisser le lien dans la coulisse pour obtenir la longueur souhaitée
- Matériau: 73% polyester, 16% coton, 11% viscose

DELANTAL

- Bolsillo frontal
- Ajustable: pasar el cordón por la abertura para ajustarlo a la medida deseada
- Material: 73 % poliéster, 16 % algodón, 11 % viscosa

SCHÜRZE

- Vordertasche
- Verstellbar: Band durch den Durchzug ziehen, um die gewünschte Größe zu erreichen
- Material: 73 % Polyester, 16 % Baumwolle, 11 % Viskose

PACKAGING

cardboard tube
Ø 8.5 cm, H 24.5 cm
SOLD X 4



SINGLE SIZE



MACHINE WASHABLE



HANG-UP LOOP



LARGE POCKET

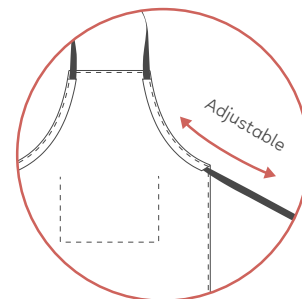

BOSS
APR0001



EGG
APR0002



SERIAL GRILLER
APR0003



MEAL PLANNER

L 9 x H 23 x W 1.3 cm (closed)

MEAL PLANNER

- 2 notepads, each with 30 tear-off sheets
- 80 g/m² paper
- Wooden pencil included
- Material: paper. Rigid cardboard backing

PLANNER MENÙ
SETTIMANALE

- 2 blocchi note con 30 fogli staccabili ognuno
- Carta 80 g/m²
- Matita di legno inclusa
- Materiale: carta. Supporto in cartoncino rigido

PLANIFICATEUR DE REPAS

- 2 blocs-notes avec chacun 30 feuilles détachables
- Papier 80 g/m²
- Crayon en bois inclus
- Matériau : papier. Support en carton rigide

PLANIFICADOR DEL MENÙ

- 2 blocs de notas con 30 hojas separables cada uno
- Papel 80 g/m²
- Lápiz de madera incluido
- Material: papel. Soporte de carton rigido

ESSENSPLAN

- 2 Notizblöcke mit je 30 abreißbaren Seiten
- Papier 80 g/m²
- Inklusive Bleistift
- Material: Papier. Basis aus stabilem Karton

PACKAGING
cello sleeve w/inner side on show
L 9.5 x H 23.6
x W 1.3 cm

SOLD X 6

MEP0001



RECIPE BOOK

L 22 x H 28 x W 13 cm

RECIPE COLLECTION FOLDER

- 6 cardboard dividers
- 50 browsable transparent pockets
- Material: paper, plastic. Rigid cardboard backing

RACCOGLITORE PORTA-RICETTE

- 6 separatori in cartoncino
- 50 buste sfogliabili trasparenti
- Materiale: carta, plastica. Supporto in cartoncino rigido

CLASSEUR PORTE-RECETTES

- 6 séparateurs en carton
- 50 enveloppes transparentes à feuilletter
- Matériau : papier, plastique. Support en carton rigide

* While stock lasts

RECOPIADOR DE RECETAS

- 6 separadores de cartón
- 50 sobres hojeables transparentes
- Material: papel, plástico. Soporte de cartón duro

ORDNER FÜR REZEPTE

- 6 Trennblätter aus Karton
- 50 transparente Hüllen zum Umblättern
- Material: Papier, Kunststoff. Basis aus stabilem Karton

PACKAGING

view top box
w/cardboard base
L 23.5 x H 29.5 x W 4 cm

SOLD X 2

REC0002 *

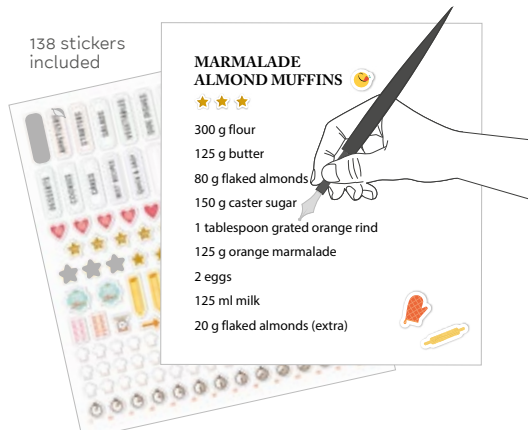

138 stickers included

MARMALADE
ALMOND MUFFINS

- ★★★★
- 300 g flour
- 125 g butter
- 80 g flaked almonds
- 150 g caster sugar
- 1 tablespoon grated orange rind
- 125 g orange marmalade
- 2 eggs
- 125 ml milk
- 20 g flaked almonds (extra)



Rigid cardboard backing

KITCHEN TIMER

KITCHEN TIMER

- 60 minutes, manually adjustable
- Material: plastic

TIMER DA CUCINA

- 60 minuti, regolabile manualmente
- Materiale: plastica

MINUTEUR DE CUISSON

- 60 minutes, réglable manuellement
- Matériau : plastique

TEMPORIZADOR DE COCINA

- 60 minutos, regulable manualmente
- Material: plástico

KÜCHEN-TIMER

- 60 Minuten, manuell einstellbar
- Material: Kunststoff

PACKAGING

PVC box w/hook
L 6.7 x H 14 x W 6.5 cm

SOLD X 4

AVOCADO

KT0003



8 059174 834418



Ø 6 cm, H 9 cm



No batteries
needed

PACKAGING

PVC box w/hook
L 7 x H 10.5 x W 6.5 cm

SOLD X 4

LADYBUG

KT0001



8 052783 615515



Ø 6 cm, H 4 cm



PACKAGING

PVC box w/hook
L 7 x H 10.5 x W 6.5 cm

SOLD X 4

PANDA

KT0002



8 052783 615522



Ø 6 cm, H 5 cm



MICROWAVE CLEANER

Ø 14 cm, H 12 cm

MICROWAVE CLEANER

- Dissolves dirt deposits in just over 5 minutes
- Material: plastic

PULISCI MICROONDE

- Scioglie le incrostazioni di sporco in poco più di 5 minuti
- Materiale: plastica

NETTOYANT POUR MICRO-ONDES

- Il fait fondre les saletés incrustées en à peine plus de 5 minutes
- Matériau : plastique

LIMPIADOR DE MICROONDAS

- Disuelve las incrustaciones de suciedad en poco más de 5 minutos
- Material: plástico

MIKROWELLENREINIGER

- Löst verkrusteten Schmutz in knapp mehr als 5 Minuten
- Material: Kunststoff



PACKAGING

cardboard box
L 14 x H 12.5 x W 14 cm

SOLD X 4

VOC0001



Double-walled base specifically designed to keep the outer layer cool

BAG CLIPS

SET OF BAG CLIPS

- Material: plastic

SET DE CLIPS DE FERMETURE POUR SACHETS

- Matériau : plastique

SET MIT VERSCHLUSS-CLIPS FÜR VERPACKUNGEN

- Material: Kunststoff

SET DI CLIP CHIUDI PACCO

- Materiale: plastica

SET DE PINZAS PARA CERRAR PAQUETES

- Material: plástico

SOLD X 6

MUSICAL NOTE

L 5.5 x H 5 x W 1.5 cm



PACKAGING

cello sleeve
w/cardboard
L 9.3 x H 21 cm

CLIP0001



PANDA

L 4 x H 3.3 x W 4 cm



PACKAGING

cello sleeve
w/cardboard
L 9.3 x H 21 cm

CLIP0002



HEART

L 4.5 x H 4 x W 3 cm

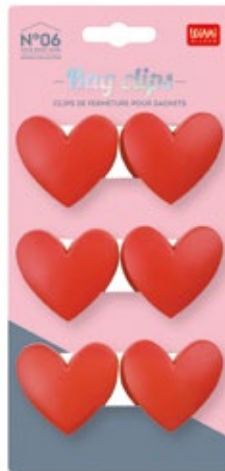

PACKAGING

cello sleeve
w/cardboard
L 10 x H 21 cm

CLIP0004



COOKIE

L 5 x H 5 x W 3.4 cm



PACKAGING

cello sleeve
w/cardboard
L 10 x H 17.5 cm

CLIP0003



AVOCADO

L 4.3 x H 5.5 x W 3 cm



PACKAGING

cello sleeve
w/cardboard
L 12.5 x H 17.5 cm

CLIP0005



MOVIE NIGHT FOR TWO

bucket: L 13 x H 21.5 x W 13 cm
tumblers: Ø 10 cm, H 16 cm

POPCORN BUCKET AND TUMBLER SET

- Tumblers with lids and straws
- Material: PP, AS

SET DI UN CONTENITORE PER POPCORN E DUE BICCHIERI

- Bicchieri con tappo a vite e cannuccia
- Materiale: PP, AS

SET BOÎTE À POPCORN ET DEUX GOBELETS

- Gobelets avec couvercle à visser et paille
- Matériau : PP, AS

SET DE UN CUBO PARA PALOMITAS Y DOS VASOS

- Vasos con tapón enroscable y pajita
- Material: PP, AS

* While stock lasts

SET MIT EINEM POPCORNBEHÄLTER UND ZWEI BECHERN

- Becher mit Schraubdeckel und Strohhalm
- Material: PP, AS

PACKAGING

cardboard box
L 24.5 x H 22 x W 14 cm

SOLD X 3

FIK0001 *



8 054117 620967

**POPCORN BUCKET**

Ø 17.5 cm, H 17.5 cm

POPCORN BUCKET

- Material: PP

CONTENITORE PER POPCORN

- Materiale: PP

BOÎTE À POPCORN

- Matériau : PP

CUBO PARA PALOMITAS

- Material: PP

POPCORNBEHÄLTER

- Material: PP

**SOLD X 6**

PCB0001



8 051739 306743

SAUCE DISPENSER GUN

L 22 x H 16.5 x W 5.5 cm

SAUCE DISPENSER GUN

- Contains two reusable containers for sauces
- Material: ABS, PE

PISTOLA SPARA SALSJE

- Contiene due contenitori per salse riutilizzabili
- Materiale: ABS, PE

PISTOLET DISTRIBUTEUR DE SAUCES

- Il contient deux réservoirs à sauces réutilisables
- Matériau : ABS, PE

PISTOLA PARA SALSAS

- Contiene dos recipientes reutilizables para salsas
- Material: ABS, PE

PISTOLE ALS SAUCENSPENDER

- Enthält zwei wiederverwendbare Behälter für Saucen
- Material: ABS, PE



100 ml

100 ml

PACKAGING

cardboard box
L 23 x H 16.2 x W 5.7 cm

SOLD X 4

BCG0001



8 051739 307023



LOOKIN' PINE

L 1.7 x H 7.5 x W 1.5 cm

SET OF 6 APERITIF FORKS

- Reusable and durable
- Material: stainless steel and silicone

SET DI 6 FORCHETTINE PER APERITIVO

- Riutilizzabili e durevoli
- Materiale: acciaio inox e silicone

SET DE 6 PETITES FOURCHETTES POUR L'APÉRITIF

- Réutilisables et durables
- Matériau : acier inox et silicone

SET DE 6 TENEDORES PEQUEÑOS DE APERITIVO

- Reutilizables y duraderos
- Material: acero inoxidable y silicona

SET MIT 6 APERITIF-GÄBELCHEN

- Wiederverwendbar und langlebig
- Material: Edelstahl und Silikon

PACKAGING

PVC box w/hook
L 20 x H 12 x W 2 cm

SOLD X 6

PICK0003



MEOW

L MAX 3.4 x H MAX 9 x W 0.4 cm

SET OF 6 APERITIF FORKS

- Reusable and durable
- Material: stainless steel and silicone

SET DI 6 FORCHETTINE PER APERITIVO

- Riutilizzabili e durevoli
- Materiale: acciaio inox e silicone

SET DE 6 PETITES FOURCHETTES POUR L'APÉRITIF

- Réutilisables et durables
- Matériau : acier inox et silicone

SET DE 6 TENEDORES PEQUEÑOS DE APERITIVO

- Reutilizables y duraderos
- Material: acero inoxidable y silicona

SET MIT 6 APERITIF-GÄBELCHEN

- Wiederverwendbar und langlebig
- Material: Edelstahl und Silikon

PACKAGING

PVC box w/hook
L 20 x H 12 x W 2 cm

SOLD X 6

PICK0001



MEOW

L 2 x H 3.5 x W 0.8 cm

SET OF 6 DRINK MARKERS

- Reusable and durable
- Material: silicone

SET DI 6 SEGNABICCHIERI

- Riutilizzabili e durevoli
- Materiale: silicone

SET DE 6 MARQUE-VERRES

- Réutilisables et durables
- Matériau : silicone

SET DE 6 MARCADORES DE VASOS

- Reutilizables y duraderos
- Material: silicona

SET MIT 6 GLASMARKIERERN

- Wiederverwendbar und langlebig
- Material: Silikon

**PACKAGING**cardboard box
L 9 x H 12.5 x W 1.6 cm**DISPLAY**material: cardboard
L 10 x H 19.7 x W 14 cm**8 PCS**

DRMAKIT7



8 052694 003807

**OVER THE TOP**

L 1.5 x H 3 x W 1.8 cm

SET OF 6 DRINK MARKERS

- Reusable and durable
- Material: silicone

SET DI 6 SEGNABICCHIERI

- Riutilizzabili e durevoli
- Materiale: silicone

SET DE 6 MARQUE-VERRES

- Réutilisables et durables
- Matériau : silicone

SET DE 6 MARCADORES DE VASOS

- Reutilizables y duraderos
- Material: silicona

SET MIT 6 GLASMARKIERERN

- Wiederverwendbar und langlebig
- Material: Silikon

**PACKAGING**cardboard box
L 9.5 x H 12 x W 2.3 cm**DISPLAY**material: cardboard
L 10 x H 22.3 x W 18.8 cm**8 PCS**

DRMAKIT6



8 051128 755824



FIESTA!

L MAX 1.8 x H MAX 2.9 x W 1.5 cm

SET OF 6 DRINK MARKERS

- Reusable and durable
- Material: silicone

SET DI 6 SEGNABICCHIERI

- Riutilizzabili e durevoli
- Materiale: silicone

SET DE 6 MARQUE-VERRES

- Réutilisables et durables
- Matériau : silicone

SET DE 6 MARCADORES DE VASOS

- Reutilizables y duraderos
- Material: silicona

SET MIT 6 GLASMARKIERERN

- Wiederverwendbar und langlebig
- Material: Silikon



PACKAGING

cardboard box
L 9 x H 12.5 x W 1.6 cm



DISPLAY

material: cardboard
L 10 x H 19.7 x W 14 cm

8 PCS

DRMAKIT1

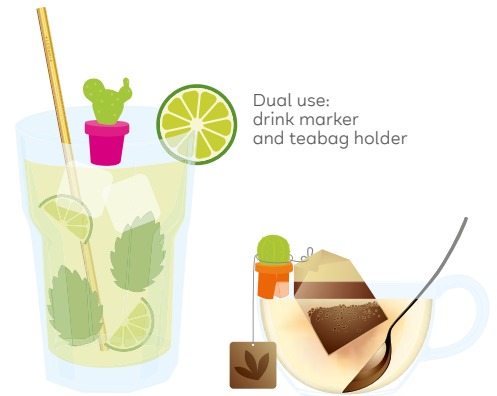

LOVE IS IN THE GLASS

L 2 x H 1.8 x W 1 cm

SET OF 6 DRINK MARKERS

- Reusable and durable
- Material: silicone

SET DI 6 SEGNABICCHIERI

- Riutilizzabili e durevoli
- Materiale: silicone

SET DE 6 MARQUE-VERRES

- Réutilisables et durables
- Matériau : silicone

SET DE 6 MARCADORES DE VASOS

- Reutilizables y duraderos
- Material: silicona

SET MIT 6 GLASMARKIERERN

- Wiederverwendbar und langlebig
- Material: Silikon



PACKAGING

cardboard box
L 9 x H 12.5 x W 1.6 cm



DISPLAY

material: cardboard
L 9.6 x H 19.8 x W 14 cm

8 PCS

DRMAKITS



REUSABLE ICE CUBES

REUSABLE ICE CUBES

- The packaging contains 16 pieces
- Pre-filled with water
- Material: plastic, water

CUBETTI DI GHIACCIO RIUTILIZZABILI

- La confezione contiene 16 forme
- Pre-riempiti con acqua
- Materiale: plastica, acqua

GLAÇONS RÉUTILISABLES

- L'emballage contient 16 formes
- Pré-remplis avec de l'eau
- Matériau : plastique, eau

CUBITOS DE HIELO REUTILIZABLES

- El envase contiene 16 formas
- Rellenados previamente con agua
- Material: plástico, agua

WIEDERVERWENDBARE EISWÜRFEL

- Die Verpackung enthält 16 Formen
- Mit Wasser vorgefüllt
- Material: Kunststoff, Wasser



TROPICAL

PACKAGING

plastic shaker
Ø 7.5 cm, H 16.5 cm
SOLD X 4

ICS0001



8 059174 839918



DIAMONDS

PACKAGING

plastic shaker
Ø 7.5 cm, H 16.5 cm
SOLD X 4

ICS0002



8 059174 839925



STAINLESS STEEL STRAWS

STAINLESS STEEL STRAWS

- Brush included for easy hand washing
- Material: stainless steel

CANNUCCE IN ACCIAIO INOX

- Scovolino incluso per una facile pulizia a mano
- Materiale: acciaio inox

PAILLES EN ACIER INOX

- Goupillon inclus, pour un nettoyage facile à la main
- Matériau : acier inox

PAJITAS DE ACERO INOXIDABLE

- Cepillo incluido para una fácil limpieza a mano
- Material: acero inoxidable

STROHHALME AUS EDELSTAHL

- Inklusive kleiner Bürste zum einfachen Reinigen von Hand
- Material: Edelstahl



STANDARD SIZE

Ø 0.6 cm, H 21.5 cm



PACKAGING

window box
L 8 x H 25 x W 1.5 cm
SOLD X 6

STRW0001 GOLD



8 052461 962597

Set of 6



COCKTAIL SIZE

Ø 0.6 cm, H 13.5 cm



PACKAGING

window box
L 6 x H 16 x W 1.5 cm
SOLD X 6

STRW0002 GOLD



8 052461 962603

Set of 6



DISHWASHER SAFE

EASY TO CLEAN

ANTI-RUST

CHEERS TO LOVE

Ø 5 cm, H 22.5 cm - 150 ml

SET OF 2 CHAMPAGNE FLUTES

- Material: glass (lead free)

SET DI 2 FLÛTE

- Materiale: vetro (senza piombo)

SET DE 2 FLÛTES À CHAMPAGNE

- Matériau : verre (sans plomb)

SET DE 2 FLAUTAS

- Material: vidrio (sin plomo)

2ER-SET SEKTLÖTEN

- Material: Glas (bleifrei)

SOLD X 4**PACKAGING**window box
L 14.5 x H 23 x W 7.2 cm

GLA0001

**CHEERS**

L MAX 11 x H MAX 14.5 cm

DRINKING JAR WITH LID AND STRAW

- Stainless steel screw lid
- Material: glass, plastic, stainless steel

BICCHIERE IN VETRO CON TAPPO E CANNUCCIA

- Tappo a vite in acciaio inox
- Materiale: vetro, plastica, acciaio inox

GOBELET EN VERRE AVEC COUVERCLE ET PAILLE

- Couvercle en acier inox à visser
- Matériau : verre, plastique, acier inoxydable

VASO DE VIDRIO CON TAPADERA Y PAJITA

- Tapadera de rosca de acero inoxidable
- Material: vidrio, plástico, acero inoxidable

TRINKGLAS MIT DECKEL UND TRINKHALM

- Deckel aus Edelstahl mit Schraubverschluss
- Material: Glas, Kunststoff, Edelstahl

* While stock lasts

SOLD X 4

Without lid and straw

**FLAMINGO**

JAR0001 *

**CACTUS**

JAR0002



COOLING BEER MUG

Ø 8.5 cm, H 15.5 cm - 440 ml

COOLING BEER MUG

- Keeps beer (or any other drink) fresh for longer
- Double wall containing a fast-freezing amber liquid
- Ready to use after just 2 hours in the freezer
- Material: PS, EPS, cooling liquid

BOCCALE DI BIRRA REFRIGERANTE

- Mantiene la birra (o qualsiasi altra bevanda) fresca più a lungo
- Doppia parete contenente un liquido ambrato a rapido congelamento
- Pronto all'uso dopo solo 2 ore di freezer
- Materiale: PS, EPS, liquido refrigerante

CHOPE À BIÈRE RÉFRIGÉRANTE

- Elle maintient la bière (ou n'importe quelle autre boisson) fraîche plus longtemps
- Double paroi contenant un liquide ambré à congélation rapide
- Prête à l'emploi après seulement 2 heures au congélateur
- Matériau : PS, EPS, liquide réfrigérant

JARRA DE CERVEZA REFRIGERANTE

- Mantiene la cerveza (o cualquier otra bebida) fresca durante más tiempo
- Doble pared que contiene un líquido ambarino de congelación rápida
- Lista para el uso después de solo 2 horas de congelador en la nevera
- Material: PS, EPS, líquido refrigerante

KÜHLENDER BIERKRUG

- Hält Bier (oder andere Getränke) länger kühl
- Die Doppelwand enthält eine bernsteinfarbene Flüssigkeit, die schnell kühlt
- Nach nur 2 Stunden im Gefrierschrank einsatzbereit
- Material: PS, EPS, Kühlflüssigkeit

PACKAGING

window box
L 11 x H 16.5 x W 11 cm
SOLD X 4

BMUG0001

**SHOT GLASSES**

Ø 5 cm, H 6 cm - 25 ml

SET OF 4 SHOT GLASSES

- Material: transparent glass

SET DI 4 BICCHIERINI DA LIQUORE

- Materiale: vetro trasparente

SET DE 4 MINI VERRES À LIQUEUR

- Matériau : verre transparent

SET DE 4 VASOS DE CHUPITO

- Material: vidrio transparente

SET MIT 4 MINI-LIKÖRGLÄSERN

- Material: transparentes Glas

PACKAGING

PVC box
L 11.5 x H 8.5 x W 11.5 cm
SOLD X 4

SHOT0001



WINE SET

WINE SET

- Set of stainless steel accessories in a bottle-shaped case
- Small: corkscrew, ring drip stopper, pouring stopper
- Large: corkscrew, bottle opener, ring drip stopper, standard stopper, pouring stopper
- Material: stainless steel, plastic

SET DA VINO

- Set di accessori in acciaio inox in custodia a forma di bottiglia
- Small: cavatappi, anello salva-goccia, tappo versatore
- Large: cavatappi, levacapsule, anello salva-goccia, tappo standard, tappo versatore
- Materiale: acciaio inox, plastica

SET DE VIN

- Set d'accessoires en acier inox dans un étui en forme de bouteille
- Small : tire-bouchon, bague anti-goutte, bouchon verseur
- Large : tire-bouchon, décapsuleur, bague anti-goutte, bouchon standard, bouchon verseur
- Matériau : acier inox, plastique

SET DE VINO

- Set de accesorios en acero inoxidable en estuche con forma de botella
- Small: sacacorchos, anillo antigoteo, tapón decantador
- Large: sacacorchos, cortacápsulas, anillo antigoteo, tapón estándar, tapón decantador
- Material: acero inoxidable, plástico

WEIN-SET

- Zubehör-Set aus Edelstahl in einem flaschenförmigen Etui
- Small: Korkenzieher, Tropfenauffangring, Gießverschluss
- Large: Korkenzieher, Flaschenöffner, Tropfenauffangring, Standardverschluss, Gießverschluss
- Material: Edelstahl, Kunststoff



* While stock lasts

SMALL

3 accessories
Ø 6.5 cm,
H 23.5 cm



PACKAGING
cardboard box
L 7 x H 24 x W 7 cm
SOLD X 4



LARGE

5 accessories
Ø 7.5 cm,
H 32.5 cm



PACKAGING
cardboard box
L 8 x H 33 x W 8 cm
SOLD X 4



BOTTLE OPENER

Ø 2.4 cm, H 11.5 cm

BOTTLE OPENER

- Practical and functional
- 2-in-1 function: corkscrew and bottle opener
- Material: stainless steel, ABS

APRIBOTTIGLIE

- Pratico e funzionale
- Funzione 2 in 1: cavatappi e apribottiglie
- Materiale: acciaio inox, ABS

OUVRE-BOUETTEILLE

- Pratique et fonctionnel
- Fonction 2 en 1 : tire-bouchon et ouvre-bouteille
- Matériau : acier inox, ABS

ABREBOTELLAS

- Práctico y funcional
- Función 2 en 1: sacacorchos y abrebotellas
- Material: acero inoxidable, ABS

FLASCHENÖFFNER

- Praktisch und funktionell
- 2-in-1-Funktion: Korkenzieher und Flaschenöffner
- Material: Edelstahl, ABS

**PACKAGING**

cardboard box
L 4.5 x H 14 x W 4 cm

**DISPLAY**

material: cardboard
L 15 x H 21 x W 13 cm
9 PCS

BOPKIT1

8 051128 754537

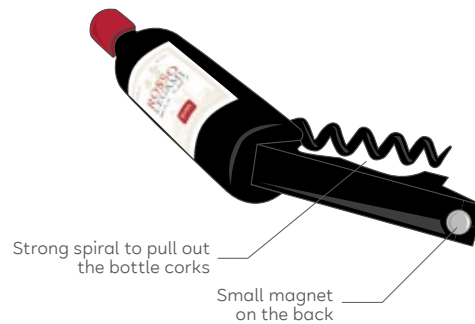
**WINE VACUUM STOPPERS**

Ø 3.3 cm, H 5.7 cm

SET OF 2 VACUUM STOPPERS FOR WINE

- Material: plastic, silicone seal

SET DI 2 TAPPI SOTTOVUOTO PER IL VINO

- Materiale: plastica, guarnizione in silicone

SET DE 2 BOUCHONS POMPE À VIN

- Matériau : plastique, joint en silicone

SET DE 2 TAPONES DE VACÍO PARA EL VINO

- Material: plástico, junta de sellado en silicona

SET MIT 2 VAKUUM-VERSCHLÜSSEN FÜR WEINFLASCHEN

- Material: Kunststoff, Dichtung aus Silikon

**PACKAGING**

carded
L 10 x H 13 cm

**DISPLAY**

material: cardboard
L 22.5 x H 25.3 x W 23.5 cm
12 PCS

WINEKIT1

8 051128 751697



Press the stopper repeatedly to extract the air



Numbers engraved on the stopper to remember the date the bottle was opened



BOTTLE COOLER

L 36 x H 18 x W 1 cm (opened)

BOTTLE COOLER

- Adjustable hook and loop closure: it fits both wine and champagne bottles
- Contains a cooling gel: ready to use after just 2 hours in the freezer
- Material: polyester, PVC, cooling gel

FASCIA REFRIGERANTE PER BOTTIGLIA

- Chiusura regolabile a strappo: si adatta sia alle bottiglie di vino che a quelle di champagne
- Contiene un gel refrigerante: pronta all'uso dopo solo 2 ore di freezer
- Materiale: poliestere, PVC, gel refrigerante

BANDE RÉFRIGÉRANTE POUR BOUTEILLE

- Fermeture réglable à scratch : elle s'adapte aussi bien aux bouteilles de vin qu'aux bouteilles de champagne
- Elle contient un gel réfrigérant : prête à l'emploi après seulement 2 heures au congélateur
- Matériau : polyester, PVC, gel réfrigérant

BANDA REFRIGERANTE PARA BOTELLA

- Cierre de gancho y bucle regulable: se adapta tanto a las botellas de vino como a las de champán
- Contiene un gel refrigerante: lista para el uso después de solo 2 horas de congelador
- Material: poliéster, PVC, gel refrigerante

KÜHLMANSCHETTE FÜR FLASCHE

- Verstellbarer Klettverschluss: passt sich sowohl an Wein- wie auch an Champagnerflaschen an
- Enthält ein Kühlgel: nach nur 2 Stunden im Gefrierschrank einsatzbereit
- Material: Polyester, PVC, Kühlgel



WINE LOVER
ACW0001



PACKAGING

cardboard box
L 15 x H 22 x W 2.5 cm
SOLD X 4



BOTTLE COOLER

L 15 x H 24.5 x W 1 cm

BOTTLE COOLER

- With elasticated bands at the sides: adapts to wine and champagne bottles (*)
- Contains a refrigerant gel: ready for use after just 3 hours in the freezer
- Material: polyester, PVC, refrigerant gel

FASCIA REFRIGERANTE PER BOTTIGLIA

- Con fasce laterali elastiche: si adatta sia alle bottiglie di vino che a quelle di champagne (*)
- Contiene un gel refrigerante: pronta all'uso dopo solo 3 ore di freezer
- Materiale: poliestere, PVC, gel refrigerante

BANDE RÉFRIGÉRANTE POUR BOUTEILLE

- Dotée de bandes élastiques sur le côté, elle s'adapte aussi bien aux bouteilles de vin qu'à celles de champagne (*)
- Contient un gel réfrigérant : prête à l'emploi après seulement 3 heures au congélateur
- Matériau : polyester, PVC, gel réfrigérant

BANDA REFRIGERANTE PARA BOTELLA

- Con bandas laterales elásticas: se adapta tanto a botellas de vino como de champán (*)
- Contiene un gel refrigerante: está lista para usar tan solo 3 horas después de guardarla en el congelador
- Material: poliéster, PVC, gel refrigerante

KÜHLMANSCHETTE FÜR FLASCHE

- Mit elastischen Bändern an den Seiten: sowohl für Weinflaschen als auch für Champagnerflaschen geeignet (*)
- Enthält ein Kühlmittel: nach nur 3 Stunden im Gefrierschrank gebrauchsfertig
- Material: Polyester, PVC, Kühlmittel

*standard size



KITTY
ACW0003



PACKAGING

cardboard box
L 15.5 x H 27.3 x W 2.5 cm
SOLD X 4



COUNT YOUR LUCKY STARS



Ø 10 cm, H 9 cm - 350 ml

NEW BONE CHINA PORCELAIN MUG

TAZZA IN PORCELLANA NEW BONE CHINA

TASSE EN PORCELAIN NEW BONE CHINA

TAZA DE PORCELANA NEW BONE CHINA

TASSE AUS NEW-BONE-CHINA-PORZELLAN

PACKAGING

window box
L 15 x H 14 x W 10 cm

SOLD X 1



ARIES
CUP0001



8 051739 303100



TAURUS
CUP0002



8 051739 303117



GEMINI
CUP0003



8 051739 303124



CANCER
CUP0004



8 051739 303131



LEO
CUP0005



8 051739 303148



VIRGO
CUP0006



8 051739 303155



LIBRA
CUP0007



8 051739 303162



SCORPIO
CUP0008



8 051739 303179



SAGITTARIUS
CUP0009



8 051739 303186



CAPRICORN
CUP0010



8 051739 303193



AQUARIUS
CUP0011



8 051739 303209



PISCES
CUP0012



8 051739 303216

CUP-PUCCINO

Ø 10 cm, H 9 cm - 350 ml

NEW BONE CHINA PORCELAIN MUG

TAZZA IN PORCELLANA NEW BONE CHINA

TASSE EN PORCELAINE NEW BONE CHINA

TAZA DE PORCELANA NEW BONE CHINA

TASSE AUS NEW-BONE-CHINA-PORZELLAN

* While stock lasts



PACKAGING

window box
L 15 x H 14 x W 10 cm

SOLD X 1



TAKE A BREAK COLLECTION



PANDA
CUP0013



8 051739 307917



KITTY
CUP0014



8 051739 307924



LLAMA
CUP0016



8 051739 307948



LAZY TEAM
CUP0018



8 051739 307962



UNICORN
CUP0019



8 051739 307979



KOALA
CUP0020



8 051739 307986



DINO
CUP0021



8 051739 307993



BOSS
CUP0023



8 051739 308013



BIKE LOVER
CUP0024



8 051739 308020



SUPER MUMMY
CUP0035



8 052461 962139



SUPER DADDY
CUP0036



8 052461 962146



SPACE
CUP0037 *



8 052461 962153





AIR BALLOON
CUP0042



8 052461 962863

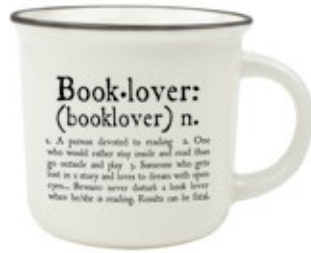

BOOK LOVER
CUP0045



8 052461 962894



GOLD FOIL

TRAVEL
CUP0046



8 052461 962900



AFTER RAIN
CUP0049



8 052461 962931



GOLD FOIL

LIMITED EDITION
CUP0050



8 052461 962948



PARTNER IN CRIME
CUP0052



8 054320 566472



HANGOVER
CUP0053



8 054320 566489



GOLD FOIL

VERY BUSY
CUP0054



8 054320 566496



SLOTH
CUP0055



8 054320 566502



HEART
CUP0056 ✱



8 054320 566519



GOLD FOIL

DRAMA QUEEN
CUP0065



8 052694 002244



TEACHER
CUP0066



8 052694 004613



NO SUGAR
CUP0067



8 052694 004620



TEDDY BEAR
CUP0068



8 052694 005016



GOLD FOIL

QUEEN
CUP0069



8 052694 005443



GOLD FOIL

KING
CUP0070



8 052694 005450



GENIUS
CUP0064



8 052694 002237



MILANO
CUP0025



8 051739 308037



ROMA
CUP0027



8 051739 308051



FIRENZE
CUP0028



8 051739 308068



COMO
CUP0033



8 051739 308211



NAPOLI
CUP0034



8 051739 308228



TRIESTE
CUP0057



8 053610 782028



SIENA
CUP0058



8 053610 784176



VIAREGGIO
CUP0059



8 053610 784183



BOLZANO
CUP0060



8 053610 785050



LIVORNO
CUP0061



8 052694 000653



BERGAMO
CUP0062



8 052694 002213

BUONGIORNO COLLECTION - ITALIAN MARKET



TORINO
CUP0063



8 052694 002220



RAINBOW
CUP0038



8 052461 962825



PRIMO CAFFÈ
CUP0039



8 052461 962832



CAPOLAVORO
CUP0044



8 052461 962887

ESPRESSO FOR TWO

Ø 5.5 cm, H 5 cm - 50 ml

TWO NEW BONE CHINA PORCELAIN
COFFEE MUGS

DUE TAZZINE DA CAFFÈ IN PORCELLANA
NEW BONE CHINA

DEUX TASSES À CAFÉ EN PORCELAINE
NEW BONE CHINA

DOS TAZAS DE CAFÉ EN PORCELANA
NEW BONE CHINA

ZWEI ESPRESSOTASSEN AUS
NEW-BONE-CHINA-PORZELLAN

* While stock lasts



PACKAGING
window box
L 16 x H 7 x W 7 cm
SOLD X 2



POISON AND ANTIDOTE
MM0007



8 056304 482686



DOG AND CAT
MM0009



8 058093 946790



SPACE
MM0010 *



8 058093 946806



PANDA
MM0011



8 058093 946813



SUPER MUMMY AND SUPER DADDY
MM0015



8 059174 835767



AVOCADO
MM0016



8 054320 566526



AFTER RAIN
MM0017



8 054320 566533



CORGI
MM0018



8 052694 002251



POO
MM0019



8 052694 002268



SPACE
MM0020



8 052694 005542



TU VUÒ FÀ L'AMERICANO

Ø 10 cm, H 15 cm - 300 ml

DOUBLE-LAYER NEW BONE CHINA PORCELAIN MUG

- Keeps your drinks warm
- With soft silicone lid

TAZZA IN PORCELLANA NEW BONE CHINA A DOPPIO STRATO

- Mantiene calde le tue bevande
- Con tappo in morbido silicone

TASSE EN PORCELAINE NEW BONE CHINA À DOUBLE PAROI

- Elle maintient vos boissons chaudes
- Avec couvercle en silicone souple

TAZA DE PORCELANA NEW BONE CHINA CON DOBLE CAPA

- Mantiene calientes tus bebidas
- Con tapa en silicona blanda

TASSE AUS NEW-BONE-CHINA-PORZELLAN MIT DOPPELTER BESCHICHTUNG

- Hält Ihre Getränke warm
- Mit Deckel aus weichem Silikon



Without silicone lid

PACKAGING
window box
L 10.3 x H 16 x W 10.3 cm
SOLD X 1

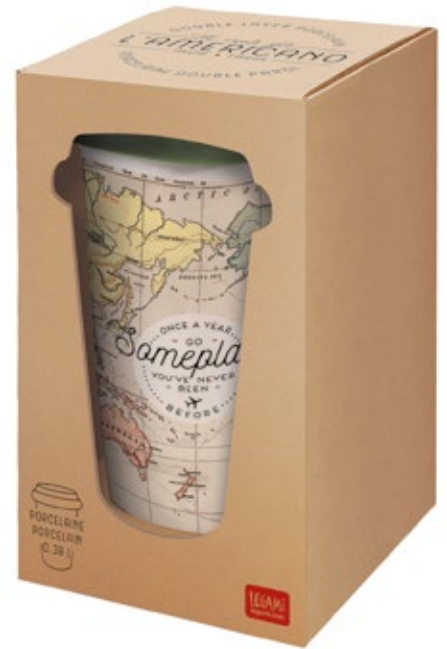

KITTY
AME0002



8 051122 263660



TRAVEL
AME0008



8 051122 263721



PANDA
AME0016



8 054320 566540



STARS
AME0017



8 054320 566557



SLOTH
AME0018



8 054320 566564



HANGOVER
AME0019



8 054320 566571

BUONGIORNO MUG

Ø 9 cm, H 8 cm - 350 ml

NEW BONE CHINA PORCELAIN MUG**TAZZA IN PORCELLANA NEW BONE CHINA****TASSE EN PORCELAIN NEW BONE CHINA****TAZA DE PORCELANA NEW BONE CHINA****TASSE AUS NEW-BONE-CHINA-PORZELLAN****PACKAGING**window box
L 12 x H 15 x W 9 cm**SOLD X 1****WORLD CITIES****VERONA**

*I'm going to see
the world.
#Verona*

MUG0082

8 052783 614990

**TORINO**

*I'm going to see
the world.
#Torino*

MUG0084

8 052783 615010

ITALIAN MARKET**BOOK LOVER**

*Chi legge i tuoi stessi libri ha
una mappa per la tua anima.*

MUG0051

8 056304 484659

**DREAMER**

*Ho un sogno e...
ti ci devo portare.*

MUG0052

8 056304 484666

MUGS DISPLAY

Floor empty display on demand:

2-sided

material: cardboard, wooden base
L 55 x H 162 x W 35 cm**MOQ: 63 pcs**

- Espresso for two: 18 pcs
- Cup-puccino / Count your lucky stars: 30 pcs
- Tu vuoi fa l'americano: 15 pcs

DISMUG2

8 054320 564973



FOR INDOOR & OUTDOOR USE

INDOOR AND OUTDOOR STRING LIGHTS

L 520 cm

STRING OF LIGHTS FOR INDOORS AND OUTDOORS

- With 50 LEDs
- Light colour: warm white
- Material: copper wire

FILO DI LUCI PER INTERNO ED ESTERNO

- Con 50 LED
- Colore luce: bianco caldo
- Materiale: filo in rame

GUIRLANDE LUMINEUSE POUR INTÉRIEUR ET EXTÉRIEUR

- Avec 50 LED
- Couleur de la lumière : blanc chaud
- Matériau : guirlande en cuivre

CABLE DE LUCES PARA INTERIORES Y EXTERIORES

- Con 50 LED
- Color de la luz: blanco cálido
- Material: cable de cobre

LICHTERKETTE FÜR INNEN- UND AUSSENBEREICHE

- Mit 50 LEDs
- Lichtfarbe: Warmweiß
- Material: Kupferdraht

PACKAGING

window box w/hook and w/try me
L 9 x H 16.5 x W 3.5 cm



Timer function



Water Resistant IP44

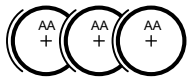

3 x AA batteries (not included)



DISPLAY

material: cardboard
L 9.6 x H 17.5 x W 22.5 cm
6 PCS

OSLKIT1



8 051128 755800



LED LIGHT

L 7.5 x H 11.3 x W 1.5 cm

LED LIGHT

- Ideal for wardrobes, bathrooms, corridors, basements, and more
- 6 LED lights
- Power: 36 lumens
- Material: plastic

LUCE A LED

- Ideale per armadi, bagni, corridoi, cantine e molto altro ancora
- 6 luci LED
- Potenza: 36 Lumen
- Materiale: plastica

LAMPE LED

- Idéale pour les armoires, salles de bains, couloirs, caves et bien d'autres encore
- 6 lampes LED
- Puissance : 36 Lumen
- Matériau : plastique

LUZ LED

- Ideal para armarios, baños, pasillos, sótanos y mucho más
- 6 luces LED
- Potencia: 36 lúmenes
- Material: plástico

LED-LICHT

- Ideal für Schränke, Bäder, Flure, Keller und vieles andere mehr
- 6 LED-Lichter
- Stärke: 36 Lumen
- Material: Kunststoff



3 x AAA batteries (not included)



Hole for fixing

On/off switch

Adhesive backing



FOR INDOOR USE ONLY

PACKAGING

carded
L 13 x H 20.5 x W 4 cm
SOLD X 4

NTL0001



8 058093 949418



Self-standing packaging



FOR INDOOR
USE ONLY**STRING OF LIGHTS WITH MINI GLASS JARS**

L 185 cm

STRING OF LIGHTS WITH MINI GLASS JARS

- With 10 LEDs
- Light colour: warm white
- Material: copper wire, glass

FILO DI LUCI CON VASETTI DI VETRO

- Con 10 LED
- Colore luce: bianco caldo
- Materiale: filo in rame, vetro

GUIRLANDE LUMINEUSE AVEC DES BOCAUX EN VERRE

- Avec 10 LED
- Couleur de la lumière : blanc chaud
- Matériau : guirlande en cuivre, verre

CABLE DE LUCES CON TARROS DE VIDRIO

- Con 10 LED
- Color de la luz: blanco cálido
- Material: cable de cobre, vidrio

LICHTERKETTE MIT GLÄSERN

- Mit 10 LEDs
- Lichtfarbe: Warmweiß
- Material: Kupferdraht, Glas

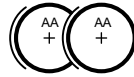
2 x AA batteries
(not included)**PACKAGING**
window box w/try me
L 21 x H 15 x W 3 cm**SOLD X 4**

STRI0001



8 052783 613672

**STRING OF LIGHTS WITH PHOTO HOLDER CLIPS**

L 190 cm

STRING OF LIGHTS WITH PHOTO HOLDER CLIPS

- Composed of 20 LEDs. With 20 removable clips
- Light colour: warm white
- Material: copper wire, plastic

FILO DI LUCI CON CLIP PORTAFOTO

- Composto da 20 LED. Con 20 clip removibili
- Colore luce: bianco caldo
- Materiale: filo in rame, plastica

GUIRLANDE LUMINEUSE AVEC CLIPS PORTE PHOTOS

- Composée de 20 LED. Avec 20 clips amovibles
- Couleur de la lumière : blanc chaud
- Matériau : guirlande en cuivre, plastique

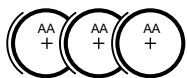
3 x AA batteries
(not included)FOR INDOOR
USE ONLY**CABLE DE LUCES CON CLIPS PARA FOTOS**

- Compuesto por 20 LED. Con 20 clips removibles
- Color de la luz: blanco cálido
- Material: cable de cobre, plástico

LICHTERKETTE MIT CLIPS FÜR FOTOS

- Bestehend aus 20 LEDs. Mit 20 abnehmbaren Clips
- Lichtfarbe: Warmweiß
- Material: Kupferdraht, Kunststoff

PACKAGING
window box w/try me
L 11 x H 9 x W 3.5 cm**SOLD X 6**

CSTR0001



8 052461 962504



FOR INDOOR
USE ONLY**UNDER THE RAINBOW**

L 190 cm

STRING OF RAINBOW-SHAPED LIGHTS

- With 20 LEDs
- Silver-coloured wire
- Light colour: warm white
- Material: copper wire, PS

FILO DI LUCI A FORMA DI ARCOBALENO

- Con 20 LED
- Filo color argento
- Colore luce: bianco caldo
- Materiale: filo in rame, PS

GUIRLANDE LUMINEUSE EN FORME D'ARC-EN-CIEL

- Avec 20 LED
- Guirlande de couleur argent
- Couleur de la lumière : blanc chaud
- Matériau : guirlande en cuivre, PS

CABLE DE LUCES EN FORMA DE ARCOÍRIS

- Con 20 LED
- Cable de color plata
- Color de la luz: blanco cálido
- Material: cable de cobre, PS

LICHTERKETTE IN REGENBOGENFORM

- Mit 20 LEDs
- Silberfarbener Draht
- Lichtfarbe: Warmweiß
- Material: Kupferdraht, PS

PACKAGING
window box w/try me
L 12 x H 11 x W 4 cm
SOLD X 6

STRI0003

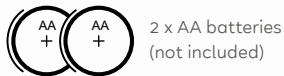

8 052461 962498

2 x AA batteries
(not included)FOR INDOOR
USE ONLY**LOVE AT FIRST LIGHT**

L 190 cm

STRING OF HEART-SHAPED LIGHTS

- With 20 LEDs
- Silver-coloured wire
- Light colour: warm white
- Material: copper wire, PS

FILO DI LUCI A FORMA DI CUORE

- Con 20 LED
- Filo color argento
- Colore luce: bianco caldo
- Materiale: filo in rame, PS

GUIRLANDE LUMINEUSE EN FORME DE CŒUR

- Avec 20 LED
- Guirlande de couleur argent
- Couleur de la lumière : blanc chaud
- Matériau : guirlande en cuivre, PS

CABLE DE LUCES EN FORMA DE CORAZÓN

- Con 20 LED
- Cable de color plata
- Color de la luz: blanco cálido
- Material: cable de cobre, PS

LICHTERKETTE MIT LICHTERN IN HERZFORM

- Mit 20 LEDs
- Silberfarbener Draht
- Lichtfarbe: Warmweiß
- Material: Kupferdraht, PS

PACKAGING
window box w/hook
and w/try me
L 12 x H 11 x W 4 cm
SOLD X 6

STRI0002

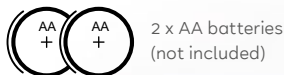

8 052461 962481

2 x AA batteries
(not included)

BOTTLE LIGHTS

Ø 2.2 (upper cap part) x H 5 cm (without string) string length: 2 m

STRING OF LIGHTS FOR BOTTLES

- 20 LED lights
- Light colour: warm white
- Material: copper wire, cork and plastic stopper

CABLE DE LUCES PARA BOTELLA

- 20 LED
- Color de la luz: blanco cálido
- Material: cable de cobre, tapón de corcho y plástico

PACKAGING

carded
L 11 x H 21 x W 2.5 cm
SOLD X 6

BLU0001



8 052694 001476

FILO DI LUCI PER BOTTIGLIA

- 20 LED
- Colore luce: bianco caldo
- Materiale: filo in rame, tappo in sughero e plastica

FLASCHEN-LICHTERKETTE

- 20 LEDs
- Lichtfarbe: Warmweiß
- Material: Kupferdraht, Verschluss aus Kork und Kunststoff

GUIRLANDE LUMINEUSE POUR BOUTEILLE

- 20 LED
- Couleur lumière : blanc chaud
- Matériau : fil de cuivre, bouchon en liège et plastique



Bottle not included

JAR OF STARS

L 9 x H 20 cm - string length: 2 m

GLASS BOTTLE WITH FAIRY LIGHTS

- With 20 LEDs
- Light colour: warm white
- Material: copper wire, plastic, glass

BOTTIGLIA IN VETRO CON FILO DI LUCI

- Con 20 LED
- Colore luce: bianco caldo
- Materiale: filo in rame, plastica, vetro

GUIRLANDE EN BOUTEILLE

- Avec 20 LED
- Couleur de la lumière : blanc chaud
- Matériau : guirlande en cuivre, plastique, verre

BOTELLA DE CRISTAL CON GUIRNALDA

- Con 20 LED
- Color de la luz: blanco cálido
- Material: cable de cobre, plástico, vidrio

GLASFLASCHE MIT LICHTERKETTE

- Mit 20 LEDs
- Lichtfarbe: Warmweiß
- Material: Kupferdraht, Kunststoff, Glas

**FOR INDOOR USE ONLY****PACKAGING**

window box
L 13.5 x H 18.5 x W 12.5 cm
SOLD X 3

GBL0001



8 054117 620080



FOR INDOOR
USE ONLY

LED LIGHT SPOOL

Ø 7.5 cm, H 9.8 cm - string length: 10 m

STRING OF LIGHTS ON SPOOL

- With 100 LEDs
- Light colour: warm white
- Material: copper wire, pine wood

ROCCHETTO CON FILO DI LUCI

- Con 100 LED
- Colore luce: bianco caldo
- Materiale: filo in rame, legno di pino

BOBINE AVEC GUIRLANDE LUMINEUSE

- Avec 100 LED
- Couleur de la lumière : blanc chaud
- Matériau : guirlande en cuivre, bois de pin

CARRETE CON CABLES DE LUCES

- Con 100 LED
- Color de la luz: blanco cálido
- Material: cable de cobre, madera de pino

SPULE MIT LICHTERKETTE

- Mit 100 LEDs
- Lichtfarbe: Warmweiß
- Material: Kupferdraht, Kiefernholz

PACKAGING

window box w/try me
L 8.5 x H 13 x W 8.5 cm

SOLD X 2

LIG0001



8 059174 833343

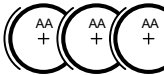

3 x AA batteries
(not included)



TIME TO SHINE

Ø 7.5 cm, H 15.5 cm

LED LANTERN

- Light colour: warm white
- Material: plastic, stainless steel

LAMPADA LED

- Colore della luce: bianco caldo
- Materiale: plastica, acciaio inossidabile

LANTERNE LED

- Couleur de la lumière : blanc chaud
- Matériau : plastique, acier inoxydable

LÁMPARA LED

- Color de la luz: blanco cálido
- Material: plástico, acero inoxidable

LED-LAMPE

- Lichtfarbe: Warmweiß
- Material: Kunststoff, rostfreier Stahl

FOR INDOOR
USE ONLY

PACKAGING

cardboard box
L 9 x H 16 x W 8.5 cm

SOLD X 3

LLN0001



8 053610 784299



USB
RECHARGEABLE



UP TO 5 HOURS
OF LIGHT



3 BRIGHTNESS
LEVELS



USB charging cable
included



FOR INDOOR
USE ONLY**MAGMASTIC!**

Ø 11 cm, H 36.3 cm

LAVA LAMP

- Light effect: lava
- With 2 E14 R39 30W bulbs included
- Power cord with type C plug (European 2-pin)
- Material: glass, water, paraffin, wax, aluminium

LAMPADA LAVA

- Effetto luminoso: lava
- 2 lampadine E14 R39 da 30 W incluse
- Cavo di alimentazione con spina di tipo C (europea a due poli)
- Materiale: vetro, acqua, paraffina, cera, alluminio

LAMPE À LAVE

- Effet lumineux : lave
- 2 ampoules E14 R39 de 30 W incluses
- Câble d'alimentation muni d'une prise de type-C (européenne à deux broches)
- Matériau : verre, eau, paraffine, cire, aluminium

LÁMPARA DE LAVA

- Efecto luminoso: lava
- 2 bombillas E14 R39 de 30 W incluidas
- Cable de alimentación con enchufe tipo C (europeo de dos polos)
- Material: vidrio, agua, parafina, cera, aluminio

LAVALAMPE

- Lichteffect: Lava
- 2 Glühlampen E14 R39 zu 30 W im Lieferumfang enthalten
- Im Lieferumfang enthalten ist ein Netzkabel mit Typ-C-Stecker (Eurostecker, zweipolig)
- Material: Glas, Wasser, Paraffin, Wachs, Aluminium

PACKAGINGcardboard box
L 21 x H 26.6 x W 11.3 cm**SOLD X 2**GOLD
LAV0001

8 052694 001445

SILVER
LAV0002

8 052694 001452

HOLO
LAV0003

8 052694 001469

FOR INDOOR
USE ONLY

IT'S A SIGN

L MAX 20 x H MAX 32.5 x W MAX 10 cm

NEON EFFECT LED LAMP

- Dual power supply: batteries (not included) or the USB cable (included)
- Material: plastic

LAMPADA LED A EFFETTO NEON

- Doppia alimentazione: a batterie (non incluse) o tramite cavo USB (incluso)
- Materiale: plastica

LAMPE LED À EFFET NÉON

- Double alimentation : à piles (non incluses) ou avec câble USB (inclus)
- Matériau : plastique

LÁMPARA LED EFECTO NEÓN

- Doble alimentación: con pilas (no incluidas) o con cable USB (incluido)
- Material: plástico

LED-LAMPE MIT NEON-EFFEKT

- Doppelte Stromversorgung: mit Batterien (nicht im Lieferumfang enthalten) oder über ein USB-Kabel (im Lieferumfang enthalten)
- Material: Kunststoff

DUAL POWER SUPPLY

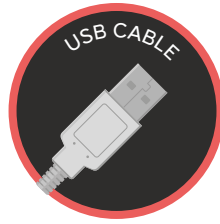

OR



PACKAGING

cardboard box
L MAX 25 x H MAX 30 x W 4.5 cm
SOLD X 2

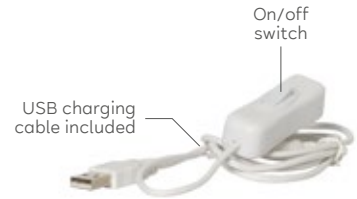

CACTUS
LL0001



FLAMINGO
LL0002



HEART
LL0003



FLASH
LL0004



RAINBOW
LL0005



KITTY
LL0006



FOR INDOOR
USE ONLY

MINI DECORATIVE LIGHT

L MAX 14 x H MAX 15 x W 3.3 cm

MINI DECORATIVE LIGHT

- Light colour: warm white
- Material: metal, wood, plastic

MINI LUCE DECORATIVA

- Colore luce: bianco caldo
- Materiale: metallo, legno, plastica

MINI LAMPE DÉCORATIVE

- Couleur de la lumière : blanc chaud
- Matériau : métal, bois, plastique

MINILUZ DECORATIVA

- Color de la luz: blanco cálido
- Material: metal, madera, plástico

DEKORATIVE MINI-LICHT

- Lichtfarbe: Warmweiß
- Material: Metall, Holz, Kunststoff

PACKAGING

window box
L MAX 15 x H MAX 18.5 x W 4 cm
SOLD X 3



3 x LR44 batteries
(included)

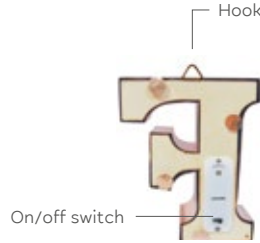

LETTERS

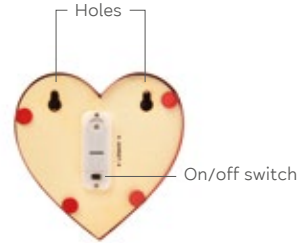

SHAPES

					
LELI0001 	LELI0002 	LELI0003 	LELI0004 	LELI0005 	LELI0006 
					
LELI0007 	LELI0008 	LELI0009 	LELI0010 	LELI0011 	LELI0012 
					
LELI0013 	LELI0014 	LELI0015 	LELI0016 	LELI0017 	LELI0018 
					
LELI0019 	LELI0020 	LELI0021 	LELI0022 	LELI0023 	LELI0024 
					
LELI0025 	LELI0026 	LELI0027 			

**MINI DECORATIVE LIGHTS RANGE
3 PCS X LETTER**

LELI - GROUP





FUCHSIA
GLITTER

FLAMINGO
LELI0040



8 059174 834227



PINK
GLITTER

UNICORN
LELI0041



8 059174 834234



GOLD
GLITTER

STARS
LELI0042



8 059174 839581



GREEN
GLITTER

CACTUS
LELI0043



8 059174 839598



RED
GLITTER

HEART
LELI0044



8 059174 839604



RAINBOW
LELI0046



8 052461 962566

MINI DECORATIVE LIGHTS RANGE
3 PCS X SHAPE

LELIDECO - GROUP



8 054320 564379



MINI DECORATIVE LIGHTS
RANGE + DISPLAY

- Ø 50 cm, H 190 cm
- Double-sided spinner display
- Swivel wheels
- 42 hooks
- Material: metal
- Assortment:
 - 5 pcs x shape
 - 5 pcs x A, G, L, M, R, S
 - 3 pcs x B, C, D, E, F, H, I, J, K, N, O, P, Q, T, U, V, W, X, Y, Z, &

DISLELI - GROUP



8 054320 561255

RINGS & THINGS

CERAMIC PLATE

- Material: ceramic

PIATTINO IN CERAMICA

- Materiale: ceramica

SOUCOUPE EN CÉRAMIQUE

- Matériau : céramique

PLATO DE CERÁMICA

- Material: cerámica

KERAMIKTELLER

- Material: Keramik



PACKAGING

window box
L 3.8 x H 11.2 x W 10.2 cm
SOLD X 4



L 11 x H 11 x W 2 cm

STARS
CPL0001



8 052694 003319



L 11.5 x H 11.5 x W 2 cm

KITTY
CPL0002



8 052694 003326



L 12 x H 12 x W 1.5 cm

EGG
CPL0003



8 052694 003333



L 10 x H 13 x W 1.5 cm

AVOCADO
CPL0004



8 052694 003340



L 8.5 x H 14.5 x W 2 cm

MAGIC
CPL0005



8 052694 003357



THE SOUND OF NATURE

L 3.5 x H 11 x W 10 cm

MOTION-ACTIVATED BIRDSONG BOX

- Technology: infrared motion sensor
- Duration of sound: 20 seconds
- Sound: birdsong
- Material: plastic

CASSETTA SONORA CON SENSORE DI MOVIMENTO

- Tecnologia: sensore di movimento tramite infrarossi
- Durata del suono: 20 secondi
- Suono: cinguettio di uccelli
- Materiale: plastica

NICHOIR SONORE AVEC CAPTEUR DE MOUVEMENT

- Technologie : capteur de mouvement à infrarouge
- Durée du son : 20 secondes
- Son : pépiement d'oiseaux
- Matériau : plastique

CASITA SONORA CON SENSOR DE MOVIMIENTO

- Tecnología: sensor de movimiento mediante infrarrojos
- Duración del sonido: 20 segundos
- Sonido: trino de pájaros
- Material: plástico

KLANGBOX MIT BEWEGUNGSENSOR

- Technologie: Infrarot-Bewegungssensor
- Klangdauer: 20 Sekunden
- Klang: Vogelgezwitscher
- Material: Kunststoff

PACKAGING

cardboard box
L 3,8 x H 11,2 x W 10,2 cm

DISPLAY

material: cardboard
L 25 x H 25 x W 16 cm

8 PCS

RSBKIT1



Hole for wall mounting

On/off and volume control dial



USB charging cable included



MAGNETIC HOURGLASS

L 8 x H 16.5 x W 8 cm (base included)

MAGNETIC HOURGLASS

- Hourglass with ferrous powder
- Magnetic wooden base

CLESSIDRA MAGNETICA

- Clessidra con polvere di ferro
- Base in legno magnetica

SABLIER MAGNÉTIQUE

- Sablier avec de la poudre de fer
- Base en bois magnétique

RELOJ DE ARENA MAGNÉTICO

- Reloj de arena con polvo de hierro
- Base magnética de madera

MAGNETISCHE SANDUHR

- Sanduhr mit Eisenpulver
- Magnetholzbasis

PACKAGING

cardboard box
L 9 x H 20 x W 9 cm

SOLD X 4

HG0001

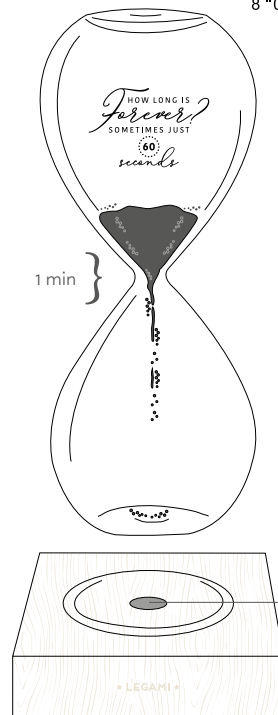

SUPER SOFT!

PILLOW

- Filler: 100% polyester
- Exterior fabric: 95% polyester, 5% elastan

CUSCINO

- Imbottitura: 100% poliester
- Materiale del rivestimento esterno: 95% poliester, 5% elastane

COUSSIN

- Rembourrage : 100 % polyester
- Matériau du revêtement extérieur : 95 % polyester, 5 % élasthanne

COJÍN

- Relleno: 100 % poliéster
- Material del revestimiento externo: 95 % poliéster, 5 % elastano

KISSEN

- Füllung: 100 % Polyester
- Material des Außenbezugs: 95 % Polyester, 5 % Elasthan

SOLD X 2



Design Corgi, Kitty and Panda: With openings on both sides for keeping hands warm.



L 25 x H 24 x W 29 cm

CORGI
SUS0003



8 053610 782073



L 25 x H 24 x W 29 cm

KITTY
SUS0004



8 053610 782080



L 34 x H 26 x W 19 cm

PANDA
SUS0006



8 052694 002282



L 28 x H 42 x W 14 cm

DINO
SUS0002



8 053610 782066



L 28 x H 42 x W 14 cm

TEDDY BEAR
SUS0007



8 052694 002640



L 45 x H 38 x W 15 cm

HEART
SUS0005



8 053610 782844

SUPER SOFT DISPLAY

Material: cardboard four shelves, resistant structure, removable crowner
L 62 x H 175 x W 37 cm

**FULL ASSORTED DISPLAY
4 PCS X DESIGN**

DISSUPERSOFT-GROUP



8 053610 782677

**SCENTED CANDLE**

Ø 7.2 cm, H 8.4 cm - 150 gr

SCENTED CANDLE

- Fragrance: porcelain peony
- Burn time: 30 hours
- With paper covering to protect the wax
- Material: candle in a mixture of plant and paraffin wax, glass jar capable of resisting high temperatures, cotton wick without aluminium

CANDELA PROFUMATA

- Fragranza: porcelain peony
- Tempo di bruciatura: 30 ore
- Con copertura in carta per proteggere la cera
- Materiale: candela in miscela vegetale e paraffina, contenitore in vetro resistente alle alte temperature, stoppino in cotone senza alluminio

BOUGIE PARFUMÉE

- Parfum : porcelain peony
- Temps de combustion : 30 heures
- Dotée d'un couvercle en carton pour protéger la cire
- Matière : bougie fabriquée avec un mélange de cire végétale et de paraffine, contenant en verre résistant aux hautes températures, mèche en coton sans aluminium

VELA PERFUMADA

- Fragancia: porcelain peony
- Duración de la vela: 30 horas
- Con tapa de papel para proteger la cera
- Material: vela de mezcla de cera vegetal y parafina, recipiente de vidrio resistente a las altas temperaturas, mecha de algodón sin aluminio

DUFTKERZE

- Duft: porcelain peony
- Brenndauer: 30 Stunden
- Mit Papierabdeckung zum Schutz des Wachses
- Material: Kerze aus einer Mischung aus pflanzlichem Wachs und Paraffin, Hitzebeständiges Behältnis aus Glas, Baumwolldocht ohne Aluminium

PACKAGING

cardboard box
L 7.8 x H 9 x W 7.8 cm

SOLD X 4

CDL0001



8 052694 005122



BAMBOO FOLDING STAND

L 28 x H 20 x W 2.5 cm (closed)
L 28 x H MAX 20 x W MAX 20 cm (opened)

BAMBOO FOLDING STAND

- Practical stand for tablets, books, recipe books or sheet music
- Material: bamboo, stainless steel

LEGGIO PIEGHEVOLE IN BAMBÙ

- Pratico supporto per tablet, libri, ricettari o spartiti
- Materiale: bambù, acciaio inox

PUPITRE PLIANT EN BAMBOU

- Support pratique pour tablettes, livres, recueils de recettes ou partitions
- Matériau : bambou, acier inox

ATRIL PLEGABLE DE BAMBÙ

- Práctico soporte para tabletas, libros, recetarios o partituras
- Material: bambù, acero inoxidable

KLAPPULT AUS BAMBUS

- Praktischer Pult für Tablets, Bücher, Rezeptsammlungen oder Noten
- Material: Bambus, Edelstahl

PACKAGING

cardboard box
L 27 x H 20 x W 4 cm

SOLD X 4**BAMST0001**

8 052461 964249



Stainless steel folding page-holders

Reclinable:
5 different tilt angles**SLAM DUNK**

Ø 32 cm, H 30 cm

BASKETBALL BIN

- Material: plastic

CESTINO A FORMA DI CANESTRO

- Materiale: plastica

CORBILLE EN FORME DE PANIER DE BASKET

- Matériau : plastique

PAPELERA EN FORMA DE CANASTA

- Material: plástico

BASKETBALLKORB-MÜLLEIMER

- Material: Kunststoff

PACKAGING
cardboard belly band
SOLD X 6

BTC0001

8 052461 961491

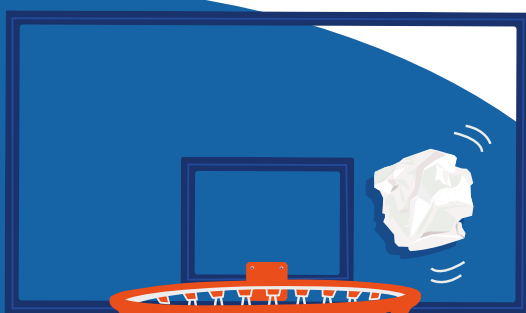

BEST MOMENTS EVER

L 16 x H 17 x W 4.2 cm

PHOTO ALBUM

- Album with 40 pages in 180 g/m² paper
- Ideal for instant and standard photos (up to 10 x 15 cm)
- Thread-sewn binding with ribbon closure
- Material: paper

ALBUM FOTOGRAFICO

- Album con 40 pagine in carta 180 g/m²
- Ideale per foto istantanee e per foto standard (fino a 10x15 cm)
- Rilegatura a broccia filo refe e chiusura con nastro
- Materiale: carta

ALBUM PHOTO

- Album de 40 pages en papier 180 g/m²
- Idéal pour les photos instantanées et les photos de taille standard (jusqu'à 10 x 15 cm)
- Brochage au fil et fermeture avec un ruban
- Matériau : papier

ÁLBUM DE FOTOS

- Álbum con 40 páginas de papel de 180 g/m²
- Ideal para fotos instantáneas y para fotos estándar (hasta 10 x 15 cm)
- Encuadernación rústica cosida y cierre con cinta
- Material: papel

FOTOALBUM

- Album mit 40 Papierseiten 180 g/m²
- Ideal für Sofortbilder und herkömmliche Fotos (bis 10 x 15 cm)
- Mit Fadenheftung und Band zum Verschließen
- Material: Papier

SOLD X 3

PBM0003



Includes 48 adhesive corners



BEST MOMENTS EVER

L 23 x H 23.5 x W 3 cm

PHOTO ALBUM

- Includes: one 40-page album made from 180 g/m² cardstock and 1 case containing 1 glitter ink pen, 1 roll of paper sticky tape, 24 adhesive photo corners to hold the photos in the album, 12 paper frames and 44 paper scrap booking embellishments
- Material: paper

ALBUM FOTOGRAFICO

- Include: 1 album con 40 pagine in carta 180g/m² e 1 custodia contenente 1 penna con inchiostro glitterato, 1 nastro adesivo in carta, 24 angoli adesivi per fissare le foto all'album, 12 cornici in carta e 44 elementi decorativi
- Materiale: carta

* While stock lasts

SOLD X 2**ALBUM PHOTO**

- Comprend : 1 album avec 40 pages en papier 180 g/m² et 1 étui contenant 1 stylo pailletée, 1 ruban adhésif en papier, 24 angles adhésifs pour fixer les photos dans l'album, 12 cadres en papier et 44 éléments décoratifs
- Matériau : papier

ÁLBUM DE FOTOS

- Incluye: 1 álbum con 40 páginas de papel de 180 g/m² y 1 funda con 1 bolígrafo con purpurina, 1 cinta adhesiva de papel, 24 esquinas adhesivas para pegar las fotos en el álbum, 12 marcos de papel y 44 adornos
- Material: papel

FOTOALBUM

- Enthält: 1 Album mit 40 Seiten aus Karton (180 g/m²) und 1 Hülle mit 1 Hülle mit 1 Stift mit Glitter-Tinte, 1 Papier-Klebeband, 24 Klebecken zum Befestigen der Fotos im Album, 12 Papierrahmen und 44 dekorativen Elementen
- Material: Papier

**THE KIT INCLUDES:**

1 red glitter ink pen



24 adhesive photo corners



1 paper sticky tape

**PACKAGING**view top box with cardboard base
L 38 x H 25 x W 3 cm**HEART**

PBM0001 *



12 paper frames



44 paper scrap booking embellishments



Bound photo album with ribbon closure



GOLD FOIL

PAGE SIZE:
21.5 x 23 cm



THE KIT INCLUDES:

1 green glitter ink pen



24 adhesive photo corners



1 paper sticky tape



PACKAGING

view top box with cardboard base
L 38 x H 25 x W 3 cm

TRAVEL

PBM0002



12 paper frames



44 paper scrap booking embellishments



Bound photo album with ribbon closure

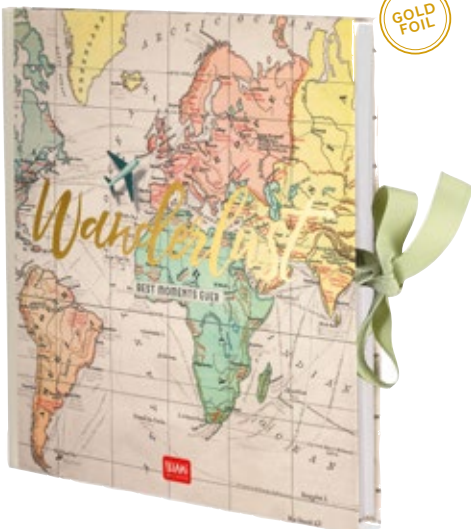

GOLD FOIL

PAGE SIZE:
21.5 x 23 cm



EVERY MOMENT COUNTS

box: L 16.5 x H 4.2 x W 16.5 cm - photo album: L 78 x H 13 cm

MEMORY BOX

- Box with magnetic closure
- The box contains an accordion photo album
- 24 photo corners are included to hold your pictures in the album
- Material: paper from certified forest sources

SCATOLA DEI RICORDI

- Scatola con chiusura magnetica
- Contiene un album fotografico pieghevole a fisarmonica
- 24 angoli adesivi inclusi, per fissare le fotografie all'album
- Materiale: carta proveniente da fonti forestali certificate

BOÎTE À SOUVENIRS

- Boîte à fermeture aimantée
- Contient un album photo pliant en accordéon
- 24 coins adhésifs inclus, pour fixer les photos dans l'album
- Matériau : papier provenant de forêts certifiées

CAJA DE RECUERDOS

- Caja con cierre magnético
- Incluye un álbum de fotos desplegable
- 24 esquinas adhesivas incluidas, para fijar las fotos al álbum
- Material: papel procedente de fuentes forestales certificadas

ERINNERUNGSBOX

- Box mit Magnetverschluss
- Enthält ein Fotoalbum mit Zick-Zack-Faltung
- Inklusive 24 Klebecken zum Befestigen der Fotos im Album
- Material: Papier aus zertifizierten Wäldern



PACKAGING

shrink-wrapping w/paper card
L 16.7 x H 4.5 x W 16.7 cm

SOLD X 4

HEART

MEB0001



8 054117 620974



PACKAGING

shrink-wrapping w/paper card
L 16.7 x H 4.5 x W 16.7 cm

SOLD X 4

TRAVEL

MEB0002



8 054117 620981





MAGNETIC WIRE PHOTO HOLDER

L 120 cm

MAGNETIC WIRE PHOTO HOLDER

- 7 photo clips included
- Material: plastic, metal, magnet

FILO MAGNETICO PORTA FOTO

- 7 ferma-foto inclusi
- Materiale: plastica, metallo, magnete

FIL MAGNÉTIQUE PORTE-PHOTOS

- 7 clips pour photos inclus
- Matériau : plastique, métal, aimant

* While stock lasts

CUERDA MAGNÉTICA PORTAFOTOS

- Incluye 7 clips para fotos
- Material: plástico, metal, imán

MAGNETBAND ALS FOTOHALTER

- Inklusive 7 Fotohalter
- Material: Kunststoff, Metall, Magnet

PACKAGING

- carded
- L 14 x H 18 cm x W 1 cm
- SOLD X 3**



CAMERA
CAB0014



HEART
CAB0016



KITTY
CAB0018 *



AIR BALLOON
CAB0020



LUCKY

L 6 x H 4.5 x W 2 cm

MAGNETIC PHOTO HOLDER

- Also ideal as a paper clip holder, business card holder, ring holder
- Material: metal, magnet

PORTAFOTO MAGNETICO

- Ideale anche come porta graffette, porta biglietti da visita, porta anelli
- Materiale: metallo, magnete

PORTE PHOTOS MAGNÉTIQUE

- Idéal aussi comme porte trombones, porte cartes de visite, porte bagues
- Matériau : métal, aimant

PORTAFOTOS MAGNÉTICO

- Ideal también como portaclips, porta tarjetas de visita, portanillos
- Material: metal, imán

MAGNETISCHER FOTOHALTER

- Ideal auch für Büroklammern, Visitenkarten oder Ringe
- Material: Metall, Magnet

PACKAGING

- window box
- L 9 x H 11.5 x W 4 cm
- SOLD X 6**

BDM0001

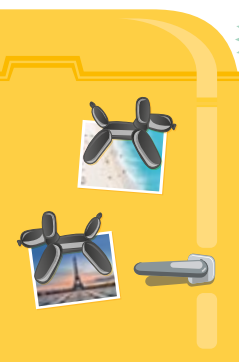

Double magnet



Photo holder

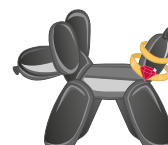

Ring holder



Paper clip holder

GLITTER PHOTO FRAME

GLITTER PHOTO FRAME

- 1 replaceable photo included
- Material: PC, liquid

PORTAFOTO CON GLITTER

- 1 fotografia sostituibile inclusa
- Materiale: PC, liquido

CADRE PHOTO À PAILLETES

- 1 photo remplaçable incluse
- Matériau : PC, liquide

PORTARRETRATOS CON PURPURINA

- Incluye 1 fotografía que se puede cambiar
- Material: PC, líquido

BILDERRAHMEN MIT GLITTER

- Inklusive 1 austauschbaren Foto
- Material: PC, Flüssigkeit

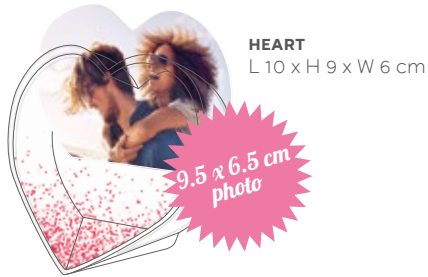

PACKAGING
cardboard box
L 12 x H 11 x W 6 cm
SOLD X 4

GPF0005



PACKAGING
cardboard box
L 7.2 x H 10 x W 3.6 cm
SOLD X 4

GPF0001



PACKAGING
cardboard box
12.5 x H 10 x W 3.6 cm
SOLD X 4

GPF0002



PACKAGING
cardboard box
L 17 x H 12 x W 3.6 cm
SOLD X 4

GPF0003



RETRO ALARM CLOCK

L 10.9 x H 8.7 x W 6 cm

VINTAGE INSPIRED ALARM CLOCK

- Ivory face and glow-in-the-dark hands
- Material: plastic

OROLOGIO-SVEGLIA VINTAGE

- Quadrante avorio e lancette che si illuminano al buio
- Materiale: plastica

HORLOGE-RÉVEIL VINTAGE

- Cadran couleur ivoire et aiguilles qui s'éclairent dans l'obscurité
- Matériau : plastique

RELOJ DESPERTADOR VINTAGE

- Esfera marfil y agujas que se iluminan en la oscuridad
- Material: plástico

VINTAGE-WECKER

- Elfenbeinfarbenes Zifferblatt und im Dunkeln leuchtende Zeiger
- Material: Kunststoff

 1 x AA battery (not included)

PACKAGING

window box
L 12 x H 11.3 x W 7 cm

SOLD X 2



CLO0001 RED 



8 058093 949524



CLO0002 AQUA 



8 058093 949531

MINI TICK TOCK

L 4 x H 6.5 x W 2 cm

ALARM CLOCK

- Material: matte metal

OROLOGIO-SVEGLIA

- Materiale: metallo opaco

HORLOGE-RÉVEIL

- Matériau : métal opaque

RELOJ DESPERTADOR

- Material: metal opaco

WECKER

- Material: mattes Metall

 1 x LR44 battery (included)

PACKAGING

PET box w/hook
L 4.5 x H 8.5 x W 2 cm



DISPLAY

Material: cardboard
L 10.6 x H 10 x W 7.5 cm

6 PCS

SVEKIT23 RED 



8 051128 756227



PACKAGING

PET box w/hook
L 4.5 x H 8.5 x W 2 cm



DISPLAY

Material: cardboard
L 10.6 x H 10 x W 7.5 cm

6 PCS

SVEKIT26 VINTAGE GREEN 



8 051128 756241



MAGNET

L 5.5 x H 8 cm

MAGNET

- UV varnish or foil printing
- Material: paper, plastic, magnetised plastoferrite

CALAMITA

- Stampa con vernice UV o lamina
- Materiale: carta, plastica, plastoferrite magnetizzata

✳ While stock lasts

SOLD X 3**AIMANT**

- Impression avec vernis UV ou film laminé
- Matériau : papier, plastique, plastoferrite magnétisé

IMÁN

- Con motivos en barniz UV o efecto metálico
- Material: papel, plástico, plastoferrita magnética

MAGNET

- Druck mit UV-Lack oder Folienprägung
- Material: Papier, Kunststoff, magnetisierter Plastoferrit

WORLD CITIES COLLECTION

MAG0230



8 052783 615027



MAG0260



8 052783 618370



MAG0231



8 052783 615034



MAG0263



8 052783 618400



MAG0233



8 052783 615058



MAG0261



8 052783 618387



MAG0234



8 052783 615065



MAG0264



8 052783 618417



MAG0235



8 052783 615072



MAG0236



8 052783 615089



MAG0266



8 052783 618431



MAG0262



8 052783 618394



MAG0265



8 052783 618424



MAG0267



8 051739 308914



MAG0268



8 051739 309256



MAG0237



8 052783 615096



MAG0238



8 052783 615225



MAG0239



8 052783 615232



MAG0240



8 052783 615249



MAG0269



8 053610 782004



MAG0271



8 053610 785036



MAG0272



8 053610 785043



MAG0273



8 052694 000660



MAG0243



8 052783 615270



MAG0245



8 052783 615294



MAG0249



8 052783 615331

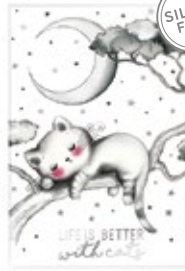

MAG0251



8 052783 615355



MAG0252



8 052783 615362

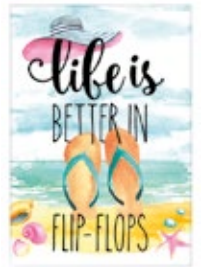

MAG0257



8 052783 615416

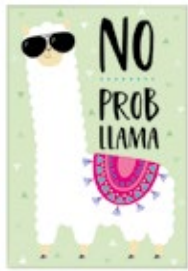

MAG0258



8 052783 615423



MAG0270



8 053610 782950

SOMETHING TO WRITE

L 14.8 x H 21 cm

SET OF FRIDGE MAGNETS

- The pack contains over 100 pieces, including letters, punctuation, numbers and symbols
- Material: magnetic rubber sheet

SET DI MAGNETI DA FRIGORIFERO

- Il set contiene più di 100 pezzi, incluse lettere, punteggiatura, numeri e simboli
- Materiale: foglio magnetico gommato

SET D'AIMANTS POUR FRIGO

- Le set comprend plus de 100 pièces, dont des lettres, des signes de ponctuation, des chiffres et des symboles
- Matériau : feuille magnétique caoutchoutée

SET DE IMANES PARA EL FRIGORÍFICO

- El set contiene más de 100 piezas, entre las que se incluyen letras, signos de puntuación, números y símbolos
- Material: hoja magnética revestida con goma

MAGNET-SET FÜR DEN KÜHLSCHRANK

- Das Set enthält mehr als 100 Stücke, inklusive Buchstaben, Satzzeichen, Zahlen und Symbolen
- Material: Magnetblatt mit Gummibeschichtung

* While stock lasts



PACKAGING

cardboard envelope
L 16 x H 24 cm

SOLD X 6

TYPEWRITER

STW0001 *



8 051122 265657

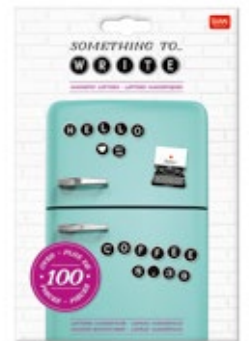

PACKAGING

cardboard envelope
L 16 x H 24 cm

SOLD X 6

AIRPORT *

STW0002



8 051122 265664



SOMETHING TO REMEMBER

L MAX 28 x H MAX 28 cm

MAGNETIC WHITEBOARD

- Marker with anti-choking cap conforming to toy regulations
- Material: magnetic rubber sheet

LAVAGNA MAGNETICA

- Pennarello conforme alla normativa giocattolo con tappo anti soffoco
- Materiale: foglio magnetico gommato

TABLEAU MAGNÉTIQUE

- Feutre avec bouchon anti-étouffement, conforme à la réglementation applicable aux jouets
- Matériau : feuille magnétique caoutchoutée

* While stock lasts

PIZARRA MAGNÉTICA

- Rotulador con tapón antiasfixia conforme a la normativa de juguetes
- Material: hoja magnética revestida con goma

MAGNETTAFEL

- Filzstift mit verschluckbarem Verschluss, entspricht der Spielzeuginhaltlinie
- Material: Magnetblatt mit Gummibeschichtung

PACKAGING

PVC bag w/hook
L MAX 28.5 x H MAX 35 cm

SOLD X 2

Magnetic marker
with felt eraser

AVOCADO

MBO0085 *



8 054320 569244



HEART

MBO0086 *



8 054320 569251



PANDA

MBO0087



8 054320 569268



RAINBOW

MBO0088



8 054320 569275



UNICORN

MBO0089



8 054117 621544



KITTY

MBO0090



8 054320 569282



STARS

MBO0091 *



8 054320 569299



TRAVEL

MBO0092 *



8 054320 569305

DON'T FORGET

L 11 x H MAX 26 x W 1.3 cm

MAGNETIC NOTEPAD

- 60 tear-off sheets
- 80 g/m² paper
- Pencil included
- Material: paper. Rigid cardboard backing. Magnetic base

BLOC-NOTES MAGNETICO

- 60 fogli staccabili
- Carta 80 g/m²
- Matita inclusa
- Materiale: carta. Supporto in cartoncino rigido. Base magnetica

BLOC-NOTES MAGNÉTIQUE

- 60 feuilles détachables
- Papier 80 g/m²
- Crayon inclus
- Matériau : papier. Support en carton rigide. Base magnétique

BLOC DE NOTAS MAGNÉTICO

- 60 hojas separables
- Papel 80 g/m²
- Lápiz incluido
- Material: papel. Soporte de cartón duro. Base magnética

MAGNETISCHER NOTIZBLOCK

- 60 abtrennbare Zettel
- Papier 80 g/m²
- Inklusive Bleistift
- Material: Papier. Basis aus stabilem Karton. Magnetische Basis

PACKAGINGshrink-wrapping w/hook
L 11 x H MAX 28 x W 1.3 cm**SOLD X 2**

RAINBOW
MNPO077



8 054320 566588



TRAVEL
MNPO081



8 054320 566625



AVOCADO
MNPO083



8 054320 566649



KITTY
MNPO084



8 054320 566656



LLAMA
MNPO085



8 054320 566663



PANDA
MNPO086



8 054320 566670

SHAKE YOUR BUTTS

Ø 7 cm, H 12 cm

PUSH-BUTTON ASHTRAY

- Material: tin, plastic

POSACENERE CON PULSANTE

- Materiale: latta, plastica

CENDRIER À POUSSOIR

- Matériau : fer-blanc, plastique

CENICERO CON PULSADOR

- Material: hojalata, plástico

ASCHENBECHER MIT DRUCKKNOPF

- Material: Blech, Kunststoff

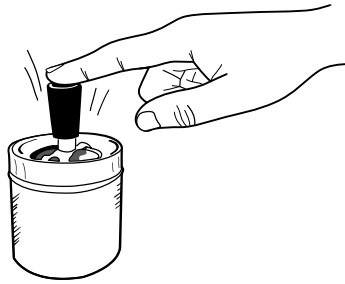

TRAVEL

DISPLAY

material: cardboard
L 8 x H 20 x W 22 cm

3 PCS

WASKIT1



TROPICAL

DISPLAY

material: cardboard
L 8 x H 20 x W 22 cm

3 PCS

WASKIT2



SLOTH

DISPLAY

material: cardboard
L 8 x H 20 x W 22 cm

3 PCS

WASKIT3



NOTES



LET'S **CELEBRATE**
Every Moment Counts

Make every get-together a moment to remember

GIFT BAG

GIFT BAG

• Bag made from matte laminated paper 210 g/m², printed with UV varnish or foil, ribbon handles

SACCHETTO REGALO

• Sacchetto in carta plastificata opaca 210 g/m², stampa con vernice UV o lamina, manici in nastro

SAC CADEAU

• Sac en papier plastifié opaque 210 g/m², impression avec vernis UV ou film laminé, poignées ruban

* While stock lasts

SOLD X 3

BOLSA DE REGALO

• Bolsa de papel plastificado opaco 210 g/m², Impresión con tinta UV o lámina, asas de cinta

GESCHENKTÜTE

• Tüte aus mattem, mit Kunststoffolie überzogenem Papier 210 g/m², Druck mit UV-Lack oder Folienprägung, Schlaufengriffe



SMALL
L 10 cm
H 15 cm
W 6.5 cm

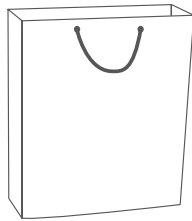

MEDIUM
L 19 cm
H 25 cm
W 11.5 cm

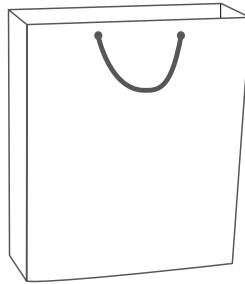

LARGE
L 26.5 cm
H 32.5 cm
W 11.5 cm

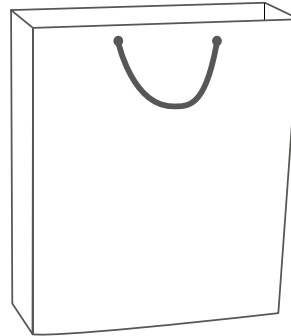

X-LARGE
L 31 cm | L 43 cm
H 43 cm | H 31 cm
W 11.5 cm | W 11.5 cm
VERTICAL HORIZONTAL

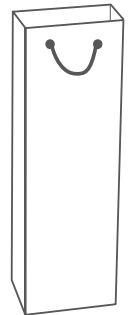

BOTTLE
L 12 cm
H 36 cm
W 8.5 cm

SMALL



TRAVEL
GB0352



TAG
GB0355



AIR BALLOON
GB0357



PANDA
GB0473



FLORA
GB0593



MEDIUM



HEART
GB0361



TRAVEL
GB0371



TAG
GB0376



AIR BALLOON
GB0378



HAPPINESS
GB0482



PANDA
GB0484



UNICORN CAKE
GB0585



CRYSTAL BALL
GB0586



RAINBOW
GB0588



STARS
GB0589



GRADUATION
GB0590



BABY BORN-GIRL
GB0591



BABY BORN-BOY
GB0592



CANDLES
GB0616



PARTY
GB0617



GIN
GB0618



SPACE
GB0619



UNICORN
GB0620



FLORA
GB0621



BOOK LOVER
GB0654



SWEETS
GB0655



LARGE



TRAVEL
GB0384



8 055748 242993



TAG
GB0389



8 055748 243044



AIR BALLOON
GB0391



8 055748 243068



CANDLES
GB0489



8 056304 486127



HEART
GB0594



8 054320 563587



PARTY
GB0595



8 054320 563594



GIN
GB0596



8 054320 563600



SPACE
GB0597



8 054320 563617



UNICORN
GB0598



8 054320 563624



FLORA
GB0599



8 054320 563631



UNICORN CAKE
GB0600



8 054320 563648



CRYSTAL BALL
GB0601



8 054320 563655



VINYL
GB0602



8 054320 563662



RAINBOW
GB0603



8 054320 563679



STARS
GB0604



8 054320 563686



GRADUATION
GB0605



8 054320 563693



BABY BORN - GIRL
GB0606



8 054320 563709



BABY BORN - BOY
GB0607



8 054320 563716



FLOWERS
GB0647



8 053610 785395



HAPPY BIRTHDAY
GB0648



8 053610 785401



SWEETS
GB0649



8 053610 785418

X-LARGE



FLOWERS
GB0650



8 053610 785425



HAPPY BIRTHDAY
GB0651



8 053610 785432



SPACE
GB0608



8 054320 563723



UNICORN
GB0609



8 054320 563730



STARS
GB0610



8 054320 563747



FLORA
GB0611



8 054320 563754



CANDLES
GB0615



8 054320 563792



TRAVEL
GB0399



8 055748 243143

BOTTLE



TRAVEL

GB0496



SMOKING

GB0497



WINE LOVER

GB0500



STARS

GB0613

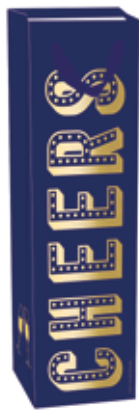

CHEERS

GB0614



FLOWERS

GB0652



MEERKAT

GB0653



DISPLAY ON DEMAND

Products not included



GIFT BAGS DISPLAY

Floor empty display on demand: MOQ 132 pcs material: metal Ø 31.5 cm, H 174 cm

DISGIF2

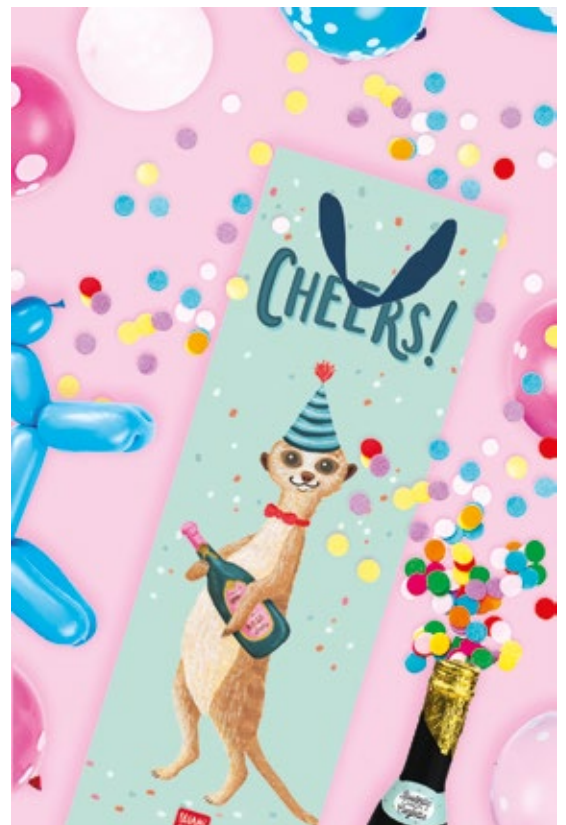

BOWS & RIBBON SET

SET OF TWO BOWS AND A RIBBON

- Contains 2 adhesive bows and 10 metres of ribbon
- Material: PP, PET

SET DI DUE FIOCCHI E UN NASTRO

- Contiene 2 fiocchi autoadesivi e 1 nastro di 10 metri
- Materiale: PP, PET

SET DE DEUX NŒUDS ET UN RUBAN

- Set contenant 2 nœuds adhésifs et 1 ruban de 10 mètres
- Matériau : PP, PET

SET DE DOS LAZOS Y UNA CINTA

- Contiene 2 lazos autoadhesivos y 1 cinta de 10 metros
- Material: PP, PET

SET MIT ZWEI SCHLEIFEN UND EINEM GESCHENKBAND

- Enthält zwei selbstklebende Schleifen und ein 10 Meter langes Geschenkband
- Material: PP, PET

PACKAGING

cello sleeve w/cardboard
L 10 x H 24 x W 4.5 cm

SOLD X 6



Large bow:
Ø 10 cm, H 4.5 cm



Small bow:
Ø 5 cm, H 2.5 cm



Ribbon:
L 6 x H 3.5 x W 3.5 cm



BAR0001

RED

BAR0002

YELLOW

BAR0003

BLUE

BAR0004

PINK

BAR0005

LIGHT BLUE

BAR0006

AQUA

BAR0007

GOLD

BAR0008

SILVER



GIFT BOX

LOVE MAIL BOX

GIFT BOX

- Sturdy material
- Reusable
- Swing open and shut
- Material: paper

SCATOLA REGALO

- Materiale resistente
- Riutilizzabile
- Chiusura basculante
- Materiale: carta

BOÎTE CADEAU

- Matériau solide
- Réutilisable
- Couvercle rabattable
- Matériau : papier

CAJA DE REGALO

- Material resistente
- Reutilizable
- Cierre basculante
- Material: papel

GESCHENKSCHACHETEL

- Stabiles Material
- Wiederverwendbar
- Verschlussklappe
- Material: Papier

SOLD X 2



XL L 12.1 x H 13.3 x W 22.2 cm

L L 10.1 x H 11.7 x W 19.2 cm

M L 8.5 x H 10.1 x W 15.8 cm

S L 6.5 x H 8.3 x W 12.2 cm



MLBKIT4



Contains: 4 boxes
to be sold individually

WRAPPING PAPER

L 200 x H 70 cm

WRAPPING PAPER

- Weight: 80 g/m²
- Cardboard centre tube diameter 35 mm

CARTA REGALO

- Grammaturo: 80 g/m²
- Anima in tubo rigido diametro 35 mm

PAPIER CADEAU

- Grammage : 80 g/m²
- Tube rigide central diamètre 35 mm

PAPEL DE REGALO

- Gramaje: 80 g/m²
- Tubo interior rígido con diámetro 35 mm

GESCHENKPAPIER

- Grammaturo: 80 g/m²
- Stabiler Pappkern mit Durchmesser von 35 mm

SOLD X 6

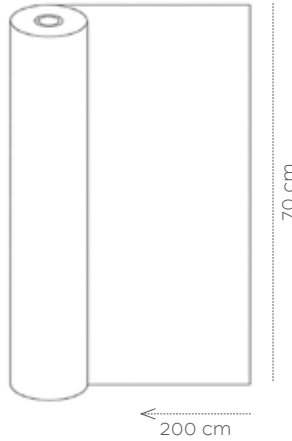

WRAPPING PAPER DISPLAY

Floor empty display on demand: MOQ 30 pcs
material: cardboard
L 28 x H 70 x W 30 cm

DISWRAP



TRAVEL
WRAP0001



STARS
WRAP0002



MUSICAL NOTE
WRAP0003



AFTER RAIN
WRAP0009



HEART
WRAP0021



HAPPY BIRTHDAY
WRAP0030





HOLO PRINT

CAKE
WRAP0031



8 053610 785074



DAISY
WRAP0032



8 053610 785081



GOLD FOIL

FLOWERS
WRAP0033



8 053610 785098



HOLO PRINT

RAINBOW
WRAP0034



8 053610 785104



SILVER FOIL

BABY BORN - BOY
WRAP0035



8 053610 785111



SILVER FOIL

BABY BORN - GIRL
WRAP0036



8 053610 785128



SILVER FOIL

SPACE
WRAP0037



8 053610 785135



HOLO PRINT

UNICORN
WRAP0038



8 053610 785142

SCRATCH OFF CARD

L 12.5 x H 17.5 cm

SCRATCH TO REVEAL GREETING CARD

- High-quality 350 g/m² cardstock greeting card
- Personalise the card with a message you can cover with the sticker included
- Scratch off sticker and envelope included

BIGLIETTO D'AUGURI GRATTA E SCOPRI

- Biglietto d'auguri in cartoncino di altissima qualità, 350 g/m²
- Personalizzabile con un messaggio da coprire con l'adesivo incluso
- Adesivo da grattare e busta inclusi

CARTE DE VŒUX À GRATTER

- Carte de vœux en carton de très haute qualité, 350 g/m²
- Personnalisable avec un message à couvrir à l'aide de l'autocollant fourni
- Autocollant à gratter et enveloppe inclus

TARJETA DE FELICITACIÓN RASCA Y DESCUBRE

- Tarjeta de felicitación de cartulina de alta calidad, 350 g/m²
- Personalizable con un mensaje que se cubre con el adhesivo incluido
- Adhesivo para rascar y sobre incluidos

RUBBELLOS-GLÜCKWUNSCHKARTE

- Glückwunschkarte aus besonders hochwertigem Karton (350 g/m²)
- Persönlich gestaltbar mit einer Nachricht, die durch den beiliegenden Aufkleber versteckt wird
- Rubbelaufkleber und Umschlag inklusive



1. Write your message and let the ink dry.



2. Cover the message with the silver sticker included.



3. The person who receives your card will then scratch the sticker away with a coin to read the secret message!



Scratch off sticker

DISPLAY
material: cardboard
L 14 x H 23.5 x W 7.5 cm
12 PCS



Scratch off sticker

DISPLAY
material: cardboard
L 14 x H 23.5 x W 7.5 cm
12 PCS



Scratch off sticker

DISPLAY
material: cardboard
L 14 x H 23.5 x W 7.5 cm
12 PCS



Scratch off sticker

DISPLAY
material: cardboard
L 14 x H 23.5 x W 7.5 cm
12 PCS





SILVER FOIL



DISPLAY
material: cardboard
L 14 x H 23.5 x W 7.5 cm
12 PCS

BGSKIT4



Scratch off sticker



GOLD FOIL



DISPLAY
material: cardboard
L 14 x H 23.5 x W 7.5 cm
12 PCS

BGSKIT5

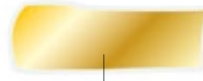

Scratch off sticker



GOLD FOIL



DISPLAY
material: cardboard
L 14 x H 23.5 x W 7.5 cm
12 PCS

BGSKIT6



Scratch off sticker



SILVER FOIL



DISPLAY
material: cardboard
L 14 x H 23.5 x W 7.5 cm
12 PCS

BGSKIT7



Scratch off sticker

SCRATCH OFF CARD - SPICY

L 12.5 x H 17.5 cm

SCRATCH TO REVEAL GREETING CARD

- High-quality 350 g/m² cardstock greeting card
- 6 possible spicy surprises

BIGLIETTO D'AUGURI GRATTA E SCOPRI

- Biglietto d'auguri in cartoncino di altissima qualità, 350 g/m²
- 6 possibili sorprese piccanti

CARTE DE VŒUX À GRATTER

- Carte de vœux en carton de très haute qualité, 350 g/m²
- 6 surprises coquines possibles

TARJETA DE FELICITACIÓN RASCA Y DESCUBRE

- Tarjeta de felicitación de cartulina de alta calidad, 350 g/m²
- 6 posibles sorpresas picantes

RUBBELLOS-GLÜCKWUNSCHKARTE

- Glückwunschkarte aus besonders hochwertigem Karton (350 g/m²)
- 6 mögliche pikante Überraschungen



GOLD FOIL



DISPLAY
material: cardboard
L 14 x H 23.5 x W 7.5 cm
12 PCS

BGSKIT9



Scratch the sticker away. Which of these spicy surprises will appear?

LITTLE BOYS GREETING CARDS

L 11,5 x H 17 cm

GREETING CARD

- Top-quality greeting card with coloured envelope, all cards embossed and worked with coloured foil

BIGLIETTO D'AUGURI

- Biglietto d'auguri di altissima qualità, con busta colorata, tutti i soggetti con lavorazioni a rilievo e lamina colorata

CARTE DE VŒUX

- Carte de voeux en carton de très haute qualité, avec enveloppe colorée, toutes les illustrations en relief et film laminé coloré

TARJETA DE FELICITACIÓN

- Tarjeta de felicitación de cartulina de alta calidad con sobre de color, todos los modelos con motivos en relieve y lámina de color

GLÜCKWUNSCHKARTE

- Glückwunschkarte aus hochwertigem Papier mit farbigem Kuvert, Reliefprägung und farbiger Folienprägung



BG0748



8 059174 833473



BG0749



8 059174 833480



BG0750



8 059174 833497



BG0751



8 059174 833503



BG0752



8 059174 833510



BG0753



8 059174 833527



BG0754



8 059174 833534



BG0755



8 059174 833541



BG0756



8 059174 833558



BG0757



8 059174 833565

LITTLE GIRLS GREETING CARDS

L 11.5 x H 17 cm

GREETING CARD

- Top-quality greeting card with coloured envelope, all cards embossed and worked with coloured foil

BIGLIETTO D'AUGURI

- Biglietto d'auguri di altissima qualità, con busta colorata, tutti i soggetti con lavorazioni a rilievo e lamina colorata

CARTE DE VŒUX

- Carte de voeux en carton de très haute qualité, avec enveloppe colorée, toutes les illustrations en relief et film laminé coloré

TARJETA DE FELICITACIÓN

- Tarjeta de felicitación de cartulina de alta calidad con sobre de color, todos los modelos con motivos en relieve y lámina de color

GLÜCKWUNSCHKARTE

- Glückwunschkarte aus hochwertigem Papier mit farbigem Kuvert, Reliefprägung und farbiger Folienprägung



BG0758



8 059174 833572

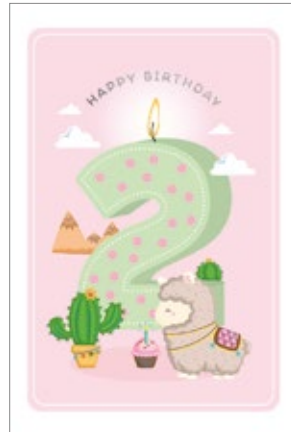

BG0759



8 059174 833589

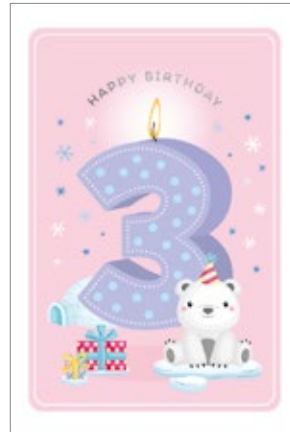

BG0760



8 059174 833596

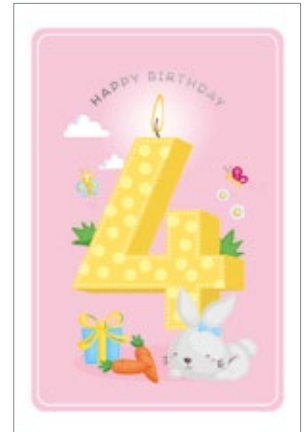

BG0761



8 059174 833602



BG0762



8 059174 833619



BG0763



8 059174 833626



BG0764



8 059174 833633



BG0765



8 059174 833640



BG0766



8 059174 833657



BG0767



8 059174 833664

GREETING CARDS

L 11.5 x H 17 cm

GREETING CARD

- Top-quality greeting card with coloured envelope, all cards embossed and worked with coloured foil

BIGLIETTO D'AUGURI

- Biglietto d'auguri di altissima qualità, con busta colorata, tutti i soggetti con lavorazioni a rilievo e lamina colorata

CARTE DE VŒUX

- Carte de voeux en carton de très haute qualité, avec enveloppe colorée, toutes les illustrations en relief et film laminé coloré

* While stock lasts

SOLD X 10

TARJETA DE FELICITACIÓN

- Tarjeta de felicitación de cartulina de alta calidad con sobre de color, todos los modelos con motivos en relieve y lámina de color

GLÜCKWUNSCHKARTE

- Glückwunschkarte aus hochwertigem Papier mit farbigem Kuvert, Reliefprägung und farbiger Folienprägung



BIRTHDAY



BG0388



8 057093 539636



BG0634



8 055748 241910



BG0658



8 056304 488244



BG0684



8 056304 488503



BG0685



8 056304 488510



BG0686



8 056304 488527



BG0687



8 056304 488534



BG0688



8 056304 488541

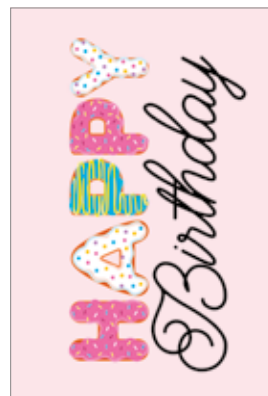

BG0690



8 056304 488565



BG0692



8 056304 488589



BG0693



8 056304 488596



BG0697



8 056304 488633



BG0702



8 051122 263929



BG0719



8 051739 309102



BG0720



8 051739 309119



BG0731



8 051739 306330



BG0733 ✱



8 051739 306354



BG0770



8 059174 833848

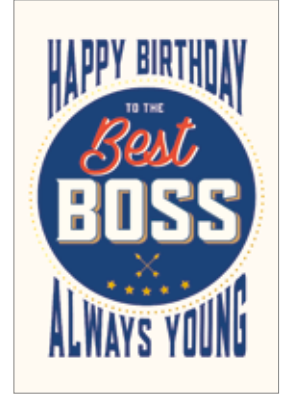

BG0771



8 059174 833862

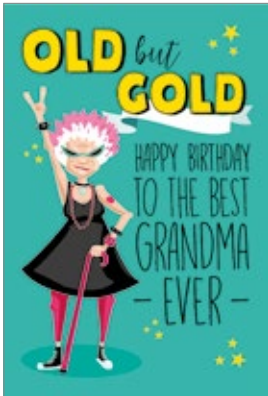

BG0772



8 059174 833879

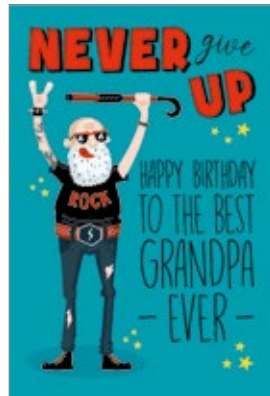

BG0773



8 059174 833886



BG0776



8 054117 628697



BG0777



8 054117 628703



BG0778



8 054117 628710



BG0779



8 054117 628727

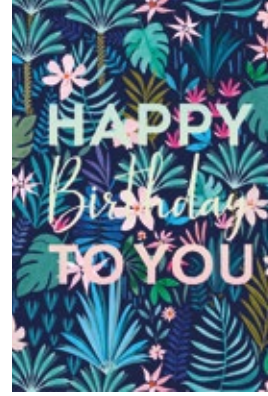

BG0780



8 054117 628734

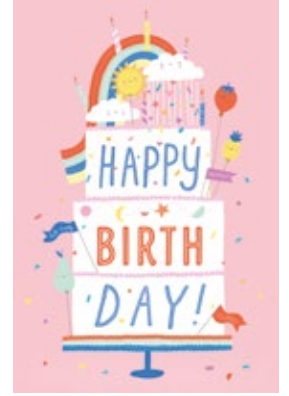

BG0781



8 054117 628741

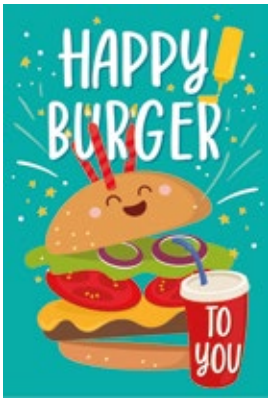

BG0782



8 054117 628758



BG0783



8 054117 628765



BG0784



8 054117 628772



BG0785



8 054117 628789



BG0786



8 054117 628796



BG0787



8 054117 628802



BG0788



8 054117 628819

LOVE & FRIENDSHIP



BG0337



8 051070 279966



BG0344



8 057093 530046



BG0345



8 057093 530053



BG0626



8 051764 521548



BG0676



8 056304 488428

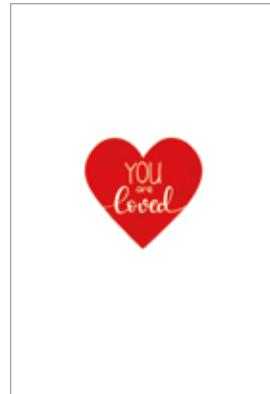

BG0677



8 056304 488435

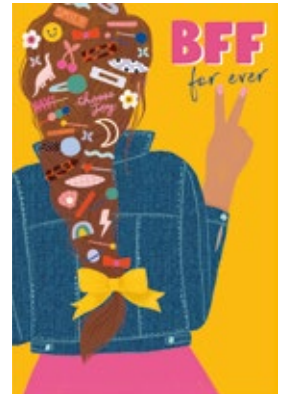

BG0789



8 054117 628826



BG0802



BG0803



BG0804

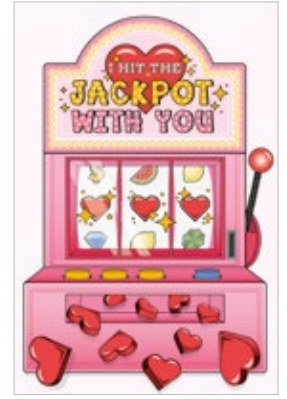

BG0805



BG0806



BABY BORN



BG0624



BG0625



BG0792

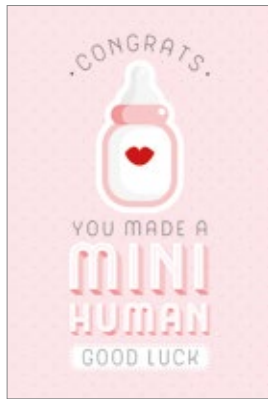

BG0670

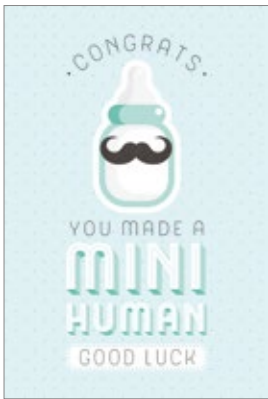

BG0671



BG0790



BG0791



VARIOUS



BG0338



BG0363





BG0651



8 056304 484123

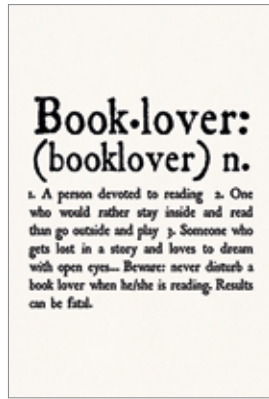

BG0652



8 056304 484130



BG0661



8 056304 488275



BG0662



8 056304 488282



BG0681



8 056304 488473



BG0682



8 056304 488480



BG0694



8 056304 488602



BG0698 *



8 056304 488640



BG0701



8 051122 263912



BG0703



8 051122 263936



BG0726



8 051739 306286

WEDDING & ANNIVERSARY



BG0339



8 051070 279980



BG0389



8 057093 539643



BG0627



8 051764 521555



BG0655



BG0672



BG0637



FAMILY



BG0403



BG0714



BG0715



GRADUATION

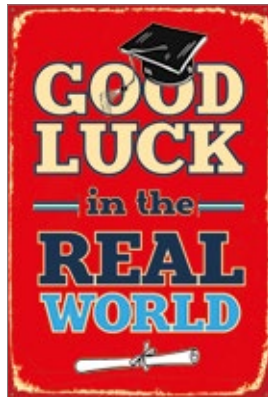

BG0343



BG0769



PERFECT MATCH

L 13 x H 12 cm

PUZZLE CARD

- Puzzle comes already pieced together
- Back can be personalised with a message

BIGLIETTO D'AUGURI PUZZLE

- Puzzle fornito già montato
- Retro da personalizzare con un messaggio

CARTE D'ANNIVERSAIRE PUZZLE

- Puzzle fourni déjà monté
- Dos du puzzle à personnaliser avec un message

TARJETA PUZLE DE FELICITACIÓN

- El puzle se suministra ya montado
- Parte trasera personalizable con un mensaje

PUZZLE-GRUSSKARTE

- Das Puzzle wird zusammengesetzt geliefert
- Rückseite mit Platz für eine persönliche Nachricht

Paper envelope included

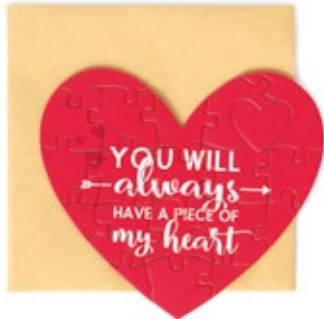

DISPLAY

material: cardboard
L 15 x H 17 x W 7.5 cm

12 PCS

BGHKIT1



PARTY GREETING CARDS

3D GREETING CARD

- Top-quality greeting card 350 g/m², with coloured envelopes
- All cards worked with coloured foil

3D-GLÜCKWUNSCHKARTE

- Glückwunschkarte aus hochwertigem Papier 350 g/m², mit farbigem Kuvert
- Alle Karten mit farbigem Folienprägung



BIGLIETTO D'AUGURI 3D

- Biglietto d'auguri in cartoncino di altissima qualità, 350 g/m² con busta colorata
- Tutti i soggetti con lavorazioni in lamina colorata

PACKAGING

biobased cello sleeve
L 12 x H 18 cm

CARTE DE VŒUX 3D

- Cartes de vœux en carton de très haute qualité 350 g/m², avec enveloppe colorée
- Toutes les illustrations en film laminé coloré

TARJETA DE FELICITACIÓN 3D

- Tarjeta de felicitación de cartulina de alta calidad 350 g/m², con sobres de color
- Todos los modelos con motivos en lámina de color



front

back



SOLD X 10



BG0643



8 056304 484048



BG0644



8 056304 484055



BG0645



8 056304 484062



BG0646



8 056304 484079



BG0647



8 056304 484086



BG0648



8 056304 484093

SMALL GREETING CARDS

L 7 x H 7 cm

SMALL GREETING CARD

- Top-quality greeting card with coloured envelopes
- All cards embossed and worked with coloured foil

BIGLIETTINO D'AUGURI

- Cartoncino di altissima qualità, con busta colorata
- Tutti i soggetti con lavorazioni a rilievo e lamina colorata

PETITE CARTE DE VŒUX

- Carte de vœux en carton de très haute qualité, avec enveloppe colorée
- Toutes les illustrations en relief et film laminé coloré

SOLD X 10

TARJETA DE FELICITACIÓN PEQUEÑA

- Tarjeta de felicitación de cartulina de alta calidad con sobres de color
- Todos los modelos con motivos en relieve y lámina de color

MINI-GLÜCKWUNSCHKARTE

- Glückwunschkarte aus hochwertigem Papier mit farbigem Kuvert
- Reliefprägung und farbiger Folienprägung

SMALL GREETING CARDS DISPLAY

Counter empty display on demand: MOQ 240 pcs
12 pockets
material: cardboard
L 19 x H 35.5 x W 30 cm

DISCA2X6



LOVE & FRIENDSHIP

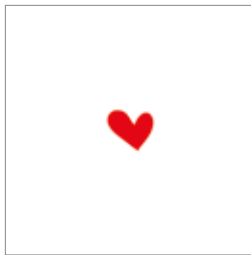

BQEL001



BQEL003



BQEL006



BQEL007



BQEL008

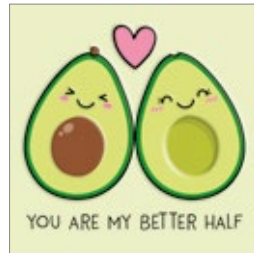

BQEL009

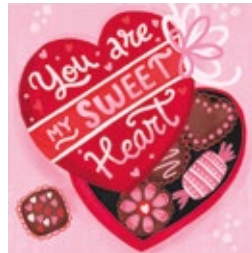

BQEL010



BQEL011



BQEL012



WEDDING & ANNIVERSARY



BQEW002



BABY BORN



BQEBB003



BQEBB004



BQEBB005



BQEBB006

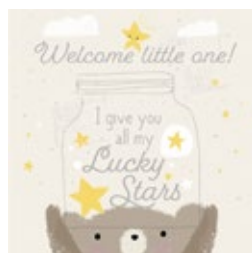

BQEBB007



GRADUATION



BQEG001





BIRTHDAY



BQEG002

BQEB001

BQEB002

BQEB003



8 059174 834074

8 056304 487551

8 056304 487568

8 056304 487575

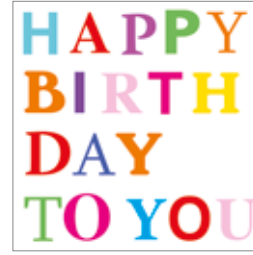

BQEB005

BQEB008

BQEB011

BQEB012

BQEB013



8 056304 487599

8 056304 487629

8 056304 487650

8 056304 487667

8 056304 487674

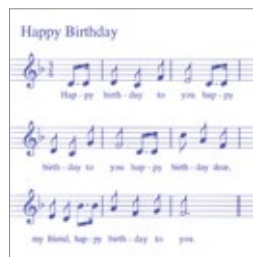

BQEB015

BQEB019

BQEB020

BQEB021

BQEB022



8 056304 487698

8 056304 487735

8 056304 487742

8 056304 487759

8 056304 487766



BQEB024

BQEB025

BQEB028

BQEB030

BQEB031



8 056304 487780

8 056304 487797

8 056304 487827

8 056304 487841

8 056304 487858

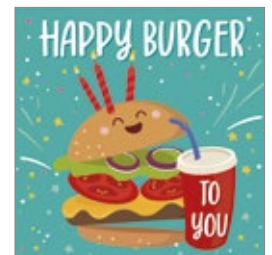
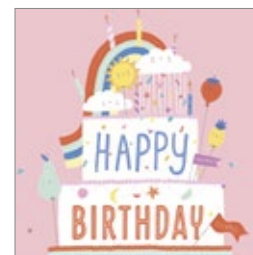
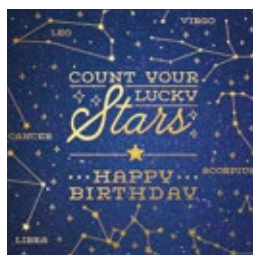

BQEB032

BQEB034

BQEB035

BQEB036

BQEB037



8 059174 833992

8 059174 834029

8 054117 628895

8 054117 628901

8 054117 628918



BQEB038



8 054117 628925



BQEB039



8 054117 628932



BQEB040



8 054117 628949



BQEB041



8 054117 628956



BQEB042



8 054117 628963



BQEB043



8 054117 628970

VARIOUS



BQEV003



8 056304 487995



BQEV004



8 056304 488008

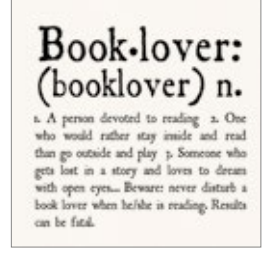

BQEV006



8 056304 488022



BQEV007



8 056304 488039

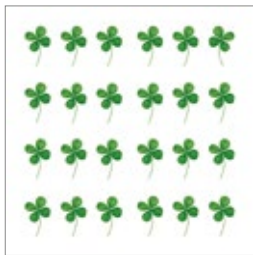

BQEV008



8 056304 488046



BQEV009



8 056304 488053

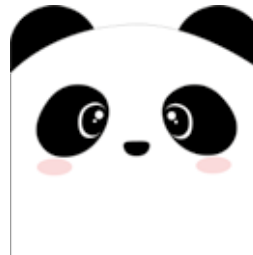

BQEV010



8 059174 834050

DISPLAYS ON DEMAND

REETING CARDS SPINNER DISPLAY 96+48 CARDS

Floor empty display on demand
Material: metal
L 60 x H 185 x W 60 cm

MOQ:

- 96 pockets for card sizes 11.5x17 cm (10 pcs per pocket, total 960 pcs)
- 48 pockets for card sizes 7x7 cm (10 pcs per pocket, total 480 pcs)

DISCAD96+48

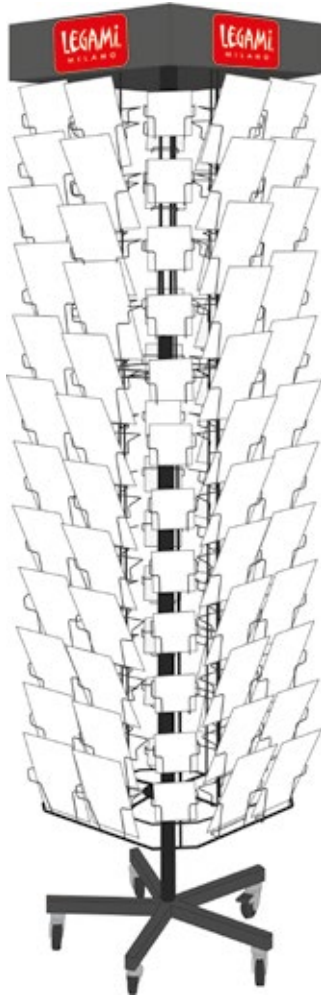

REETING CARDS SPINNER DISPLAY 44+44 CARDS

Floor empty display on demand
Material: metal
L 35 x H 180 x W 35 cm

MOQ:

- 44 pockets for card sizes 11.5x17 cm and 10.5x15.5 cm (10 pcs per pocket, total 440 pcs)
- 44 pockets for card sizes 7x7 cm (10 pcs per pocket, total 440 pcs)

DISCAD44+44

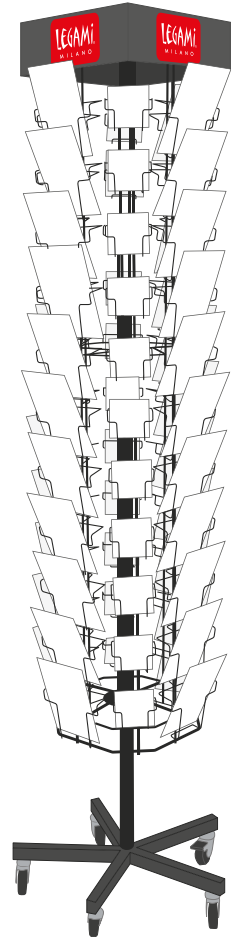

SMALL GREETING CARDS DISPLAY

Counter empty display on demand: MOQ 240 pcs
12 pockets
material: cardboard
L 19 x H 35.5 x W 30 cm

DISCA2X6



CONFETTI POPPER

Ø 4.5 cm, H 18.5 cm

CONFETTI POPPER

- Coloured confetti
- Material: plastic, paper

SPARACORIANDOLI

- Coriandoli colorati
- Materiale: plastica, carta

LANCE CONFETTIS

- Confettis colorés
- Matériau : plastique, papier

LANZADOR DE CONFETI

- Confeti de culores
- Material: plástico, papel

KONFETTIWERFER

- Bunte Konfetti
- Material: Kunststoff, Papier

SOLD X 3



BOTTLE PARTY POPPER

Ø 4.5 cm, H 18.5 cm

BOTTLE PARTY POPPER

- Product contents under pressure
- Material: plastic, paper

BOTTIGLIA SPARACORIANDOLI

- Prodotto con contenuto sotto pressione
- Materiale: plastica, carta

BOUEILLE CANON À CONFETTIS

- Produit au contenu sous pression
- Matériau : plastique, papier

BOTELLA LANZADORA DE CONFETI

- Producto con contenido a presión
- Material: plástico, papel

KONFETTIWERFER-FLASCHE

- Der Inhalt des Produkts steht unter Druck
- Material: Kunststoff, Papier



DISPLAY

material: cardboard
L 17 x H 26 x W 17 cm
9 PCS

MBCKIT1



MAXI BOTTLE PARTY POPPER

Ø 9.2 cm, H 33.5 cm

BOTTLE PARTY POPPER

- Product contents under pressure
- Material: plastic

BOTTIGLIA SPARACORIANDOLI

- Prodotto con contenuto sotto pressione
- Materiale: plastica

BOUEILLE CANON À CONFETTIS

- Produit au contenu sous pression
- Matériau : plastique

BOTELLA LANZADORA DE CONFETI

- Producto con contenido a presión
- Material: plástico

KONFETTIWERFER-FLASCHE

- Der Inhalt des Produkts steht unter Druck
- Material: Kunststoff

SOLD X 3

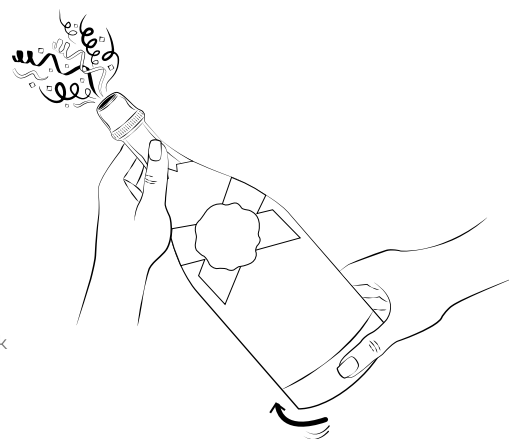

MBP0001



PINK OR BLUE, WE LOVE YOU

GENDER REVEAL PARTY KIT

- The kit contains: 1 giant balloon, 1 packet of pink confetti, 1 packet of blue confetti, 2 round balloons, 2 star-shaped balloons, 1 garland, 4 party blowers, 2 pins to burst the giant balloon
- Includes a paper straw for inflating the balloons
- 1 string for tying the balloons
- Material: natural latex, aluminium foil film, paper

KIT FESTA DI GENDER REVEAL

- Il kit contiene: 1 palloncino gigante, 1 confezione di coriandoli rosa, 1 confezione di coriandoli azzurri, 2 palloncini rotondi, 2 palloncini a forma di stella, 1 ghirlanda, 4 trombette, 2 puntine per scoppiare il palloncino gigante
- Cannuccia in carta per il gonfiaggio dei palloncini inclusa
- 1 nastro per legare i palloncini
- Materiale: lattice naturale, pellicola di alluminio, carta

KIT POUR GENDER REVEAL PARTY

- Le kit comprend : 1 ballon géant, 1 paquet de confettis roses, 1 paquet de confettis bleus, 2 ballons ronds, 2 ballons en forme d'étoile, 1 guirlande, 4 sifflets, 2 épingles pour faire exploser le ballon géant
- Paille en papier pour gonfler les ballons incluse
- 1 ruban pour accrocher les ballons
- Matériau : latex naturel, film d'aluminium, papier

KIT PARA FIESTA DE REVELACIÓN DE GÉNERO

- El kit contiene: 1 globo gigante, 1 paquete de confeti rosa, 1 paquete de confeti celeste, 2 globos redondos, 2 globos en forma de estrella, 1 guirnalda, 4 matasuegras y 2 punzones para explotar el globo gigante
- Pajita de papel para inflar los globos incluida
- 1 cinta para atar los globos
- Material: látex natural, película de aluminio, papel

SET FÜR DIE GENDER REVEAL PARTY

- Das Set enthält: 1 Riesenluftballon, 1 Päckchen mit rosa Konfetti, 1 Päckchen mit hellblauem Konfetti, 2 runde Luftballons, 2 Luftballons in Sternform, 1 Girlande, 4 Tröten, 2 Reißzwecken, um den Riesenluftballon zum Platzen zu bringen
- Inklusive Papierstrohhalm zum Aufblasen der Ballons
- 1 Band zum Binden der Luftballons
- Material: Naturlatex, Aluminiumfolie, Papier

PACKAGING

cardboard box
L 13,3 x H 17 x W 4,3 cm

SOLD X 4

GRK0001



8 052694 001483



L 215 cm

Jumbo Balloon:
Ø 90 cm

String length: 5 m

L 2.6 x H 7.5 cm (closed)

L 40 x H 40 cm (size of inflated balloons)

L 32 x H 32 (size of inflated balloons)

LET'S PARTY!

SET OF 5 BIRTHDAY PARTY BALLOONS

- With hole for hanging the balloons
- Includes a paper straw for inflating the balloons
- 1 string for tying the balloons
- Material: aluminium foil film

SET DI 5 PALLONCINI PER FESTA DI COMPLEANNO

- Con foro per appendere i palloncini
- Cannuccia in carta per il gonfiaggio dei palloncini inclusa
- 1 nastro per legare i palloncini
- Materiale: pellicola di alluminio

SET DE 5 BALLONS D'ANNIVERSAIRE

- Avec un trou pour suspendre les ballons
- Paille en papier pour gonfler les ballons incluse
- 1 ruban pour accrocher les ballons
- Matériau : film d'aluminium

SET DE 5 GLOBOS PARA FIESTA DE CUMPLEAÑOS

- Con orificio para colgar los globos
- Pajita de papel para inflar los globos incluida
- 1 cinta para atar los globos
- Material: película de aluminio

5ER-SET LUFTBALLONS FÜR GEBURTSTAGSFEIER

- Mit Loch zum Aufhängen der Luftballons
- Inklusive Papierstrohhalm zum Aufblasen der Ballons
- 1 Band zum Binden der Luftballons
- Material: Aluminiumfolie



2 stars balloon all rounded
40 x 40 cm
(size of inflated balloons)



2 round balloons all rounded
32 x 32 cm
(size of inflated balloons)



L 37 x H 70 x W 22 cm
(size of inflated balloons)



PACKAGING
cardboard box
L 13.3 x H 17 x W 4.3 cm
SOLD X 4

UNICORN
BLN0001



8 052694 001490



String length: 5 m



2 stars balloon all rounded
L 40 x H 40 cm
(size of inflated balloons)



1 round balloons all rounded
L 32 x H 32 cm
(size of inflated balloons)



L38.5 x H 50 x W 21 cm
(size of inflated balloons)



L 46 x H 66 x W 19 cm
(size of inflated balloons)



PACKAGING
cardboard box
L 13.3 x H 17 x W 4.3 cm
SOLD X 4

SPACE
BLN0002



8 052694 001506



String length: 5 m

IT'S PARTY TIME

BIRTHDAY PARTY KIT

- The kit contains 1 garland, 1 crown, 4 party blowers, 5 balloons
- Includes a paper straw for inflating the balloons
- Material: paper, cardboard, aluminium foil film, plastic

KIT FESTA DI COMPLEANNO

- Il kit contiene 1 ghirlanda, 1 corona, 4 trombette, 5 palloncini
- Cannuccia in carta per il gonfiaggio dei palloncini inclusa
- Materiale: carta, cartoncino, pellicola di alluminio, plastica

KIT FÊTE D'ANNIVERSAIRE

- Le kit contient 1 guirlande, 1 couronne, 4 sifflets, 5 ballons
- Paille en papier pour gonfler les ballons incluse
- Matériau : papier, carton, film d'aluminium, plastique

KIT PARA FIESTAS DE CUMPLEAÑOS

- El kit contiene 1 guirnalda, 1 corona, 4 matasuegras y 5 globos
- Pajita de papel para inflar los globos incluida
- Material: papel, cartulina, película de aluminio, plástico

SET FÜR GEBURTSTAGSPARTY

- Das Set enthält 1 Girlande, 1 Krone, 4 Tröten, 5 Luftballons
- Inklusive Papierröhrchen zum Aufblasen der Luftballons
- Material: Papier, Karton, Aluminiumfolie, Kunststoff

PACKAGING

cardboard box
L 13.3 x H 17 x W 4.3 cm

SOLD X 4

BPD0001



8 053610 781746



L 215 cm



Adjustable:
Ø MIN 16 cm - MAX 19 cm



L 2.6 x H 7.5 cm (closed)



2 X



2 X

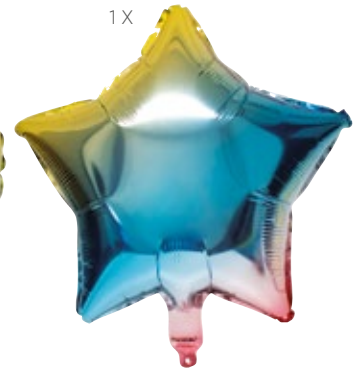

1 X

L 20 x H 20 cm / L 32 x H 32 cm / L 40 x H 40 cm
(size of inflated balloons)

BIRTHDAY CALENDAR

L 11.5 x H 30.5 cm

BIRTHDAY CALENDAR

- Perpetual wall calendar with spiral binding
- 14 sheets of 200 g/m² natural hammered paper

CALENDARIO DEI COMPLEANNI

- Calendario perpetuo da parete con rilegatura a spirale
- 14 fogli in carta 200 g/m² naturale martellata

CALENDRIER DES ANNIVERSAIRES

- Calendrier perpétuel mural avec reliure à spirale
- 14 feuilles en papier 200 g/m² naturel martelé

CALENDARIO PARA CUMPLEAÑOS

- Calendario perpetuo de pared con espiral
- 14 hojas de papel 200 g/m² natural martillado

GEBURTSTAGSKALENDER

- Ewiger Wandkalender mit Spiralbindung
- 14 Blätter aus natürlichem strukturiertem Papier 200 g/m²

SOLD X 3

BDC0001



8 052783 617076



GOLD
FOIL

12 zodiac
signs
(1 per month)



LOVE IS IN THE AIR

DECORATIONS KIT FOR A ROMANTIC EVENING

- The kit contains 1 garland, 2 coasters, 2 napkins, 5 balloons and decorative confetti
- Paper straw for inflating the balloons included
- Material: plastic coated paper, cardboard, paper, aluminium foil film, PP

KIT DECORAZIONE SERATA ROMANTICA

- Il kit contiene 1 ghirlanda, 2 sottobicchieri, 2 tovaglioli, 5 palloncini, coriandoli decorativi
- Cannuccia in carta per il gonfiaggio dei palloncini inclusa
- Materiale: carta plastificata, cartoncino, carta, pellicola di alluminio, PP

KIT DÉCORATION SOIRÉE ROMANTIQUE

- Le kit contient 1 guirlande, 2 dessous de verre, 2 serviettes, 5 ballons et des confettis
- Paille en papier pour gonfler les ballons incluse
- Matériau : papier plastifié, carton, papier, film d'aluminium, PP

KIT DECORATIVO PARA UNA NOCHE ROMÁNTICA

- El kit incluye 1 guirnalda, 2 posavasos, 2 servilletas, 5 globos y confeti decorativo
- Pajita de papel para inflar los globos incluida
- Material: papel plastificado, cartulina, papel, película de aluminio, PP

DEKO-SET FÜR ROMANTISCHE ABENDE

- Das Set enthält 1 Girlande, 2 Glasuntersetzer, 2 Servietten, 5 Luftballons, Konfetti zum Dekorieren
- Inklusive Papierröhrchen zum Aufblasen der Luftballons
- Material: kunststoffbeschichteter Karton, Karton, Papier, Aluminiumfolie, PP

PACKAGING

cardboard box
L 13.3 x H 17 x W 4.3 cm

SOLD X 4

DS0001

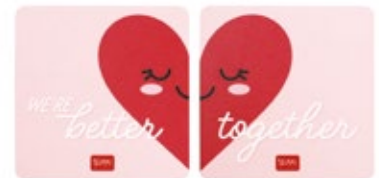

BALLOON MODELLING KIT

BALLOON MODELLING KIT

- Includes: 32 coloured balloons, 1 mini pump, 72 stick-on eyes, instructions
- Material: plastic, paper

KIT PALLONCINI MODELLABILI

- Include: 32 palloncini colorati, 1 pompetta, 72 occhi adesivi, istruzioni
- Materiale: plastica, carta

KIT BALLONS MODELABLES

- Il inclut : 32 ballons colorés, 1 petite pompe, 72 yeux adhésifs, le mode d'emploi
- Matériau : plastique, papier

KIT GLOBOS PARA MODELAR

- Incluye: 32 globos de colores, 1 mini inflador, 72 ojos adhesivos, instrucciones
- Material: plástico, papel

KIT MIT MODELLIERBAREN LUFTBALLONS

- Enthält: 32 farbige Luftballons, 1 kleine Pumpe, 72 Klebeaugen, Anweisungen
- Material: Kunststoff, Papier

PACKAGING

cardboard box
L 17 x H 10 x W 5 cm

SOLD X 4

BALL0001



THE PARTY IS ON

Ø 4.2 cm, L 10 cm (including pom pom)

SET OF 8 PARTY HATS

- With pompom and glitter
- One size
- Material: paper

SET DI 8 CAPPELLINI DA FESTA

- Con pompon e dettagli glitterati
- Taglia unica
- Materiale: carta

SET DE 8 CHAPEAUX FESTIFS

- Avec pompon et détails pailletés
- Taille unique
- Matériau : papier

SET DE 8 GORROS DE FIESTA

- Con pompon y detalles de purpurina
- Talla única
- Material: papel

SET MIT 8 PARTYHÜTCHEN

- Mit Pompons und Glitterdetails
- Einheitsgröße
- Material: Papier

PACKAGING

view top box
w/ cardboard base
L 13.5 x H 25.6 x W 5.9 cm

SOLD X 4

PHAT0001



8 053610 781755



PARTY KING & QUEEN

Ø 22 cm, H 19 cm (when inflated)

INFLATABLE CROWN

- Adult size
- Material: PVC

CORONA GONFIABILE

- Taglia adulta
- Materiale: PVC

COURONNE GONFLABLE

- Taille pour adultes
- Matériau : PVC

CORONA INFLABLE

- Talla de adulto
- Material: PVC

AUFBLASBARE KRONE

- Erwachsenengröße
- Material: PVC



PACKAGING
cardboard box
L 13 x H 18 x W 3 cm



DISPLAY
material: cardboard
L 14 x H 31.5 x W 23 cm
7 PCS

CROKIT1



PACKAGING
cardboard box
L 13 x H 18 x W 3 cm



DISPLAY
material: cardboard
L 14 x H 31.5 x W 23 cm
7 PCS

CROKIT2



PARTY PRINCE & PRINCESS

Ø 20 cm, H 16 cm (when inflated)

INFLATABLE CROWN

- Suitable for children between 3 and 10 years of age
- Material: PVC

CORONA GONFIABILE

- Adatta per bambini dai 3 ai 10 anni
- Materiale: PVC

COURONNE GONFLABLE

- Elle convient aux enfants de 3 à 10 ans
- Matériau : PVC

CORONA INFLABLE

- Adecuada para niños de 3 a 10 años
- Material: PVC

AUFBLASBARE KRONE

- Geeignet für Kinder von 3 bis 10 Jahren
- Material: PVC



PACKAGING
cardboard box
L 13 x H 18 x W 3 cm



DISPLAY
material: cardboard
L 14 x H 31.5 x W 23 cm
7 PCS

CROKIT3



PACKAGING
cardboard box
L 13 x H 18 x W 3 cm



DISPLAY
material: cardboard
L 14 x H 31.5 x W 23 cm
7 PCS

CROKIT4



MAXI CANDLES

L MAX 7.5 x H 15 x W 1.5 cm (plastic holder included)

MAXI CAKE CANDLE

- With glitter
- Plastic holder

MAXI CANDELA PER TORTA

- Con glitter
- Supporto in plastica

MAXI BOUGIE POUR GÂTEAU

- Avec paillettes
- Support en plastique

* While stock lasts

MAXI VELA PARA TARTA

- Con purpurina
- Soporte de plástico

MAXI-KERZE FÜR TORTE

- Mit Glitter
- Kerzenhalter aus Kunststoff

PACKAGING

PVC box w/hook
L 11 x H 22 x W 2 cm

SOLD X 3



NUC0001 *



8 051739 308518



NUC0002 *



8 051739 308525



NUC0003 *



8 051739 308532



NUC0004



8 051739 308549



NUC0005 *



8 051739 308556



NUC0006 *



8 051739 308563



NUC0007 *



8 051739 308570



NUC0008 *



8 051739 308587



NUC0009 *



8 051739 308594



NUC0010 *



8 051739 308600



NUC0011 *



8 051739 308617



NUC0012 *



8 051739 308624



NUC0013 *



8 051739 308631



NUC0014 *



8 051739 308648



NUC0015 *



8 051739 308655



NUC0016 *



8 051739 308662



NUC0017 *



8 051739 308679



NUC0018 *



8 051739 308686



NUC0019



8 051739 308693



NUC0020 *



8 051739 308709

HAPPY BIRTHDAY CANDLES

L 4 x H 10 cm x W 1 cm (plastic holder included)



CAKE CANDLE

- Plastic holder

CANDELA PER TORTA

- Supporto in plastica

BOUGIE POUR GÂTEAU

- Support en plastique

VELA PARA TARTA

- Soporte de plástico

KERZE FÜR TORTE

- Kerzenhalter aus Kunststoff

PACKAGING

window box
L 5 x H 12,6 x W 1,6 cm
SOLD X 6



HAPPY BIRTHDAY CANDLE DISPLAY

Full assorted display
MQ 120 pcs
material: cardboard
L 25,3 x H 26,5 x W 19,7 cm

DISCNU-GROUP



8 052694 017583



CNU0001



8 052694 016593



CNU0002



8 052694 016609



CNU0003



8 052694 016616



CNU0004



8 052694 016623



CNU0005



8 052694 016630



CNU0006



8 052694 016647



CNU0007



8 052694 016654



CNU0008



8 052694 016661



CNU0009



8 052694 016678



CNU0010



8 052694 016685



CNU0011



8 052694 016692



CNU0012



8 052694 016708



CNU0013



8 052694 016715



CNU0014



8 052694 016722



CNU0015



8 052694 016739



CNU0016



8 052694 016746



CNU0017



8 052694 016753



CNU0018



8 052694 016760



CNU0019



8 052694 016777



CNU0020



8 052694 016784

PARTY CANDLES WITH COLOURED FLAME

Ø 0.5 cm, H 6 cm (plastic holder included)

PARTY CANDLES WITH COLOURED FLAME

- Plastic holders

CANDELINE CON FIAMMA COLORATA

- Supporti in plastica

BOUGIES DE FÊTE À FLAMME COLORÉE

- Supports en plastique

VELAS CON LLAMA DE COLORES

- Soportes de plástico

GEBURTSTAGSKERZEN MIT BUNTER FLAMME

- Kerzenstecker aus Kunststoff

PACKAGING
cardboard box
L 12 x H 13 x W 1.5 cm



DISPLAY
material: cardboard
L 13 x H 24 x W 19 cm
12 PCS

FLCKIT1



8 051128 755459



12 holders included

**PARTY CANDLES**

H 7 cm (plastic stand included)

CAKE CANDLES

- Plastic holders

CANDELINE PER TORTA

- Supporti in plastica

BOUGIES POUR GÂTEAU

- Supports en plastique

VELAS PARA TARTA

- Soportes de plástico

KERZEN FÜR TORTE

- Kerzenhalter aus Kunststoff

PACKAGING
window box
L 14 x H 10 x W 2.5 cm
SOLD X 6

HAP0002



8 052783 614150

**CAKE CANDELABRA**

Ø 13.5 cm, H 14 cm (plastic holder included)

CAKE CANDELABRA

- 9 candles included
- Material: plastic

CANDELABRO PER TORTE

- 9 candeline incluse
- Materiale: plastica

CHANDELIER POUR GÂTEAUX

- 9 bougies incluses
- Matériau : plastique

CANDELABRO PARA TARTAS

- 9 velas incluidas
- Material: plástico

KERZENSTÄNDER FÜR TORTE

- Inklusive 9 Kerzen
- Material: Kunststoff

PACKAGING
window box
L 12.5 x H 11 x W 5 cm



DISPLAY
material: cardboard
L 26 x H 18.5 x W 10.5 cm
4 PCS

CANKIT1



8 051128 750133





LOL *Land of Laughs*

Laugh-out-loud magic to lighten any mood

STRESS LESS

ANTI-STRESS TOY

• Material: polyurethane

PUPAZZO ANTISTRESS

• Materiale: poliuretano

JOUET ANTI-STRESS

• Matériau : polyuréthane

JUGUETE ANTIESTRÉS

• Material: poliuretano

ANTISTRESS-SPIELZEUG

• Material: Polyurethan

SOLD X 2

PACKAGING

window box
L 7.4 x H 10 x W 7.4 cm

TRAVEL

SQ10001



8 053610 783865



PACKAGING

window box
L 7.2 x H 9 x W 5.2 cm

HEART

SQ10002



8 053610 783872



PACKAGING

window box
L 7 x H 10 x W 7 cm

POO

SQ10003



8 053610 783889



PACKAGING

window box
L 9 x H 12.5 x W 5 cm

LLAMA

SQ10004



8 053610 783896



PACKAGING

window box
L 8 x H 22.5 x W 4.8 cm

BANANA

SQ10005



8 052694 001902



PACKAGING

window box
L 8.8 x H 17 x W 4.2 cm

BOSS

SQ10006



8 052694 001919



PACKAGING

window box
L 8.8 x H 17 x W 4.2 cm

EX

SQ10007



8 052694 001926



PACKAGING

window box
L 8.8 x H 17 x W 4.2 cm

TEACHER

SQ10008



8 052694 003616



ANTI-STRESS FORMULA

ANTI-STRESS TOY

• Material: latex, maltose

PUPAZZO ANTISTRESS

• Materiale: lattice, maltosio

JOUET ANTI-STRESS

• Matériau : latex, maltose

JUGUETE ANTIESTRÉS

• Material: látex, maltosa

• **ANTISTRESS-SPIELZEUG**

• Material: Latex, Maltose

* While stock lasts

SOLD X 2

PACKAGING

clamshell
L 13.3 x H 20.3 x W 4.3 cm

BOSS

STRES0006 *



PACKAGING

clamshell
L 13.3 x H 20.3 x W 4.3 cm

EX

STRES0007 *



PACKAGING

clamshell
L 14.5 x H 26 x W 6.5 cm

BANANA

STRES0008 *



SQUEEZE ME!

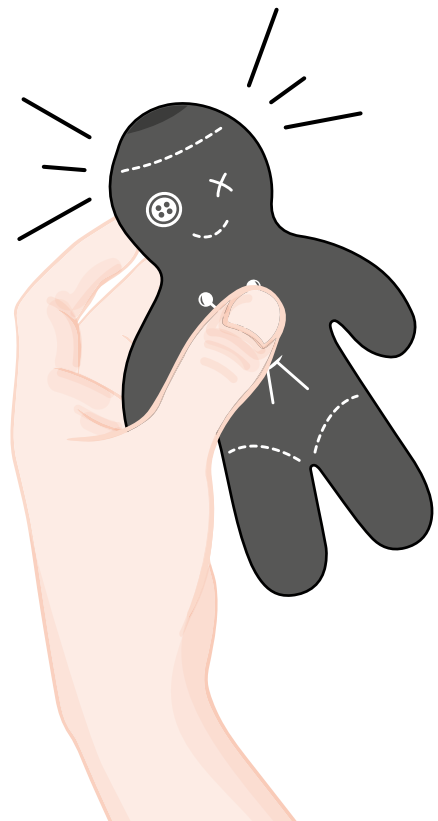

GIFT VOUCHERS

L 20.3 x H 8.2 x W 0.8 cm

BOOK OF 24 VOUCHERS

- 24 vouchers with perforated edges for easy tearing
- Material: paper

BLOCCHETTO DA 24 VOUCHER

- 24 voucher con perforazione per lo strappo
- Materiale: carta

CARNET DE 24 BONS

- 24 bons avec perforation pour les détacher
- Matériau : papier

SOLD X 5

BLOQUE DE 24 CUPONES

- 24 cupones perforados para arrancar
- Material: papel

BLOCK MIT 24 GUTSCHEINEN

- 24 Gutscheine mit Perforation zum Abreißen
- Material: Papier



ROMANTIC GIFT VOUCHERS



ENGLISH

LC0002



ITALIAN

LC0001



FRENCH

LC0003



SPANISH

LC0004



GERMAN

LC0005



PORTUGUESE

LC0006



SPICY GIFT VOUCHERS



ENGLISH

SXC0001



ITALIAN

SXC0002



FRENCH

SXC0003



SPANISH

SXC0004



GERMAN

SXC0005



PORTUGUESE

SXC0006





DAD GIFT VOUCHERS

SILVER FOIL

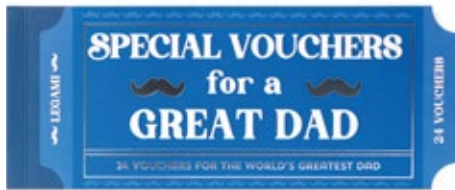

ENGLISH 
DVO0001

8 053610 784060



ITALIAN 
DVO0002

8 053610 784077



FRENCH 
DVO0003

8 053610 784084



SPANISH 
DVO0004

8 053610 784091



GERMAN 
DVO0005

8 053610 784107



PORTUGUESE 
DVO0006

8 053610 784114

MUM GIFT VOUCHERS

HOLD PRINT



ENGLISH 
MVO0001

8 053610 784008



ITALIAN 
MVO0002

8 053610 784015



FRENCH 
MVO0003

8 053610 784022



SPANISH 
MVO0004

8 053610 784039



GERMAN 
MVO0005

8 053610 784046



PORTUGUESE 
MVO0006

8 053610 784053

OUR LOVE IS FOREVER

L 4 x H 6.5 x W 2 cm

LOVERS' PADLOCK

- 2 keys included
- Material: metal

LUCCHETTO DEGLI INNAMORATI

- 2 chiavi incluse
- Materiale: metallo

CADENAS D'AMOUR

- 2 clés incluses
- Matériau : métal

CANDADO DE LOS ENAMORADOS

- Incluye 2 llaves
- Material: metal

VORHÄNGESCHLOSS FÜR VERLIEBTE

- Inklusive 2 Schlüssel
- Material: Metall

PACKAGING

window box
L 11.7 x H 14.7 x W 3.5 cm

SOLD X 4

LOV0001



8 052783 614051



LOVE IS THE ANSWER

L 10 x H 10 x W 7 cm

HEART OF ANSWERS

- Contains a multi-sided dice with 20 possible answers (in English)
- Material: ABS

CUORE DELLE RISPOSTE

- Contiene un dado a più facce con 20 possibili risposte (in inglese)
- Materiale: ABS

COEUR À RÉPONSES

- Il contient un dé à plusieurs faces comptant 20 réponses possibles (en anglaise)
- Matériau : ABS

CORAZÓN DE LAS RESPUESTAS

- Contiene un dado de varias caras con 20 posibles respuestas (en inglés)
- Material: ABS

HERZ DER ANTWORTEN

- Enthält einen Würfel mit mehreren Seiten und mit 20 möglichen Antworten (in englischer Sprache)
- Material: ABS

PACKAGING

cardboard box
L 10.5 x H 8.5 x W 10.3 cm

SOLD X 4

LIA0001 *



8 059174 835781



* While stock lasts



No batteries needed



FOIL AND GLITTER

WHO AM I?

L 18 x H 12 cm
Pen: Ø 1 cm, H 11.5 cm

"WHO AM I?" GUESSING GAME

- 8 pairs of paper glasses
- 35 pre-written cards and 15 blank cards to fill in with names of your choice
- Marker with felt eraser included
- Material: paper

GIOCO INDOVINA CHI SONO

- 8 occhiali di carta
- 35 carte compilate e 15 carte libere su cui scrivere personaggi sempre nuovi
- Pennarello con feltro per cancellare incluso
- Materiale: carta

JEU « QUI SUIS-JE ? »

- 8 paires de lunettes en papier
- 35 cartes complétées et 15 cartes vierges sur lesquelles écrire vos propres idées
- Inclus : marqueur effaçable avec brosse en feutre pour effacer les noms
- Matériau : papier

JUEGO ADIVINA QUIÉN SOY

- 8 gafas de papel
- 35 tarjetas con los nombres ya escritos y 15 tarjetas libres para escribir nuevos personajes
- Incluye rotulador con fieltro para borrar
- Material: papel

RATESPIEL WER BIN ICH?

- 8 Papierbrillen
- 35 ausgefüllte Karten und 15 Blankokarten, auf die man immer wieder neue Persönlichkeiten schreiben kann
- Stift mit Filz zum Löschen im Lieferumfang enthalten
- Material: Papier

PACKAGING
cardboard box
L 18 x H 13 x W 4 cm
SOLD X 6

PGL0001
8 052694 001537



2-8 PLAYERS

UP TO 100 NAMES TO GUESS



HOT MOUSTACHE

L MAX 10 x H MAX 6.3 x W 0.5 cm

SET OF 6 SELF-ADHESIVE FAKE MOUSTACHES

- Easy to apply
- Single use adhesive
- Material: polyester, cotton

SET DI 6 BAFFI FINITI AUTOADESIVI

- Facili da applicare
- Adesivo monouso
- Materiale: poliestere, cotone

SET DE 6 FAUSSES MOUSTACHES AUTOCOLLANTES

- Faciles à appliquer
- Autocollant à usage unique
- Matériau : polyester, coton

SET DE 6 BIGOTES POSTIZOS AUTOADHESIVOS

- Fáciles de aplicar
- Adhesivo desechable
- Material: poliéster, algodón

SET MIT 6 SELBSTKLEBENDEN FALSCHEN SCHNURRBÄRTEN

- Einfache Anbringung
- Einweg-Klebstoff
- Material: Polyester, Baumwolle

PACKAGING

carded
L 23 x H 20 x W 0.5 cm
SOLD X 6

FMU0001



8 054320 565925

**PRISON BREAK**

L 12.5 x H 18.5 x W 15.5 cm

CELL PHONE JAIL

- With a 60-minute timer that you can set
- Holds up to 6 cell phones
- Material: ABS, PP, metal

PRIGIONE PER CELLULARI

- Con timer fino a 60 minuti, regolabile manualmente
- Può contenere fino a 6 cellulari
- Materiale: ABS, PP, metallo

PRISON POUR TÉLÉPHONE PORTABLE

- Avec une minuterie réglable manuellement jusqu'à 60 minutes
- Peut contenir jusqu'à 6 téléphones portables
- Matériau : ABS, PP, métal

PRISIÓN PARA MÓVILES

- Con temporizador de hasta 60 minutos con ajuste manual
- Caben hasta 6 móviles
- Material: ABS, PP, metal

GEFÄNGNIS FÜR HANDYS

- Mit Timer bis 60 Minuten, von Hand einstellbar
- Bietet Platz für bis zu 6 Handys
- Material: ABS, PP, Metall

PACKAGING

cardboard box
L 8 x H 18.5 x W 16.4 cm
SOLD X 4

PHJ0001



8 054117 629915

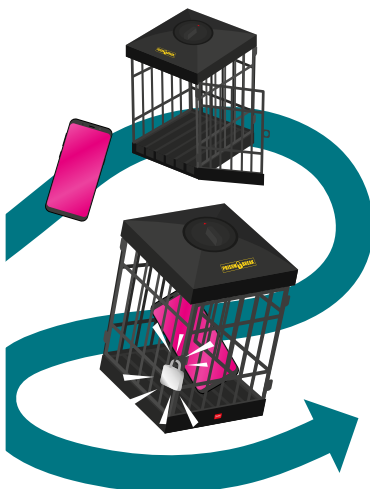

Phones not included



SEX IN PROGRESS

L 2.5 x H 2.5 x W 2.5 cm

SET OF 3 DICE

- Six-sided dice: 6 actions, 6 parts of the body and 6 places
- Material: acrylic, polyester pouch

SET DI 3 DADI

- Dadi a 6 facce: 6 azioni, 6 parti del corpo e 6 luoghi
- Materiale: acrilico, busta in poliestere

SET DE 2 DÉs

- Dés à 6 faces : 6 actions, 6 parties du corps et 6 lieux
- Matériau : acrylique, pochette en polyester

SET DE 3 DADOS

- Dados con 6 caras: 6 acciones, 6 partes del cuerpo y 6 lugares
- Material: acrílico, bolsa de poliéster

SET MIT 3 WÜRFELN

- Würfeln mit je 6 Seiten: 6 Aktionen, 6 Körperteile, 6 Orte
- Material: Acryl, Beutel aus Polyester

PACKAGING

carded
L 11 x H 23 x W 3 cm
SOLD X 4

SPICY

DND0002



Pouch to store dice included

DATE IN PROGRESS

L 2.3 x H 2.3 x W 2.3 cm

SET OF 3 DICE

- Six-sided dice: 6 different cuisines, 6 movie genres and 6 activities for couples
- Material: acrylic, polyester pouch

SET DI 3 DADI

- Dadi a 6 facce: 6 diverse cucine, 6 generi cinematografici e 6 attività di coppia
- Materiale: acrilico, busta in poliestere

SET DE 3 DÉs

- Dés à 6 faces : 6 cuisines différentes, 6 genres cinématographiques et 6 activités de couple
- Matériau : acrylique, pochette en polyester

SET DE 3 DADOS

- Dados con 6 caras: 6 platos diferentes, 6 géneros cinematográficos y 6 actividades en pareja
- Material: acrílico, bolsa de poliéster

SET MIT 3 WÜRFELN

- Würfeln mit je 6 Seiten: 6 verschiedene Speisen, 6 Filmgenres und 6 Aktivitäten zu zweit
- Material: Acryl, Tasche aus Polyester

PACKAGING

carded
L 10 x H 22 x W 3 cm
SOLD X 4

DATE

DND0001



Pouch to store dice included

SPIN THE WHEEL

L 8.2 x H 10.4 x W 4 cm

ANSWER WHEEL

- 10 possible answers
- Material: ABS

RUOTA DELLE RISPOSTE

- 10 possibili risposte
- Materiale: ABS

ROUE DES RÉPONSES

- 10 réponses possibles
- Matériau : ABS

RULETA DE LAS RESPUESTAS

- 10 respuestas posibles
- Material: ABS

DAS ANTWORT-RAD

- 10 mögliche Antworten
- Material: ABS



PACKAGING

cardboard box
L 8.6 x H 12.5 x W 5 cm

SOLD X 4

OFFICE

MAW0001



8 052694 001513



1. Ask your question

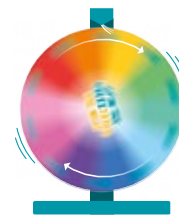

2. Spin the wheel



3. Here's your answer!



PACKAGING

cardboard box
L 8.6 x H 12.5 x W 5 cm

SOLD X 4

SPICY

MAW0002



8 052694 005115



1. Looking to spice up your partner's night?



2. Just spin the wheel! Wait for it...



3. Enjoy your evening!



SPIN THE BOTTLE

Ø 12 x H 18 cm

SPIN THE BOTTLE

- 8 different challenges
- Material: plastic

GIOCO DELLA BOTTIGLIA

- 8 diverse sfide
- Materiale: plastica

JEU DE LA BOUTEILLE

- 8 défis différents
- Matériau : plastique

JUEGO DE LA BOTELLA

- 8 retos diferentes
- Material: plástico

FLASCHENDREHEN

- 8 unterschiedliche Herausforderungen
- Material: Kunststoff



PACKAGING

cardboard box
L 18 x H 12,5 x W 6 cm
SOLD X 4

SPB0001



DECISION MAKER

L 14.5 x H 21.5 x W 10 cm

MAGNETIC PENDULUM

- With 6 possible answers
- Material: plastic, metal, magnetic base

PENDOLO MAGNETICO

- Con 6 possibili risposte
- Materiale: plastica, metallo, base magnetica

PENDULE MAGNÉTIQUE

- Avec 6 réponses possibles
- Matériau : plastique, métal, base magnétique

PÉNDULO MAGNÉTICO

- Con 6 respuestas posibles
- Material: plástico, metal, base magnética

MAGNETISCHES PENDEL

- Mit 6 möglichen Antworten
- Material: Kunststoff, Metall, Magnetbasis

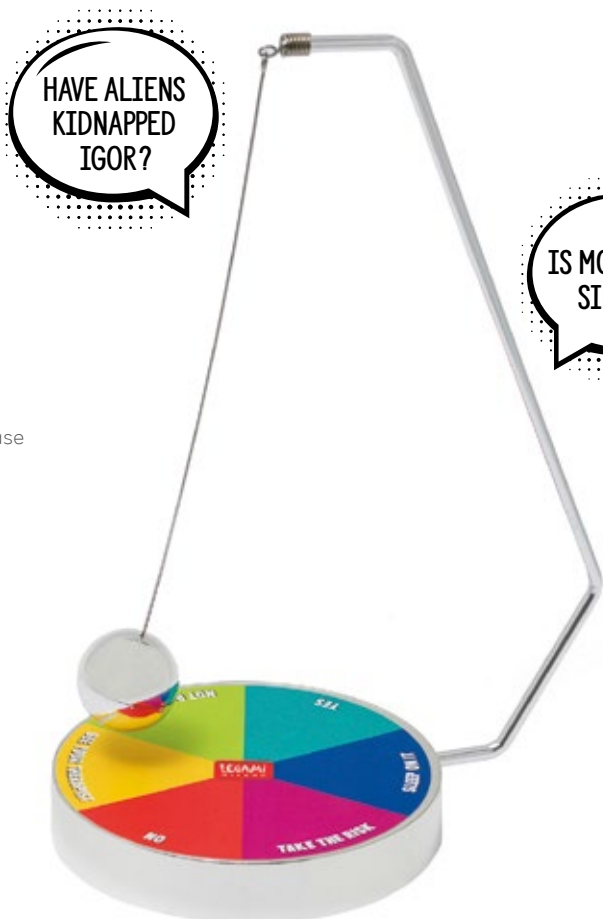

PACKAGING

cardboard box
L 11.8 x H 20.4 x W 3 cm



DISPLAY

material: cardboard
L 24 x H 27.5 x W 21.5 cm
10 PCS

DMKIT2



SOUND MACHINE

L 6 x H 10 x W 2 cm

SOUND MACHINE WITH FUN SOUND EFFECTS
 • 20 sound effects
 • Material: ABS, silicone

GIOCO CON EFFETTI SONORI DIVERTENTI
 • 20 effetti sonori
 • Materiale: ABS, silicone

MACHINE AUX AMUSANTS EFFETS SONORES
 • 20 effets sonores
 • Matériau : ABS, silicone

MÁQUINA CON DIVERTIDOS EFECTOS SONOROS
 • 20 efectos sonoros
 • Material: ABS, silicona



3 x LR44 batteries (included, for the use of the "try me" function)

GERÄUSCH-GENERATOR MIT LUSTIGEN GERÄUSCHEN
 • 20 Geräusche
 • Material: ABS, Silikon

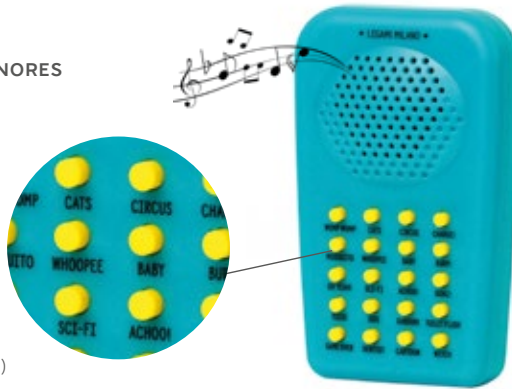

PACKAGING
 carded
 L 11.5 x H 18 x W 2 cm
SOLD X 4



MULTI VOICE CHANGER

L 7 x H 7 x W 4.5 cm

MINI VOICE CHANGER MEGAPHONE
 • 4 different sound effects
 • Material: plastic

MINI MEGAFONO CAMBIA VOCE
 • 4 effetti sonori diversi
 • Materiale: plastica

MINI MÉGAPHONE MODIFICATEUR DE VOIX
 • 4 effets sonores différents
 • Matériau : plastique

MINIMEGÁFONO CAMBIADOR DE VOZ
 • 4 efectos sonoros diferentes
 • Material: plástico

MINI-MEGAFON MIT STIMMVERZERRER
 • 4 verschiedene Geräusche
 • Material: Kunststoff

 1 x 23A battery (included for the use of the "try me" function)



PACKAGING
 carded
 L 11.5 x H 15 x W 4.6 cm
SOLD X 6



YES & NO

Ø 8.8 cm, H 3.5 cm

SET OF TWO SOUND BUTTONS
 • 10 different sound variations for each button
 • Material: ABS

SET DE DOS BOTONES SONOROS
 • 10 variedades sonoras para cada botón
 • Material: ABS

SET DI DUE PULSANTI SONORI
 • 10 diverse varianti sonore per ogni pulsante
 • Materiale: ABS

SET MIT ZWEI BUZZERN
 • 10 verschiedene Töne für jeden Buzzer
 • Material: ABS

SET DE DEUX BOUTONS SONORES
 • 10 variantes sonores différentes pour chaque bouton
 • Matériau : ABS

 2 x AAA batteries (included)

PACKAGING
 cardboard box
 L 19 x H 9.5 x W 4.7 cm
SOLD X 4



SCREAM AND SHOUT

L 21 x H 17 x Ø 14 cm

MEGAPHONE

- Dual function: voice and siren
- Adjustable volume
- Folding handle. Practical strap
- Material: megaphone made of ABS, polyester strap

MEGAFONO

- Doppia funzione: voce e sirena
- Volume regolabile
- Manico pieghevole. Pratico laccio
- Materiale: megafono in ABS, laccio in poliester

MÉGAPHONE

- Double fonction : voix et sirène
- Volume réglable
- Poignée pliable. Lanière pratique
- Matériau : mégaphone en ABS, lanière en polyester



MEGÁFONO

- Doble función: voz y sirena
- Volumen ajustable
- Mango plegable. Práctica correa
- Material: megáfono de ABS, correa de poliéster

MEGAFON

- Doppelfunktion: Stimme und Sirene
- Lautstärke verstellbar
- Klappbarer Handgriff. Praktischer Gurt
- Material: Megafon aus ABS, Haltegurt aus Polyester

PACKAGING

cardboard box
L 21.5 x H 13.5 x W 13.5 cm
SOLD X 4



DUAL FUNCTION

1. VOICE

2. SIREN



RING FOR...

Ø 7.5 cm, H 14 cm

HAND BELL

- Ergonomic handle
- Shiny finish
- Material: iron, ABS

CAMPANELLA

- Impugnatura ergonomica
- Finitura lucida
- Materiale: ferro, ABS

CLOCHETTE

- Manche ergonomique
- Finition brillante
- Matériau : fer, ABS

CAMPANILLA

- Mango ergonómico
- Acabado brillante
- Material: hierro, ABS

HANDGLÖCKCHEN

- Ergonomischer Griff
- Hochglanz-Oberfläche
- Material: Eisen, ABS

PACKAGING

window box
L 7.7 x H 14 x W 7.7 cm
SOLD X 4



KISS
BELO001



BEER
BELO002



SPICY
BELO003



DO NOT DISTURB

Ø 10 cm, L 10 cm

SUDOKU TOILET ROLL**CARTA IGIENICA SUDOKU****PAPIER TOILETTE SUDOKU****PAPEL HIGIÉNICO CON SUDOKU****SUDOKU-TOILETTENPAPIER****PACKAGING**

cardboard box

L 11 x H 11 x W 11 cm

SOLD X 4**SUDOKU**

TR0001

**MAGIC SHOT**

L 22,8 x H 27,5 x W 18,5 cm (opened)

Hoop diameter: 14 cm

BASKETBALL HOOP FOR WASTE BIN WITH SOUND EFFECT

- Turn your waste bin into a mini basketball hoop
- The basketball hoop reproduces the sound effect of a cheering crowd after each shot
- Material: ABS, PP

CANESTRO SONORO PER CESTINO

- Trasforma il cestino in un piccolo canestro
- Il canestro riproduce l'effetto sonoro della folla che acclama dopo ogni centro
- Materiale: ABS, PP

PANIER SONORE POUR CORBEILLE

- Transformez la corbeille en un petit panier
- Le panier reproduit l'effet sonore de la foule qui acclame après chaque tir réussi
- Matériau : ABS, PP

CANASTA SONORA PARA PAPELERA

- Transforma la papelera en una pequeña canasta
- La canasta reproduce el sonido de la multitud que vitorea después de haber encestado
- Material: ABS, PP

BASKETBALLKORB MIT GERÄUSCH FÜR DEN MÜLLEIMER

- Verwandeln Sie Ihren Mülleimer in einen Basketballkorb
- Der Basketballkorb gibt das Geräusch eines Beifall spendenden Publikums nach jedem Treffer wieder
- Material: ABS, PP

PACKAGING

cardboard box

L 20 x H 24 x

W 6,5 cm

SOLD X 4

BKH0001

2 x AA batteries
(not included)Back clip: easily attaches
to any waste bin with a flat edge

DO NOT DISTURB

Ø 10 cm, L 10 cm

PUZZLE TOILET PAPER

CARTA IGIENICA ENIGMISTICA

PAPIER TOILETTE À ÉNIGMES

PAPEL HIGIÉNICO CON PASATIEMPOS

RÄTSEL-TOILETTPAPIER



PACKAGING

cardboard box
L 11 x H 11 x W 11 cm**SOLD X 4**PUZZLE
TR0003

8 052694 001520

**KNOCKOUT**

L 18 x H 35 x W 18 cm

TABLETOP PUNCHING BALL

- Suction cup base
- Air pump included
- Material: iron, PU

PUNGIBALL DA TAVOLO

- Base a ventosa
- Pompetta ad aria inclusa
- Materiale: ferro, PU

PUNCHING-BALL DE TABLE

- Socle à ventouse
- Petite pompe à air incluse
- Matériau : fer, PU

PUNCHING BALL DE MESA

- Base con ventosa
- Bomba de aire incluida
- Material: hierro, PU

TISCH-BOXBIRNE

- Basis mit Saugnapf
- Inklusive Luftpumpe
- Material: Eisen, PU

PACKAGING

cardboard box
L 21 x H 19.5 x W 10.7 cm**SOLD X 4**

MIPB0001



8 052461 964638

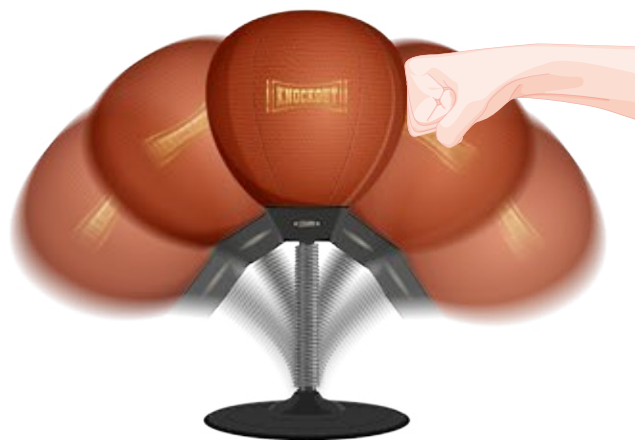



ON THE **GO**
Your tastes in anyplace

Always carry what you enjoy tasting, easily and with style

HOT & COLD - VACUUM TUMBLER

Ø 9 cm, L 11.5 cm

VACUUM TUMBLER

- Light and sturdy
- Hermetic seal
- Easy to open and close lid
- Material: double-layer stainless steel, plastic

BICCHIERE TERMICO

- Leggero e resistente
- Chiusura ermetica
- Tappo con comodo sistema apri e chiudi
- Materiale: acciaio inox a doppio strato, plastica

VERRE ISOTHERME

- Légèr et résistant
- Fermeture hermétique
- Couvercle avec système d'ouverture facile
- Matériau : acier inox à double paroi, plastique

VASO TERMO

- Ligero y resistente
- Cierre hermético
- Tapa con cómodo sistema de apertura y cierre
- Material: acero inoxidable de doble capa, plástico

THERMOBECHER

- Leicht und robust
- Hermetisch dichter Verschluss
- Deckel mit praktischem System zum Öffnen und Schließen
- Material: zweischichtiger Edelstahl, Kunststoff



PARTS IN CONTACT WITH FOOD ARE BPA AND PHTHALATE FREE



PACKAGING

window box
L 9 x H 12.4 x W 9.2 cm

SOLD X 2

325 ml



TRAVEL
TUM0001



STARS
TUM0002



BUTTERFLY
TUM0003



FLAMINGO
TUM0004



HUMMINGBIRD
TUM0005



HANGOVER
TUM0006



POP MATERIAL

WINDOW DISPLAY
L 48 x H 53 cm

Order 2 pcs of each design and you will receive a window display

TUM-GROUP



HOT & COLD - VACUUM BOTTLE

VACUUM BOTTLE

- Light and resistant
- Hermetic seal
- Material: double-layer stainless steel, removable silicone handle

BOTTIGLIA TERMICA

- Leggera e resistente
- Chiusura ermetica
- Materiale: acciaio inox a doppio strato, manico in silicone removibile

GOURDE THERMIQUE

- Légère et résistante
- Fermeture hermétique
- Matériau : acier inox à double paroi, poignée en silicone amovible

BOTELLA TÉRMICA

- Liger y resistente
- Cierre hermético
- Material: acero inoxidable de doble capa, asa de silicona extraíble

THERMOSFLASCHE

- Leicht und robust
- Hermetisch dichter Verschluss
- Material: zweischichtiger Edelstahl, abnehmbarer Silikongriff





PARTS IN CONTACT WITH FOOD ARE BPA AND PHTHALATE FREE



800 ml

Ø 8 cm, H 29.2 cm



BLACK
SSBL0002



TRAVEL
SSBL0003



STARS
SSBL0004



FLORA
SSBL0005



BUTTERFLY
SSBL0006



AFTER RAIN
SSBL0007



PACKAGING
window box
L 8 x H 29.6 x W 8 cm
SOLD X 2



HOT & COLD BOTTLE
800 ML RANGE
2 PCS X DESIGN
SSB-GROUP



Ø 7 cm, H 24.5 cm



TRAVEL
SSB0005



8 059174 832490



BLACK
SSB0010



8 054320 563808



GOLD FOIL

STARS
SSB0011



8 054320 563815



SILVER FOIL

FLORA
SSB0012



8 054320 563822



BUTTERFLY
SSB0014



8 054117 628369



FLAMINGO
SSB0015



8 054117 628376



SILVER FOIL

HUMMINGBIRD
SSB0016



8 054117 628383



HANGOVER
SSB0017



8 054117 628390



CLOUD
SSB0018



8 054117 628406



AFTER RAIN
SSB0019



8 053610 784350

PACKAGING
window box
L 7.5 x H 25.7 x 7.5 cm
SOLD X 2

HOT & COLD BOTTLE
500 ML RANGE
2 PCS X DESIGN
BOTTLE-GROUP



8 054320 564980



FOR LEGAMI'S 500 ML
HOT & COLD BOTTLE
ONLY

SPORT LID

Lid: Ø 4 cm, L 7.8 x H 4.5 (closed)
Straw: Ø 0.6, H 21.5 cm

STRAW LID

- Suitable for the 500 ml Hot & Cold Vacuum bottle
- Hermetic seal
- 2 straws included
- Material: plastic

TAPPO CON BECCUCCIO

- Adatto per l'utilizzo sulla bottiglia termica Hot & Cold da 500 ml
- Chiusura ermetica
- 2 cannucce incluse
- Materiale: plastico

BOUCHON POUR GOURDE

- Compatible avec la gourde thermique Hot & Cold de 500 ml
- Fermeture hermétique
- 2 pailles incluses
- Matériau : plastique

TAPÓN CON BOQUILLA

- Apto para el uso con la botella térmica Hot & Cold de 500 ml
- Cierre hermético
- 2 pajitas incluidas
- Material: plástico

VERSCHLUSS MIT TRINKÖFFNUNG

- Für die Hot & Cold Thermosflasche mit einem Fassungsvermögen von 500 ml geeignet
- Hermetisch dichter Verschluss
- 2 Trinkhalme enthalten
- Material: Kunststoff



PACKAGING

carded
L 10 x H 22 x W 4.5 cm
SOLD X 4

LID0001



Ideal for sports

Anti-drip

2 straws included

Flip-open

Hermetic seal

**FULL ASSORTED DISPLAY*
MOQ 36 PCS**

DISBOTM-SSB-GROUP



**BOTTLE RANGE +
SPORT LID + FLOOR DISPLAY BOTTLES
500 ML / 800 ML + POP MATERIAL**



POP MATERIAL

WINDOW DISPLAY

L 24.1 x H 68 cm

Order the full assorted display

40 PCS X SIZE 500 ML

16 PCS X SIZE 800 ML

12 PCS X SPORT LID

You will receive a window display.

DISBOTM2-SSB-GROUP



*Legami's 500 ml Hot & cold bottle only

**HOT & COLD - BOTTLE RANGE
500 ML / 800 ML + TUMBLER RANGE + SPORT
LID + FLOOR DISPLAY + POP MATERIAL**



POP MATERIAL

WINDOW DISPLAY

A. L 24.1 x H 68 cm

B. L 48 x H 53 cm

Order the full assorted display

28 PCS X SIZE 500 ML

16 PCS X SIZE 800 ML

14 PCS X TUMBLERS

12 PCS X SPORT LID

You will receive two window displays.

DISBOTM2-SSBTUM-GROUP



LUNCH BAG

L 38 x H 24 x W 16 cm (without handles)

LUNCH BAG

- Durable, insulated and washable
- Roomy: 2 compartments with zip closure + 1 front pocket
- Material: polyester exterior, PEVA interior, foam batting

BORSA PORTA PRANZO

- Resistente, termoisolante e lavabile
- Capiente: 2 scomparti con chiusura con cerniera + 1 tasca frontale
- Materiale: esterno in poliester, interno in PEVA, imbottitura in spugna

SAC À REPAS

- Résistant, isotherme et lavable
- Grand format : 2 compartiments avec fermeture éclair + 1 poche avant
- Matériau : extérieur en polyester, intérieur en PEVA, rembourrage en éponge

BOLSA PARA EL ALMUERZO

- Resistente, termoaislante y lavable
- Espaciosa: 2 compartimentos con cierre de cremallera + 1 bolsillo frontal
- Material: exterior de poliéster, interior de PEVA, relleno de espuma

LUNCH-TASCHE

- Strapazierfähig, wärmeisolierend und waschbar
- Viel Stauraum: 2 Fächer mit Reißverschluss + 1 Fronttasche
- Material: außen Polyester, innen PEVA, Schaumstoff-Polsterung



Bottom compartment



TRAVEL
LLBAG0001



8 054117 621704



FLORA
LLBAG0002



8 054117 621711



LUNCH BAG

L 21 x H 19 x W 14.5 cm (without handles)

LUNCH BAG

- Durable, heat-insulating and spacious
- Removable and adjustable shoulder strap
- Material: polyester exterior, EVA interior, foam padding

BORSA PORTA PRANZO

- Resistente, termoisolante e capiente
- Tracolla rimovibile e regolabile
- Materiale: esterno in poliester, interno in EVA, imbottitura in spugna

SAC À REPAS

- Résistant, isotherme et de grande capacité
- Bandoulière amovible et réglable
- Matériau : extérieur en polyester, intérieur en EVA, rembourrage en mousse

BOLSA PARA EL ALMUERZO

- Resistente, con aislamiento térmico y con gran capacidad
- Bandolera removible y regulable
- Material: exterior en poliéster, interior en EVA, acolchado en espuma

LUNCH-TASCHE

- Robust, wärmeisoliert und groß
- Abnehmbarer und verstellbarer Trageriemen
- Material: außen aus Polyester, innen aus EVA, Innenfutter aus Frottee

PACKAGING

cardboard belly band
L 21 x H 25 x W 5 cm

SOLD X 2



TRAVEL
LBAG0001



Shoulder strap:
MIN 70 cm
MAX 130 cm



FLORA
LBAG0004



FOOD

FOOD STORAGE

LUNCH BOX

L 18 x H 10 x W 10 cm

LUNCH BOX

- Durable material
- Material: PS, PE, PP, polyester

CONTENITORE PORTA PRANZO

- Materiale durevole
- Materiale: PS, PE, PP, poliester

BOÎTE REPAS

- Matériau durable
- Matériau : PS, PE, PP, polyester

FIAMBRERA

- Material duradero
- Material: PS, PE, PP, poliéster

LUNCHBOX

- Langlebiges Material
- Material: PS, PE, PP, Polyester

PACKAGING

cardboard box
L 20 x H 11 x W 11 cm

SOLD X 2



Without lid and trays

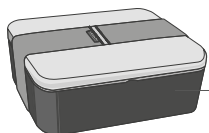

Can also be used with only one container



Cutlery included

Two separate levels



TRAVEL
LUB0001



FLORA
LUB0004



SNACK BAGS



SET OF 3 REUSABLE SNACK BAGS

- Zip seal. Expandable bottom
- Material: PE, OPP, PET

SET DI 3 BUSTE RIUTILIZZABILI PORTA SNACK

- Chiusura a pressione. Fondo estensibile
- Materiale: PE, OPP, PET

SET DE 3 POCHETTES À GOÛTER RÉUTILISABLES

- Fermeture à pression. Fond extensible
- Matériau : PE, OPP, PET

SET DE 3 BOLSAS REUTILIZABLES PARA APERITIVOS

- Cierre a presión. Fondo extensible
- Material: PE, OPP, PET

3ER-SET WIEDERVERWENDBARE BEUTEL FÜR SNACKS

- Druckverschluss. Erweiterbarer Boden
- Material: PE, OPP, PET

PACKAGING

cardboard envelope
L 23.7 x H 22 x W 0.5 cm
SOLD X 6



REUSABLE



DISHWASHER SAFE



FREEZER SAFE



FOOD SAFE MATERIAL

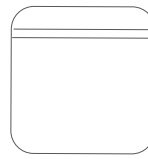

SMALL
L 15.8 x H 16 cm

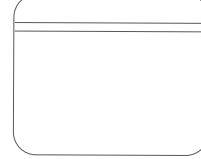

MEDIUM
L 21.5 x H 18 cm

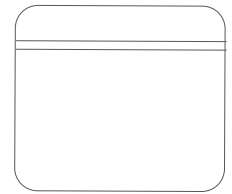

LARGE
L 23 x H 21 cm



UNICORN

ZB0001



8 053610 783711



SPACE

ZB0002



8 053610 783728



COOKIE

ZB0003



8 053610 783735



PANDA

ZB0004



8 053610 783742



GEL PACK FOR FOOD

GEL PACK FOR FOOD

- Dual use: keeps food hot or cold
- Reusable
- Material: PVC

GEL PACK PER ALIMENTI

- Doppio utilizzo: tiene in fresco o in caldo gli alimenti
- Riutilizzabile
- Materiale: PVC

POCHE DE GEL À USAGE ALIMENTAIRE

- Double utilisation : garde au chaud ou au froid les aliments
- Réutilisable
- Matériau : PVC

GEL TÉRMICO PARA ALIMENTOS

- Doble uso: mantiene los alimentos fríos o calientes
- Reutilizable
- Material: PVC

GELPACK FÜR LEBENSMITTEL

- Doppelte Funktion: Hält deine Lebensmittel kalt oder warm
- Wiederverwendbar
- Material: PVC



PACKAGING

window box
L 11.5 x H 15.5 x W 1.5 cm
SOLD X 6

PENGUIN

HCPO001



L 11 x H 12 x W 1 cm



PACKAGING

window box
L 12.5 x H 13.5 x W 1.5 cm
SOLD X 6

RAINBOW

HCPO002



L 12 x H 11 x W 1 cm



PACKAGING

window box
L 11.5 x H 15.5 x W 1.5 cm
SOLD X 6

AVOCADO

HCPO003



L 10.5 x H 13 x W 1 cm





PARTNERS IN **STYLE**
Express Yourself

Embrace the wow factor to enhance your style

TOTE BAG

L 38.5 x 42 cm (without handles)

COTTON BAG

- Material: 100% cotton

SAC EN COTON

- Matériau : 100 % coton

BAUMWOLLTASCHE

- Material: 100 % Baumwolle



BORSA DI COTONE

- Materiale: 100% cotone

BOLSA DE ALGODÓN

- Material: 100 % algodón

SOLD X 3

TOTE BAGS DISPLAY

Floor empty display on demand: MOQ 60 pcs
material: metal
Ø 31.5 cm, H 187.5 cm

DISTOTE



AFTER RAIN
CBAG0001



AIR BALLOON
CBAG0002



DAISY
CBAG0003



WHALE
CBAG0004



SUNFLOWER
CBAG0005



BOOKLOVER
CBAG0006



STARS
CBAG0007



NEW
HOLO PRINT

COTTON MESH BAG

L 41 x H 65 cm (handles included)

COTTON MESH BAG

- Durable, practical
- Material: 100% cotton

BORSA A RETE IN COTONE

- Resistente, pratica
- Materiale: 100% cotone

SAC EN MAILLE EN COTON

- Résistant, pratique
- Matériau : 100 % coton

BOLSA DE RED EN ALGODÓN

- Resistente, práctica
- Material: 100 % algodón

EINKAUFSNETZ AUS BAUMWOLLE

- Robust, praktisch
- Material: 100 % Baumwolle



PACKAGING

cardboard belly band
L 15 x H 12 x W 5 cm

SOLD X 3



MAB0001 BEIGE



8 051739 307603



MAB0002 BLUE



8 051739 307610



MAB0004 GREEN



8 054117 621353



WHAT A PURSE!

L 10 x H 8.5 x 2 cm

COIN PURSE

- Practical metal zip closure
- Material: PU, polyester

PORTAMONETE

- Pratica chiusura con cerniera in metallo
- Materiale: PU, poliester

PORTE-MONNAIE

- Fermeture éclair pratique en métal
- Matériau : PU, polyester

MONEDERO

- Cierre práctico con cremallera de metal
- Material: PU, poliéster

MÜNZTASCHE

- Praktischer Reißverschluss aus Metall
- Material: PU, Polyester

SOLD X 4



HEART
HPU0001



WHAT A WALLET!

L 20 x H 10 x W 3 cm (closed)

WALLET

- Practical and safe zip closure
- External metal zip, internal plastic zip
- Material: 50% PU, 40% cotton, 10% polyester

PORTAFOGLIO

- Chiusura a cerniera pratica e sicura
- Cerniera esterna in metallo, cerniera interna in plastica
- Materiale: 50% PU, 40% cotone, 10% poliester

PORTEFEUILLE

- Fermeture éclair pratique et sûre
- Fermeture éclair extérieure en métal, fermeture éclair interne en plastique

* While stock lasts

SOLD X 2

- Matériau : 50 % PU, 40 % coton, 10 % polyester

CARTERA

- Cierre de cremallera práctico y seguro
- Cremallera externa de metal, cremallera interna de plástico
- Material: 50 % PU, 40 % algodón, 10 % poliéster

GELDBÖRSE

- Mit praktischem und sicherem Reißverschluss
- Reißverschluss außen aus Metall, Reißverschluss innen aus Kunststoff
- Material: 50 % PU, 40 % Baumwolle, 10 % Polyester

PACKAGING

view-top box
w/ cardboard base
L 20 x H 14 x W 4 cm



3

COMPARTMENTS

12

CARD SLOTS

1

ZIPPED POCKET FOR COINS



TRAVEL
WALL0001



STARS
WALL0006





HOLO PRINT

FLORA
WALL0007 *
8 054320 569893



FLASH
WALL0008 *
8 054320 569909



HEART
WALL0009 *
8 054117 620905



BLACK FOIL

DAISY
WALL0012 *
8 053610 785203



GOLD FOIL

CHERRY
WALL0013 *
8 053610 785210

**WHAT A CARD HOLDER!**

L 12.5 x H 8.3 x W 1 cm

CARD HOLDER

- 4 slots
- 1 pocket with metal zip
- RFID blocking: protects against data theft
- Material: exterior 100% PU, interior 100% polyester

PORTA CARTE

- 4 tasche
- 1 tasca con cerniera in metallo
- Protezione RFID: protegge dal furto dei dati
- Materiale: esterno 100% PU, interno 100% poliestere

SOLD X 4**PORTE-CARTES**

- 4 étuis
- 1 poche à fermeture éclair en métal
- Protection RFID : protège du vol de données
- Matériau : extérieur 100 % PU, intérieur 100 % polyester

TARJETERO

- 4 bolsillos
- 1 bolsillo con cremallera de metal
- Protección RFID: protege del robo de datos
- Material: exterior 100 % PU, interior 100 % poliéster

KARTENTASCHE

- 4 Fächer
- 1 Fach mit Metallreißverschluss
- RFID-Schutz: schützt vor Datendiebstahl
- Material: außen 100 % PU, innen 100 % Polyester

4

CARD SLOTS

1

ZIPPED POCKET FOR COINS**TRAVEL**

CAD0001



8 052694 002985

**STARS**

CAD0002



8 052694 002992

NICE TO MEET YOU

L 10.2 x H 6.5 x W 1.4 cm

CARD HOLDER

- Material: metal coated in PU with magnetic closure, soft velvet lining

PORTA CARTE

- Materiale: metallo rivestito in PU con chiusura magnetica, interno in morbido velluto

PORTE-CARTES

- Matériau : métal avec revêtement en PU et fermeture magnétique, intérieur en velours doux

TARJETERO

- Material: metal revestido en PU con cierre magnético, interior de terciopelo suave

VISITENKARTENTASCHE

- Material: Metall mit PU-Beschichtung und Magnetverschluss, innen aus weichem Samt

**DISPLAY**material: cardboard
L 16 x H 18 x W 15 cm**12 PCS****TRAVEL**

MCHMKIT15



8 052694 000950



BADGE HOLDER

L 10.4 x H 9 cm

BADGE HOLDER

- Dimensions for inserting badge or business cards: 9.5 x 6.5 cm
- Cord with snap hook and safety clip clasp
- Material: PU with polyester internal lining

PORTA BADGE

- Dimensioni utili del badge o dei biglietti da visita inseribili: 9,5 x 6,5 cm
- Cordino con moschettone e chiusura con clip di sicurezza
- Materiale: PU con fodera interna in poliester

PORTE-BADGE

- Dimensions du badge ou de la carte de visite insérables : 9,5 x 6,5 cm
- Cordon avec mousqueton et fermeture avec clip de sécurité
- Matériau : PU avec doublure intérieure en polyester

PORTA TARJETA DE IDENTIFICACIÓN

- Dimensiones de la tarjeta identificativa o tarjeta de visita: 9,5 x 6,5 cm
- Cordón con mosquetón y cierre con clip de seguridad
- Material: PU con forro interno de poliéster

NAMENSCHILDHALTER

- Maße des einzusteckenden Namensschildes oder der Visitenkarte: 9,5 x 6,5 cm
- Band mit Karabinerhaken und Sicherheits- Clipverschluss
- Material: PU mit Innenfutter aus Polyester

PACKAGING

carded
L 12 x H 19.5 cm
SOLD X 3



BADGE HOLDER DISPLAY

Counter empty display on demand: MOQ 18 pcs
material: cardboard
L 13.5 x H 24.5 x W 23.5 cm

DISBH

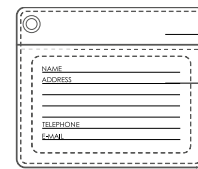
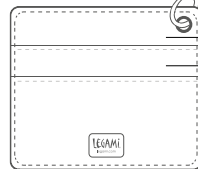
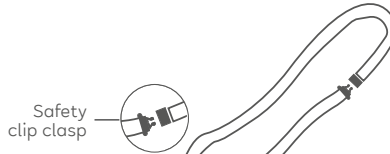

BH0029 PETROL BLUE
8 059174 835736



BH0030 TRAVEL
8 053610 785227



BH0031 STARS
8 052694 002312



BH0032 DAISY
8 052694 002329



BH0033 FLOWERS
8 052694 004071

POUCH

L 21.5 x H 14 cm

POUCH

- Practical zip closure. Fabric loop
- Material: 100% cotton exterior, 100% polyester interior

POCHETTE

- Pratica chiusura con cerniera. Cinturino in tessuto
- Materiale: esterno 100% cotone, interno 100% poliestere

POCHETTE

- Fermeture éclair pratique. Lanière en tissu
- Matériau : extérieur 100 % coton, intérieur 100 % polyester

BOLSO DE MANO

- Cierre práctico con cremallera. Correa de tela
- Material: exterior 100 % algodón, interior 100 % poliéster

POCHETTE

- Praktischer Reißverschluss. Tragegurt aus Textil
- Material: außen 100 % Baumwolle, innen 100 % Polyester

SOLD X 4



TRAVEL
COZ0001



8 054117 621780



STARS
COZ0002



8 054117 621797



FLOWERS
COZ0003



8 054117 621803



ELEPHANT
COZ0004



8 054117 621810



DAISY
COZ0005



8 054117 621827



PANDA
COZ0006



8 054117 621834

COIN PURSE

L 12 x H 9 cm x W 3 cm

COIN PURSE

- Practical zip closure
- Material: 100% cotton exterior, 100% polyester interior

PORTAMONETE

- Pratica chiusura con cerniera
- Materiale: esterno 100% cotone, interno 100% poliestere

PORTE-MONNAIE

- Fermeture éclair pratique
- Matériau : extérieur 100 % coton, intérieur 100 % polyester

MONEDERO

- Cierre práctico con cremallera
- Material: exterior 100 % algodón, interior 100 % poliéster

MÜNZTASCHE

- Praktischer Reißverschluss
- Material: außen 100 % Baumwolle, innen 100 % Polyester

SOLD X 4



TRAVEL
COC0001



STARS
COC0002



FLOWERS
COC0003



ELEPHANT
COC0004



PANDA
COC0006



POUCH AND COIN PURSE DISPLAY

Counter empty display on demand: MOQ 68 pcs material: metal L 23 x H 51 x W 33.5 cm

DISFUN



SEE YOU SOON

L 16.2 x H 6.8 x W 1.4 cm (closed)

FOLDABLE GLASSES CASE

- Magnetic closure
- Material: PU exterior, soft velvet lining

CUSTODIA PORTAOCCHIALI PIEGHEVOLE

- Chiusura magnetica
- Materiale: esterno in PU, interno in morbido velluto

ÉTUI À LUNETTES PLIANT

- Fermeture magnétique
- Matériau : extérieur en PU, intérieur en velours doux

SOLD X 3

FUNDA PARA GAFAS PLEGABLE

- Cierre magnético
- Material: exterior de PU, interior de terciopelo suave

FALTBARES BRILLENETUI

- Magnetverschluss
- Material: außen aus PU, innen aus weichem Samt

SEE YOU SOON DISPLAY

Counter empty display on demand: MOQ 15 pcs
material: cardboard
L 26 x H 22.5 x W 12 cm

DISFGC



TRAVEL
FGC0005



STARS
FGC0014



HEART
FGC0016



DAISY
FGC0017



CHERRY
FGC0018



SECRETS BOX - MEDIUM

L 16.5 x H 3.5 x W 6 cm

GLASSES AND PEN CASE

- Material: metal coated in PU with spring closure

ASTUCCIO PORTA OCCHIALI E PENNE

- Materiale: metallo rivestito in PU con chiusura a molla

ÉTUI À LUNETTES ET STYLOS

- Matériau : métal avec revêtement en PU et fermeture à ressort

SOLD X 2

ESTUCHE PARA GAFAS Y BOLÍGRAFOS

- Material: metal revestido en PU con cierre de muelle

ETUI FÜR BRILLE UND STIFTE

- Material: Metall mit PU-Beschichtung und Federverschluss

SECRETS BOX MEDIUM DISPLAY

Counter empty display on demand: MOQ 12 pcs
material: cardboard
L 27.5 x H 19.5 x W 19 cm

DISMSBM



8 057093 530350



AIR BALLOON
MSBM0060



8 058093 945724



GOLD FOIL

TRAVEL
MSBM0061



8 052783 615867



GOLD FOIL

STARS
MSBM0062



8 052783 615874



HOLD PRINT

AFTER RAIN
MSBM0063



8 053610 785234



BLACK FOIL

DAISY
MSBM0064



8 053610 785241



GOLD FOIL

CHERRY
MSBM0065



8 053610 785258

SECRETS BOX - SMALL

L 9 x H 3 x W 5 cm

MINI CASE

- Material: metal coated in PU with spring closure

MINI ASTUCCIO

- Materiale: metallo rivestito in PU con chiusura a molla

MINI-ÉTUI

- Matériau : métal avec revêtement en PU et fermeture à ressort

* While stock lasts

SOLD X 2**MINI ESTUCHE**

- Material: metal revestido en PU con cierre de muelle

MINI-ETUI

- Material: Metall mit PU-Verkleidung und Federverschluss

SECRETS BOX SMALL DISPLAY

Counter empty display on demand: MOQ 16 pcs
material: cardboard
L 27.5 x H 19 x W 19 cm

DISMSBS



8 051070 279140

**PANDA**

MSBS0078 *



8 055748 243389

**OWL**

MSBS0082



8 058093 945762

**BASEBALL**

MSBS0088 *



8 058093 945823

**AIR BALLOON**

MSBS0089 *



8 058093 945830

**TRAVEL**

MSBS0090 *



8 052783 615881

**NAMASTÉ**

MSBS0093



8 052783 615911

**TROPICAL**

MSBS0094



8 052783 615928

BLING QUEEN

L 13 x H 5.5 x W 9 cm

JEWELLERY BOX

- Mini size
- Zip closure
- Equipped with three compartments
- Material: PU, soft velvet inner lining

PORTAGIOIE

- Formato mini
- Chiusura a zip
- Dotato di tre scomparti
- Materiale: PU, interno foderato in morbido velluto

BOÎTE À BIJOUX

- Format mini
- Fermeture éclair
- Dotée de trois compartiments
- Matériau : PU, doublure intérieure en velours doux

SOLD X 3**JOYERO**

- Formato mini
- Cierre con cremallera
- Dotado de tres compartimentos
- Material: PU, interior forrado de terciopelo suave

SCHMUCKKASTEN

- MiniFormat
- Öffnung mit Reißverschluss
- Mit drei Fächern ausgestattet
- Material: PU, Innenfutter aus weichem Samt

**DIAMONDS**

JEB0001



8 059174 834081

**STARS**

JEB0002



8 059174 834098



ROSE GOLD FOIL



GOLD FOIL

WHAT A KEY RING!

L 7 x H MAX 6 x W MAX 0.2 cm

ENAMEL KEY RING

- With split key ring
- Shiny finish
- Bright colours, strong and long-lasting
- Material: zinc

PORTACHIAVI IN METALLO SMALTATO

- Con anello a spirale
- Finitura lucida
- Colori brillanti, ottima resistenza e durata nel tempo
- Materiale: zinco

PORTE-CLÉS EN MÉTAL ÉMAILLÉ

- Avec anneau en spirale
- Finition brillante
- Couleurs brillantes, excellente résistance et durée dans le temps
- Matériau : zinc

LLAVERO DE METAL ESMALTADO

- Con anillo en espiral
- Acabado brillante
- Colores brillantes, muy resistentes y duraderos en el tiempo
- Material: zinc

SCHLÜSSELANHÄNGER AUS EMAILLIERTEM METALL

- Mit Spiralring
- Hochglanz-Oberfläche
- Brillante Farben, sehr beständig und dauerhaft
- Material: Zink

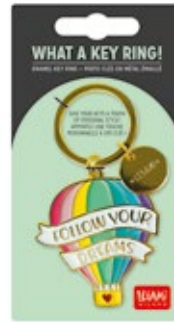

SINGLE KEY RING
PACKAGING
 carded
 L 7 x H 13 x W 0.3 cm
SOLD X 3



SET OF 2 KEY RINGS
PACKAGING
 carded
 L 10 x H 13 x W 0.3 cm
SOLD X 3

SINGLE KEY RINGS



AIR BALLOON
EKR0001



8 053610 781892



HOUSE
EKR0002



8 053610 781908



SCOOTER
EKR0003



8 053610 781915



TRAVEL
EKR0004



8 053610 781922



SUPER MUMMY
EKR0005



8 053610 781939



SUPER DADDY
EKR0006



8 053610 781946



CAR
EKR0009



8 052694 001933



KITTY
EKR0010



8 052694 001940

SET OF 2 KEY RINGS



POO
EKR0007



8 053610 781953



PUZZLE
EKR0008



8 053610 783186



PIZZA
EKR0011



8 052694 005108

MY INITIAL

H 6 cm (without hook)

KEY RING

- With split key ring and carabiner
- Material: PU, metal

PORTACHIAVI

- Con anello a spirale e moschettone
- Materiale: PU, metallo

PORTE-CLÉS

- Avec anneau en spirale et mousqueton
- Matériau : PU, métal

LLAVERO

- Con anillo en espiral y mosquetón
- Material: PU, metal

SCHLÜSSELANHÄNGER

- Mit Spiralling und Karabinerhaken
- Material: PU, Metall

INDIVIDUAL DESIGNS: SOLD X 1

STARTER KIT

50 PCS:

3 PCS: A, E, L, M, S, HEART

2 PCS: B, C, D, F, G, I, N, P, R, T, V

1 PC: H, J, K, O, Q, U, W, X, Y, Z

INKKIT1



8 051128 752564

KEY RING DISPLAY

Counter empty display
on demand: MOQ 36 pcs
material: cardboard
L 27 x H 27 x W 19,5 cm

DISGEN



8 054117 627942



INK0001



8 052783 616635



INK0002



8 052783 616642



INK0003



8 052783 616659



INK0004



8 052783 616666



INK0005



8 052783 616673



INK0006



8 052783 616680



INK0007



8 052783 616697



INK0008



8 052783 616703



INK0009



8 052783 616710



INK0010



8 052783 616727



INK0011



8 052783 616734



INK0012



8 052783 616741



INK0013



8 052783 616758



INK0014



8 052783 616765



INK0015



8 052783 616772



INK0016



8 052783 616789



INK0017



8 052783 616796



INK0018



8 052783 616802



INK0019



8 052783 616819



INK0020



8 052783 616826



INK0021



8 052783 616833



INK0022



8 052783 616840



INK0023



8 052783 616857



INK0024



8 052783 616864



INK0025



8 052783 616871



INK0026



8 052783 616888



INK0027



8 052783 616895

MY KEY RING

L 5 x H 9 x W 0.5 cm

KEY RING

- Carabiner with two split key rings
- Material: TPU, metal

PORTACHIAVI

- Moschettone con due anelli a spirale
- Materiale: TPU, metallo

PORTE-CLÈS

- Mousqueton avec deux anneaux en spirale
- Matériau : TPU, métal

LLAVERO

- Mosquetón con dos anillos en espiral
- Material: TPU, metal

SCHLÜSSELANHÄNGER

- Karabinerhaken mit zwei Spiralringen
- Material: TPU, Metall

PACKAGING

carded
L 7 x H 11.5 x W 0.7 cm



DISPLAY

cardboard
L 7.5 x H 22 x W 20.5 cm
8 PCS

KRKIT1



8 051128 754919



LUCKY CHAIN

H MAX 8 cm (cord included)

KEY RING

- Material: zinc with silicone cord

PORTACHIAVI

- Materiale: zinco con cordino in silicone

PORTE-CLÈS

- Matériau : zinc avec cordon en silicone

LLAVERO

- Material: zinc con cordón en silicona

SCHLÜSSELANHÄNGER

- Material: Zink mit Silikonband

SOLD X 3

KEY RING DISPLAY

Counter empty display
on demand: MOQ 36 pcs
material: cardboard
L 27 x H 27 x W 19.5 cm

DISGEN



8 054117 627942



HOUSE
KEY0004



8 057093 533269



FOUR LEAF
KEY0006



8 057093 533283



CAR
KEY0007



8 057093 533290



BIKE LOVER
KEY0012



8 057093 539674



HEART
KEY0016



8 051764 522699



KITTY
KEY0021



8 055748 243426



FIESTA & SIESTA

L 19.5 x H 2 x W 1.7 cm (closed)

FOLDING PAPER FAN
 • Elastic closure
 • Material: paper

ÉVENTAIL PLIANT EN PAPIER
 • Fermeture avec élastique
 • Matériau : papier

FALTBARER PAPIERFÄCHER
 • Verschluss mit Gummiband
 • Material: Papier

DISPLAY
 material: cardboard
 L 10.6 x H 26.6 x W 14.3 cm
8 PCS

VENTAGLIO IN CARTA PIEGHEVOLE
 • Chiusura con elastico
 • Materiale: carta

ABANICO PLEGABLE DE PAPEL
 • Cierre con elástico
 • Material: papel



FLOWERS
PAPFKIT2

 8 051128 756791



PEACOCK
PAPFKIT3

 8 051128 756807



WATERMELON
PAPWKIT4

 8 051128 756814



RAINBOW
PAPRKIT6

 8 051128 756821



I LOVE MY BAG

L 4 x H 6.5 x W 1 cm

BAG HANGER
 • Non-slip rear side
 • Material: zinc

GANCIO PORTA BORSA
 • Lato posteriore antiscivolo
 • Materiale: zinco

CROCHET PORTE-SAC
 • Côté arrière antidérapant
 • Matériau : zinc

COLGADOR PARA BOLSO
 • Lado posterior antideslizante
 • Material: zinc

HANDTASCHEINTRAGEHAKEN
 • Rutschfeste Rückseite
 • Material: Zink

PACKAGING
 carded
 L 8 x H 13 cm



DISPLAY
 material: cardboard
 L 8.5 x H 22.4 x W 17.7 cm
10 PCS

TRAVEL
HANGKIT1

 8 051128 756418

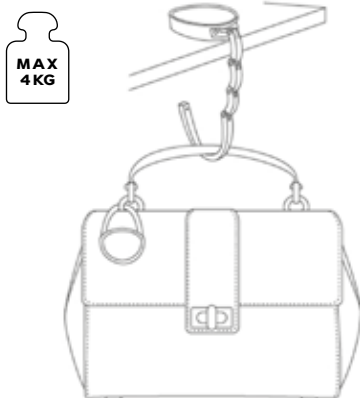

PACKAGING
 carded
 L 8 x H 13 cm



DISPLAY
 material: cardboard
 L 8.5 x H 22.4 x W 17.7 cm
10 PCS

FLOWERS
HANGFKITS

 8 051128 756425



PIN YOUR STYLE!

L MAX 3.3 x H MAX 3 x W 1 cm

ENAMEL METAL PIN

- Shiny finish
- Bright colours, strong and long lasting
- Material: metal

SPILLA IN METALLO SMALTATO

- Finitura lucida
- Colori brillanti, ottima resistenza e durata nel tempo
- Materiale: metallo

BROCHE EN MÉTAL ÉMAILLÉ

- Finition brillante
- Couleurs brillantes, excellente résistance et durée dans le temps
- Matériau : métal

BROCHE DE METAL ESMALTADO

- Acabado brillante
- Colores brillantes, muy resistentes y duraderos en el tiempo
- Material: metal

BROSCHE AUS EMAILLIERTEM METALL

- Hochglanz-Oberfläche
- Brillante Farben, sehr beständig und dauerhaft
- Material: Metall

PACKAGING

carded
L 6.2 x H 8 x W 1.2 cm
SOLD X 6



KITTY
MTP0001



PANDA
MTP0002



LLAMA
MTP0003



AVOCADO
MTP0004



EGG
MTP0005



AIR BALLOON
MTP0006



BOOK LOVER
MTP0007



SPACE
MTP0008



GAME LOVER
MTP0009



SET OF 2 PINS



PACKAGING

carded
L 7.5 x H 8 x W 1.2 cm
SOLD X 6

PIZZA

MTP0010



MY INITIAL

L MAX 2.5 x H 2.5 x W 0.2 cm

ADHESIVE METAL LETTER

- Single-use
- Material: metal, 3M adhesive

LETTERA ADESIVA IN METALLO

- Monouso
- Materiale: metallo, adesivo 3M

LETTRE ADHÉSIVE EN MÉTAL

- À usage unique
- Matériau : métal, adhésif 3M

LETRA ADHESIVA DE METAL

- Artículo de un solo uso
- Material: metal, adhesivo 3M

KLEBEBUCHSTABE AUS METALL

- Einmalige Verwendung
- Material: Metall, 3M-Klebstoff

INDIVIDUAL DESIGNS: SOLD X 2

PACKAGING
carded
L 5 x H 8 cm



FIRST ORDER: MOQ 1 FULL ASSORTED DISPLAY (120 PCS)

material: cardboard
L 20.5 x H 16 x W 15.5 cm

ASSORTMENT:

- 6 PCS: A, E, L, M, S**
- 5 PCS: B, C, D, F, G, I, R, &**
- HEART, STAR,**
- FOUR-LEAF CLOVER**
- 4 PCS: N, O, P, T, V**
- 3 PCS: J**
- 2 PCS: H, K, W, Z**
- 1 PC: Q, U, X, Y**



ILSKIT1



A

ILS0001



B

ILS0002



C

ILS0003



D

ILS0004



E

ILS0005



F

ILS0006



G

ILS0007



H

ILS0008



I

ILS0009



J

ILS0010



K

ILS0011



L

ILS0012



M

ILS0013



N

ILS0014



O

ILS0015



P

ILS0016



Q

ILS0017



R

ILS0018



S

ILS0019



T

ILS0020



U

ILS0021



V

ILS0022



W

ILS0023



X

ILS0024



Y

ILS0025



Z

ILS0026



&

ILS0027



♥

ILS0028



★

ILS0029



♣

ILS0030



CUTIE

L MAX 3.2 x H MAX 2.5 x W 0.2 cm

SET OF 2 METAL STICKERS

- Single-use
- Material: metal, 3M adhesive

SET DI 2 ADESIVI IN METALLO

- Monouso
- Materiale: metallo, adesivo 3M

SET DE 2 AUTOCOLLANTS EN MÉTAL

- À usage unique
- Matériau : métal, adhésif 3M

SET DE 2 ADHESIVOS DE METAL

- Artículo de un solo uso
- Material: metal, adhesivo 3M

SET AUS 2 AUFKLEBERN MIT METALL

- Einmalige Verwendung
- Material: Metall, 3M-Klebstoff



PACKAGING
carded
L 6.2 x H 11 cm



PANDA + AVOCADO

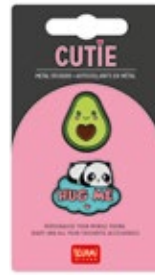

DISPLAY
material: cardboard
L 6.8 x H 14.6 x W 6.5 cm
10 PCS



PACKAGING
carded
L 6.2 x H 11 cm



FRIES



DISPLAY
material: cardboard
L 6.8 x H 14.6 x W 6.5 cm
10 PCS



PACKAGING
carded
L 6.2 x H 11 cm



NARWHAL + RAINBOW



DISPLAY
material: cardboard
L 6.8 x H 14.6 x W 6.5 cm
10 PCS



PACKAGING
carded
L 6.2 x H 11 cm



LLAMA + SLOTH



DISPLAY
material: cardboard
L 6.8 x H 14.6 x W 6.5 cm
10 PCS



PACKAGING
carded
L 6.2 x H 11 cm



UNICORN + DINOSAUR



DISPLAY
material: cardboard
L 6.8 x H 14.6 x W 6.5 cm
10 PCS



PACKAGING
carded
L 6.2 x H 11 cm



HEART



DISPLAY
material: cardboard
L 6.8 x H 14.6 x W 6.5 cm
10 PCS



UMBRELLA DRY BAG

L 13.7 x H 30.5 x W 0.4 cm

UMBRELLA DRY BAG

- Absorbent interior
- Leakproof PEVA layer
- Drawstring fastening
- Material: polyester (exterior), PEVA, microfibre (interior)

CUSTODIA ANTIGOCIA PER OMBRELLO

- Interno assorbente
- Strato antigoccia in PEVA
- Chiusura a coulisse
- Materiale: poliester (esterno), PEVA, microfibra (interno)

HOUSSE ANTIGOUTTE POUR PARAPLUIE

- Intérieur absorbant
- Épaisseur antigoutte en PEVA
- Fermeture à coulisse
- Matériau : polyester (extérieur), PEVA, microfibre (intérieur)

FUNDA ANTIGOTAS PARA PARAGUAS

- Interior absorbente
- Capa antigotas de PEVA
- Cierre con cordón
- Material: poliéster (externo), PEVA, microfibra (interior)

TROPFSICHERE REGENSCHIRMHÜLL

- Saugfähiges Innenfutter
- Tropfschutzschicht aus PEVA
- Verschluss mit Kordelzug
- Material: Polyester (außen), PEVA, Mikrofaser (innen)



PACKAGING

carded
L 10 x H 39.8 cm
SOLD X 4

UDB0001



8 052694 002336



Drawstring fastening



UNIVERSAL SIZE



LEAKPROOF



ABSORBENT INTERIOR



Umbrella not included



FOLDING UMBRELLA

L 5 x H 23.5 x W 5 cm (closed);
 Ø 100 cm, H 55 cm (opened)

FOLDING UMBRELLA

- Manual opening, windproof structure
- Carrying case included
- Material: polyester, black steel frame, plastic handle

OMBRELLO PIEGHEVOLE

- Apertura manuale, struttura antivento
- Custodia inclusa
- Materiale: poliester, struttura in acciaio nero, impugnatura in plastica

PARAPLUIE PLIANT

- Ouverture manuelle, structure résistante au vent
- Étui inclus
- Matériau : polyester, structure en acier noir, poignée en plastique

PARAGUAS PLEGABLE

- Apertura manual, estructura antiviento
- Funda incluida
- Material: poliéster, estructura en acero negro, mango de plástico

TASCHENSCHIRM

- Manuelle Öffnung, Anti-Wind-Struktur
- Inklusive Schutzhülle
- Material: Polyester, Struktur aus schwarzem Stahl, Kunststoffgriff

SOLD X 3



AFTER RAIN
UMB0001

 8 052783 615539

FOLDING UMBRELLA DISPLAY

Counter empty display
 on demand: MOQ 9 pcs
 material: cardboard
 L 17 x H 8 x W 17 cm (empty)
 L 17 x H 24 x W 17 cm (full)

DISUMB

 8 051128 752502



TRAVEL
UMB0003

 8 052783 615553



STARS
UMB0004

 8 053610 784435



I LOVE YOU UMBRELLA

Ø 123 cm, H 93 cm (opened)

HEART-SHAPED UMBRELLA

- Manual opening
- Material: polyester, black steel frame, plastic handle

OMBRELLO A FORMA DI CUORE

- Apertura manuale
- Materiale: poliestere, struttura in acciaio nero, impugnatura in plastica

PARAPLUIE EN FORME DE CŒUR

- Ouverture manuelle
- Matériau : polyester, structure en acier noir, poignée en plastique

PARAGUAS EN FORMA DE CORAZÓN

- Apertura manual
- Material: poliéster, estructura de acero negro, mango de plástico

REGENSCHIRM IN HERZFORM

- Manuelle Öffnung
- Material: Polyester, Struktur aus schwarzem Stahl, Kunststoffgriff

SOLD X 3



UMBH0001



RAINBOW UMBRELLA

Ø 130 cm, H 105 cm (opened)

UMBRELLA

- Automatic opening
- Material: polyester, black steel frame, wooden handle

OMBRELLO

- Apertura automatica
- Materiale: poliestere, struttura in acciaio nero, impugnatura in legno

PARAPLUIE

- Ouverture automatique
- Matériau : polyester, structure en acier noir, poignée en bois

PARAGUAS

- Apertura automática
- Material: poliéster, estructura de acero negro, mango de madera

REGENSCHIRM

- Automatische Öffnung
- Material: Polyester, Struktur aus schwarzem Stahl, Holzgriff

SOLD X 3



Automatic opening

UMBM0002





SOS *Smart Objects for Survival*

Be prepared to mastermind any situation

SOS LOOK AT ME

L 19 x H 15 cm (open);
L 5 x H 5.5 cm (closed)

LENS CLEANING CLOTH

- Ideal for cleaning glasses and all types of screens
- Material: polyamide, polyester

PANNO PULIZIA LENTI

- Ideale per pulire occhiali e tutti i tipi di schermi
- Materiale: poliammide, poliestere

CHIFFON DE NETTOYAGE LENTILLE OPTIQUE

- Idéal pour nettoyer vos lunettes et tout type d'écrans
- Matériau : polyamide, polyester

PAÑO PARA LIMPIAR LENTES

- Idóneo para limpiar gafas y todo tipo de pantallas
- Material: poliamida, poliéster

REINIGUNGSTUCH FÜR LINSEN

- Ideal zur Reinigung von Brillen und allen Arten von Bildschirmen
- Material: Polyamid, Polyester



DISPLAY

material: cardboard
L 5.5 x H 14.5 x W 16.2 cm

10 PCS

TRAVEL

LOOKKIT46



8 051128 756890



DISPLAY

material: cardboard
L 5.5 x H 14.5 x W 16.2 cm

10 PCS

STARS

LOOKKIT55



8 051128 756906



DISPLAY

material: cardboard
L 5.5 x H 14.5 x W 16.2 cm

10 PCS

PANDA

LOOKKIT56



8 051128 756913



DISPLAY

material: cardboard
L 5.5 x H 14.5 x W 16.2 cm

10 PCS

DAISY

LOOKKIT57



8 051128 756920

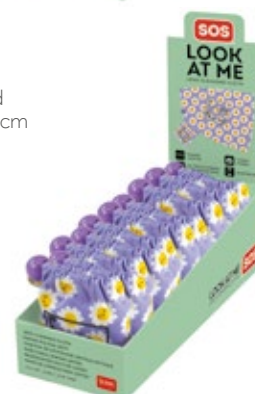

DISPLAY

material: cardboard
L 5.5 x H 14.5 x W 16.2 cm

10 PCS

RAINBOW

LOOKKIT58



8 051128 756937



SOS GLASSES

GLASSES REPAIR KIT

- Mini screwdriver key ring
- Material: plastic, metal

KIT RIPARA OCCHIALI

- Mini cacciavite portachiavi
- Materiale: plastica, metallo

SET DE RÉPARATION POUR LUNETTES

- Mini tournevis porte-clés
- Matériau : plastique, métal

SET REPARA GAFAS

- Llaveru minidestornillador
- Material: plàstic, metal

BRILLEN-REPARATUR-SET

- Mini-Schraubendreher als Schlüsselanhänger
- Material: Kunststoff, Metall

PACKAGING
carded
L 7 x H 15.5 x W 1 cm



DISPLAY
material: cardboard
L 18 x H 22.5 x W 13 cm
12 PCS

EYEKITZ



8 051128 750447



6 screws and 2 nose pads Phillips head Flat head



Mini screwdriver

SOS STRING

L 68 cm

GLASSES CORD

- Suitable for most frames
- Material: polyamide, non-slip rubber loop

CORDINO PER OCCHIALI

- Adatto alla maggior parte delle montature
- Materiale: poliammide, passante antiscivolo in gomma

CORDON À LUNETTES

- Adapté à la plupart des montures
- Matériau : polyamide, passant antiglisse en caoutchouc

CORDÓN PARA GAFAS

- Se adapta a la mayoría de las monturas
- Material: poliamida, enganche antideslizante de goma

BRILLENBAND

- Für die meisten Brillengestelle geeignet
- Material: Polyamid, rutschfeste Gummischlaufe

PACKAGING
carded
L 8 x H 16.5 cm



DISPLAY
material: cardboard
L 10 x H 27.5 x W 21 cm
15 PCS

ERBLAKITI BLACK ■



8 051128 756395



SUPER NIGHT DREAM

L 3.8 x H 6 x W 1.8 cm

RECHARGEABLE LED READING LIGHT

- LED light with 360° rotation
- 3 brightness levels
- Recharges from any USB port
- Warm white LED light
- Material: ABS, aluminium

LUCE LED DA LETTURA RICARICABILE

- Luce LED con rotazione a 360°
- 3 livelli di intensità di luce
- Si ricarica da qualsiasi porta USB
- Luce led bianco caldo
- Materiale: ABS, alluminio

LAMPE DE LECTURE LED RECHARGEABLE

- Lumière LED à rotation à 360°
- 3 niveaux d'intensité lumineuse
- Elle se recharge depuis n'importe quel port USB
- Lumière LED blanche chaude
- Matériau : ABS, aluminium

LUZ LED DE LECTURA RECARGABLE

- Luz led con rotación a 360°
- 3 niveles de intensidad de la luz
- Se carga en cualquier puerto USB
- Luz led blanco cálido
- Material: ABS, aluminium

WIEDERAUFLADBARES LED-LESELICHT

- LED-Licht um 360° drehbar
- 3 Helligkeitsstufen
- Kann über jeden USB-Anschluss aufgeladen werden
- LED-Licht warmweiß
- Material: ABS, Aluminium



Adjustable



360° rotation



Foldable

PACKAGING
cardboard box
L 8 x H 12.5 x W 2.5 cm
SOLD X 4

SND0001



8 052694 002022



Rechargeable via the USB cable included



Handy clip

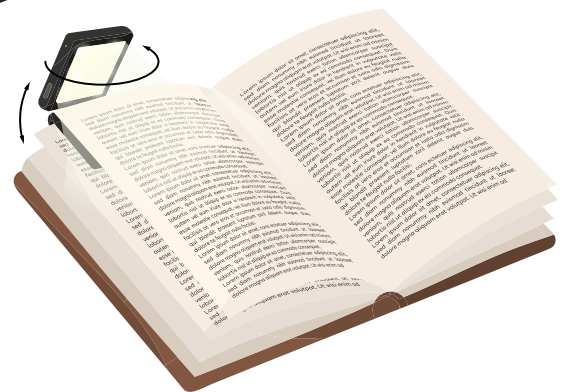

MINI NIGHT DREAM

L 3.5 x H 2.8 x W 1.6 cm

RECHARGEABLE LED READING LIGHT

- 2 brightness levels
- Can be recharged from any USB port
- Cold white LED light
- Material: ABS, stainless steel

LUCE LED DA LETTURA RICARICABILE

- 2 livelli di intensità di luce
- Si ricarica da qualsiasi porta USB
- Luce led bianco freddo
- Materiale: ABS, acciaio inox

LAMPE DE LECTURE LED RECHARGEABLE

- 2 niveaux d'intensité lumineuse
- Elle se recharge depuis n'importe quel port USB
- Lampe LED blanche froide
- Matériau : ABS, acier inox

LUZ LED DE LECTURA RECARGABLE

- 2 niveles de intensidad de la luz
- Recarga con cualquier puerto USB
- Luz led de color blanco frío
- Material: ABS, acero inoxidable

WIEDERAUFLADBARES LED-LESELICHT

- 2 Lichtstärkestufen
- Lässt sich über jeden USB-Port aufladen
- Kaltes weißes LED-Licht
- Material: ABS, Edelstahl

PACKAGING
carded
L 9.4 x H 13.2 cm

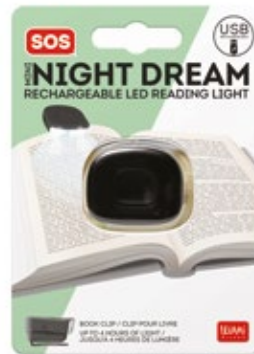

DISPLAY
material: cardboard
L 12.4 x H 24.7 x W 22 cm
10 PCS

LEDMRKIT1



8 051128 756777



Rechargeable via the USB cable included

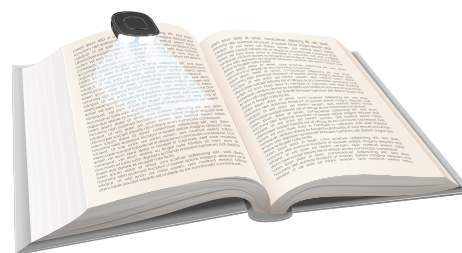

Handy clip



SMART NIGHT DREAM

L 13 x W 2 cm

ADJUSTABLE LED READING LIGHT

- With practical clip
- Cold white LED light
- Material: ABS, stainless steel

LUCE LED DA LETTURA ORIENTABILE

- Con pratica clip di aggancio
- Luce led bianco freddo
- Materiale: ABS, acciaio inox

LAMPE DE LECTURE LED ORIENTABLE

- Avec un clip d'accrochage pratique
- Lampe LED blanche froide
- Matériau : ABS, acier inox

LUZ LED DE LECTURA ORIENTABLE

- Incluye un práctico clip de enganche
- Luz led de color blanco frío
- Material: ABS, acero inoxidable

AUSRICHTBARE LED-LESELEUCHTE

- Mit praktischem Einhak-Clip
- Kaltes weißes LED-Licht
- Material: ABS, Edelstahl

PACKAGING
carded
L 7.5 x H 17 cm



DISPLAY

material: cardboard
L 19 x H 24.5 x W 13 cm
10 PCS

ABLKIT1



2 x LR1130
batteries (included)



Handy clip

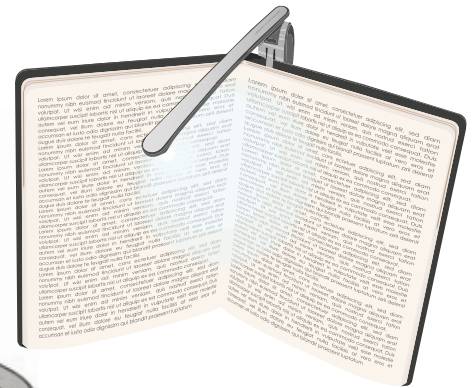

MICRO NIGHT DREAM

L 4.2 x H 3.5 x W 3.5 cm

LED GLASSES LIGHT

- Material: plastic

LUCE LED PER OCCHIALI

- Materiale: plastica

LAMPE LED POUR LUNETTES

- Matériau : plastique

LUZ LED PARA GAFAS

- Material: plástico

LED-LICHT FÜR BRILLE

- Material: Kunststoff

PACKAGING
carded
L 7.3 x H 11.8 cm



DISPLAY

material: cardboard
L 18 x H 19 x W 14.5 cm
8 PCS

MNLKIT1

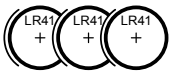

3 x LR41 batteries
(included)

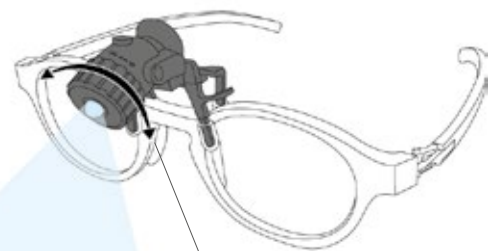

On/off switch

SOS HEADLAMP

L 28 x H 2.5 cm (band)
L 6 x H 4 x W 4 cm (lamp)

COB LED HEADLAMP

- 3 light modes: high (100 lm), eco (30 lm), strobe (flashing)
- Visibility: up to 12 m
- Material: plastic, fabric

LAMPADA FRONTALE LED COB

- 3 modalità di illuminazione: forte (100 lm), eco (30 lm), SOS (lampeggiante)
- Visibilità: fino a 12 m
- Materiale: plastica, tessuto

LAMPE FRONTALE LED COB

- 3 modes d'éclairage : puissant (100 lm), éco (30 lm), SOS (lumière clignotante)
- Visibilité : jusqu'à 12 m
- Matériau : plastique, tissu



3 x AAA batteries (included)



100 LUMENS



UP TO 10 HOURS



UP TO 12 m

LINTERNA FRONTAL LED COB

- 3 modos de iluminación: fuerte (100 lm), eco (30 lm) y SOS (parpadeo)
- Visibilidad: hasta 12 m
- Material: plástico, tejido

STIRNLAMPE MIT COB-LED

- 3 Leuchtarten: sehr hell (100 lm), eco (30 lm), SOS (Blinklicht)
- Sichtbarkeit: bis zu 12 m
- Material: Kunststoff, Gewebe

PACKAGING

carded
L 12 x H 15.5 x W 8 cm
SOLD X 6

HEL0001



8 054117 621377

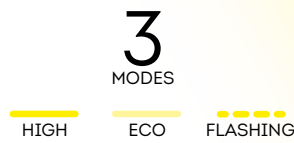
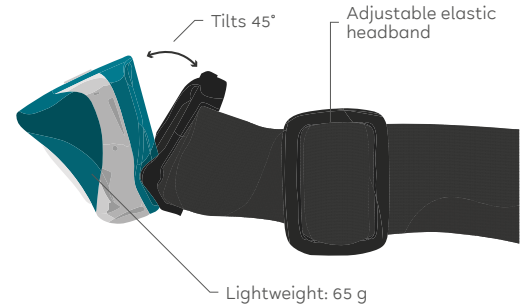

SOS CAR SWEET CAR

L MAX 6.8 x H MAX 11.5 cm



AIR AND CAR FRESHENER

• Material: fragranced cardboard

PROFUMATORE PER AUTO E AMBIENTI

• Materiale: cartoncino profumato

DÉSODORISANT POUR VOITURE ET ENVIRONNEMENTS

• Matériau : carton parfumé

AMBIENTADOR PARA EL COCHE Y PARA LOS AMBIENTES

• Material: cartón perfumado

DEODORANT FÜR AUTOS UND RÄUME

• Material: duftender Karton

PACKAGING

carded
L 7.4 x H 19 cm

DISPLAY

material: cardboard
L 8 x H 22 x W 5 cm
12 PCS



On the beach
AVOCADO
CARKIT17



8 051128 755503



Vanilla
DREAM CATCHER
CARKIT14



8 051128 755473



On the beach
CACTUS
CARKIT15



8 051128 755480



Ocean
HEART
CARKIT19



8 051128 756500



Strawberry
AIR BALLOON
CARKIT16



8 051128 755497



Ocean
SLOTH
CARKIT13



8 051128 755466



Vanilla
PANDA
CARKIT18



8 051128 755510

SOS WINTER

L MAX 9.5 x H MAX 10 cm

HAND WARMER

- Reusable
- Material: polyester, PE

SCALDAMANI

- Riutilizzabile
- Materiale: poliester, PE

CHAUFFE-MAINS

- Réutilisable
- Matériau : polyester, PE

CALENTADOR DE MANOS

- Reutilizable
- Material: poliéster, PE

HANDWÄRMER

- Wiederverwendbar
- Material: Polyester, PE

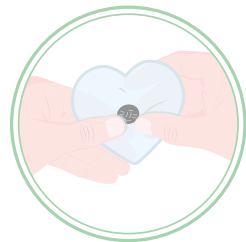

1.

Press the metal piece until a "click" is felt.

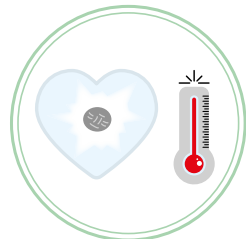

2.

The hand warmer will rapidly heat up. It will remain warm for approx. 30 minutes.

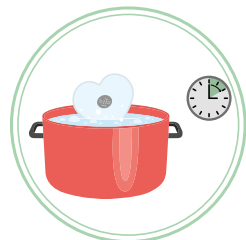

3.

To reuse it, place the hand warmer in boiling water for approx. 5 to 10 minutes.

PACKAGING

PET box w/ hook
L 9.5 x H 13.3 x W 1.7 cm



DISPLAY

material: cardboard
L 10 x H 17.5 x W 11.5 cm

7 PCS

PANDA WARMKIT8



PACKAGING

PET box w/ hook
L 9.5 x H 14.8 x W 1.7 cm



DISPLAY

material: cardboard
L 10 x H 19.5 x W 11.5 cm

7 PCS

PENGUIN WARMKIT9



PACKAGING

PET box w/ hook
L 9.5 x H 13.3 x W 1.7 cm



DISPLAY

material: cardboard
L 10 x H 17.5 x W 11.5 cm

7 PCS

HEART WARMKIT11



PACKAGING

PET box w/ hook
L 9.5 x H 13.3 x W 1.7 cm



DISPLAY

material: cardboard
L 10 x H 17.5 x W 11.5 cm

7 PCS

RAINBOW WARMKIT10



SOS RAIN

L 100 x H 76 cm - Kid's size
L 128 x H 130 cm - Adult size

DISPOSABLE RAIN PONCHO WITH HOOD

• Material: PE

PONCHO IMPERMEABILE USA E GETTA CON CAPPuccio

• Materiale: PE

PONCHO DE PLUIE IMPERMÉABLE À CAPUCHE JETABLE

• Matériau : PE

PONCHO IMPERMEABLE DESECHABLE CON CAPUCHA

• Material: PE

EINWEG-REGENPONCHO MIT KAPUZE

• Material: PE

PACKAGING
plastic bag w/hook
L 5 x H 9 x W 1.5 cm



DISPLAY
material: cardboard
L 22 x H 15 x W 14 cm
18 PCS

PONCHOKIT1
8 052694 003890



PACKAGING
plastic bag w/hook
L 7 x H 11.5 x W 1.5 cm



DISPLAY
material: cardboard
L 22 x H 18.5 x W 14 cm
18 PCS

PONCHOKIT1
8 051128 705060



SOS SANPEI

Ø 25.5 cm, H 12.5 cm

FOLDABLE RAIN HAT

• Material: nylon

CAPPELLO ANTIPIOGGIA PIEGHEVOLE

• Materiale: nylon

CHAPEAU DE PLUIE PLIABLE

• Matériau : nylon

GORRO IMPERMEABLE PLEGABLE

• Material: nylon

FALTBARER REGENHUT

• Material: Nylon

PACKAGING
plastic bag
L 12 x H 16 x W 1.5 cm



DISPLAY
material: cardboard
L 13.5 x H 25.5 x W 16 cm
7 PCS

HATKIT4
8 051128 756463



ONE SIZE FITS ALL

FOLDABLE BAG

L 12 x H 12 cm (folded);
L 43 x H 45.5 cm (opened)

FOLDABLE BAG
• Practical, lightweight and resistant
• Material: polyester

BORSA PIEGHEVOLE
• Pratica, leggera e resistente
• Materiale: poliester

SAC PLIABLE
• Pratique, léger et résistant
• Matériau : polyester

BOLSA PLEGABLE
• Práctica, ligera y resistente
• Material: poliéster

FALTBARE EINKAUFSTASCHE
• Praktisch, leicht und robust
• Material: Polyester



DISPLAY
material: cardboard
L 13 x H 17 x W 11 cm
7 PCS

TRAVEL FBAKIT4
8 051128 754674



MAX 20 KG

SOS POCKET HERO

L 8 x H 6 x W 0.7 cm

11-IN-1 MULTIFUNCTION CREDIT CARD

- Carry case included
- Material: stainless steel, PU case

CARTA MULTIFUNZIONE 11 IN 1

- Custodia inclusa
- Materiale: acciaio inossidabile, custodia in PU

CARTE MULTIFONCTION 11 EN 1

- Pochette incluse
- Matériau : acier inoxydable, pochette en PU

TARJETA MULTIFUNCIÓN 11 EN 1

- Funda incluida
- Material: acero inoxidable, funda de PU

11-IN-1-MULTIFUNKTIONSWERKZEUG

- Inklusive Etui
- Material: Edelstahl, Etui aus PU

PACKAGING

carded
L 11 x H 13 x W 1 cm

DISPLAY

material: cardboard
L 12.5 x H 20.5 x W 14 cm

12 PCS

METKIT1

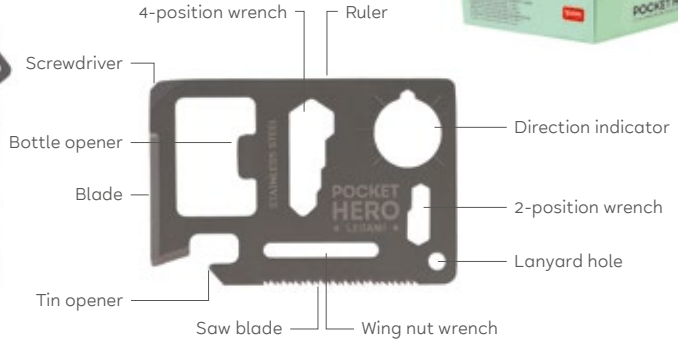

SOS MR. 007

L 3 x H 5 x W 0.8 cm (closed)

7-IN-1 MULTI-TOOL

- Nickel-free key ring
- Material: metal

MULTIFUNZIONE 7 IN 1

- Portachiavi nickel free
- Materiale: metallo

MULTI-OUTIL 7-EN-1

- Porte-clés sans nickel
- Matériau : métal

MULTIHERRAMIENTA 7 EN 1

- Llavero sin níquel
- Material: metal

7-IN-1-MULTIFUNKTIONSWERKZEUG

- Nickelfreier Schlüsselanhänger
- Material: Metall

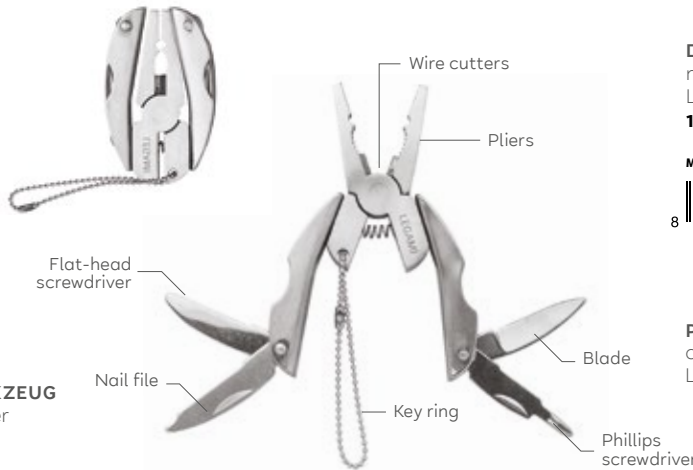

DISPLAY

material: cardboard
L 12.5 x H 19.5 x W 12.8 cm

10 PCS

MULTKIT1



PACKAGING

carded
L 10 x H 12 x W 1 cm



SOS I WILL SURVIVE

L 2.5 x H 9 cm (closed)

11-IN-1 MULTI-TOOL

- For recreational use only, not suitable for contact with food
- Material: ABS plastic handle, steel accessories

MULTIFUNZIONE 11 IN 1

- Solo per uso hobbistico, non adatto al contatto con alimenti
- Materiale: manico in plastica ABS, accessori in acciaio

MULTI-OUTIL 11-EN-1

- Adapté uniquement à des fins récréatives, ne convient pas au contact avec des aliments
- Matériau : manche en plastique ABS, accessoires en acier

MULTIHERRAMIENTA 11 EN 1

- Solo para uso lúdico, no apto para el contacto con alimentos
- Material: mango de plástico ABS, accesorios de acero

11-IN-1-MULTIFUNKTIONSWERKZEUG

- Nur zur Hobby-Anwendung, nicht für den Kontakt mit Lebensmitteln geeignet
- Material: Griff aus ABS-Kunststoff, Accessoires aus Stahl

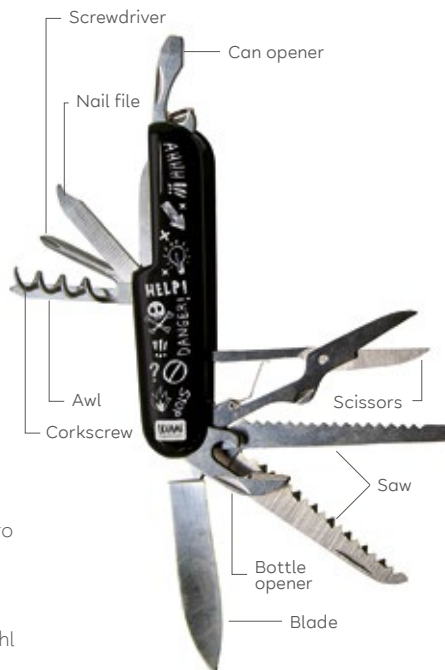

DISPLAY

material: cardboard
L 11.5 x H 15 x W 13.8 cm

12 PCS

KNIFKIT1



PACKAGING

cardboard box
L 10 x H 2.5 x W 3 cm



SOS SUPERPEN

Ø 1.2, H 9.7 cm

MINI MULTIFUNCTION PEN

• Material: steel, aluminium

MINI PENNA MULTIFUNZIONE

• Materiale: acciaio, alluminio

MINI STYLO MULTIFONCTION

• Matériau : acier, aluminium

MINIBOLÍGRAFO MULTIFUNCIÓN

• Material: acero, aluminio

MINI-MULTIFUNKTIONSTIFT

• Material: Stahl, Aluminium



PACKAGING

carded
L 8 x H 17 x W 1.4 cm



DISPLAY

material: cardboard
L 10 x H 26.5 x W 17 cm
10 PCS



PEMTKIT1



8 051128 754964

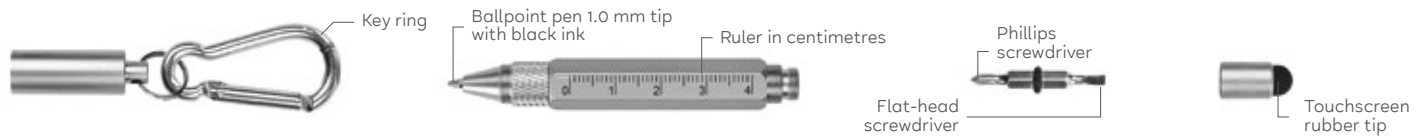

SOS MR. BIT

Ø 1.5 cm, H 11 cm

SCREWDRIVER

• Magnetic precision head
• Material: metal, aluminium

CACCIAVITE

• Testa magnetica di precisione
• Materiale: metallo, alluminio

TOURNEVIS

• Support magnétique de précision
• Matériau : métal, aluminium

DESTORNILLADOR

• Cabezal magnético de precisión
• Material: metal, aluminio

SCHRAUBENZIEHER

• Magnetischer Präzisionskopf
• Material: Metall, Aluminium

PACKAGING

carded
L 7.5 x H 16.5 x W 2 cm



DISPLAY

material: cardboard
L 20 x H 24 x W 13.5 cm
12 PCS



SCWKITS



8 051128 754728

Chrome vanadium bits

- ⊕ 3 Phillips-heads
- ⊖ 3 flat-heads
- ⚙ 2 torx-heads



8 interchangeable bits

SOS MR. CARPENTER

L 7 x H 20 x W 2 cm

6-IN-1 MULTIFUNCTION HAMMER

• The handle contains 4 screwdrivers:
2 flat-head and 2 Phillips
• Material: steel

MARTELLO MULTIFUNZIONE 6 IN 1

• Il manico contiene 4 cacciaviti:
2 a punta piatta e 2 a croce Phillips
• Materiale: acciaio

MARTEAU MULTIFONCTION 6-EN-1

• Le manche contient 4 tournevis :
2 à pointe plate et 2 cruciformes
• Matériau : acier

MARTILLO MULTIFUNCIÓN 6 EN 1

• El mango contiene 4 destornilladores:
2 de punta plana y 2 Phillips
• Material: acero

6-IN-1-MULTIFUNKTIONSHAMMER

• Der Griff enthält vier Schraubenzieher:
2 Schlitz- und 2 Kreuz-Schraubenzieher
• Material: Stahl

- ⊕ 2 Phillips screwdrivers
- ⊖ 2 flat-head screwdrivers

PACKAGING

carded
L 10 x H 26.5 x W 2.2 cm
SOLD X 6

HAMM0001



8 052461 962627



SOS PASSWORD BOOK

L 8.2 x H 5 x W 0.4 cm (closed)

**BOOKLET FOR ORGANISING
USERNAMES AND PASSWORDS**

- Material: paper, magnetic cover

**LIBRICINO PER ORGANIZZARE
USERNAME E PASSWORD**

- Materiale: carta, copertina magnetica

**CARNET POUR NOTER LES IDENTIFIANTS
ET LES MOTS DE PASSE**

- Matériau : papier, couverture magnétique

**CUADERNILLO PARA ORGANIZAR
NOMBRES DE USUARIO Y
CONTRASEÑAS**

- Material: papel, tapa magnética

**BÜCHLEIN ZUR ORGANISATION VON
BENUTZERNAMEN UND PASSWÖRTERN**

- Material: Papier, Magnet-Cover

PACKAGING

carded
L 11 x H 13 x W 0.4 cm



DISPLAY

material: cardboard
L 12.5 x H 23 x W 18.5 cm

15 PCS

PSWKIT1

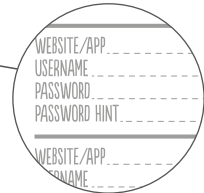

9 sheets to keep up
to 36 accounts

SOS SECRET BANK

Ø 1.5 cm, L 5.5 cm

MONEY HOLDER KEY RING

- Can hold one rolled banknote
- Material: aluminium

PORTACHIAVI PORTA SOLDI

- Può contenere una banconota arrotolata
- Materiale: alluminio

PORTE-CLÉS PORTE-MONNAIE

- Il peut contenir un billet roulé à l'intérieur
- Matériau : aluminium

LLAVERO PORTA DINERO

- Puede contener un billete enrollado
- Material: aluminio

**SCHLÜSSELANHÄNGER FÜR EINE
BANKNOTE**

- Kann eine aufgerollte Banknote aufnehmen
- Material: Aluminium

PACKAGING

carded
L 7 x H 10.5 x W 0.7 cm



DISPLAY

material: cardboard
L 17 x H 17 x W 10.8 cm

10 PCS

SECKIT1



Fold your banknote,
then roll and put it here



SECRET ROCK

L 10.3 x H 5.5 x W 9 cm

KEY-HIDER STONE

- Reclosable compartment
- Material: polyresin, plastic

SASSO NASCONDI CHIAVE

- Scompartimento richiudibile
- Materiale: poliresina, plastica

PIERRE CACHE-CLÉ

- Compartiment refermable
- Matériau : polyrésine, plastique

PIEDRA ESCONDE LLAVE

- Compartimento recerrable
- Material: poliresina, plástico

**STEIN ZUM VERSTECKEN
VON SCHLÜSSELN**

- Wiederschließbares Fach
- Material: Polyresin, Kunststoff

DISPLAY

material: cardboard
L 19.5 x H 23.5 x W 22.5 cm

8 PCS

ROCKKIT1



Top



Bottom



SOS MISS SPRAYER

L 3 x H 10.2 x W 3 cm

MINI FACIAL MIST SPRAYER

- USB rechargeable
- Lightweight and compact
- Super-silent
- Material: ABS

MINI NEBULIZZATORE PER IL VISO

- Ricaricabile USB
- Leggero e compatto
- Ultrasilenzioso
- Materiale: ABS

MINI BRUMISATEUR POUR LE VISAGE

- Rechargeable par USB
- Léger et compact
- Très silencieux
- Matériau : ABS

MINI NEBULIZADOR PARA EL ROSTRO

- Recargable con USB
- Ligero y compacto
- Ultrasilencioso
- Material: ABS

MINI ZERSTÄUBER FÜR DAS GESICHT

- Aufladbar mit USB
- Leicht und kompakt
- Besonders leise
- Material: ABS

PACKAGING

window box w/hook
L 6.2 x H 15 x W 3.5 cm

SOLD X 4

MTS0001

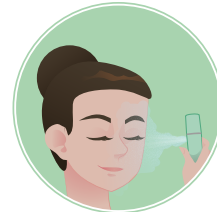

REFRESH YOUR FACE!

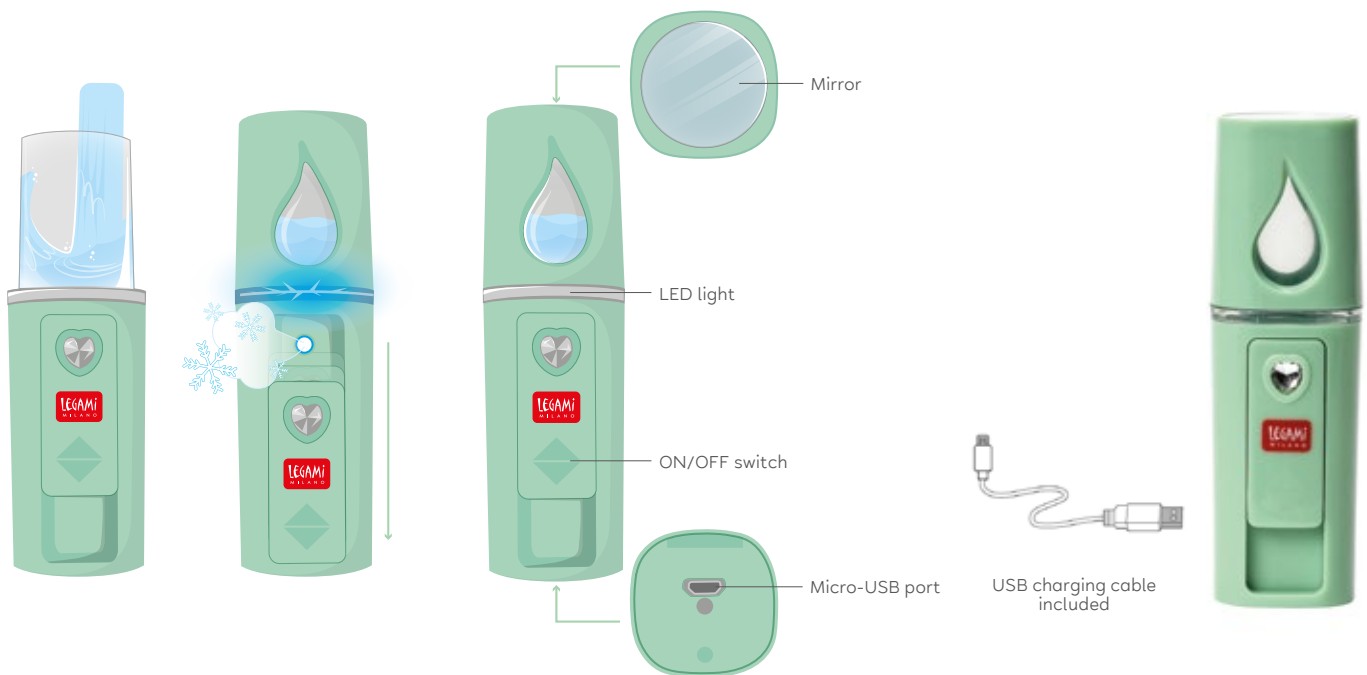

SOS PERFECT KISS

Ø 1.6 cm, H 10 cm

REFRESHING MOUTH SPRAY

- Refreshing action to eliminate bad breath. Works instantly

SPRAY ORALE RINFRESCANTE

- Azione rinfrescante, per eliminare i cattivi odori. Effetto immediato

SPRAY BUCCAL RAFRAÎCHISSANT

- Action rafraichissante, pour éliminer les mauvaises odeurs. Effet immédiat

SPRAY ORAL REFRESCANTE

- Acción refrescante para eliminar los malos olores. Efecto inmediato

ERFRISCHENDES MUNDSPRAY

- Wirkt erfrischend, um Mundgeruch zu beseitigen. Sofort wirksam

PACKAGING

carded
L 7 x H 14 x W 2 cm

DISPLAY

material: cardboard
L 9 x H 12 x W 27.5 cm

12 PCS

PKKIT1



SOS MR. TICKLE

BACK SCRATCHER
• Material: metal

GRATTASCHIENA
• Materiale: metallo

GRATTE-DOS
• Matériau : métal

RASCADOR DE ESPALDA
• Material: metal

RÜCKENKRATZER
• Material: Metall

MINI BACK SCRATCHER

L 11 cm (closed)
L 25 cm (extended)

PACKAGING
carded
L 7.5 x H 15.5 x W 1.5 cm



DISPLAY
material: cardboard
L 18 x H 21 x W 10.5 cm
10 PCS

MBSKIT1
8 051128 754421

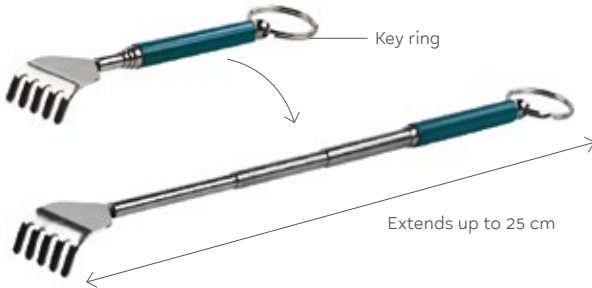

BACK SCRATCHER

L 15.5 cm (closed)
L 51 cm (extended)

PACKAGING
carded
L 8 x H 22.2 x W 1 cm



DISPLAY
material: cardboard
L 18.2 x H 29 x W 11.5 cm
10 PCS

TESCKIT1
8 051128 754896



SEWING KIT

Ø 8 cm, H 16 cm

SEWING KIT

- Retro style glass jar with a soft lid that can be used as a pincushion
- Material: glass jar, soft lid with pincushion

KIT PER CUCITO

- Barattolo di vetro dallo stile retrò con tappo morbido che consente di appuntare aghi e spilli
- Materiale: barattolo in vetro, tappo morbido con cuscino

SET DE COUTURE

- Bocal en verre au style rétro avec couvercle mou qui permet d'y épingler des aiguilles et des épingles
- Matériau : bocal en verre, couvercle mou avec coussin

SET DE COSTURA

- Bote de vidrio en estilo retro con tapón blando que permite clavar agujas y alfileres
- Material: bote de vidrio, tapa blanda con almohadilla

NÄHSET

- Glasbehälter im Retro-Stil mit weichem Verschluss, der als Nadelkissen dient
- Material: Behälter aus Glas, weicher Verschluss mit Nadelkissen

PACKAGING

cardboard box
L 8.5 x H 16.2 x W 8.5 cm
SOLD X 4

SEW0001
8 056304 489937



SOS MR. SIZE - FOLDING RULER

L 23 x H 1.6 x W 3.6 cm (folded)

FOLDING RULER

- Extension: up to 200 cm / 78"
- 10 folds
- Double graduation: inches and centimetres
- Material: birch wood, iron hinges with engraved graduation

METRO PIEGHEVOLE

- Estensione: fino a 200 cm / 78"
- 10 pieghe
- Doppia misurazione: centimetri e pollici
- Materiale: legno di betulla, giunzioni in ferro con graduazione incisa

MÈTRE PLIANT

- Extension : jusqu'à 200 cm / 78"
- 10 segments
- Double mesure : centimètres et pouces
- Matériau : bois de bouleau, articulations en fer avec graduation gravée

METRO PLEGABLE

- Extensión: hasta 200 cm / 78"
- 10 pliegues
- Doble medida: centímetros y pulgadas
- Material: madera de abedul, uniones de hierro con escala grabada

KLAPPBARER METERSTAB

- Länge: bis zu 200 cm / 78"
- 10 Klappteile
- Zwei Maßeinheiten: Zentimeter und Zoll
- Material: Birkenholz, Gelenke aus Eisen mit eingprägter Maßeinteilung

PACKAGING:

cardboard wrap
L 3.8 x H 25.8 x W 1.6 cm

SOLD X 6

WFR0001



8 051739 306859

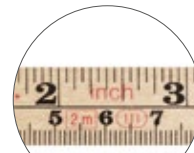

SOS MR. SIZE - RETRACTABLE TAPE MEASURE

L 5 x H 5 x W 1.4 cm

RETRACTABLE TAPE MEASURE

- Double graduation: inches and centimetres
- Extension: up to 200 cm / 80"
- Material: PVC tape measure, ABS case

METRO RETRATTILE

- Doppia graduazione in centimetri e pollici
- Estensione: fino a 200 cm / 80"
- Materiale: metro in PVC, cassa in ABS

MÈTRE RÉTRACTABLE

- Double mesure : centimètres et pouces
- Extension : jusqu'à 200 cm / 80"
- Matériau : mètre en PVC, boîtier en ABS

CINTA MÉTRICA RETRÁCTIL

- Doble medida: centímetros y pulgadas
- Extensión: hasta 200 cm / 80"
- Material: metro en PVC, carcasa de ABS

ROLLMASSBAND

- Zwei Maßeinheiten: Zentimeter und Zoll
- Länge: bis zu 200 cm / 80"
- Material: Maßband aus PVC, Kapsel aus ABS

PACKAGING

carded
L 8 x H 14.4 x W 1.4 cm

DISPLAY

material: cardboard
L 8.5 x H 25 x W 20 cm
12 PCS

TMKIT2



8 051128 754841



SOS FOLDING STOOL

L 39.5 x H 30 x W 21.5 cm (opened)

FOLDING STOOL

- Space-saving closable stool
- Material: PP, metal screws

SGABELLO PIEGHEVOLE

- Sgabello richiudibile salvaspazio
- Materiale: PP, viti in metallo

ESCABEAU PLIANT

- Escabeau repliable et peu encombrant
- Matériau : PP, vis en métal

TABURETE PLEGABLE

- Taburete plegable compacto
- Material: PP, tornillos de metal

KLAPPHOCKER

- Platzsparender Klapphocker
- Material: PP, Metallschrauben



PACKAGING

shrink-wrapping
L 39.5 x H 44 x W 5.5 cm
SOLD X 4

FS0001



8 059174 839680



SOS 7-DAYS

L 10 x H 1.6 x W 3 cm

PILL BOX

- 7 different compartments, one for each day of the week
- Material: chrome-plated stainless metal, ABS

PORTA PILLOLE

- 7 diversi scomparti, uno per ogni giorno della settimana
- Materiale: metallo inossidabile cromato, ABS

PILULIER

- 7 compartiments séparés, un pour chaque jour de la semaine
- Matériau : métal inoxydable chromé, ABS

PASTILLERO

- 7 compartimentos distintos, uno para cada día de la semana
- Material: metal inoxidable cromado, ABS

PILLENDOSE

- 7 verschiedene Fächer, eins für jeden Wochentag
- Material: verchromtes, rostfreies Metall, ABS

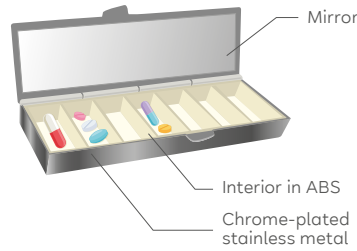

DISPLAY

material: cardboard
L 10.5 x H 19 x W 13.5 cm
8 PCS

TRAVEL PILLKIT10



SOS FEEL BETTER

Ø 15 cm, H 6 cm - 350 ml

FABRIC ICE BAG

- Practical screw cap with hermetic seal
- Material: cotton and polyester, internal fabric with PVC coating

BORSA DEL GHIACCIO IN TESSUTO

- Pratico tappo a vite con chiusura ermetica
- Materiale: cotone e poliestere, tessuto interno con rivestimento in PVC

POCHE À GLACE EN TISSU

- Bouchon à vis pratique avec fermeture hermétique
- Matériau : coton et polyester, tissu interne avec revêtement en PVC

* While stock lasts

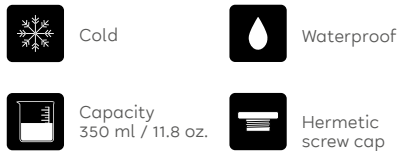

BOLSA DE HIELO DE TELA

- Práctico tapón de rosca con cierre hermético
- Material: algodón y poliéster, tejido interior con revestimiento en PVC

EISTASCHE AUS STOFF

- Praktischer, hermetischer Schraubverschluss
- Material: Baumwolle und Polyester, Innenfutter mit PVC-Beschichtung



TRAVEL IB0001



PACKAGING

window box
L 11.2 x H 11 x W 11.2 cm
SOLD X 3



PENGUIN IB0003



SOS PERSONAL ALARM

L 4.5 x H 9.5 x W 2 cm

PERSONAL SAFETY ALARM WITH LED LIGHT

- For attracting attention
- Material: plastic, aluminium

ALLARME DI SICUREZZA PERSONALE CON LUCE LED

- Permette di attirare l'attenzione
- Materiale: plastica, alluminio

ALARME DE SÉCURITÉ PERSONNELLE AVEC LUMIÈRE LED

- Elle permet d'attirer l'attention
- Matériau : plastique, aluminium

ALARMA DE SEGURIDAD PERSONAL CON LUZ LED

- Permite llamar la atención
- Material: plástico, aluminio

TASCHENALARM MIT LED-LICHT

- Erregt Aufmerksamkeit in Notsituationen
- Material: Kunststoff, Aluminium

PACKAGING

carded
L 9 x H 14.4 x W 2.2 cm



DISPLAY

material: cardboard
L 20 x H 22.5 x W 15.3 cm
8 PCS

PALKIT1

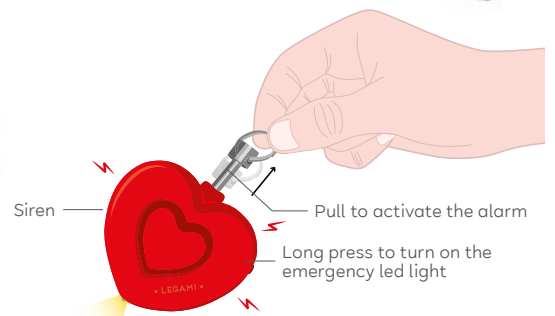

SOS SCREEN CLEANER

L 15 x H 13 cm

PRE-MOISTENED WIPES

- 12 individually-wrapped wipes
- Ideal for cleaning glasses and all types of screen

SALVIETTINE PRE-IMBEVUTE

- 12 salviettine confezionate singolarmente
- Ideali per pulire occhiali e tutti i tipi di schermi

LINGETTES NETTOYANTES PRÉ-HUMIDIFIÉES

- 12 lingettes avec sachet individuel
- Idéales pour nettoyer vos lunettes et tout type d'écrans

TOALLITAS HÚMEDAS

- 12 toallitas envasadas individualmente
- Idóneas para limpiar gafas y todo tipo de pantallas

VORGETRÄNKTE TÜCHER

- 12 einzeln verpackte Tücher
- Ideal zur Reinigung von Brillen und allen Arten von Bildschirmen

PACKAGING

cardboard box
L 6 x H 5.3 x W 4.5 cm



Individually-wrapped

DISPLAY

material: cardboard
L 12.5 x H 21 x W 19 cm

16 PCS

SCLKITI



8 051128 750768



SOS HAND CLEANSING GEL

L 4 x H 13 x W 3 cm (carabiner included) – 30 ml

HAND CLEANSING GEL

GEL DETERGENTE MANI

GEL NETTOYANT POUR LES MAINS

GEL LIMPIADOR DE MANOS

HANDREINIGUNGSGEL



62% alcohol

Non-sticky

With emollient pearls

No need to rinse

Instant and effective



Equipped with a metal carabiner



Ocean breeze

DISPLAY

material: cardboard
L 14.5 x H 16 x W 13 cm

12 PCS

TRAVEL

HSKITS



8 051128 756432



SOS CLEANSING WET WIPES

L 7 x H 13 x W 2 cm

10 CLEANSING WET WIPES FOR HANDS

- Plastic free
- Scented sanitising hand wipes in resealable packaging
- Made of viscose

10 SALVIETTINE DETERGENTI UMIDIFICATE PER MANI

- Senza plastica
- Salviettine umidificate detergenti e profumate per mani in confezione richiudibile
- In viscosa

10 LINGETTES NETTOYANTES HUMIDES POUR LES MAINS

- Sans plastique
- Lingettes nettoyantes humides et parfumées pour les mains en emballage refermable
- En viscoso

10 TOALLITAS LIMPIADORAS HÚMEDAS PARA MANOS

- Sin plástico
- Toallitas húmedas limpiadoras y perfumadas para manos en envase resellable
- De viscosa

10 REINIGENDE FEUCHTTÜCHER FÜR DIE HÄNDE

- Ohne Kunststoff
- Duftende, reinigende Feuchttücher für die Hände in einer wiederverschließbaren Packung
- Aus Viskose

*Plastic free: wording refers to the wipes.



70% alcohol

Non-sticky

No need to rinse



Ocean breeze

DISPLAY

material: cardboard
L 12 x H 16.5 x W 11.5 cm

12 PCS

TRAVEL

WIPKITS



8 052694 003180



* ONE MORE DESIGN ON PAGE 52

LET THE WIND BLOW

L 2.7 x H 8 x W 1.2 cm

WINDPROOF LIGHTER

- Material: plastic, metal

ACCENDINO ANTIVENTO

- Materiale: plastica, metallo

BRIQUET TEMPÊTE

- Matériau : plastique, métal

MECHERO ANTIVIENTO

- Material: plástico, metal

STURMFUERZEUG

- Material: Kunststoff, Metall



TRAVEL UNICORN STARS FLOWERS THIS IS MINE



Wind Proof

DISPLAY

material: cardboard

L 13.5 x H 14.5 x W 12.8 cm

50 PCS: 10 X DESIGN

BLKIT3



8 051128 756210



SI CHIAMA PIETRO

L 2.3 x H 6.8 x W 1 cm

ACCENDINO ELETTRICO RICARICABILE

- Materiale: plastica, metallo

* While stock lasts

ITALIAN MARKET ONLY



DISPLAY

material: cardboard

L 12 x H 15 x W 12 cm

50 PCS: 10 X DESIGN

LIGH0034 *



8 056304 482310



TAKE ME AWAY

L 6 x H 8.8 cm

POCKET ASHTRAY

- Outer material: PVC; internal material: heat-resistant aluminium foil

POSACENERE DA TASCHINO

- Materiale esterno: PVC; materiale interno: foglio in alluminio resistente al calore

CENDRIER DE POCHE

- Matériau extérieur : PVC; matériau intérieur : feuille en aluminium résistante à la chaleur

CENICERO DE BOLSILLO

- Material externo: PVC; material interno: capa de aluminio resistente al calor

ASCHENBECHER FÜR DIE TASCHE

- Außenmaterial: PVC; Innenmaterial: wärmebeständige Aluminiumfolie



DISPLAY

material: cardboard

L 9 x H 17 x W 17.5 cm

12 PCS

TRAVEL

PASHKIT14



8 051128 755558



NO SMOKING

L 6 x H 9.5 x W 2.5 cm

CIGARETTE PACKET HOLDER

- Material: tin

* While stock lasts

SOLD X 3

PORTA PACCHETTO DI SIGARETTE

- Materiale: latta

ÉTUI POUR PAQUETS DE CIGARETTES

- Matériau : fer-blanc

PORTA-PAQUETE DE CIGARROS

- Material: hojalata

ETUI FÜR ZIGARETTENSCHACHEL

- Material: Blech



BOAT

NOSP0015 *



8 056304 489838



AFTER RAIN

NOSP0017 *



8 056304 489852



STAR **TECH**
It's Show Time

Free your tech from the monotony of grey

SUPER FAST

Ø MAX 10 cm

SMARTPHONE WIRELESS CHARGER

- Compatible with smartphones with Qi technology
- Material: silicone

CARICABATTERIE WIRELESS PER SMARTPHONE

- Compatibile con smartphone con tecnologia Qi
- Materiale: silicone

CHARGEUR SANS FIL POUR SMARTPHONE

- Compatible avec les smartphones de technologie Qi
- Matériau : silicone

CARGADOR INALÁMBRICO PARA SMARTPHONE

- Compatible con smartphones con tecnología Qi
- Material: silicona

KABELLOSE LADESTATION FÜR SMARTPHONE

- Kompatibel mit Smartphones mit Qi-Technologie
- Material: Silikon

PACKAGING

window box w/hook
L 12.5 x H 12.5 x W 2.4 cm
SOLD X 3

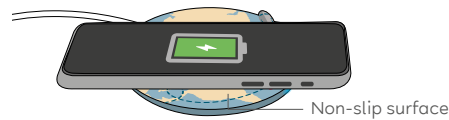
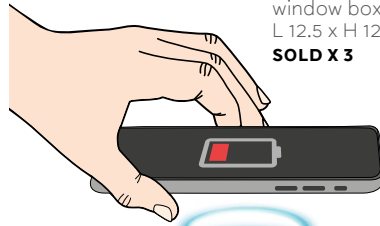

AVOCADO
WCHAR0001



PANDA
WCHAR0002



VINYL
WCHAR0005



TRAVEL
WCHAR0006



KITTY
WCHAR0008



MY SUPER POWER

L MAX 13 x H MAX 13 x W MAX 5.5 cm

POWER BANK

• Material: ABS

BATTERIA RICARICABILE

• Materiale: ABS

BATTERIE EXTERNE

• Matériau : ABS

BATERÍA EXTERNA RECARGABLE

• Material: ABS

POWERBANK

• Material: ABS

* While stock lasts



PACKAGING

window box w/hook

L 10 x H 15.5 x W 5 cm

SOLD X 2



USB charging cable included for charging the power bank



AVOCADO

POW0017 *



8 054117 620004



RAINBOW

POW0019



8 054117 620028



HEART

POW0020



8 054117 620035



GIN

POW0021



8 054117 620042



UNICORN

POW0022



8 054117 620059



KITTY

POW0024



8 052694 002091

MY SUPER POWER



Ø 3.5 x H MAX 11.6 cm

POWER BANK

- Charges up to two devices simultaneously
- Material: PVC

BATTERIA RICARICABILE

- Ricarica fino a due dispositivi contemporaneamente
- Materiale: PVC

BATTERIE EXTERNE

- Elle recharge jusqu'à deux appareils en même temps
- Matériau : PVC

BATERÍA EXTERNA RECARGABLE

- Recarga hasta dos dispositivos a la vez
- Material: PVC

POWERBANK

- Bis zu zwei Geräte gleichzeitig aufladen
- Material: PVC

4800 mAh

PACKAGING

window box
L 7.2 x H 19.2 x W 4 cm
SOLD X 2



USB - Type-C charging cable included



HIPPO
POW0025



UNICORN
POW0026



SUPERCHARGE

L 6.2 x H 9 x W 1 cm

POWER BANK

- 2 USB ports: charges up to two devices simultaneously
- Material: ABS

BATTERIA RICARICABILE

- 2 porte USB: ricarica fino a due dispositivi contemporaneamente
- Materiale: ABS

BATTERIE EXTERNE

- 2 ports USB : elle recharge jusqu'à deux appareils en même temps
- Matériau : ABS

* While stock lasts

5000 mAh

BATERÍA EXTERNA RECARGABLE

- 2 puertos USB: recarga hasta dos dispositivos a la vez
- Material: ABS

POWERBANK

- 2 USB-Ports: bis zu zwei Geräte gleichzeitig aufladen
- Material: ABS



LED light battery indicator

Micro USB input
USB output

PACKAGING

carded
L 9 x H 17 x W 3 cm
SOLD X 2



USB charging cable included



PETROL BLUE
POW0008 *



TRAVEL
POW0014



DAISY
POW0023 *





TEDDY BEAR
POW0027



PANDA
POW0028



KOALA
POW0029

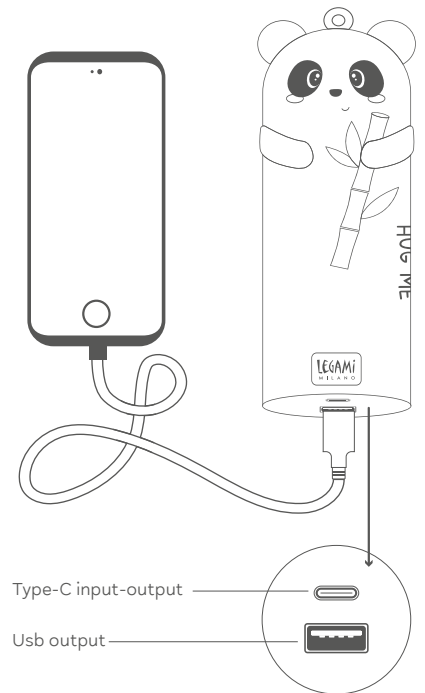

WIRELESS POWER MAN

L 6.3 x H 9.5 x W 1.5 cm

PORTABLE WIRELESS POWER BANK

- Suitable for wireless charging of smartphones with Qi technology
- 2-in-1: you can charge 2 devices simultaneously via wireless and/or USB charging
- Material: ABS, silicone micro suction cups

CARICABATTERIE WIRELESS PORTATILE

- Adatto per la ricarica wireless di smartphone con tecnologia Qi
- 2 in 1: è possibile ricaricare 2 dispositivi contemporaneamente tramite carica wireless e/o tramite USB
- Materiale: ABS, micro ventose in silicone

CHARGEUR SANS FIL PORTABLE

- Adapté pour la recharge sans fil de smartphones dotés de la technologie Qi
- 2-en-1: il est possible de recharger 2 appareils en même temps par l'intermédiaire de la recharge sans fil et/ou USB
- Matériau : ABS, micro-ventouses en silicone

* While stock lasts

BATERÍA EXTERNA RECARGABLE INALÁMBRICA PORTÁTIL

- Apto para la carga inalámbrica de smartphones con tecnología Qi
- 2 en 1: se pueden cargar 2 dispositivos a la vez con carga inalámbrica y/o con USB
- Material: ABS, microventosas en silicona

TRAGBARE KABELLOSE POWERBANK

- Geeignet für das kabellose Aufladen von Smartphones, die über die Qi-Technologie verfügen
- 2 in 1: Ermöglicht das Aufladen von bis zu 2 Geräten mit der kabellosen Ladefunktion und/ oder via USB gleichzeitig
- Material: ABS, kleine Saugnäpfe aus Silikon



PACKAGING

cardboard box w/hook
L 10.5 x H 16 x W 2 cm

SOLD X 2

POW0013 *



USB charging cable included



SUPER FAST - STAND

L 7 x H 11 x W 8 cm

WIRELESS CHARGING STAND

- Compatible with smartphones with Qi technology
- Material: ABS

CARICABATTERIE WIRELESS CON SUPPORTO

- Compatibile con smartphone con tecnologia Qi
- Materiale: ABS

CHARGEUR SANS FIL AVEC SUPPORT

- Compatible avec les smartphones de technologie Qi
- Matériau : ABS

CARGADOR INALÁMBRICO CON SOPORTE

- Compatible con smartphones con tecnología Qi
- Material: ABS

KABELLOSE LADESTATION MIT HALTERUNG

- Kompatibel mit Smartphones mit Qi-Technologie
- Material: ABS

PACKAGING

cardboard box w/hook
L 9.5 x H 12 x W 7.7 cm

SOLD X 4

WCHAR0007

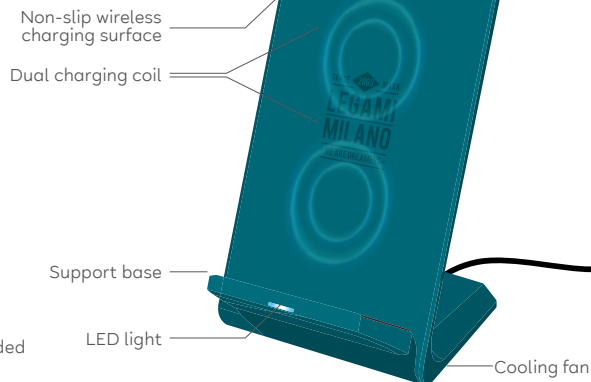

USB cable included



MEOW POWER BANK

Ø 4 cm, H 9.5 cm

POWER BANK

- Material: ABS

BATTERIA RICARICABILE

- Materiale: ABS

BATTERIE EXTERNE

- Matériau : ABS

BATERÍA EXTERNA RECARGABLE

- Material: ABS

POWERBANK

- Material: ABS



PACKAGING

PET box w/hook
L 6 x H 15 x W 6 cm

SOLD X 2

POW0007



PLUG & CHARGE - USB + USB-C

L 2.5 x H 4.2 x W 8.2 cm

WALL CHARGER

- 1 USB port and 1 USB-C port
- Type-C plug (European 2-pin)
- Material: plastic

CARICABATTERIE DA MURO

- 1 porta USB e 1 porta USB Tipo-C
- Spina di Tipo C (europea a due poli)
- Materiale: plastica

CHARGEUR MURAL

- 1 port USB et 1 port USB Type-C
- Prise de Type-C (européenne à deux broches)
- Matériau : plastique

CARGADOR DE PARED

- 1 puerto USB y 1 puerto USB tipo C
- Enchufe tipo C (europeo de dos polos)
- Material: plástico

LADEGERÄT

- 1 USB-Port und 1 USB-C-Port
- Typ-C-Stecker (Eurostecker, zweipolig)
- Material: Kunststoff

PACKAGING

PVC box w/hook
L 4.5 x H 10.5 x W 2.8 cm



DISPLAY

material: cardboard
L 9.4 x H 15 x W 9 cm

6 PCS

WACHKIT1



UP TO 2 DEVICES



FAST CHARGE



SAFE CHARGING

Compatibility

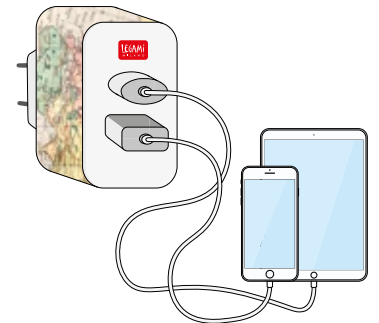

PLUG & CHARGE - 3 USB

L 2.3 x H 6 x W 7 cm

WALL CHARGER

- 3 USB ports
- Type-C plug (European 2-pin)
- Material: plastic

CARICABATTERIE DA MURO

- 3 porte USB
- Spina di Tipo C (europea a due poli)
- Materiale: plastica

CHARGEUR MURAL

- 3 ports USB
- Prise de Type-C (européenne à deux broches)
- Matériau : plastique

CARGADOR DE PARED

- 3 puertos USB
- Enchufe tipo C (europeo de dos polos)
- Material: plástico

LADEGERÄT

- 3 USB-Ports
- Typ-C-Stecker (Eurostecker, zweipolig)
- Material: Kunststoff

PACKAGING

PVC box w/hook
L 6 x H 8.8 x W 2.5 cm



DISPLAY

material: cardboard
L 13 x H 12.5 x W 8 cm

6 PCS

WACHKIT2



UP TO 3 DEVICES



FAST CHARGE



SAFE CHARGING

Compatibility

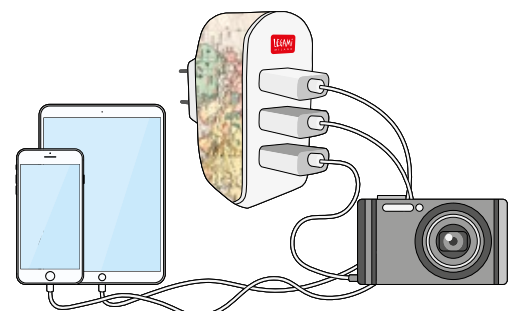

6-IN-1 KEYCHAIN CHARGING CABLE

L 7 cm (closed) - L 14 cm (opened)

6-IN-1 KEYCHAIN CHARGING CABLE

- Can be used for data transfer and charging*
- It is also possible to transfer the charge from one device to another
- Material: TPE, ABS

CAVO DI RICARICA PORTACHIAVI 6 IN 1

- Può essere utilizzato per il trasferimento dei dati e per la ricarica*
- È anche possibile trasferire la carica da un dispositivo all'altro
- Materiale: TPE, ABS

CÂBLE DE RECHARGE PORTE-CLÉS 6-EN-1

- Il peut être utilisé pour le transfert des données et pour la recharge*
- Il est aussi possible de transférer la charge d'un appareil à l'autre
- Matériau : TPE, ABS

CABLE DE RECARGA LLAVERO 6 EN 1

- Puede utilizarse para transferir datos y para la carga*
- También es posible transferir la carga de un dispositivo a otro
- Material: TPE, ABS

6-IN-1-LADEKABEL ALS SCHLÜSSELANHÄNGER

- Kann zur Datenübertragung und zum Aufladen verwendet werden*
- Kann auch zur Übertragung der Aufladung zwischen Geräten verwendet werden
- Material: TPE, ABS

*Does not support data storage

PACKAGING

carded
L 14.5 x H 9 x W 1 cm
SOLD X 6

UCC0009

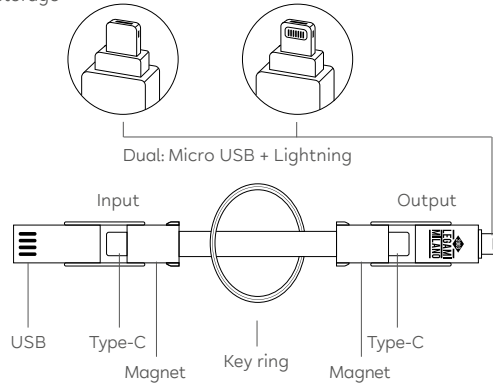

- Connections:
- USB to Micro USB
 - USB to Type-C
 - USB to Lightning
 - Type-C to Micro USB
 - Type-C to Type-C
 - Type-C to Lightning

THREE HUGS

L 120 cm

3-IN-1 CHARGING AND SYNCHRONIZATION CABLE

- 5 connectors: USB or Type-C, Micro-USB, Type-C and Lightning
- With Type-C - USB adapter
- Material: TPE

CAVO 3 IN 1 DI RICARICA E SINCRONIZZAZIONE

- 5 connettori: USB o Tipo-C, Micro-USB, Tipo-C e Lightning
- Con adattatore Tipo-C - USB
- Materiale: TPE

CÂBLE 3 EN 1 DE RECHARGE ET SYNCHRONISATION

- 5 connecteurs: USB ou type-C, micro-USB, type-C et Lightning
- Avec adaptateur type-C - USB
- Matériau : TPE

CABLE 3 EN 1 DE RECARGA Y SINCRONIZACIÓN

- 5 conectores: USB o Tipo C, Micro-USB, Tipo C y Lightning
- Con adaptador Tipo C - USB
- Material: TPE

3 IN 1 LADE- UND SYNCHRONISIERUNGSKABEL

- 5 Steckverbinder: USB oder Typ C, Micro-USB, Typ C und Lightning
- Mit Typ-C/USB-Adapter
- Material: TPE

PACKAGING

cardboard box
L 8.1 x H 17.5 x W 2.1 cm
SOLD X 4



USB or Type-C, Type-C, Micro USB and Lightning



Fast Charging



Rapid syncing

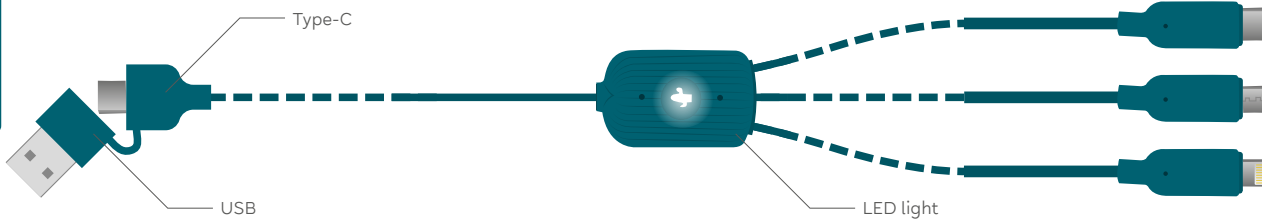

KITTY
CCA0002



CACTUS
CCA0003



CHARGE 'N ROLL

L 4 x H 6 x W 2 cm (TRC0001) - L 6 x H 4.5 x W 2 cm (TRC0002)

3-IN-1 RETRACTABLE CHARGING CABLE

- 4 connectors: USB, Type-C, Micro USB and Lightning
- Can be used for data syncing and for charging*
- Material: plastic, rubber

CAVO DI RICARICA 3 IN 1 RETRATTILE

- 4 connettori: USB, Tipo-C, Micro-USB e Lightning
- Può essere utilizzato per la sincronizzazione dei dati e per la ricarica*
- Materiale: plastica, gomma

CÂBLE DE CHARGE 3 EN 1 RÉTRACTABLE

- 4 connecteurs : USB, Type-C, Micro USB et Lightning
- Peut être utilisé pour la synchronisation des données et pour la charge*
- Matériau : plastique, caoutchouc

CABLE DE CARGA 3 EN 1 RETRÁCTIL

- 4 conectores: USB, Tipo C, Micro-USB y Lightning
- Se puede utilizar para sincronizar datos y cargar dispositivos*
- Material: plástico, goma

EINZIEHBARES LADEKABEL 3 IN 1

- 4 Steckverbinder: USB, Typ C, Micro-USB und Lightning
- Kann zur Datensynchronisierung und zum Aufladen genutzt werden*
- Material: Kunststoff, Gummi



Telescopic

*Does not support data storage

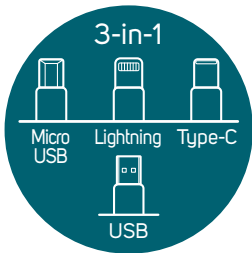

PACKAGING
carded
L 10.5 x H 12.5 x W 2.5 cm
SOLD X 4

PANDA
TRC0001



8 053610 784206



PACKAGING
carded
L 10.5 x H 12.5 x W 2.5 cm
SOLD X 4

RAINBOW
TRC0002



8 053610 784213



Compatibility

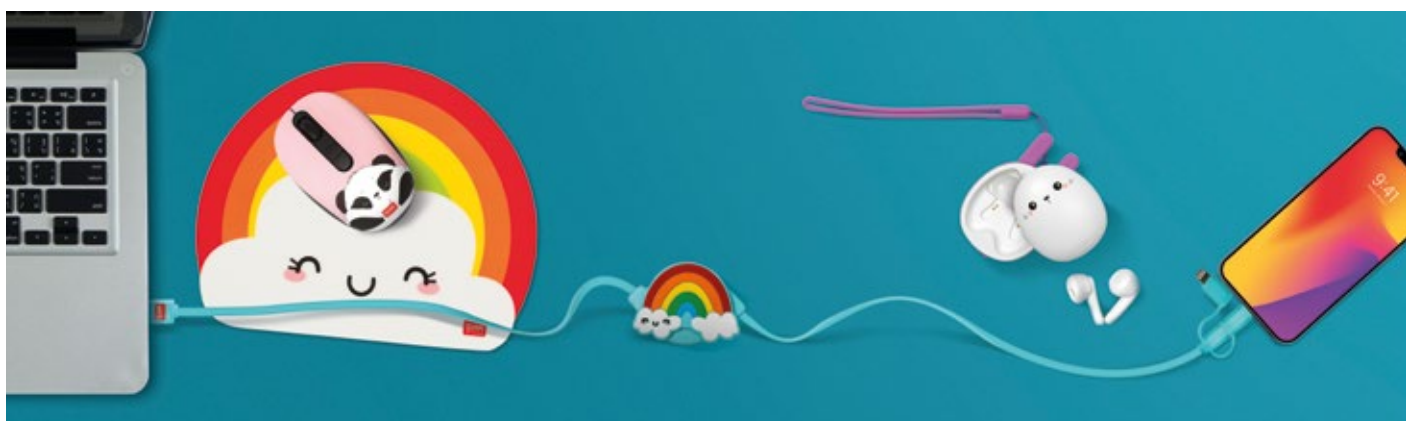

LINK UP

L MAX 5 x H MAX 16 x W MAX 4.2 cm (without hook)

CHARGING* MULTI CABLE

- 4 cables: USB, type-C, Micro USB and Lightning
- Material: metal, TPE, PVC. TPE coated cable

CAVO DI RICARICA* MULTIPLO

- 4 cavi: USB, Tipo-C, Micro-USB e Lightning
- Materiale: metallo, TPE, PVC. Cavo rivestito in TPE

CÂBLE DE RECHARGE* MULTIPLE

- 4 câbles : USB, Type-C, Micro USB et Lightning
- Matériau : métal, TPE, PVC. Câble revêtu en TPE

CABLE DE RECARGA* MÚLTIPLE

- 4 cables: USB, tipo C, Micro-USB y Lightning
- Material: metal, TPE, PVC. Cable revestido de TPE

MEHRFACH-LADEKABEL*

- 4 Kabel: USB, Typ C, Micro-USB und Lightning
- Material: Metall, TPE, PVC. Mit TPE beschichtetes Kabel

*Does not support data sync.

PACKAGING

carded
L 9 x H 20 x W
MAX 4.2 cm
SOLD X 3



* While stock lasts



AVOCADO
UCC0001



8 059174 833022



KOALA
UCC0003 *



8 059174 833046



8 BALL
UCC0004



8 059174 833985



PANDA
UCC0005



8 052461 964775



RAINBOW
UCC0006



8 052461 964782



FAN FOR PHONE

Ø 9 cm (fan blade)

MINI FAN

- For iPhones, smartphones and tablets
- With type-C USB, Micro USB and Lightning adapter
- Material: TPE

MINI VENTILATORE

- Per iPhone, smartphone e tablet
- Con adattatore USB Tipo-C, Micro-USB e Lightning
- Materiale: TPE

MINI VENTILATEUR

- Pour iPhones, smartphones et tablettes
- Avec adaptateur USB Type-C, Micro USB et Lightning
- Matériau : TPE

MINI VENTILADOR

- Para iPhones, smartphones y tabletas
- Con adaptador USB tipo C, Micro-USB y Lightning
- Material: TPE

MINI-VENTILATOR

- Für iPhones, Smartphones und Tablets
- Mit Adapter für USB Typ C, Micro-USB und Lightning
- Material: TPE



No batteries needed



Type-C USB, Micro USB and Lightning adapter



For iPhones, smartphones and tablets



PACKAGING
carded
L 6 x H 15 x W 3 cm

DISPLAY
material: cardboard
L 15.5 x H 23.8 x W 16.8 cm
12 PCS

FANKIT2



SELFIE QUEEN

L 5.5 x H 8 x W 3 cm

SELFIE LIGHT

- 32 high-power LEDs
- USB charging cable included
- Material: plastic

LUCE PER SELFIE

- 32 LED ad alta potenza
- Cavo di ricarica USB incluso
- Materiale: plastica

LUMIÈRE POUR SELFIE

- 32 LED à haute puissance
- Câble de recharge USB inclus
- Matériau : plastique

LUZ PARA SELFIS

- 32 LED de alta potencia
- Cable de carga USB incluido
- Material: plástico

SELFIE-LICHT

- 32 LEDs mit hoher Leistung
- Inklusive USB-Ladekabel
- Material: Kunststoff



8 colour effects

3 shades of light

3 brightness levels

Rechargeable

PACKAGING
window box
L 8.2 x H 16.8 x W 3.2 cm
SOLD X 4

SELF0001



ALWAYS TOGETHER

L 70 cm

UNIVERSAL

SMARTPHONE LANYARD

- Multifunction: adjustable lanyard with clasp.
- Can also be used for keys
- Does not block charging port
- Material: nylon, metal, TPU

CORDINO PORTA CELLULARE

- Multifunzione: cordino regolabile con gancio, utilizzabile anche come porta chiavi
- Non interferisce con l'ingresso del cavo di ricarica
- Materiale: nylon, metallo, TPU

CORDON PORTE-TÉLÉPHONE PORTABLE

- Multifonction : cordon réglable avec mousqueton, peut aussi être utilisé comme porte-clés
- N'interfère pas avec l'entrée du câble de charge
- Matériau : nylon, métal, TPU

CORDÓN PARA MÓVIL

- Multifuncional: cordón regulable con gancho, utilizable también como llavero
- No interfiere con la entrada del cable de carga
- Material: nailon, metal, TPU

HANDY-TRAGESCHLAUFE

- Multifunktional: verstellbare Schlaufe mit Haken, auch als Schlüsselanhänger verwendbar
- Behindert nicht den Anschluss des Ladekabels
- Material: Nylon, Metall, TPU



Metal clasp



Fabric lanyard



Strong and secure



Adhesive tab

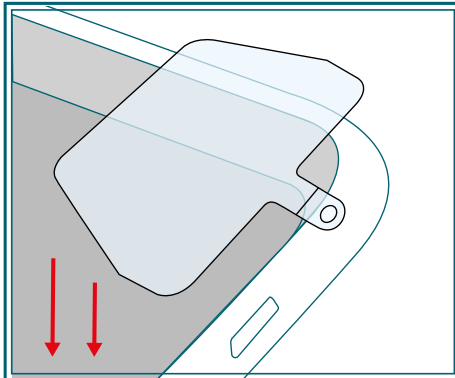

1. Position

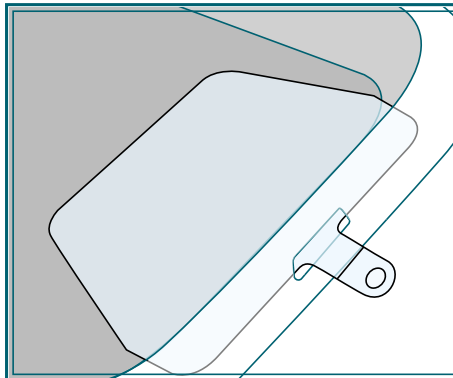

2. Insert

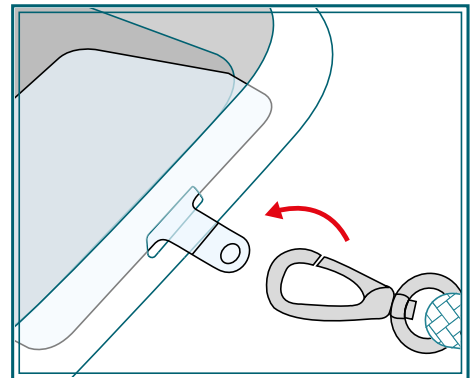

3. Attach

**PACKAGING**cardboard box
L 9 x H 15 x W 1.7 cm**SOLD X 6**

PHL0003 ROSE GOLD



8 054117 621391

**PACKAGING**cardboard box
L 9 x H 15 x W 1.7 cm**SOLD X 6**

PHL0004 NAVY BLUE



8 054117 621407



WATERPROOF SMARTPHONE POUCH

L 11.8 x H 24 x W 1 cm (without fabric cord)

WATERPROOF SMARTPHONE POUCH

- Hermetic seal
- Adjustable lanyard
- Touch friendly
- Materials: ABS, TPU, fabric

CUSTODIA IMPERMEABILE PER SMARTPHONE

- Chiusura ermetica
- Cordino regolabile
- Sensibilità touch screen
- Materiale: ABS, TPU, tessuto

ÉTUI IMPERMÉABLE POUR SMARTPHONE

- Fermeture hermétique
- Cordon réglable
- Sensibilité écran tactile
- Matériau : ABS, TPU, tissu

FUNDA IMPERMEABLE PARA SMARTPHONE

- Cierre hermético
- Cordón ajustable
- Compatible con pantalla táctil
- Material: ABS, TPU, tejido

WASSERDICHTE SCHUTZHÜLLE FÜR SMARTPHONE

- Hermetischer Verschluss
- Verstellbare Schlaufe
- Touchscreen-Empfindlichkeit
- Material: ABS, TPU, Stoff

**PACKAGING**

cardboard box

L 12 x H 27 x W 1.5 cm

SOLD X 4**KITTY****WPP0003**

8 054117 627799

**WATERPROOF SMARTPHONE POUCH**

L 10.7 x H 22 cm (without fabric cord)

WATERPROOF SMARTPHONE POUCH

- Hermetic seal
- Removable lanyard included
- Touch friendly
- Material: PVC, fabric

CUSTODIA IMPERMEABILE PER SMARTPHONE

- Chiusura ermetica
- Cordino removibile incluso
- Sensibilità touch screen
- Materiale: PVC, tessuto

ÉTUI IMPERMÉABLE POUR SMARTPHONE

- Fermeture hermétique
- Cordon amovible inclus
- Sensibilité écran tactile
- Matériau : PVC, tissu

FUNDA IMPERMEABLE PARA SMARTPHONE

- Cierre hermético
- Cordón extraíble incluido
- Compatible con pantalla táctil
- Material: PVC, tejido

WASSERDICHTE SCHUTZHÜLLE FÜR SMARTPHONE

- Hermetischer Verschluss
- Inklusive abnehmbarer Schlaufe
- Touchscreen-Empfindlichkeit
- Material: PVC, Stoff

* While stock lasts

**PACKAGING**

cardboard box

L 12 x H 27 x W 1.5 cm

SOLD X 4**BLUE****WPP0004** *

8 053610 784220



FLOATING WATERPROOF SMARTPHONE POUCH

L 13 x H 22 x W 1.5 cm (without fabric cord)
(WPP0006; WPP0007)
L 10.7 x H 22 x W 1.3 cm (without fabric cord)
(WPP0001; WPP0005)

FLOATING WATERPROOF SMARTPHONE POUCH

- Hermetic seal
- Removable lanyard included
- Touch friendly
- Material:
WPP0001, WPP0005: PVC, fabric
WPP0006: PVC, fabric, sponge
WPP0007: TPU, fabric, sponge

CUSTODIA IMPERMEABILE GALLEGGIANTE PER SMARTPHONE

- Chiusura ermetica
- Cordino removibile incluso
- Sensibilità touch screen
- Materiale:
WPP0001, WPP0005: PVC, tessuto
WPP0006: PVC, tessuto, spugna
WPP0007: TPU, tessuto, spugna

ÉTUI IMPERMEABLE ET FLOTTANT POUR SMARTPHONE

- Fermeture hermétique
- Cordon amovible inclus
- Sensibilité écran tactile
- Matériau :
WPP0001, WPP0005 : PVC, tissu
WPP0006 : PVC, tissu, éponge
WPP0007 : TPU, tissu, éponge

FUNDA IMPERMEABLE FLOTANTE PARA SMARTPHONE

- Cierre hermético
- Cordón extraíble incluido
- Compatible con pantalla táctil
- Material:
WPP0001, WPP0005: PVC, tejido
WPP0006: PVC, tejido, esponja
WPP0007: TPU, tejido, esponja

WASSERDICHTE SCHWIMMENDE SCHUTZHÜLLE FÜR SMARTPHONES

- Hermetischer Verschluss
- Inklusive abnehmbarer Schlaufe
- Touchscreen-Empfindlichkeit
- Material:
WPP0001, WPP0005: PVC, Stoff
WPP0006: PVC, Stoff, Schwamm
WPP0007: TPU, Stoff, Schwamm

* While stock lasts



PACKAGING
cardboard box
L 12 x H 27 x W 1.5 cm
SOLD X 4

DAISY
WPP0005



8 052694 011246



PACKAGING
cardboard box
L 12 x H 27 x W 1.5 cm
SOLD X 4

FLAMINGO
WPP0001 *



8 052461 961644





PACKAGING
cardboard box
L13.5 x H 27 x W 2.7 cm
SOLD X 4

WAVES
WPP0006



PACKAGING
cardboard box
L13.5 x H 27 x W 2.7 cm
SOLD X 4

HOLO FAIRY
WPP0007



KEY RING FOR AIRTAG

L 3.8 x H 5 cm

KEY RING FOR AIRTAG

- Does not interfere with the AirTag signal
- Material: silicone, metal

PORTACHIAVI PER AIRTAG

- Non influisce sul segnale dell'AirTag
- Materiale: silicone, metallo

PORTE-CLÉS POUR AIRTAG

- N'affecte pas le signal de l'AirTag
- Matériau : silicone, métal

LLAVERO PARA AIRTAG

- No influye en la señal del AirTag
- Material: silicona, metal

SCHLÜSSELANHÄNGER FÜR AIRTAG

- Keine Beeinflussung des AirTag-Signals
- Material: Silikon, Metall

PACKAGING

cardboard box
L 6 x H 12.5 x W 1.3 cm



KEYS



SUITCASE



BACKPACK

AirTag not included



DISPLAY

material: cardboard
L 6.4 x H 17.5 x W 9 cm
7 PCS

**PANDA
ATAKIT1**



DISPLAY

material: cardboard
L 6.4 x H 17.5 x W 9 cm
7 PCS

**CORGI
ATAKIT2**



DISPLAY

material: cardboard
L 6.4 x H 17.5 x W 9 cm
7 PCS

**GIN
ATAKIT3**



DISPLAY

material: cardboard
L 6.4 x H 17.5 x W 9 cm
7 PCS

**TRAVEL
ATAKIT4**



DISPLAY

material: cardboard
L 6.4 x H 17.5 x W 9 cm
7 PCS

**HEART
ATAKIT5**



DISPLAY

material: cardboard
L 6.4 x H 17.5 x W 9 cm
7 PCS

**RAINBOW
ATAKIT6**



DISPLAY

material: cardboard
L 6.4 x H 17.5 x W 9 cm
7 PCS

**AVOCADO
ATAKIT7**



SCREEN CLEANER

L MAX 3 x H MAX 3 x W MAX 0.1 cm

SCREEN CLEANER STICKERS

- Detachable and reusable
- Material: polyester, microfibre, silicone

ADESIVI PULISCI-SCHERMO

- Staccabili e riutilizzabili
- Materiale: poliester, microfibra, silicone

ADHÉSIFS DE NETTOYAGE POUR ÉCRANS

- Amovibles et réutilisables
- Matériau : polyester, microfibre, silicone

ADHESIVOS LIMPIAPANTALLAS

- Se pueden despegar y volver a utilizar
- Material: poliéster, microfibra, silicone

KLEBENDE DISPLAY-REINIGUNGSPADS

- Abnehmbar und wiederverwendbar
- Material: Polyester, Mikrofaser, Silikon

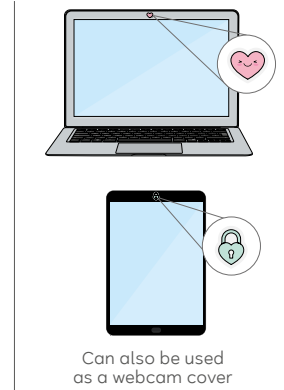

Can also be used as a webcam cover



PACKAGING
cardboard envelope
w/window
L 6.5 x H 14.7 x W 0.2 cm



DISPLAY
material: cardboard
L 7 x H 18.2 x W 6.5 cm
12 PCS

RAINBOW + AIR BALLOON
SCSKIT1



8 051128 754780



PACKAGING
cardboard envelope
w/window
L 6.5 x H 14.7 x W 0.2 cm

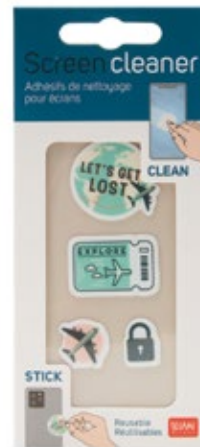

DISPLAY
material: cardboard
L 7 x H 18.2 x W 6.5 cm
12 PCS

TRAVEL
SCSKIT2



8 051128 754797



IPHONE 14 CLEAR CASE

iPhone not included

PHONE CASE

- Material: high quality TPU, dirt and scratch resistant

COVER CELLULARE

- Materiale: TPU di elevata qualità, resistente allo sporco e alle abrasioni

COQUE TÉLÉPHONE

- Matériau : TPU de haute qualité, résistant à la saleté et aux abrasions

CARCASA PARA MÓVIL

- Material: TPU de elevada calidad, resistente a la suciedad y a las abrasiones

HÜLLE FÜR PHONE

- Material: hochwertiges TPU, widerstandsfähig gegen Schmutz und Abrieb

* While stock lasts

SOLD X 2

ALLOWS ACCESS TO CONTROLS AND PORTS

SOFT TPU MATERIAL



14 PLUS

PACKAGING
carded
L 10 x H 20.5 cm



14 PRO MAX

PACKAGING
carded
L 10 x H 20.5 cm

FOR iPhone 14 PLUS



CCIPXIIIIM001 *



8 053610 782998



CCIPXIIIIM002 *



8 053610 783001

FOR iPhone 14 PRO MAX

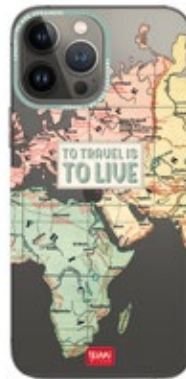

CCIPXIIIIPM001 *



8 053610 783032

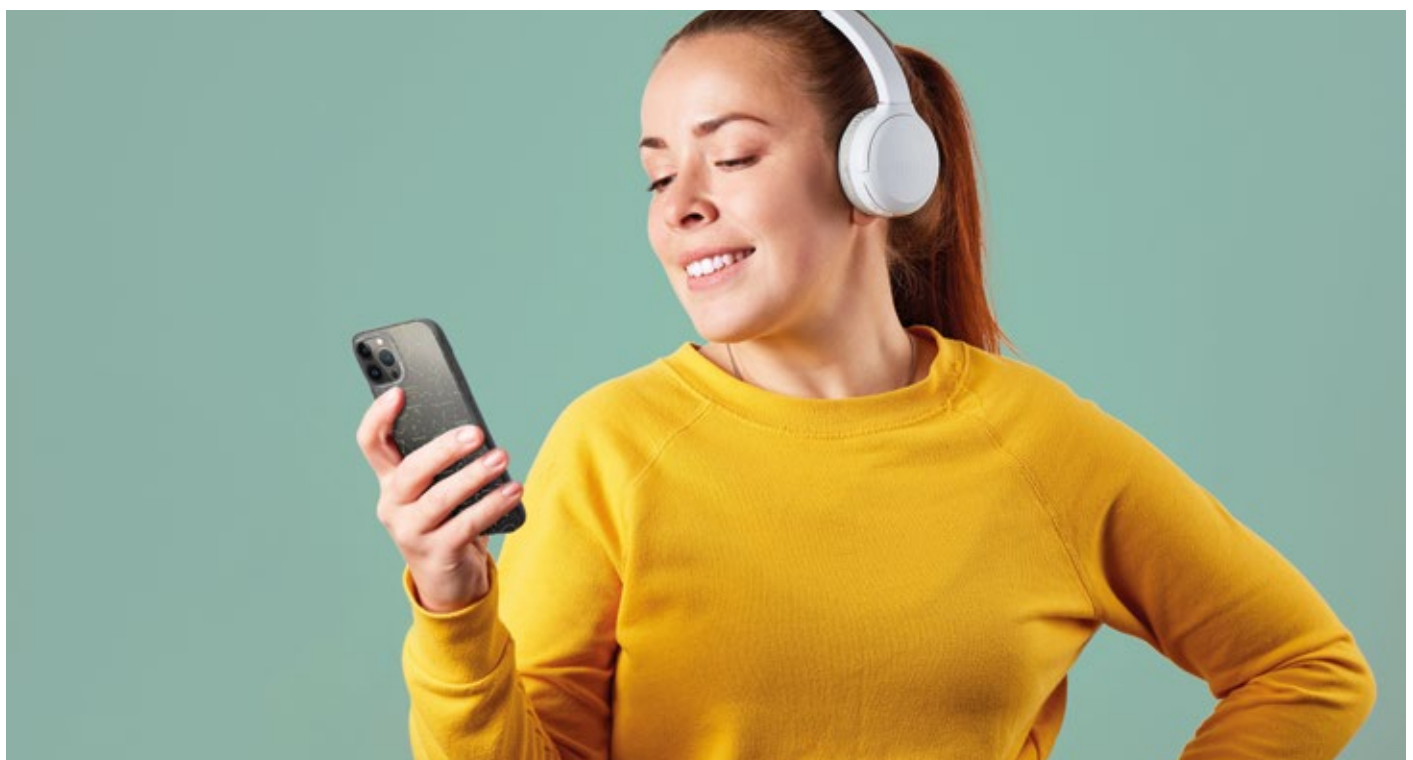

iPhone not included

IPHONE 12 CLEAR CASE

PHONE CASE

• Material: high quality TPU, dirt and scratch resistant

COVER CELLULARE

• Materiale: TPU di elevata qualità, resistente allo sporco e alle abrasioni

COQUE TÉLÉPHONE

• Matériau : TPU de haute qualité, résistant à la saleté et aux abrasions

CARCASA PARA MÓVIL

• Material: TPU de elevada calidad, resistente a la suciedad y a las abrasiones

HÜLLE FÜR PHONE

• Material: hochwertiges TPU, widerstandsfähig gegen Schmutz und Abrieb

* While stock lasts

SOLD X 2



12 MINI
PACKAGING
carded
L 9.7 x H 18.8 cm



12 PRO MAX
PACKAGING
carded
L 10.5 x H 20.5 cm

FOR iPhone 12 MINI

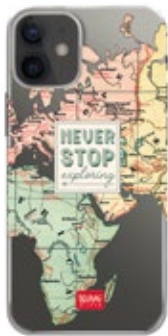

CCIPXIIM001 *



8 054320 560715



HOLO PRINT

CCIPXIIM005 *



8 054320 560753



CCIPXIIM006



8 054320 560760



SILVER FOIL

CCIPXIIM007



8 054320 560777



SILVER FOIL

CCIPXIIM008



8 054320 560784

FOR iPhone 12 PRO MAX



HOLO PRINT

CCIPXIIP005 *



8 054320 560913



CCIPXIIP006 *



8 054320 560920



SILVER FOIL

CCIPXIIP007



8 054320 560937



SILVER FOIL

CCIPXIIP008



8 054320 560944



iPhone not included

IPHONE 11 AND IPHONE X CLEAR CASE

PHONE CASE

• Material: high quality TPU, dirt and scratch resistant

COVER CELLULARE

• Materiale: TPU di elevata qualità, resistente allo sporco e alle abrasioni

COQUE TÉLÉPHONE

• Matériau : TPU de haute qualité, résistant à la saleté et aux abrasions

CARCASA PARA MÓVIL

• Material: TPU de elevada calidad, resistente a la suciedad y a las abrasiones

HÜLLE FÜR PHONE

• Material: hochwertiges TPU, widerstandsfähig gegen Schmutz und Abrieb

* While stock lasts

SOLD X 2



X/XS
PACKAGING
 carded
 L 10 x H 19 cm

FOR iPhone X/XS



CCIPX002 *



8 052783 612583

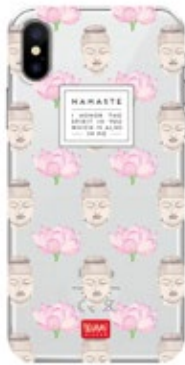

CCIPX007



8 052783 612637



CCIPX020



8 051739 306521



USB FLASH DRIVE

L MAX 4 x H MAX 4.8 x W MAX 2.5 cm

USB FLASH DRIVE

- USB interface: 3.0 (backward compatible with 2.0 USB ports)
- Material: soft PVC coating

CHIAVETTA USB

- Interfaccia USB: 3.0 (retrocompatibile con porte USB 2.0)
- Materiale: rivestimento in morbido PVC

CLÉ USB

- Interface USB : 3.0 (elle est rétrocompatible avec les ports USB 2.0)
- Matériau : revêtement en PVC doux

MEMORIA USB

- Interfaz USB: 3.0 (retrocompatible con puertos USB 2.0)
- Material: revestimiento en PVC blando

* While stock lasts

USB-STICK

- USB-Schnittstelle: 3.0 (abwärtskompatibel mit USB-Ports des Standards 2.0)
- Material: Beschichtung aus weichem PVC

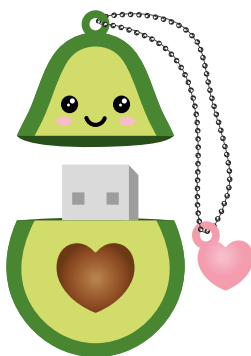

ULTRA FAST



USB INTERFACE

PACKAGING

carded
L 12.5 x H 8 x W MAX 2.7 cm
SOLD X 3



RAINBOW
USB0006



GIN
USB0007 *



AVOCADO
USB0008



PANDA
USB0009



WIRELESS MOUSE

L 5.5 x H 10 x W 3.5 cm

WIRELESS MOUSE WITH USB RECEIVER

- 2.4 GHz wireless optical mouse
- Ultra-compact USB receiver
- Three speed options: 800 DPI, 1200 DPI and 1600 DPI
- Material: ABS

MOUSE WIRELESS CON RICEVITORE USB

- Mouse ottico wireless 2,4 GHz
- Ricevitore USB ultra compatto
- Tre opzioni di velocità: 800 DPI, 1200 DPI e 1600 DPI
- Materiale: ABS

SOURIS SANS FIL AVEC RÉCEPTEUR USB

- Souris optique sans fil 2,4 GHz
- Récepteur USB ultracompact
- Trois options de vitesse : 800 DPI, 1200 DPI et 1600 DPI
- Matériau : ABS

RATÓN INALÁMBRICO CON RECEPTOR USB

- Ratón óptico inalámbrico 2,4 GHz
- Receptor USB ultracompacto
- Tres opciones de velocidad: 800 DPI, 1200 DPI y 1600 DPI
- Material: ABS

KABELLOSE MAUS MIT USB-EMPFÄNGER

- Optische, kabellose Maus mit 2,4 GHz
- Ultrakompakter USB-Empfänger
- Drei Geschwindigkeitsstufen: 800 DPI, 1200 DPI und 1600 DPI
- Material: ABS

PACKAGING
window box
w/hook
L 12.2 x H 21 x
W 4.5 cm
SOLD X 4



* While stock lasts



USB 2.0 interface



Nano receiver included



Ambidextrous design



Wireless connection



TRAVEL
WM00001



8 054320 561019

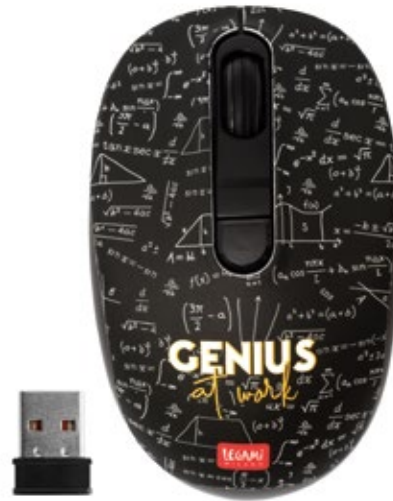

GENIUS
WM00002



8 054320 561026



FLORA
WM00003 *



8 054320 561033



PANDA
WM00004



8 054320 561040



DAISY
WM00005



8 053610 781878

WARM IT UP

L MAX 10 x H MAX 10 cm

USB MUG WARMER

- Ideal for mugs or glasses with a flat bottom
- Keeps your drinks hot
- Material: vinyl

SCALDA TAZZA USB

- Ideale per tazze o bicchieri con fondo piatto
- Mantiene le tue bevande calde
- Materiale: vinile

CHAUFFE-TASSE USB

- Idéal pour les tasses ou les verres à fond plat
- Maintient vos boissons chaudes
- Matériau : vinyle

CALENTADOR DE TAZA USB

- Ideal para tazas o vasos con fondo plano
- Mantiene tus bebidas calientes
- Material: vinilo

USB-TASSENWÄRMER

- Ideal für Tassen oder Gläser mit flachem Boden
- Hält Ihre Getränke warm
- Material: Vinyl

PACKAGING

window box
L 15 x H 15.5 x W 2.5 cm
SOLD X 3



PANDA
WIU0001



8 051122 263790



No batteries needed



For Windows and Mac



COOKIE
WIU0003



8 051122 263813



KITTY
WIU0006



8 052783 616536



HANGOVER
WIU0007



8 054117 621414



EGG
WIU0008



8 054117 621421



RAINBOW
WIU0009



8 054117 621438



HEART
WIU0010



8 053610 782851

MOUSEPAD

L 21 x H 18 cm

MOUSEPAD

- Material: dust-proof and anti-glare PVC surface; 2,5 mm anti-slip rubber base

TAPPETINO PER MOUSE

- Materiale: superficie antipolvere e antiriflesso in PVC; base in gomma antiscivolo da 2,5 mm

TAPIS DE SOURIS

- Matériau : surface anti-poussière et antireflet en PVC ; base en caoutchouc antidérapant d'une épaisseur de 2,5 mm

ALFOMBRILLA PARA RATÓN

- Material: superficie antipolvo y antirreflejo de PVC; base de goma antideslizante de 2,5 mm

MOUSEPAD

- Material: Anti-Staub- und Anti-Reflex-Oberfläche aus PVC; Basis aus rutschfestem Gummi mit einer Stärke von 2,5 mm

* While stock lasts

PACKAGING

carded
L 23,5 x H 22 x W 0,4 cm
SOLD X 2



WORLD CITIES COLLECTION



BERGAMO

MOU0014 *



8 052783 616376

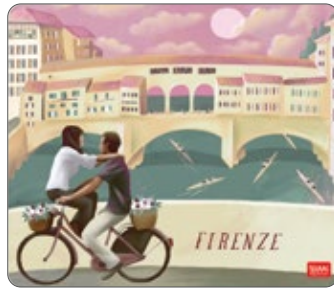

FIRENZE

MOU0015



8 052783 616383



ROMA

MOU0017



8 052783 616406

APHORISMS COLLECTION

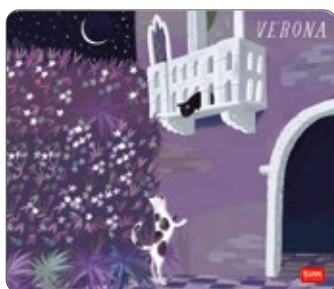

VERONA

MOU0019 *



8 052783 616420



AIR BALLOON

MOU0001



8 056304 482327



TRAVEL

MOU0010



8 051122 263615



BOSS

MOU0011



8 051122 263622



DAISY

MOU0030



8 052694 002053

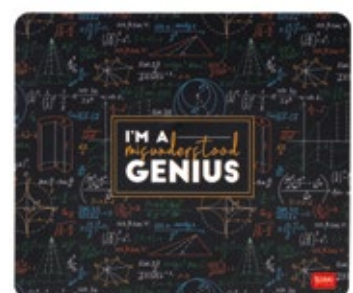

GENIUS

MOU0031



8 052694 002060

MOUSEPAD

L MAX 22.3 x H MAX 23.3 cm

MOUSEPAD

- Material: dust-proof and anti-glare PVC surface; 2.5 mm anti-slip rubber base

TAPPETINO PER MOUSE

- Materiale: superficie antipolvere e antiriflesso in PVC; base in gomma antiscivolo da 2,5 mm

TAPIS DE SOURIS

- Matériau : surface anti-poussière et antireflet en PVC; base en caoutchouc antidérapant d'une épaisseur de 2,5 mm

ALFOMBRILLA PARA RATÓN

- Material: superficie antipolvo y antirreflejo de PVC; base de goma antideslizante de 2,5 mm

MOUSEPAD

- Material: Anti-Staub- und Anti-Reflex-Oberfläche aus PVC; Basis aus rutschfestem Gummi mit einer Stärke von 2,5 mm

PACKAGING

carded
L MAX 25 x H MAX 27.8 x W 0.4 cm
SOLD X 2



SUPER CUTE COLLECTION



VINYL

MOU0024



8 054320 566724



EGG

MOU0025



8 054320 566731



PANDA

MOU0026



8 054320 566748



RAINBOW

MOU0027



8 054320 566755



KITTY

MOU0028



8 054320 566762



AVOCADO

MOU0029



8 054320 566779

BLOW AWAY

L 16 x H 8 x W 5.5 cm

MINI USB BLOWER

- Connects directly to any USB port
- Useful for cleaning keyboards, monitors, PC fans and the general area surrounding a PC
- Material: plastic

MINI SOFFIATORE USB

- Si collega direttamente ad una qualsiasi presa USB
- Utile per la pulizia di tastiere, monitor, ventole PC ed in generale l'area intorno al PC
- Materiale: plastica

MINI SOUFFLEUR USB

- À brancher directement à une prise USB
- Idéal pour nettoyer les claviers, les écrans, les ventilateurs d'ordinateur et en général la zone autour de l'ordinateur
- Matériau : plastique

MINISOPLADOR USB

- Se conecta directamente a cualquier toma USB
- Útil para la limpieza de teclados, monitores, ventiladores de ordenadores y el área del ordenador en general
- Material: plástico

MINI-GEBLÄSE MIT USB-ANSCHLUSS

- Lässt sich direkt mit jedem USB-Anschluss verbinden
- Nützlich für die Reinigung von Tastaturen, Monitoren, PC-Lüftern und allgemein für den Bereich um den Computer
- Material: Kunststoff



For Windows and Mac



Cable length: 150 cm



No batteries needed



PACKAGING
cardboard box
L 15 x H 10.5 x W 5.5 cm
SOLD X 4

MB0002



NEAT 'N CLEAN

L 14 x H 5.5 x W 4.5 cm

MINI USB VACUUM CLEANER

- Connects directly to any USB port
- Useful for cleaning keyboards and the general area surrounding a PC
- Includes 2 accessories: a brush and a flexible rubber nozzle
- Material: plastic

MINI ASPIRAPOLVERE USB

- Si collega direttamente ad una qualsiasi presa USB
- Utile per la pulizia di tastiere ed in generale l'area intorno al PC
- Include 2 accessori: spazzolina e bocchetta in gomma flessibile
- Materiale: plastica

MINI ASPIRATEUR USB

- À brancher directement à une prise USB
- Idéal pour nettoyer les claviers et en général la zone autour de l'ordinateur
- 2 accessoires inclus : brosse et buse flexible en caoutchouc
- Matériau : plastique

MINI ASPIRADORA USB

- Se conecta directamente a cualquier toma USB
- Útil para la limpieza de teclados y el área del ordenador en general
- Incluye 2 accesorios: mini cepillo y boquilla de goma flexible
- Material: plástico

MINI-STAUBSAUGER MIT USB-ANSCHLUSS

- Lässt sich direkt mit jedem USB-Anschluss verbinden
- Nützlich für die Reinigung von Tastaturen und allgemein für den Bereich um den Computer
- Inklusive 2 Accessoires: Bürstchen und Saugaufsatz aus flexiblem Gummi
- Material: Kunststoff



For Windows and Mac



Cable length: 150 cm



No batteries needed



PACKAGING
cardboard box
L 15 x H 9.5 x W 5.2 cm
SOLD X 4

MVC0001



CACTUS USB HUB

L 6 x H 7.3 cm

4-PORT USB HUB

- Allows data synchronization
- Compatible with USB 1.0/1.1/2.0
- Connects up to 4 devices at the same time
- Material: PVC

HUB USB A 4 PORTE

- Consente la sincronizzazione dati
- Compatible with USB 1.0/1.1/2.0
- Connetti fino a 4 periferiche contemporaneamente
- Materiale: PVC

HUB USB À 4 PORTS

- Il permet la synchronisation des données
- Compatible avec USB 1.0 / 1.1 / 2.0
- Connectez jusqu'à 4 périphériques simultanément
- Matériau : PVC

HUB USB CON 4 PUERTOS

- Permite la sincronización de datos
- Compatible con USB 1.0/1.1/2.0
- Conecta hasta 4 periféricos a la vez
- Material: PVC

USB-HUB MIT 4 PORTS

- Ermöglicht die Datensynchronisierung
- Kompatibel mit USB 1.0/1.1/2.0
- Schließen Sie bis zu 4 Peripheriegeräte gleichzeitig an
- Material: PVC



For Windows and Mac



Cable length: 50 cm

PACKAGING

window box w/hook
L 8 x H 14.5 x W 4 cm
SOLD X 4

MUA0003



MINI USB HUB

L 12.2 x H 2.2 x W 2.8 cm

4-PORT USB HUB

- Allows data synchronization
- Compatible with USB 1.0/1.1/2.0
- Connects up to 4 devices at the same time
- Material: plastic

HUB USB A 4 PORTE

- Consente la sincronizzazione dati
- Compatible with USB 1.0/1.1/2.0
- Connetti fino a 4 periferiche contemporaneamente
- Materiale: plastica

HUB USB À 4 PORTS

- Il permet la synchronisation des données
- Compatible avec USB 1.0/1.1/2.0
- Connectez jusqu'à 4 périphériques simultanément
- Matériau : plastique

HUB USB CON 4 PUERTOS

- Permite la sincronización de datos
- Compatible con USB 1.0/1.1/2.0
- Conecta hasta 4 periféricos a la vez
- Material: plástico

USB-HUB MIT 4 PORTS

- Ermöglicht die Datensynchronisierung
- Kompatibel mit USB 1.0/1.1/2.0
- Schließen Sie bis zu 4 Peripheriegeräte gleichzeitig an
- Material: Kunststoff



For Windows and Mac



Cable length: 56 cm

PACKAGING

PET box w/hook
L 13.7 x H 5.7 x W 3 cm
SOLD X 5



MUA0001 BLACK



8 058093 949609

LAPTOP TRAY

L 44 x H 33.5 x W 4 cm

LAPTOP TRAY

- Also perfect as a tablet holder
- Soft cushion with padding
- Material: MDF, polyester.
- Padding: 100% polystyrene

SUPPORTO PER COMPUTER PORTATILE

- Perfetto anche come supporto per tablet
- Morbido cuscino con imbottitura
- Materiale: MDF, poliestere.
- Imbottitura: 100% polistirene

SUPPORT POUR ORDINATEUR PORTABLE

- Support également parfait pour les tablettes
- Coussin moelleux avec rembourrage
- Matériau : MDF, polyester.
- Rembourrage : 100 % polystyrène

BANDEJA PARA ORDENADOR PORTÁTIL

- Perfecta también como soporte para tabletas
- Cojín blando con relleno
- Material: MDF, poliéster.
- Relleno: 100 % poliestireno

LAPTOPKISSEN

- Auch als Tabletkissen perfekt geeignet
- Weiches Kissen mit Füllung
- Material: MDF, Polyester.
- Füllung: 100 % Polystyrol

PACKAGING
cardboard belly band
SOLD X 2



TRAVEL
LDESK001



8 059174 839987



PANDA
LDESK002



8 059174 839994



STARS
LDESK003



8 054320 565031



GENIUS
LDESK004



8 053610 782011



USE BOTH HORIZONTALLY AND VERTICALLY

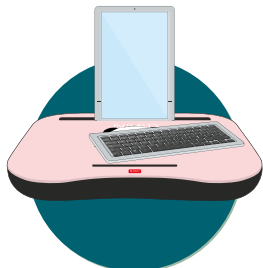

MAGNETIC CLIP

L MAX 4.8 x H MAX 3.3 x W 1 cm (closed)

MAGNETIC CLIP

- Ideal for keeping your cables tidy
- Material: silicone, magnet

CLIP MAGNETICA

- Ideale per tenere i cavi ordinati
- Materiale: silicone, magnete

CLIP MAGNÉTIQUE

- Idéal pour garder les câbles ordonnés
- Matériau : silicone, aimant

CLIP MAGNÉTICO

- Ideal para mantener los cables ordenados
- Material: silicona, imán

MAGNETISCHER CLIP

- Ideal, um Kabel zu ordnen
- Material: Silikon, Magnet

* While stock lasts

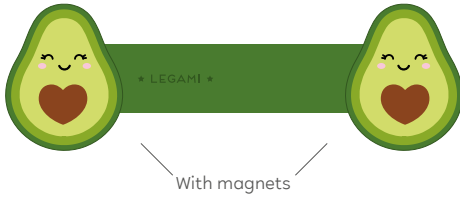

With magnets

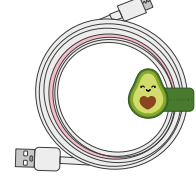
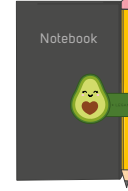
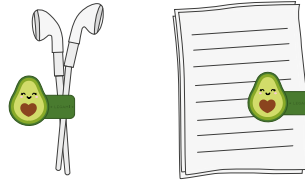

PACKAGING
carded
L 9 x H 12 cm x W 1 cm



DISPLAY
material: cardboard
L 10.6 x H 16.8 x W 8.4 cm
6 PCS

HEART
CATYHEAKIT1 *
8 051128 755343



PACKAGING
carded
L 9 x H 12 cm x W 1 cm



DISPLAY
material: cardboard
10.6 x H 16.8 x W 8.4 cm
6 PCS

AVOCADO
CATYAVOKIT2
8 051128 755350



PACKAGING
carded
L 9 x H 12 cm x W 1 cm



DISPLAY
material: cardboard
10.6 x H 16.8 x W 8.4 cm
6 PCS

RAINBOW
CATYRNBKIT3
8 051128 755367



PACKAGING
carded
L 9 x H 12 cm x W 1 cm



DISPLAY
material: cardboard
10.6 x H 16.8 x W 8.4 cm
6 PCS

CACTUS
CATYCAKIT4
8 051128 755374



CABLE TIES

L 18 x H 2 cm

SET OF 8 CABLE TIES

- Material: polyester, nylon

SET DI 8 FASCETTE STRINGICAVO

- Materiale: poliester, nylon

SET DE 8 ATTACHE-CÂBLES

- Matériau : polyester, nylon

SET DE 8 BRIDAS PARA SUJETAR CABLES

- Material: poliéster, nailon

SET MIT 8 KABELBINDERN

- Material: Polyester, Nylon

PACKAGING

carded

L 11 x H 16,5 cm

SOLD X 8

VE0002



WEBCAM COVER

2 small covers: L 0.9 x H 1.8 x W 0.01 cm

1 big cover: L 1.2 x H 2.9 x W 0.01 cm

SET OF 3 WEBCAM COVERS

- Material: ABS, 3M adhesive

SET DI 3 COVER PER WEBCAM

- Materiale: ABS, adesivo 3M

SET DE 3 CACHES WEBCAM

- Matériau : ABS, adhésif 3M

SET DE 3 FUNDAS PARA WEBCAM

- Material: ABS, adhesivo 3M

SET MIT 3 ABDECKUNGEN FÜR WEBCAM

- Material: ABS, 3M-Klebstoff

PACKAGING

carded

L 6.5 x H 12 x W 0.5 cm



DISPLAY

material: cardboard

L 16 x H 17 x W 8 cm

12 PCS

WECKIT1

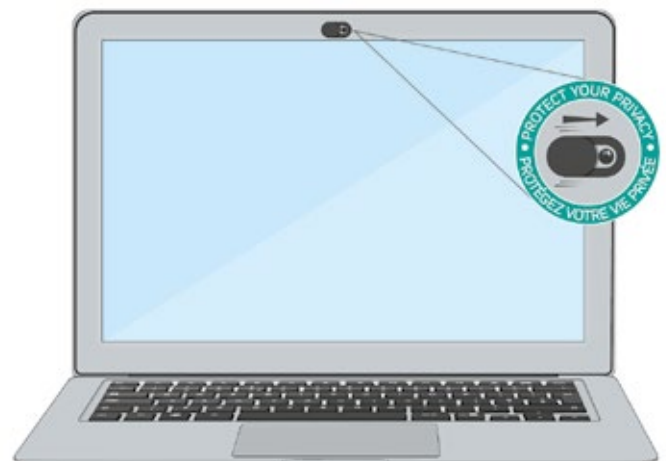

TABLET SLEEVE

L 22 x H 15,5 x W 2 cm

UNIVERSAL SLEEVE FOR TABLETS

- With metal zip and slider
- Material: external nylon covering, padded material interior

CUSTODIA UNIVERSALE PER TABLET

- Con cerniera e cursore in metallo
- Materiale: rivestimento esterno in Nylon, interno in materiale imbottito

POCHETTE UNIVERSELLE POUR TABLETTE

- Avec fermeture et glissière en métal
- Matériau : revêtement extérieur en nylon, intérieur en matériau rembourré

FUNDA UNIVERSAL PARA TABLETAS

- Con cremallera y cursor de metal
- Material: revestimiento exterior en nailon, interior en material acolchado

UNIVERSALE HÜLLE FÜR TABLETS

- Mit Reißverschluss und Schieber aus Metall
- Material: Außenmaterial aus Nylon, gepolstertes Innenfutter

MINI TABLET SLEEVE 6"-7"

For tablets and iPads from 6 to 7 inches in size

PACKAGING

window box
L 22,5 x H 19,6 x W 2,8 cm
SOLD X 1



DREAM CATCHER
SLM0001



8 056304 482525



GENIUS
SLM0002



8 056304 482532



FLOWERS
SLM0004



8 056304 482556

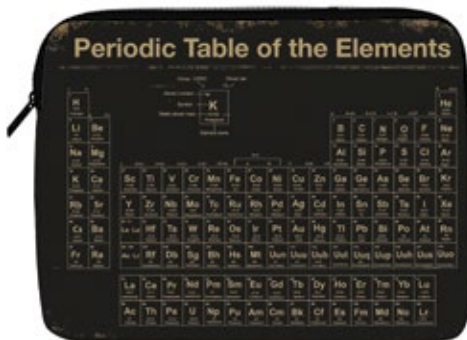

ELEMENTS
SLM0005



8 056304 482563



DONUT
SLM0006



8 056304 482570



CACTUS
SLM0007



8 056304 482587



AFTER RAIN
SLM0008



8 056304 482594

BE FREE

L 5.5 x H MAX 8.5 x W 3 cm

WIRELESS EARBUDS

- Touch sensor
- Up to 5 hours of playing time
- Built-in dual microphone
- Material: ABS, silicone

AURICOLARI WIRELESS

- Sensore touch
- Fino a 5 ore di riproduzione
- Doppio microfono integrato
- Materiale: ABS, silicone

ÉCOUTEURS SANS FIL

- Capteur tactile
- Jusqu'à 5 heures de reproduction
- Double microphone intégré
- Matériau : ABS, silicone

AURICULARES INALÁMBRICOS

- Sensor táctil
- Hasta 5 horas de reproducción
- Doble micrófono integrado
- Material: ABS, silicona

WIRELESS-EARBUD-KOPFHÖRER

- Berührungssensor
- Bis zu 5 Stunden Spielzeit
- Doppeltes, integriertes Mikrofon
- Material: ABS, Silikon

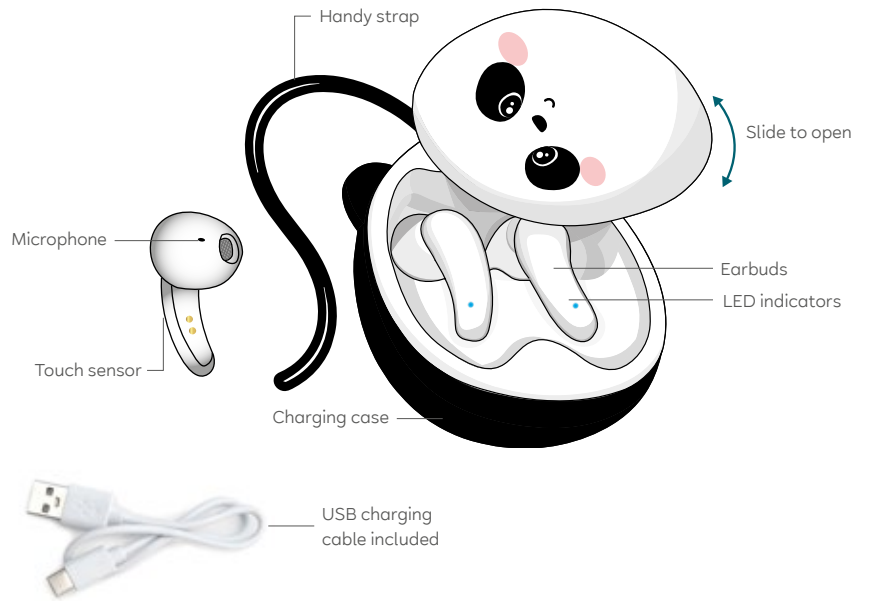

PACKAGING
cardboard box
L 9 x H 12.5 x W 3.5 cm
SOLD X 4

PANDA
EAR0001



PACKAGING
cardboard box
L 9 x H 12.5 x W 3.5 cm
SOLD X 4

KITTY
EAR0002



Built-in dual microphone



Compatibility: iOS and Android



Lightweight and practical



Autopairing



High-quality audio and voice



Up to 5 hours of playing time

AIR 'N GO

CASE AND CORD SET FOR AIRPODS

- Includes three pieces: case, cord and carabiner
- Material: silicone, aluminium carabiner

SET CUSTODIA E CORDINO PER AIRPODS

- Include tre pezzi: custodia, cordino per collo e moschettone
- Materiale: silicone, moschettone in alluminio

SET DE ÉTUI ET CORDON POUR AIRPODS

- Il comprend : étui, cordon et mousqueton
- Matériau : silicone, mousqueton en aluminium

SET DE FUNDA Y CORDÓN PARA AIRPODS

- Incluye tres piezas: funda, cordón para el cuello y mosquetón
- Material: silicona, mosquetón de aluminio

SET MIT HÜLLE UND BAND FÜR AIRPODS

- Enthält drei Teile: Hülle, Band zum Umhängen und Karabinerhaken
- Material: Silikon, Karabinerhaken aus Aluminium

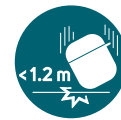
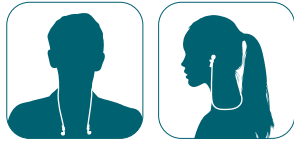

Shock resistant



Water resistant



Wireless charging compatible

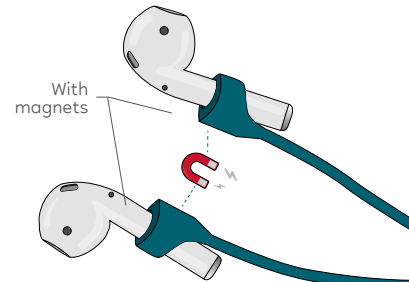
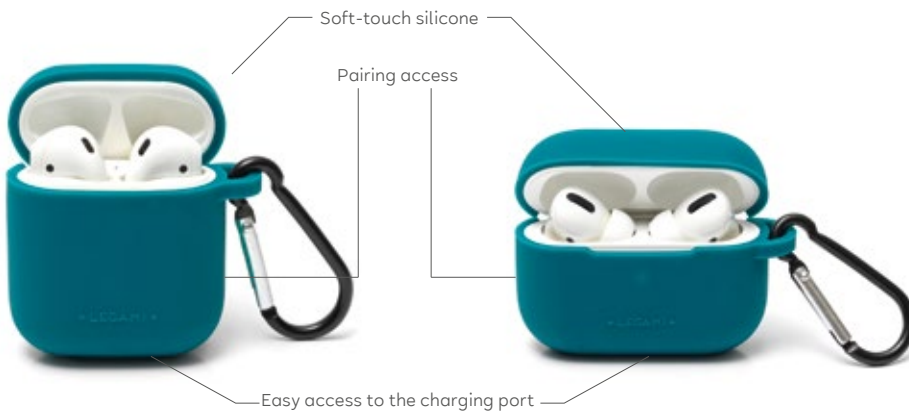

Strap length: 73 cm

*AirPods and charging case not included

FOR AIRPODS 1&2



PACKAGING
carded
L 11 x H 14.5 x W 2.7 cm
SOLD X 6



AIR0001 PETROL BLUE
8 054320 561279

AIR0002 TURQUOISE
8 054320 561286

FOR AIRPODS PRO



PACKAGING
carded
L 11 x H 15.5 x W 2.7 cm
SOLD X 6



AIR0003 PETROL BLUE
8 054320 561293

AIR0004 TURQUOISE
8 054320 561309

THE SOUND OF CUTENESS

L 6 x H 8 x W 5 cm

WIRELESS SPEAKER WITH STAND

- Two connection options: cable and wireless
- Compatible with all devices with wireless technology
- Material: plastic

SPEAKER WIRELESS CON SUPPORTO

- Doppia modalità di connessione: cavo e wireless
- Compatibile con tutti i dispositivi con tecnologia wireless
- Materiale: plastica

BAFFLE SANS FIL AVEC SUPPORT

- Deux solutions de connexion différentes : sans fil et câble
- Compatible avec tous les appareils munis de technologie sans fil
- Matériau : plastique

ALTAVOZ INALÁMBRICO CON SOPORTE

- Doble modalidad de conexión: inalámbrica y por cable
- Compatible con todos los dispositivos con tecnología inalámbrica
- Material: plástico

WIRELESS- SPEAKER MIT HALTERUNG

- Zwei Verbindungsmodi: mit Kabel und wireless
- Kompatibel mit allen Geräten mit Wireless-Technologie
- Material: Kunststoff



Phone stand and speaker



USB rechargeable



Two connection options: wireless and cable

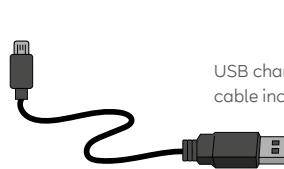
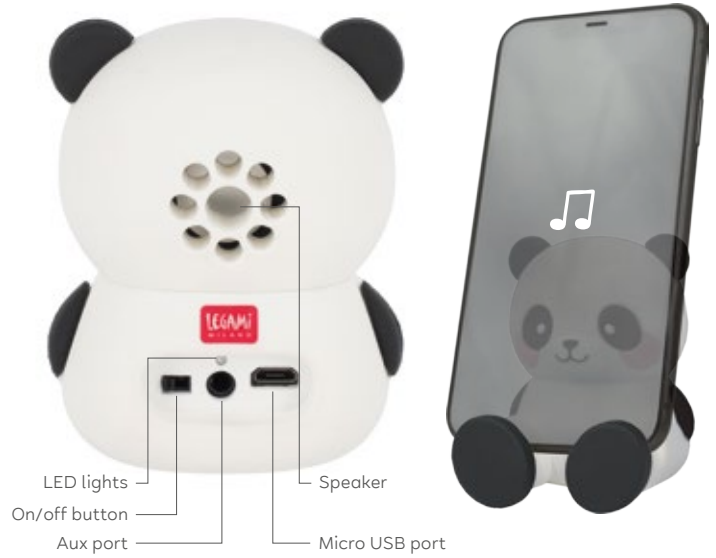

USB charging cable included

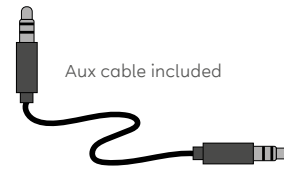

Aux cable included



PACKAGING
cardboard box w/hook
L 8.8 x H 13 x W 5.8 cm
SOLD X 4

PANDA
SPS0001

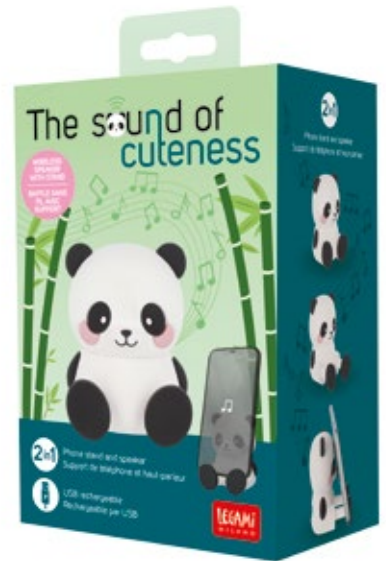

PACKAGING
cardboard box w/hook
L 8.8 x H 13 x W 5.8 cm
SOLD X 4

TEDDY BEAR
SPS0002



PUMP UP THE VOLUME

Ø 4.3 cm, H 4.8 cm (MSP0001);
 Ø 4.3 cm, L 5.8 x H 5 cm (MSP0002)

MINI WIRELESS HANDS-FREE SPEAKER

- Takes selfies remotely
- Compatible with all devices with wireless technology
- Material: external coating in rubber, interior in plastic

MINI VIVAVOCE E SPEAKER WIRELESS

- Scatta selfie da remoto
- Compatibile con tutti i dispositivi con tecnologia wireless
- Materiale: rivestimento esterno in gomma, interno in plastica

MINI HAUT-PARLEUR ET BAFFLE SANS FIL

- Il permet de prendre des selfies à distance
- Compatible avec tous les appareils munis de technologie sans fil
- Matériau : revêtement extérieur en caoutchouc, intérieur en plastique

MINI MANOS LIBRES Y ALTAVOZ INALÁMBRICO

- Echo selfis a distancia
- Compatible con todos los dispositivos con tecnología inalámbrica
- Material: revestimiento exterior de goma, interior de plástico

KABELLOSE MINI-FREISPRECHERINRICHTUNG UND -SPEAKER

- Kann Selfies aus der Ferne aufnehmen
- Kompatibel mit allen Geräten mit Wireless-Technologie
- Material: Außenmaterial Gummi, Innenmaterial Kunststoff



USB rechargeable

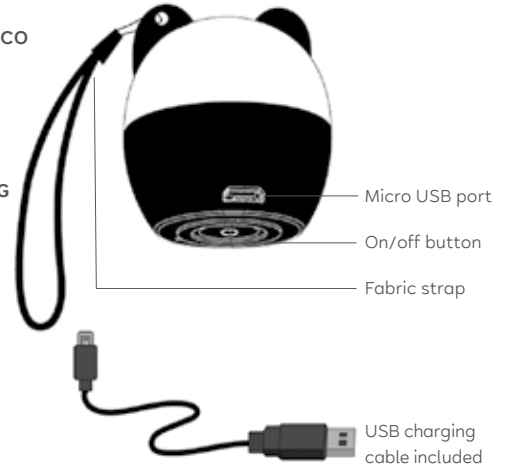

PACKAGING

cardboard box w/hook
 L 8 x H 15.5 x W 4.5 cm

SOLD X 2

PANDA

MSP0001



8 051739 306279

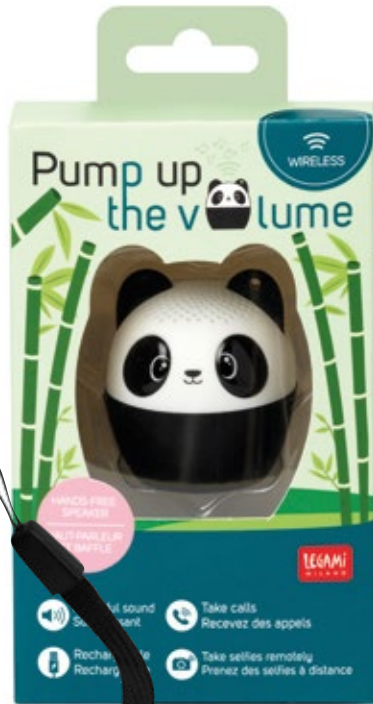

PACKAGING

cardboard box w/hook
 L 8 x H 15.5 x W 4.5 cm

SOLD X 2

CACTUS

MSP0002



8 054117 621384

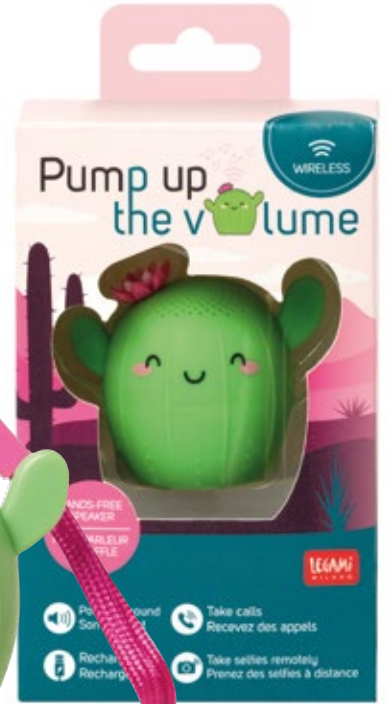

SINGING IN THE SHOWER

L 9 x H MAX 8.5 x W 5 cm

WATER-RESISTANT WIRELESS HANDS-FREE SPEAKER

- Compatible with all devices with wireless technology
- Material: silicone, ABS

VIVAVOCE E SPEAKER WIRELESS RESISTENTE ALL'ACQUA

- Compatibile con tutti i dispositivi con tecnologia wireless
- Materiale: silicone, ABS

HAUT-PARLEUR ET BAFFLE SANS FIL RÉSISTANT À L'EAU

- Compatible avec tous les dispositifs munis de technologie sans fil
- Matériau : silicone, ABS

MANOS LIBRES Y ALTAVOZ INALÁMBRICO RESISTENTE AL AGUA

- Compatible con todos los dispositivos con tecnología inalámbrica
- Material: silicona, ABS

WASSERFESTE KABELLOSE-FREISPRECHERICHTUNG UND -SPEAKER

- Kompatibel mit allen Geräten mit Kabellose -Technologie
- Material: Silikon, ABS

* While stock lasts

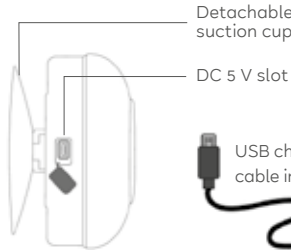
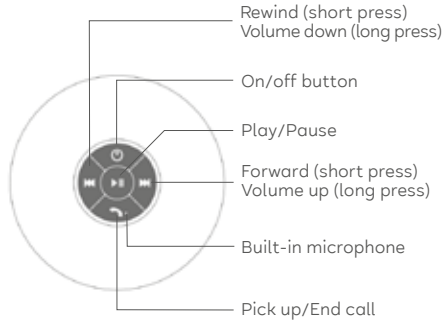

PACKAGING

window box w/hook
L 10 x H 15 x W 5.5 cm

SOLD X 2



USB rechargeable



SLOTH
SHOW0001



TRAVEL
SHOW0003



AFTER RAIN
SHOW0005



FLORA
SHOW0007 *



HEART
SHOW0008



KITTY
SHOW0009



ME & YOU**AUDIO SPLITTER**

- A 3.5 mm jack input that doubles into two audio outputs
- Material: soft plastic exterior, ABS and metal interior

SDOPPIATORE AUDIO

- Un ingresso jack da 3,5 mm che si sdoppia in due uscite audio
- Materiale: esterno in plastica morbida, interno in ABS e metallo

DOUBLEUR D'ÉCOUTEURS

- Une entrée jack de 3,5 mm se partageant en deux sorties audio
- Matériau : extérieur en plastique doux au toucher, intérieur en ABS et en métal

DIVISOR DE AURICULARES

- Un conector jack de 3,5 mm que se bifurca en dos salidas de audio
- Material: exterior de plástico blando, interior de ABS y metal

AUDIOVERDOPPLER

- Eine 3,5-mm-Klinkenbuchse, die sich in zwei Audioausgänge verdoppelt
- Material: außen aus weichem Kunststoff, innen aus ABS und Metall

SOLD X 3**PACKAGING**

carded
L 8 x H 10 x W 1.2 cm

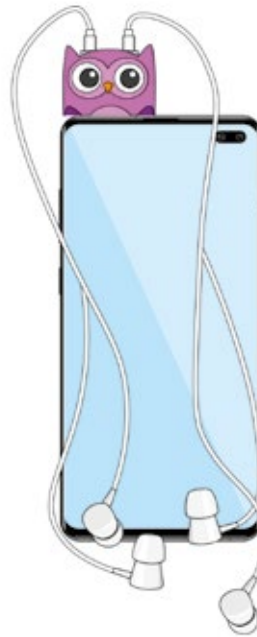

OWL
MY0001



8 051070 278471



CAMERA
MY0012



8 051764 522897





TO **TRAVEL** IS TO LIVE
Your Journey Starts Here

Make sure to pack your personality, while exploring the world

MY TRAVEL BUDDY

L 28 x H 15 x W 6 cm (open)
L 16 x H 16 x W 10 cm (closed)

TRAVEL PILLOW WITH SLEEP MASK

- Zip closure
- Space saving, with a convenient travel hook
- Material:
exterior: 95% polyester, 5% spandex
interior: 100% polyester

CUSCINO DA VIAGGIO CON MASCHERINA DA NOTTE

- Chiusura a zip
- Salvaspazio, con gancio per un comodo trasporto
- Materiale:
esterno: 95% poliestere, 5% spandex
interno: 100% poliestere

SOLD X 3



COUSSIN DE VOYAGE AVEC MASQUE DE NUIT

- Fermeture éclair
- Gain de place, avec mousqueton pratique pour le transport
- Matériau :
extérieur : 95 % polyester, 5 % spandex
intérieur : 100 % polyester

ALMOHADA DE VIAJE CON ANTIFAZ PARA DORMIR

- Cierre con cremallera
- Compacta, con gancho para transportarla cómodamente
- Material:
exterior: 95 % poliéster, 5 % elastano
interior: 100 % poliéster

REISEKISSEN MIT SCHLAFMASKE

- Reißverschluss
- Platzsparend, mit praktischem Transporthaken
- Material:
außen: 95 % Polyester, 5 % Elasthan
innen: 100 % Polyester



PENGUIN
CTP0001



8 053610 784251



TEDDY BEAR
CTP0002



8 053610 784268



UNICORN
CTP0003



8 053610 784275



PANDA
CTP0004



8 053610 784282

TRAVEL PILLOW

L 20.3 x H 30 x W 13.3 cm

MEMORY FOAM TRAVEL PILLOW

- Ergonomic and breathable
- Removable and machine-washable external cover
- Perfect for supporting the neck
- Material:
 - exterior: 100% polyester
 - interior: 100% memory foam

CUSCINO DA VIAGGIO IN MEMORY FOAM

- Ergonomic e traspirante
- Fodera esterna sfoderabile e lavabile in lavatrice
- Perfetto per sostenere il collo
- Materiale:
 - esterno: 100% poliestere
 - interno: 100% memory foam

COUSSIN DE VOYAGE EN MOUSSE À MÉMOIRE DE FORME

- Ergonomique et respirant
- Housse extérieure amovible et lavable en machine
- Parfait pour soutenir le cou
- Matériau:
 - extérieur : 100 % polyester
 - intérieur : 100 % mousse à mémoire de forme

COJÍN DE VIAJE DE VISCOELÁSTICA

- Ergonómico y transpirable
- Forro externo desfundable y lavable en lavadora
- Perfecto para sujetar el cuello
- Material:
 - exterior: 100 % poliéster
 - interior: 100 % viscoelástica

REISEKISSEN AUS MEMORY-SCHAUM

- Ergonomisch und atmungsaktiv
- Abnehmbarer und in der Maschine waschbarer Bezug
- Perfekte Unterstützung der Halswirbel
- Material:
 - außen: 100 % Polyester
 - innen: 100 % Memory-Schaum

SOLD X 3



TRAVEL
TPP0001
8 052694 002350



MINI TRAVEL PILLOW

L 18 x H 9 x W 9 cm

MINI MEMORY FOAM TRAVEL PILLOW

- Small and portable
- The external cover can be removed and machine-washed
- Material:
 - exterior: 100% polyester
 - interior: 100% memory foam

MINI CUSCINO DA VIAGGIO IN MEMORY FOAM

- Piccolo e portatile
- Fodera esterna sfoderabile e lavabile in lavatrice
- Materiale:
 - esterno: 100% poliestere
 - interno: 100% memory foam

MINI ALMOHADA DE VIAJE EN MEMORY FOAM

- Pequeña y portátil
- Funda exterior desfundable y lavable en la lavadora
- Material:
 - exterior: 100 % poliéster
 - interior: 100 % viscoelástica

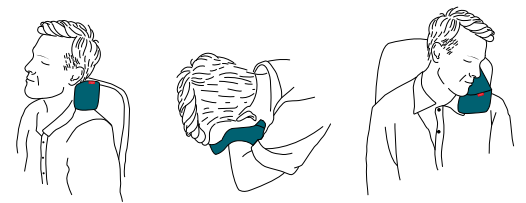

MINI-REISEKISSEN AUS MEMORY-SCHAUM

- Klein und tragbar
- Abnehmbarer und in der Waschmaschine waschbarer Außenbezug
- Material:
 - außen: 100 % Polyester
 - innen: 100 % Memory-Schaum



SOLD X 3

SLEEP MASK

L 20.5 x H 10 x W 1 cm

**SLEEP MASK**

- Elastic strap that is practical, comfortable and adjustable
- Material: polyester

MASCHERINA DA NOTTE

- Elastico regolabile, pratico e comodo
- Materiale: poliестere

MASQUE DE SOMMEIL

- Sangle élastique, pratique, confortable et réglable
- Matériau : polyester

ANTIFAZ DE NOCHE

- Sujeción con elástico, práctico, cómodo y regulable
- Material: poliéster

SCHLAFMASKE

- Elastischer, praktischer, bequemer und verstellbarer Verschluss
- Material: Polyester

*MORE DESIGNS ON PAGE 45

PACKAGINGwindow box
L 9.5 x H 23 x W 1.8 cm**DISPLAY**material: cardboard
L 11.3 x H 31 x W 15.5 cm
7 PCS

SEMKIT4



8 051128 755008

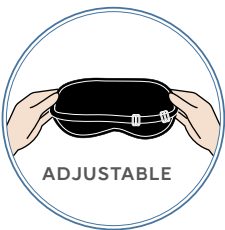

ADJUSTABLE

**TRAVEL SLEEP MASK**

L 21 x H 9.5 x W 0.5 cm

**TRAVEL SLEEP MASK**

- Elastic hook and loop closure
- Material: 96.1% polyester, 3.9% elastane

MASCHERINA DA VIAGGIO PER GLI OCCHI

- Chiusura a strappo elastica
- Materiale: 96,1% poliестere, 3,9% elasthan

MASQUE DE VOYAGE POUR LES YEUX

- Fermeture à scratch élastique
- Matériau : 96,1 % polyester, 3,9 % élasthanne

ANTIFAZ DE VIAJE

- Cierre de gancho y bucle elástico
- Material: 96,1 % poliéster, 3,9 % elastano

REISE-SCHLAFMASKE FÜR DIE AUGEN

- Elastischer Klettverschluss
- Material: 96,1 % Polyester, 3,9 % Elasthan

PACKAGINGplastic bag
L 12 x H 15 x W 1.5 cm**DISPLAY**material: cardboard
L 13.1 x H 26.5 x W 22 cm
12 PCS

MASKIT1



8 051128 750454

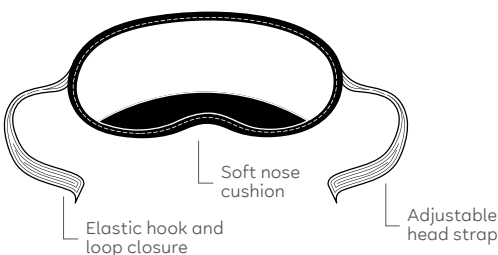

MANICURE KIT

L 7.5 x H 11 x W 2 cm

MANICURE KIT

- Contains: mini scissors, nail clippers, file, cuticle pusher
- Zip closure
- Material: PU case with fleece lining, stainless steel accessories

KIT MANICURE

- Contiene: forbicine, tagliaunghie, lima, spingicuticole
- Chiusura a zip
- Materiale: custodia in PU con interno in pile, accessori in acciaio inox

KIT MANUCURE

- Contient : des ciseaux à ongles, un coupe-ongle, une lime et un pousse cuticule
- Fermeture éclair
- Matériau : pochette en PU, intérieur en polaire, accessoires en acier inoxydable

KIT DE MANICURA

- Incluye: tijeras, cortaúñas, lima y empujacutículas
- Cierre con cremallera
- Material: estuche de PU con interior de forro polar, accesorios de acero inoxidable



STAINLESS STEEL



IDEAL FOR TRAVEL



* MORE DESIGNS ON PAGE 50

MANIKÜRE-SET

- Inhalt: Nagelschere, Nagelknipser, Nagelfeile, Nagelhautschieber
- Reißverschluss
- Material: Etui aus PU mit Futter aus Fleece, Utensilien aus Edelstahl



NAIL CLIPPERS

MINI SCISSORS

FILE

CUTICLE PUSHER

PACKAGING

window box
L 13 x H 16 x W 4 cm

SOLD X 6

TRAVEL

MST0003



8 052694 001742



TRAVEL ALARM CLOCK

L 6.5 x H 2.5 x W 7 cm (closed)

ANALOG TRAVEL ALARM CLOCK

- Practical metal case
- Material: matte metal, plastic

OROLOGIO-SVEGLIA ANALOGICA DA VIAGGIO

- Pratica custodia in metallo
- Materiale: metallo opaco, plastica

HORLOGE-RÉVEIL ANALOGIQUE DE VOYAGE

- Étui métallique pratique
- Matériau : métal opaque, plastique

RELOJ DESPERTADOR ANALÓGICO DE VIAJE

- Práctica funda en metal
- Material: metal opaco, plástico

ANALOG-REISEWECKER

- Praktisches Etui aus Metall
- Material: mattes Metall, Kunststoff



1 x LR44 battery (included)

PACKAGING

cardboard box
L 7 x H 9.5 x W 3 cm

SOLD X 3

TAC0001



8 059174 833336



WORLDWIDE TRAVEL ADAPTER

L 6 x H 5.7 x W 4.6 cm

UNIVERSAL WORLDWIDE TRAVEL ADAPTER

- 2 USB ports for the direct charging of mobile devices such as smartphones and tablets
- Material: ABS, brass

ADATTATORE UNIVERSALE DA VIAGGIO

- 2 porte USB per ricaricare direttamente i dispositivi mobili come smartphone e tablet
- Materiale: ABS, ottone

CHARGEUR ADAPTATEUR DE VOYAGE UNIVERSEL

- 2 ports USB pour recharger directement les dispositifs mobiles de type smartphone et tablette
- Matériau : ABS, laiton

ADAPTADOR DE VIAJE UNIVERSAL

- 2 puertos USB para cargar directamente los dispositivos móviles como smartphone y tabletas
- Material: ABS, latón

UNIVERSALER REISELADAPTER

- 2 USB-Ports zum direkten Aufladen von mobilen Geräten wie Smartphones und Tablets
- Material: ABS, Messing



Compatible with more than 150 countries

**DISPLAY**material: cardboard
L 14 x H 16 x W 16 cm**6 PCS****TAKIT2**

8 051128 754483

**PACKAGING**PET box w/hook
L 6.3 x H 10 x W 5 cm**DIGITAL LUGGAGE WEIGHING SCALE**

L 3 x H 9.8 x W 2.6 cm

DIGITAL LUGGAGE WEIGHING SCALE

- Tare function, for weighing any objects to be added to the baggage
- Measurement unit: kg/lb
- Material: ABS, PC

BILANCIA DIGITALE PESA VALIGIA

- Funzione tara, per pesare eventuali oggetti da aggiungere al bagaglio
- Unità di misura: kg/lb
- Materiale: ABS, PC

PÈSE-BAGAGE NUMÉRIQUE

- Fonction tare, pour peser d'éventuels objets à ajouter dans le bagage
- Unité de mesure : kg/lb
- Matériau : ABS, PC

BALANZA DIGITAL PARA MALETA

- Función tara, para pesar objetos que se vayan a añadir al equipaje
- Unidad de medida: kg/lb
- Material: ABS, PC

DIGITALE KOFFERWAAGE

- Tara-Funktion, um eventuelle Gegenstände, die dem Gepäck hinzugefügt werden sollen, abzuwiegen
- Maßeinheit: kg/lb
- Material: ABS, PC

1 x CR2032 battery
(included)**PACKAGING**window box
L 6 x H 17 x W 3.5 cm**SOLD X 4****DTS0001**

8 051739 306835

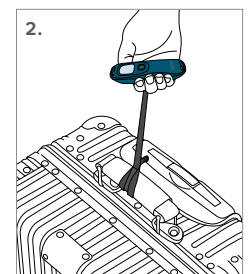
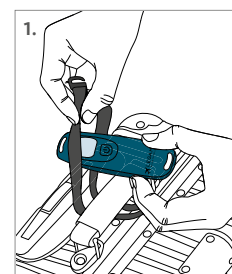

How to use:

MAX
50 KG
110 LB

MINI TRAVEL IRON

L 10 x H 3.2 x W 7.5 cm (folded)

MINI TRAVEL IRON

- Compact and light
- Power cord with Schuko plug included
- Dry iron, no water
- Material: PC, aluminium coated with non-stick Teflon paint

MINI FERRO DA STIRO DA VIAGGIO

- Compatto e leggero
- Cavo di alimentazione con spina schuko incluso
- Stira a secco, senza acqua
- Materiale: PC, alluminio rivestito con vernice teflon antiaderente

MINI FER À REPASSER DE VOYAGE

- Compact et léger
- Câble d'alimentation muni d'une prise schuko inclus
- Repassage à sec, sans eau
- Matériau : PC, aluminium revêtu d'un émail téflon antiadhésif

MINIPLANCHA DE VIAJE

- Compacta y ligera
- Cable de alimentación con enchufe Schuko incluido
- Plancha en seco, sin agua
- Material: PC, aluminio revestido con pintura teflón antiadherente

MINI-REISEBÜGELEISEN

- Kompakt und leicht
- Inklusive Netzkabel mit Schuko-Stecker
- Funktioniert ohne Wasser
- Material: PC, Aluminium mit Antihaft-Teflonlack



Temperature range:
100°C-200°C



Supply:
100-240 V ~ 50 Hz



Power:
25 W

PACKAGING

cardboard box
L 11.5 x H 9 x W 8 cm

SOLD X 3

T10001



Non-stick metal plate

Power cord input

Folding handle

Indicator light

1.5 m



LINT-REMOVING STICKY ROLLER

L 4 x H 9.5 x W 4 cm (closed)

LINT-REMOVING STICKY ROLLER

- Contains 3 rolls of 30 sheets each
- Pre-cut easy-tear paper
- Material: plastic, adhesive paper

RULLO ADESIVO LEVA PELUCCHI

- Contiene 3 rotoli da 30 fogli cadauno
- Carta pretagliata strappo facile
- Materiale: plastica, carta adesiva

ROULEAU ADHÉSIF ANTI-PELUCHE

- Il contient 3 rouleaux de 30 feuilles chacun
- Papier prédécoupé facile à détacher
- Matériau : plastique, papier adhésif

RODILLO ADHESIVO QUITA PELUSAS

- Contiene 3 rodillos de 30 hojas cada uno
- Hojas precortadas que se separan fácilmente
- Material: plástico, papel adhesivo

FUSSELROLLE

- Enthält 3 Rollen mit jeweils 30 Klebeblättern
- Vorgeschnittenes, leicht abreißbares Papier
- Material: Kunststoff, Klebepapier



Self-standing packaging

PACKAGING

carded
L 12.5 x H 17 x W 6 cm

SOLD X 4

* While stock lasts

LB0001 AQUA



8 052783 613924

LB0002 GREY



8 052783 614174



LUGGAGE PADLOCK

L 3 x H 5.8 x W 1.5 cm

LUGGAGE PADLOCK

- Programmable 3-digit combination
- Material: plastic, chrome-plated steel

LUCCHETTO PER VALIGIA

- Combinazione programmabile a 3 cifre
- Materiale: plastica, acciaio cromato

CADENAS POUR VALISE

- Combinaison programmable à 3 chiffres
- Matériau : plastique, acier chromé

CANDADO PARA MALETA

- Combinación de 3 cifras configurable
- Material: plástico, acero cromado

SCHLOSS FÜR KOFFER

- Programmierbare 3-stellige Kombination
- Material: Kunststoff, verchromter Stahl

PACKAGING

carded
L 8.5 x H 14.5 x W 1.5 cm



SAFE INSPECTION
NO DAMAGE

**DISPLAY**

material: cardboard
L 20.5 x H 21 x W 13 cm

10 PCS

TSAKIT2



8 051128 754490

**HANDS FREE STRAP**

L 4.5 x H MIN 25.5 x W 1.5 cm (closed)
L 4.5 x H MAX 37.5 x W 1.5 cm (opened)

BAG HOLDER STRAP FOR SUITCASE

- Adjustable strap
- Resistant snap buckle closure
- Also suitable as a bag hanger for clothes
- Material: polyester, plastic

CINGHIA PORTA BORSA PER VALIGIA

- Cinghia regolabile
- Chiusura con fibbia a scatto resistente
- Adatta anche come appendiabiti da borsa
- Materiale: poliestere, plastica

SANGLE PORTE SAC POUR VALISE

- Sangle réglable
- Fermeture avec boucle à clip résistante
- Elle est aussi adaptée pour accrocher des vêtements au sac
- Matériau : polyester, plastique

CORREA PORTABOLSA PARA MALETA

- Correa regulable
- Cierre con resistente hebilla de presión
- Adecuada también como percha de bolso
- Material: poliéster, plástico

KOFFERGURT

- Verstellbarer Gurt
- Robuster Schnappverschluss
- Auch als an der Tasche befestigter Bügel geeignet
- Material: Polyester, Kunststoff



Adjustable strap

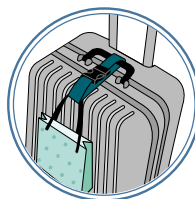

Resistant snap buckle closure, easy to hook and unhook



Also suitable as a bag hanger for clothes



HFB0001



8 052461 962474

PACKAGING

carded
L 9.8 x H 20.8 x W 1.5 cm

SOLD X 3

LUGGAGE TAG

L 6.8 x H 17 x W 1 cm

LUGGAGE TAG

- Space for personal data
- Material: PU

ETICHETTA BAGAGLIO

- Spazio per dati personali
- Materiale: PU

ÉTIQUETTE DE BAGAGE

- Espace pour les données personnelles
- Matériau : PU

ETIQUETA PARA EQUIPAJE

- Espacio para datos personales
- Material: PU

GEPÄCKANHÄNGER

- Platz für persönliche Daten
- Material: PU

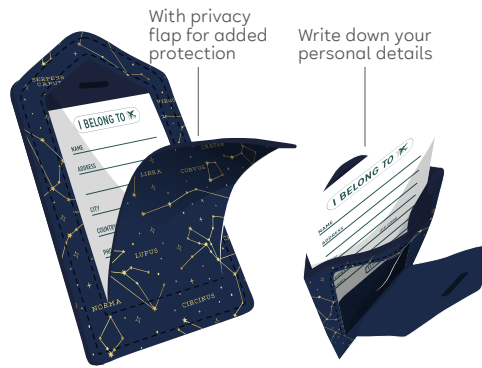

PACKAGING

carded
L 8.5 x H 21 x W 1.5 cm
SOLD X 3



GOLD FOIL

TRAVEL
NLUG0001



8 053610 785302



PETROL
NLUG0002



8 052694 002404



GOLD FOIL

STARS
NLUG0003



8 052694 002374



BLACK FOIL

DAISY
NLUG0004



8 052694 004088



GOLD FOIL

FLOWERS
NLUG0005



8 052694 004095



BLACK FOIL

TRAVEL
Let's get lost together
NLUG0006



8 052694 005221



PACKAGING

carded
L 15.4 x H 20.9 x W 1.5 cm
SOLD X 3

PASSPORT HOLDER

L 10.5 x H 14 x W 1 cm (closed)

PASSPORT HOLDER

- 1 passport pocket
- 4 pockets for credit cards and tickets
- RFID blocking: protects against data theft
- Material: PU with polyester internal lining

PORTA PASSAPORTO

- 1 tasca per il passaporto
- 4 tasche per carte di credito e ticket
- Protezione RFID: protegge dal furto dei dati
- Materiale: PU con fodera interna in poliester

PORTE-PASSEPORT

- 1 pochette pour le passeport
- 4 pochettes pour les cartes de crédit et les tickets

- Protection RFID : protège du vol de données
- Matériau : PU avec doublure intérieure en polyester

PORTA PASAPORTE

- 1 bolsillo para el pasaporte
- 4 bolsillos para tarjetas de crédito y tiques
- Protección RFID: protege del robo de datos
- Material: PU con forro interno de poliéster

REISEPASSHÜLLE

- 1 Fach für den Reisepass
- 4 Fächer für Kreditkarten und Tickets
- RFID-Schutz: schützt vor Datendiebstahl
- Material: PU mit Innenfutter aus Polyester



PACKAGING

window box
L 10.5 x H 17 x W 1.2 cm

SOLD X 3

**DISPLAY AVAILABLE
ON PAGE 388**

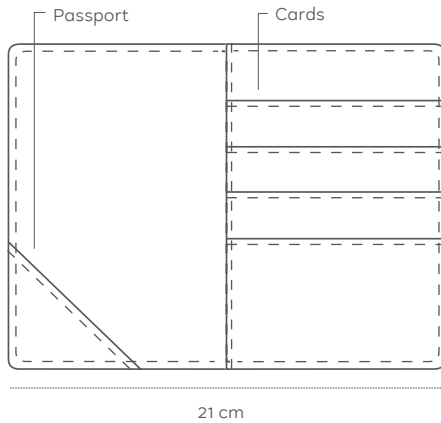



TRAVEL ORGANISER

L 11 x H 24 x W 3 cm (closed)

TRAVEL ORGANISER

- 4 large pockets for boarding pass and passport
- 7 small pockets for credit cards and tickets
- RFID blocking: protects against data theft
- Material: soft PU with nylon lining

PORTA DOCUMENTI DA VIAGGIO

- 4 tasche grandi per carte d'imbarco e passaporto
- 7 tasche piccole per carte di credito e ticket
- Protezione RFID: protegge dal furto dei dati
- Materiale: morbido PU con fodera in nylon

PORTE-DOCUMENTS DE VOYAGE

- 4 grandes pochettes pour les cartes d'embarquement et le passeport
- 7 petites pochettes pour les cartes de crédit et les tickets

- Protection RFID : protège du vol de données
- Matériau : polyuréthane souple avec doublure en nylon

PORTA DOCUMENTOS DE VIAJE

- 4 bolsillos grandes para tarjetas de embarque y pasaporte
- 7 bolsillos pequeños para tarjetas de crédito y tickets
- Protección RFID: protege del robo de datos
- Material: PU suave con forro de nylon

REISEDOKUMENTENTASCHE

- 4 große Fächer für Bordkarten und Reisepass
- 7 kleine Fächer für Kreditkarten und Tickets
- RFID-Schutz: schützt vor Datendiebstahl
- Material: weiches PU mit Nylonhülle

PACKAGING

window box
L 12 x H 27.5 x W 2 cm
SOLD X 3

DISPLAY AVAILABLE ON PAGE 388

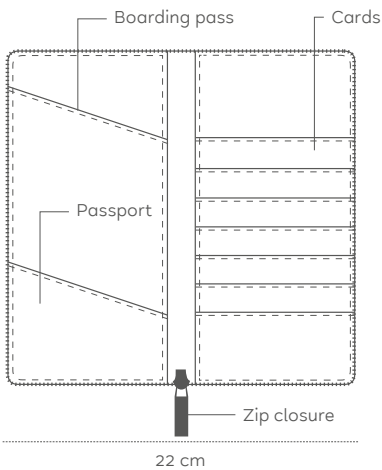

TRAVEL
T00032



PETROL
T00033



STARS
T00034



DAISY
T00035



FLOWERS
T00036



CABLE ORGANISER

L 23.8 x H 14 x W 4.7 cm

CABLE ORGANISER

- Zip closure
- 2 zip pockets and 6 elasticated loops on the inside
- Material:
 - exterior: 100% cotton
 - interior: 100% polyester

ORGANISER PER CAVI

- Chiusura a zip
- 2 tasche interne zippate e 6 elastici
- Materiale:
 - esterno: 100% cotone
 - interno: 100% poliestere

SAC DE RANGEMENT POUR CÂBLES

- Fermeture éclair
- 2 poches intérieures zippées et 6 élastiques
- Matériau :
 - extérieur : 100 % coton
 - intérieur : 100 % polyester

ORGANIZADOR PARA CABLES

- Cierre con cremallera
- 2 bolsillos internos con cremallera y 6 elásticos
- Material:
 - exterior: 100 % algodón
 - interior: 100 % poliéster

KABEL-ORGANIZER

- Reißverschluss
- 2 Innentaschen mit Reißverschluss und 6 elastische Schlaufen
- Material:
 - außen: 100 % Baumwolle
 - innen: 100 % Polyester

PACKAGINGcardboard belly band
L 23.8 x H 21.5 cm**SOLD X 4**

CP00001



8 052694 002367

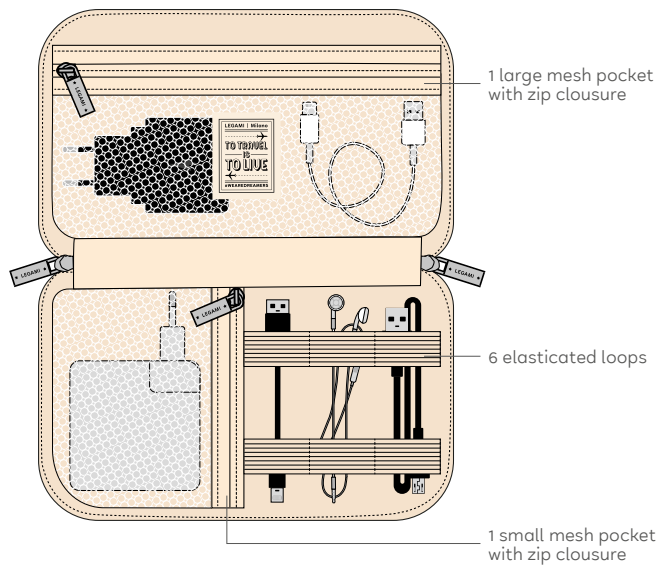

TRAVELLER SET

TRAVELLER SET

- The set includes: 1 spatula, 3 bottles and 2 pots which comply with airport regulations
- Includes a sheet of personalisable plastic labels
- Material: plastic, TPU

SET DA VIAGGIO

- Il set comprende: 1 spatola, 3 flaconi e 2 barattoli conformi alle norme aeroportuali
- Include un foglio di etichette plastificate personalizzabili
- Materiale: plastica, TPU

SET DE VOYAGE

- Le set comprend : 1 spatule, 3 flacons et 2 pots conformes aux réglementations des aéroports
- Il comprend une série d'étiquettes plastifiées personnalisables
- Matériau : plastique, TPU

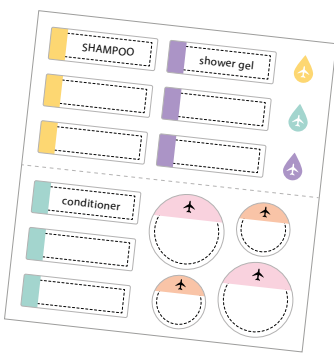

SET DE VIAJE

- El set incluye: 1 espátula, 3 frascos y 2 tarros conformes con las normas aeroportuarias
- Incluye un folio de etiquetas plastificadas personalizables
- Material: plástico, TPU

REISE-SET

- Das Set enthält: 1 Spatel, 3 Fläschchen und 2 Dosen, die den Flughafenbestimmungen entsprechen
- Enthält ein Blatt mit individuell gestaltbaren Kunststoff-Etiketten
- Material: Kunststoff, TPU



PACKAGING

PVC pouch
L 15 x H 11 x W 4.5 cm
SOLD X 4

TBS0001



TRAVEL TOILETRY BAG

L 24 x H 15 x W 8 cm (closed)
L 24 x H 42 x W 4 cm (opened, hook included)

TRAVEL TOILETRY BAG

- Perfect for travelling or for the gym, also ideal for everyday use
- Material: polyester

BEAUTY CASE DA VIAGGIO

- Perfetto per il viaggio o per la palestra, ideale anche per l'uso quotidiano
- Materiale: poliestere

TROUSSE DE MAQUILLAGE DE VOYAGE

- Parfaite pour les voyages ou la salle de sport, mais aussi pour un usage quotidien
- Matériau : polyester

NECESER DE VIAJE

- Perfecto para viajar o llevar al gimnasio, también es ideal para usar a diario
- Material: poliéster

REISE-KOSMETIKTASCHE

- Perfekt für Reisen oder das Fitnessstudio, ideal auch für den Alltag
- Material: Polyester

PACKAGING

cardboard belly band
L 24 x H 22.5 x W 6 cm
SOLD X 4

TOR0001

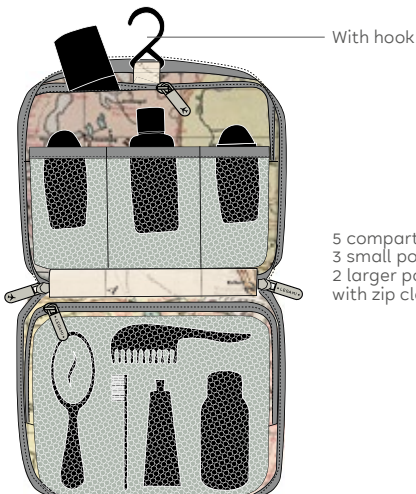

5 compartments:
3 small pockets and
2 larger pockets
with zip closure



TRAVEL ORGANISER SET

SET OF 3 TRAVEL BAGS

- Ideal for storing clothing, shoes or travel accessories
- Material: polyester

SET DI 3 BUSTE DA VIAGGIO

- Ideale per riporre indumenti, scarpe o accessori da viaggio
- Materiale: poliestere

SET DE 3 HOUSSES DE VOYAGE

- Idéal pour ranger les vêtements, les chaussures ou les accessoires de voyage
- Matériau : polyester

SET DE 3 ORGANIZADORES DE VIAJE

- Ideal para meter prendas, zapatos o accesorios de viaje
- Material: poliéster

SET MIT 3 KOFFERORGANIZERN

- Ideal für Bekleidung, Schuhe oder Reise-Accessoires
- Material: Polyester

PACKAGING

cardboard box
L 14.5 x H 25 x W 3.5 cm
SOLD X 4

STB0001



8 052461 962047



SHOE BAG
L 23 x H 37 x W 12 cm

LARGE PACKING CUBE
L 40 x H 26 x W 10 cm

SMALL PACKING CUBE
L 26 x H 20 x W 10 cm



TRAVEL BAGS

SET OF 3 TRAVEL BAGS

- Material: polyester

SET DI 3 BUSTE DA VIAGGIO

- Materiale: poliestere

SET DE 3 HOUSSES DE VOYAGE

- Matériau : polyester

SET DE 3 ORGANIZADORES DE VIAJE

- Material: poliéster

SET MIT 3 KOFFERORGANIZERN

- Material: Polyester

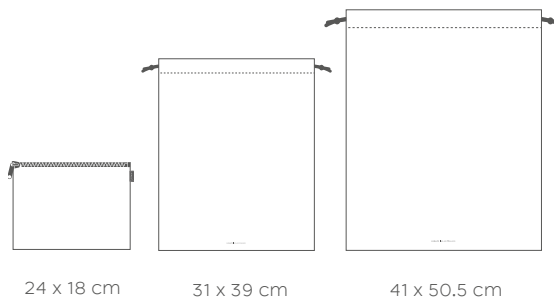

PACKAGING
cardboard belly band w/ hook
L 24 x H 21 x W 2.5 cm
SOLD X 2



POSE0001



8 052783 616055

FOLDABLE TRAVEL BAG

L 20 x H 15 cm (folded)

L 36.5 x H 32 x W 18 cm (opened, without handles)

FOLDABLE TRAVEL BAG

- Ultra-lightweight and super-resistant
- Material: polyester

BORSA DA VIAGGIO PIEGHEVOLE

- Ultra leggera e super resistente
- Materiale: poliestere

SAC DE VOYAGE PLIABLE

- Ultraléger et très résistant
- Matériau : polyester

BOLSA DE VIAJE PLEGABLE

- Ultraligera y superresistente
- Material: poliéster

FALTBARE REISETASCHE

- Ultraleicht und besonders robust
- Material: Polyester



Zip closure

2 handles

**PACKAGING**

cardboard belly band

L 20 x H 19.5 x W 5 cm

SOLD X 4

TSB0001

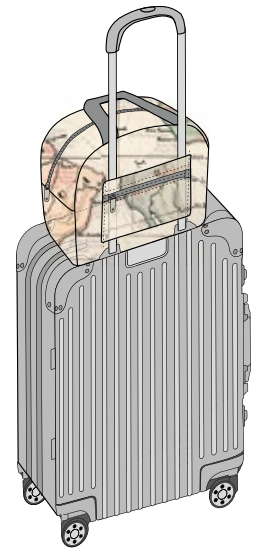

8 052461 962054

**FOLDABLE BACKPACK**

L 9 x H 16 x W 5 cm (pouch - closed)

L 33 x H 51 x W 0.7 cm

FOLDABLE BACKPACK

- Two side pockets
- Front pocket with zip
- Padded shoulder strap
- Material: polyester

ZAINO PIEGHEVOLE

- Due tasche laterali
- Tasca frontale con zip
- Spallacci imbottiti
- Materiale: poliestere

SAC À DOS PLIABLE

- Deux poches latérales
- Poche avant avec fermeture éclair
- Bretelles matelassées
- Matériau : polyester

MOCHILA PLEGABLE

- Dos bolsillos laterales
- Bolsillo frontal con cremallera
- Tirantes acolchados
- Material: poliéster

FALTBARER RUCKSACK

- Zwei Seitentaschen
- Tasche auf der Vorderseite mit Reißverschluss
- Gepolsterte Tragegurte
- Material: Polyester

SOLD X 4

FB0002



8 053610 785326



VINTAGE MEMORIES

Remember That?

Relive your favourite memories, again and again

BINOCULARS

L 8.6 x H 3.7 x W 12 cm

BINOCULARS

- Binoculars with 30 mm glass lenses and centralised focus adjustment
- Magnification: 4x
- Material: plastic, glass, fabric

BINOCOLO

- Binocolo con lenti in vetro da 30 mm e funzionalità centralizzata di messa a fuoco
- Ingrandimento: 4x
- Materiale: plastica, vetro, tessuto

JUMELLES

- Jumelles avec lentilles en verre de 30 mm et système centralisé de mise au point
- Agrandissement : 4x
- Matériau : plastique, verre, tissu

PRISMÁTICOS

- Prismáticos con lentes de vidrio de 30 mm y función de enfoque centralizada
- Aumento: 4x
- Material: plástico, vidrio, tejido

FERNGLAS

- Fernglas mit 30 mm dicken Glaslinsen und zentralisierter Scharfeinstellungsfunktion
- Vergrößerung: 4x
- Material: Kunststoff, Glas, Stoff

PACKAGING

cardboard box
L 12 x H 9.8 x W 5 cm
SOLD X 4

BIN0001



MAGNIFYING GLASS

L 13.5 x H 1.4 x W 6.5 cm

3X MAGNIFYING GLASS

- Enlarges objects 3 times
- Material: plastic, glass

LENTE DI INGRANDIMENTO 3X

- Ingrandisce 3 volte gli oggetti osservati
- Materiale: plastica, vetro

LOUPE GROSSISSANTE 3X

- Elle grossit 3 fois les objets observés
- Matériau : plastique, verre

LUPA DE AUMENTO 3X

- Aumenta 3 veces los objetos observados
- Material: plástico, vidrio

LUPE MIT 3X-VERGRÖSSERUNG

- Macht die betrachteten Gegenstände 3-mal größer
- Material: Kunststoff, Glas

PACKAGING

carded
L 12.5 x H 16.5 cm



DISPLAY

material: cardboard
L 14 x H 27.5 x W 18.5 cm
10 PCS

MAGNKITI



MICROSCOPE

L 2.5 x H 10 x W 5 cm

PORTABLE MICROSCOPE WITH LED ILLUMINATION

- Package contents: portable microscope, removable base, 2 plastic slides, instruction manual
- Material: plastic

MICROSCOPIO PORTATILE CON ILLUMINAZIONE LED

- Contenuto della confezione: microscopio portatile, base removibile, 2 vetrini in plastica, manuale d'uso
- Materiale: plastica

MICROSCOPE PORTABLE AVEC ÉCLAIRAGE LED

- Contenu de la boîte : microscope portable, base amovible, 2 lames en plastique, mode d'emploi
- Matériau : plastique

MICROSCOPIO PORTÁTIL CON ILUMINACIÓN LED

- Contenido de la caja: microscopio portátil, base desmontable, 2 portaobjetos de plástico, manual de instrucciones
- Material: plástico

TRAGBARES MIKROSKOP MIT LED-BELEUCHTUNG

- Inhalt der Verpackung: tragbares Mikroskop, abnehmbare Basis, 2 Objektträger aus Kunststoff, Gebrauchsanweisung
- Material: Kunststoff

PACKAGING

window box
L 13 x H 17 x W 4 cm
SOLD X 4

MS0001

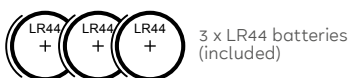

COMPASS

Ø 4.4 cm, H 1 cm

COMPASS KEY RING

- Material: aluminium, with a magnet and transparent dial

BUSSOLA PORTACHIAVI

- Materiale: alluminio, con magnete e quadrante trasparente

PORTE-CLÉS BOUSSOLE

- Matériau : aluminium, avec aimant et cadran transparent

BRÚJULA-LLAVERO

- Material: aluminio, con imán y esfera transparente

KOMPASS-SCHLÜSSELANHÄNGER

- Material: Aluminium, mit Magnet und transparentem Kompassquadranten

PACKAGING
cardboard box
L 5.7 x H 4.8 x W 1.5 cm



DISPLAY
material: cardboard
L 13 x H 14.5 x W 11 cm
16 PCS



WHISTLE

L 4.2 x H 2.2 x W 1.8 cm

METAL WHISTLE

- Material: metal, plastic, fabric cord

FISCHIETTO IN METALLO

- Materiale: metallo, plastica, cordino in tessuto

SIFFLET EN MÉTAL

- Matériau : métal, plastique, cordon en tissu

SILBATO DE METAL

- Material: metal, plástico, cordón en tejido

TRILLERPFEIFE AUS METALL

- Material: Metall, Kunststoff, Stoffkordel

PACKAGING
cardboard box
L 6.5 x H 4.5 x W 3.5 cm



DISPLAY
material: cardboard
L 14 x H 17 x W 15 cm
12 PCS



WALKIE TALKIE



L 4 x H 14 x W 2 cm

SET OF 2 WALKIE TALKIES

- 8 channels
- Transmission range: 3-5 km in open spaces
- Adjustable volume and button lock function
- Material: plastic

SET DI 2 WALKIE TALKIE

- 8 canali
- Distanza di trasmissione: 3-5 km in spazio aperto
- Volume regolabile e blocco tasti
- Materiale: plastica

LOT DE 2 TALKIES-WALKIES

- 8 canaux
- Distance de transmission : 3-5 km dans un espace ouvert
- Volume réglable et verrouillage des touches
- Matériau : plastique

JUEGO DE 2 WALKIE TALKIES

- 8 canales
- Distancia de transmisión: 3-5 km en espacios abiertos
- Volumen ajustable y bloqueo de botones
- Material: plástico

SET MIT 2 WALKIE-TALKIES

- 8 Kanäle
- Übertragungsreichweite: 3-5 km im Freien
- Lautstärke verstellbar und Tastensperre
- Material: Kunststoff

PACKAGING
cardboard box
L 10 x H 18.5 x W 7.5 cm
SOLD X 3



4 x AAA batteries (not included)

NOT FOR SALE IN THE FOLLOWING COUNTRIES: THE UNITED STATES, CANADA, AUSTRALIA, NEW ZEALAND.

PIN ART

L 12.5 x H 18 x W 4.5 cm

THREE-DIMENSIONAL IMPRINTS

- Material: plastic, steel

IMPRONTE TRIDIMENSIONALI

- Materiale: plastica, acciaio

EMPREINTES TRIDIMENSIONNELLES

- Matériau : plastique, acier

IMÁGENES TRIDIMENSIONALES

- Material: plástico, acero

DREIDIMENSIONALE ABDRÜCKE

- Material: Kunststoff, Stahl



PACKAGING

cardboard box
L 13.5 x H 18.5 x W 5 cm

SOLD X 4

ART0001



NEWTON'S CRADLE

L 9 x H 9 x W 7.5 cm

NEWTON'S CRADLE

- Material: ABS, steel

PENDOLO DI NEWTON

- Materiale: ABS, acciaio

PENDULE DE NEWTON

- Matériau : ABS, acier

PÉNDULO DE NEWTON

- Material: ABS, acero

NEWTONPENDEL

- Material: ABS, Stahl

PACKAGING

cardboard box
L 7.8 x H 11 x W 3 cm



DISPLAY

material: cardboard
L 16.5 x H 18.5 x W 15 cm

10 PCS

NCKIT1

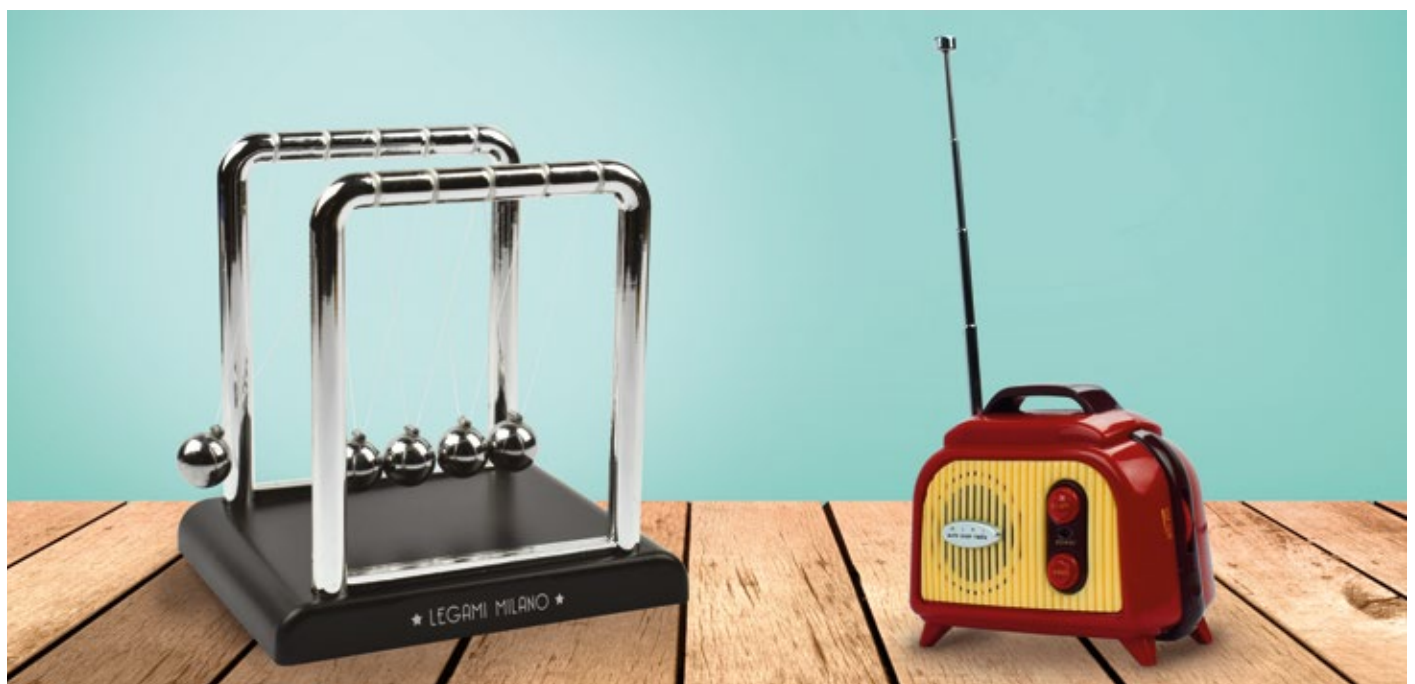

HARMONICA

L 10.2 x H 2 x W 3 cm

DIATONIC HARMONICA IN THE KEY OF C

- With 10 holes that allow you to make 20 different sounds
- Material: metal, plastic

ARMONICA DIATONICA IN CHIAVE DI DO (C)

- Con 10 fori che permettono di emettere 20 diversi suoni
- Materiale: metallo, plastica

HARMONICA DIATONIQUE EN CLÉ DE DO (C)

- Avec 10 trous qui permettent d'émettre 20 sons différents
- Matériau : métal, plastique

HARMÓNICA DIATÓNICA EN CLAVE DE DO (C)

- Con 10 celdas que permiten emitir 20 sonidos distintos
- Material: metal, plástico

DIATONISCHE HARMONIKA IN DER TONART C

- Mit 10 Löchern, mit denen 20 unterschiedliche Töne erzeugt werden können
- Material: Metall, Kunststoff

PACKAGING

cardboard box
L 12.5 x H 3.5 x W 4.5 cm



Plastic case
L 11.2 x H 3 x W 4.5 cm

DISPLAY

material: cardboard
L 12.5 x H 18.5 x W 19.5 cm
8 PCS

HARKITI



8 051128 750201



Metal shell

MINI FM RADIO

L 8.8 x H 7.5 x W 4.5 cm

MINI PORTABLE RADIO

- FM band from 88 MHz to 108 MHz
- Automatic channel searching
- Reset function
- Material: metal, ABS

MINI RADIO PORTATILE

- Banda FM da 88 MHz a 108 MHz
- Scansione automatica
- Funzione Reset
- Materiale: metallo, ABS

MINI RADIO PORTABLE

- Bande FM de 88 MHz à 108 MHz
- Balayage automatique
- Fonction Reset
- Matériau : métal, ABS

MINI RADIO PORTÁTIL

- Banda FM de 88 MHz a 108 MHz
- Búsqueda de canales automática
- Función Reset
- Material: metal, ABS

TRAGBARES MINI-RADIO

- FM-Band zwischen 88 MHz und 108 MHz
- Automatische Scan-Funktion
- Reset-Funktion
- Material: Metall, ABS

PACKAGING

window box
L 10.2 x H 10.7 x W 5.5 cm
SOLD X 3

FM0001



8 051122 260935



Telescopic antenna for better reception



2 x AA batteries (not included)

MUSIC BOX

L 3.3 x H 8 x W 2.5 cm

MUSIC BOX

- MDF base

CARILLON A MANOVELLA

- Base in MDF

BOÎTE À MUSIQUE À MANIVELLE

- Base en MDF

CARILLÓN DE MANIVELA

- Base de MDF

KURBEL-SPIELUHR

- MDF-Basis

* While stock lasts

SOLD X 5

PACKAGING

cardboard box
L 4 x H 8 x W 2.5 cm



MUSIC BOX DISPLAY

Counter empty display on demand: MOQ 50 pcs
material: metal
L 23 x H 42 x W 15 cm

DISSONG



8 052783 618097



MOON RIVER
SONG0003
 8 052783 617991

FOUR SEASONS
SONG0005
 8 052783 618011

REALITY
SONG0006
 8 052783 618028

MY WAY
SONG0008
 8 052783 618042

OVER THE RAINBOW
SONG0010 *
 8 052783 618066

IMAGINE
SONG0011
 8 052783 618073

SINGIN' IN THE RAIN
SONG0012
 8 052783 618080

PUZZLE

Horizontal: L 68 x H 48 cm
Vertical: L 48 x H 68 cm

1000-PIECE PUZZLE

- Poster guide included
- Material: plastic-coated cardboard, fabric



PACKAGING
cardboard tube
Ø 11 cm, H 30 cm

PUZZLE DA 1000 PEZZI

- Poster guida incluso
- Materiale: cartone plastificato, tessuto

PUZZLE DE 1 000 PIÈCES

- Poster d'aide à l'assemblage inclu
- Matériau : carton plastifié, tissu

PUZLE DE 1000 PIEZAS

- Póster guía incluido
- Material: cartón plastificado, tejido

PUZZLE MIT 1000 TEILEN

- Inklusive Poster als Motivvorlage
- Material: kunststoffbeschichteter Karton, Stoff



Cotton pouch and poster guide included



GOLD FOIL

TRAVEL
PUZ0001



8 054320 669787

SOLD X 3



GOLD FOIL

STARS
PUZ0002



8 054320 659794



Holo PRINT

FLORA
PUZ0003



8 054320 659800



LLAMA
PUZ0004



8 054320 659817



PURPLE FOIL

ALICE IN WONDERLAND
PUZ0005



8 054117 620202



WORLD CITIES
PUZ0006



8 054117 620219



POP MATERIAL

WINDOW DISPLAY
L 55 x H 36 cm

Order the full assorted display (36 pcs) and you will receive a window display.

DISPU-GROUP



8 054117 620226

PUZZLE DISPLAY

Floor empty display
on demand: MOQ 36 pcs
2-sided
material: cardboard,
wooden base
L 37 x H 125 x W 35 cm

DISPU



8 051128 755916



BOOK LOVER
PUZ0008



8 053610 781724



NEW

ROMA
PUZ0011



8 052694 016852



GOLD FOIL

CHEERS
PUZ0009



8 053610 781731

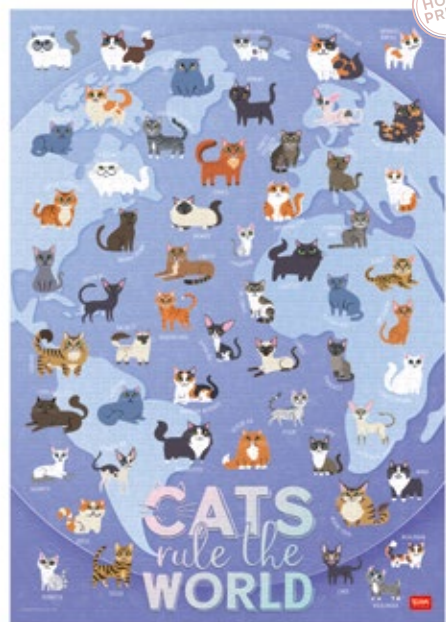

HOLD PRINT

KITTY
PUZ0010



8 052694 001682

BINGO

Rotary cage: L 18.5 x H 22.5 x W 20.7 cm
 Display board: L 21 x H 23.4 x W 1 cm

BINGO

- Contents: 1 metal rotary cage, 90 numbered balls, 1 display board, 60 reusable cards, 300 marker counters, 2 fabric pouches
- Material: metal, paper, plastic, fabric

TOMBOLA

- Contenuto: 1 contenitore girevole in metallo, 90 palline numerate, 1 tabellone, 60 cartelle riutilizzabili, 300 pedine segnanumero, 2 buste in tessuto
- Materiale: metallo, carta, plastica, tessuto

BINGO

- Contient : 1 boulier en métal, 90 boules numérotées, 1 tableau d'affichage, 60 cartons réutilisables, 300 jetons de marquage, 2 sacs de tirage en tissu
- Matériau : métal, papier, plastique, tissu

BINGO

- Contenido: 1 bombo giratorio de metal, 90 bolas numeradas, 1 tablero, 60 cartones reutilizables, 300 fichas para marcar los números, 2 bolsas de tela
- Material: metal, papel, plástico, tejido

BINGO

- Inhalt: 1 Lostrommel aus Metall, 90 Zahlenkugeln, 1 Zahlentafel, 60 wiederverwendbare Spieltafeln, 300 Zahlenplättchen, 2 Stoffbeutel
- Material: Metall, Papier, Kunststoff, Stoff

PACKAGING

cardboard box
 L 21 x H 21 x W 21 cm

SOLD X 2

BNG0001

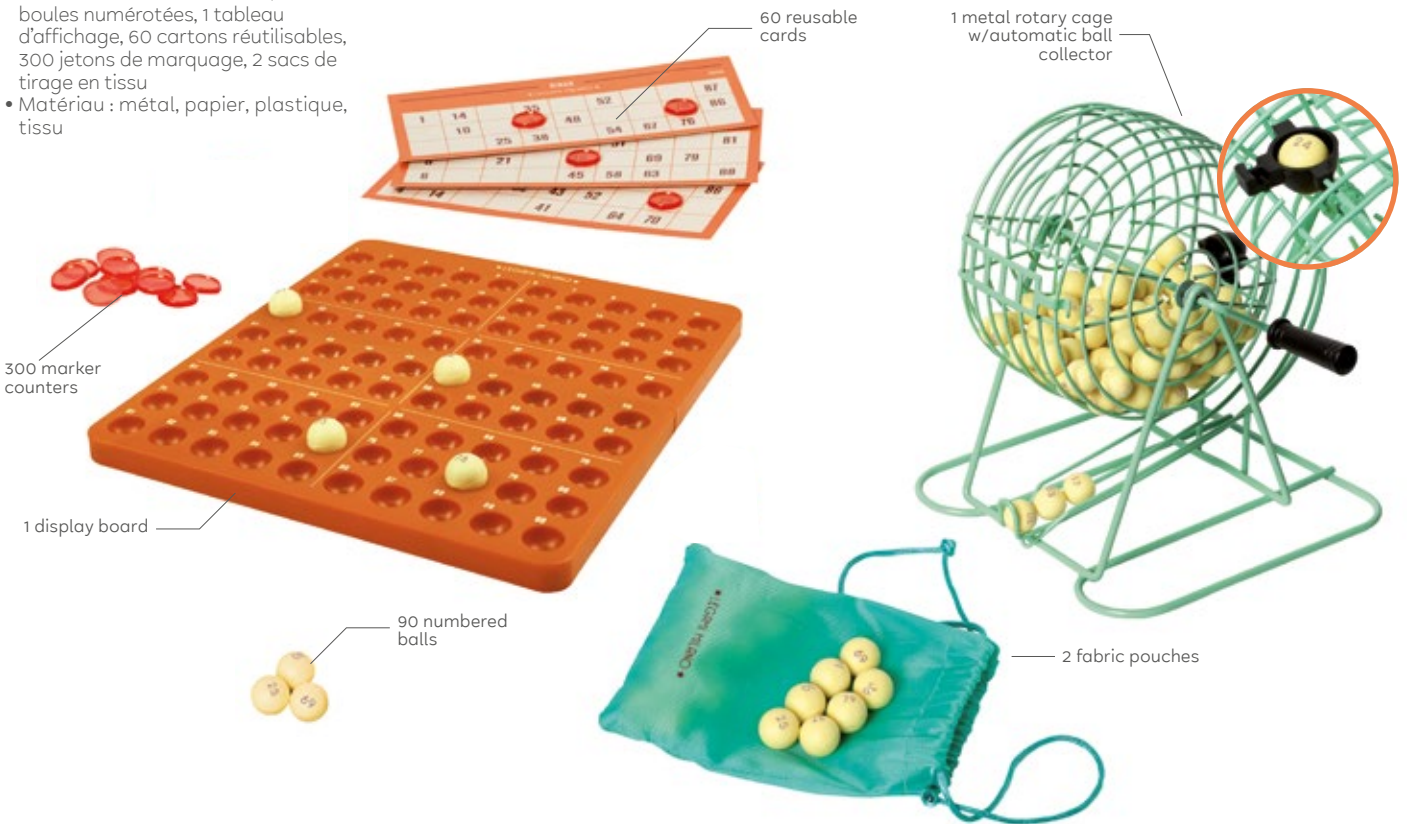
**WHOOPEE CUSHION**

Ø 15 cm

WHOOPEE CUSHION

- Self-inflating
- Material: rubber

CUSCINO SCOREGGINO

- Autogonfiante
- Materiale: gomma

COUSSIN PÊTEUR

- Autogonflant
- Matériau : caoutchouc

COJÍN TIRAPEDOS

- Autoinflable
- Material: goma

PUPSKISSEN

- Selbstaufblasend
- Material: Gummi

**PACKAGING**

cardboard box
 L 13.3 x H 17 x W 4.3 cm

SOLD X 4

WH00001



PLAYING CARDS

L 6.2 x H 8.8 cm

PLAYING CARDS

- 2 sets of 54 cards
- 100% waterproof
- Material: PVC

CARTE DA GIOCO

- 2 mazzi da 54 carte
- Impermeabili al 100%
- Materiale: PVC

CARTES À JOUER

- 2 jeux de 54 cartes
- Entièrement imperméables
- Matériau : PVC

CARTAS

- 2 barajas de 54 cartas
- 100 % impermeables
- Material: PVC

SPIELKARTEN

- Doppeldeck-Karten mit jeweils 54 Karten
- 100 % wasserfest
- Material: PVC

PACKAGINGtin box
L 13 x H 3.7 x W 10.2 cm**DISPLAY**material: cardboard
L 14 x H 23 x W 21 cm**6 PCS****PLAKITI**

8 051128 751680

**DOMINOES**

L 4.7 x H 2.4 cm (tile size)

DOMINOES

- Contents: 28 tiles
- Material: plastic

DOMINO

- Contenuto: 28 tessere
- Materiale: plastica

DOMINOS

- Contenu : 28 pièces
- Matériau : plastique

DOMINÓ

- Contenido: 28 fichas
- Material: plástico

DOMINO

- Inhalt: 28 Spielsteine
- Material: Kunststoff

PACKAGINGtin box with paper wrap
L 17.5 x H 3.7 x W 5.3 cm**DISPLAY**material: cardboard
L 18.5 x H 18.5 x W 18 cm**6 PCS****DOMKIT1**

8 051128 751383

**TIDDLYWINKS**

L 15.3 x H 4.5 x W 15.3 cm

TIDDLYWINKS

- Material: plastic, paper

GIOCO DELLE PULCI

- Materiale: plastica, carta

JEU DE PUCES

- Matériau : plastique, papier

JUEGO DE LA PULGA

- Material: plástico, papel

FLOHSPIEL

- Material: Kunststoff, Papier

PACKAGINGcardboard box
L 15.3 x H 15.3 x W 4.5 cm**SOLD X 4****TID0001**

8 052783 619148

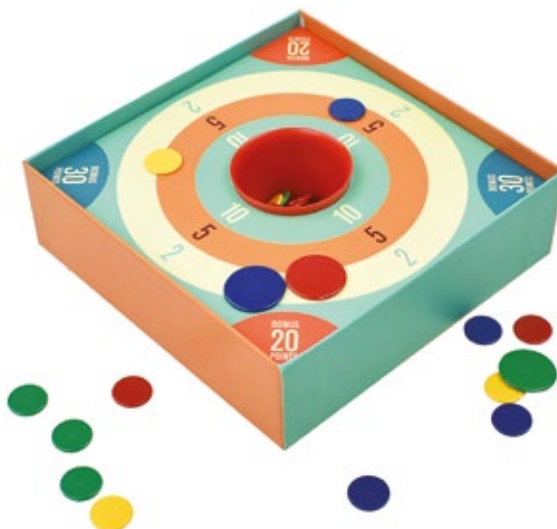

SKIPPING ROPE

L 300 cm (cord)

SKIPPING ROPE

- Lightweight, ergonomic wooden handles
- Adjustable rope
- Material: wood, nylon-cotton blend

CORDA PER SALTARE

- Manici in legno ergonomici e leggeri
- Corda regolabile
- Materiale: legno, nylon misto cotone

CORDE À SAUTER

- Poignées en bois ergonomiques et légères
- Corde réglable
- Matériau : bois, mélange de nylon et de coton

CUERDA PARA SALTAR

- Mangos de madera ergonómicos y ligeros
- Cuerda regulable
- Material: madera, mezcla de nailon y algodón

SPRINGSEIL

- Ergonomische und leichte Holzgriffe
- Verstellbares Seil
- Material: Holz, Nylon-Baumwollmischung

**PACKAGING**cardboard tube
Ø 7 cm, H 18.5 cm**SOLD X 4**

ROP0001



8 053610 784442

**HULA HOOP**

Ø 78 cm

HULA HOOP

- 16 detachable sections
- Material: PE

HULA HOOP

- 16 sezioni assemblabili
- Materiale: PE

CERCEAU DE GYMNASTIQUE

- 16 arceaux à assembler
- Matériau : PE

HULA HOOP

- 16 secciones montables
- Material: PE

HULA-HOOP-REIFEN

- In 16 Teile zerlegbar
- Material: PE

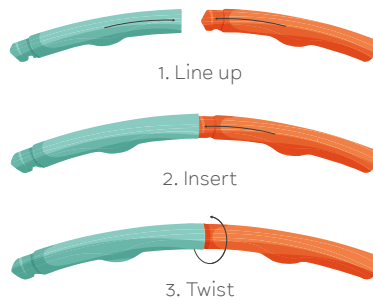
HOW TO ASSEMBLE

1. Line up

2. Insert

3. Twist

PACKAGINGcardboard box
L 16 x H 18 x W 7.5 cm**SOLD X 4**

HUP0001



8 052694 011284

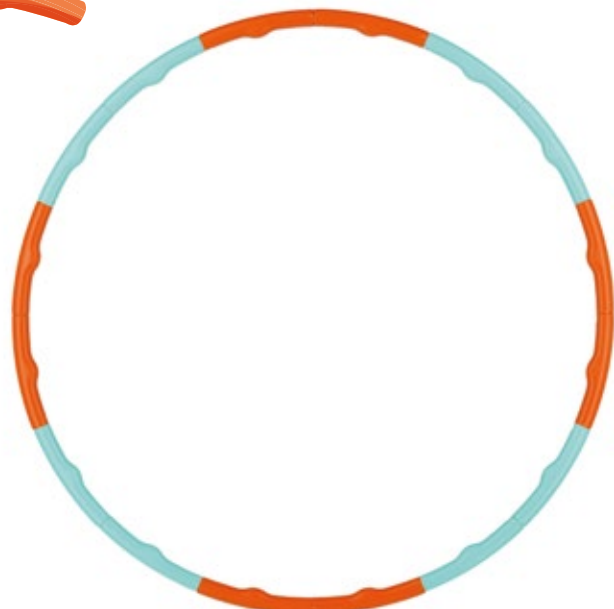

HOPSCOTCH

HOPSCOTCH

- Includes 1 bean bag and 2 pcs of coloured chalk
- Material: tin, chalk, polyester, sand, paper

GIOCO DELLA CAMPANA

- Include 1 segnalino e 2 gessi colorati
- Materiale: latta, gesso, poliester, sabbia, carta

MARELLE

- Le jeu contient un palet et 2 craies colorées
- Matériau : fer-blanc, craie, polyester, sable, papier

JUEGO DE LA RAYUELA

- Incluye 1 ficha y 2 tizas de colores
- Material: hojalata, tiza, poliéster, arena y papel

HIMMEL UND HÖLLE

- Das Spiel beinhaltet 1 Sandsäckchen und 2 bunte Kreiden
- Material: Blech, Kreide, Polyester, Sand, Papier



PACKAGING

tin box
L 13 x H 10 x W 3.5 cm

SOLD X 4

HOP0001



8 053610 781397

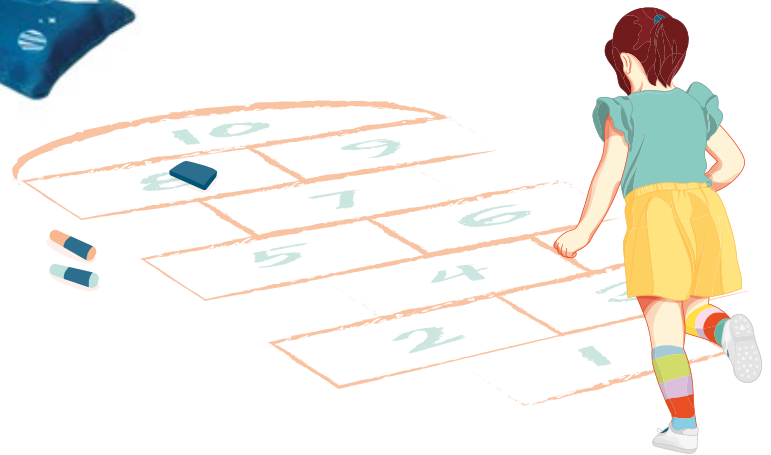

FRENCH SKIPPING



L 300 x H 1 cm

FRENCH SKIPPING ROPE

- "How to play" song book included
- Nursery rhymes in English
- Material: elastic

GIOCO DELL'ELASTICO

- Libretto incluso con regole, filastrocche e sequenze di salti. Filastrocche in lingua inglese
- Materiale: elastico

JEU DE L'ÉLASTIQUE

- Livret inclus comprenant les règles, des comptines et des séries de saut à reproduire
- Comptines en anglais
- Matériau : élastique.

JUEGO DEL ELÁSTICO

- Incluye libro con reglas, canciones y secuencias de saltos. Canciones en inglés
- Material: elástico

GUMMIBAND-SPIEL

- Inklusive Booklet mit Regeln, Reimen und Sprungfolgen. Reime in englischer Sprache
- Material: Gummi



PACKAGING

tin box
L 13 x H 10 x W 3.5 cm

SOLD X 4

FRS0001



8 052694 011291



FLYING DISK

Ø 27.5 cm, W 3 cm

FLYING DISK

- Material: polypropylene

DISCO VOLANTE

- Materiale: polipropilene

DISQUE-VOLANT

- Matériau : polypropylène

DISCO VOLADOR

- Material: polipropileno

FLUGSCHEIBE

- Material: Polypropylen

**PACKAGING**

window box
L 27.6 x H 31 x W 3.2 cm

SOLD X 4

DISC0002

**KITE**

L 58 x H 68 cm (opened, without tail)

DIAMOND KITE

- Material: polyester, fabric, metal frame, plastic handle

AQUILONE

- Materiale: poliester, tessuto, struttura in metallo, manico in plastica

CERF-VOLANT

- Matériau : polyester, tissu, structure en métal, poignée en plastique

COMETA

- Material: poliéster, tejido, estructura metálica, mando de plástico

FLUGDRACHEN

- Material: Polyester, Stoff, Gestell aus Metall, Kunststoffgriff

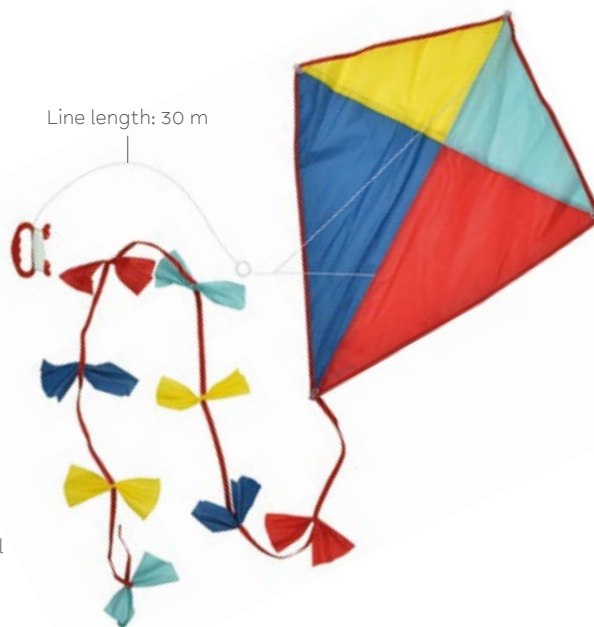
**PACKAGING**

cardboard box
L 9 x H 68.5 x W 6 cm

SOLD X 4

KI0001



Polyester bag included

**DIABOLO**

Diabolo: Ø 10.2 cm, H 13 cm

Fabric string: L 145 cm

DIABOLO

- Material: plastic, iron, wood, cotton

GIOCO DEL DIABOLO

- Materiale: plastica, ferro, legno, cotone

JEU DU DIABOLO

- Matériau : plastique, fer, bois, coton

JUEGO DEL DIÁBOLO

- Material: plástico, hierro, madera, algodón

DIABOLO

- Material: Kunststoff, Eisen, Holz, Baumwolle

**PACKAGING**

window box
L 13.5 x H 35 x W 10.5 cm

SOLD X 4

DBL0001



JUGGLING BALLS

Ø 6.5 cm

JUGGLING BALLS

- Set of 3 juggling balls
- Material: PU-coated and filled with plastic beads

PALLINE DA GIOCOLIERE

- Set 3 palline giocoleria
- Materiale: rivestite in PU e riempite di grani in plastica

BALLES DE JONGLAGE

- Set de 3 balles de jonglage
- Matériau : revêtues de PU et remplies de grains en plastique

PELOTAS DE MALABARES

- Set de 3 pelotas de malabares
- Material: revestimiento en PU y relleno con granos de plástico

JONGLIERBÄLLE

- Set mit 3 Jonglierbällen
- Material: PU-beschichtet und mit Kunststoff-Perlen gefüllt

PACKAGINGwindow box
L 6.5 x H 18.5 x W 6.5 cm**DISPLAY**material: cardboard
L 13.8 x H 19.3 x
W 20.3 cm**6 PCS****JUGKIT1**

8 051128 751499

**GLASS MARBLES**

Ø 1.7 cm - Ø 2.5 cm

GLASS MARBLES

- Contains 20 player marbles
- + 1 shooter marble
- Material: glass

BIGLIE IN VETRO

- Contiene 20 biglie
- + 1 biglione
- Materiale: vetro

BILLES EN VERRE

- Il contient : 20 billes
- + 1 calot
- Matériau : verre

CANICAS DE VIDRIO

- Contiene 20 canicas
- + 1 bolón
- Material: vidrio

GLASMURMELN

- Enthält 20 kleine Murmeln
- + 1 große Murmel
- Material: Glas

PACKAGINGtin box
L 8 x H 10.8 x W 2.5 cm**DISPLAY**material: cardboard
L 16.5 x H 21.5 x W 18 cm**12 PCS****GMKIT1**

8 051128 754346

**MAGIC SPRING**

Ø 6.7 cm, H 7 cm

SPRING TOY

- Material: galvanised steel

IL GIOCO DELLA MOLLA

- Materiale: acciaio zincato

LE RESSORT MAGIQUE

- Matériau : acier zingué

MUELLE DE JUGUETE

- Material: acero cincado

DAS SPIRALSPIEL

- Material: verzinkter Stahl

PACKAGINGcardboard box
L 7 x H 7.2 x W 7 cm**DISPLAY**material: cardboard
L 15 x H 28 x W 22.5 cm**12 PCS****SLKIT1**

8 051128 751550



MEMORY

L 4.5 x H 1.5 W 6 cm

LIGHT-UP MEMORY GAME WITH SOUND EFFECTS

- Material: plastic

GIOCO DI MEMORIA LUMINOSO E SONORO

- Materiale: plastica

JEU DE MÉMOIRE LUMINEUX ET SONORE

- Matériau : plastique

JUEGO DE MEMORIA LUMINOSO Y SONORO

- Material: plástico

GEDÄCHTNISPIEL MIT LICHT- UND TONEFFEKTEN

- Material: Kunststoff



4 x LR1130 batteries (included)

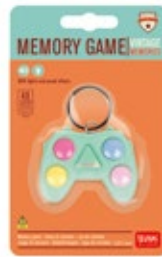

With lights and sounds

PACKAGINGblister card
L 9.5 x H 15.5 W 2.3 cm**DISPLAY**material: cardboard
L 11 x H 28 x W 23 cm**8 PCS**

MMKKIT1



8 051128 756326



With key ring

MEMORY

L 6.4 x H 6.4 x W 2 cm

LIGHT AND SOUND MEMORY GAME

- Material: plastic

GIOCO DI MEMORIA LUMINOSO E SONORO

- Materiale: plastica

JEU DE MÉMOIRE LUMINEUX ET SONORE

- Matériau : plastique

JUEGO DE MEMORIA CON LUCES Y SONIDO

- Material: plástico

GEDÄCHTNISPIEL MIT LICHT UND SOUND

- Material: Kunststoff



3 x LR44 batteries (included)



With lights and sounds

PACKAGINGcarded
L 10.3 x H 13 x W 2.3 cm**DISPLAY**material: cardboard
L 12 x H 25.2 x W 18 cm**8 PCS**

MEZKIT1



8 051128 755527

**YO-YO**

Ø 6 cm, H 2.8 cm

YO-YO

- With clutch and lights
- Material: plastic

YO-YO

- Con frizione e luci
- Materiale: plastica

YO-YO

- Avec embrayage et lumières
- Matériau : plastique

YOYÓ

- Con embrague y luces
- Material: plástico



1 x LR41 battery (included, non-replaceable)



With lights

JO-JO

- Mit Kupplung und Lichtern
- Material: Kunststoff

**PACKAGING**window box
L 10 x H 11 x W 4.5 cm**SOLD X 4**

YOY0001



8 052783 615621



15 PUZZLE

L 10 x H 2 x W 10 cm

15 PUZZLE

- Number puzzle with tiles from 1 to 15
- Material: beech wood

PUZZLE DEL 15

- Rompicapo numerico con tessere da 1 a 15
- Materiale: legno di faggio

JEU DE TAQUIN

- Casse-tête numérique avec des pions de 1 à 15
- Matériau : bois de hêtre

JUEGO DEL 15

- Rompecabezas numérico con fichas del 1 al 15
- Material: madera de haya

15-PUZZLE

- Zahlen-Knobelspiel mit Plättchen von 1 bis 15
- Material: Buchenholz

**PACKAGING**window box
L 10.3 x H 13.8 x W 2.5 cm**SOLD X 4**

FIP0001



8 059174 833121

**TUMBLING TOWER**

L 7.4 x H 23.3 x W 7.4 cm

TUMBLING TOWER GAME

- Contents: 48 blocks and cardboard support to hold the tower inside the box
- Material: beech wood

IL GIOCO DELLA TORRE TRABALLANTE

- Contenuto: 48 mattoncini e supporto di cartoncino per sistemare la torre all'interno della scatola
- Materiale: legno di faggio

LE JEU DE LA TOUR INFERNALE

- Contenu : 48 briques et support en carton pour ranger la tour à l'intérieur de la boîte
- Matériau : bois de hêtre

EL JUEGO DE LA TORRE TAMBALEANTE

- Contenido: 48 piezas y soporte de cartón para colocar la torre dentro de la caja
- Material: madera de haya

DAS SPIEL DES WACKELIGEN TURMS

- Inhalt: 48 Klötze und Stapelhilfe aus Karton, um den Turm in der Schachtel zu platzieren
- Material: Buchenholz

**PACKAGING**cardboard box
L 8.4 x H 24 x W 8.4 cm**SOLD X 2**

TOW0001



8 056304 486233

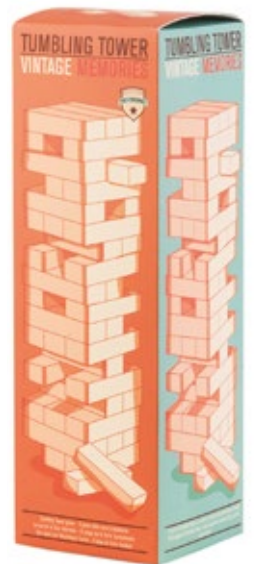

LET'S SUDOKU!

L 14 x H 14 x W 2.7 cm

SUDOKU

- 81 numbered pegs
- Playing instructions included
- Material: beech wood

SUDOKU

- 81 pioli numerati
- Istruzioni di gioco incluse
- Materiale: legno di faggio

SUDOKU

- 81 pièces numérotées
- Règles de jeu incluses
- Matériau : bois de hêtre

SUDOKU

- 81 tacos numerados
- Instrucciones del juego incluidas
- Material: madera de haya

SUDOKU

- 81 nummerierte Stifte
- Inklusive Spielanleitung
- Material: Buchenholz

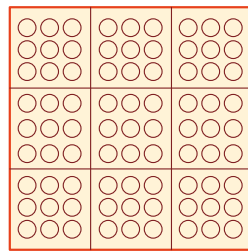

1 board

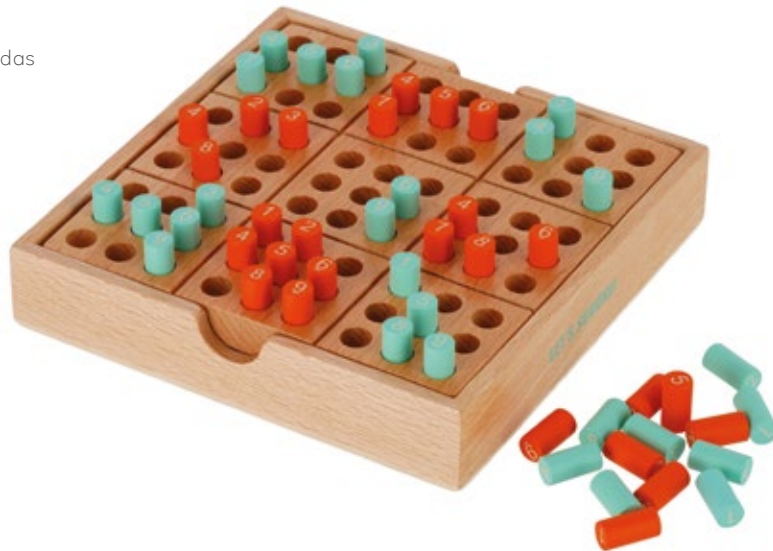

81 numbered pegs

**PACKAGING**

window box
L 14.5 x H 16.5 x W 3 cm

SOLD X 4

SUD0001

**MIKADO**

H 18 cm

MIKADO

- 41 bamboo sticks in 5 different colours
- Material: bamboo

SHANGHAI

- 41 bastoncini in bambù di 5 colori diversi
- Materiale: bambù

MIKADO

- 41 baguettes en bambou de 5 couleurs différentes
- Matériau : bambou

MIKADO

- 41 palillos de bambú de 5 colores diferentes
- Material: bambú

MIKADO

- 41 Bambusstäbchen in 5 verschiedenen Farben
- Material: Bambus

PACKAGING

cardboard tube
Ø 4 cm, H 20 cm

SOLD X 8

MIK0001



WOODEN CHESS & DRAUGHTS

L 28.2 x H 1.5 x W 28.7 cm (opened)

CHESS AND DRAUGHTS

- Easy and secure closure, the pieces can be placed back inside the board at the end of the game
- Material: beech wood

SCACCHI E DAMA

- Chiusura facile e sicura, i pezzi si possono riporre all'interno della scacchiera al termine del gioco
- Materiale: legno di faggio

ÉCHECS ET DAMES

- Fermeture facile et sûre, les pièces peuvent être remises à l'intérieur de l'échiquier à la fin du jeu
- Matériau : bois de hêtre

AJEDREZ Y DAMAS

- Cierre fácil y seguro, las piezas se pueden meter dentro del tablero al final del juego
- Material: madera de haya

SCHACH UND DAME

- Einfaches und sicheres Schließen, die Figuren lassen sich nach Spielende im Inneren des Schachbrettes verstauen
- Material: Buchenholz

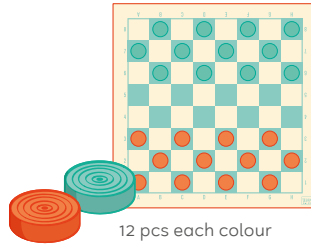

12 pcs each colour

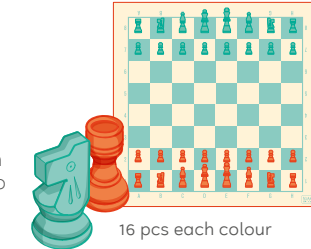

16 pcs each colour

PACKAGING

cardboard box
L 28.7 x H 15.5 x W 3.5 cm
SOLD X 4

CD0001



8 052461 965666

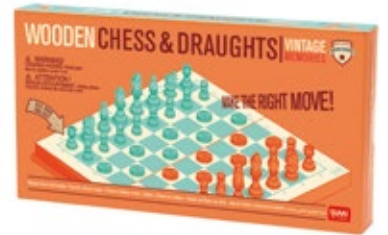

Closed



Opened



FOUR IN A LINE

L 24.8 x H 17.3 x W 17.5 cm (assembled)

4 IN A LINE

- The game board turns into a handy lid
- Material: beech wood

4 IN LINEA

- La tavola da gioco diventa un comodo coperchio
- Materiale: legno di faggio

4 EN LIGNE

- La grille de jeu devient un couvercle pratique
- Matériau : bois de hêtre

4 EN LÍNEA

- El tablero de juego se convierte en una práctica tapadera
- Material: madera de haya

4 IN EINER REIHE

- Das Spielbrett wird zu einem bequemen Deckel
- Material: Buchenholz

PACKAGING

cardboard box
L 26 x H 18.5 x W 5 cm
SOLD X 2

FOUR001



8 051739 306842



21 pcs each colour



Closed

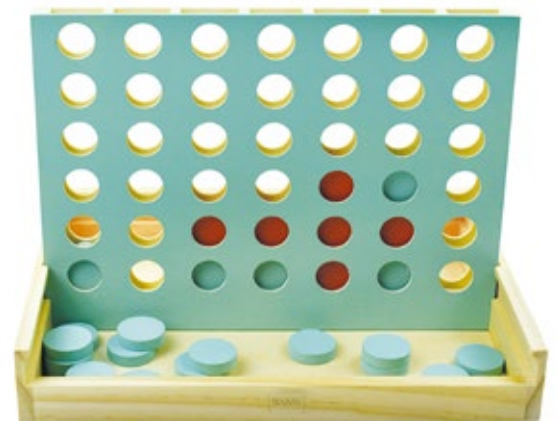

Opened

ARCADE MINI

L 5.7 x H 9.5 x W 5.7 cm

MINI ARCADE GAME

- Includes 152 8-bit games
- 1.8" TFT screen
- Language: English
- Material: plastic

MINI VIDEOGIOCO ARCADE

- Include 152 giochi in 8-bit
- Schermo TFT da 1,8"
- Lingua: inglese
- Materiale: plastica

MINI BORNE D'ARCADE

- 152 jeux en 8-bits inclus
- Écran TFT de 1,8"
- Langue : anglais
- Matériau : plastique

MINI VIDEOJUEGO ARCADE

- Incluye 152 juegos en 8 bits
- Pantalla TFT de 1,8"
- Idioma: inglés
- Material: plástico

MINI-ARCADE-SPIEL

- Enthält 152 8-Bit-Spiele
- 1,8"-TFT-Bildschirm
- Sprache: Englisch
- Material: Kunststoff

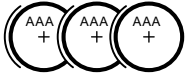
3 x AAA batteries
(not included)

With lights and sounds



PACKAGING

cardboard box w/hook
L 10 x H 18.2 x W 6.5 cm

SOLD X 4

MMAC0001



8 059174 839963

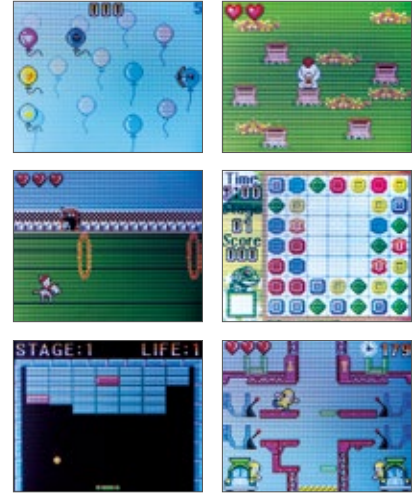

ARCADE ZONE

L 8.5 x H 15.4 x W 9 cm

MINI ARCADE GAME

- Includes 240 8-bit games
- 2.5" TFT screen
- Language: English
- Material: plastic

MINI VIDEOGIOCO ARCADE

- Include 240 giochi in 8-bit
- Schermo TFT da 2,5"
- Lingua: inglese
- Materiale: plastica

MINI BORNE D'ARCADE

- 240 jeux en 8-bits inclus
- Écran TFT de 2,5"
- Langue : anglais
- Matériau : plastique

MINI VIDEOJUEGO ARCADE

- Incluye 240 juegos en 8 bits
- Pantalla TFT de 2,5"
- Idioma: inglés
- Material: plástico

MINI-ARCADE-SPIEL

- Enthält 240 8-Bit-Spiele
- 2,5"-TFT-Bildschirm
- Sprache: Englisch
- Material: Kunststoff

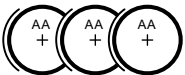
3 x AA batteries
(not included)

With lights and sounds



PACKAGING

window box w/hook
L 10.2 x H 23 x W 10.2 cm

SOLD X 4

MAC0001



8 059174 839970



ARCADE SPEED RACE

L 8,5 x H 16 x 8 cm

MINI ARCADE GAME

- Includes 30 games
- 2.4" TFT screen
- Language: English
- Material: plastic

MINI VIDEOGIOCO ARCADE

- Include 30 giochi
- Schermo TFT da 2,4"
- Lingua: inglese
- Materiale: plastica

MINI BORNE D'ARCADE

- Inclut 30 jeux
- Écran TFT de 2,4"
- Langue : anglais
- Matériau : plastique

MINI VIDEOJUEGO ARCADE

- Incluye 30 juegos
- Pantalla TFT de 2,4"
- Idioma: inglés
- Material: plástico

MINI-ARCADE-VIDEOSPIEL

- Beinhaltet 30 Spiele
- TFT-Bildschirm 2,4 Zoll
- Sprache: Englisch
- Material: Kunststoff

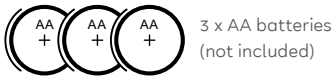
**PACKAGING**window box w/hook
L 10,2 x H 23 x W 10,2 cm**SOLD X 4**

RAC0001

**GALACTIC RACE**

L 14.4 x H 10.5 x W 24.8 cm

PINBALL ARCADE

- Electronic scoreboard
- Double control flippers
- Material: plastic

FLIPPER ARCADE

- Segnapunti elettronico
- Levette con doppio controllo
- Materiale: plastica

FLIPPER D'ARCADE

- Tableau d'affichage du score électronique
- Batteurs à double contrôle
- Matériau : plastique

PINBALL ARCADE

- Marcador electrónico
- Paletas con doble control
- Material: plástico

ARCADE FLIPPERAUTOMAT

- Elektronischer Punktezähler
- Zwei einzeln steuerbare Flipper-Hebel
- Material: Kunststoff

**PACKAGING**window box
L 16,5 x H 10,6 x W 27 cm**SOLD X 4**

FLIP0001



POCKET ARCADE GAME

L 3.5 x H 5.5 x W 1.5 cm

MINI PORTABLE CONSOLE

- Includes 11 8-bit games
- 1.25" LCD screen
- Language: English
- Material: plastic

MINI CONSOLE PORTATILE

- Include 11 giochi in 8-bit
- Schermo LCD da 1,25"
- Lingua: inglese
- Materiale: plastica

MINI CONSOLE PORTABLE

- 11 jeux en 8-bits inclus
- Écran LCD de 1,25"
- Langue : anglais
- Matériau : plastique

MINICONSOLA PORTÁTIL

- Incluye 11 juegos en 8 bits
- Pantalla LCD de 1,25"
- Idioma: inglés
- Material: plástico

TRAGBARE MINI-KONSOLE

- Enthält 11 8-Bit-Spiele
- 1,25"-LCD-Bildschirm
- Sprache: Englisch
- Material: Kunststoff

2 x LR44 batteries
(included)

With sounds

PACKAGINGcarded
L 10 x H 15 x W 1.7 cm**DISPLAY**material: cardboard
L 11.5 x H 26 x W 21.5 cm**8 PCS**

MVGKIT1



8 051128 754902



Keychain included

SUPER ARCADE STATION

L 5.7 x H 9.4 x W 2.2 cm

MINI PORTABLE CONSOLE

- Includes 152 8-bit games
- 1.8" TFT screen
- Language: English
- Material: plastic

MINI CONSOLE PORTATILE

- Include 152 giochi in 8-bit
- Schermo TFT 1,8"
- Lingua: inglese
- Materiale: plastica

MINI CONSOLE PORTABLE

- Contient 152 jeux en 8-bit
- Écran TFT de 1,8"
- Langue : anglais
- Matériau : plastique

MINICONSOLA PORTÁTIL

- Incluye 152 juegos de 8 bits
- Pantalla TFT de 1,8"
- Idioma: inglés
- Material: plástico

TRAGBARE MINI-KONSOLE

- Enthält 152 verschiedene 8-Bit-Spiele
- TFT-Bildschirm 1,8 Zoll
- Sprache: Englisch
- Material: Kunststoff

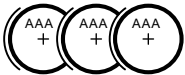
3 x AAA batteries
(not included)

With lights and sounds

PACKAGINGwindow box w/ hook
L 8 x H 18 x W 2.6 cm**SOLD X 4**

SAS0001



8 052694 001193



ARCADE PUNCHBALL

L 7 x H 14 x 9 cm

MINI PUNCHBALL ARCADE GAME

- 3 different game intervals: 45, 90 or 120 seconds
- Material: plastic

MINI GIOCO ARCADE PUNIGBALL

- 3 diversi intervalli di gioco: 45, 90, 120 secondi
- Materiale: plastica

MINI BORNE D'ARCADE PUNCHING-BALL

- 3 intervalles de jeu différents : 45, 90 ou 120 secondes
- Matériau : plastique

MINIJUEGO ARCADE DE BOXEO

- 3 intervalos de juego diferentes: 45, 90 y 120 segundos
- Material: plástico

MINI-ARCADE-SPIEL PUNCHINGBALL

- 3 verschiedene Spielintervalle: 45, 90 oder 120 Sekunden
- Material: Kunststoff

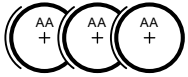

3 x AA batteries
(not included)



With lights and sounds

**PACKAGING**

window box w/hook
L 10.2 x H 23 x W 10.2 cm

SOLD X 4

PBL0001



8 053610 782585

**WHAT A SHOT!**

L 10 x H 32.5 x 22 cm

MINI BASKETBALL ARCADE GAME

- 3 different game intervals: 45, 90 or 120 seconds
- Material: plastic

MINI GIOCO ARCADE DI BASKET

- 3 diversi intervalli di gioco: 45, 90, 120 secondi
- Materiale: plastica

MINI BORNE D'ARCADE DE BASKET

- 3 intervalles de jeu différents : 45, 90 ou 120 secondes
- Matériau : plastique

MINIJUEGO ARCADE DE BALONCESTO

- 3 intervalos de juego diferentes: 45, 90 y 120 segundos
- Material: plástico

MINI-ARCADE-SPIEL BASKETBALL

- 3 verschiedene Spielintervalle: 45, 90 oder 120 Sekunden
- Material: Kunststoff

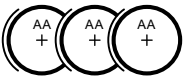

3 x AA batteries
(not included)



With lights and sounds

**PACKAGING**

window box
L 11 x H 23 x W 22.5 cm

SOLD X 4

BASK0001



8 053610 782608



HEAD-TO-HEAD ARCADE GAME

L 8.7 x H 11 x W 20 cm

TWO-PLAYER MINI ARCADE GAME

- Includes 300 8-bit games
- Dual 2.8" TFT screens
- Language: English
- Material: plastic

MINI VIDEOGIOCO ARCADE A DUE GIOCATORI

- Include 300 giochi in 8-bit
- Doppio schermo TFT 2,8"
- Lingua: inglese
- Materiale: plastica

MINI BORNE D'ARCADE DEUX JOUEURS

- Contient 300 jeux en 8-bit
- Double écran TFT 2,8"
- Langue : anglais
- Matériau : plastique

MINI VIDEOJUEGO ARCADE PARA DOS JUGADORES

- Incluye 300 juegos a 8 bits
- Doble pantalla TFT de 2,8"
- Idioma: inglés
- Material: plástico

MINI-ARCADE-VIDEOSPIEL FÜR ZWEI SPIELER

- Enthält 300 verschiedene 8-Bit-Spiele
- Doppelter TFT-Bildschirm 2,8 Zoll
- Sprache: Englisch
- Material: Kunststoff

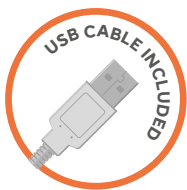

With lights and sounds

DUAL POWER SUPPLY

OR

**PACKAGING**

window box
L 10 x H 13 x W 11.9 cm
SOLD X 2

HTH0001

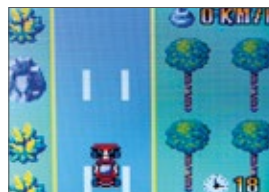
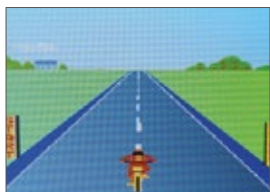

8 052694 001186

**ARCADE DISPLAY**

4-sided, with shelves and hooks
Material: cardboard, plastic
Assortment:

- 12 pcs x Super Arcade Station, Arcade Mini, Arcade Zone, Arcade Speed Race
- 8 pcs x Head-to-head arcade game
- 2 kit x Pocket Arcade Game

ARCADE-GROUP23



8 052694 004576



WONDERLAND *For the little dreamers*

Spark the light of magic in a child's eyes

SOFT DREAMS

Ø 8,3, H 13 cm

RECHARGEABLE NIGHT LIGHT

- Light effect: colour-changing light
- USB rechargeable
- Material: plastic, silicone

LUCE NOTTURNA RICARICABILE

- Effetto luminoso: luce multicolore
- Ricaricabile USB
- Materiale: plastica, silicone

VEILLEUSE RECHARGEABLE

- Effet lumineux : lumière multicolore
- Rechargeable par USB
- Matériau : plastique, silicone

LÁMPARA NOCTURNA RECARGABLE

- Efecto luminoso: luz que cambia de color
- Recargable con USB
- Material: plástico, silicona

WIEDERAUFLADBARES NACHTLICHT

- Lichteffect: bunt wechselndes Licht
- Wiederaufladbar über USB
- Material: Kunststoff, Silikon

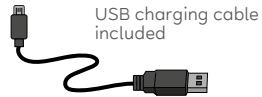

PACKAGING
cardboard box
L 10 x H 13,2 x W 9,5 cm
SOLD X 2

KITTY
NLS0001



POP MATERIAL

WINDOW DISPLAY
L 29,7 x H 42 cm

Order 6 pcs of each design and you will receive a window display.

NLSPOP-GROUP



PACKAGING
cardboard box
L 10 x H 13,2 x W 9,5 cm
SOLD X 2

DINO
NLS0002



SWEET DREAMS

NIGHT LIGHT

- Light effect: colour changing light
- Material: PVC

LUCE NOTTURNA

- Effetto luminoso: luce multicolore
- Materiale: PVC

VEILLEUSE

- Effet lumineux : lumière multicolore
- Matériau : PVC

LÁMPARA NOCTURNA

- Efecto luminoso: luz que cambia de color
- Material: PVC

NACHTLICHT

- Lichteffect: bunt wechselndes Licht
- Material: PVC



3 x LR44 batteries (included)



PACKAGING
cardboard box
L 11 x H 15 x W 11 cm
SOLD X 2

UNICORN
L 10.4 x H 11.5 x W 9.6 cm
NILO001



PACKAGING
cardboard box
L 11 x H 15 x W 11 cm
SOLD X 2

SPACE
L 9.7 x H 14 x W 9.7 cm
NILO003



PACKAGING
cardboard box
L 11 x H 15 x W 11 cm
SOLD X 2

MOON
L 14 x H 11.5 x W 8.2 cm
NILO004



PACKAGING
cardboard box
L 11 x H 15 x W 11 cm
SOLD X 2

PANDA
L 9 x H 11.5 x W 8 cm
NILO005



SUPER MOON

Ø 15 cm

ADHESIVE GLOW-IN-THE-DARK MOON

- Material: PVC

LUNA FOSFORESCENTE ADESIVA

- Materiale: PVC

LUNE PHOSPHORESCENTE AUTOCOLLANTE

- Matériau : PVC

LUNA FOSFORESCENTE ADHESIVA

- Material: PVC

KLEBE-LEUCHTMOND

- Material: PVC

**PACKAGING**

carded
L 19,5 x H 24 x W 2 cm

**DISPLAY**

material: cardboard
L 20,7 x H 33 x W 21 cm

8 PCS

GLWKIT2



8 051128 755312



Base with single-use adhesive

SUPER STARS

L MAX 8.5 cm

ADHESIVE GLOW-IN-THE-DARK STARS

- Material: PVC

STELLE FOSFORESCENTI ADESIVE

- Materiale: PVC

ÉTOILES PHOSPHORESCENTES AUTOCOLLANTES

- Matériau : PVC

ESTRELLAS FOSFORESCENTES ADHESIVAS

- Material: PVC

KLEBE-LEUCHTSTERNE

- Material: PVC

**PACKAGING**

carded
L 18.5 x H 17.8 x W 1 cm

**DISPLAY**

material: cardboard
L 19.5 x H 26 x W 19.5 cm

10 PCS

GLWKIT1



8 051128 755329



25 single-use double-sided stickers included



MUSIC BOX

L 12 x H 9 x W 13.5 cm

MUSICAL JEWELLERY BOX

- Mirror inside
- Material: cardboard

CARILLON PORTAGIOIE

- Specchio all'interno
- Materiale: cartone

BÔTE À BIJOUX MUSICALE

- Miroir à l'intérieur
- Matériau : carton

CAJA DE MÚSICA CON JOYERO

- Espejo en el interior
- Material: cartón

SCHMUCKKASTEN MIT SPIELUHR

- Spiegel im Innern
- Material: Karton



PACKAGING
cardboard box
L 12.5 x H 10 x W 15 cm
SOLD X 4

UNICORN
CRL0001



Drawer for storing jewellery and small items



COIN BANK

COIN BANK

- With rubber stopper
- Material: ceramic

SALVADANAIO

- Con tappo in gomma
- Materiale: ceramica

TIRELIRE

- Avec bouchon en caoutchouc
- Matériau : céramique

HUCHA

- Con tapón de goma
- Material: cerámica

SPARDOSE

- Mit Gummiverschluss
- Material: Keramik

SOLD X 2



DINO

L 13.5 x H 18 x W 10 cm

PACKAGING

cardboard box
L 18.5 x H 21.5 x W 14 cm

SAVE0009



UNICORN

L 20.5 x H 18.5 x W 7.5 cm

PACKAGING

cardboard box
L 23 x H 21.5 x W 11 cm

SAVE0010



PIGGY

L 14 x H 12 x W 12 cm

PACKAGING

cardboard box
L 16 x H 15.5 x W 13 cm

SAVE0011



SPIN ME ROUND

Ø 13 cm, H 12 cm

SPINNING TOP

- Material: metal, ABS

TROTTOLA

- Materiale: metallo, ABS

TOUPIE

- Matériau : métal, ABS

PEONZA

- Material: metal, ABS

KREISEL

- Material: Metall, ABS

PACKAGING

window box
L 10.8 x H 10.8 x W 10.8 cm

SOLD X 4

UNICORN

TOP0001



8 052694 001667



PACKAGING

window box
L 10.8 x H 10.8 x W 10.8 cm

SOLD X 4

SPACE

TOP0002



8 052694 001674

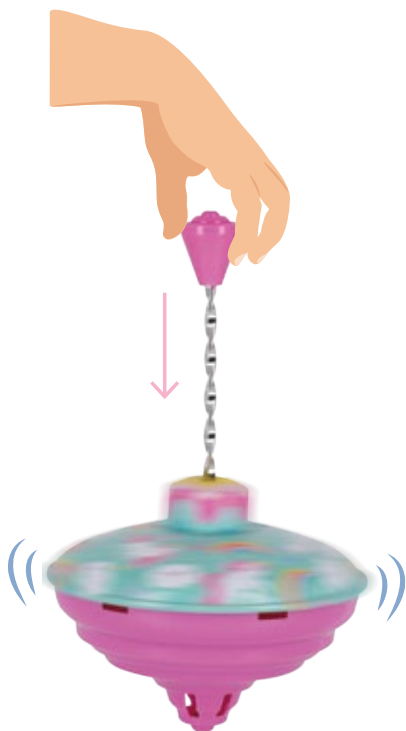

MINI BALL SET

L 11 x H 15.5 x W 11 cm (MAX)

SET OF 3 MINI BALLS

- American football, basketball and football
- Material: plastic

SET DI 3 MINI PALLONI

- Football americano, basket e calcio
- Materiale: plastica

SET DE 3 MINI BALLONS

- Football américain, basket et foot
- Matériau : plastique

SET DE 3 MINI BALONES

- Fútbol americano, baloncesto y fútbol
- Material: plástico

SET MIT 3 MINI-BÄLLEN

- Amerikanischer Football, Basketball und Fußball
- Material: Kunststoff

PACKAGING

window box
L 30 x H 15.5 x W 11 cm

SOLD X 2

BS0002



8 054320 564997



Football: Ø 11 cm

Basketball: Ø 11 cm

American football:
Ø 9.5 cm, L 15.5 cm



BUBBLE BUBBLE

Ø 4 cm, H 11.3 cm

SOAP BUBBLES

- Bubble wand attached to the cap
- With a mini puzzle on the cap

BOLLE DI SAPONE

- Soffiatore inserito nel tappo
- Con piccolo rompicapo sul tappo

BULLES DE SAVON

- Souffleur intégré au couvercle
- Doté d'un petit casse-tête sur le couvercle

POMPAS DE JABÓN

- Soplador incorporado en el tapón
- Incluye un pequeño rompecabezas en el tapón

SEIFENBLASEN

- Stab zum Blasen im Deckel integriert
- Mit kleinem Geduldsspiel im Deckel

DISPLAY

material: cardboard
L 23.5 x H 33 x W 23 cm

36 PCS

SBKIT1

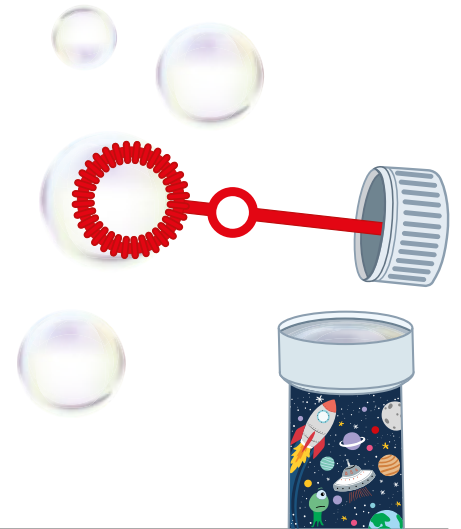

LIGHT-UP BOUNCY BALL

Ø 7.5 cm

LIGHT-UP BOUNCY BALL

- Lights up when it bounces
- Material: TPU, liquid, TPR

PALLINA RIMBALZANTE LUMINOSA

- Si illumina quando rimbalza
- Materiale: TPU, liquido, TPR

BALLE REBONDISSANTE LUMINEUSE

- Elle s'illumine lorsqu'elle rebondit
- Matériau : TPU, liquide, TPR

PELOTA LUMINOSA DE REBOTE

- Se ilumina cuando rebota
- Material: TPU, líquido, TPR

LEUCHTENDER FLUMMI

- Leuchtet, wenn er hüpf
- Material: TPU, Flüssigkeit, TPR



2 x AG1 batteries (included, non-replaceable)



DISPLAY

material: cardboard
L 23 x H 17 x W 16 cm

6 PCS

UNICORN

BOBKIT1



3 x AG10 batteries (included, non-replaceable)

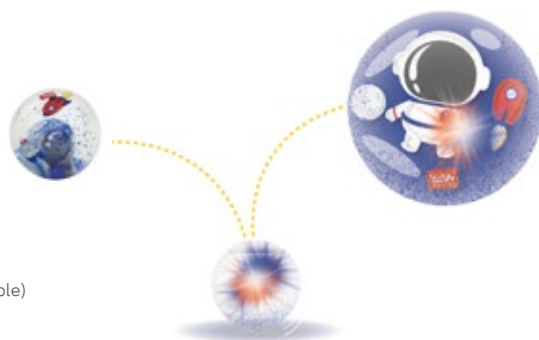

DISPLAY

material: cardboard
L 23 x H 17 x W 16 cm

6 PCS

SPACE

BOBKIT2



MINI WATER GAME

L 15.2 x H 7 x W 2 cm

MINI WATER GAME

• Material: plastic, water

MINI GIOCO AD ACQUA

• Materiale: plastica, acqua

MINI JEU D'EAU

• Matériau : plastique, eau

MINI JUEGO DE AGUA

• Material: plástico, agua

MINI-WASSERFLIPPER

• Material: Kunststoff, Wasser



No batteries needed



PACKAGING
window box
L 16 x H 10 x W 2.5 cm
SOLD X 6

UNICORN
MWG0001



PACKAGING
window box
L 16 x H 10 x W 2.5 cm
SOLD X 6

SPACE
MWG0002



MINI PINBALL

L 17.7 x H 29 x W 1.8 cm

MINI PINBALL

• Material: plastic

MINI FLIPPER

• Materiale: plastica

MINI FLIPPER

• Matériau : plastique

MINI PINBALL

• Material: plástico

MINI-FLIPPERAUTOMAT

• Material: Kunststoff



PACKAGING
window box
L 18 x H 32 x W 2 cm
SOLD X 4

UNICORN
PBG0003



PACKAGING
window box
L 18 x H 32 x W 2 cm
SOLD X 4

SPACE
PBG0004



KALEIDOSCOPE

Ø 4.5 cm, H 19 cm

KALEIDOSCOPE

• Material: paper, polypropylene, PMMA

CALEIDOSCOPIO

• Materiale: carta, polipropilene, PMMA

KALÉIDOSCOPE

• Matériau : papier, polypropylène, PMMA

CALEIDOSCOPIO

• Material: papel, polipropileno, metacrilato

KALEIDOSKOP

• Material: Papier, Polypropylen, PMMA



DISPLAY

material: cardboard
L 15.5 x H 27 x W 15 cm

9 PCS

UNICORN

KALKIT1



DISPLAY

material: cardboard
L 15.5 x H 27 x W 15 cm

9 PCS

SPACE

KALKIT2



SHAKE IT UP!

Ø 14.5 cm, W 4.5 cm

TAMBOURINE

• Material: plywood, metal

TAMBURELLO

• Materiale: compensato di legno, metallo

TAMBOURIN

• Matériau : contreplaqué, métal

PANDERETA

• Material: contrachapado de madera, metal

TAMBURIN

• Material: Schichholz, Metall



PACKAGING
window box
L 16.5 x H 21 x W 5 cm
SOLD X 3

UNICORN
TAM0001



PACKAGING
window box
L 16.5 x H 21 x W 5 cm
SOLD X 3

SPACE
TAM0002



MY SECRET DIARY

L 11 x H 15.5 x W 2.4 cm

SECRET DIARY WITH PADLOCK

- 100 g/m² paper, 328 pages

DIARIO SEGRETO CON LUCCHETTO

- Carta 100 g/m², 328 pagine

JOURNAL INTIME AVEC CADENAS

- Papier 100 g/m², 328 pages

DIARIO SEGRETO CON CANDADO

- Papel 100 g/m², 328 páginas

GEHEIMES TAGEBUCH MIT VORHÄNGSCHLOSS

- Papier 100 g/m², 328 Seiten



PACKAGING

PET box
L 15 x H 15.8 x W 2.8 cm

SOLD X 2



UNICORN
DIA0011



SPACE
DIA0012



PANDA
DIA0013



GROWING UP

ON THE GO

LET'S DRINK!

Ø 7.5 cm, H 17 cm - 400 ml

KIDS' BOTTLE

- Lightweight
- Hermetic seal
- Material: copolyester

BORRACCIA PER BAMBINI

- Leggera
- Chiusura ermetica
- Materiale: copoliestere

GOURDE POUR ENFANT

- Légère
- Fermeture hermétique
- Matériau : copolyester

CANTIMPLORA PARA NIÑOS

- Ligera
- Cierre hermético
- Material: copoliéster

KINDERTRINKFLASCHE

- Leicht
- Hermetischer Verschluss
- Material: Copolyester

SOLD X 4



UNICORN
KBOT0001



SPACE
KBOT0002



POP MATERIAL

WINDOW DISPLAY
L 38 x H 44 cm

Order 4 pcs of each design and you will receive a window display.

KBOT-POP-GROUP



BE BRAVE

30 PRINTED ADHESIVE BANDAGES

- 30 plasters, assorted shapes
- Strong, hypoallergenic and breathable
- Material: PE

30 CEROTTI STAMPATI

- 30 cerotti formati assortiti
- Resistenti, ipoallergenici e traspiranti
- Materiale: PE



Breathable



Latex-free

30 PANSEMENTS IMPRIMÉS

- 30 pansements de formes différentes assorties
- Résistants, hypoallergéniques et respirants
- Matériau : PE

30 TIRITAS ESTAMPADAS

- 30 tiritas con formatos variados
- Resistentes, hipoalergénicas y transpirables
- Material: PE

30 BEDRUCKTE PFLASTER

- 30 Pflaster in verschiedenen Größen
- Widerstandsfähig, hypoallergen und atmungsaktiv
- Material: PE



PACKAGING

tin box
L 7 x H 9.4 x W 2.8 cm



DISPLAY

material: cardboard
L 7.7 x H 22 x W 20 cm

6 PCS

UNICORN

PLSKIT1



PACKAGING

tin box
L 7 x H 9.4 x W 2.8 cm



DISPLAY

material: cardboard
L 7.7 x H 22 x W 20 cm

6 PCS

SPACE

PLSKIT2



Pre-assorted displays

SMALL FLOOR SPINNER DISPLAY

4-sided, with shelves and hooks
Swivel wheels
Material: wood and iron, dust-repellent paint
L 65 x H 171.5 x W 65 cm

DISPLAY + PRESELECTED SIDE:

EXTRAORDINARY STATIONERY COLLECTION

DISGREYSM-FIXED



8 054320 564843

CHOOSE 3 SIDES FROM THE FOLLOWING*:

*You can't choose the same side twice

HOME SWEET HOME COLLECTION

DISGREYSM-HSHLIGHT



8 054320 564904

CUTIE BEAUTY + BODY AND SOUL COLLECTION

DISGREYSM-BEAUTY



8 054320 564850

VINTAGE MEMORIES + LOL COLLECTION

DISGREYSM-VINLLOL



8 052694 004408

WONDERLAND COLLECTION

DISGREYSM-WOND



8 052694 004415

EXTRAORDINARY STATIONERY COLLECTION (ADDITIONAL SIDE)

DISGREYSM-STATIONERY



8 054320 564874

STAR TECH COLLECTION

DISGREYSM-HITECH



8 054320 564881

TO TRAVEL IS TO LIVE COLLECTION + BIKEAHOLIC COLLECTION

DISGREYSM-TRAVELBIKE



8 054320 564898

SOS COLLECTION

DISGREYSM-SOS



8 054320 564867

With the order of this pre-assorted display you will receive a Legami official partner window sticker



WINDOWS STICKER
L 20 x H 6 cm



MEDIUM FLOOR DISPLAY

4-sided, with shelves and hooks
Swivel wheels
Material: wood and iron, dust-repellent paint
L 100 x H 140 x W 80 cm

DISPLAY + PRESELECTED SIDES:

EXTRAORDINARY STATIONERY COLLECTION (ONE SHELF SIDE + ONE SLAT SIDE)

DISGREYME-FIXED



8 054320 564911

CHOOSE 1 SHELVES SIDE FROM THE FOLLOWING:

CUTIE BEAUTY COLLECTION + PARTNERS IN STYLE COLLECTION + BODY AND SOUL COLLECTION

DISGREYME-CUTIEBEAUTY



8 053610 782783

VINTAGE MEMORIES COLLECTION + LOL COLLECTION + WONDERLAND COLLECTION

DISGREYME-VINWONLLOL



8 054320 564935

CHOOSE 1 SLAT SIDE FROM THE FOLLOWING:

HOME SWEET HOME COLLECTION

DISGREYME-HSHLIGHT



8 054320 564942

SOS + STAR TECH COLLECTION

DISGREYME-SOSTECH



8 053610 782790

TO TRAVEL IS TO LIVE COLLECTION + BIKEAHOLIC COLLECTION

DISGREYME-TRAVELBIKE



8 054320 564966

STAR TECH COLLECTION

DISGREYME-STARTECH



8 053610 782776

With the order of this pre-assorted display you will receive a Legami official partner window sticker



WINDOWS STICKER
L 20 x H 6 cm



Shelf side

Slat side

SUPER SOFT! DISPLAY

Cardboard four shelves,
resistant structure,
removable crowner
L 62 x H 175 x W 37 cm

**FULL ASSORTED DISPLAY
4 PCS X DESIGN**

DISSUPERSOFT-GROUP



8 053610 782677



BOOK LOVERS DISPLAY

Counter spinner display
Material: cardboard, plastic
Ø 20, H 37 cm

FULL ASSORTED DISPLAY:

BOOKMARKS (PAGE 115)

Bookmarks with elastics: 45 pcs

READING LIGHTS (PAGE 280)

Super night dream: 4 pcs

Mini night dream: 1 kit

Smart night dream: 1 kit

Micro night dream: 1 kit

DISBOOKLOVER-GROUP



8 054117 620721



**MINI DECORATIVE LIGHTS
RANGE + DISPLAY**

Ø 50, H 190 cm

Double-sided spinner display

Swivel wheels

42 hooks

Material: metal

FULL ASSORTED DISPLAY:

• 5 pcs x shape

• 5 pcs x A, G, L, M, R, S

• 3 pcs x B, C, D, E, F, H, I, J, K,
N, O, P, Q, T, U, V, W, X, Y, Z, &

DISLELI - GROUP



8 054320 561255



ARCADE DISPLAY



4-sided, with shelves and hooks
Material: cardboard, plastic
L 52 x H 161 x 51.5 cm

FULL ASSORTED DISPLAY:

- 12 pcs x Super Arcade Station, Arcade Mini, Arcade Zone, Arcade Speed Race
- 8 pcs x Head-to-head arcade game
- 2 kit x Pocket Arcade Game

ARCADE-GROUP23



8 052694 004576



BE BOLD DISPLAY



Material: cardboard
L 23,5 x H 26 X W 17 cm
12 pockets

FULL ASSORTED DISPLAY + POP MATERIAL 1 KIT X DESIGN

ACMPOP-GROUP



8 052694 017521



POP MATERIAL

WINDOWS DISPLAY
L 29.7 x H 42 cm

Order the full
assorted display
and you will receive
a window display.

HAPPY BIRTHDAY CANDLE DISPLAY



Material: cardboard
L 25,3 x H 26,5 x W 19,7 cm

FULL ASSORTED DISPLAY: 6 PCS X DESIGN

DISCNU-GROUP



8 052694 017583



Displays on demand

Products not included

GREETING CARDS SPINNER DISPLAY 96+48 CARDS

Floor empty display on demand
Material: metal
L 60 x H 185 x W 60 cm

MOQ:

- 96 pockets for card sizes 11.5x17 cm (10 pcs per pocket, total 960 pcs)
- 48 pockets for card sizes 7x7 cm (10 pcs per pocket, total 480 pcs)

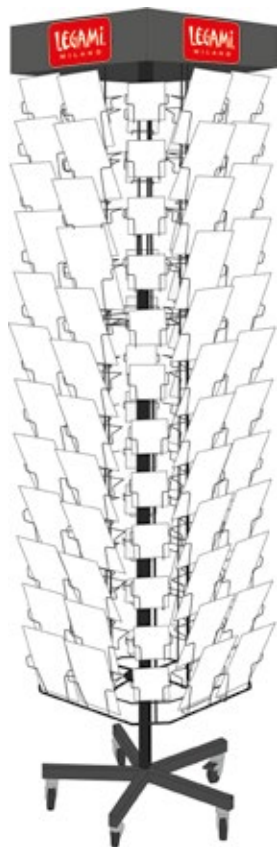

DISCAD96+48



8 052694 002923

GREETING CARDS SPINNER DISPLAY 44+44 CARDS

Floor empty display on demand
material: metal
L 35 x H 180 x W 35 cm

MOQ:

- 44 pockets for card sizes 11.5x17 cm and 10.5x15.5 cm (10 pcs per pocket, total 440 pcs)
- 44 pockets for card sizes 7x7 cm (10 pcs per pocket, total 440 pcs)

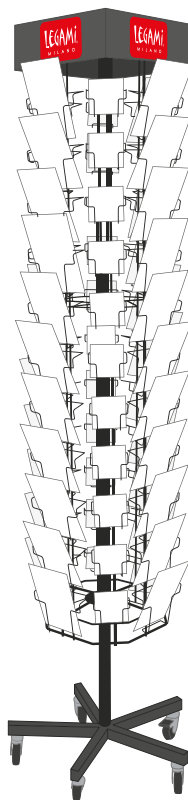

DISCAD44+44



8 052783 612996

GIFT BAGS DISPLAY

Floor empty display on demand: MOQ 132 pcs
material: metal
ø 31.5 cm, H 174 cm



DISGIF2



8 052694 004200

SMALL GREETING CARDS DISPLAY

Counter empty display on demand: MOQ 240 pcs
12 pockets
material: cardboard
L 19 x H 35.5 x W 30 cm

DISCA2x6



8 051070 279003



WRAPPING PAPER DISPLAY

Floor empty display on demand: MOQ 30 pcs
material: cardboard
L 28 x H 70 x W 30 cm

DISWRAP



8 051128 755879



NOTEBOOK COUNTER DISPLAY

Counter empty display
on demand
material: cardboard
L 29.5 x H 28.5 x W 27 cm

DISDIAS



COLOURS COLLECTION

MOQ: 30 pcs
(medium, small)

MEDIUM
MEDIUM
SMALL



PHOTO COLLECTION

MOQ: 30 pcs
(medium, small, mini spiral)

MEDIUM
SMALL
MINI
SPIRAL



SMALL
SMALL
MEDIUM
MEDIUM
MEDIUM
LARGE



SMALL
MINI
SPIRAL
MEDIUM
LARGE
SPIRAL
LARGE
MAXI
SPIRAL



NOTEBOOK FLOOR DISPLAY

Floor empty display
on demand
material: cardboard, wooden base
L 58.5 x H 158 x W 39 cm

DISDIAM



COLOURS COLLECTION

MOQ:
• small: 60 pcs
• medium: 90 pcs
• large: 30 pcs

PHOTO COLLECTION

MOQ:
• small: 30 pcs
• mini spiral: 18 pcs
• medium: 30 pcs
• large spiral: 24 pcs
• large: 24 pcs
• maxi spiral: 21 pcs

NOTEBOOK SPINNER DISPLAY

Floor empty display
on demand
material: acrylic and wood
L 47.5 x H 185 x W 47.5 cm

SMALL: H 17.3 cm | **MEDIUM:** H 23.8 cm | **LARGE:** H 27.3 cm

1 SMALL SECTION:

- small: 48 pcs

3 MEDIUM SECTIONS:

- medium: 120 pcs

2 LARGE SECTIONS:

- large: 64 pcs

TOTAL CAPACITY: 232 PCS

DISNOTGREY2



8 054117 627959



TOTE BAGS DISPLAY

Floor empty display
on demand: MOQ 60 pcs
material: metal
Ø 31.5 cm, H 187.5 cm

DISTOTE



8 052694 004217



PUZZLE DISPLAY

Floor empty display
on demand: MOQ 36 pcs
2-sided
material: cardboard,
wooden base
L 37 x H 125 x W 35 cm

DISPU



8 051128 755916



MUGS DISPLAY

Floor empty display on demand
2-sided
material: cardboard, wooden base
L 55 x H 162 x W 35 cm

MOQ: 63 pcs

- Espresso for two: 18 pcs
- Cup-puccino / Count your lucky stars: 30 pcs
- Tu vuoi fa l'americano: 15 pcs

DISMUG2



8 054320 564973



BADGE HOLDER DISPLAY

Counter empty display
on demand: MOQ 18 pcs
material: cardboard
L 13.5 x H 24.5 x W 23.5 cm

DISBH



8 055748 242009



**BADGE HOLDER
ON PAGE 261**

PASSPORT HOLDER DISPLAY

Counter empty display
on demand: MOQ 12 pcs
material: cardboard
L 15.5 x H 25.5 x W 17.5 cm

DISPH



8 055748 242016



**PASSPORT HOLDER
ON PAGE 342**

TRAVEL ORGANISER DISPLAY

Counter empty display
on demand: MOQ 12 pcs
material: cardboard
L 15.5 x H 35 x W 22 cm

DISTO



8 055748 241996



**TRAVEL ORGANIZER
ON PAGE 343**

FOLDING UMBRELLA DISPLAY

Counter empty display
on demand: MOQ 9 pcs
material: cardboard
L 17 x H 8 x W 17 cm (empty)
L 17 x H 24 x W 17 cm (full)

DISUMB



8 051128 752502



* While stock lasts



HOT&COLD VACUUM BOTTLE FLOOR DISPLAY*

Floor empty display
on demand: MOQ see page 246
material: cardboard, wooden base
L 46 x H 176 x W 39 cm

DISBOTM *



8 059174 834128



HOT&COLD COLLECTION FLOOR DISPLAY

Floor empty display
on demand: MOQ see page 246
material: cardboard, wooden base
L 60 x H 172 x W 36 cm

DISBOTM2



8 054320 565666

*Legami's 500 ml Hot & cold bottle only

SECRETS BOX MEDIUM DISPLAY

Counter empty display
on demand: MOQ 12 pcs
material: cardboard
L 27.5 x H 19.5 x W 19 cm

DISMSBM



SECRETS BOX SMALL DISPLAY

Counter empty display
on demand: MOQ 16 pcs
material: cardboard
L 27.5 x H 19 x W 19 cm

DISMSBS



SEE YOU SOON DISPLAY

Counter empty display
on demand: MOQ 15 pcs
material: cardboard
L 26 x H 22.5 x W 12 cm

DISFGC



KEY RING DISPLAY

Counter empty display
on demand: MOQ 36 pcs
material: cardboard
L 27 x H 27 x W 19.5 cm

DISGEN



POUCH AND COIN PURSE DISPLAY

Counter empty display
on demand: MOQ 68 pcs
material: metal
L 23 x H 51 x W 33.5 cm

DISFUN



MUSIC BOX DISPLAY

Counter empty display on demand:
MOQ 50 pcs
material: metal
L 23 x H 42 x W 15 cm

DISSONG



ERASABLE PENS DISPLAY

Large counter empty display on demand:
 MOQ 450 pcs
 • 15 pockets
 • material: acrylic
 • L 29.3 x H 27.5 x W 18.5 cm

DISSEP4



ERASABLE PEN REFILL SET DISPLAY

Small counter empty display on demand:
 MOQ 80 pcs
 2 hooks
 material: cardboard
 L 13 x H 27 x W 10 cm

DISREFEP



LOVELY FRIENDS REFILL SET DISPLAY

Small counter empty display on demand:
 MOQ 70 pcs
 2 hooks
 material: cardboard
 L 13 x H 27 x W 10 cm

DISREFCPP



SMART TOUCH DISPLAY

Counter empty display on demand:
 MOQ 24 pcs
 material: cardboard
 L 12.5 x H 18 x W 14.5 cm

DISPWT



SMACK DISPLAY

Counter empty display on demand: MOQ 28 pcs
 material: cardboard
 L 19 x H 16.5 x W 10 cm

DISSMACK2



BOOKMARKS SPINNER DISPLAY

Counter empty display on demand:
 14 hooks
 (hook capacity: 12 pcs)
 total capacity: 168 pcs
 material: metal
 ø 23 cm, H 46 cm

DISWIRW



COLLECTION	ITEM	N° PCS X DESIGN / COLOUR	PAGE	ITEM CODE	EAN CODE
BIKEAHOLIC	BIKE HORN RANGE	2 PCS X DESIGN	18	BIKEHORN-GROUP	8 054320 564218
BIKEAHOLIC	BIKE BELL RANGE	2 PCS X DESIGN	19	BIKEBELL-GROUP	8 054320 564201
BODY AND SOUL	WARM CUDDLES RANGE	2 PCS X DESIGN	29	WC-GROUP	8 054117 620325
CUTIE BEAUTY	SMACK RANGE + DISPLAY	4 PCS X DESIGN	48	SMACK-GROUP	8 054320 564683
EXTRAORDINARY STATIONERY	ACRYLIC MARKERS RANGE + DISPLAY + POP MATERIAL	1 KIT X DESIGN	78	ACMPOP-GROUP	8 052694 017521
EXTRAORDINARY STATIONERY	TAROT NOTEBOOKS + QUADERNI RANGE	3 PCS X SIZE	131	TAROT-GROUP	8 052694 017743
EXTRAORDINARY STATIONERY	ERASABLE PEN RANGE	1 KIT X DESIGN	54	ERASABLE-GROUP	8 052694 004354
EXTRAORDINARY STATIONERY	CLICK&CLACK RANGE	1 KIT X DESIGN	64	CLICKKIT-GROUP	8 054320 564775
EXTRAORDINARY STATIONERY	KAWAII RANGE	4 PCS X DESIGN	94	KA-GROUP	8 054117 620400
EXTRAORDINARY STATIONERY	KAWAII RANGE + POP MATERIAL	4 PCS X DESIGN	95	KAPOP-GROUP	8 053610 782745
EXTRAORDINARY STATIONERY	PENCIL CASE RANGE	4 PCS X DESIGN	96	PC-GROUP	8 054320 564539
EXTRAORDINARY STATIONERY	DESK FRIENDS RANGE	2 PCS X DESIGN	98	PHS-GROUP	8 054117 620332
EXTRAORDINARY STATIONERY	SMART NOTES RANGE	2 PCS X DESIGN	110	SMARTNOTES-GROUP	8 054320 564690
EXTRAORDINARY STATIONERY	SMART PLANNING RANGE	2 PCS X DESIGN	110	SMARTPLAN-GROUP	8 054117 620424
EXTRAORDINARY STATIONERY	SMART WEEK RANGE	2 PCS X DESIGN	111	DESKWEEK-GROUP	8 054117 620431
EXTRAORDINARY STATIONERY	PAPER THOUGHTS RANGE	3 PCS X DESIGN	111	PAPERTHOUGHTS-GROUP	8 054320 564607
EXTRAORDINARY STATIONERY	BOOKMARKS RANGE + READING LIGHTS RANGE + BOOKLOVERS DISPLAY	BOOKMARKS: -45 BOOKMARKS WITH ELASTIC READING LIGHTS: -4 SUPER NIGHT DREAM -MINI NIGHT DREAM 1 KIT -SMART NIGHT DREAM 1 KIT -MICRO NIGHT DREAM 1 KIT	115	DISBOOKLOVER-GROUP	8 054117 620721
EXTRAORDINARY STATIONERY	BOOKMARKS ZODIAC COLLECTION RANGE	3 PCS X DESIGN	117	BOOKMARKZODIAC-GROUP	8 054320 564225
EXTRAORDINARY STATIONERY	MY NOTEBOOK SMALL LINED RANGE	3 PCS X COLOUR	126	MYNOT-SL-GROUP	8 054320 564508
EXTRAORDINARY STATIONERY	MY NOTEBOOK SMALL PLAIN RANGE	3 PCS X COLOUR	126	MYNOT-SP-GROUP	8 054320 564515
EXTRAORDINARY STATIONERY	MY NOTEBOOK MEDIUM LINED RANGE	3 PCS X COLOUR	127	MYNOT-ML-GROUP	8 054320 564478
EXTRAORDINARY STATIONERY	MY NOTEBOOK MEDIUM PLAIN RANGE	3 PCS X COLOUR	127	MYNOT-MP-GROUP	8 054320 564485
EXTRAORDINARY STATIONERY	MY NOTEBOOK LARGE LINED RANGE	3 PCS X COLOUR	128	MYNOT-LL-GROUP	8 054320 564447
EXTRAORDINARY STATIONERY	MY NOTEBOOK LARGE PLAIN RANGE	3 PCS X COLOUR	128	MYNOT-LP-GROUP	8 054320 564454

COLLECTION	ITEM	N° PCS X DESIGN / COLOUR	PAGE	ITEM CODE	EAN CODE
EXTRAORDINARY STATIONERY	MY NOTEBOOK MEDIUM LINED METALLIC COLLECTION + POP MATERIAL	6 PCS X COLOUR	125	MYNOT-MLMC-GROUP	8 051128 758436
EXTRAORDINARY STATIONERY	MY NOTEBOOK MEDIUM DOTTED RANGE	3 PCS X COLOUR	129	MYNOT-DOT-GROUP	8 054320 564430
EXTRAORDINARY STATIONERY	PHOTO NOTEBOOK NEW SIZE RANGE	3 PCS X DESIGN	133	NOTPHOTO-GROUP	8 051128 758405
EXTRAORDINARY STATIONERY	QUADERNO SMALL LINED RANGE	3 PCS X DESIGN	136	A6NOT-GROUP	8 054320 564652
EXTRAORDINARY STATIONERY	QUADERNO MEDIUM LINED RANGE	3 PCS X DESIGN	137	A5NOT-GROUP	8 054320 564645
EXTRAORDINARY STATIONERY	QUADERNO MEDIUM PLAIN RANGE	3 PCS X DESIGN	138	A5NOTPLAIN-GROUP	8 054320 564591
EXTRAORDINARY STATIONERY	QUADERNO LARGE LINED RANGE	3 PCS X DESIGN	139	B5NOT-GROUP	8 054320 564669
EXTRAORDINARY STATIONERY	LARGE AND MAXI SPIRAL NOTEBOOK + POP MATERIAL	3 PCS X DESIGN	142	A4-A5NOTS-GROUP	8 052694 017576
EXTRAORDINARY STATIONERY	LARGE SPIRAL NOTEBOOK RANGE	3 PCS X DESIGN	143	A5NOTS-GROUP	8 054320 564584
EXTRAORDINARY STATIONERY	MAXI TRIO SPIRAL NOTEBOOK RANGE	3 PCS X DESIGN	144	A4NOTSTRIO-GROUP	8 054320 564355
HOME SWEET HOME	COUNT YOUR LUCKY STARS RANGE	1 PC X DESIGN	162	CUP-GROUP	8 054320 564270
HOME SWEET HOME	CUP-PUCCINO RANGE	1 PC X DESIGN	163	CUPBREAK-GROUP	8 054320 564287
HOME SWEET HOME	ESPRESSO FOR TWO RANGE	2 PCS X DESIGN	166	ESPRESSO-GROUP	8 054320 564294
HOME SWEET HOME	TU VUO' FA' L'AMERICANO RANGE	1 PC X DESIGN	167	AME-GROUP	8 054320 564737
HOME SWEET HOME	MINI DECORATIVE LIGHTS RANGE	3 PCS X LETTER	176	LELI - GROUP	8 054320 564386
HOME SWEET HOME	MINI DECORATIVE LIGHTS RANGE	3 PCS X SHAPE	177	LELIDECO - GROUP	8 054320 564379
HOME SWEET HOME	MINI DECORATIVE LIGHTS RANGE + DISPLAY	5 PCS X SHAPE 5 PCS X A, G, L, M, R, S 3 PCS X B, C, D, E, F, H, I, J, K, N, O, P, Q, T, U, V, W, X, Y, Z, &	177	DISLELI - GROUP	8 054320 561255
HOME SWEET HOME	RINGS & THINGS RANGE	4 PCS X DESIGN	178	CPL-GROUP	8 052694 004361
HOME SWEET HOME	SUPER SOFT! RANGE + FLOOR DISPLAY	4 PCS X DESIGN	180	DISSUPERSOFT-GROUP	8 053610 782677
HOME SWEET HOME	SOMETHING TO REMEMBER RANGE	2 PCS X DESIGN	192	MBO-GROUP	8 054320 564706
HOME SWEET HOME	DON'T FORGET RANGE	2 PCS X DESIGN	193	DONTFORGET-GROUP	8 054117 620370
LET'S CELEBRATE	BOWS & RIBBON SET RANGE	6 PCS X DESIGN	201	BAR-GROUP	8 054117 620363
LET'S CELEBRATE	MAXI CANDLES RANGE	3 PCS X DESIGN	226	MAXICANDLE-GROUP	8 054320 564362
LET'S CELEBRATE	HAPPY BIRTHDAY CANDLE RANGE + DISPLAY	6 PCS X DESIGN	227	DISCNU-GROUP	8 052694 017583
LOL	STRESS LESS RANGE	2 PCS X DESIGN	230	SQI-GROUP	8 052694 004378

COLLECTION	ITEM	N° PCS X DESIGN / COLOUR	PAGE	ITEM CODE	EAN CODE
ON THE GO	HOT&COLD TUMBLER RANGE + POP MATERIAL	2 PCS X DESIGN	246	TUM-GROUP	8 054117 628642
ON THE GO	HOT & COLD BOTTLE 800 ml RANGE	2 PCS X DESIGN	247	SSB-GROUP	8 054320 564751
ON THE GO	HOT & COLD BOTTLE 500 ml RANGE	2 PCS X DESIGN	248	BOTTLE-GROUP	8 054320 564980
ON THE GO	HOT & COLD 500 ml + FLOOR DISPLAY BOTTLES 500 ml	36 PCS X SIZE 500 ml	249	DISBOTM-SSB-GROUP	8 054320 564317
ON THE GO	HOT & COLD BOTTLE RANGE + SPORT LID + FLOOR DISPLAY BOTTLES 500 ml / 800 ml + POP MATERIAL	40 PCS X SIZE 500 ml 16 PCS X SIZE 800 ml 12 PCS X SPORT LID	249	DISBOTM2-SSB-GROUP	8 054117 620448
ON THE GO	HOT & COLD BOTTLE RANGE + HOT & COLD TUMBLER RANGE + SPORT LID + FLOOR DISPLAY BOTTLES 500 ml / 800 ml + POP MATERIALS	28 PCS X SIZE 500 ml 16 PCS X SIZE 800 ml 14 PCS X TUMBLERS 12 PCS X SPORT LID	249	DISBOTM2-SSBTUM-GROUP	8 054117 628611
PARTNERS IN STYLE	TOTE BAG RANGE	3 PCS X DESIGN	256	TOTEBAG-GROUP	8 051128 758412
PARTNERS IN STYLE	WHAT A WALLET! RANGE	2 PCS X DESIGN	258	WALL-GROUP	8 054320 564768
PARTNERS IN STYLE	POUCH RANGE	4 PCS X DESIGN	262	COTTPOUCH-GROUP	8 053610 782691
PARTNERS IN STYLE	COIN PURSE RANGE	4 PCS X DESIGN	263	COTTPURSE-GROUP	8 053610 782707
PARTNERS IN STYLE	SEE YOU SOON RANGE	3 PCS X DESIGN	264	FGC-GROUP	8 054117 620318
PARTNERS IN STYLE	WHAT A KEY RING! RANGE	3 PCS X DESIGN	267	KEYRING-GROUP	8 053610 782714
PARTNERS IN STYLE	LUCKY CHAIN RANGE	3 PCS X DESIGN	269	LUCKYCHAIN-GROUP	8 054320 564331
PARTNERS IN STYLE	PIN YOUR STYLE! RANGE	6 PCS X DESIGN	271	MTP-GROUP	8 052694 004385
STAR TECH	SUPER FAST RANGE	3 PCS X DESIGN	294	WCHAR-GROUP	8 054320 564713
STAR TECH	MY SUPER POWER RANGE	2 PCS X DESIGN	295	POWER-GROUP	8 054320 564638
STAR TECH	SUPERCHARGE RANGE	2 PCS X DESIGN	296	POWERSUPER-GROUP	8 054117 620356
STAR TECH	LINK UP RANGE	3 PCS X DESIGN	304	UCC-GROUP	8 054320 564324
STAR TECH	USB FLASH DRIVE RANGE	3 PCS X DESIGN	315	USB-GROUP	8 053610 782721
STAR TECH	WIRELESS MOUSE RANGE	4 PCS X DESIGN	316	WMO-GROUP	8 053610 782738
STAR TECH	WARM IT UP RANGE	3 PCS X DESIGN	317	WIU-GROUP	8 054117 628659
STAR TECH	MOUSEPAD RANGE	2 PCS X DESIGN	318	MOU-GROUP	8 054320 564409
STAR TECH	BE FREE RANGE + POP MATERIAL	4 PCS X DESIGN	326	EAR-POP-GROUP	8 051128 758429

COLLECTION	ITEM	N° PCS X DESIGN / COLOUR	PAGE	ITEM CODE	EAN CODE
STAR TECH	SINGING IN THE SHOWER RANGE	2 PCS X DESIGN	330	SHOWER-GROUP	8 054320 564676
VINTAGE MEMORIES	PUZZLE RANGE + FLOOR DISPLAY + POP MATERIAL	36 PCS	354	DISPU-GROUP	8 054117 620226
VINTAGE MEMORIES	ARCADE DISPLAY	-12 PCS X SUPER ARCADE STATION, ARCADE MINI, ARCADE ZONE, ARCADE SPEED RACE -8 PCS X HEAD-TO-HEAD ARCADE GAME -POCKET ARCADE GAME 2 KIT	366	ARCADE-GROUP23	8 052694 004576
WONDERLAND	SOFT DREAMS RANGE + POP MATERIAL	6 PCS X DESIGN	372	NLSPOP-GROUP	8 052694 004392
WONDERLAND	SWEET DREAMS RANGE	2 PCS X DESIGN	373	SWEETDRE-GROUP	8 053610 782752
WONDERLAND	LET'S DRINK RANGE + POP MATERIAL	4 PCS X DESIGN	380	KBOT-POP-GROUP	8 051128 758443
SMALL FLOOR SPINNER DISPLAY	SMALL FLOOR SPINNER DISPLAY + FIXED ASSORTMENT STATIONERY	PRE-ASSORTED PACK	382	DISGREYSM-FIXED	8 054320 564843
SMALL FLOOR SPINNER DISPLAY	VINTAGE MEMORIES + LOL ASSORTMENT	PRE-ASSORTED PACK	382	DISGREYSM-VINLOL	8 052694 004408
SMALL FLOOR SPINNER DISPLAY	WONDERLAND ASSORTMENT	PRE-ASSORTED PACK	382	DISGREYSM-WOND	8 052694 004415
SMALL FLOOR SPINNER DISPLAY	CUTIE BEAUTY + BODY & SOUL ASSORTMENT	PRE-ASSORTED PACK	382	DISGREYSM-BEAUTY	8 054320 564850
SMALL FLOOR SPINNER DISPLAY	HOME SWEET HOME ASSORTMENT	PRE-ASSORTED PACK	382	DISGREYSM-HSHLIGHT	8 054320 564904
SMALL FLOOR SPINNER DISPLAY	SOS ASSORTMENT	PRE-ASSORTED PACK	382	DISGREYSM-SOS	8 054320 564867
SMALL FLOOR SPINNER DISPLAY	EXTRAORDINARY STATIONERY ADDITIONAL ASSORTMENT	PRE-ASSORTED PACK	382	DISGREYSM-STATIONERY	8 054320 564874
SMALL FLOOR SPINNER DISPLAY	STAR TECH ASSORTMENT	PRE-ASSORTED PACK	382	DISGREYSM-HITECH	8 054320 564881
SMALL FLOOR SPINNER DISPLAY	TO TRAVEL IS TO LIVE + BIKEAHOLIC ASSORTMENT	PRE-ASSORTED PACK	382	DISGREYSM-TRAVELBIKE	8 054320 564898
MEDIUM FLOOR DISPLAY	MEDIUMFLOORDISPLAY +FIXED ASSORTMENT STATIONERY	PRE-ASSORTED PACK	382	DISGREYME-FIXED	8 054320 564911
MEDIUM FLOOR DISPLAY	STAR TECH ASSORTMENT	PRE-ASSORTED PACK	382	DISGREYME-STARTECH	8 053610 782776
MEDIUM FLOOR DISPLAY	CUTIE BEAUTY + PARTNERS IN STYLE + BODY & SOUL ASSORTMENT	PRE-ASSORTED PACK	382	DISGREYME-CUTIEBEAUTY	8 053610 782783
MEDIUM FLOOR DISPLAY	VINTAGE + WONDERLAND + LOL ASSORTMENT	PRE-ASSORTED PACK	382	DISGREYME-VINWONLOL	8 054320 564935
MEDIUM FLOOR DISPLAY	HOME SWEET HOME ASSORTMENT	PRE-ASSORTED PACK	382	DISGREYME-HSHLIGHT	8 054320 564942
MEDIUM FLOOR DISPLAY	SOS + STAR TECH ASSORTMENT	PRE-ASSORTED PACK	382	DISGREYME-SOSTECH	8 053610 782790
MEDIUM FLOOR DISPLAY	TO TRAVEL IS TO LIVE + BIKEAHOLIC ASSORTMENT	PRE-ASSORTED PACK	382	DISGREYME-TRAVELBIKE	8 054320 564966

CONTACTS

HEAD OFFICE

LEGAMI SpA SB

18, via Stezzano
24052 Azzano San Paolo (Bg), Italy
T. +39 035 534168
www.legami.com

DIRECTOR OF SALES

Francesco Arcidiacono
T. +39 035 534168
M. +39 347 8990546
francesco.arcidiacono@legami.com

AREA MANAGER - ITALY

Enrico Fassi
T. +39 035 534168
M. +39 347 4131204
enrico.fassi@legami.com

Filippo Maceroli
T. +39 035 534168
M. +39 328 6460391
filippo.maceroli@legami.com

AREA MANAGER - EXPORT (UK, IRELAND, THE NETHERLANDS, NORDICS, USA, CANADA, AUSTRALIA)

Igor Salmi
T. +39 035 534168
M. +39 349 5183603
igor.salmi@legami.com

AREA MANAGER - EXPORT (GERMANY, AUSTRIA, SWITZERLAND, EASTERN EUROPE)

Christian Termeer
T. +39 035 534168
M. +39 392 3902982
christian.termeer@legami.com

COUNTRY MANAGERS

AUSTRIA

Jerzy Ziolkowski
M +43 664 3591231
Fh.ziolkowski@gmail.com

GERMANY (KEY ACCOUNT)

Jerzy Ziolkowski
M +49 175 5637915
Fh.ziolkowski@gmail.com

GERMANY (BY)

Benedikt Mühlenbein
M +49 151 21651361
b.muehlenbein@ben-em.de

GERMANY (BW)

Hubertus Roggon
M +49 170-1847703
h.roggon@t-online.de

GERMANY (NRW)

Toy Fox - Martin Horch
M +49 173 899 27 00
M +49 176 44 44 44 38
mh@moritz-toys.de

GERMANY (BE - BB - MV - SN - ST - TH)

Stefan Wecker
M +49 160 94452331
post@stefanwecker.de

GERMANY (HB - HH - NI - SH)

Meik Oelmann
M +49 171 6422096
meik-oelmann@gmx.de

GERMANY (HE - RP - SL)

Andreas Klein
M +49 172-66 51 374
mr.trolley@gmx.de

BELGIUM & LUXEMBOURG

Artolis Lux sarl
Tristan van Overbroek
M. +32 475 395413
t.overbroek@artolislux.com

FINLAND

Inspiration 4 You Oy
Tatjana Himanen
M. + 358 50 543 7438
tatjana@inspiration4you.fi

FRANCE

Yellow Diffusion
Maud Dreullat
M. +33 6 02237364
maud.dreullat@legami.com

Charlotte Morvan
M. +33 6 66528805
charlotte.morvan@yellowdiffusion.com

NORTHERN IRELAND

Isla Agencies Ltd
Paul Jackson
M. +44 788 0682645
pjac794518@aol.com

IRELAND

Isla Agencies Ltd
Jackie Rabbitt
M. +353 878 563580
jackierabbitt@gmail.com

PORTUGAL

Estrelas de Papel
Rogério Moreira
M. +351 213 511080
rogerio.moreira@estrelasdepapel.pt

SPAIN

Som2
Santi Pares
M. +34 660 873515
santipares@somdos.com

Christophe Martin
M. +34 609 480757
chmartin@somdos.com

THE NETHERLANDS

Interesting Sales
Peter Verboom
T. +31 355263577
M. +31 611445007
info@interesting-sales.nl

DISTRIBUTORS

AUSTRALIA & NEW ZEALAND

The Paperie
Martin Burton
T. +61 417 668898
martin@thepaperie.com.au

BULGARIA

Orange International AD
Niya Arsenieva
Tel: +359 2 9810400
info@orange-bg.com

CANADA

Jannex Enterprises 1980 LTD
Adam Hes
T. +1 905 2848484
Fax. +1 905 2848485
adamh@jannex.com

CENTRAL AMERICA

Desarrollos Culturales Costarricenses D.C.C., S.A.
Sales Department
T. +506 2220 3015
info@dcc.cr

CROATIA

Soho
Robert Komazec
T. +385 1 3648717
M. +385 98 417854
robert@soho.hr

CYPRUS

Mohel Ltd
T. +357 99434562
info@kontossil1935.gr

CZECH REPUBLIC

Ski a Bike Centrum Radotin s.r.o.
Eliska Zachariasova
t. +420 731 156 535
velkoobchod@kauppa.cz

DENMARK

Kidek AB
Sales Department
T. +46 42 165520
info@kidek.dk

ESTONIA

Marmatel OY
Kristiina Rea
+372 5333 5768
kristiina@marmatel.ee

GREECE

Panos Voyatzis Sa
Panos Voyatzis
M. +30 210 3247 128
pv@fiftyfifty.gr

GREAT BRITAIN & CHANNEL ISLANDS

Stone Marketing Limited
+44 1732 771771
James Sprigg
james@stonemarketing.com

MEXICO

Casa Greha SA de CV
Sandra Gresati
T. +52 33 1374 0316
hola@grupogreha.com

NORWAY

Handysize Nordic AS
Sales Department
T. +47 21525242
ordre@handysizenordic.no

PRC - SHANGHAI OFFICE

Doris Zhang 章晓敏
T. +86 21 60 15 10 62
M. +86 138 17 99 07 47
zhang.doris@yzshanghai.cn

Raul Thomas Mora 托马斯
T. +86 21 60 15 10 62
M. +86 137 61 61 61 62
raul.mora@yzshanghai.cn

UAE, KSA, QATAR, KUWAIT BAHRAIN, OMAN, LEBANON JORDAN, EGYPT, MOROCCO, ALGERIA

Azadea Group
T. +971 4 4359 300
lifestyle.distribution@azadea.com

ROMANIA

Alma Artex SRL
Adrian Harhoi
T. +40 212 117741
adrian.harhoi@alma.ro

SLOVENIA

Acron d.o.o.
Martin Lampret
T. +386 1 620 96 28
martin@acron-trgovina.si

SOUTH AFRICA

SG Distributors
Giulietta Campanelli
T. +27 11 4449050
giulietta@sgdistributors.co.za

SWEDEN (AND THE ÅLAND ISLANDS)

Kidek AB
Sales Department
T. +46 42 165520
info@kidek.se

SWITZERLAND

Edizioni Alfa Kartos SA
Marco Danzi
T. +41 91 7916783
info@alfa-kartos.ch

TURKEY

Yemeniciler Inc
Mephisto Bookstores
Muge Deniz
T. +90 212 249 06 96
mugedeniz@mephisto.com.tr

URUGUAY

Mosca Hnos Sa
Elisa Fabricio
T. +598 2409 3141
elisa.fabricio@mosca.com.uy

FOR OTHER COUNTRIES

Refer to Head Office

All of the brands, names and models of the devices are the property of the relative companies.

AirPods, AirPods Pro, AirTag, iPad, iPhone, Lightning and Mac are trademarks of Apple Inc., registered in the U.S. and other countries.

Qi and the Qi symbol are registered trademarks of the Wireless Power Consortium.

All other brands, logos, product names and registered trademarks are the property of their respective owners.

We reserve the right to change any aspect of our programme without notice. This catalogue and the order form have been checked for accuracy. Please forgive us should any error occur nonetheless. We also accept no liability for potential errors. While we strive for utmost precision in every detail, we cannot be held responsible for any inaccuracies, nor for any subsequent loss or any damage arising from these. This catalogue is printed on environmentally safe, chlorine-free paper, unless limited by reasons of supply or production technicalities. Catalogue printed in Italy. All sizes are given in length x height x width. Our separate price list gives ordering details and terms and conditions of supply. The general terms and conditions of trade of Legami are in force.



CLIMATE PLUS



BEYOND CARBON NEUTRALITY



LEGAMI SpA SB, VIA STEZZANO 18,
24052 AZZANO SAN PAOLO (BG) ITALY
PH + 39(0)35 534168 - FAX + 39(0)35 536973
WWW.LEGAMI.COM

S P R I N G / S U M M E R 2 0 2 4

