

XTREME XCITEMENT.

BMW X.

X models make up two entirely new classes of vehicles created by BMW: Sports Activity Vehicles® (SAV®) and Sports Activity Coupes®. Distinguished by their roominess, ruggedness and sleek design, BMW SAVs demonstrate the dynamic power and premium performance that are characteristic of the brand.

BMW X MODELS

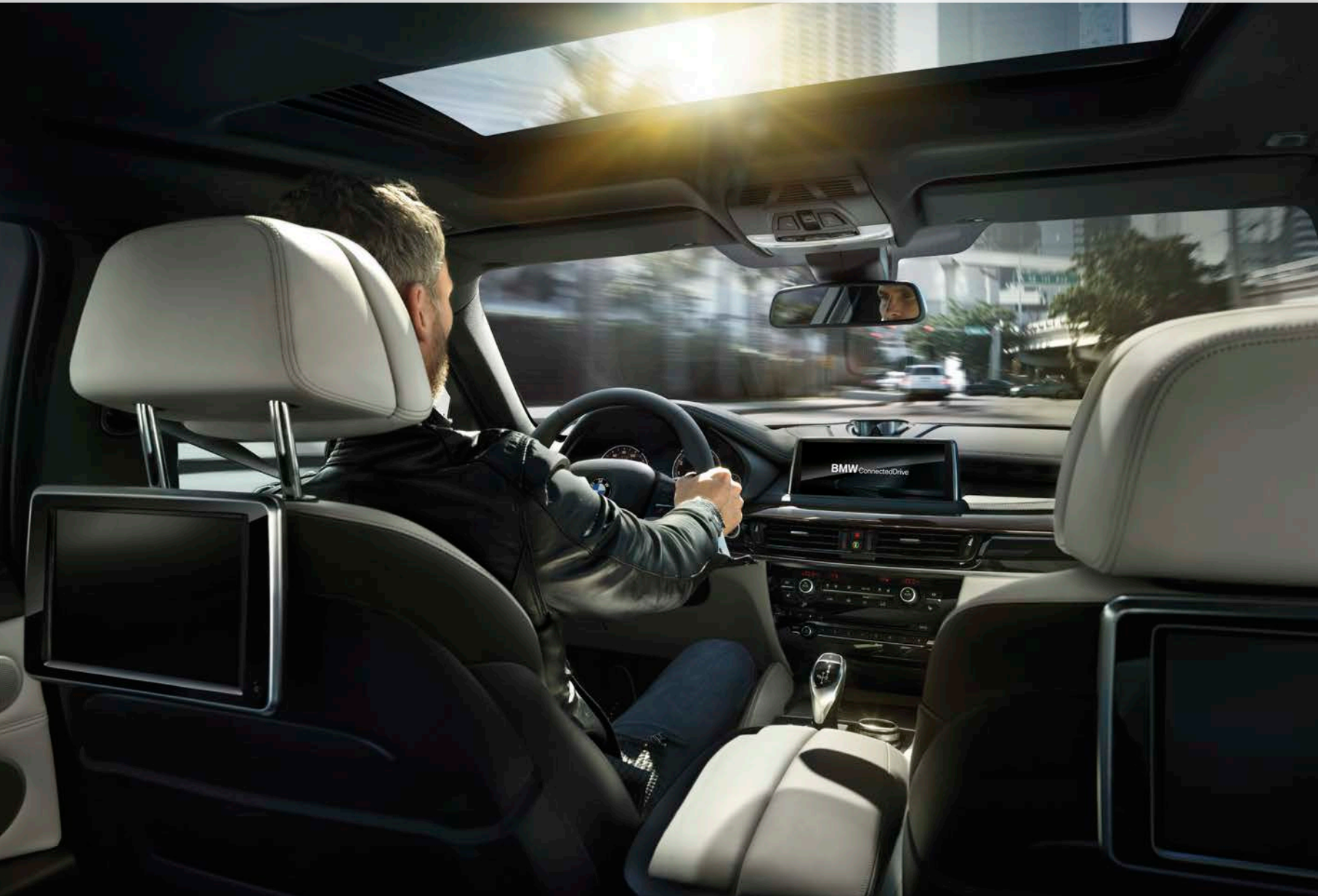

X FACTOR.

Built to move, the BMW X6 unites the robust profile of an X model with the agility of a coupe. A TwinPower Turbo V-8 engine unleashes 445 hp, something you can experience in many weather conditions thanks to xDrive intelligent all-wheel drive.



BMW X6

[EXTERIOR COLORS](#)

[UPHOLSTERY](#)

[INTERIOR TRIMS](#)

[WHEELS / TIRES](#)

[PACKAGES](#)

[TECHNICAL DATA](#)



CONCERT HALL ON WHEELS.

The Bang & Olufsen® High-End Surround Sound System delivers 16 loudspeakers with a 1,200-watt output – including a center speaker that automatically rises from the dashboard. It envelops you in incredible acoustics.



BACK SEAT HUB.

This Rear-seat entertainment system Professional comes with two separate color screens that are tilt-adjustable, plus a DVD drive. Radio and Navigation can be controlled via remote.

BMW X6 EXTERIOR COLORS

NON-METALLIC

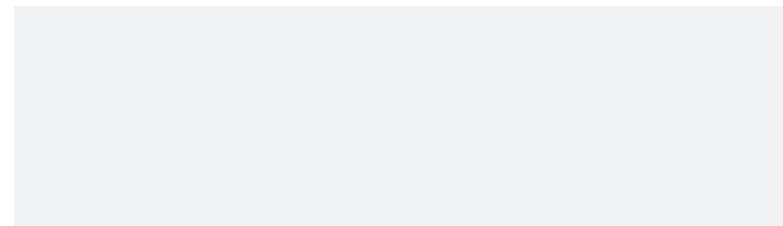

300 Alpine White (Non-metallic)

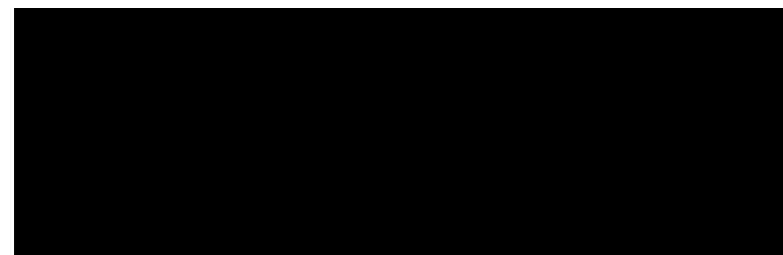

668 Jet Black (Non-metallic)

METALLIC

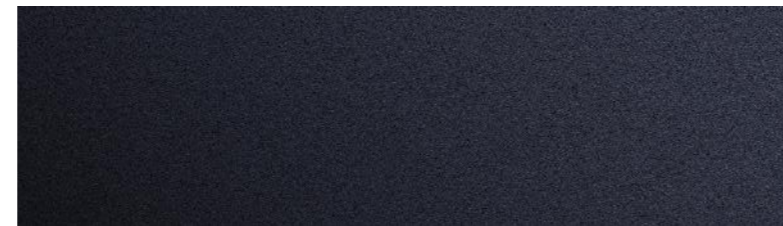

416 Carbon Black Metallic



A52 Space Gray Metallic

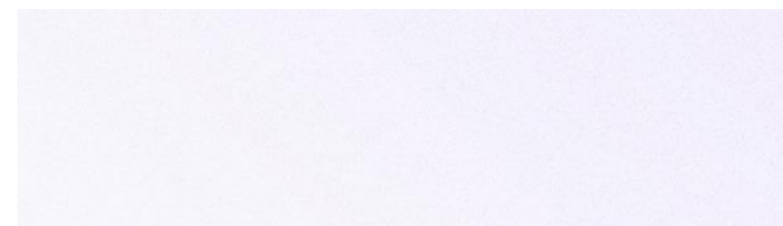

A96 Mineral White Metallic



C2P Atlas Cedar Metallic



A90 Dark Graphite Metallic

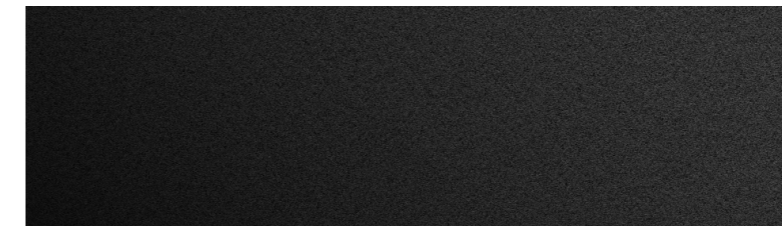

475 Black Sapphire Metallic



A83 Glacier Silver Metallic

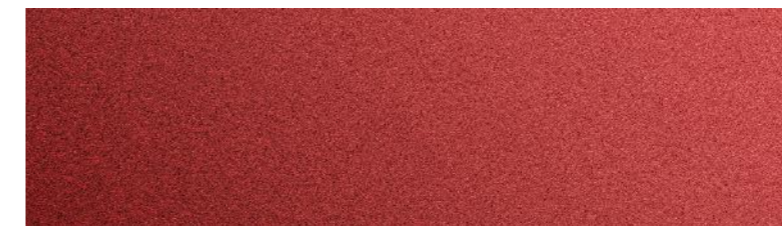

C06 Flamenco Red Metallic

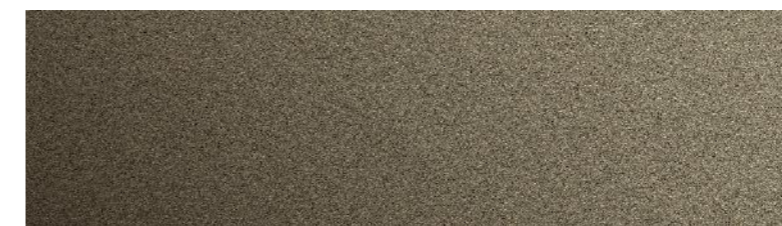

C07 Dark Olive Metallic



A14 Mineral Silver Metallic

BMW INDIVIDUAL

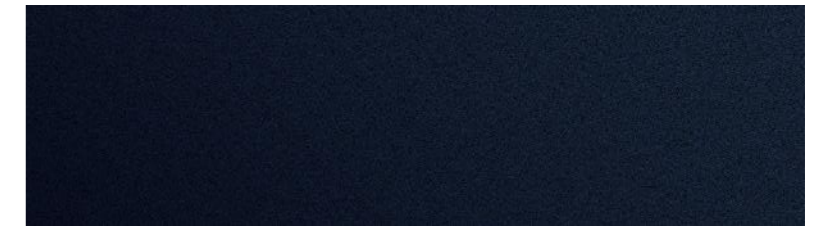

S34 Azurite Black Metallic



X01 Pearl Silver Metallic

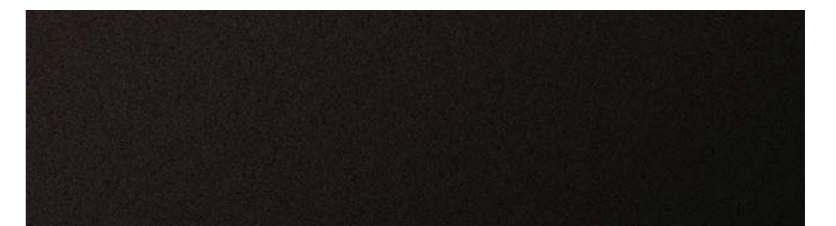

X03 Ruby Black Metallic

BMW X6 UPHOLSTERY

DAKOTA LEATHER



LCB8 Terra Dakota Leather



LCD1 Coral Red / Black Dakota Leather

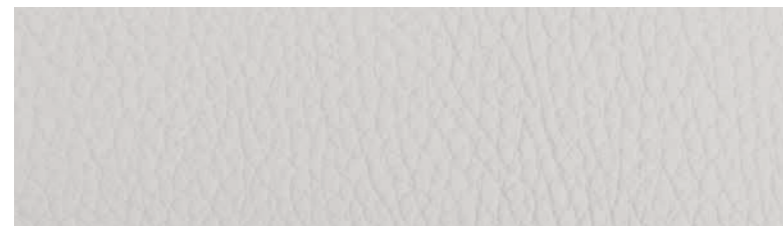

LCEW Ivory White / Black Dakota Leather

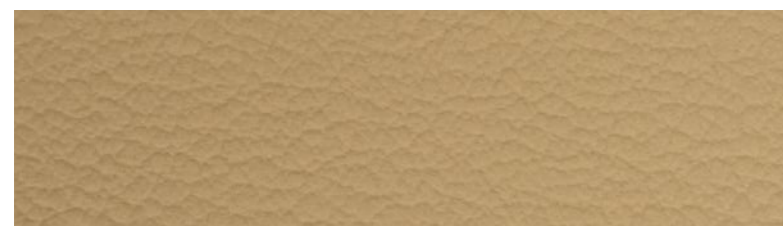

LCFY Canberra Beige / Black Dakota Leather



LCRI Cognac Dakota Leather



LCSW Black Dakota Leather

NAPPA LEATHER

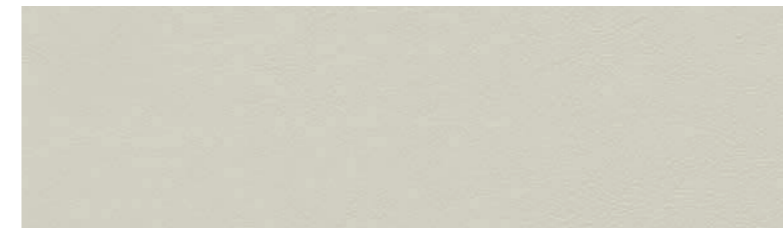

NAEN Ivory White / Black Bicolor
Nappa Leather

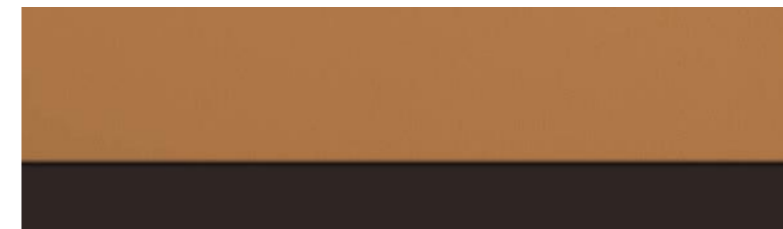

NARQ Cognac / Black Bicolor
Nappa Leather

Leather: Leather on all seating surfaces; other components may be Leather or SensaTec.

BMW INDIVIDUAL

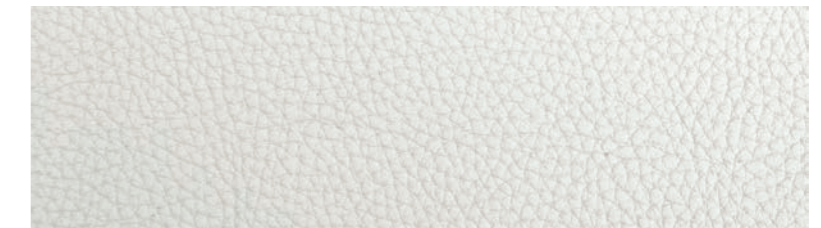

ZAFU Smoke White Extended Merino Leather

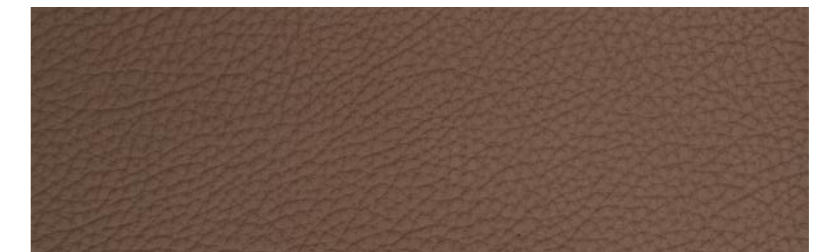

ZAML Nutmeg Extended Merino Leather



ZAN3 Taupe Extended Merino Leather

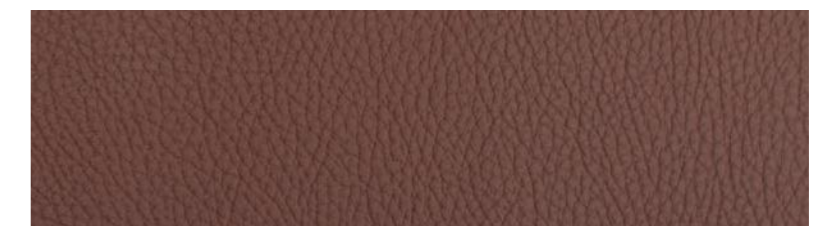

ZAP3 Criollo Brown Extended Merino Leather

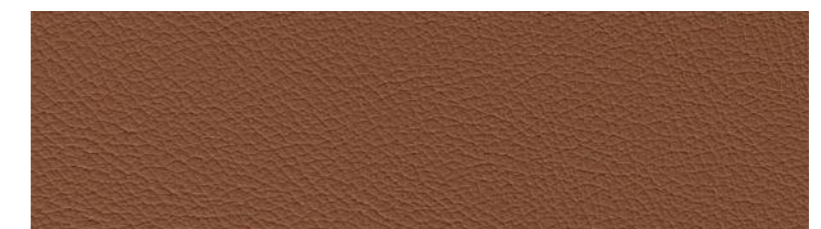

ZAP5 Amaro Brown Extended Merino Leather

BMW X6 INTERIOR TRIMS



4MR Aluminum Hexagon trim



4CV Fineline Oak Wood trim

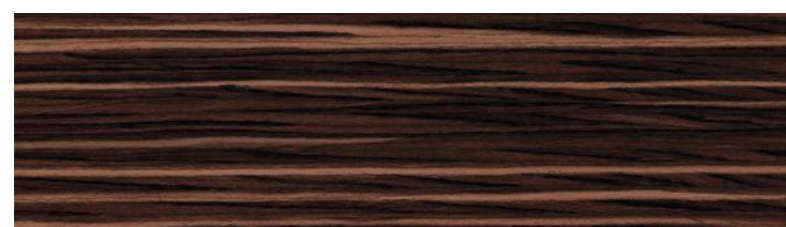

4D0 Fineline Striped Wood trim

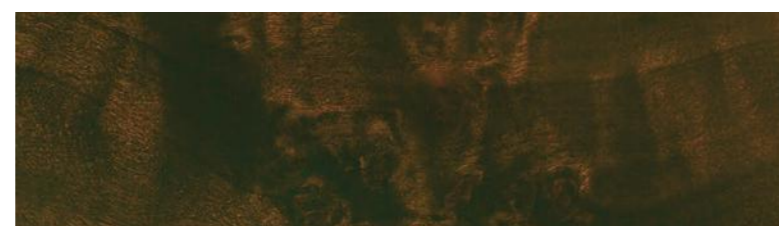

4AC Poplar Wood trim



4B9 Brushed Aluminum trim



4DD Fineline Pure Textured Wood trim

BMW X6 WHEELS / TIRES



Y Spoke light alloy wheels (Style 595)
19 x 9.0 front and rear; and 255/50 front and rear run-flat all-season tires^{1,2}



Double Spoke light alloy wheels (Style 623M)
19 x 9.0 front and rear; and 255/50 front and rear run-flat all-season tires^{1,2}



Double Spoke light alloy wheels (Style 469M)
20 x 10.0 front, 20 x 11.0 rear; and 275/40 front, 315/35 rear run-flat performance tires^{1,2,3}



Double Spoke Black light alloy wheels (Style 469M)
20 x 10.0 front, 20 x 11.0 rear; and 275/40 front, 315/35 rear run-flat performance tires^{1,2,3}



V Spoke light alloy wheels (Style 597)
20 x 10.0 front, 20 x 11.0 rear; and 275/40 front, 315/35 rear run-flat performance tires^{1,2,3}



Star Spoke High-gloss Black light alloy wheels (Style 491)
20 x 10.0 front, 20 x 11.0 rear; and 275/40 front, 315/35 rear run-flat performance tires^{1,2,3}

¹ Run-flat tires do not come equipped with a spare wheel and tire.

² Driving over rough or damaged road surfaces, as well as debris, curbs and other obstacles, can cause serious damage to wheels, tires and suspension parts. This is more likely to occur with low-profile tires, which provide less cushioning between the wheel and the road. Be careful to avoid road hazards and reduce your speed, especially if your vehicle is equipped with low-profile tires.

³ Performance tires include Mobility Kit; not recommended for driving in ice and snow conditions.

BMW X6 PACKAGES

COLD WEATHER PACKAGE

Heated steering wheel
Heated rear seats
Retractable headlight washers

DRIVER ASSISTANCE PACKAGE

(Available on 35i)
Rear-view Camera
Head-up Display

DRIVER ASSISTANCE PLUS

(Available on 35i)
Active Blind Spot Detection
Active Driving Assistant¹
ACC with Stop & Go^{1,2} +
Active Driving Assistant¹ (optional)
Side- and Top-view Cameras
Speed Limit Info

LUXURY SEATING PACKAGE

(Available on 35i)
Ventilated front seats
Multi-contour seats

COGNAC/BLACK BICOLOR INTERIOR DESIGN PACKAGE

Fineline Striped Wood trim (options available)
Cognac/Black Bicolor Nappa Leather and Black Nappa Leather
dashboard with contrast stitching (option available)

IVORY WHITE/BLACK BICOLOR INTERIOR DESIGN PACKAGE

Fineline Oak Wood trim (options available)
Ivory White/Black Bicolor Nappa Leather and Black Nappa Leather
dashboard with contrast stitching (option available)

DYNAMIC HANDLING PACKAGE

Dynamic Damper Control + rear-axle air suspension
Dynamic Performance Control + Active Roll Stabilization

M SPORT PACKAGE

19-inch Double Spoke wheels (Style 623M) (options available)
Sport seats (option available)
Aluminum Hexagon interior trim (options available)
M steering wheel
Aerodynamic kit
Shadowline exterior trim
Standard suspension
Adaptive M Suspension (optional)

PREMIUM PACKAGE

(Available on 35i)
Comfort Access keyless entry
4-zone automatic climate control
SiriusXM[®] Satellite radio with 1-year subscription
Wireless charging
WiFi Hotspot

EXECUTIVE PACKAGE

(Available on 50i)
Soft-close automatic doors
Rear manual side-window shades
Leather dashboard
Ceramic controls
Head-up Display
Wireless charging
WiFi Hotspot

¹ Active Driving Assistant is not a substitute for the driver's own responsibility in maintaining safe control of the vehicle.

² After evaluating the road, traffic and visibility conditions, the driver must decide whether and how Active Cruise Control is to be used.

BMW X6 TECHNICAL DATA



| | X6 sDrive35i / X6 xDrive35i | X6 xDrive 50i |
|-------------------------------|---|--|
| ENGINE | 3.0-liter TwinPower Turbo inline 6-cylinder | 4.4-liter TwinPower Turbo V-8 |
| OUTPUT @ RPM | 300 hp @ 5800-6400 / 300 lb-ft @ 1200-5000 | 445 hp @ 5500-6000 / 480 lb-ft @ 2000-4500 |
| 0-60 MPH (sec) ¹ | 6.0 | 4.6 |
| CITY / HIGHWAY / COMBINED MPG | 18/25/21 / 18/24/20 | 15/21/17 |

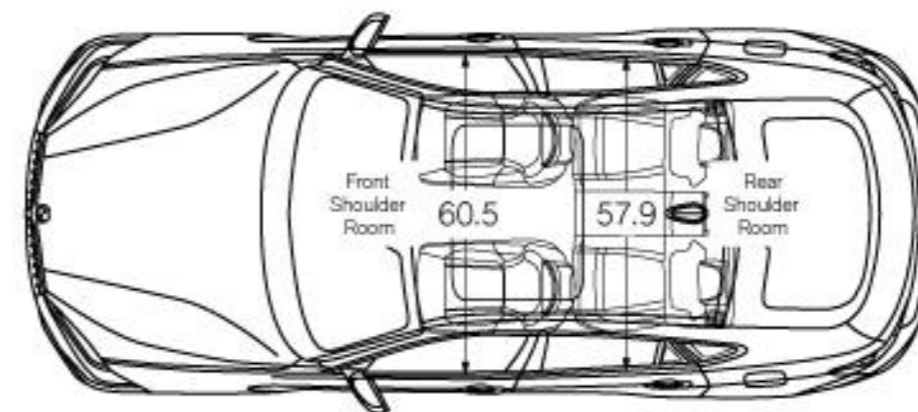
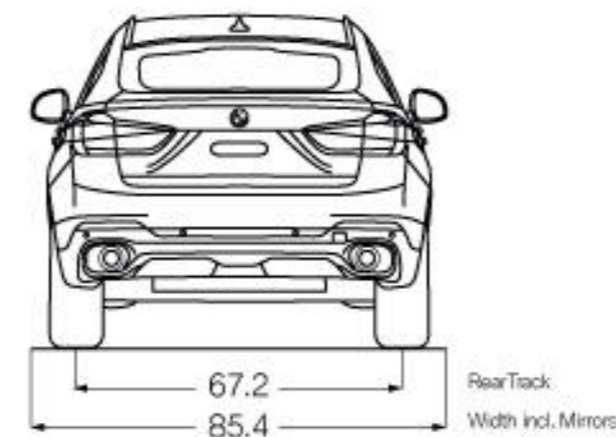
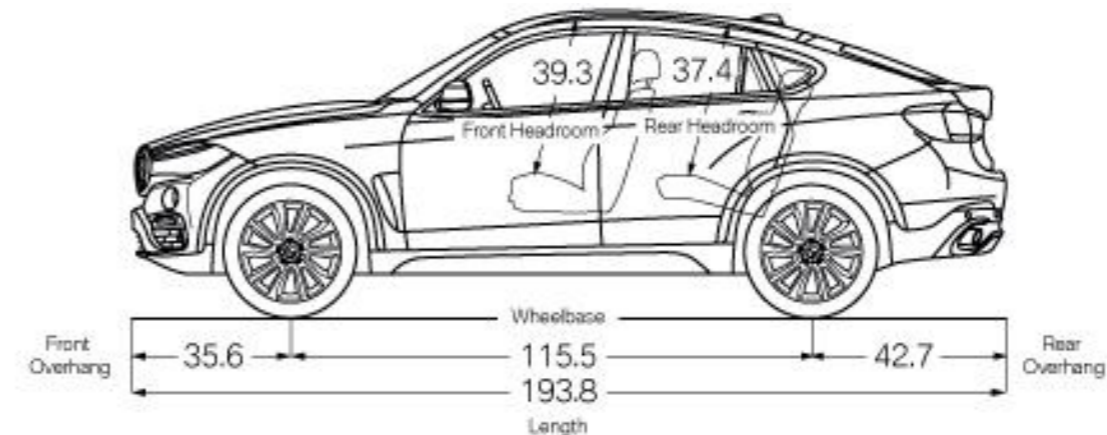
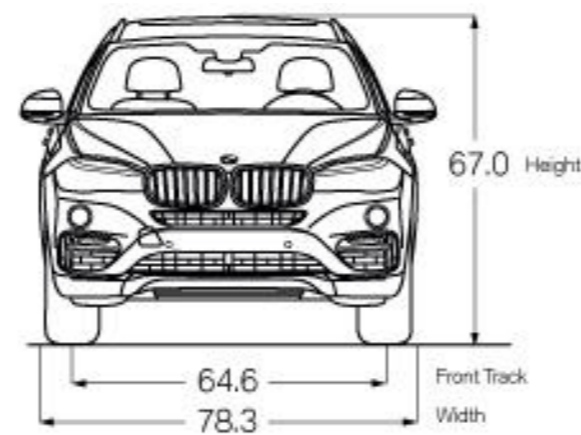

All dimensions in technical drawings are given in inches. Dimensions shown apply to X6 xDrive35i.

Figures subject to change. Not all packages available in all models. Please visit your BMW Retailer or bmwusa.com for the most up-to-date information.

¹BMW AG preliminary test results. Actual acceleration results may vary, depending on specification of vehicle; road and environmental conditions; testing procedures and driving style. These results should be used for comparison only and verification should not be attempted on public roads. BMW urges you to obey all posted speed laws and always wear safety belts.

Not all features are available on all models. Get the latest information on standard and optional features, packages and technical specifications. Visit bmwusa.com and select the BMW model of your choice.

XHILARATING.

The third generation X5 continues to deliver premium features and rugged individuality. As a Sports Activity Vehicle® (SAV®), it offers a range of technologies that maximize efficiency, driving dynamics, comfort and versatility like a true champion – both on the highway and off the beaten path .



BMW X5

EXTERIOR COLORS

UPHOLSTERY

INTERIOR TRIMS

WHEELS / TIRES

PACKAGES

TECHNICAL DATA



FLEXIBILITY, IN A SPLIT SECOND.

The split-fold-down rear seats system extends the transport versatility of your BMW. Thanks to the rear-seat backrest, which splits in a 40/20/40 ratio, various individual configurations are possible.



TOUCH OF CLASS.

Add a deep black, glazed ceramic finish to the iDrive Controller bezel, the ventilation and audio controls, and more. The black ceramic provides a rich, custom look and unique feel to the interior.

BMW X5 EXTERIOR COLORS

NON-METALLIC

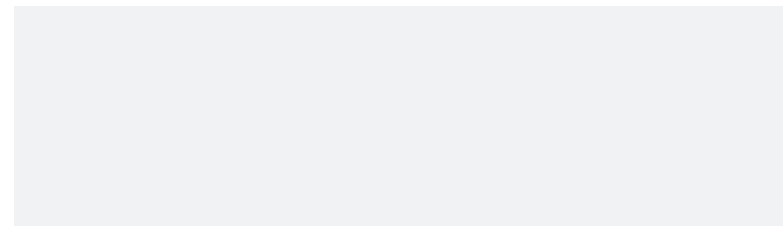

300 Alpine White (Non-metallic)

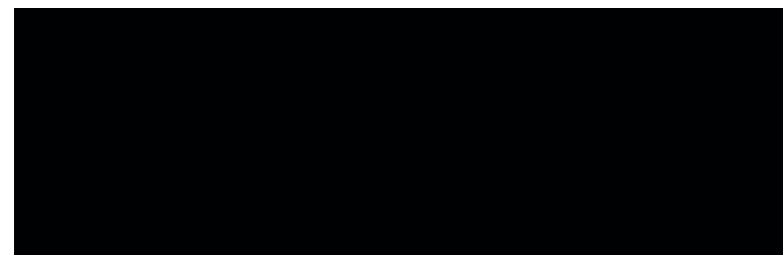

668 Jet Black (Non-metallic)

METALLIC

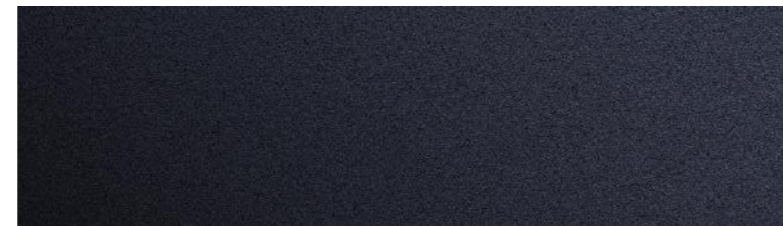

416 Carbon Black Metallic

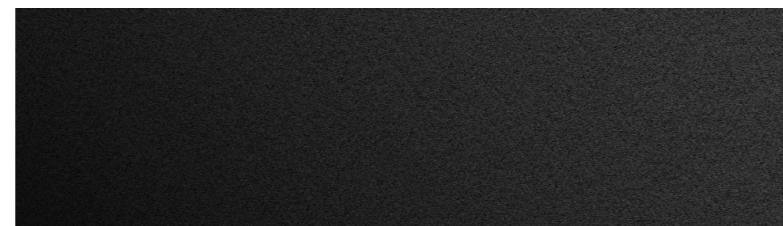

475 Black Sapphire Metallic



A52 Space Gray Metallic

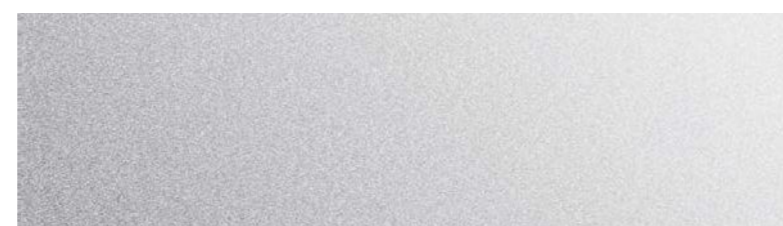

A83 Glacier Silver Metallic

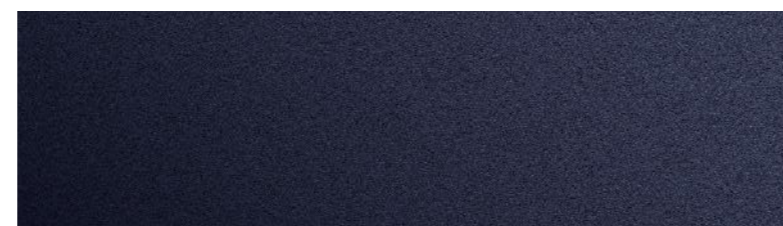

A89 Imperial Blue Metallic



A90 Dark Graphite Metallic

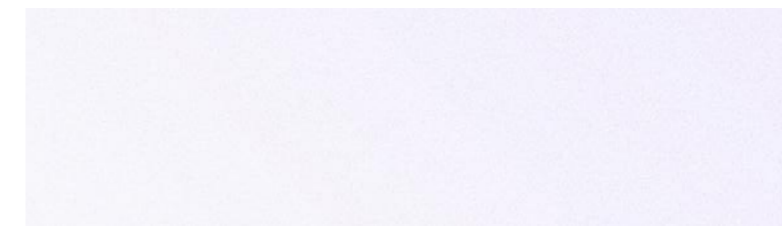

A96 Mineral White Metallic

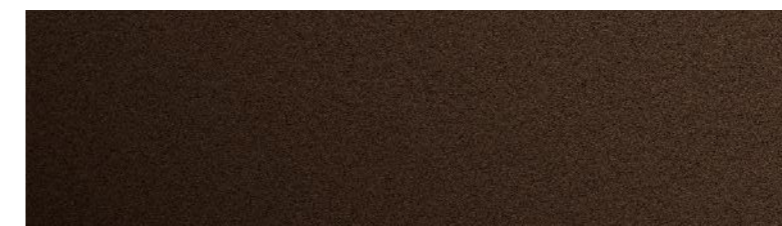

B53 Sparkling Brown Metallic



C2P Atlas Cedar Metallic

BMW INDIVIDUAL

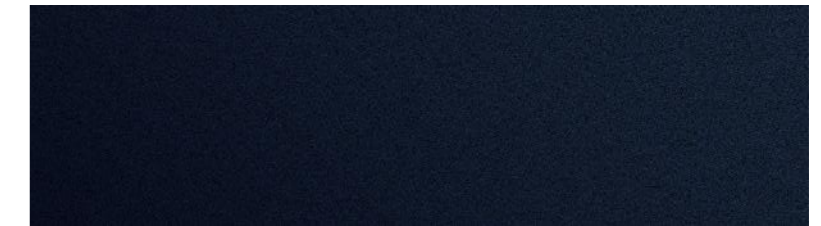

S34 Azurite Black Metallic

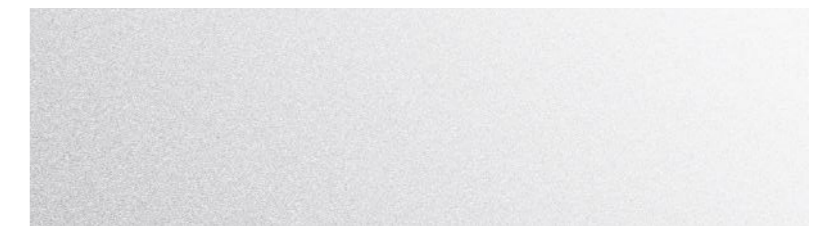

X01 Pearl Silver Metallic

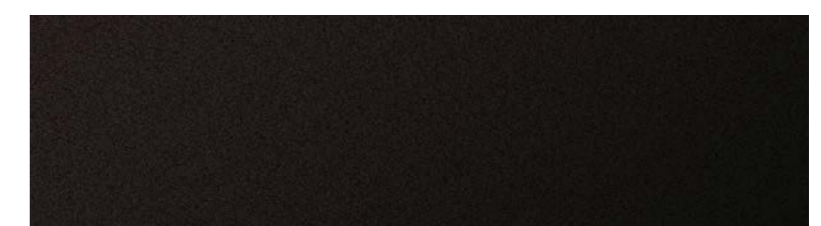

X03 Ruby Black Metallic

BMW X5 UPHOLSTERY

SENSATEC



KCSW Black SensaTec

DAKOTA LEATHER



LCB8 Terra Dakota Leather

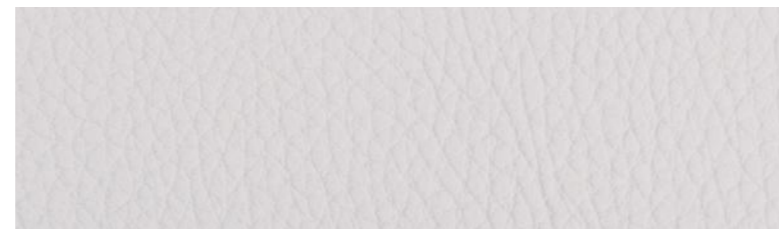

LCEW Ivory White / Black Dakota Leather

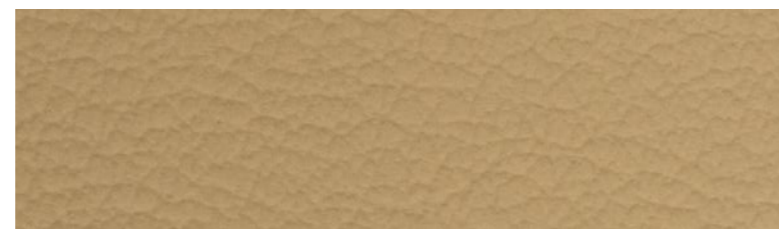

LCFY Canberra Beige / Black Dakota Leather

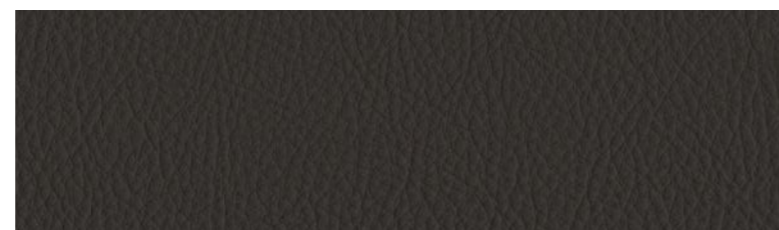

LCMY Mocha Dakota Leather



LCSW Black Dakota Leather

NAPPA LEATHER

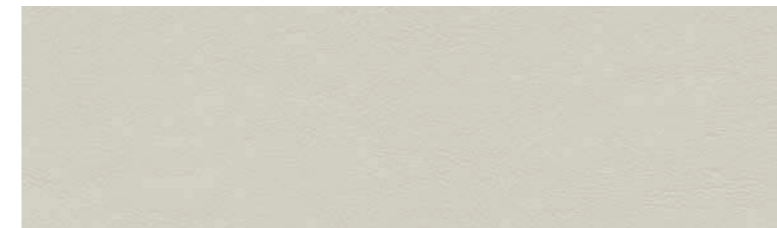

NAEW Ivory White / Black Nappa Leather

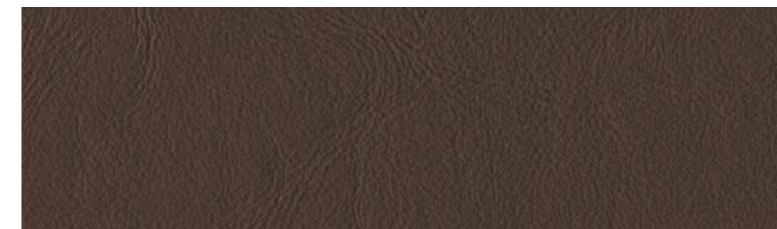

NAMY Mocha Nappa Leather

BMW INDIVIDUAL



ZAFU Smoke White Extended Merino Leather

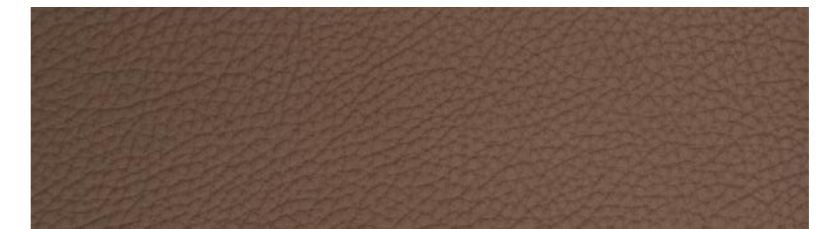

ZAML Nutmeg Extended Merino Leather



ZAN3 Taupe Extended Merino Leather

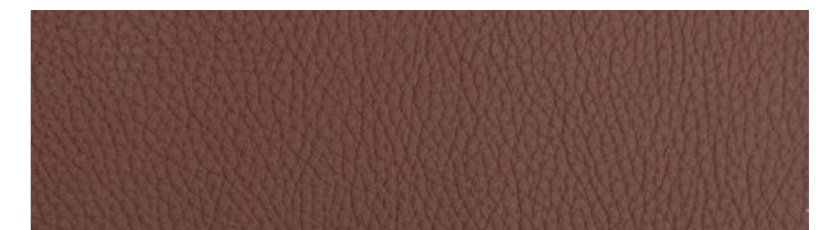

ZAP3 Criollo Brown Extended Merino Leather

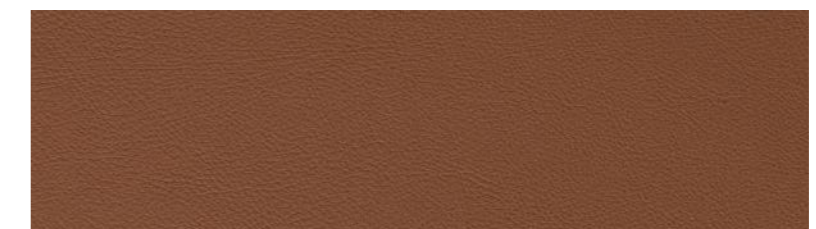

ZAP5 Amaro Brown Extended Merino Leather

Leather: Leather on all seating surfaces; other components may be Leather or SensaTec.

Not all features are available on all models. Get the latest information on standard and optional features, packages and technical specifications. Visit bmwusa.com and select the BMW model of your choice.

BMW X5 INTERIOR TRIMS

INTERIOR TRIMS



4AC Poplar Wood trim



4B9 Brushed Aluminum trim



4CV FIneline Oak Wood trim



4DD FIneline Pure Textured Wood trim



4MR Aluminum Hexagon trim

BMW INDIVIDUAL

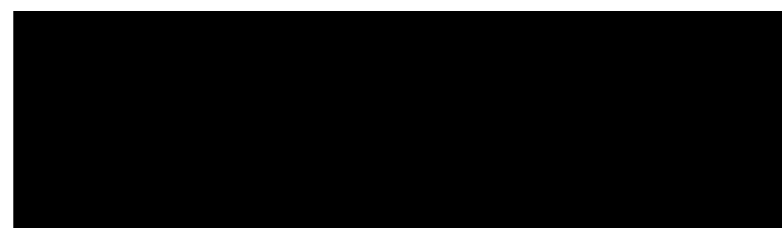

XE7 Piano Black trim

BMW X5 WHEELS / TIRES



Double Spoke Black light alloy wheels (Style 469M)
20 x 10.0 front, 20 x 11.0 rear; and 275/40 front, 315/35 rear run-flat performance tires^{1,2,3}



Double Spoke light alloy wheels (Style 469M)
20 x 10.0 front, 20 x 11.0 rear; and 275/40 front, 315/35 rear run-flat performance tires^{1,2,3}



Multi Spoke light alloy wheels (Style 448)
19 x 9.0 front and rear; and 255/50 front and rear run-flat all-season tires^{1,2}



Double Spoke Orbit Gray light alloy wheels (Style 449)
19 x 9.0 front and rear; and 255/50 front and rear run-flat all-season tires^{1,2}



Y Spoke light alloy wheels (Style 451)
20 x 10.0 front, 20 x 11.0 rear; and 275/40 front, 315/35 rear run-flat performance tires^{1,2,3}



Double Spoke light alloy wheels (Style 467M)
19 x 9.0 front and rear; and 255/50 front and rear run-flat all-season tires^{1,2}

¹ Run-flat tires do not come equipped with a spare wheel and tire.

² Driving over rough or damaged road surfaces, as well as debris, curbs and other obstacles, can cause serious damage to wheels, tires and suspension parts. This is more likely to occur with low-profile tires, which provide less cushioning between the wheel and the road. Be careful to avoid road hazards and reduce your speed, especially if your vehicle is equipped with low-profile tires.

³ Performance tires include Mobility Kit; not recommended for driving in ice and snow conditions.

BMW X5 PACKAGES

COLD WEATHER PACKAGE

Heated steering wheel
Heated rear seats
Retractable headlight washers

DRIVER ASSISTANCE PLUS

Active Blind Spot Detection
Active Driving Assistant¹
ACC with Stop & Go^{1,2} +
Active Driving Assistant¹ (optional)
Side- and Top-view Cameras
Speed Limit Info

DYNAMIC HANDLING PACKAGE

(Available on 50i)
Dynamic Damper Control +
rear-axle air suspension
Dynamic Performance Control +
Active Roll Stabilization

DRIVER ASSISTANCE PACKAGE

(Available on 35i, 35d)
Rear-view Camera
Head-up Display

LIGHTING PACKAGE

Adaptive LED Lights
Automatic high beams

IVORY WHITE INTERIOR DESIGN PACKAGE

Poplar Wood trim
(options available)
Ivory White/ Black Nappa Leather
and Black Nappa Leather
dashboard with contrast stitching
(options available)

MOCHA INTERIOR DESIGN PACKAGE

Poplar Wood trim
(options available)
Mocha Nappa Leather and
Black Nappa Leather dashboard
with contrast stitching
(options available)

LUXURY PACKAGE

Chrome-line exterior trim

PREMIUM PACKAGE

(Available on 35i, 35d)
Comfort Access keyless entry
4-zone automatic climate control
SiriusXM[®] Satellite Radio with 1-year
subscription
Wireless charging
WiFi Hotspot
Dakota Leather Upholstery

EXECUTIVE PACKAGE

(Available on 50i)
Soft-close automatic doors
Rear manual side-window shades
Leather dashboard
Ceramic controls
Head-up Display
Wireless charging
WiFi Hotspot

LUXURY SEATING PACKAGE

(Available on 35i, 35d)
Ventilated front seats
Multi-contour seats

M SPORT PACKAGE

19-inch Double Spoke wheels (Style 467M)
(options available)
Sport Automatic transmission
High-gloss roof rails
Satin Aluminum roof rails (optional)
Sport seats
Multi-contour seats (optional)
Poplar Wood trim
(options available)
M steering wheel
Aerodynamic kit
Shadowline exterior trim
Standard suspension
Adaptive M Suspension (optional)

¹ Active Driving Assistant is not a substitute for the driver's own responsibility in maintaining safe control of the vehicle.

² After evaluating the road, traffic and visibility conditions, the driver must decide whether and how Active Cruise Control is to be used.

Not all features are available on all models. Get the latest information on standard and optional features, packages and technical specifications. Visit bmwusa.com and select the BMW model of your choice.

BMW X5 TECHNICAL DATA

| | X5 sDrive35i | X5 xDrive35i | X5 xDrive35d | X5 xDrive50i |
|-------------------------------|---|--------------|--|-----------------------------------|
| ENGINE | 3.0-liter TwinPower Turbo inline 6-cylinder | | 3.0-liter TwinPower Turbo Diesel inline 6-cylinder | 4.4-liter TwinPower Turbo V-8 |
| OUTPUT @ RPM | 300 hp @ 5800-6400 / 300 @ 1200-5000 | | 255 hp @ 4000 / 413 @ 1500-3000 | 445 @ 5500-6000 / 480 @ 2000-4500 |
| 0-60 MPH (sec) ¹ | 6.1 | 6.1 | 6.5 | 4.7 |
| CITY / HIGHWAY / COMBINED MPG | 18/25/21 | 18/24/20 | 23/29/25 | 15/21/17 |

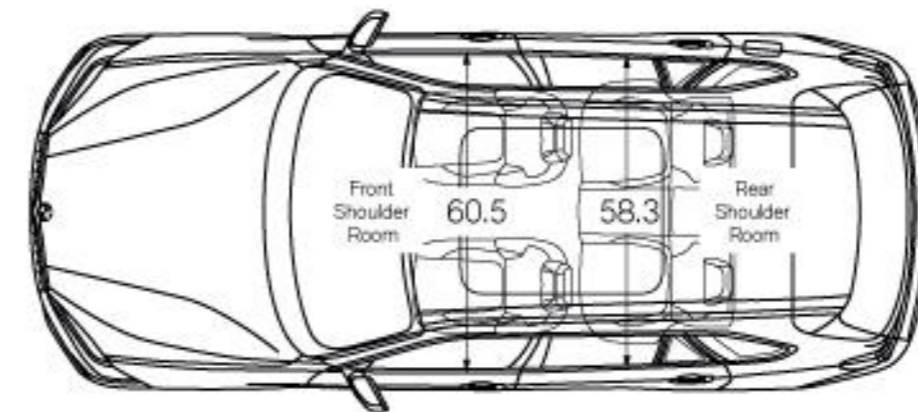
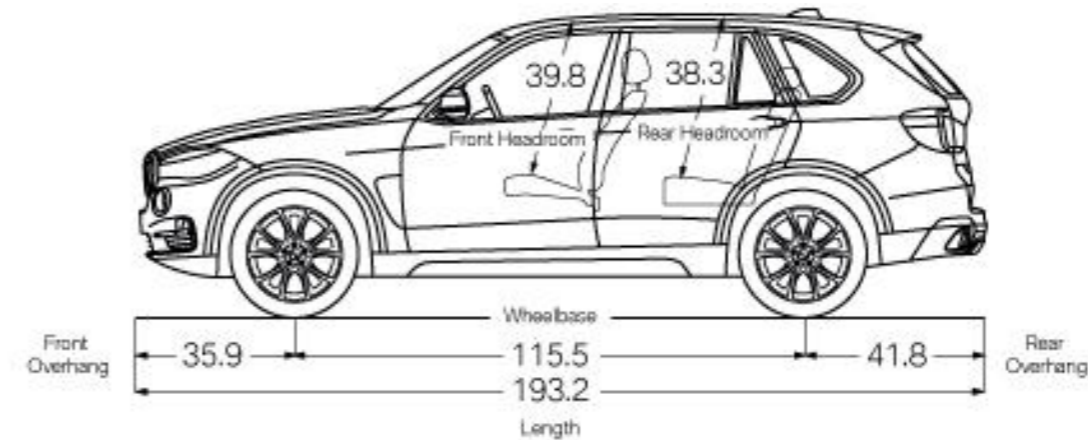
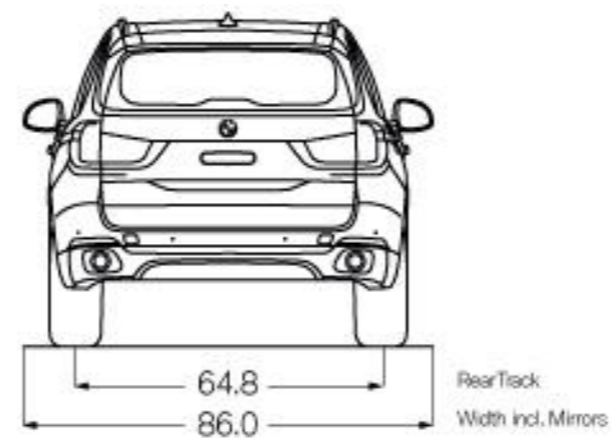
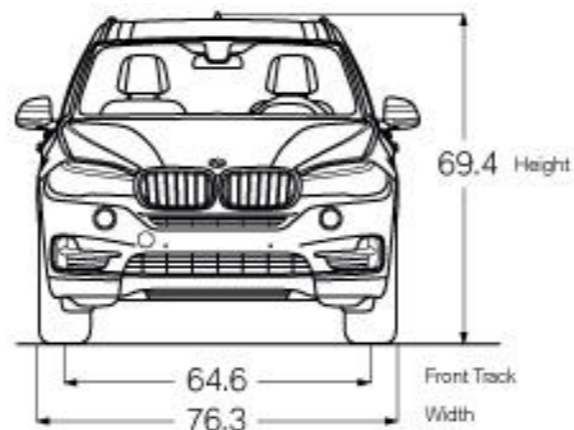

All dimensions in technical drawings are given in inches. Dimensions shown apply to X5 xDrive35i.

Figures subject to change. Not all packages available in all models. Please visit your BMW Retailer or bmwusa.com for the most up-to-date information.

¹BMW AG preliminary test results. Actual acceleration results may vary, depending on specification of vehicle; road and environmental conditions; testing procedures and driving style. These results should be used for comparison only and verification should not be attempted on public roads. BMW urges you to obey all posted speed laws and always wear safety belts.

Not all features are available on all models. Get the latest information on standard and optional features, packages and technical specifications. Visit bmwusa.com and select the BMW model of your choice.