

**WILDERNESS**

# SAR

**MOUNTAIN, CAVE & WATER RESCUE  
PARK RANGERS • HELI & DRONE OPS**



ISSUE

**13**

[www.rescuemagazines.com](http://www.rescuemagazines.com)



© 2022 Petzl Distribution - Vuesol.org - Air Globe® - Altmann

# PETZL RESCUE SOLUTIONS

Every second counts in high-stakes situations — that's why technical rescue operations require skilled rescuers and the best equipment. It's also why rescuers train continually, as they're doing here on a via ferrata in Switzerland. They know that they can count on Petzl to provide high-performance tools.



A technical rescue solution including a STRATO VENT HI-VIZ helmet, DUO RL headlamp, FALCON MOUNTAIN harness, MINI TRAXION progress-capture pulley, SPIN L1 pulley, and ROLLER COASTER rope protector. [www.petzl.com](http://www.petzl.com)



Access  
the  
inaccessible®

# WILDERNESS SAR

# CONTENTS 13



**EDITOR:** Ade Scott  
ade@trmedialtd.com

**EDITORS/ADVISORS:**

Australia: Roland Curll  
NSW Police Rescue  
South Africa: Rob Thomas  
MCSASART

USA: Reed Thorne RTR

Dr Mike Crosslin

Shawn Alladio (K38)

UK: Richard Hackwell HMC

Paul Whithington (COMRU)

Darryl Ashford-Smith (SMRA)

Chris Walker (RNLI/DLSAR)

**CONTRIBUTORS THIS ISSUE**

Roland Curll  
Dr Steve Glassey  
Charlotte Ina-Sterland  
Greg Toman

*NB: Articles NOT shown as authored are by WSAR, TRm and ACm staff and written/edited by Ade Scott*

**PHOTOGRAPHY:**

Darryl Ashford-Smith  
Jake Borowski • Roland Curll  
Martine DeGraaf • John Evans  
Steve Glassey • Michael Quinn  
Greg Toman • Grand Canyon National Park

**REPRO**

Jo Evernden

**ADVERTISING**

Kelly Matthews  
admin@rescuemagazines.com

**SUBSCRIPTIONS** (all prices US\$)

**3 PRINT** issues including postage  
UK/USA/Canada \$20  
Worldwide \$20 + \$5 p&p  
**6 PRINT** issues including postage  
UK/USA/Canada \$35  
Worldwide \$35 + \$10 p&p  
**3 DIGITAL** issues worldwide \$8  
**6 DIGITAL** issues worldwide \$15

**BULK SUBSCRIPTIONS**

to one address - worldwide  
**10x 4 PRINT** issues= \$150 inc P&P  
**25x 4 PRINT** issues= \$275 inc P&P  
**50x 4 PRINT** issues= \$500 inc P&P

EMAIL: admin@rescuemagazines.com  
rescuemagazine@aol.com

www.rescuemagazines.com

- 2 ON THE COVER:** SWr Breathing Apparatus
- 6 PRODUCT INFO:** Rope, Dog & Water Stuff
- 14 GALLERY:** Grand Canyon National Park
- 16 SAR SAFETY:** Pt7 First Aid in Austere Environments by Greg Toman
- 22 TRAINING:** Preparing for Tree Rescue by Roland Curll
- 30 COURSE REVIEW:** Prolonged Field Care by Simon Greenfield
- 34 SAR TECHNIQUES:** Tips for Incident Management by Steve Glassey
- 38 GEAR REVIEW:** Petzl Falcon Harnesses by Ade Scott & Roland Curll
- 42 WATER RESCUE:** Hand Portable Sub-Sea ROVs
- 48 MARKET GUIDE to:** Modular High Directionals
- 62 DRONES:** Ai and Drones by Charlotte Ina-Sterland
- 66 SAR TECHNIQUES:** Critical Separations by Roland Curll



# You can't breathe the water

by **Dr. Steve Glassey PhD**

Dr Steve Glassey has been teaching swiftwater rescue for twenty years and is a registered assessor for the International Public Safety Qualifications Authority (IPSQA) for swiftwater rescue, a WorkSafe New Zealand Occupational Diver and is a PADI Public Safety Diver™.

**Will SWIFTWATER BREATHING APPARATUS be the game changer we have been looking for?**

*This is a precis of a larger study that can be viewed via details shown at the end of this article.*

The world of public safety is always evolving, with new techniques and equipment constantly being developed and refined. One of the most significant advancements in recent months is the evaluation of the Swift Water Breathing Apparatus (SWBA), a device that could revolutionize swiftwater rescue operations.

## INTRODUCTION

In 1942, Jacques-Yves Cousteau and Émile Gagnan designed the first reliable and commercially successful open-circuit Self-Contained Underwater Breathing Apparatus (SCUBA), known as the Aqua-Lung. In 1945, Scott Aviation worked with the New York Fire Department to roll out the first widespread adoption of the AirPac, a Self-Contained Breathing Apparatus (SCBA) for firefighting. These innovations transformed their respective fields, and now, we stand on the brink of another game-changing innovation - the Swift Water Breathing Apparatus (SWBA).

## THE CONCEPT OF SWBA

SWBA is a repurposed version of Emergency Breathing Systems (EBS) used by aircrew for escaping downed aircraft in water. EBS are mini-SCUBA systems that have been adapted for maritime and aviation emergencies. The key difference between SWBA and traditional SCUBA practice is that SWBA operates EBS without the intention to dive. Instead, it provides a few extra breaths of air,





enabling rescuers to perform surface level tasks in challenging conditions, such as navigating through a long set of rapids or escaping the deadly churn of a low head dam.

### TRIAL & EVALUATION

Following initial trials in the United Arab Emirates, the formal trial of the Swift Water Breathing Apparatus (SWBA) was conducted at Vector Wero whitewater park in October 2023. The trial involved the use of various Emergency Breathing Systems (EBS) devices, including the HEED3, Tiger Performance EBS, and an improvised set using parts from various manufacturers. The Poseidon and Aqualung EBS underwent a desktop evaluation based on publicly available material and contact with their distributors.

The two Personal Flotation Devices (PFDs) used across all EBS for the trials were the NRS Rapid Rescuer and the Force6 Rescue Ops vests. The improvised set used an assortment of parts from different suppliers, including a reconditioned AquaLung ABS Octopus which unlike the other mouthpieces had a 120 degree angle between the hose and mouthpiece which made it easier to operate, stow and deploy when packed down the front of the PFD.

The trial found that the use of SWBA improved the operator experience significantly. The SWBA was donned at the start of the day's activities and worn to see if they impeded movements and



# REALISTIC WATER RESCUE TRAINING



# FICC

Fayetteville Technical Community College  
2201 Hull Rd,  
Fayetteville, NC 28303  
Tel +1 (910) 678-8400  
www.faytechcc.edu



found no such interference. The most common issues were cylinder pressure or volume, and mouthpiece orientation.

The conditioned practice of having a relaxed jaw holding the mouthpiece (2nd stage regulator) in SCUBA diving prompted minor change in behaviour with the need to apply additional bite pressure when passing through rapids and hydraulics as otherwise the mouthpiece was prone to being pulled out by the turbulent water. It only took one such experience to encourage adopting a firmer bite in subsequent runs of the whitewater channel.

All the products evaluated appear suitable for use as SWBA. Whether their individual manufacturers approve them for such use is not covered in this study. However, as all the proprietary devices are intended for escape purposes, they could be further modified to make them more suitable for swiftwater environments.

### CHALLENGES AND CONSIDERATIONS

Despite its potential, the implementation of SWBA is not without its challenges. There are currently no standards for SWBA, and the standards developed for EBS are not suitable for swiftwater or the function that SWBA could play. Furthermore, the use of SWBA requires due diligence and legal advice before implementation.

To assist safe implementation a Good Practice Guideline: Swiftwater Breathing Apparatus has been developed. Under this guideline operators must be certified, which involves completion of a recreational dive medical, verification of recognized swift water rescue technician and Level 1 Supervised Diver (ISO) credentials, and passing an examination following the SWBA online course.

The online certification process for those holding their diver and swiftwater technician credentials is now available from the website below.

### CONCLUSION

In conclusion, the potential of SWBA to revolutionize water rescue operations is undeniable. However, its implementation requires careful consideration of legal and operational factors. As we move forward, it is crucial to develop fit for purpose SWBA products and ensure that operators are adequately trained and certified. With these measures in place, SWBA could indeed be the game-changer we have been looking for in swiftwater rescue operations.

To access full details on the evaluation including videos, Good Practice Guideline, SWBA® online course and further information, visit [www.swba.tech](http://www.swba.tech)

## TRAIN IN SAFETY AT THE NEWEST FACILITY IN THE USA

In an increasingly flood-prone world, swift water rescue training is critically important for first responders. Specialized training can often be difficult and dangerous to arrange in natural outdoor settings.

In spring 2023, Fayetteville Technical Community College (FTCC), already known for its educational and training services to Fort Bragg, opened the only indoor swift water rescue training facility on the east coast of the United States.

An 88,000-gallon indoor tank allows for a variety of training scenarios, including different weather, water temperatures, obstacles, and rescue challenges, including simulated rescues at night. Located on FTCC's 30-acre state-of-the-art *Fire & Rescue Training Complex* on Tom Starling Road in Fayetteville, North Carolina.

Learn more <https://www.faytechcc.edu/swrtf>

# SWIFT

Pro Buoyancy Aid

by **Secumar**

**SPECIFICATION:**

**Color:** fluorescent yellow, red, black

**Material:** CORDURA® fabric

**Quick release mechanism:** 1

**Adjustment:** Elastic neoprene side panels with Velcro closure

[ED: This is available for around £205/ from Aspli in the UK. In Germany, SWS (Water Rescue-Bayern) offers this as a kit complete with Edelrid cutters, Singing Rock Cowstail with carabiner and an AustriaAlpin ring as an option and a Northern Diver Flexi light which is an 8 lumen light lasting 20-36hrs and tested to 60m



ED, we're not sure if this is so 'new' that it's not listed by Secumar or so old that it's been discontinued but it was new to us and obviously still available!]

New buoyancy aid for swift water rescue from Germany's leading life jacket manufacturer. Designed with the input of professional rescue services the compact shape ensures optimal freedom of movement for the wearer. The new personal buoyancy aid for rapid water rescue on moving and turbulent water, Swift Water Rescue for short. The vest, which is available in 4 sizes, is characterized by its very compact shape and low weight. Hidden front pockets easily accommodate a webbing sling and carabiner. Large reflective surfaces on the front and back ensure good visibility. The detachable crotch strap keeps the vest safely in position. The lifeline can be stowed in the large pocket in the back area and individual Velcro labels can be attached to the fleece surfaces of the pocket flap. The SWIFT is pulled over the head, adjusted to the body with two side panels with Velcro and fleece surfaces and three waist belts with plastic fasteners running in tunnels. It fits very snug and is very 'clean' in the front area to avoid snagging

- Adj waist straps:** 3
- Reflective stripes**  
Front and back / shoulder straps
- Detachable crotch strap**
- Cowtail mount:** 1
- Hidden storage pockets:** 2
- Inside pocket:** 1 (e.g. for a cold protection blanket)
- Large back pocket:** 1
- Small neck pouch**
- Universal mounting plate:** 2
- Adj padded shoulder straps with tabs**
- Water drainage holes**
- Quick release waist belt with D-ring for attachment of Cowtail**
- Neoprene stowage pockets**
- Back pocket with fleece surface for tactical badges**
- Shoulder strap with attachment loops**
- Neck pocket with fleece surface for name tag**

depth and allegedly visible from 3km/1.9 miles away. It's available in a range of colours but is single use only - the batteries aren't replaceable. This kit will set you back €355 as individual components or €242 from SWS as the complete kit. Bargain! ]

www.secumar.com  
www.aspli.com  
www.waterrescue.bayern

Sizing/ Actual buoyancy:  
S (40 - 60kg) ca. 50 N  
M (60 - 80kg) ca. 60 N  
L (80 - 100kg) ca. 70 N  
XL (100 - 120kg) ca. 80 N

Approvals: DIN EN ISO: 12402-5





# EVACUATION RAFT

INFLATABLE WATER RESCUE CRAFT

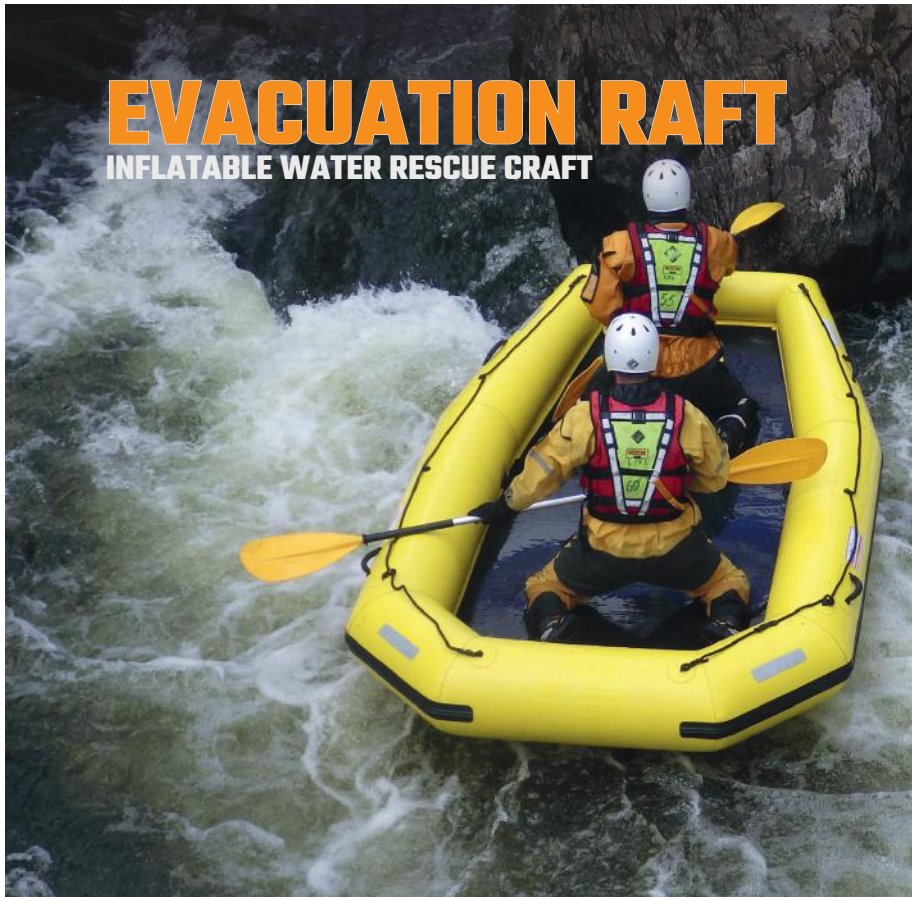

**MFC**International  
by RESPIREX  
ENGINEERED INFLATABLE PRODUCT SOLUTIONS

- Can be used in very shallow water (5cm or more)
- Closed stern to keep the deck dry and provides greater reassurance for casualties
- Can be paddled or pulled by hand
- Excellent stability
- 8 or 10 Person Capacities
- Available in Hypalon or TPU materials
- Extremely tough & durable
- Highly customisable
- Manufactured in the UK

W: [mfc-international.com](http://mfc-international.com)  
T: +44 (0)1443 433 075  
E: [sales@mfc-international.com](mailto:sales@mfc-international.com)



**Oceanid**<sup>TM</sup>  
WATER RESCUE CRAFT



[RDC@Oceanid.com](mailto:RDC@Oceanid.com)  
(208) 322-3600



# PALM PRO

## SAR MULTIROLE GLOVES

[ED: We've been researching Abseil/Rappel Gloves recently for the **ROPE EQPT BUYERS GUIDE** and thought the *Palm Pro* deserved a bit of a mention as a hybrid SAR/Water Rescue/Rope Rescue glove using an Armotex fabric on the palm instead of the usual leathers. It may not be for long drops although it does have a reinforced rope channel between the thumb and index finger but it is certainly worth a look as an all-rounder, in particular for cold, wet environments.]

Designed for search and rescue professionals, these extremely tough gloves are reinforced with high-strength fibres for serious work in cold and wet conditions.

- 2 mm super-stretch Neospan titanium neoprene for warmth when wet , embossed for flexibility
- Amara reinforced back of the hand
- Armortex reinforced palms and fingers
- pull tab
- titanium insulation
- velcro adjustable neoprene cuff
- velcro adjustable volume

Sizing: 140 g (S), 147 g (M), 151 g (L), 163 g (XL), 165 g (XXL)  
 COST: £50/\$70/€60

<https://palm.equipment>



# EXCEPTIONAL EFFICIENCY -

When snowmobiles and helicopters are the only realistic access options to your wilderness environment, the **OCEANID Rapid Deployment Craft (RDC)** will provide **Fast, Safe and Efficient** solutions for traveling through extremely difficult terrain. Depending on snow and ground conditions, the RDC is capable of ferrying 454 to 909kg/1000 to 2000 lbs. of equipment, cargo and personnel to and from emergency response events.

The RDC has the same width profile as a snowmobile which allows it to easily navigate the narrowest of trails without hindering the mobility of the snowmobile or the operator. Ready to deploy time, from folded in its bag to secured to the snowmobile, is well under 5 minutes.

Thousands of emergency first responders in the US, Canada and around the world have come to rely on the RDC as a critical component of their rescue kit. We appreciate your support and we're always looking to improve our products. To this end we have configured six new Rescue Packages, tailored to specific rescue scenarios. Visit our new website, At Oceanid, we're proud to be at your side during the most difficult water, ice, mud and snow rescue situations.



Gain the advantage with CMC's new

# CAPTO™



CMC™

[cmcpro.com](http://cmcpro.com)

# EXTREME ENVIRONMENTS



Tows incredibly well behind a snowmobile when used for patient transport or equipment hauling.



The Snowmobile Tow Package includes all necessary hardware and fittings, including protective tow shield and fittings, t



Snow Towing Package: Total Price \$6,100  
Includes Rapid Deployment Craft, Tow Shield and Tow Hardware.

[www.oceanid.com](http://www.oceanid.com)

# WRS<sup>®</sup> INTERNATIONAL

High Volume Bow and Rocker - With a raised bow height the X-Sled is able to handle tethers in swift water whilst reducing the risk of the bow diving when loaded. The increased volume maintains stability when occupied by a casualty or rescuer.

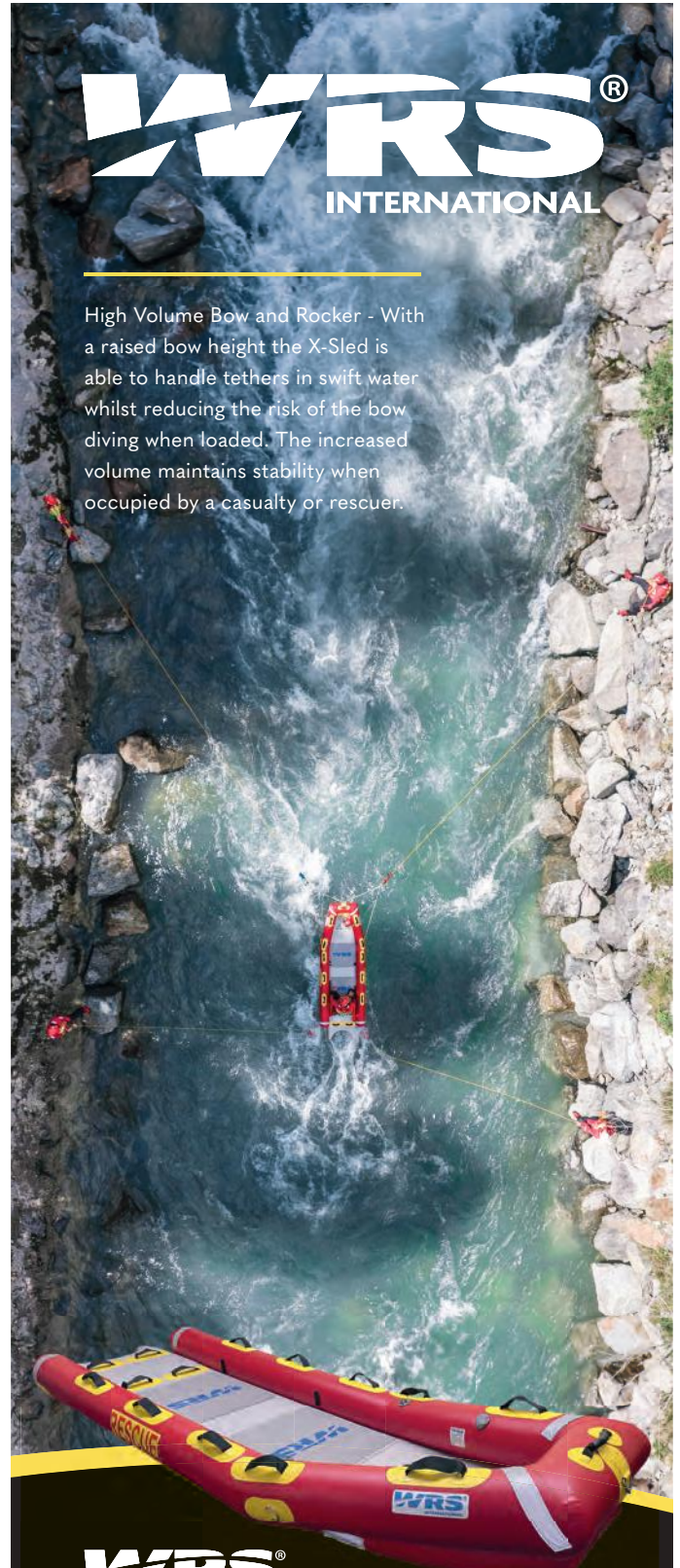

# WRS<sup>®</sup> INTERNATIONAL

## Water Rescue X-Sled

The original and best since 2014, designed in the UK.

[www.wrsinternational.com](http://www.wrsinternational.com)



# New CMC SQUID rigging organiser

[ED: The Squid is the most recent addition to our Rigging Plates guides in the **BUYERSGUIDES** and as always, CMC have some excellent background and testing that's much more interesting than a regular press-release!]...the SQUID is an innovative solution for twin tension rope systems (TTRS) and load-sharing applications. Its multi-planar design features a large attachment point for redundant anchoring and two perpendicular points for optimal alignment. SQUID efficiently brings two hardware devices side-by-side for dual operation and better shared tension. SQUID also sets ideal spacing between devices, allowing a single operator to maintain simultaneous twin tension control using dual-handle technique (aka "shark finning" or "DOUBLE CLUTCHING"). SQUID promotes safe and efficient rigging of dual capacity TTRS and provides smooth raising and lowering in mirrored and nested systems.

SQUID streamlines the rigging of redundant load-sharing systems. The SQUID's attachment points are compatible with a wide range of connection methods and they position rope hardware for easy loading and unloading while connected. SQUID naturally orients toward the load and lets components move freely, reducing the risk of binding and shifting in the event of anchor or line failure. Strong and compact, SQUID is a versatile tool for TTRS, litter bridles, cross hauls, and more. SQUID is CE marked, classified to NFPA General Use for specific configurations including TTRS, and classified to NFPA Technical Use when the secondary points are pulled directly apart from each other.

Note: textile breaking strength may be reduced when directly connected to the SQUID. See test data opposite.

## Features:

- Multi-planar rigging plate with perpendicular attachment points
- Optimizes device alignment for twin tension rope systems (TTRS)
- Enables single operator control for better shared tension
- Promotes smooth loading / unloading of connected hardware
  - Allows components to



move freely and orient toward the load

- Reduces shifting / extension in the event of line or anchor failure
- Aligns secondary points for high strength and easy load sharing
- Supports a variety of connection methods for versatile rigging
- Provides large collection points for building redundant systems
- Primary attachment point fits two (NFPA-G) or three (NFPA-T) carabiners\*
- Secondary attachment points fit one (G) or two (T) carabiners
- Simple and solid aircraft grade aluminum - no moving parts
- Strong, compact, and lightweight for multiple applications

\*More carabiners may fit in the SQUID attachment points depending on the type of carabiners, applied loads, and rigging practices involved. Care should be taken to avoid binding, wedging, or other geometric restraints.

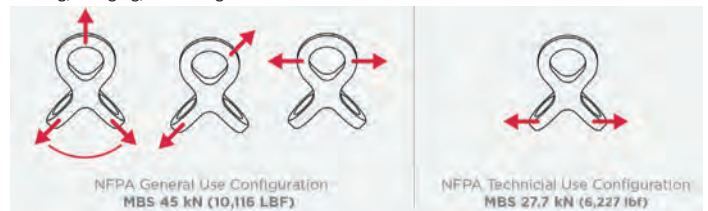

## More About Twin Tension Rope Systems:

SQUID is purpose-built to optimize device alignment in twin tension rope systems (TTRS). It simplifies the technique of bringing two devices together in a mirrored, dual handle orientation and allows a single operator to provide simultaneous twin tension control. By maintaining shared tension across two rope systems, there is reduced risk of single line failure. If such a failure does occur, TTRS has the advantage of limiting shock and extension by transferring the load to an already stretched and loaded rope. While TTRS can be deployed in a variety of ways, using the SQUID to bring two CLUTCHES together in DOUBLE CLUTCH Technique creates a lowering/hauling system that meets best practices, minimizes failure risk, and offers the potential to reduce personnel requirements.

## More About Rig Plates:

Rig plates are a key piece of equipment for building anchors, managing rope systems, and organizing connections. Using a rig plate assists with cleaner operations by spacing out components and making each part easier to assess. The SQUID's multi-planar secondary attachment points have the added benefit of aligning multiple devices and separate lines in distinct order, keeping them orderly and easy to control. The SQUID also serves as the collection point for a variety of attachment methods and allows building connections to multiple secure anchor points. Larger rig plates and anchor plates may have increased potential for rotation and system extension if any movement or failure of an anchor occurs. The SQUID is strong and compact with inherent load sharing capabilities. It naturally orients toward the load, letting components move freely and reducing the risk of binding and load shifting in the event of dynamic or directional impacts to the system.

## More About Doubling Up:

We've received a number of questions about doubling up rig plates to meet IRATA standards. We realize this is a topic of much debate. Due to its 3D shape, SQUID is not intended to be doubled up or used back to back with another SQUID (as cool as a squad of squids might be). In our assessment, SQUID's high strength ratings and robust design make it a suitable 3D anchor for attaching multiple connectors in a life safety system without doubling it up. If additional redundancy is required to meet applicable standards or norms, a possible method is to use a soft connection to back-up the attachment points, such as a sewn sling.

## SQUID TEXTILE TESTS

### INTRODUCTION

The SQUID attachment points are primarily designed for use with carabiners. While these points are also compatible with a variety of other connection methods, direct connections using textiles may have reduced breaking strength due to the SQUID's chamfered edge. CMC conducted a series of tests to evaluate this potential strength loss and provide a high level summary of the data.

### TEST METHOD

A selection of industry soft goods were directly connected to the SQUID in various rigging configurations and pulled to failure. A 1.3 cm (0.5 in) shackle was used as the control to compare the difference between SQUID and a fully rounded attachment point. The following rig-

ging configurations were evaluated to analyze the breaking strength of various soft goods when directly connected to the SQUID. For Tubular Webbing, Sewn Prusiks, and Texora Black Mambas, connections were rigged in a double girth hitch to simulate typical field methods for using the SQUID to build redundant anchors without added carabiners. For CMC G11, a single line was knotted and pulled to failure.

### KEY TAKEAWAYS

- Results are specific to the materials, loads, redundancy, and rigging practices involved.
- SQUID textile connections may have reduced breaking strength relative to a rounded shackle.
- Stable connections are preferred to reduce movement along SQUID (dressed hitches, sewn rather than tied prusiks, etc.).
- Burrs and sharp points can further reduce textile strength, when in doubt use a carabiner.
- Follow best practices for load sharing and redundancy, especially for webbing and cord.

### EXAMPLE CONNECTIONS

The following images demonstrate high strength textile connections that meet guidance for redundancy, load sharing, and stability.

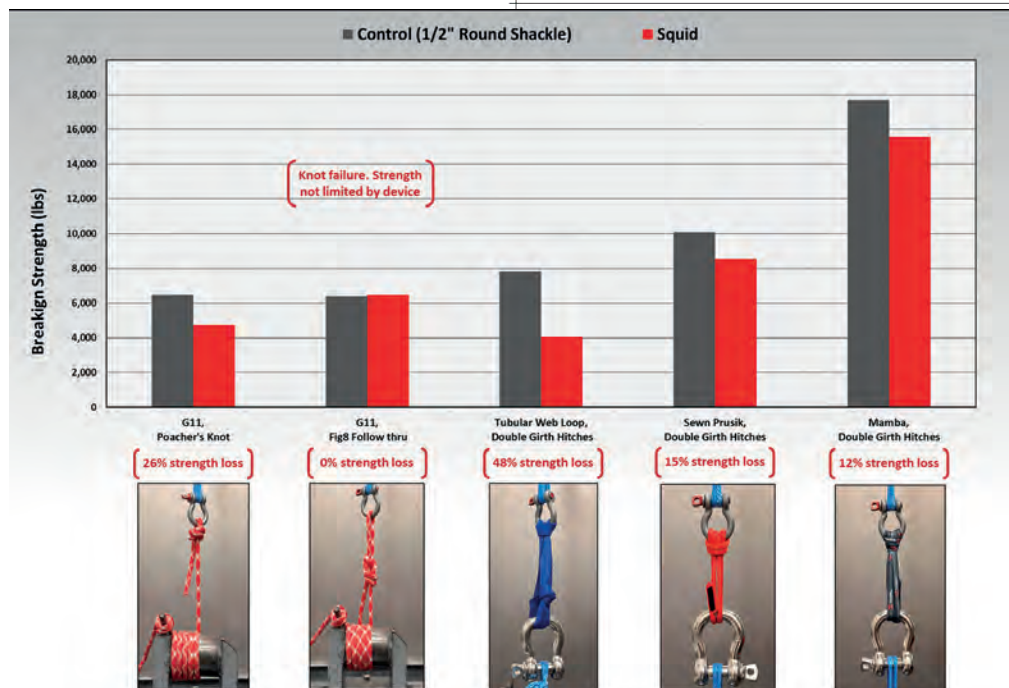
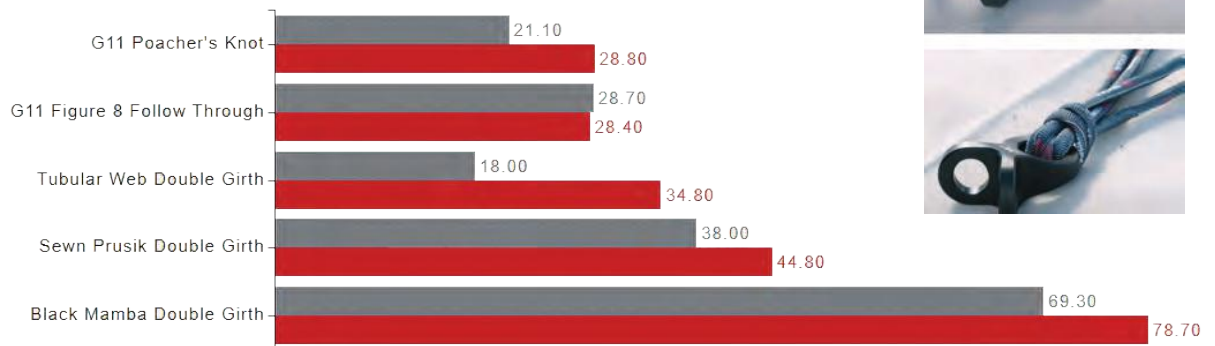

### WARNINGS

The SQUID attachment points are primarily designed for use with carabiners and are also compatible with a variety of other connection methods. All connections should be evaluated for risk based on the loads, redundancy, and rigging practices involved. The breaking strength of textiles may be reduced when directly connected to the SQUID. CMC recommends following best practices for redundancy and load sharing when making connections. Verify there is no excessive wear or indications of damage such as deformation, corrosion, sharp edges, cracks, or burrs. Minor nicks or sharp spots may be smoothed with emery cloth or similar.

Size: 104 X 84 X 51 mm / 4.1 X 3.3 X 2.0"  
 Eyes: 36 & 27mm/ 1.42 & 1.07"  
 Cost: \$149 approx £150/£170  
 Weight: 240g / 8.5oz  
 Web: www.cmcpro.com



**NEW**  
**LEATHERMAN**  
**ARC**

**TOOLS**

- ◆ MagnaCut Knife Blade
- ◆ Needlenose & Regular Pliers
- ◆ Large Bit Driver ◆ Edge File
- ◆ Diamond-coated File ◆ Pry Tool
- ◆ Small Bit Driver ◆ Wood/Metal File
- ◆ Premium Replaceable Wire Cutters
- ◆ Premium Replaceable Hard-wire
- ◆ Cutters ◆ Impact Surface (hammer)
- ◆ Large Screwdriver ◆ Awl
- ◆ Bottle Opener ◆ Can Opener
- ◆ Spring-action Scissors ◆ Saw
- ◆ Wire Stripper ◆ Electrical Crimper

**SPEC:**

Cost:	\$230/£261/€300
Weight:	8.6 Oz. 243.8g
Closed length:	4.25" 10.78 cm.
Open length:	6.45" 16.39 cm.
Blade length:	2.76" 7.02 cm.
Blade hardness:	60-63 hrc
Width:	1.3" 3.4 cm.
Overall thickness:	0.68" 1.7 cm.

**Materials:**

420 Stainless steel, 440c stainless steel, dlc coating, magnacut steel, pvd coating

**Included bits:**

Torx #10 & #15, torx #20 & #25, pozi #2 & #1, hex 1.5mm & 2mm, hex 2.5mm & 3mm, hex 4mm & 5mm, screwdriver 3/32" & 1/8", robertson #1 & 2, robertson #2 & 3

Web: [www.leatherman.com](http://www.leatherman.com)

[ED: Although we have the very similar FREE P4 we haven't had hands on with this one and at first sight we thought - nice casing but otherwise - isn't it just a variation on every other model? Not quite. Like the FREE, ARC has a 'loose-hinge' to enable one handed-swinging of the tool arms to open the pliers. It also has a feature we would like to have seen on most multitools from the start; access to all tools when the tool is closed. We realise there are drawbacks to this but on balance, being able to get out every tool with one hand, straight from your pocket is going to outweigh the negatives. And these all lock and then unlock with one hand without risking severing your fingers. The only other thing of note aside from the slick stainless fascia, is the main cutting blade being MagnaCut steel - a supposedly tougher more enduring material for a cutting edge and noticeably dark compared to the other blades/tools so easy to spot when you want it. Easier to get out too because it has taken a leaf out of previous tools and put a thumb stud on the blade to ease in getting it out. The slimline pocket clip can be removed and it has the usual array of driver bits. Not cheap but some very fine materials and details and all the tools you will want in a more useful than normal configuration ]

New **PETZL** **XENA**  
Headlamp



[ED: Out in spring 2024 and likely to be around

£120/\$155/€140 plus import duty, local taxes and shipping etc. but don't hold us to that. Petzl are the word masters in headlamps - they seem to come up with some new innovation every few months and this is a very crowded market so there is plenty of competition for your money. We currently use Peli, Unilite and LED Lenser as well as Petzl but if you had to choose one brand for headlamps it would have to be Petzl. This is another diminutive sized model unlike most of their recent introductions which were pushing for brighter-further-longer (and costlier). This one is rechargeable with plenty of head/helmet mount options. ]

The XENA® headlamp is a powerful, rechargeable, lightweight and balanced headlamp designed for maintenance, industrial, inspection and technical rescue professionals. It offers a weight-to-power ratio of 185 grams / 1400 lumens, making it an excellent choice for professionals who require a high level of brightness without extra weight.

The battery pack is located at the back, providing a balanced and comfortable fit. It is also durable, drop and impact resistant, and water and dust proof, making it suitable for various working conditions. The headlamp has three beam types and five light levels, ensuring optimal visual comfort in different situations. CONSTANT LIGHTING technology maintains a stable light intensity over time.

It also includes a rotating knob that is easy to use, even when wearing gloves. The XENA® Headlamp can be worn on the head or mounted on a variety of helmet types using compatible accessories. It is rechargeable via USB-C, and the battery is removable and replaceable.

- Weight: 185g / 6.5oz
- Brightness: 1400 lumens
- Water resistance: IP67
- Impact resistance: IK07
- Drop resistance: 1 metre/3.28ft
- Energy: 3200 mAh rechargeable lithium-ion battery, 3.7 V, 11.84 Wh (included)
- Charging time: 3.5 H

[www.petzl.com](http://www.petzl.com)



**SKELETOOL® RX**

An essential tool for EMTs or first responders with a 154CM serrated blade and a carbide glass break bit.



**LEATHERMAN®**

Available online from:  
[www.whitbyandco.co.uk](http://www.whitbyandco.co.uk)



WORK AND RESCUE TRAINER

# JOIN THE TEAM

For more information and to apply, click here

**LYON**  
WORK & RESCUE TRAINING

**VENTURE FURTHER**







We have a couple of other Grand Canyon National Park Ranger pictures in this issue, so it's only fair to show you their awesome area of operations. This is the Grand Canyon in February from Powell Point on the South Rim . Photo by Michael Quinn

# FIRST AID in AUSTERE ENVIRONMENTS & WILDERNESS AREAS



# SAR PART 7 SAFETY



By **Greg Toman**

*Greg was awarded a Churchill Fellowship for this research in 2019. A few years on, some of the personnel mentioned may have changed post but most things remain unchanged. Greg is currently leading the development of the remote rescue capability for the Queensland Fire & Emergency Service in Australia. Outside of the Fire Service, Greg's background includes a Diploma in Outdoor Education, outdoor pursuits instructor (rock climbing and whitewater kayaking), rafting guide, and instruction in advanced swiftwater rescue and high angle rescue internationally.*

*Main Photo: Linville Central Rescue Squad NC USA by Halley Burlseon - Appalachian Exposures. See WSAR#10 for more on this team and a cover shot by Halley*

## FIRST AID

All volunteer and professional rescue organisations visited had an appointed medical director or advisor. The role of the medical advisor included developing procedures and protocols for pre-hospital care undertaken in a remote or wilderness environment, having taken into account the range of injuries / illness commonly encountered by the rescue team. The medical advisor was also involved in defining the level of training required and would oversee the level of care provided. They had a detailed understanding of the environment and issues faced by the search and rescue group, as well as an understanding of rescue techniques / equipment used.

The minimum level of first aid training required of its rescue personnel by volunteer organisations was the Wilderness First Aid (40 hour) or equivalent. In many cases, volunteer organisations also had team members with a higher level of first aid qualification ranging from Wilderness First Responder (80 hour) to Emergency Medical Services (EMS) to Paramedic, and even up to Medical Doctor.

The professional rescue organisations required first aid training starting at Wilderness First Responder (80 hour) or equivalent, through to EMS or Paramedic level. In many of the volunteer and professional rescue organisations, their medical director had included pain management protocols, advanced airway management and intravenous fluid therapy in the pre-hospital care capability. The pain management protocol varied from oral medication to intravenous medication.

The requirement for a minimum Wilderness First Aid or equivalent level of training was based on personnel operating in the 'front-country' or 'back-country'. Back-country being considered a usually uninhabited area inaccessible by roads or by regular public transport. Austere or mountainous rescue incidents by nature are considered to be in the backcountry or wilderness.

In the late 1990's, the Mountain Rescue Council in the United Kingdom, commissioned the development of its own syllabus and certification for its members, based on the need for special equipment and the long protracted periods when the casualty was in the care of the rescuer. The result was the development of the *Casualty Care in Mountain Rescue* manual and certification process.

There are many inherent risks involved in mountain rescue, the most common being rockfall. This can occur due to the natural

degradation of the mountain, strong winds, rain, downwash from helicopters, other people on the mountain and even the actions of rescuers. Injuries from being struck by a rock of any size can be significant. Accessing a casualty using a ground-up approach or traversing (roped or unroped) presents a risk of falling with a range of consequences from minor injuries (cuts / abrasions) to major injuries (fractures, dislocations, penetration wounds, head injuries).

Environmental conditions and activities undertaken by rescuers can lead to temperature related illnesses (hypothermia and hyperthermia). Venomous snakes, spiders and insects pose a real risk to rescuers travelling through the bush or in the mountains.

It is often not possible or appropriate for rescue teams to have 'front country' medical personnel (i.e. paramedics) accompany them on technical rescues, unless they possess the same level of knowledge, skill, ability and fitness as members of that rescue team. Appropriate personal protective clothing and footwear are also required. Therefore, if medical assistance is required by a rescue team member it will be primarily the

responsibility of the rescue team to provide this. If available, medical assistance can often be provided via a rescue helicopter service. A 2012 North America Research Project by Victorian Paramedic Kerryn Wratt on:

*"Improving pre-hospital*

*care in remote and wilderness environments of Victoria, Australia"*

identified the specialist medical training, wilderness training, fit for purpose light-weight equipment and physical fitness required to "establish a paramedical team with the ability to safely enter a remote or wilderness environment for the purpose of providing clinical care to patients and other responders".

As for an injured rescuer, the mountain rescue team will be responsible for providing pre-hospital care for a casualty until medical personnel can access the casualty in-situ, or after the rescue team has transported the casualty to the medical personnel. As a member of a mountain rescue team, not having a sufficient level of knowledge and ability in first aid to provide the necessary pre-hospital care to a casualty can be detrimental for the casualty, and at the same time can cause unnecessary anxiety, stress and feeling of guilt for the rescuer.

## PSYCHOLOGICAL FIRST AID & STRESS INJURIES

Highlighted throughout my 2019 research trip, was the acknowledgement of the heightened risk to mountain rescue personnel (and other emergency responders) to stress related injuries and illnesses. There was also acknowledgement that the 'old school mentality' of 'harden up or get out' is totally unacceptable, and that much more has to be done to address stress injury.

For most, the term 'safety' is interpreted as steps taken to ensure the physical well-being of a person. Rescue teams invest heavily in training and equipment, the development of systems and procedures with the underpinning aim of ensuring physical safety of the rescuer and casualty.

Claudine Ronay, the Family Liaison Officer and Critical Incident Stress Manager for Yosemite Search and Rescue, identified the work by Dr Patricia Watson and Laura McGladrey on 'Psychological First Aid and Stress Injuries' as having the most positive impact in this field throughout the US National Park Service.

In 2019, Yosemite Search and Rescue conducted educational sessions for their staff on stress injury and psychological first aid. These sessions looked at the Combat and Operational Stress Continuum and the treatment principles of psychological first aid. The Combat and Operational Stress Continuum Model recognises the entire spectrum of stress responses and outcomes, from adaptive coping and full readiness, to clinical mental disorders arising from stress and unhealed stress injuries.

As a rescuer, we should be aware of our current physical and mental state. We should be professional enough to risk assess our potential involvement in rescue operations and ensure that our safety and well-being is prioritised, along with that of the rescue team. The rescue team should be conducting the same risk assessment process for each member, and the team as a whole. If an injury, physical or psychological is identified,

first aid treatment should be provided. For the individual or the team to be able to effectively assess their psychological state, both must have an awareness and understanding of potential stimuli for stress, the signs and symptoms of stress

and the levels or types of stress injury. Stress injury may not only affect a rescuer's cognitive performance it may also affect their physical performance. In this US marine Corps chart (table 1) The **Green** 'Ready' Zone does not infer an absence of stress, rather it is an ability

to integrate stress without significant distress or impairment in social or occupational functioning. Attributes and behaviours of a person operating in the **Green Zone** are:

- Remaining calm and focused
- Getting the job done
- Remaining in control physically, mentally and emotionally
- Behaving ethically and morally
- Getting sufficient sleep
- Exercising and staying fit

In the **Yellow** 'REACTING' Zone, rescuers would feel mild and temporary distress or loss of function due to stress. The distress or loss

of function is resolved as soon as the stress stimuli has gone or the rescuer adapts to the stress and becomes accustomed to it. The following experiences and behaviours are characteristic of this Zone:

- Feeling anxious or fearful
- Cutting corners on the job
- Being short tempered, irritable or angry
- Having trouble sleeping
- Lack of motivation
- Keeping to oneself
- Being negative or pessimistic
- Diminished capacity for mental focus

In the **Orange** 'INJURED' Zone the rescuer has more severe and persistent forms of distress or loss of function that signals the presence of some kind of damage to the mind, brain or spirit.

Symptoms that suggest a stress injury include:

- Losing control of one's body, emotions, or thinking
- Having difficulty falling asleep or staying asleep
- Waking up from recurrent, vivid nightmares
- Feeling persistent, intense guilt or shame

**"A survey conducted in four American states in 2015, including over four thousand EMTs and paramedics, revealed that 87% of the responders had experienced critical stress, and that 37% of those had contemplated suicide with 6.6% having actually attempted to take their own life".**

McGladrey, L. "Psychological First Aid and Stress Injuries", Chapter 10, Wilderness EMS (2018)

READY (Green Zone)	REACTING (Yellow Zone)	INJURED (Orange Zone)	ILL (Red Zone)
<p><b>Definition</b></p> <ul style="list-style-type: none"> <li>- Adaptive coping and mastery</li> <li>- Optimal functioning</li> <li>- Wellness</li> </ul> <p><b>Features</b></p> <ul style="list-style-type: none"> <li>- Well trained and prepared</li> <li>- Fit and focused</li> <li>- In control</li> <li>- Optimally effective</li> <li>- Behaving ethically</li> <li>- Having fun</li> </ul>	<p><b>Definition</b></p> <ul style="list-style-type: none"> <li>- Mild and transient distress or loss of optimal functioning</li> <li>- Always goes away</li> <li>- Low risk for illness</li> </ul> <p><b>Features</b></p> <ul style="list-style-type: none"> <li>- Irritable, angry</li> <li>- Anxious or depressed</li> <li>- Physically too pumped up or tired</li> <li>- Loss of complete self control</li> <li>- Poor focus</li> <li>- Poor sleep</li> <li>- Not having fun</li> </ul>	<p><b>Definition</b></p> <ul style="list-style-type: none"> <li>- More severe and persistent distress or loss of function</li> <li>- Leaves a "scar"</li> <li>- Higher risk for illness</li> </ul> <p><b>Causes</b></p> <ul style="list-style-type: none"> <li>- Life threat</li> <li>- Loss</li> <li>- Inner conflict</li> <li>- Wear and tear</li> </ul> <p><b>Features</b></p> <ul style="list-style-type: none"> <li>- Panic or rage</li> <li>- Loss of control of body or mind</li> <li>- Can't sleep</li> <li>- Recurrent nightmares or bad memories</li> <li>- Persistent shame, guilt, or blame</li> <li>- Loss of moral values and beliefs</li> </ul>	<p><b>Definition</b></p> <ul style="list-style-type: none"> <li>- Persistent and disabling distress or loss of function</li> <li>- Clinical mental disorders</li> <li>- Unhealed stress injuries</li> </ul> <p><b>Types</b></p> <ul style="list-style-type: none"> <li>- PTSD</li> <li>- Depression</li> <li>- Anxiety</li> <li>- Substance abuse</li> </ul> <p><b>Features</b></p> <ul style="list-style-type: none"> <li>- Symptoms and disability persist over many weeks</li> <li>- Symptoms and disability get worse over time</li> </ul>
Unit Leader Full Responsibility	Individual, Peer, Partial Responsibility	Individual, Peer, Partial Responsibility	Caregiver Responsibility

Table 1 US Marine Corps, "Combat and Operational Stress Control"



**FOR THOSE COMMITTED TO OTHERS,**

**EQUIPMENT COMMITTED TO YOU**

***Our customers risk their lives to save others.*** That's the kind of selflessness that calls for nothing but the best gear. At Cascade Rescue, we are committed to making the highest quality safety and rescue equipment. From aerial evacuation equipment to rescue toboggans, trail wheels and rigging kits, everything we make is designed and manufactured with safety, and efficiency, in mind. So whenever the wind is howling, the snow is falling and you are surrounded by darkness, you can trust Cascade Rescue products to help you accomplish your mission - ***saving lives.***



844.414.RESQ  
CASCADE-RESCUE.COM

- Feeling attacks of panic or blind rage
- Losing the ability to remember, think rationally or maintain focus
- Losing confidence in previously held moral values
- Harbours serious suicidal thoughts

The **Red** 'ILL' Zone is the zone of diagnosable mental disorders. The most widely recognised stress illness is PTSD, with other common illnesses being depression disorders, anxiety disorders and substance abuse. Indicators of the presence of a stress illness are:

- Long lasting and disabling distress or impairment of normal functional
- Stress injury symptoms and impairments that do not improve over several weeks
- Stress injury symptoms and impairments that worsen over time
- Stress injury symptoms and impairments that return after seeming to resolve

Psychological first aid can be applied to anyone who has experienced a trauma. A trauma being when a stimulus overwhelms one's capacity to integrate it. In

the context of mountain rescue that potentially means both the subject of the search and rescue, and members of the rescue team can benefit from psychological first aid.

A summary of the Treatment Principles for Psychological First Aid for the Patient:

#### 1. Create a sense of safety by:

- Mitigating the scene by reducing chaos and removing patients from perceived risk
- Provide physical safety and use language of safety ... "now that you are safe"

#### 2. Create calm by:

- Calming yourself first and demonstrate calm
- Work on the rescuer and patient breathing – bring it back to normal
- Empathetic listening
- Alleviate connected anxiety ... "your partner is safe, now let's take care of you"
- Emphasising the present, the practical and the possible

#### 3. Create self and collective efficacy by:

- Involving the person in problem-solving, self-care and rescue
- Recognising and reminding people of existing strengths

#### 4. Create connection by:

- Building an on-scene relationship
- Use patient and rescuer names
- Helping people contact family, friends, loved ones

#### 5. Create hope by:

- Keep positive ... "we've got this"
- Reflecting specific, accurate, positive facts and predictable, realistic steps
- Be future oriented ... "distance and / or time to trailhead"
- Personally maintaining and communicating hope

Adapted from "Wilderness EMS" (2018) Chapter 10, Table 10.2

Summary of methods for reducing Rescuer Stress Injury

#### 1. Minimise traumatic exposure

- Avoid unnecessary exposure
- Pause for changes from rescue to recovery, and provide a chance to opt out

#### 2. Potential for stress injury

- Be aware of stress injury formation
- Mode of Injury – overwhelmed, emotional connection, helplessness, error / guilt, isolation, near-miss, fatalities

#### 3. Signs and Symptoms

- Be aware of the signs and symptoms for the various levels of stress injury ... Ready, Reacting, Injured, Ill

#### 4. Follow-up

- On-site debrief
- One-on-one peers / leadership
- Incident support

#### 5. Ask for help

- Peer and professional help

Source: RMRG Field Guide for Rescuer Stress Injury

**"Going out to rescues in the Orange and Red in the Stress Continuum is like going out with a known back injury and having to carry a heavy pack or stretcher. Over time you will get worse to the point that you will not be able to physically function"** McGladrey, L. "Psychological First Aid for Mountain Rescuers – Series 2 (podcast)

The aim of this series on SAR SAFETY has been to highlight developments in remote / mountain rescue

that an enhance the overall safety of the rescuer and those requiring rescue. This article is just that, an attempt to highlight the importance of Psychological First Aid and Stress injuries in mountain rescue. As a fellow rescuer, I would encourage you to take advantage of the following resources that are available online and to 'spread the word'.

- Responder Alliance – Education, Advocacy, Innovation, Support <https://responderalliance.com>

- Psychological First Aid for Mountain Rescuers: Episode 1 – Stress Injuries [https://www.youtube.com/watch?v=rnc5\\_RFUygs](https://www.youtube.com/watch?v=rnc5_RFUygs)

- Psychological First Aid for Mountain Rescuers: Episode 2 – Principles in real Time <https://www.youtube.com/watch?v=ZjtIA-lNe1U>

- Psychological First Aid for Mountain Rescuers: Episode 3 – Sustaining Green <https://www.youtube.com/watch?v=QF2JQ1I634I>

- Combat and Operational Stress Control, MCTP3-30E, US Marine Corps [chrome-extension://efaidnbmnnnibpcajpcglclefindmkaj/https://www.marines.mil/Portals/1/Publications/MCTP%203-30E%20Formerly%20MCRP%206-11C.pdf?ver=2017-09-28-081327-517](https://www.marines.mil/Portals/1/Publications/MCTP%203-30E%20Formerly%20MCRP%206-11C.pdf?ver=2017-09-28-081327-517)

- Mountain Rescue Association, LMS, Psychological First Aid – A discussion Course <https://training.mra.org/>



# ROPE & EQUIPMENT

FOR YOUR VERTICAL WORLD

## 11 MM EXTREME PRO™ (G) ROPE MBS = 42.9 kN

UNICORE® TECHNOLOGY

SHEATH – 100% POLYESTER

CORE - 100% NYLON 6

NFPA 1983: 2017 (G)



PMIROPE.COM



# PREPARING for TREE RESCUE

## TREE CLIMBING FOR RESCUE TECHNICIANS

*ED: Regular readers will be aware of the close ties we have with the arb community, indeed several of our past and current rescue staff have a background in arboriculture and many maintain skills to this day. We always considered that the best qualifications for a rescue recruit was to be a firefighter-paramedic who moonlighted as an arborist and had scuba diving as a hobby! Tree work being the very epitome of rope skills on an inherently unstable structure in all weathers whilst wielding the most dangerous tool in rescue - a chainsaw!*

*There has been a sea-change in methodology and skills requirements in the past decade or so and it is with no degree of humility at all that I'm going to lay claim to being one of the first to employ rope access/rescue style SRT techniques to arb work in the early 80's at a time when 12mm laid nylon prusiks on 12mm laid or multiplait was the norm. So much so that I was often berated for the slight increase in time that my methods required despite increased safety margins, access and mobility. We started ARBCLIMBER magazine as a sister publication to our rescue titles once ropework in the arb sector started to take SRT and DRT as seriously as the previously dominant DdRT. Of course the arb sector needed to claim some degree of ownership so they renamed SRT and DRT as SRS or Stationary Rope Systems while DdRT (Doubled Ropes) was renamed MRS for Moving Rope Systems. Rescue too was taken far more seriously than ever before with aerial rescue actively trained for and even incorporated in all arb climbing competitions. But, while self rescue has become a high quality discipline amongst well trained and well funded arborist companies with properly maintained teams there are an equal number of one or two-man bands and less well trained and equipped businesses to keep rescue agencies on their toes. Even the best trained arborists can only deal with basic strandings and rapid evacuation scenarios. More serious incidents with injuries and particularly prospective spinal cases need the assistance of the local emergency services and some more serious kit. In this article, Roland takes us through the provisional familiarisation and skills they came up with to help deal with arb incidents. Initially this involves becoming familiar with standard arborist equipment and techniques including rescue which are many and varied and may well be completely alien to firefighters trained only in basic, pre-rigged kit-based rope rescue. One or two of the pictures in this article are from Ropes That Rescue's extremely comprehensive 7-day arborist rescue course not NSW Police's in-house training highlighted in Roland's article. However Roland is a 'graduate-with-honors' of Ropes that Rescue courses under Reed Thorne's tutelage. Incidentally, Reed's chip off the old block - Keith IS a professional arborist and has his dad playing second fiddle on the arb rescue courses mentioned in Reed's ad overleaf.*

by **Roland Curll**  
**NSW Police Rescue - Australia**

Roland is a 20 year veteran of Police Rescue in NSW Australia responsible for rope rescue, extrication, SAR, trauma-care and swiftwater rescue in the Illawarra region south of Sydney. This huge region incorporates Wollongong, Shellharbour, Port Kembla and Kiama with significant coastal cliffs plus the Upper Nepean river basin with remote bush, forest, canyons and waterways.



**if an arborist trained in aerial rescue is unable to complete the rescue of a colleague due to its complications, will the responding rope rescue team have the skills to complete the rescue?**





**W**hen it comes to conducting a rope rescue, pretty much every team is trained to execute the rescue by setting up an anchor point at the top and moving down to the casualty. a common rope rescue setup is to have an Arizona Vortex (or similar tripod/ multipod) on the edge as an artificial high directional, and a two-rope system involving a mainline and a belay line, or a twin tension system. Each of these two ropes are individually attached to a separate ascent/descent control device such as a CMC Clutch or a Petzl Maestro. Alternatively the rescuer may descend with a belay or second rope safety but either way to execute the rescue successfully you need good access to the top of the incident site and sound anchors. But what if you cannot establish top-anchors? What if the patient that needs rescuing is up a tree?

'Bottom up' rescues may be common for some teams in places like Yosemite where lead climbing skills are utilised to climb up to the patient. But this would be unusual for metropolitan rescue teams whereas rescues from a tree requiring a bottom-up rescue may be far more likely.

Fire rescue teams can often complete a rescue from a tree by using an elevated/ hydraulic platform or a ladder but these can be hard to position in a congested canopy or impossible to get a vehicle close enough to the tree even in the middle of a city. But saying all tree rescues can be accomplished with a ladder is like saying all cliff rescues can be achieved with a helicopter. Occasionally more specific skills are required when a rescue situation presents complications that are not common when compared to the majority of rescues that a team responds to.

This article is intended to highlight the differences between arborist methodology and those of rescuers who do not usually (if ever) perform 'bottom up' rescues and should perhaps add this to their skills repertoire. Of course, the current skills of the rope rescue team may be sufficient to complete the rescue



Pick-Off rescue courtesy of Rope-that-Rescue

using standard techniques but it would still be as well to familiarise yourself with the kinds of gear you might be confronted with and why/how it is being used by arborists.

The first thing to note is that arborists place their climbing rope using a weighted throwline skilfully lobbed by hand (or by crossbow etc) over a target branch with the help of a small weighted sandbag. Arborists will usually then install a friction saver using the throwline cord. This is a sling with two metal eyes, (one larger than the other to allow the weight-pouch to pass through) that will be dragged back up and over the branch with the weight-pouch then falling back to ground. This is then connected to the end of the climbing rope which is hauled up and through the friction saver eyes (or straight over the branch if no friction saver has been installed) and back to the ground. The rope can then be anchored at the base for SRT (SRS/Stationary Rope System), or, more usually used for MRS/ Moving Rope System of Doubled Rope Technique or DdRT where the tail end of the rope is tied into the harness and the other (longer) end is connected to the harness via a climbing hitch or a mechanical prusik also called a hybrid device as they both function as ascenders and descenders. more on this shortly but note the small 'd' in DdRT. Not to be confused with the much lesser used DRT or Double Rope Technique which is a stationary rope system where both ropes are loaded simultaneously instead of alternately, usually for descent. Some rescue teams will be familiar with throwlines or pilot lines for sending ropes across ravines/ buildings for highlines or for cliff-to-helo ops. Arborists use very thin 2mm or so throwline or carrier cord for maximum distance and least resistance and this is a skill worth mastering for anyone involved in rope access or rescue. A throwline may not work all the time to reach the full height required and arborists may physically climb from limb to limb using shorter throwline lengths or thrown lanyards which we'll discuss shortly.

Arborists themselves are trained to rescue colleagues from trees, this is

# TECHNIQUES

referred to as aerial rescue and is a regular competition event. Aerial rescue courses train an arborist to a certain level including haemorrhage control with a CAT which is now a standard item in an arb first aid kit. They can provide rapid access and stabilisation and pick off to ground if circumstances permit. Anything more complex involving serious injury or entrapment and emergency services will be required, Which raises the question, if an arborist who is trained in aerial rescue is unable to complete the rescue of a colleague due to its complications, will the responding rope rescue team have the skills to complete the rescue? You might consider using ropes that are already in place but this would contravene most rescue team's protocols since you have no way of knowing the efficacy of rope or anchor. If you haven't practiced throwlining it may be possible for the rope rescue team to utilise another on-site arborist to establish your own ropes for you?

In most countries arborists have workplace safety standards that require a tree climbing professional on standby in case an arborist needs rescuing. Many rescue incidents involving an arborist stuck in a tree could be resolved by the standby rescue person/team, or the arborist themselves could complete a self-rescue so a rope rescue team may never be called. But a rope rescue team can most certainly be called to rescue an arborist working by himself or with just a ground crew with no other climber or it may be to a recreational or research tree climber or even a hunter any of whom can be injured or become trapped or suspended. A civilian paraglider or parachutist may also require a rescue team but military parachutists have their own self-rescue procedures and would not usually require a civilian rope rescue team).

Rescuers will be familiar with any arb SRT system even if the hardware is unfamiliar. What you really need to learn about and become proficient in is DdRT/MRS equipment and techniques. The images above by arb legend Jeff Jepson are from **ARBCLIMBER** issue one and show the



traditional 'hip-thrust' ascending method using DdRT where the rope passes over a limb (or friction saver if you want to make progress much easier) and back to the arborist's harness. The other side is connected into via a hitch, in this case the climber is using a short section of tail to create the hitch (called Split Tail) but these days it is more normal to use a separate hitch climber system. This is a technique worth practicing and many accomplished rope rescuers find it difficult at first.

The hitch climber setup (right) is basically a pulley and a prusik attached to the main rope. The pulley of choice for the arborist usually has additional attachment points for carabiners such as this *DMM Eccentric* pulley which makes for better management of carabiners while the pulley eases directional pull-through of the rope. The 'prusik' is more usually a Vadotain Tresse or VT hitch. Most rope rescuers use a bound loop prusik and 3 wraps but because arborists manoeuvre both up and down the rope, the VT is preferred. Most are in manufactured lengths with pre-sewn or spliced eyes in each end. Arborists will have their own favourite from the Schwabisch and Distel Prusik to Blake's hitch. While the VT may not be familiar to many rescuers, it is in use as a lightweight system with some Wilderness/Canyon Rescue teams. so it's not just being used in tree climbing skills.

Once proficient in DdRT and the use of the Hitch Climber systems you can progress to hardware systems like the *Rock Exotica Akimbo* above right and the *RopeRunner* and *Petzl ZigZag* shown opposite. The *Petzl Zigzag* is basically a mechanical version of the climber's hitch with the tail of the rope usually clipped into one of the eyes on the left of the device. In the case of the *ZigZag*, the image shows its *Chicane* adjunct which



diverts enough load to be able to use it on single ropes. This is *Petzl's* version of the original load-diversion concept embodied by the *Rope Wrench* shown opposite in red with a hitch climber system on a single rope.



Rescuers are unlikely to perform rescue using dedicated arborist equipment and techniques unless intimately familiar with them and most have enough on their plate already but, as stated earlier, familiarisation with the systems being used might be invaluable.

One aspect that is interesting to note is that, despite the recent trend towards SRT /SRS arborist ropes are invariably thicker and softer, than kernmantle rescue ropes because they use fewer strands in the sheath - usually 16 and are often 24 strand Double braid which is a braided sheath over a braided core. 1/2" is still a standard diameter for many arborists but for the more technical hardware, more kernmantle-like ropes from 11.5 to 11.9 are used. Arborists prefer these softer, slightly more dynamic ropes for better handling but while some are now using Technora and similar tough aramid materials in hitch cord and sometimes ropes to mitigate accidental cutting, the majority are not as tough and abrasion resistant





www.rescuemagazine.com



as a rescue kernmantle. The *Cousin-Trestec Atrax* (left) shows another common arborist preference that could trip up rescuers - the spliced or stitched termination. In the case of this *Atrax* the eye is a low profile splice designed to pass through even a *ZigZag* eye but many are quite bulky splices or sewn eyes so bear that in mind if you are trying to pull a rope through some hardware or a fork.

Arborists routinely use foot ascenders and knee ascenders on semi-flexible tethers. Cavers will be familiar with rope walking systems but it is arborists that seem to have

Knowledge is light in the rucksack and not easily left at home

Ropes That RESCUE<sup>estd</sup>

# COMPREHENSIVE BOTTOM-UP TREE RESCUE workshops for Rescue Personnel



This rescue class is for fire and emergency services, not for arborists although many firefighters are also arborists. We employ techniques, rope and equipment that would be found on a special operations rescue truck in addition to regular tree access techniques and equipment.

next 1 Week Course=  
Nevada City, California  
Tues 14th to Mon 20th November 2023  
Cost \$1650

[www.ropesthathatrescue.com](http://www.ropesthathatrescue.com)

cornered the demand. So much so that the unusual, twin cammed Harken Ninja (above) with smooth ribs instead of teeth, was marketed more towards arborists that in was to access & rescue although it was highlighted in **TECHNICAL RESCUE** magazine at the time of launch.

Another technique is what some refer to as 'alternating lanyards' which is basically throwing the main climbing rope over a branch, ascending that rope, and then transferring your weight to a 'pole strap' or 'lanyard' which is also attached to the tree.

The original rope is then removed and thrown to a higher branch, and the climber continues to alternate from rope to rope (or lanyard to lanyard) which are commercially available in various longer length but usually 5m/16ft or so. The *Teufelberger HipSTAR Flex* below incorporates a smaller version of the

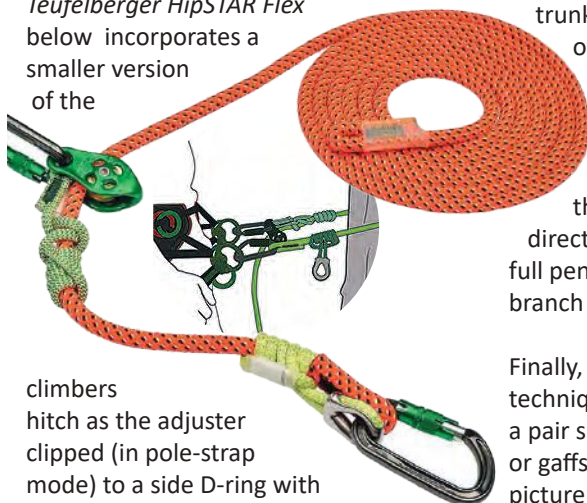

climbers hitch as the adjuster clipped (in pole-strap mode) to a side D-ring with the terminal carabiner clipped to the other Side D-ring. Alternatively, the thimble-eye prusik can be adjusted away from the termination to allow the rope end to pass around a limb and clip back in as a choke while the hitch climber allows continual adjustment along the single length of rope. These items allow the climber to access different locations



\*Pick-Off rescue courtesy of Rope-that-Rescue

of the tree more safely including 'limb walking' where two or even three rope lengths are used simultaneously or in sequence to allow progression and balance along a branch away from the trunk. A paraglider or parachutist will often be suspended well away from the central trunk and necessitate a precarious approach. The limb walking technique mitigates the full weight of the rescuer on the branch as well as providing directional stability and preventing a full pendulum in case of a slip or if the branch should snap..

Finally, another arb (and utilities) specific technique is Climbing a tree or pole with a pair spikes (also referred to as spurs or gaffs) and this is how most people picture an arborist. In the image above you can see that rescuer and rescuee are wearing spikes/spurs which can be so sharp if well maintained, as to be hazardous in a rescue and you might consider unstrapping those from your and carefully dropping them before packaging and descending. Using the spikes with a pole strap is incredibly useful if not essential for accessing a

tree with few branches or a utility pole though these can nearly always be accessed via Hydraulic platform or ladder. This is again a technique worth learning and perfecting. While arborists will not use spikes on a tree unless it is being dismantled (removed) because of the damage they can inflict on live growth, rescuers may not have that choice. Using spikes removes the problem of trying to throw a rope over a high branch. At the same time, climbing with spikes could be used as only one part of a rescue operation. One technician could be climbing with spikes, whilst other members of the team are trying to throw a rope over a high branch. If the rope is secured over a high branch by the other members of

the team, the climber could then attach to the rope and use multiple arborist skills to continue their access of the high branch.

Many mountain rescue teams have experience with crampons for moving on ice. They may also have experience of rescuing patients who are wearing crampons. Likewise in the tree climbing world, tree climbing spikes have sharp components that the rescue team would need to be aware of especially in the hope of avoiding any penetrating injuries during a rescue.

All of these arborist techniques are useful for the rope rescue technician to learn in order to broaden their access options and may prove vital in being able to perform a ground-up tree rescue.

Once a viable top anchor has been established - perhaps by using arborist-specific techniques and equipment the rescue team can revert to more familiar procedures and equipment to package and evacuate the casualty to ground.



Introducing

# 11mm Pro-G

Strong - Supple - Predictable

BlueWater's 11mm NFPA-G rated low elongation line features:

- < 48 carrier sheath
- < Designed to run well in all devices
- < Whopping 9,447 lbf. published tensile strength
- < Polyester sheath with Nylon core
- < Available in 2 highly visible contrasting colors

Diameter:	11mm
Tensile Strength:	9,447 lbf. (42 kN)
Grams Per Meter:	93

Elongation	@ 300 lbf. = 2.6%
	@ 600 lbf. = 4.7%
	@ 1000 lbf. = 6.8%



209 Lovvorn Rd, Carrollton, GA 30117  
Tel: (770) 834-7515 > (800) 533-7673  
[www.BlueWaterRopes.com](http://www.BlueWaterRopes.com)  
email: [Info@BlueWaterRopes.com](mailto:Info@BlueWaterRopes.com)

On August 8, 2023, Pacific hurricane winds intensified fire behavior in a series of wildfires that occurred on the island of Maui in Hawai'i. The wind-driven wildfires destroyed more than 2,200 structures and damaged an additional 1,791. There is over \$5.5 billion in destruction to the quaint historic Lāhainā Town, which was the original capital of the Hawaiian Kingdom. More than 100 lives were lost, making this the deadliest fire in U.S. history and the worst natural disaster in Hawai'i's history.

More than 15,000 people were affected on August 8, 2023, through evacuation, loss of power, water and communication. Together, FEMA and the Red Cross provided shelter for nearly 8,000 individual. At ten months after the fires, more than 3,000 individuals still remained in those shelters due to housing shortages on the island of Maui in Hawai'i.

The non-profit, GEM, Global Empowerment Mission recently published data that 2023 was the worst year in recorded history around the world for natural and man-made disasters. First responders can never unsee the things witnessed. The scars left by these disasters extend beyond the physical damage; they mark the hearts and minds of those who serve and survive.

With wildfires on the rise;  
Where do we go from here?  
How do we continue to support others without facing burnout?  
Are we learning from incidents and sharing best practices effectively?  
What about prevention?

Join the Hawai'i SAR CON Virtual Event where you can explore lessons learned from the Maui wildfires, discover trauma relief tools, and collaborate on innovative strategies for future disaster preparedness and resilience. Together, we can forge a path forward that not only addresses immediate needs but also builds a foundation for a more resilient future.

**PURCHASE  
TICKETS HERE**



**PARTNERSHIP  
OPPORTUNITIES**



**MAUI WILDFIRES  
LESSONS LEARNED**

---

**TRAUMA RECOVERY TOOLS**

---

**UNSUNG  
HERO  
AWARDS**

**HAWAII SAR  
CON  
AUGUST 1-2**

**VIRTUAL  
EVENT**

**WWW.HAWAII SARCON.COM**

**SPONSORSHIP INFO  
PARTNERSHIPS@HAWAII SARCON.COM**

**PC: Tik Tok@chrissylovitt IG@captain\_chrissy**

# PROLONGED FIELD CARE



## why, who, what, where & when?

### INTRODUCTION

Pre-hospital, first responder, austere, tactical, care under fire, high risk, remote, prolonged care, medic, clinician, practitioner, expert; the list goes on for the amount of names and phrases used to describe people, roles and courses working in a non-hospital environment. Some of them (in my opinion and I do have a few!) are used to make someone or a course sound more than it is. Some though, do exactly as it says on the tin.

I've been involved in pre-hospital care for the best part of three decades, predominately in the NHS but also have what I would deem a "reasonable background" of working in challenging environments around the world, including in an overseas medical response capacity. I have met a lot of people, done a lot of courses, got my hands dirty and treated who knows how many people in my time. I'd like to say I'm experienced but by no means an expert and I'm a firm believer in "every day is a school day".

I like to do courses that can challenge my thinking, push my comfort zone and are "a bit different". For a while I've been thinking about a Prolonged Field Care/Prolonged Casualty Care or remote area medical course. So, for the past twelve months or so I've been looking at various companies and reading reviews on the multitude of courses out there... there are a lot! However, after having previously experienced the quality of teaching with a company in North Wales on a Prehospital Trauma Life Support course with emphasis on remote areas and then on a specialist remote area operations risk management course, it was a no brainer to go and try out their "Prolonged Field Care" two-day course. As the name implies, the course centres on what to do if help isn't arriving any time soon.

### SATURDAY

So, it was in the early hours of a damp Saturday morning in September that I set off to the training centre of Remote Area Risk International (R2Ri) in Snowdonia. Their training facility is at the National Outdoor Centre and they are the pre hospital care and risk management partner to Plas y Brenin. Sitting down in the welcoming environment with a brew and biscuit, the other attendees consisted of doctors, paramedics, members of a disaster response team who deploy both in the UK and overseas, Mountain Rescue, expedition medic and remote area safety specialist; a whole wealth of experience, knowledge and

### by Simon Greenfield

Simon served 28 years as an NHS paramedic and as a HART Paramedic and is now an advanced paramedic on the Clinical Support Desk for West Midlands Ambulance Service. Simon also has extensive experience working in austere environments as part of disaster response/humanitarian crisis agencies in areas like Sierra Leone, Syria and Nepal.



ideas all there for the same reason; to learn what to do beyond the scope of 'traditional' remote area medical courses, given the context of where they work.

One of the things I look for when deciding on a course is who will be teaching and their credibility and experience. R2Ri do not disappoint in this area. The course lead being a doctor, expedition leader, published author and contributor to the new 3rd edition Oxford Expedition and Wilderness Medical Handbook, having worked in some of the most remote areas on earth; Mount Everest, Arctic Circle and Antarctica (as a British Antarctic Survey Doctor), to name but a few. The other two Faculty members being experienced paramedics within the military (including background as a medical element of one of the most elite units in the UK), NHS and civilian expedition sectors. Importantly, the Faculty had real world experience of Prolonged Field Care, including in both civilian context and hostile settings overseas in a military context.

R2Ri have been running the course for years, to military, expedition, disaster response and outdoor sector teams.

R2Ri also had an academic researcher from one of their partner Universities attending the course as a delegate, in advance of a series of research studies related to Prolonged Field Care (we weren't told what). During the course, a second researcher attended, from a globally renowned University. This second academic undertook the world first PhD study into Prolonged Field Care and R2Ri was apparently one of the key parties supporting that PhD, data wise. All excellent credentials for what would be an excellent course.

Day one was predominantly classroom-based discussions and lectures until the evening. The one thing that became apparently clear is that PFC considerations go well beyond actual immediate medical care. The rest is made up of



equipment considerations, nursing protocols and techniques, check cards covering key mnemonics and algorithms, non-technical roles and skills, communications, team logistic considerations, evacuation plans; the list goes on. All relevant, all thought provoking, all important cogs in an ever-turning wheel of which most probably go unconsidered in an untrained or inexperienced eye.

On most pre-hospital courses you will run through a patient scenario, assess, treat and package all within probably no more than half an hour and the exercise ends when the big yellow van or notional rescue helicopter turns up and whisks the patient away, at which time we all high five each other and go home for tea and medals. However, PFC doesn't stop there. In PFC this is only the beginning. Discussions, lectures and equipment reviews revolving around nursing and general healthcare of the patient took place; toileting, feeding, dental hygiene, environmental protection, to name a few of the subject areas. It's all very well treating that patient who has fallen and sustained a head injury and ankle fracture;

the treating bit is relatively easy. But what about when the patient is six hours or more away from definitive care or further help? What do we do when they need to pee? What do we need to do if they are thirsty or hungry or have soiled themselves? What if the tourniquet is causing more pain than we can deal with? Lots of important things that we don't necessarily think about on a day-to-day basis when dealing with a patient. And this patient doesn't have to be up a mountain in the Cairngorms, in the middle of a jungle or an African desert. With the way things are in the UK with ambulance response times, this could be a teenager with a broken leg on a rugby pitch or an elderly patient who has been on the floor all night with a broken hip.



Equipment was a key discussion part; the minimum kit, the should have, must have, nice to have. The "oooooh nice and shiny" and the "wow that's clever". The specifics and the improvised. Medications. The stretchers. The big and small. What the book says and reality... but you do need duct tape. Always duct tape. And scissors! Importantly, the training and kit choices also had to work across a range of skill levels and qualifications.

When you have this type and level of experience under one roof from both sides of the desk, I always find it useful to hear of the "what went wrong"; equipment freezing up and failing to work because of sudden temperature changes. Using certain types of fluid giving sets as some become "sticky" in warmer climates. Different duct tape in different climates as the glue can be less effective. If taking chocolate to a cold environment then you are best to take ones with "air bubbles" in them rather than solid chocolate as these warm up quicker and are less likely to cause dental problems when biting into a piece that's frozen. You learn something new every day!

After a casual lunch and more tea, the early afternoon carried on with discussions about casualty evacuations, team welfare and communication before being split up into two teams, ready for the night-time exercise. One of the factors for me in deciding on a course provider is looking at the course title, the content, course structure and if these parts all tie in together. One of the main selling points for me was the fact that a real

time PFC exercise would take place throughout the night; this wasn't a course that just discussed PFC, it did it as well. A very long night (more than 12 hours) was ahead of us.

The teams were split equally with doctors, paramedics and non-HCP's. The course is designed to benefit all skill levels and so the make-up of the delegates reflected a broad church,

with everyone operating to their skills level. Time was allocated to decide on what casualty care equipment would be taken and splitting the carrying of this kit between the team; all our own personal equipment, tents, cookers, sleeping kit, food and water had to be carried in expedition backpacks for the duration of the exercise. Once the logistics were covered; there was a couple of hours spare in which to eat, rest and relax before being let out into the wild.

## THE EXERCISE

The two teams "Broadsword" and "Danny Boy" (you had to be there or over a certain age!) were given a simple map to follow from the base, up into the mountains. The exercise simulated a civilian expedition in a remote area, overseas. The instructions were simple; "here's a map of your expedition route, follow it!"



www.rescuemagazines.com



evacuated safely. By now it was dawn, light enough to see but still raining. Working together as a team the camp was taken down while casualty care was being continued. A route out was decided and reconnoitred.

The casualty was safely evacuated under the watchful eyes of the faculty to a point of “end ex”, a Helicopter Landing Zone. Tired, cold and wet but feeling accomplished, the exercise took just over 12 hours to complete.

## SUNDAY MORNING

After some downtime to allow for getting showered, fed and watered a constructive and interactive debrief took place. For

From the nature of the course, whilst we weren't told, we were expecting a casualty or casualties somewhere along the way and as we set off it was starting to get dark, the weather was clear, but the forecast was “light showers”.

After approximately half an hour, the “light showers” started. For anyone who has been to Wales and experienced light showers you'll know what I mean when I say that this is a slight understatement. After about another thirty minutes, each team came across a casualty with multiple injuries and started to work independently. The great thing about this course and the environment we were in, was that everything was fluid and had to take into account the environment and conditions, including looking after ongoing personal admin needs. By this time, it was raining heavily and dark. Two people were tasked with casualty assessment and treatment, one took the role of team leader while the others carried out communications and discussed evacuation plans. It soon became apparent that no help was coming and that after a team chat it was decided to make camp until help arrived..... or would it?

Fast forward to early Sunday morning (I don't want to give it all away) and a camp had been set up for all team members including a casualty care area. A rota had been set up providing fulltime care for the patient with two casualty carers at any one time. With injects from a faculty member, real time care and treatment was carried out for several hours at a time, including reassessment, feeding and hydration, toileting and personal care of the casualty while also taking into account the welfare and safety of all the team members and plans for evacuation.

Communication came through that we were to move the patient to a new position, for a realistic reason within the scenario, following which would then allow the patient to be

me, this was one of the most worthwhile parts of the course with valid and worthwhile learning and take-home points. New things to consider, next time think about this, what if?; all useful thoughts and take-home points.

I went away on the Sunday afternoon with a quiet warmth in me; I don't know what I was expecting from the course if I am honest, but I felt as though I had learnt new things, refreshed on some areas, and have been encouraged to spend time researching some of the areas that were new or rusty to me.

## CONCLUSION

Prolonged Field Care (PFC) is as it says. It's about the prolonged care of a patient in a non-hospital environment (and not just in a field!). However there seems to be a lot of emphasis these days on everything being “tactical” or “hostile”. The R2Ri course is civilian context (although the training has successfully been used in hostile environments by Faculty members). While there is no doubt a need and place for these phrases and courses, PFC is not just about the medical care, it's all the other stuff that goes into it as well.

In the near on three decades I've been a paramedic, I have undertaken countless courses and exercises but I have never spent a solid 12 hours dealing with the care and evacuation of a casualty. When I think about it, it seems madness that PFC is not seen as a standard part of training for UK pre-hospital clinicians, specialist rescue teams, HART and similar. You can checkout Remote Area International at

[www.r2international.com](http://www.r2international.com)



## BABY RESCUE BAG

Designed for rescue transportation of the children with a height 40-110 cm, max. weight 25 kg



Size: 80x45x35 cm  
Weight: 3300 g

[www.singingrock.com](http://www.singingrock.com)



# RESCUE | MEDICAL | MOULAGE



Emergency Response Bag  
Product code: DS01952

T: 01329 311451 E: [info@dsmedical.co.uk](mailto:info@dsmedical.co.uk) [www.dsmedical.co.uk](http://www.dsmedical.co.uk)



# TIPS for incident management of SAR operations

by **Dr. Steve Glassey PhD**



Dr Steve Glassey has been teaching swiftwater rescue for twenty years and is a registered assessor for the International Public Safety Qualifications Authority (IPSQA) for swiftwater rescue, a WorkSafe New Zealand Occupational Diver and is a PADI Public Safety Diver™.

About 15 years ago when I was instructing an incident command course at RNZAF Base Ohakea when I found that students sometimes become overwhelmed with all the information and injects coming in during the tabletop exercises. The air force participants were not alone; in fact, highly complex novel scenarios often overwhelmed even experienced public safety leaders both operationally and in training that I have observed over the years. My mantra is to always set up participants in exercises to succeed, even if just marginally. Exercises should be used to build confidence, and you want these people to feel they have the ability to take on whatever challenges they may face. No one wants to have “that” pilot who has an emergency but failed that exact scenario 9 out of the 10 times they rehearsed it in a simulator, right?

This sense of feeling overwhelmed is likely not because of incompetence, but more so the reality of being human. We are wired to be mono-taskers, with only 2.5% of us actually able to multitask effectively. The University of Oregon has concluded that the human brain has a built-in limit on the number of discrete thoughts it can entertain at one time. The limit for most individuals is four (Awh & Vogel, 2008). Once this limit is exceeded, the efficiency and quality of our mental efforts start to deteriorate. And in complex emergencies, we surely have more than four things to worry about.

I tried out a modified mind mapping method and aligned it to incident action planning to create a visually collaborative process known as TIPS, the Targeted Incident Management System. Targeted because it looks like a bullseye or target map, starting off with a small number of factors identified for a situation that then extrapolates out with compounding information until tasks are assigned and tracked. The incident management team, with the leader taking charge of the pen usually on a whiteboard or large sheet of paper, focuses the conversation on getting a common understanding of the situation. From there, the group identifies the factors affecting the situation, which are really all the things that they

are worried about. Then we assign a priority to each factor. The priority is subjective and contextual, using a simple low, medium, and high rating. The only rule in this phase is that everything cannot be a high priority. Then the group discusses what the options are to treat the factor, such as evacuate or shelter-in-place. The best option(s) are then chosen to extrapolate with tasks to enable that option's execution. Those tasks are then assigned to a member of the incident management team. Those team members now have a set of tasks, with an assigned priority to work on. The leader may have tasks but can now monitor progress of their direct reports who can naturally delegate their tasks accordingly. Using a whiteboard creates shared situational awareness of the incident and how their tasks relate to others and the overall priorities. At the end of the process, a structured briefing can be given and even transposed onto formal incident command planning forms.

In the example opposite, based on a real event, occupants of a house are stranded in a flood with waters rising in darkness and stormy weather. The green shaded sections indicate when the person responsible has completed the task so the leader can easily track progress.

Recently, I had the opportunity to show this tool to emergency managers in the United Arab Emirates, and given Arabic text reads right to left, the tool also being so visual was very well received (in fact, it was the best tool they took away from the multi-day course they said). It allows for different languages, and when given an impromptu exercise on a Tsunami warning, the groups came up with a detailed incident action plan within minutes. The other benefit is that it can be used Business-As-Usual for any planning, from events to project management, and in doing so ensures participants are constantly refreshing in its use and no longer trying to remember a planning tool they learned on a course months or years ago.

What I have found interesting is giving people highly novel scenarios, as where familiar scenarios are given, people default





# POWER ASCENDERS – FOR PROFESSIONALS.

ActSafe Power Ascenders are an ingenious combination of a high-capacity rope winch in a compact, lightweight and user-friendly design. They simply redefine the possibilities for working in vertical environments.

[skylotec.com](http://skylotec.com)



## ActSafe ACX

- simplifies and accelerates work on complex or difficult to access structures
- power-saving use
- remote control up to 150m





## ActSafe RCX

- for effortless and efficient rescue operations
- 0-24m/minute at 250kg, IP 67 standard
- variable rope grab system



# PETZL FALCON

by Roland Curll & Ade Scott



Falcon, Falcon, Falcon.....When it comes to lighter technical rescue harnesses, the *Petzl FALCON* has been at the forefront for a while now. It was originally introduced as a lighter alternative to the highly successful *NAVAJO* series of technical rescue harnesses from their launch in the 1990s right up to present day in the form of the *AVAO* (pic. below left). The *FALCON* was introduced as a hybrid between a wide-belted, hardware adorned technical rescue harness and a slimmed down climbing harness - something that the mountain and wilderness rescue teams would appreciate.

*Petzl* re-launched the *FALCON* in 2023 with 3 versions:

**FALCON** - Tech Rescue

**FALCON MOUNTAIN** - Climbing/Tactical

**FALCON ASCENT** - Ascending/Cave/Mine

Each of these models has unique features that make them suitable for different environments and different scenarios but all three tend towards a 'sportier' version of their rescue/ industrial counterparts. The *ASCENT* has a caving harness style central tie-in and similar bulk to the *FALCON 'Tech'* while the *MOUNTAIN* has a thinner web belt and climbing style belay loop.

The new *FALCON* is the closest of the designs to the *NAVAJO/AVAO* and is a rescue harness designed for technical mountaineering and rescue operations although *Petzl* do have a range of accessories that can turn even their lightest offering

into a full-metal monster - more on that shortly. The *FALCON* really should have been called the *FALCON 'Tech'* or something similar to properly distinguish which one we're talking about. In fact, that's how we'll refer to it in this article. The *'Tech'* occupies the middle ground for mountain/wilderness teams that are involved in technical rescue, or for rope rescue teams that respond in both industrial and wilderness areas. There are plenty of wilderness teams with remote industrial facilities and/or major roads and bridges on their patch but don't want the bulk or cost of different harnesses for different tasking.

Both the *FALCON 'Tech'* and the *ASCENT* are, in effect, what we used to call SRT harnesses where auto-lock descenders and ascenders can be used without rotating the device 90 degrees as is the case with a belay-loop harness. In this case, the central D-ring is large enough to accommodate other connections or the *ASCENT* can have a semi-circular *Maillon* as its central hard point. It weighs 915g (size 1) compared to the 1175g of a size 1 *AVAO* but retains the hard ventral connection point which helps distribute the weight between the waistbelt and leg loops for suspended operations. All three versions have upgraded the padding on the earlier *FALCON* to thermo-form, 3-D foam padding. We see this on many, if not most harnesses these days because it provides comfort in strategic areas and the 'creases'



**AVAO**



**FALCON  
'Tech'**



**FALCON 'Tech'**



# PETZI FALCON HARNESES

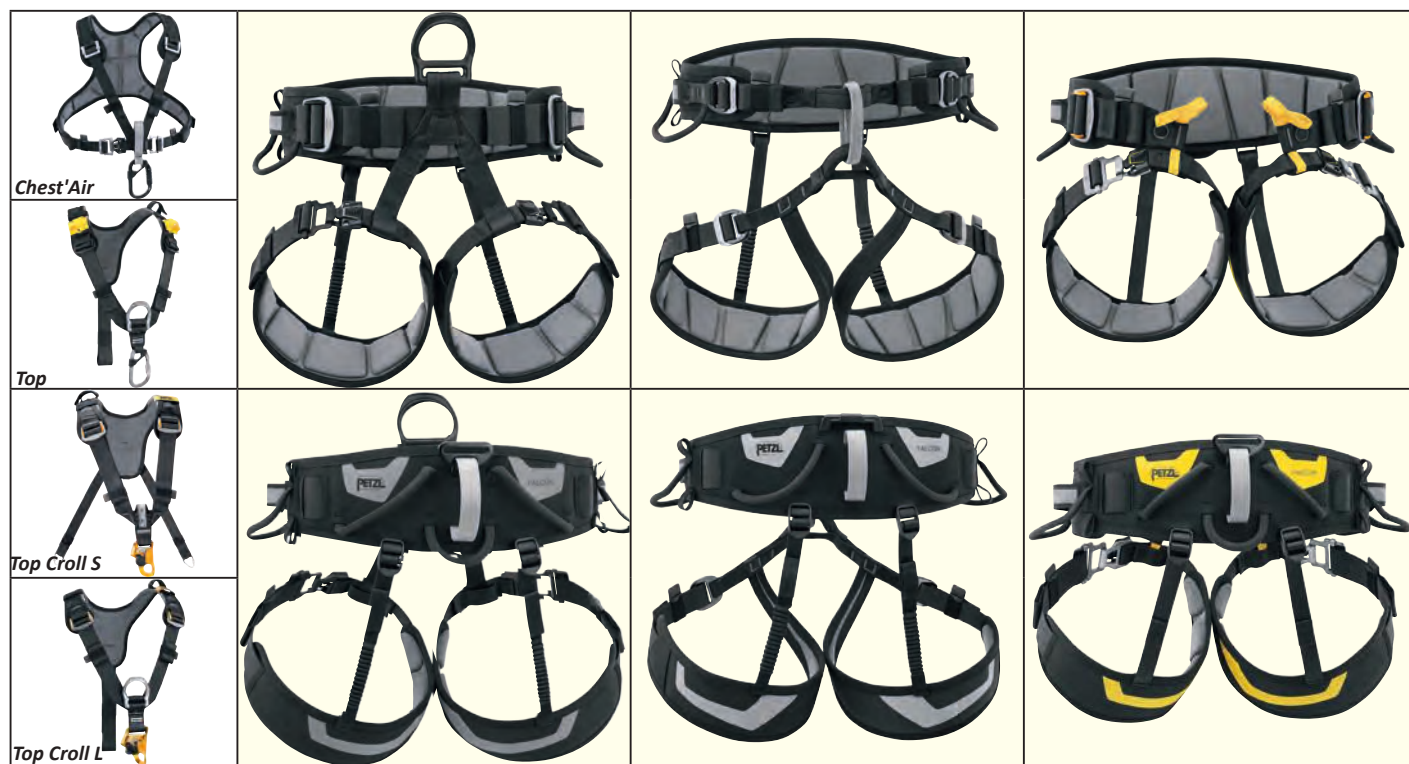

MODEL	FALCON 'Tech'	FALCON MOUNTAIN	FALCON ASCENT
Fits Chest Harness...	Top, Top Croll S & L, Chest'Air	Top, Top Croll S & L, Chest'Air	Top Croll S & L
PROD CODE	C038DA	C038FA	C038EA
<b>COST</b> (inc VAT/Tax)	£175 \$240 €180	£150 \$200 €155	£198 \$250 €195
<b>WEIGHT</b>	900g /915g /945g	670g/700g	800g/830g
<b>Waist SIZES</b>	0= 65- 80cm (black only) 1=70-93cm 2= 83-120cm	1=70-93cm 2= 83-120cm	1=70-93cm 2= 83-120cm
<b>Waist BUCKLE</b>	Fixed, Double back Lg	Fixed, Double back Sml	Fixed, Double back Lg
<b>Leg SIZES</b>	0 = 44-59cm (Black only) 1= 47-62cm 2= 50-65cm	1= 47-62cm 2= 50-65cm	1= 47-62cm 2= 50-65cm
<b>Leg BUCKLES</b>	Fast Clip (opens)	Fixed, Double back Sml	Fast Clip (opens)
<b>STANDARDS</b>	CE EN 813, CE EN 358, UKCA, EAC, ASTM F1772	CE EN 813, CE EN 358, CE EN 12277 type C, UKCA, EAC, ASTM F1772	CE EN 813, CE EN 358, UKCA, EAC, ASTM F1772
<b>NOTES</b>	Rear Belay. 5 Gear loops 2 Caritool & 2 gear bag Loops Textile side-D loops	Rear Belay. 4 Gear loops 2 Caritool & 2 gear bag Loops Textile side-D loops	Rear Belay. 5 Gear loops 2 Caritool & 2 gear bag Loops Textile side-D loops

allow the waist and leg loops to bend where they should without bunching up the padding. Because they are stripped down harnesses, none of the three *FALCONS* has the mesh lining that we see on the *AVAO* to facilitate better air flow and less sweating but they do all have a rear belay or attachment loop which is something we have always been keen on as a feature on a rescue harness. A rear belay is particularly useful for attaching an edge safety line unhindered by the tendency to try and rotate you when attached at the front or side. Properly adjusted, this makes assisting with stretcher edge negotiation

easier and less cluttered. Also common to all three models are chest harness attachment points and a similar combination of heavy-cord gear loops which hold their shape really well because this is a formula that *Petzi* perfected decades ago and have stuck with it.

None have side-D rings, that'd be too heavy, but they do have a double thickness sewn loop on each side - it's the grey panel you see on each side of the waist belts in the images in the table above, but is clearer in the plan-view opposite. *Petzi*

# GEAR REVIEW

www.rescuemagazines.com

describe this as a 'textile lateral attachment point'. If you want the convenience of forward facing side-Ds, *Petzl* has you covered with their *RING2SIDE* accessory (pic right) this sits inside that reinforced webbing loop and the openable ring, (opened with an Allen key), locks the little assembly into the loop allowing simpler attachment of lanyards and hardware. That will set you back an extra £\$€25.

While we're on nifty extras, if that climbing belay loop on the *MOUNTAIN* doesn't suit you there is the *Ring2Ring* which again uses the openable ring concept but this time provides a 90 degree rotated eye alongside the regular belay loop which orientates most hardware into a more user-friendly position. The openable ring originated in the arb industry as a variation on their sliding ring attachments on a rope bridge (rope or webbing that spans from side to side on an arb harness) and is finding more and more uses throughout the rope-access and rescue fields.

The waistbelt on all three models is a self locking *DoubleBack Plus* buckle in various size configurations. A waist buckle on each side allows you to grasp the stitch-ended webbing, do the hip wiggle and tighten up (green arrow) with the central connection remaining more or less in the centre. To loosen, you simply pull the buckle frame forward (yellow arrow) and wiggle those hips. The *FALCON 'Tech'* and *ASCENT* have *FAST LT* leg buckles that can unclip for easy donning and doffing (pic right) while the *MOUNTAIN* uses a more traditional fixed adjustable buckle.

The *Petzl TOP CROLL* chest harness can be added to make it a full body harness, but it is not ANSI rated. The *FALCON 'Tech'* comes in 3 sizes – size 0, size 1, and size 2 where the smallest size 0 is only available in the tactical (black) model and is not a size option for the other two harness models.

The *FALCON MOUNTAIN* harness is a lightweight and compact version of the *Falcon* designed more for mountain rescue and ski patrol. It only weighs 670g (size 1) so this new version is 18% lighter and more compact than before. The ventral attachment is a textile belay loop, with a small textile bridge for more range of motion in use (but not as much as an arborist harness) and more comfort when walking in it. The lightweight and compact size and less hardware means it is more heli-friendly and easy to stow in backpacks for long approaches in the mountains and wilderness areas. This harness has a semi rigid waistbelt and leg loops which have 3D foam padding, comfortable yet still with reduced bulk.



There is a new version of the *Petzl CHEST AIR* chest harness that works well with the *FALCON MOUNTAIN*, but it is also compatible with all three versions of the *FALCON*.

The *FALCON ASCENT* is designed for caving and big ascents using ascender configurations. It weighs 800g (size 1) and has a caving style front that helps position the chest ascender low. This harness features improved attachment points, waist adjustment buckles and moulded 3D padding for increased comfort. Like the *FALCON 'Tech'*, the *FALCON ASCENT* has self locking *DoubleBack Plus* buckles for the waistbelt, and *Fast LT* buckles for the leg loops. The openable leg loops also make it easy to putting on and taking off, even when wearing massive boots.

All the *FALCON* harnesses have optimal gear and tool organisation as they are equipped with semi-rigid gear loops on the sides and lower profile loops on the rear of the harness. Each harness also has 4 sewn eyes to install *Petzl CARITools* and the *Petzl TOOLBAGS*, allowing for very organised storage of gear. They all have a waistbelt that is slim enough so that it does not dig into the ribs of the wearer when bending and manoeuvring.

You could say there is a fourth new version of the *FALCON*, the tactical version, but it is simply the *'Tech'* or *MOUNTAIN* versions with black and grey colours, instead of black and yellow. In fact, if the *MOUNTAIN* had a mesh and removable rather than fixed padding it could almost be the *Petzl ASPIC* which is their military harness

The 2023 *Petzl FALCON* range is a versatile and comfortable solution for technical mountaineering and rescue operations. With three versions to choose from, climbers and rescuers can select the harness that fits their needs and the environment they will be working in. All versions of the *FALCON* come with a range of features that make them comfortable to wear, easy to adjust, and efficient for gear and tool organisation. They have become something of a modular system with the chest and hardware adaptor options making them particularly versatile. They are tagged as 'lightweight' but the majority of rescuers in ANY environment from industrial to wilderness and con-space to tactical will get on well with the *FALCONS*. We had team members using the original *FALCON* concurrent with the bulkier *NAVAJO* and nobody ever complained so these newer, better configured and more comfortable versions are some of the best all-rounders on the market. Nice one *Petzl*, making sure that the *Falcon* remains as iconic a name in rescue harnesses as the *Navajo* was and the *Avao* would be if it was a catchier name!

**NEW in 2024**

www.rescuemagazines.com

# BUYERSGUIDES

**The most comprehensive GUIDES to safety and access equipment ever produced**

**FREE-to-ALL BUYERSGUIDES** to make better use of all the MARKET GUIDE articles we have in all of our magazines. Digital, page-turning publications that can be downloaded as a PDF but are **continually updated on the same link** so that readers can get the latest version whenever you want to take a look for something. These will be sent to all readers and available from our website.

- **CONTINUALLY UPDATING** prices, specifications and new or discontinued products updated weekly with new Product guides being added regularly.
- **NEW PRODUCTS** will be incorporated into the tables and introductions as they are released
- **PRICES** monitored and updated monthly and currency conversions listed in GBPE, US\$ & Euro€

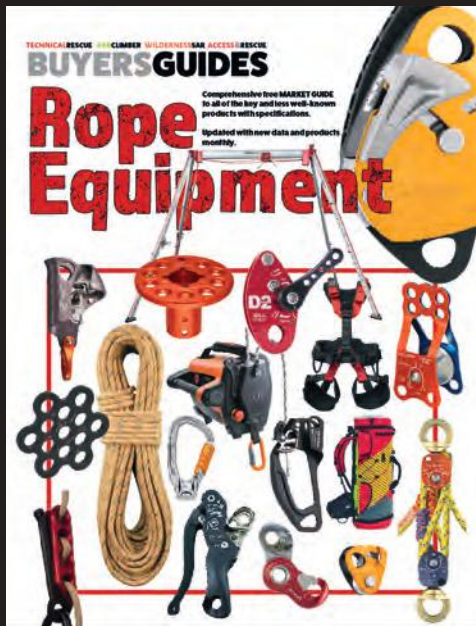

- **DISCONTINUED MODELS** will have a note to that effect before being removed altogether
- **SAFETY NOTICES & RECALLS** shown
- **300+ PAGES** in each GUIDE

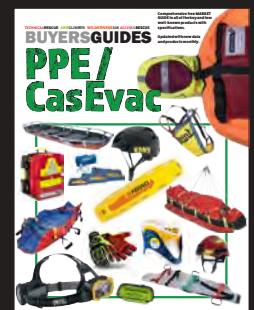
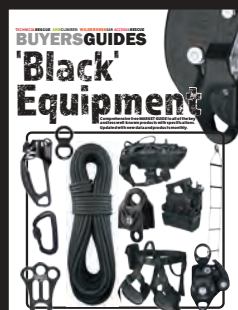
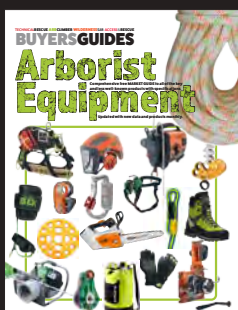

# SUB-SEA ROVS

Choosing and operating hand-portable underwater drones



VideoRay's Pro3 (now in it's Pro4 & 5 versions) in use with St. Louis County Sheriff's Rescue Squad in Minnesota's sector of the Great Lakes

**W**e should first define the acronym that we're using here - ROV or Remote Operated Vehicle - further defined by the term SubSea because an ROV could just as easily be your kids toy car. There are other terms - UUV is Underwater Unmanned Vehicle and AUV is an Autonomous Underwater Vehicle which is not directly controlled by an operator but rather preprogrammed to carry out a specific task via a specified route and mode - these don't use a tether and are not usually utilised by rescue teams. As far as ROVs are concerned, there is a fine line between a mini or hand-portable underwater Remote Operated Vehicle that rescue agencies would or could use and the smaller end of the scientific and oilfield ROVs defined as Work-Class ROVS that look like a block of flats with arms. The difference of course is the ability for your average search team to be able to carry and deploy it and their ability to buy it in the first place. All of the models in this guide cost less than a fire truck - some of them cost less than a set of tyres for your Off Road vehicle but those big boxy exploration and maintenance ROVs are 5 and 6 figure sums or they weigh the same as a small elephant at their smallest! Take this *Oceaneering OmniMaxx* on the right - it looks a lot like some of the models in this article if you look at this picture in isolation, but it's 1.3m/50" long and over a quarter of a tonne and don't even bother about asking the cost. They know you can't afford it, rescue/emergency response isn't mentioned once in their blurb. Most of the big ROV manufacturers don't mention rescue or search & recovery in



their list of possible taskings and industries served. They are all about inspection and maintenance of pipelines, subsea comms cables, ships and submarines - you can see where all the money is - oil, gas, shipping and the military... rescue, not so much. So even though ROV's like that

*Omni Maxx* might be the kind of vehicle that a dive team would crave, it is, to all intents and purposes, 'out of your league'. As we said earlier, it's a fine line between the most expensive 'recreational' ROV and the cheapest Search and/or Rescue ROV but cost is often the first consideration. Emergency responders and Government agencies not related to defence are unlikely to have money to burn and for most, an ROV is a luxury. It will be tempting to look at some of the numerous Chinese 'recreational' models costing only a few hundred up to a thousand or two on the basis that any capability is better than nothing? Or is it? Once you rock up to a scene with expectations of a capability in underwater search and maybe light-recovery you effectively have a duty of care to perform that task to a level of professionalism expected of any emergency service. Deploying an ROV that looks like your kids skilfully constructed it using one of those month by month publications that builds into a complete ROV, might leave you with egg on your face. Because, despite the fact that it worked fine in the practice pool, when it came to deployment at an actual incident with time pressing, weather rubbish and the incident commander waiting for you to perform, the video graphics looked sketchy, the tether ran out 20 feet

## MINI SUBSEA ROVs

short of the target and the battery packed up after 7 minutes because the water is pretty chilly. Not buying 'cheap' is a broad concept that you could apply to any technological kit used for rescue but ROVs - whether aerial or subsea - are a relatively new phenomenon with many new companies vying for your attention and most don't have the kind of track record that you might otherwise look for in selecting equipment.

That's certainly true of aerial ROVs but in fact, subsea ROVs do have some specialists from our sector. Regular readers of **TECHNICAL RESCUE** magazine will be familiar with *JW Fishers* who have been featuring for the past 30 years and this century we have seen Canadian company *DeepTrekker* and US company *VideoRay* targeting the rescue, inspection and research sectors. It's fair to say that *Deeptrekker* and *VideoRay* represent perhaps the more technological end of things - reliable, modern, complex subsea robotics with a range of vehicles that include an absolute maze of mission possibilities. Compared to the many Chinese models available (which may or may not be good) *Deeptrekker*, *VideoRay* and *JW Fishers* have skin in the game, a track record in rescue that you can hang your hat on. *JW Fishers* represents the bombproof, more traditional end of robotics. Their *Sea Lion* (pic-top) and slightly more basic *Sea Otter* are perhaps the most robust in this sector with a simple cylinder modified to take the lighting units, thrusters and manipulators common to all ROV's. We often think of them in terms of that great (and probably urban myth) analogy that retells how NASA engineers were proud of their latest innovation after thousands of hours of research and design and hundreds of thousands of dollars - a pen that could write in any orientation, underwater, in zero gravity, in freezing temperatures or extreme heat to which the Soviets replied that they too has such an innovation - they called it a pencil. Whether this is true or not, and we doubt it, the point of the analogy is that simple is often the best option. With ROVs being operated in an alien environment by rescuers who rarely get level of use and experience that deep-sea explorers and maintenance workers get but who may be operating under critical time and environmental constraints, the less to go wrong the better.

### POWER/BATTERIES

All of these ROVs are electrically driven but not all have an independent on-board battery system. Some can only operate via hardwire connection to a top-side power source usually housed in a *Pelican* style hardcase like this *Video-Ray* power-case (right). With transformers, many can use other top-side power sources like vehicle batteries or even mains supplies. Many fuel-driven generators on rescue trucks have AC power sockets which some, like *Video-Ray's Defender*, can use. But for the most part, in rescue we're talking independent battery power. The top-side systems

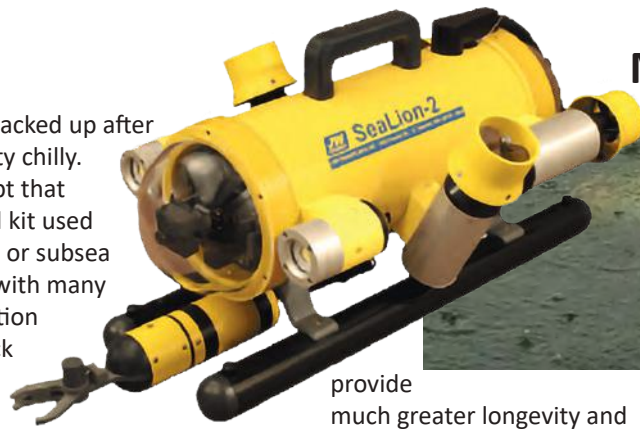

provide much greater longevity and easier power monitoring and management than autonomous on-board batteries and, since a tether is



Pictures above: Top-right to bottom left- *Deeptrekker's Photon*, *Blue Robotics' Blue ROV*, *VideoRay's Pro4* and *Boxfish's ROV+*

usually used for retrieval, control and live feed, it is not a stretch to add a power cable. Nevertheless a tether adds bulk and drag which an on board battery doesn't but work/search durations are radically different - expect 1 to 4 hours with an on-board high end Li-ion or polymer. The *BlueRov2* above quotes 2hours for heavy use up to 6 hours with 'light' use.

A tether may allow up to 8 hours from a top-side powerpack.

### CONTROL OF THRUSTERS

In terms of controlling your ROV this relies on thrusters, basically impellers that can have variable orientation but are more usually fixed. Vector thrusters are paired in opposing directions as you can see in the *Fishers Sea Lion* at the top and the *BlueROV2* above

# WATER RESCUE

with additional vertical thrusters for lift. Variable thrusters can be rotated to give infinite directional control. The way you control might be via a simple thumb toggle or, taking a leaf out of military UAVs, the *Play Station*-style controller is seen by many under 50 year-olds as an easier means to control the ROV. The control systems and imaging options are often pre-mounted into a *Peli*-style hard case with the monitor handily located in the lid and ready for use when you open the case like the *JW.Fisher* system right



for their *Sea lion2*. Lighter weight, out-of-the-box controllers are also available like the *Deeptrekker* system above right used to control its *DTG3* ROV and *Video-Ray's Expeditionary* controller left using a tablet with add-ons from the main control box. Laptop computers are another common interface to provide video and sonar viewing.

## SENSORS

On-board sensors can provide data on temperature, depth, direction/orientation, size of and proximity to objects. Exact location of your ROV has to be achieved via transponders **rather than GPS because satellite-based systems only work in the surface layers of water**. A little easier to work out is orientation of the ROV in terms of whether it is upside down etc. and this is achieved with an on-board gyroscope or gimbal relaying attitude to the system. This is all important information that affects the ability of the ROV to perform and enable the controller to carry out specific tasks. Some ROVs have these sensors as standard, most can be added to a package. At a minimum, rescuers will want the option of temperature because the colder it is, the shorter time your battery will last and a navigation package. Navigation in terms of directing the ROV where to go is usually undertaken with **USBL** tracking which uses the surface boat (if you are using one) as its reference GPS. There are also computer analytics that use DVL or Doppler Velocity Log (speed relative to the seabed) and distance from mother-ship figures to calculate location. Usually, DVL just give you an accurate speed.

## VIDEO, IMAGING & LIGHTING

Getting your Remotely Operated Vehicle to the underwater scene is only one part of the package requirements, in fact, by itself is of no use whatsoever. The ROVs need to be able to do something tangible and this means at least the ability to scan an area with Sonar or IR etc. or film and illuminate a scene and to relay that back in real time to the team on top. There they will view data and control the ROV from a mobile 'command-Post' like the *Fishers* model above. Real-time visuals

include video and higher resolution stills and these generally need to be well illuminated. All ROVs have on-board lighting - arrays of LEDs these days offering differing lighting levels and types of beam from long range spot to short range wide-area flood.

Something that doesn't require lighting is Sonar. Sonar is the most often used asset by rescue agencies and this is a complex field in itself with most ROVs designed to accommodate a specific brand/model of multi-beam rather than scanning or side-scansonar (see our separate GUIDE to SONAR). The image below is via a Kongsberg Flexview sonar which can be retrofitted to many ROVs and in this case has picked out the

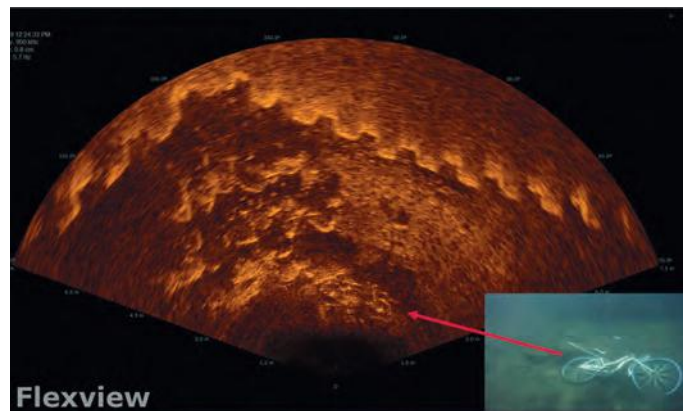

outline of a bicycle but humans can be far less distinct and it takes a skilled operator with lots of experience to discern a bone-fide target from all the other clutter than may be adorning a lake, bay or river bed.

Your ROV may be equipped with a manipulator arm that can either grab and retrieve objects (to a very specified weight) or perform other manipulation and or cutting tasks but the vast majority of dive and surface water rescue teams are using their ROVs as a search tool so it is the video capability and/or acoustic/sonar imaging that are most important. And these are elements that can really rack up the bill on your ROV. Imaging sonar will triple the price of a US\$10K ROV. it's always the add-ons that get you but these add-ons can be crucial. High Definition video aided by high intensity white light LEDs with images relayed by a hard-wire (fibre-optic) tether offer the most reliable way to get the best quality images to the controller on top though there are WiFi telemetry systems that will undoubtedly improve in the coming years. This may not be quite as useful a development as you might think because virtually all ROV deployments would use a tether to the surface anyway in order to deploy, recover or find your ROV should it

# Make Searching Open Waters Safer & Easier with JW Fishers Underwater Equipment

## Hand Held Underwater Metal Detectors



### Pulse 8X

- Detects ALL metals on land & underwater
- Audio and Visual output
- Commercial construction
- Ideal for evidence recovery
- Rated #1 by US Homeland Security

### SAR-1

- "Snareless" design with VIBRATING handle
- Bright red LED display
- Specialized for low visibility environments
- 200' depth rating

## Side Scan Sonar

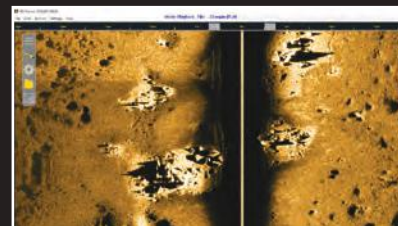

\* Simulated Drowning Victim



### 600kHz - CW

- Simple to operate
- Up to 225' (75m) range on each side
- Displays images on laptop or tablet
- Commercial construction
- Works in all waters, regardless of clarity
- In use by public safety dive teams

### 450kHz / 900 kHz - CHIRP

- Fully digital
- Up to 495' (150m) range on each side
- Breaks down for easy transport (case included)
- Commercial construction
- Low cost and easy operation
- Complete turnkey system

## Remote Operated Vehicle with Sector Scanning Sonar



### SeaLion-3

- 7 vectored, thruster system
- Front and rear 1080p HD cameras
- Two monitors for viewing and control
- Picture in picture (PIP) functionality
- Easily transportable
- Commercial construction
- 1,000' depth capability

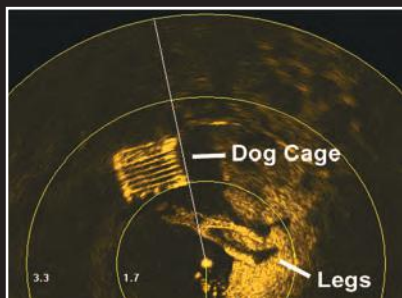

### SCAN-650

- Target sizing capability
- 360° sweep pattern
- High resolution imagery
- User friendly software
- Commercial construction
- ROV, pole or tripod mountable
- Starting at \$6,995



PHONE: (508) 822-7330  
 info@jwfishers.com  
 jwfishers.com

shut-down and become lost or entrapped. The downfall of video is that it relies on fairly clear water and this is often not what you're dealing with in inclement weather which is why acoustic imaging or sonar is a more favoured function - it not only 'sees' through the murk, it does so over distance of 100s of feet. It is sonar which sets apart the more serious ROV packages and these aspects require far more detail than we can provide in this general article.

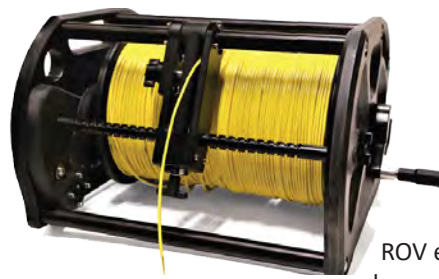

Tethers add considerably to the air weight of the package and to the in-water drag that the ROV experiences though they are often neutrally buoyant, Experienced controllers learn to manage the cables so that they impart the minimum drag from the cable reel or pack to the water's edge. In-water there's not too much you can do other than avoid changes of direction after obstacles or even seaweed wracks that will conspire to add drag and limit the endurance time of your ROV.

## TETHERS

Technically a tether is simply the load-capable connection between your ROV and top-side that enables you to drag it back should it lose power. Once you add a power cable and data transmission cable (fibre-optics) your tether is actually an umbilical providing and receiving vital power and/or data as well as being the distance restrain and haul-back line. Power transmission cables like the Video-Ray Expedition Reel below, may not be as long as a simple tether cord or cord & fibre-optic tether which is only limited in length by the capabilities of your ROV and sheer weight and bulk of log tether lengths. Your ROV will have a depth rating which is related to water pressure and what the casing can withstand. This can be anything from 5metres/16feet to 2000m/6560ft.

Two things to note here - 1) you might think 5metres - what the hell use is that? But if you are an inland water rescue or dive team it is highly likely that the vast majority of your incidents will involve water depths of less than 30ft so size isn't everything. 2) Equally, do not think that if your ROV has a limit of say 100feet, you only need 100 feet of tether or umbilical. Again, it's not about depth, it's about lateral searching. JWfisher's tether option for the 1000ft rated Seal Lion is 1500ft, not so that you can run it so far beyond 1000feet that you might break it but so that you can move up to 1500ft laterally from your control position - it might only ever be 15ft deep. Of course you then have concerns about the battery life and in particular if you are fighting a current or water flow. That's when that tether might become even more crucial as it allows you to run your ROV out to the max and then manually haul it back rather than operating on only half the limit because you are guiding it back under power before passing the PONR.

## MANIPULATION ARM, GRABS & TOOLS

Other add-ons include the ubiquitous grasping jaws that you see in every deep-sea film but for rescuers, it's not so common even though it can prove immensely useful. Some are more versatile than others, the simplest, cheapest options are single axis arms that only move up and down or left and right. Some don't move at all and are 'grabbers' or other tools that connect direct to the ROV body. Manipulators like the set sported by Video-Ray's Defender below, can operate in all axis directions, swivelling at the union and articulating at the elbow and 'wrist'. The best option might be a modular arrangement that allows you to quickly remove or attach a **MANIPULATOR ARM** or a head (connecting directly to an ROV without the articulated arm) and if that also allowed you the choice of **GRAB** jaws, hydraulic **CUTTER** or even a **LASER** so much the better. But as an inherent feature that you specify at the time of purchase, these are extra expenses, complications to electronics and snag hazards that could trip you up if you are only using them infrequently. Blueprint make a generic series of manipulator arms and tools (pic right) that are used by *Boxfish* and *Video-Ray* among others.



In terms of retrieval of an object or body by grabbing it with jaws, the grip strength is not the same as the ROV's load capacity. You must remember that a strong grip closure can damage an item or disintegrate a cadaver so your control needs to be finite and accurate. You have the advantage that the load capacity is significantly increased by the buoyancy of water - a 10kg/22lb payload may just be enough to move an adult weighing 100kg/220lb under the water. *DeepTrekker*, *Video-Ray* and *Boxfish* offer a **LASER** (scaler) which is not a James Bond villain cutting tool but a rangefinder or incredibly accurate measuring device using two beams.

There are guides with specifications to all of the most applicable small ROVs and Sonar systems in our free **WATER RESCUE BUYERSGUIDE out late Spring 2024:** <https://accessandrescue.hflip.co/GuidetoWaterRescueEquipment>



# SONAR EMILY

- Easy Operation based Humminbird SONAR
- Real-time imagery for search and recovery missions
- Light weight (17 kg)
- Line of Sight technology
- GPS Accurate Mapping
- Navigation Lights for Night Missions
- Side scan, downward imaging and bathymetry
- SD cards for recording and post-processing
- Autonomy through easy waypoint entry
- SARHAWK Post Mission Processing Software

# SWIFT WATER RESCUE EMILY

- Line of sight technology
- Battery powered, jet boat
- Fast and durable, 40 km/h
- Navigation Lights for Night Missions
- Easy to deploy off riverbanks, piers, bridges
- Self-righting technology for strong currents

**HYDRONALIX**

For UK: [info@emilyrobotuk.co.uk](mailto:info@emilyrobotuk.co.uk)  
For US: [info@hydronalix.com](mailto:info@hydronalix.com)



# MODULAR MULTIPOD & TETRAPOD HIGH-DIRECTIONAL

**AHD**s or Artificial High Directionals became a thing earlier this century largely because Reed likes to name things and see if it catches on. It refers to a manufactured addition to the landscape that can hold your rope systems clear of the ground and edge that needs to be negotiated. Technically, a self-supporting tripod or quadpod holding loads centrally without the need for lateral guying or opposing vector forces isn't acting as a high directional but more often than not all of these frames are called AHDs. This MARKET GUIDE DOES NOT include the humble one-piece industrial tripod with three legs more or less equally sized. Many of these are used by mountain, cliff and cave rescue teams because they are the cheapest and sometimes smaller option



Modular systems often come as complete kits. In fact, the Arizona Vortex above is normally only offered as the one kit to which you then add extra and different components.

so you can find a full list of ALL Tripods, Quadpods and AHDs in our **BUYERSGUIDE to ROPE EQUIPMENT**. Here we are concerned only with modular AHDs that break down for transport and offer the best options for negotiating tricky edges as one of two or more variations. We have not included perhaps the most versatile of modular systems the USAR struts because they are so heavy and bulky as to be firmly the domain of urban-industrial teams that can drive a vehicle direct to the incident site. Nevertheless, if you want your AHD to also double as vehicle stabilisation struts, shoring for collapsed building or trench rescue struts then check them out in our **ROPE EQPT and USAR/EXTRICATION BUYERSGUIDES**. Tripods are the default configuration for most modular systems and a tripod was



LEFT: The Eyolf Pythagoras has a swivel foot option but at its simplest offers this spike and ball-end leg. The AZV Raptor spike foot has attachment eyes, a spike and an upturned hook. The ball and socket joint is common to many models offering a stable foot able to orientate to any angle and direction. This AZV foot is attached to a n AZORP rigging head making it the shortest monopod on the market!



# FRAMES

the norm for rescue throughout most of the 20th century, in the case of many US/Canadian wilderness teams these were often jerry-rigged on-site from timber and rope lashings. Bi-pedal A-frames too have been AHD's since Egyptian/Greco/Roman time and perhaps before. So they're nothing new but in the context of this article, and rescue in general, we are determining an AHD to be a purpose built, load-bearing frame capable of lowering and lifting a rescue load (2 persons and associated paraphernalia). They are really static versions of a maritime or dock-side davit arm but highly mobile and adaptable to different edge negotiation situations. In wilderness rescue terms they are something of an anomaly since we are generally concerned with low weight and low bulk whereas these things are likely to be

second only in mass to the vehicles you arrived on scene in! However, an AHD can be a single pole (monopod) if properly guyed/stayed or a two-legged A-frame both of which are lighter than a tripod or multitipod but require more expertise to rig and operate.

There are 7 distinct types of stand-alone

AHDs:

- 1) **MONOPOD** - single leg with anchor points on the head for back-stays and main attachment for the lowering system. *TerrAdaptor* version shown on the right
- 2) **BIPOD/A-FRAME** - two legs which can luff out beyond an edge if properly guyed.
- 3) Traditional **TRIPOD** with a fixed head and attached legs
- 4) Traditional **QUADPOD** with a fixed head and attached legs
- 5) **BEAM** where a gantry is created between two sets of legs to span much wider gaps or trenches.
- 6) **MULTIPOD** which is a modular system of detachable legs, head(s) and components capable of creating any of the above depending on head-anchor configurations.
- 7) **TETRAPOD/TETRAHEDRAL FRAME**; which used to be just the Australian *Larkin Frame* but there is now some competition. This is effectively a pyramidal shape (or two pyramids joined) with a rigid frame connecting the three feet together and tipped over so that it pivots on the edge created between two legs - simple genius. This is a true luffing frame in that the load-head can be safely moved in-board of the edge for safe rigging by pulling down on the rear 'tail' of the frame. When ready that same tail is then lifted (under strict control) so that the head and load are luffed out beyond the edge so that all ropes clear the edge and edge negotiation is safe and simple.

In monopod or gin pole configuration you can really see the difference in bulk between the immense strength and bulk of USAR shoring strut systems (not included in this guide) like *Holmatro's* 3.2kg/7.1lb monopod head (left) with 4 stainless steel shackles for guys and the more wilderness oriented models like *SMC's* rather more mountain orientated *Space Station* above right at- around half the weight at 1.8kg/4lb and the *Arizona Vortex* head (right) is half the weight again at 1kg/2.2lb.

## LIGHT ALLOY MODULAR SYSTEMS

Our title pic is one of Reed Thorn's favourites and shows the *Arizona Vortex* in its natural

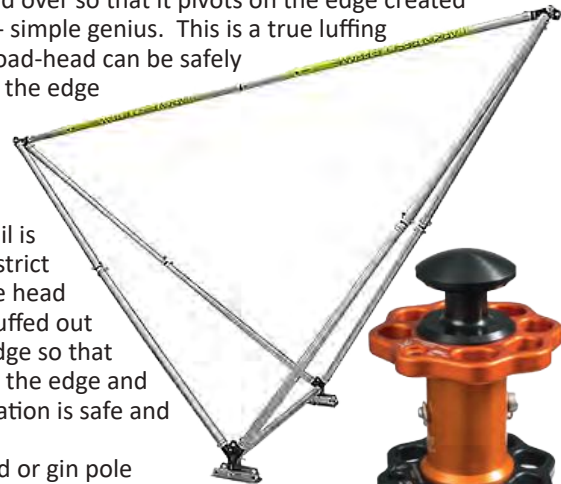

environment in Sedona and is, together with the *SMC TerrAdaptor*, *Ferno's Arachnipod* and the new *Eyolf Pythagoras*, the most adaptable of modular systems capable of being transformed from a mono-pod to an A-frame to a tripod and a quadpod. In the case of the *Arachnipod*, the quadpod can have a regular head or a beam gantry that enables you to span the width of a hole or edge from side to side up to 4m. The legs, heads, feet and accessories are all detachable and interchangeable. *Kong* and *Protekt* for instance have footplates that are anchored by the weight of your vehicle (wheel). On the previous page *SMC's* tripod and monopod head are packed in a bag separate from the legs and feet while the complete *Arizona Vortex* system packs into 4 to 6 bags including two just for feet. This makes transport in wilderness areas a lot easier as the weight and bulk is spread across multiple team members safe in the knowledge that when they arrive at the incident, their AHD will cover every eventuality. The *AZV's* flat plate (far right) can rotate 360 degrees with a ball and socket joint but a second type of foot has a spiked foot. *Kong's* modular foot (shown above and on the *Cevedale* right) has a sprung spike below a broad, spiked plate with further ground spike holes. It also has a load bearing eye not present on the basic leg.

## FIXED HEAD TRIPODS

**Are not included in this guide** but can still be useful to wilderness rescuers. On the right is *Kong's Cevedale Rescue 2* and far right is *SAR Product's Quadpod* which are fixed head tripods where the legs and head are semi-permanently connected and you simply fold everything inwards for storage and transportation in one bag. As with all lightweight AHDs the legs telescope and pin in place to give shorter or greater working height. The *Cevedale* has two integrally mounted hand winches for twin line raising/lowering. The majority of tripods and certainly all square/rectangular section AHDs, will accept some kind of mount for a winch and this is most common in industrial 'con-space' tripods. There was a time when virtually all tripods used for industrial access and rescue were one-piece, fixed head tripods and these are still the cheapest option but they do have quite specific and limited applications - they are great for over-hole entries but can still help with edge negotiations for vertical rescues providing they are back-stayed correctly because **any pull outside of the triangular or rectangular footprint will result in the frame collapsing**. Assuming that the tripod is anchored in some way, this should only result in those over the edge experiencing an alarming drop of several feet rather than having a few hundred pounds of metal hurtling towards them. This can be mitigated by running the belay directly over the edge (via soft edge protection) rather than having the main rope and the belay running through the head of the AHD. This 'grounded belay' option may not be used by experienced teams using more sophisticated AHD's that can be properly configured and stayed for the edge negotiation situation because the whole point of the AHD may be to stop rope running on unstable ground and knocking down debris.



Grand Canyon National Park Rangers using the Arizona Vortex. Pic by GCNPS/A Fitzgerald

## FOOT RESTRAINTS

A number of tripods have locking pins on the head to stop the legs spreading beyond a set limit, or the head design holds the legs at a predetermined angle so these can dispense with leg restraints which some see as a trip hazard. But the norm for modular systems likely to be adopting more acute angles is for a foot restraint strap/rope/chain to ensure the legs can't spread and collapse the AHD under load. Most have eyes or larger attachment rings on the foot or at the base of the legs - these can have a rope threaded or simply clip in a carabiner and adjust the rope, webbing or chain to allow the required spread. Note that these are not always load bearing beyond leg restraining but some are also fully load bearing deviations for your operational rope systems.

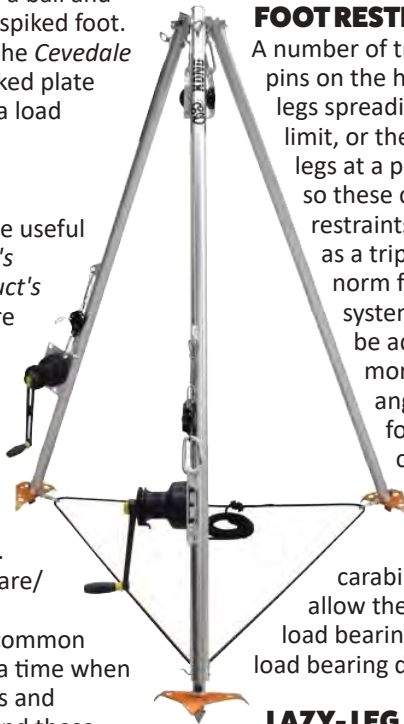

## LAZY-LEG

In the image at the top of *GCNP's AZV system* you can see that the two forward legs are hard up against the edge, in this case at around 80 degrees to the vertical rather than angled forward like the *SAR Products Quadpod* above, but it could easily be. The single leg at the rear is a lazy-leg in that it takes very little of the load that is applied to the A-frame legs, in fact virtually none until or unless the load moves in-board of the edge. Instead, its function here is to offer stability and security to the two A-frame legs to restrict rearward movement during hauling. It can also be used to increase the footprint for spanning larger holes or gaps than an equilateral tripod/quadpod might offer and to bridge uneven height. Of course any tripod or quadpod can have one (or two) legs extended more than the others in order to mimic a lazy leg as with the *Quadpod* above but true lazy leg head attachments allow greater rotation and in the case of some round-tube models, can be adjusted through the head and locked to alter the length. All legs on the *AZV* and *TerrAdaptor* can extend through and beyond the head to be locked into place with pins.

# Obelisk

for Technical Rescue teams



Designed and manufactured by Lyon Equipment specifically for emergency service work. Adjustable width cross-head with max height of 2200mm for a large, clear working area below the anchor points.

**LYON**  
WORK & RESCUE

# MARKET GUIDE

## TETRAHEDRAL FRAMES (TETRAPODS)

We're calling this a TETRAPOD. The iconic *Larkin Frame* from Australia (distributed outside Oz by *Lyon Equipment* in the UK) is an offset pyramid which you tip over in order to clear an edge or it can sit upright in a standard tripod configuration except with solid leg restraints instead of the usual webbing or rope! The *Larkin* is a simple, fixed structure but is nonetheless very versatile. In this image you can see how guying and



manoeuvring the 'tail' of the frame allows the head to clear an edge by quite a large margin. The frame pivots on two feet and there are pulleys on fixed eyes at the two top corners of the frame. We only know of two competitive designs to this, one is another of our old favourites - the *SRTe OzPod* which was taken over by *DB Sala's Rollgliss* and then *3M* and then disappeared along with all *SRTe* gear. The *Ozpod* was a modular system comprising a tripod (or A-Frame) and a base frame that converted it into a tetrahedral frame. The interesting thing about this one though is that the frame had a hinged 'break' (arrowed) which enabled you to pull back on a handle to luff the frame in and out under load as well as pivot the frame. It meant that edge clearance was greater than pivoting the frame alone. Like all tetrapods the rescuer and casualty can be brought inboard within (or on) the frame rather than close to the edge. The tripod part of this *Ozpod* still seems to be produced by or on behalf of *Skedco* in the US. A more recent version, though by no means new, is *Kong's*

*Grizzly*. This differs in having no rigid section between the two feet so technically a bi-pod. Like the *OzPod*, this is modular in that the legs or poles can be used to create a bespoke monopod (inset pic) and bi-pod. The components shackle together with the shackle then creating load bearing eyes at each corner. Multipods and tetrapods can take longer to set up than more basic tri/quadpods, we required a single rescue technician to set up the *Ozpod* as shown above within 5 minutes, no mean feat. In contrast a much simpler tri/quadpod will go up in a couple of minutes and modular and tetrapod in 3-5 minutes. None of these times include attaching stays/rigging.

## BEAM GANTRIES

In the modern era it was *Ferno's Archnipod* that introduced a transverse beam to attach to their regular A-frame legs and create a gantry that could span a much wider opening or a section of trench. With an eye (or two) on a sliding trolley controlled by a pulley adjustment system this provides a versatile option. We also found this to be useful for improving lateral positioning options on a cliff/building edge but this is not a use you see much (or it's not really allowed) because they are designed to be loaded vertically not with the slight side-pull that an edge negotiation imparts. Nevertheless, properly guyed, this works and we found it much safer than the alternative which is to pendulum the main line(s) to negotiate an obstacle. In the case of the *Arachnipod* you can have a 2, 3 or 4 metre/13ft beam so these entire gantry arrangements are generally too large and heavy for use.

*Protekt* too have a huge beam gantry using two tripods so it's called the *Hexapod* but while it is included in the **Rope Eqpt BUYERSGUIDE** it isn't modular apart from the beam itself being detachable so is a not included in these data tables. Which brings us to the *Obelisk* from *Lyon Eqpt* in the UK (pic right). They came up with a true cross between a quadpod and a manageable sized beam gantry with a very slick trolley system that's about as bombproof as they come. Their stainless steel beam is only 40cm/15" wide but can take one or two sliding eyes. *SAR Products*, also in the UK have a *Multipod* that has moveable but fixed position eyes on its beam that is enough to give you some options when positioning the load. As a modular head there is scope for both *Lyon* and *SAR Products* to expand the beam options should demand require

it. The *SAR Products* head is not as slick as *Lyon's* but it does offer a tripod option within the kit as well as quadpod.

*TerrAdaptor's* answer is this excellent use of existing components offering a multi-position beam head that can be pinned in place. position.

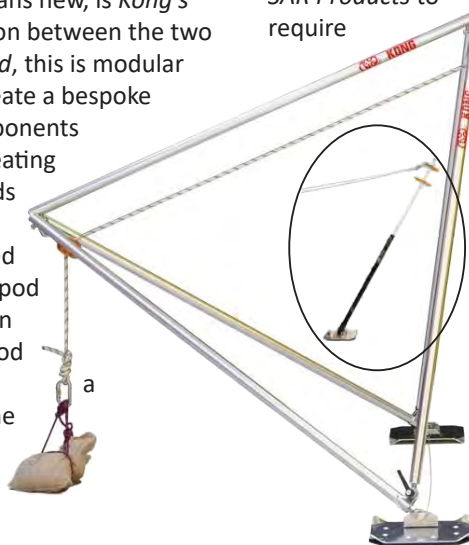
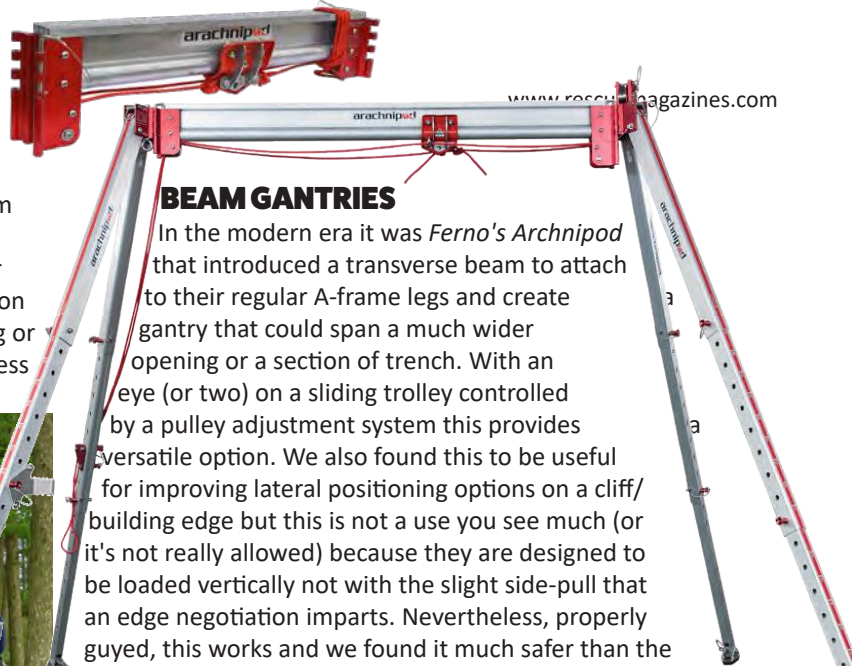

### VARIOUS OTHER FEATURES

Some of these modular systems are very complex with numerous kit options for the gin-pole, bi/tri/quadpod and beam systems that we could not hope to list separately in this guide - with the *Arachnipod* for instance there are 8 variations on the one tripod - so our prices give the most basic rescue model to the most complex but even that can be augmented with more optional extras. Above is the previously discussed *Obelisk* head made of stainless steel, a useful material if you operate in a marine/sea cliff environment where regular steel and aluminium alloys will degrade unless kept clean and dry. Very few models provide numbering on their adjustment holes and yet we have always contested that this is an incredibly useful (and simple) feature to ensure correct assembly when you're in a rush, in the dark in poor weather conditions. Of course industry drives much of the AHD development and they don't care so much - it's an extra cost they don't need. *Lyon's Obelisk* for instance is available with number for an additional charge. The *Arachnipod* remains the finest proponent of clear markings with numbers and letters on the top and bottom sections to really ensure there are no mix ups. Their standard feet above show just how clear their marking is, at least while the tripod is new. It's worth maintaining these markings with your own resin paint or marker. *TerrAdaptor* has etched markings (circled) which you can paint to get excellent longevity and visibility. The

## MODULAR HIGH-DIRECTIONALS



Arachnipod feet (right) exhibit five features already covered -

- 1) a swivelling foot that is
- 2) detachable so that you swap in larger or more specialist feet. 3) A tactile/grippy base for smooth, hard surfaces. 4) A hole for driving in a ground stake and
- 5) a pointed or spiky end that can dig into softer ground. *Protekt* and *Ferno* have steps that can be attached to the leg to aid in rigging or tending the head once erected. *TerrAdaptor* has a universal attachment eye (left) and similarly *Ferno* also offers a slightly bulkier option for connecting pretty much anything you can think of from hybrid descenders to clipping your bag of sandwiches clear of the ground. To simplify and speed things up some offer spring-head push-pins (eg. Lyon, SMC (pic right), Rock Exotica and Ferno.)



### WINCHES

Winches are an option on most AHDs, either as a bespoke item where the manufacturer can supply a specific attachment to fit the type of tube or as an off-the shelf universal fitting. This can then have a hand winch attached to a leg to provide a smoother, mechanically advantaged option for hauling and lowering. Costs increase considerably for any of these add-ons, the Harken hand winch on this *TerrAdaptor* for instance will set you back about \$3000 with a leg adaptor.

**HIGH QUALITY RESCUE EQUIPMENT**

**KONG ITALY**  
www.kong.it

**KONG USA**  
www.kongusa.com

GRIZZLY # 617400000K

1 2 3

available in North America by

TERRADAPTOR 



**LEAVE  
NOTHING  
TO CHANCE**

When lives are on the line and minutes matter, the TerrAdaptor's versatility for rescue is unmatched. This flexibility starts with a head design that allows each leg to be adjusted to almost any angle. When you need to create a wide array of beam, bipod, tripod and quadpod configurations, the TerrAdaptor has you covered with unparalleled adaptability.

And the TerrAdaptor bag system now features updated, stowable backpack straps for easy portability and a reconfigured head bag for faster deployment.



**VISIT OUR WEBSITE TO ORDER YOUR TERRADAPTOR TODAY.**  
**SMC - SEATTLE MANUFACTURING CORP**  
**WWW.SMCGEAR.COM**  
**1-800-426-6251**



**IN THE FOLLOWING TABLES:.....**

**ORIGIN:** Is the parent company - an inset flat may indicate the manufacturer's country if different but we don't always know.

**COST:** Is for the most basic tripod configuration (not a monopod/bipod option). Some also list the variant or the most expensive version with all the bells and whistles. Prices are approximate, include VAT@20% &/or US State Sales Tax. We generally round up the cost to the nearest Pound£, US Dollar\$ or Euro€. **£\$€ in orange is a currency conversion only.**

**MATERIALS- HEAD LEGS:** The head is the section that ties the legs together and provides the main attachment points. The true Tetrahedral frames typically don't have a 'head' instead just having load bearing eyes in the corners. Legs are all aluminium alloy but some of the 'alu' heads are cast rather than machined.

**TUBE PROFILE TELE-SECTIONS:** The cross section of material which will be either round tube, square or rectangular and the number of telescoping sections in each leg, usually 2 but some are 3 or even 1 which will not reduce further for transport.

**MARKED INCREMENTS:** The total number of length adjustments available on any given leg. Usually this will be some kind of independent pin that needs to be secured to the frame to prevent loss but some (like the heavy duty shoring struts) have an integrated sprung plunger or similar locking mechanism built into the leg. **MARKED=**  the holes are numbered/lettered-much better for coordinating construction.

**LAZY-LEG WINCH ADAPTER:** Whether the system includes a Lazy-Leg (usually longer) and/or an adapter to the head that accepts a Lazy-Leg because it needs to be able to rotate up and down to a shallower angle than the side legs. **WINCH ADAPTER** allows a winch to be connected to a leg.







**WEIGHT:** for the basic tripod/quadpod unless sold as a complete kit. Excludes additional accessories: leg restraints and pulleys etc, unless integrated into the structure of the tripod.

**PACK(S) DIMENSIONS:** The number of carry bags/packs required to transport the AHD and the dimensions of the largest pack. An outline square  bespoke bag(s) is an option not included in kit price.

**MIN / MAX WORKING HEIGHT:** The working height is the maximum clearance that you can expect beneath the main load connection point IT IS NOT the overall height of the AHD though there will no doubt be some in here that have supplied that info instead! The Minimum height is achieved by compressing the leg to it's minimum setting but will always be dictated by the length of the longest leg section.

**MAX FOOTPRINT:** The largest circular hole that the tripod or quadpod can span and remain functional. This can simply refer to the standard to which it adheres - NFPA= 70"/178cm & CE 78"/203cm - a lazy leg can increase the span width much more.

**TYPE OF DEVICE:**

-  **MONOPOD:** Single leg with load bearing head
-  **BI-POD** Two-legged A-frame with load bearing head
-  **TRIPOD:** Three legged frame with load bearing head
-  **QUADPOD:** Four legged frame with load bearing head
-  **BEAM:** Load-bearing gantry between two sets of legs.
-  **TETRAPOD** Single or Double Tetrahedral frame

**MAXIMUM DEVICE LOAD:** Like the footprint, this figure can simply be the minimum required to meet a standard like 600lb in the US - they frequently hold much greater loads or quote a higher load for non-human weight. This max weight should be applied to the frame **only via the main load attachment point(s)**. This is akin to the Working Load Limit (NOT to the MBL/MBS) and will increase as height of AHD is decreased. NOT the max load that can be applied to the lateral (guy) eyes.



**TYPE OF HEAD MONO BIPOD:** Whether the head is readily detachable or fixed/bolted or is a beam. A BEAM or gantry spans two pairs of legs and enables a wider work width and/or the main hard point to be moved. They allow a moving but lockable 'trolley' to be used as the load's attachment point. **MONOPOD** or **GIN** head mounts to a single pole. Many in this list are already capable of operating as a **BIPOD** head.

**CONNECTION:** the type of load-bearing, main attachment points at the head - often a swivelling ring bolt to help negate unnecessary torque loads on your carabiner/connector but some have a fixed ring bolt, a shackle or a machined eye. The other commonest option is a drilled eye in a plate or multiple eyes in a rigging plate. The *TerrAdaptor* and *AZV*, have machined eyes with pins for connecting any type of hardware, usually a pulley or a lowering device(see ad-left).

**INTEGRATED PULLEYS:** pulley sheaves built into the structure of the AHD. Can also act as the main connection point carrying the load bearing rope(s) back to a separate anchor.

**LATERAL/REAR (GUY) EYES:** On or near the head. Some are fully load bearing but their orientation or position restricts use to anchor/stay attachment to keep the AHD stable and resist the direction of load. If none are shown, use main eye(s).

**FOOT HINGES BALL-JOINT DETACHES:** The foot can swivel upwards for storage or to change from flat to spike etc. like this *Obelisk* foot. **BALL JOINT** enables 360° rotation and lateral movement of the leg. **DETACHES** means it can be easily removed for change of foot type and/or storage

**ANCHOR EYES SPIKE GRIP:** holes that allow spikes or ground stakes to be driven through.

**SPIKE:**the foot is, or incorporates, a spike to dig into ground for a solid purchase (like this *Obelisk*).

**GRIP for hard surfaces:** May be a tactile/grippy surface like rubber or studs (like this *Obelisk*) or plastic/metal ribbing for purchase on hard

surfaces. At least one model has suction cups

**SIDE RESTRAINT ANCHOR EYES:** These are eyes or eye bolts to, or through which you connect the leg restraints. **ANCHOR** = rated for load-bearing deviation pulleys or hardware

**LEG RESTRAINTS LEGS LOCK:** Rope, webbing or chains used to stop legs from spreading. **■**=Legs are/can be locked in place.

**VERTICAL EDGE:** Can operate at, up to or slightly over a cliff or building edge. Properly guyed quadpods offer more stable option than a tripod unless it has a lazy leg.

**LUFFING:** The frame head can be manoeuvred over and beyond the edge (not just by guying)

**HOLE/CON-SPACE:**Can be positioned over a hole/well/entry for confined space entry/ vertical entry/rescue.

**CONFINE:** NOT to be CONFUSED with HOLE/CON-SPACE above where the entry is *into* a confined space but the AHD could be the size of a double decker bus! Here we mean that the device can be taken into, and operated within, a confined space - usually only devices with legs that can retract to allow a frame of less than 4ft in height.

**STANDARDS:** As usual, European CE are the most comprehensive and applicable across the work and rescue spectrum but there are several that apply, from anchors and PPE fall restraint to Machinery Directive but EN795-B for mobile anchor devices is probably best.

EN365=PPE against falls from height

EN1495=Mast climbing platforms

PD CEN/TS 16415= Personal Fall protection for max 2 persons.

EN795= PPE Anchor devices B= mobile, relates to all AHDs

EN1808 =Suspended access equipment

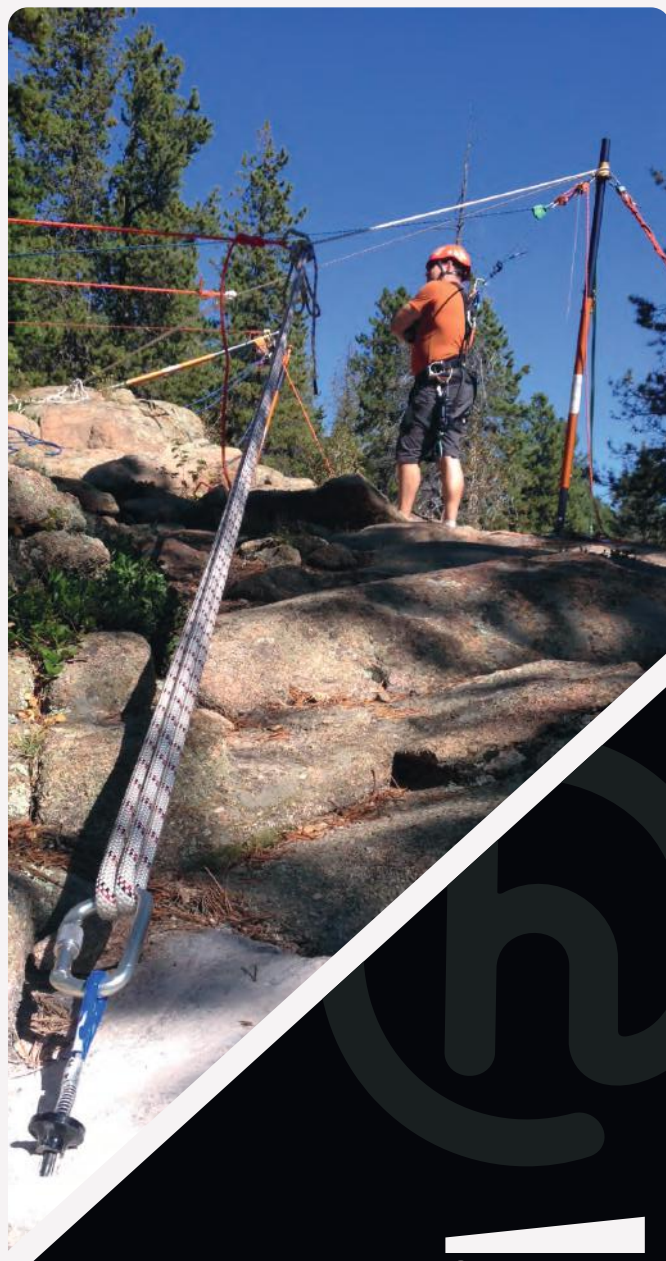

ClimbTech

## Removable Anchors

13mm (1/2") or 19mm (3/4")  
Completely Reusable  
MBS > 22kN



Distributed By  
**at height uk**  
www.atheightuk.com

# 4D POLE



NFC READY



more info

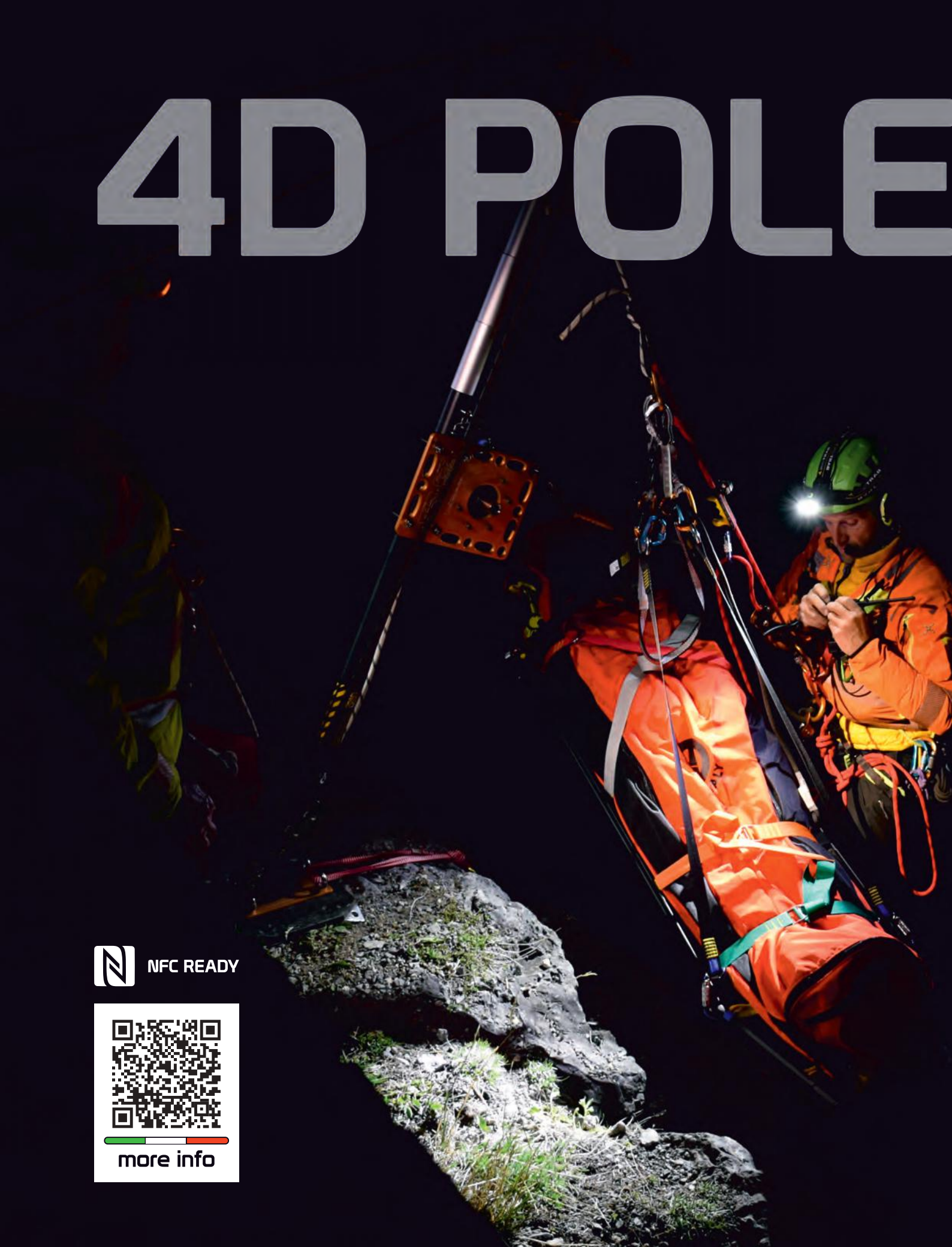

# KONG USA



[www.kong.it](http://www.kong.it)

# MARKET GUIDE

Images NOT to Scale  
Accessories shown may be an optional extra

MANUFACTURER		EYOLF			FERNO			KONG		
MODEL VARIANT		Pythagoras			Arachnipod TEMS (2,3 or 4m beam)			Grizzly 817.400		
ORIGIN										
COST		Base model: £2350 \$2990 €2750 Variant/Top model: £2800 \$3570 €3290			£3290 \$3600 €3830 £10055 \$12800 €11705*			£2700 \$3095 €2350 - - -		
STRUCTURE	TYPE OF DEVICE	■ ■ ■ ■			■ ■ ■ ■ ■			■ ■		
	MATERIALS HEAD LEGS	Alu Alu			Alu Alu			- Alu		
	TUBE PROFILE TELE-SECTIONS	Round 2			Rectangular 3			Round 1		
	MARKED INCREMENTS	■ 10x 11cm/4"			■ 20x 10cm/4"			Not applicable		
SPECIFICATIONS	LAZY LEG WINCH ADAPTER	■ -			■ □			- -		
	WEIGHT (BASIC TRIPOD)	22.2kg 49lb			27/32kg 60/70lb			15-22kg 33-48lb		
	PACK(S) DIMENSIONS	□ 1 122 x 15 x 15cm			■ 1-3 210-400cm			■ 1 200x30x15cm		
	MIN WORKING HEIGHT	110cm / 3ft 7"			112cm / 3ft 8"			150cm / 4ft 11"		
	MAX WORKING HEIGHT	190cm / 6ft 3"			267cm / 8ft 9"			160cm / 5ft 3"		
	MAX FOOTPRINT	220-330cm / 7ft 3"-10ft 10"			253-534*cm / 8ft 4"- 17ft-6"			190cm / 6ft 2"		
	MAXIMUM DEVICE LOAD	272kg 600lb			220-400kg 484-880lb			300kg 660lb		
HEAD	TYPE OF HEAD MONO BIPOD	Detachable + bolted □ ■			2x Detachable 2/3/4m Beam* □ ■			None - Tube unions - ■		
	MAIN LOAD EYES	12 Rig Plate Eyes			2/4 Ring Bolts + Sliding/locking			2 Shackles (in separate 'corners')		
	INTEGRATED PULLEY(S)	option - 4 pinned sngl or dble sheaves			2/4 (each=Dbl sheave- 1 wire, 1 rope)			0 (2 detachable supplied)		
	LATERAL/REAR (GUY) EYES	18 (on head)			3/4 (on top of each leg)			2		
FEET	LEG STEP LEG EYE	- □			□ □			- -		
	HINGED BALL-JOINT DETACH	■ - ■			■ - ■			■ - ■		
	ANCHOR HOLES SPIKE GRIP	■ ■ -			■ ■ ■			■ ■ ■		
	SIDE RESTRAINT ANCHOR EYES	■ -			■ -			■ -		
USES	LEG RESTRAINTS LEGS LOCK	Webbing with cams -			Rope -			Wire cable -		
	VERTICAL EDGE LUFFING	■ ●			■ ●			■ ■		
	HOLE CONFINE SHORING	■ ■			■ ■			■		
STANDARDS		CE pending			EN795B, CEN/TS 16415/A			EN 795/B EN 1496/B CEN/TS 16415/A		
NOTES		Pulley sheaves can be pinned into the head on both sides. A tripod version can have a cheaper bolted head with single eye			**2,3 or 4m Bridge options create the wider footprint. Alpha-numeric increment labels. Option-Foot steps & anchor points for legs.			* Including all available options		
WEBSITE		eyolf.ca			ferno.com.au			kong.it		

NOTES: COSTS: £€ shown in burnt orange are currency conversions only COST: Approx & inc local tax/VAT TYPE OF DEVICE: ■=MONOPOD ■=BI-POD ■=TRIPOD

# MODULAR HIGH-DIRECTIONALS



KONG	LYON	LYON/SPELEAN	PROTEKT
<b>Cevedale Rescue1 Rescue2</b> 842020000KK 842010000KK 842000000KK	<b>Obelisk</b> LPP0003	<b>Larkin Frame</b>	<b>TM14ZSE</b> AT016
£1730 \$2290 €1710 £8670 \$9000 €7160	£2544 \$3240 €3000 - - -	£5820 \$7300 €6790 - - -	£1310 \$1665 €1530 - - -
- Alu	Stainless Steel Alu	Cast Alu Alu	Steel Alu
Round 2	Square 3	Round 1	Rectangular 2
- 3 6	23x 7.5cm/3"	Not applicable	- 7x
-	-	- -	-
14 20-25kg 30 44-55lb 13oz	22kg 48lb 6oz	40kg 88lb 3oz	65kg 143lb
1 130x45x30cm	1 100x25cm or 2x <b>11kg/24.2lb</b>	1 202x24x30cm	1 228 x 32 x 30cm
160/165cm / 5ft 3 5"	100cm / 3ft 3"	120cm / 4ft	179cm / 5ft 11"
254cm / 8ft 3"	220cm / 8ft 8"	250cm / 8ft 2"	289cm / 9ft 5"
180cm / 5ft 11"	230cm / 7ft 6"	120cm / 4ft	271cm / 8ft 10"
1223kg 2697lb	272kg 600lb	400kg 880lb	500kg 1100lb
Fixed - -	Beam - -	Detachable -	Detachable -
3 Ring Bolts	1 or option for 2 Sliding Ring Bolt	2 Machined Eyes	2 Plate Eyes
0 (2 detachable supplied)	0	0	1
3 (on tripod head)	10* (on tripod head)	0	Vehicle anchor Plate
- -	- -	- -	- -
-	-	-	- -
-	-		- -
	-		-
Wire cable or Rope -	Webbing with cams -	-	-
		*	
EN 795/B EN 1496/B CEN/TS 16415/A	EN795:2012, CEN/TS 16415:2013	The frame is not directly anchored to, so is deemed a large redirect, not load-bearing AHD	EN795B&E, CEN/TS 16415/B&E, EN 1496B
*Rescue versions Include 1 and/or 2 integrated rope winches. Kong also has a stand-alone monopods - STELVIO and 4D.	Sliding eye(s) can be set anywhere along a 40cm/16" beam. *10 is really 6 because 2 eyes on the ends are divided into four by the beam	Can be used as full or half sized. *because it can be used as a half sized frame	ZSE is a modification of basic TM14 tripod. TM7 is the same but cannot be ZSE configured
kong.it	lyonequipment.com	lyonequipment.com	protekt.pl

= QUADPOD = BEAM/GANTRY = TETRAPOD USES: = OK BUT NOT IDEAL = Available as an Option

# MARKET GUIDE



Images NOT to Scale  
Accessories shown may be an optional extra

<b>MANUFACTURER</b>		<b>ROCK EXOTICA</b>	<b>SAR PRODUCTS</b>	<b>SMC</b>
<b>MODEL VARIANT</b>		Arizona Vortex	Multipod QU005	TerrAdaptor
<b>ORIGIN</b>				
<b>COST</b> Base model Variant or Top model		£6300 \$5279 €7558 - - - *	N/A* - - -	*£5800 \$5350 €6800 £9010 \$8520 €10500
<b>STRUCTURE</b>	<b>TYPE of DEVICE</b>	■ ■ ■ ■	■ ■ ■	■ ■ ■ ■ ■
	<b>MATERIALS HEAD LEGS</b>	Alu Alu	Stainless Steel Alu	Alu Alu
	<b>TUBE PROFILE TELE-SECTIONS</b>	Round 2	Square 2	Round 3
<b>MARKED INCREMENTS</b>		- 6x *14-15cm/5.5-5.9"	-10x 10cm/4"	■ 9x 12.7cm/5"
<b>LAZY LEG WINCH ADAPTER</b>		■ -	- □	■ □
<b>SPECIFICATIONS</b>	<b>WEIGHT (BASIC TRIPOD)</b>	33kg 72lb	17.5kg 38lb 8oz	23.8-38kg 52.3-83lb 4oz
	<b>PACK(S) DIMENSIONS</b>	□ 4-6	■ 1 120x17cm or □ 2 bags	□ 3 132x25.4x9cm
	<b>MIN WORKING HEIGHT</b>	270cm / 9ft	150cm / 5ft	122cm / 4ft
	<b>MAX WORKING HEIGHT</b>	370cm / 12ft	200cm / 6ft 7"	396cm / 13ft
<b>MAX FOOTPRINT</b>		1.4-2.25m / 4ft 7" - 7ft 5"	125 x 175cm / 4ft-5ft 9"	*178cm / 6ft 6"
<b>MAXIMUM DEVICE LOAD</b>		272kg 600lb	300kg 660lb	272kg 600lb
<b>HEAD</b>	<b>TYPE OF HEAD MONO BIPOD</b>	Detachable □ ■	Removable Beam □ -	Detachable □ □
	<b>MAIN LOAD EYES</b>	1 machined eye + 3 hardware pins	2 Shackles + 2 moveable Ring Bolts	3 Rig Plate Eyes + 2 Hardware Pins
	<b>INTEGRATED PULLEY(S)</b>	Option for 4 pinned sheaves	0	Option for 2 pinned sheaves
	<b>LATERAL (GUY) EYES</b>	6 (+optional lash-points)	4	16 (inc 2x lash rings)
	<b>LEG STEP LEG EYE</b>	- □	- -	- □
<b>FEET</b>	<b>HINGED BALL-JOINT DETACH</b>	■ - ■	■ - -	■ - ■
	<b>ANCHOR HOLES SPIKE GRIP</b>	■ ■ ■	■ - -	■ ■ ■
	<b>SIDE RESTRAINT ANCHOR EYES</b>	■ ■	■ ■	■ ■
	<b>LEG RESTRAINTS LEGS LOCK</b>	Webbing & Rope -	Webbing with cam -	Webbing & Rope -
<b>USES</b>	<b>VERTICAL EDGE LUFFING</b>	■ ●	■ -	■ ●
	<b>HOLE CONFINE SHORING</b>	■ ■*	■ ■	■ ●*
<b>STANDARDS</b>		NFPA, EN795B, CEN/TS 16415/B	EN795B, CEN/TS 16415/B	NFPA, EN795B, CEN/TS 16415/B
<b>NOTES</b>		*All components can be purchased separately inc. AZORP rig-head shown (blue) -not in kit. *slight increase in some later models	55cm beam. *not given but a fixed-head quadpod version is £1560/\$1985/€1830	Extra height is with optional extensions. *All components can be purchased separately. *4-8' Beam =max load of 3500-8500lbf depending on length and whether 1 or double tube.
<b>WEBSITE</b>		rockexotica.com cmcpro.com	sarproducts.com	smcgear.com

TYPE: □=MONOPOD ■=BI-POD ■=TRIPOD ■=QUADPOD ■=BEAM/GANTRY ■=TETRAPOD USES: ●●●=OK BUT NOT IDEAL □□=Option

TICK. TICK. TICK. TICK. TICK.

**Do you ever get used to the urgency?** To get to the site. To get to the injured. To get them stable and up and out NOW. Getting the compact grunt you need, to right where you need it, is why we build the Harken Lokhead winch. With two speeds of 14:1 and 40:1 mechanical advantage, and appropriate for 10mm-12.7mm rope, you won't find a more powerful, safer-to-use tool. One turn of the handle and it's clear. This is a revolution in portable mechanical advantage for rescue.

40:1



LEARN MORE ABOUT  
LOKHEAD WINCH KITS

Fire Winch Kit: NFPA-Certified  
Standard Kit : CE-Certified  
Tellumount weighs just 3.2KGs



harken.com

# AI & DRONES

ARTIFICIAL INTELLIGENCE - WHAT DRONES CAN SEE THAT HUMANS CAN'T



by **Charlotte Ina Sterland**

Grand Canyon National Park drone operator in 2020

*[ED: Drones are not just about the flight vehicle and the control interface, the data supplied by the drone needs to be interpreted. For visual imagery you can of course interpret what you see on the screen in real time or scan recorded data for more detailed analysis at lightning speed. Not just as a range of search parameter options like finding a straw-coloured face in a haystack but in sifting all manner of simultaneous data - weather, temperatures, colours, heat, light, terrain and even sound to come up with answers to your questions far, far quicker than a human analyst could on scene. We're not quite there yet in civil terms.*

*Although this article is concerned with drones, in reality, if the software is simply analysing data fed to it - whether by streaming in real time or post-incident from a recorded source, it wouldn't matter whether the data came from a drone, an F35 fighter or a donkey with a GoPro on its head.*

*Drones are so common in rescue that they have become as standard a piece of equipment as a helmet or a radio system, they no longer need to prove their worth, it's more about finding new uses and improving the way they're already used. Drones are already used for all kinds of applications - issue 83 of TECHNICAL RESCUE was discussing rope deployment for swiftwater rescue for instance and as far back as the 90's, before drones existed, we were discussing remotely controlled aerial vehicles as a means to deliver rescue equipment like inflatables or ropes and throwlines. But by far the most common usage today is surveillance - whether that be intelligence gathering, surveying/inspecting or searching for a lost person and this is where AI can definitely help.*

*Our roving reporter Charlotte caught up with Deepak Gaur at Aventior a progressive AI software company based in Boston, USA to discuss SAR-specific aspects of drone use.....]*



**S**AR professionals have been using artificial intelligence software to interpret images from drones which might otherwise be hard to read with the operator's naked eye on a relatively small screen. Using AI software, rescue operators and analysts who are having access issues (be they weather or fire) can gain more information about an area. *Aventior* specialises in software which analyses aerial and satellite images with the specific needs of search and rescue in mind.

Machine learning (use of machines to discover algorithms, not humans) and generative AI (generating media using models) are the rapidly developing fields of data mining behind AI technologies. Their use in image interpretation has changed the way we are able to look at whole landscapes. Mountain Rescue teams are already seeing benefits for rescue operations, but which software is useful, how does it work and how is it best used? Some opt for a camera with inbuilt software like the 'CoprZ;' an IP44 rated camera which can be attached to a drone. There are many other advanced mapping softwares, which are useful for observing wildfires or natural disasters from the air. For search and rescue teams, however, there are more specific requirements, like potentially needing to locate one person on a large rock face from the air, sometimes in bad weather, which is where sophisticated image interpretation can be useful.

Deepak Gaur is lead data scientist at *Aventior*:

### **Why did you create this software?**

Southern California has a terrain which is attractive to hikers and walkers. People take long walks, it's arid and they sometimes get lost: Searchers then need to cover vast areas in the heat. So we wanted to look at how drones could be used for this.

Rescuers tend to fly drones in an area where they detected the person's last cell phone signal. They might cover 100 square km, flying drones and taking pictures. This takes time and effort; so we wanted to see how we could process this quickly.

### **Do you use infrared sensors?**

The person we are looking for might not be alive and waving. So we can't always use infrared (IR) sensors. In arid land, a body might match the surrounding temperature also. Only when we have a temperature differential, can IR be used to detect someone; so, generally, a visual is useful. We have to detect not just human beings in all forms and shapes, but also breadcrumbs; this could be a backpack, or something else. We look for these as well. We made a programme to suit those needs. We tried to run this a few years ago in San Bernardino, California, but the project nose dived because there were not many hikers out during the pandemic.

### **So now there are more crazy hikers? After Covid? So a great time for the software?**

It could be more useful now, yes. The only problem is with vegetation cover; for example the Newline area in California is

highly forested. If we are trying to find someone lost in forest, we can't find them using visuals, so we would need to use IR for that drone. We could use the same models we use for visuals to detect people using IR data, but we haven't really done that. It's a challenge, because it all looks very similar.

### **Is it that fewer people get lost in the woods? Why haven't you Done the IR software yet?**

We haven't pursued that path too far yet. Police and fire would use it, especially units that fly drones, but we haven't marketed that yet. We don't know if there is a market for it or not.

### **Could it be used for avalanches?**

No, it would be for the most lightly covered objects. Someone buried deep in snow; I don't know if there's a technology for that.

### **So for forest, it's more likely to be for police use? More use than in the mountains?**

We can use the same models as for mountains here and apply them to IR data. We don't have to go back to the drawing board: We can use the IR feeds, take frequency in IR and shift the spectrum and make it visual so you or I can see it on the screen. For example we can put everything in blue and yellow: Everything in the IR range we can't perceive with our eyes but machines can. They can ensure things we want to see is put into red and yellow.

For AI we do need data. We generate this ourselves by having people go out in the field. Also we need animals: As we don't want to mix up an animal and a human.

### **Or we might be looking for a dog?**

Typically people get lost on their own. We would not train the platform for someone with a dog. We could look for an animal, thinking someone is lost and it turns out it's a herd of deer. We prefer to put certain basic things like a backpack, a ziplock bag or a jacket on the system. We call these bread crumbs. We capture images of these objects from different angles to train our model so if we find something which looks like a bread crumb; that is a lead. We make that lead a breadcrumb and say 'at this coordinate we identified this breadcrumb.' We can process that as a data feed: That helps us narrow down the search. It could help us concentrate resources to a smaller location.

### **So a drone flew above a shoe on the ground to train the software?**

Yes. We also train it with body parts. People try to go under shade and then we only see part of them, an arm, a torso, which could be in any position, so we trained it to that also. I see a leg, a hand, or someone's back, not actually the whole human form. We train it based on cases within the sample data. We train it on breadcrumbs, partial body, full body, and false positives of animals.

Different terrains have different looks also. Arid land has

bushes, mountains could have rocks and borders. Also shadows need training.

## **Assuming the drone can get through rain, have you trialed the software with this?**

The San Bernardino Valley in California doesn't have much rain. Arid days are when people go out hiking, so we have not trained this software for crazy rain. We can't fly a drone then very easily anyway.



We also can't fly drones above 400 feet. We were training these to get pictures at 200 feet and 400 feet, so there was documentation at the height we flew the drones at.

One challenge for training the software was with the colour of the soil. This creates a contrast with a body. If someone is caucasian or black, they contrast with different coloured soil or rock. If wearing camouflage, it's even harder to find someone. People might wear something sand coloured, which was a challenge, or some things they wear might be heat reflecting, or sun reflecting; a black t-shirt maybe.

## **Shadow is a Challenge?**

Shadow is a challenge. It's a contrast. Hard to detect. Bad weather is too. It might not be rainy or windy, but if it's foggy; it can get difficult. It gets hazy.

We focus on having a defined list of breadcrumbs. If the person carries something unique or different maybe the software could miss it as it's not trained for that.

## **Can the software be used for any drone and any hardware or only matched to one model?**

We don't load the software to the drone: The drone streams it in near real time. Then it gets downloaded, and when it's in a laptop we read into the data stream. The platform can take avi or mp4 footage. If it can create universal video format we can interpret it.

## **Have there been any recent advances in data interpretation and AI which are you particularly excited about at Aventior?**

Using vision algorithms for object detection and tracking has been key. Hyper spectral night vision cameras have also extended operations to night time.

## **Do you have a platform for sharing data?**

We built the platform to run on a laptop. We did not make it on the cloud. When out, there are no comforts of office, no internet, only connection with the drone. We need only to be able to detect it in the field.

It should run on a laptop, and our system should fit into a normal cop car or cruiser.

## **Is it a large system?**

No, it's just a laptop. We control a drone with a controller, and then need to download the software on laptop, which we can interpret. So we can just put the drone and laptop in the cop car. Every cop car (police vehicle) in the US has a laptop. It's a specialised instrument. We don't need to connect to the cloud. We can archive the data where we are.

## **So could the data be sent back from laptop? Could it be shared with a network of computers?**

Yes, the data can be used for all purposes.

## **Do you have a platform so people can instantly share with other colleagues?**

Other cloud storage could be used by colleagues to download data.

## **Are there any other things you are developing? You're looking at infrared?**

We do other work; not just this: We are working on other applications of computer vision. We are applying deep learning to processing images and videos, for safety for example: Is someone wearing a hard hat or not? Or for process efficiency: In a restaurant setting, are ppl getting served on time? Is there a long queue? Any hygiene issues? So, applications of detection which feeds from cctv. We do lots of work in life sciences, like creating digital bio markers, to identify and classify diseases. We make tools to see things; like analysis for radiologists; an assistant on a larger scale. Like search and rescue.

You can find out more about aventior at: <https://aventior.com>

# COMMERCIAL UAV EXPO

SEPT. 3-5, 2024

CAESARS FORUM / LAS VEGAS

## DRONES FOR PUBLIC SAFETY & EMERGENCY SERVICES

- Drones as First Responders
- Collision Scene Reconstruction
- Search & Rescue
- Disaster Response
- Security & Counter Drone



Learn more at  
[expouav.com](http://expouav.com)

## Don't miss out!



**DRONERESPONDERS**

DRONERESPONDERS Public Safety Summit access is included with a full conference pass purchase.



### THE COMMERCIAL UAV EVENT FOR:



Construction



Drone  
Delivery



Energy  
& Utilities



Forestry  
& Agriculture



Infrastructure  
& Transportation



Mining  
& Aggregates



Public Safety  
& Emergency Services



Security



Surveying  
& Mapping

Presented by: **COMMERCIAL  
UAV NEWS**

Official Association Partner: **COMMERCIAL DRONE ALLIANCE**

Produced by Diversified Communications

# Critical Separation for Search and Rescue

by **Roland Curll** **NSW Police Rescue - Australia**

Roland is a 20 year veteran of Police Rescue in NSW Australia responsible for rope rescue, extrication, SAR, trauma-care and swiftwater rescue in the Illawarra region south of Sydney. This huge region incorporates Wollongong, Shellharbour, Port Kembla and Kiama with significant coastal cliffs plus the Upper Nepean river basin with remote bush, forest, canyons and waterways.

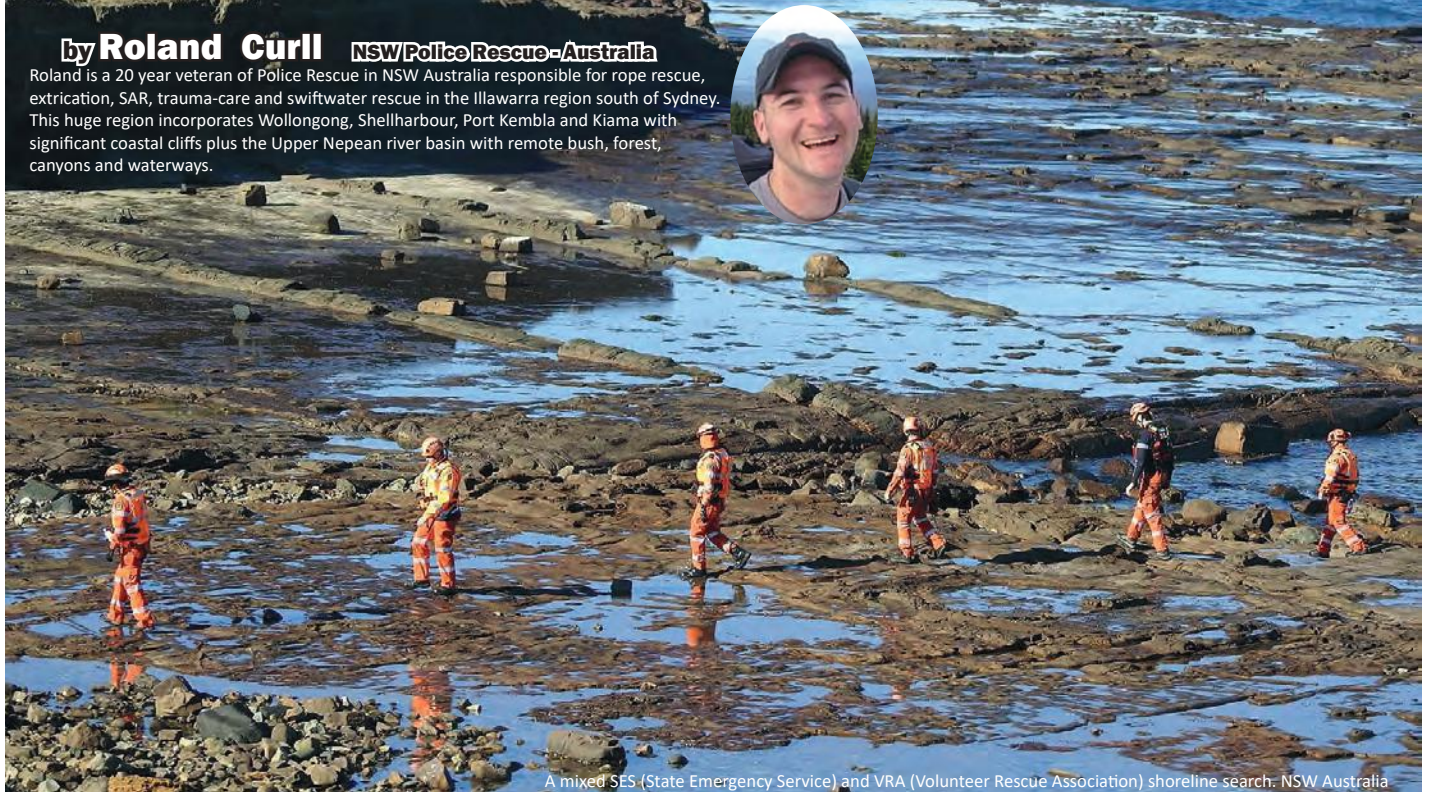

A mixed SES (State Emergency Service) and VRA (Volunteer Rescue Association) shoreline search- NSW Australia

Search techniques for search and rescue have advanced significantly over the years, mainly thanks to advancements in technology but also improved training and better integration of data and analytics. Thermal imaging cameras help detect body heat signatures, even in low visibility conditions. GPS devices enable precise tracking of search teams and aid in navigation and perhaps the two greatest assets, 1) drones that can make better use of the above and which can cover large areas quickly, providing aerial views to assist in locating missing persons must faster. 2) Mobile/Cell phones - not new obviously but as they develop better capabilities and wide coverage they can often give search teams a head start in narrowing the search area.

Geographic Information Systems allows search and rescue teams to analyse and visualize data related to the search area. It helps in creating digital maps, overlaying data layers such as topography, vegetation, and landmarks, and identifying high-probability search areas based on terrain, behavioural patterns and risks/danger-spots.

Search and rescue teams now benefit from improved training programs and standardized procedures. These programs focus

on search techniques, navigation, communication, wilderness survival skills, and utilizing specialized equipment effectively. By ensuring standardized training between teams in the same region or even nationally ensures that search teams can integrate seamlessly in mutual-aid and inter-agency operations.

Overall, the advancements in search techniques for search and rescue have led to increased efficiency, improved safety, and higher success rates in locating missing persons. One such technique is known as Critical Separation, also known as Critical Spacing. This technique has been around for a while, but it allows search teams on the ground to take a systematic approach to a search.

Establishing a systematic approach is crucial in search and rescue operations to ensure comprehensive coverage of the search area and optimise the chances of locating the missing person. This starts by conducting a thorough assessment of the search and considering things like its size, terrain, vegetation, and other relevant characteristics. It also involves identifying any potential obstacles, hazards, or areas of interest that may impact the search strategy. By establishing a systematic approach, search teams can cover the search area



Critical separation demands that the distance between two searchers allows identification of an item or person at the outer limits of peripheral vision. In open terrain that may be several metres but in dense bush like this it may only be a metre or two.

thoroughly, avoid duplication of efforts, and minimise the risk of overlooking potential clues or signs. Using critical separation will ensure a comprehensive coverage of the area without having searchers too close together in a small area

## A BRIEF HISTORY

The Lockerbie disaster, also known as the Lockerbie bombing, refers to the terrorist attack that occurred on December 21, 1988. Pan Am Flight 103, a transatlantic passenger flight traveling from London Heathrow Airport to John F. Kennedy International Airport in New York City, was destroyed by a bomb mid-air, causing the plane to crash into the town of Lockerbie, Scotland. The explosion occurred approximately 38 minutes after take-off, causing the aircraft to break apart in mid-air. Debris from the plane fell onto Lockerbie. The bombing was later determined to be an act of terrorism and remains one of the deadliest acts of terrorism in the United Kingdom's history and had a significant impact on international aviation security. After the Lockerbie disaster, several search techniques were employed to locate evidence and gather information related to the bombing.

A significant portion of the debris from the destroyed aircraft fell on the town of Lockerbie and the surrounding areas. Investigators conducted a thorough ground search to collect wreckage, personal belongings, and other evidence scattered over a wide area. This involved combing through fields, streets, and buildings to gather pieces of the aircraft and identify potential evidence. To ensure a systematic approach, the search teams divided the affected areas into a grid system. Each section was assigned to specific search teams, enabling them to methodically cover the designated areas. This helped in ensuring that no debris or evidence was overlooked.

The ground search was a challenging task, requiring coordination between various agencies, volunteers, and law enforcement personnel. The thorough and systematic approach helped ensure that crucial evidence was collected, preserving valuable information that was instrumental in the subsequent investigation and prosecution of those perceived at that time to be responsible for the Lockerbie bombing.

The focus of the ground search was to locate and collect debris and evidence rather than adhering to a specific separation distance between search team members, 'critical separation' provided a more systematic approach.

## HASTY SEARCHING

A hasty search, also known as a quick search or rapid search, is a search technique used in search and rescue operations to quickly cover a large area or to make an initial assessment of a search area. It is typically conducted when there is limited time available or when there is a need to gather immediate information about the location or condition of a missing person or a specific area.

In a hasty search, search teams move swiftly through the



designated search area, scanning for any visible signs or evidence of the missing person or any indications of their presence. The primary objective is to cover as much ground as possible in a short amount of time, rather than conducting a detailed and thorough search.

Hasty searches are often conducted in the early stages of a search operation to establish initial situational awareness, identify potential clues or indicators, and narrow down the search area. It allows search teams to quickly determine areas of higher probability for further focused search efforts. Critical separation technique could be used in this situation, but a hasty search is not intended to replace or substitute for a more comprehensive and systematic search. Instead, it serves as a preliminary step to gather initial information and guide subsequent search efforts. Once initial information is obtained, search teams can transition into more thorough search techniques, to systematically cover the designated area and locate the missing person.

Hasty searches require search team members to be observant, make quick decisions, and prioritize areas for further search based on the information gathered. They provide a rapid assessment of the search area and help direct resources effectively in a time-sensitive situation.

## TYPE 2 SEARCH

In a Type 2 search, critical separation can be utilized as a technique to maintain a specific distance between search team members while conducting a focused and targeted search in the designated area. Critical separation ensures that search team members cover the area effectively and minimize the risk of missing potential clues or evidence. Based on the specific conditions of the search area, such as terrain, vegetation, or visibility, an appropriate critical separation distance is determined. This distance allows team members to maintain visual contact and communicate effectively while ensuring adequate coverage. Search team members maintain constant communication with each other to stay aware of their locations and progress. This can be achieved through verbal communication, hand signals, or the use of communication

devices, depending on the circumstances.

The search area may be divided into sectors or assigned areas for each team member. Critical separation ensures that each team member covers their assigned sector without overlap or gaps, thereby maximizing the search efficiency. Depending on the nature of the search area, specific search techniques may be employed, such as line searches, or sector searches. Critical separation is maintained while applying these techniques, allowing team members to methodically cover the targeted area.

Critical separation in a Type 2 search helps ensure that the search area is thoroughly and efficiently covered by maintaining an appropriate distance between team members. It enhances coordination, minimizes the risk of missing potential evidence or clues, and facilitates effective communication among search team members. Ultimately, critical separation is a valuable technique that contributes to the overall success of a focused and targeted search effort in a Type 2 search.

### APPLYING CRITICAL SEPARATION

In critical separation, search team members maintain a consistent and predetermined distance from each other as they move through the search area. This spacing is typically determined based on the nature of the scene, the size of the search team, and the specific objectives of the search. By maintaining critical separation, investigators can maximize the likelihood of detecting and documenting evidence. It helps ensure that no areas are overlooked or double-searched, reducing the chances of missing crucial information or physical evidence.

In the context of search and rescue operations for locating missing persons, the technique of critical spacing is often applied to ensure a systematic and thorough search of the designated area. Before initiating the search, search and rescue teams create a search plan that includes dividing the search area into manageable sections. These sections are assigned to different teams or individuals responsible for conducting the search.

The specific distance or spacing considered "critical" will vary depending on the circumstances and the type of search being conducted. Different organizations or agencies may have their own guidelines or protocols for determining the appropriate critical spacing in different scenarios. This is further determined based on factors such as the terrain, vegetation, weather conditions, available resources, and the type of search operation. The goal is to strike a balance between covering a sufficient area and maintaining effective communication and visual contact between team members.





## PROBABILITY OF DETECTION

The probability of detection (POD) is a metric used in search and rescue operations to estimate the likelihood of successfully detecting a target or finding a missing person during a search effort. It represents the probability that the search operation will identify and locate the individual or target of interest. The probability of detection can be influenced by various factors, including search techniques, resources, environmental conditions, search area characteristics, and the capabilities of the search teams involved. It is important to note that the probability of detection is not a fixed value and can vary depending on the specific circumstances of each search operation.

To determine the probability of detection, search planners and analysts consider factors such as the search area's size, terrain, and accessibility, as well as the effectiveness of the chosen search methods and available resources. Historical data, statistical models, and experience from past search operations can also be used to estimate the probability of detection. Ultimately, the goal in search and rescue operations is to maximize the probability of detection while balancing other factors such as safety, resource allocation, and time constraints. By continuously evaluating and refining search strategies based on real-time feedback and data analysis, search teams aim to optimize their efforts and increase the chances of successfully locating missing persons or targets.

Critical separation and probability of detection are related in the sense that maintaining an appropriate critical separation distance between search team members can impact the overall probability of detection in a search operation. Critical separation plays a role in the probability of detection by ensuring adequate coverage of the search area and minimizing the risk of missing important clues or evidence. By maintaining appropriate critical separation, search team members can cover a larger area effectively and minimize the chance of overlooking potential clues or the target itself. This comprehensive coverage increases the probability of detecting the missing person or the objective of the search. Critical separation helps avoid overlapping search efforts, where multiple team members search the same area simultaneously, or leaving gaps in the search area where no coverage occurs. Both overlap and gaps can decrease the probability of detection. When team members are adequately spaced, they can observe the search area more effectively. This increases the chances of detecting subtle signs or indicators of the missing person's presence.

The efficient allocation of resources is crucial for maximizing the probability of detection. By maintaining critical separation, search teams can optimize the use of personnel and equipment, minimizing the risk of redundant search efforts and allowing resources to be distributed effectively across the search area. The effective coordination of the search effort collectively influences the probability of successfully locating the missing person or target in a search and rescue operation.



## THE NORTHUMBERLAND RAIN DANCE

Conducting critical separation in a search operation involves maintaining a specific distance between search team members to ensure effective coverage and minimize the risk of missing important clues or evidence. Here's an outline of the steps to conduct critical separation, which is also referred to as the Northumberland Rain Dance:

- Determine appropriate spacing by consider factors such as terrain, visibility, search area characteristics, and resources available. For example, if you are going to search in thick bushland, go into the thick bushland to determine the appropriate spacing instead of trying to determine appropriate spacing standing out on a road.
- Use on object of similar size to determine appropriate spacing. For example, when searching for a person, another person could be used as a reference tool or perhaps a large backpack. Place the backpack on the ground between two search team members, the two search team members move away from the backpack until it is just within view and can still be identified as a backpack (if it just looks like a coloured blur then you are too far away). The distance between the two searchers is the **Critical Separation**.
- To ensure this is accurate the two search team members walk around the backpack to confirm the distance.
- Determine the search pattern or technique to be used (e.g., line search, sector search, spiral search) based on the characteristics of the search area and objectives.
- Ensure all team members understand and are familiar with the chosen search pattern.
- Each search team member should maintain visual contact with adjacent team members, whenever possible.
- Remain observant while conducting the search, scanning the search area for any signs or evidence related to the missing person or target.
- Continuously assess the effectiveness of the current critical separation distance and adjust as needed
- Consider modifying the spacing based on the progress of the search, changing environmental conditions, or specific circumstances encountered.

Remember that the specific procedures and guidelines for conducting critical separation may vary depending on the search organization, the nature of the search area, and other operational considerations. Clearly, a missing person search will be different to an evidence search. A misper search can have differential searching where thickets of vegetation for instance demand more attention than a clear open space that obviously does not contain a missing person (though you still need to be aware of holes and hollows in what might look like a clear, flat area). Follow the protocols and instructions provided by the relevant authorities and adapt them to the specific circumstances of the search operation. Assess the visibility conditions within the search area, such as fog, low light, or dense foliage. Poor visibility may require closer spacing to ensure visual contact between team members. In adverse weather, such as heavy rain or snowfall, closer spacing may be needed to compensate for reduced visibility and

communication range.

It's important to strike a balance between maintaining an appropriate spacing for effective coverage and ensuring the safety of search team members. Close spacing may facilitate communication and visual contact. Wider spacing allows for more independence but may result in gaps in coverage. Considerations may vary depending on the specific search operation, organization, or the search environment. It is crucial to adapt the spacing based on the circumstances and the judgment of the search team leader, who should have a comprehensive understanding of the search objectives and operational conditions.

Adapt the spacing based on the specific dynamics of the search area. For instance, if certain areas require more detailed searching or have higher probabilities of locating the missing person, the spacing can be adjusted to concentrate efforts in those areas. Regularly discuss spacing and any concerns or suggestions for adjustment.

Continuously assess the safety of search team members, if hazards or risks are encountered during the search, re-evaluate the spacing to ensure the safety of team members. Adjust spacing to accommodate the strengths and limitations of individual team members, ensuring that spacing allows for sustained effectiveness throughout the search operation. Remember that the adjustment of spacing should be done in consultation with the search team leader and in consideration of the overall search objectives, operational conditions, and safety considerations. Flexibility and adaptability are key in responding to changing circumstances and optimizing the search effort to increase the probability of detecting the missing person or target.

## PURPOSEFUL WANDERING



As mentioned earlier, some areas demand more attention and closer searching than others. While searching, wander along in a purposeful manner, stopping regularly to look around and more closely inspecting the most likely spots. Adjust as terrain changes. This is referred to as 'Purposeful Wandering'. Searching by wandering forward in a purposeful manner is a search technique commonly employed in search and rescue operations, especially in situations where the search area is relatively open and lacks specific search patterns or guidance.

Here's an expansion on this technique:

- Before starting the search, conduct an initial assessment of the search area, taking note of any known information about the missing person, potential hazards, or areas of interest.
- Determine the general direction or area to begin the search based on available information, such as last known location, witness accounts, or intelligence gathered.
- Ensure effective communication among search team members before initiating the search. Establish communication protocols and frequencies to maintain contact and exchange information during the search.
- Begin the search by moving forward in a deliberate and purposeful manner.
- Maintain a steady pace while continuously scanning the surroundings for any signs, clues, or indicators related to the missing person's presence.
- Maintain your critical separation between search team members to maximize coverage while ensuring visual contact and communication.



- As the search progresses, concentrate on areas that appear more promising based on the information gathered or any emerging patterns or leads.
  - Adjust the search direction or expand the search area based on new information or developments during the search operation.
  - Remain flexible and adapt the search approach based on changing conditions, emerging information, or specific search objectives.
- Searching by purposeful wandering allows search teams to cover a broad area, systematically scan the surroundings, and actively seek out potential clues or signs of the missing person's presence. By maintaining focus, communication, and adaptability, this technique contributes to an efficient and effective search operation.

## ADVANCEMENTS IN SEARCH AND RESCUE

Critical separation plays a significant role in the advancements of search and rescue operations. As technology, techniques, and practices have evolved, the importance of maintaining critical separation has become increasingly recognized. Advancements in search and rescue have placed a strong emphasis on the safety of search team members. Critical separation helps mitigate risks and hazards by ensuring adequate spacing between team members.

Advancements in communication technology have enhanced the ability to maintain effective communication among search team members. Critical separation ensures that team members can maintain visual contact and communicate important information, such as findings, observations, or changes in the search plan, more efficiently.

Integration of advanced communication systems, such as two-way radios, GPS tracking, or mobile apps, has further facilitated coordination while adhering to critical separation guidelines. Advancements in resource management and utilization have led to more efficient search and rescue operations. By maintaining critical separation, resources, such as personnel, equipment, and search assets, can be optimally allocated to cover a larger search area while minimizing redundancy. This optimization of resources allows search teams to conduct searches more effectively and increases the probability of detecting the missing person or target.

Advancements in data analysis techniques and technology have improved search planning and decision-making processes. Critical separation data, along with other search metrics, can be collected, analysed, and utilized to optimize search strategies, improve resource allocation, and enhance the probability of detection. Advanced search algorithms and modelling tools can incorporate critical separation as a parameter to guide search planning and increase operational efficiency. Advancements in search and rescue have emphasized the importance of standardized training and protocols. Critical separation is now included as a key component of search and rescue training programs to ensure consistency and adherence to best practices across different search teams and organizations. Standardized training helps search team members understand the significance of critical separation, its relationship to safety and communication, and its impact on the overall effectiveness of search operations. Overall, critical separation has evolved as a core principle within search and rescue advancements, contributing to safer operations, improved coordination, optimal resource utilization, and enhanced search effectiveness. As search and rescue practices continue to advance, the understanding and application of critical separation will likely remain integral to the field.

**rock exotica**  
GEAR FOR THE Z AXIS

# AZTEK | SYSTEM

- Switches from 4:1 to 5:1 with a change of direction.
- Color-coded prusiks are rope friendly and can be released under light tension.
- Use AZTEK for pick off, load release hitch, high-directional guylines, litter attendant tether, litter scoop, edge restraint and much more.
- AZTEK System length ranges from just 9" to over 13'.
- Features high-efficiency ball bearings and machined aluminum parts.

AZTEK Kit includes:  
AZTEK PULLEYS  
6mm PRUSIKS (2)  
50' 8mm STATIC CORD  
44' 6mm PURCELL PRUSIK CORD  
PRO OR STANDARD BAG

COLOR CODED



EDGE RESTRAINT



LOW TENSION RELEASE



50' CORD LENGTH



SWIVEL CONNECTION

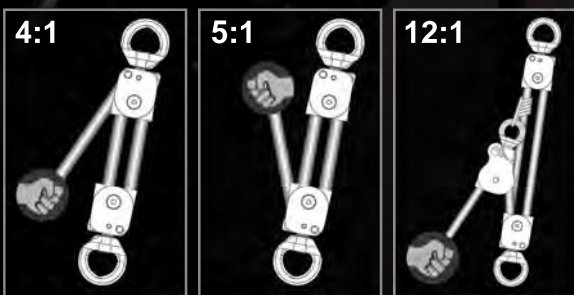

The AZTEK kit can be configured as a 4:1, 5:1 or 12:1 with the use of an additional pulley.

MIN LENGTH  
9" (22.8cm)

< WIDE RANGE OF OPERATION >

MAX LENGTH  
13' (4m)



## MOVE QUICKLY. PLAN CAREFULLY. RIG UNIDEXTEROUSLY.

You have worked hard to get here...to a situation where you have one hand available to begin getting someone out. So get started. Pivot then press Apex's thumb lock. In the same motion and without looking, swing the side-plate open. Swing back and, "click" it relocks – anywhere in your rigged system. It's a solution so well devised just one question remains: What can you take on with the other hand?



WATCH THE APEX  
IN ACTION NOW.

For ropes 11-13mm

APEX Swivel: NFPA CE UKCA

APEX Direct: CE UKCA

**Made In USA**



smcgear.com