



Our home's best for yours



En Sauvic ofrecemos lo mejor de nuestra casa para todos los hogares. Productos de diseño funcional fabricados con la máxima calidad.

In Sauvic we offer the best of our house for all households. Functional design products manufactured with the highest quality.







Sauvic nació de la fusión de dos pequeñas empresas dedicadas a la fabricación de tendederos, escurrer platos y ratoneras.

A principios de los 90 juntaron todo su know-how para fundar la actual empresa y ofrecer una gama de productos más extensa, de calidad y duradera.

Nuestras instalaciones en Manlleu, abarcan una superficie de más de 3.500 m². Allí se encuentran las cuatro naves dónde fabricamos los productos de acero, acero inoxidable, aluminio y madera, las oficinas y un gran almacén. Con tal de garantizar un servicio rápido y eficaz, invertimos en stock, tanto de materia prima como de producto final.

En Sauvic nos preocupamos por el planeta y, por esa razón, llevamos a cabo acciones sostenibles con el propósito de reducir nuestro impacto: utilizamos energías renovables y disminuimos el uso del papel. Además, la mayoría de nuestros productos evitan el uso de energía y dejan que la madre naturaleza haga su función: tendederos, escurrer platos...

En la actualidad, nuestro negocio traspasa fronteras nacionales y estamos presentes por toda Europa, exportando y participando en las ferias internacionales más importantes del sector.

¿Por qué escogernos?

Con los productos Sauvic ofrecerás a tus clientes calidad, durabilidad, proximidad y un gran abanico de opciones. Proporcionarás artículos que cumplirán sus expectativas a largo plazo.

Además, gracias a nuestro gran stock disponible, tenemos la capacidad de ofrecerte un servicio inmediato y ágil.



Sauvic was born from the fusion of two small companies dedicated to the manufacture of clothes airers, dish drainers and mousetraps.

In the early 90's they gathered all their know-how to establish the current company and offer a wider range of products, according to quality and duration.

Our facilities in Manlleu cover an area of more than 3,500 m². In that area, there are the four warehouses where we manufacture steel, stainless steel, aluminum and wood products; the offices and a large warehouse. In order to guarantee a fast and efficient service, we invest in stock, both raw material and final product.

In Sauvic we care about the planet, and, for that reason, we carry out sustainable actions with the aim of reducing our impact: we use renewable energy, and we reduce the use of paper. In addition, most of our products avoid the use of energy and let Mother Nature do her job: clothes airers, dish drainers...

Currently, our business crosses national borders and we are present throughout Europe, exporting and participating in the most important international fairs in the sector.

Why should you choose us?

With Sauvic products you will offer your customers quality, durability, proximity, and a wide range of options. You will provide items that will accomplish their long-term expectations.

In addition, due to our available large stock, we could offer you an immediate and agile service.



Fabricando productos de calidad desde 1980

Manufacturing quality products since 1980



En Sauvic llevamos más de 30 años fabricando artículos de acero, acero inoxidable, aluminio y madera para el hogar y el jardín.

In Sauvic we have been manufacturing steel, stainless steel, aluminum and wood products for the home and garden for over 30 years.

Nuestros productos son 100% locales: están elaborados con materias primas de proximidad y de gran calidad. Durante todo el proceso de fabricación, nuestro equipo vela para que sea realizado con el máximo cuidado posible. Al final de la cadena de producción, todos los artículos pasan por un control exhaustivo de calidad para garantizar que estos están listos para salir al mercado con las mejores condiciones.

Our products are 100% local: they are made with local raw materials and high quality. Throughout the entire manufacturing process, our team ensures that it is carried out with the greatest possible care. At the end of the production chain, all items go through a thorough quality control to ensure that they are ready to go on the market under the best conditions.

Todo eso nos permite ofrecer una gama de artículos funcionales y de diseño de alta calidad a un precio competitivo.

All of this allows us to offer a range of functional and high-quality design items at a competitive price.



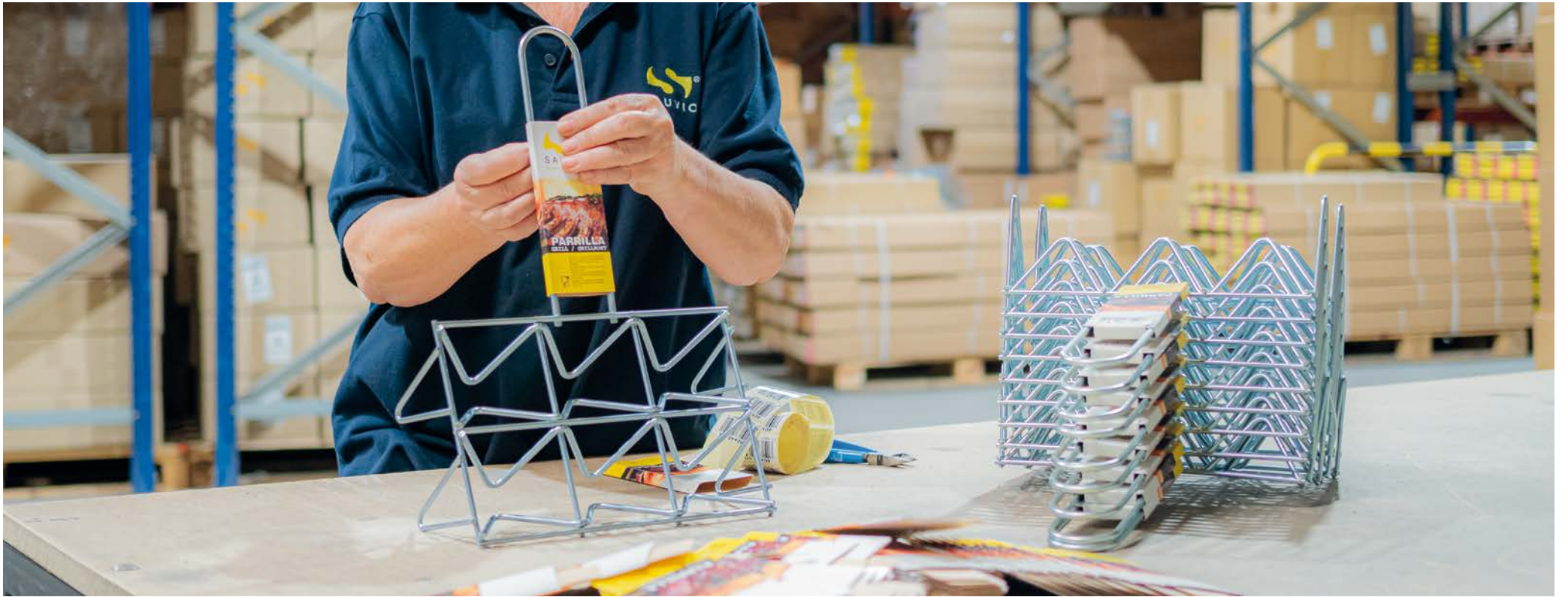



Un pequeño gran equipo

Sauvic es una familia. Cada miembro del equipo es una parte fundamental del engranaje. Grandes profesionales que llevan mucho tiempo trabajando para la empresa y ponen todo su esfuerzo para que todo salga rodado.

Además, contamos con el respaldo de una red comercial de más de 20 comerciales repartidos por España y Europa.

Somos dedicación, trabajo en equipo y compromiso.

A great little team

Sauvic is a family. Each team member is a fundamental part of the gear. Great professionals who have been working for the company for a long time put all their effort to make products and company work.

We also have the support of a commercial network of more than 20 commercials spread across Spain and Europe.

We are dedication, teamwork and commitment.







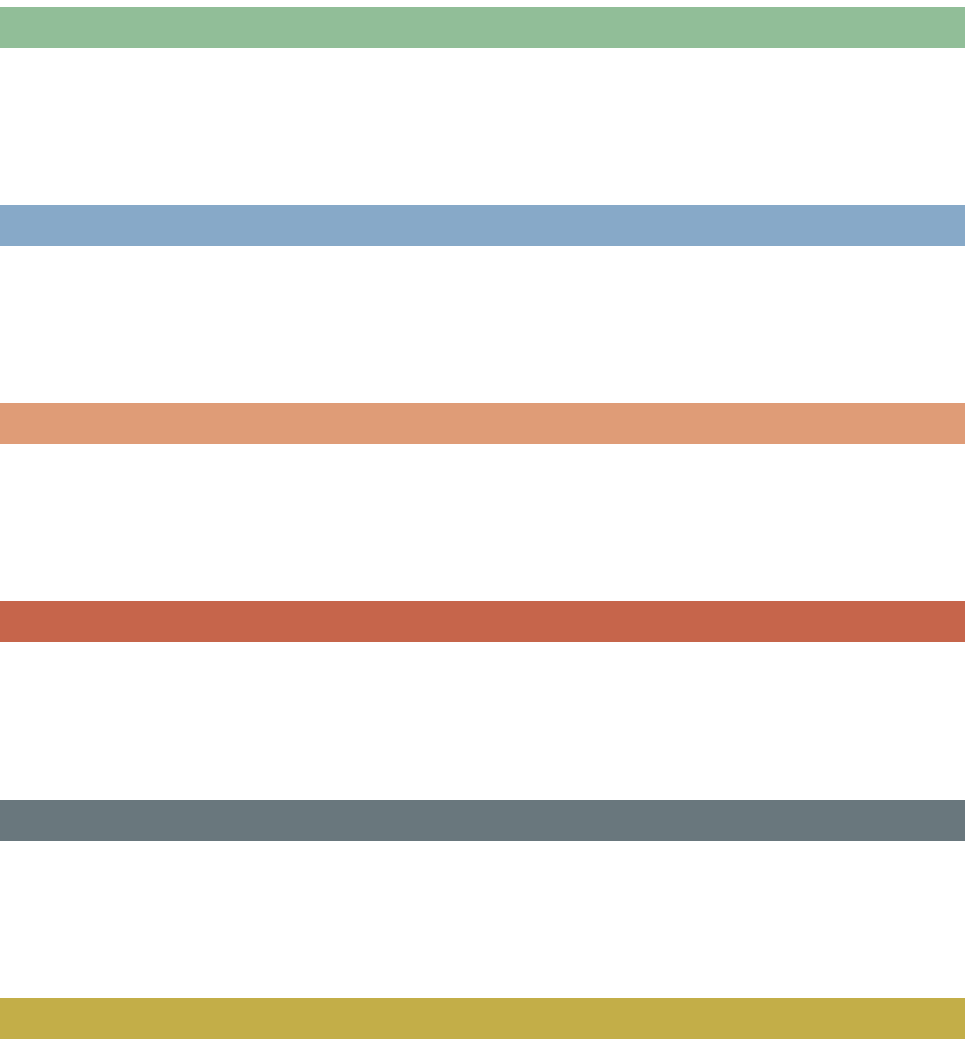

12 **Tendederos**
Clothes airers

28 **Escurreplatos**
Dish drainers

52 **Menaje**
Household items

68 **Parrillas y BBQ**
Grills and BBQ

96 **Jardín**
Garden

112 **Ratoneras**
Mouse traps





Tendederos

Clothes airers

Nuestros tendederos son un clásico. Gracias al uso de materiales de gran calidad como el acero inoxidable 18/10, la aleación de aluminio inoxidable o el plastificado, estos tendederos son resistentes a los cambios de temperatura y a los rozamientos, además de ser productos muy duraderos.

Sus diseños únicos los convertirán en un imprescindible en cada hogar.

Our clothes airers are a classic. Thanks to the use of high-quality materials such as 18/10 stainless steel, stainless aluminum alloy or steel with anti-corrosive plastic coating, clothes airers are resistant to temperature changes and friction, in addition to being very durable products.

Their unique designs will make them a must in every home.

Tendedero extensible plastificado blanco

Extendable clothes airer with white plastic-coated steel

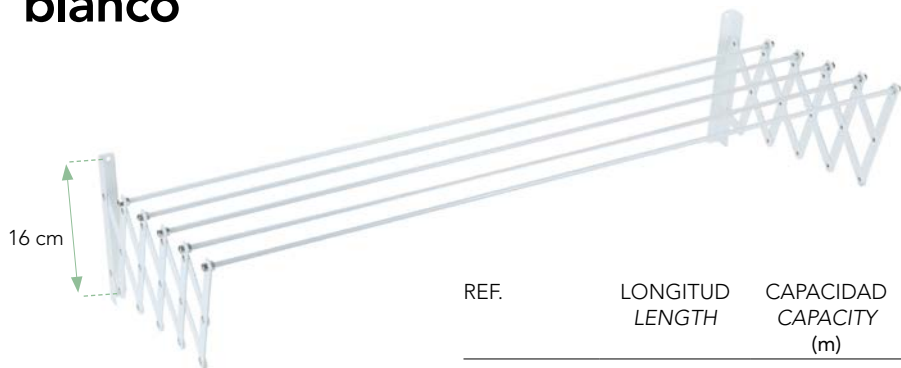

MATERIAL
MATERIAL
Acero con 0,5 mm de recubrimiento plástico anticorrosivo blanco.
Steel with 0,5 mm white anti-corrosive plastic coating.

ANCHO ABIERTO
OPEN WIDTH
78 cm

ANCHO CERRADO
CLOSED WIDTH
13,5 cm

RETRACTILADO
SHRINK-WRAPPING

3 U./PACK

REF.	LONGITUD LENGTH	CAPACIDAD CAPACITY (m)
89788	70	3,5
89791	80	4
89793	90	4,5
89796	100	5
89798	110	5,5
89801	120	6
89803	130	6,5
89806	140	7
89808	150	7,5
89811	160	8
89813	170	8,5
89816	180	9

Esta cobertura ofrece una protección duradera frente a la corrosión, los golpes y rasguños, inclemencias del tiempo y demás agentes contaminantes.

This cover offers long-lasting protection against corrosion, bumps and scratches, bad weather and other contaminating agents.

Material para su instalación incluido (tornillería y tacos).
Material for its installation included (rust-proof screws and plugs).

Tendedero extensible de aluminio

Aluminium extendable clothes airer

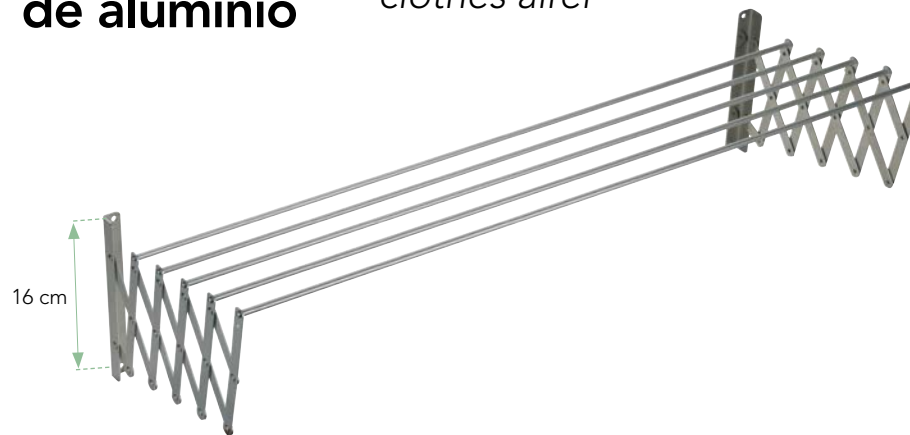

MATERIAL
MATERIAL
Aleación aluminio inoxidable.
Aluminium alloy.

ANCHO ABIERTO
OPEN WIDTH
78 cm

ANCHO CERRADO
CLOSED WIDTH
13,5 cm

RETRACTILADO
SHRINK-WRAPPING

3 U./PACK

REF.	LONGITUD LENGTH	CAPACIDAD CAPACITY (m)
90825	80	4
90827	90	4,5
90830	100	5
90833	110	5,5
90835	120	6
90837	130	6,5
90840	140	7
90843	150	7,5
90845	160	8



Varillas recortables.
The rods can be easily cut to size.

Material para su instalación incluido (tornillería inoxidable y tacos).
Material for its installation included (stainless steel screws and plugs).

Plastificado

En Sauvic apostamos por el plastificado porque ofrece una mayor resistencia a los productos. Con este proceso adquieres una capa de más de 0,5 mm de cobertura plástica anticorrosiva, protegiendo así el producto de posibles golpes y rasguños, inclemencias del tiempo y otros agentes contaminantes.

¿Qué diferencia hay entre el proceso de plastificado y el de pintado? En el proceso de pintado, la pintura epoxy se aplica sobre la pieza en frío y después se calienta para que se adhiera. En cambio, en el proceso de plastificado, la pieza se precalienta a 350 °C, se sumerge en plástico en polvo en suspensión, donde coge una capa más gruesa de material y una vez la pieza se enfría, se vuelve a calentar para que la capa se adhiera uniformemente, aportándole un mayor grado de resistencia.

Plastic coating

In Sauvic we are committed to plastic coating because it offers greater resistance to products. With this process you acquire a layer of more than 0.5 mm of anti-corrosive plastic cover, thus protecting the product from possible shocks and scratches, inclement weather, and other polluting products.

What is the difference between the plastic coating process and the painting process? *In the painting process, the epoxy paint is applied on the cold part and then heated to adhere, whereas in the plastic coating process the piece is preheated to 350°C, immersed in suspended plastic powder, where it takes a thicker layer of material and once the product is cooled, it is heated again so that the layer adheres evenly, giving it a greater degree of resistance.*





Tendedero extensible de acero inoxidable 18/10

18/10 Stainless steel extendable clothes airer



MATERIAL
MATERIAL

100% acero inoxidable 18/10 (AISI 316).
100% Electropolished (AISI 316)
18/10 stainless steel.



ANCHO ABIERTO
OPEN WIDTH

↔ 78 cm



ANCHO CERRADO
CLOSED WIDTH

↔ 13,5 cm



RETRACTILADO
SHRINK-WRAPPING



3 U./PACK

REF.	LONGITUD LENGTH	CAPACIDAD CAPACITY (m)
90795	100	5
90800	120	6
90805	140	7
90810	160	8
90815	180	9

Material para su instalación incluido (tornillería inoxidable y tacos).
Material for its installation included (stainless steel screws and plugs).



Acero inoxidable

En Sauvic utilizamos el acero inoxidable 18/8 (AISI 304) para fabricar la mayoría de nuestros productos. Con una resistencia mecánica de 60 kg/mm² y una dureza de 175-200 HB, tolera bien el calor hasta 400 °C y es resistente a la corrosión. En algunos tendederos utilizamos también el acero inoxidable 18/10 (AISI 316), dando un poco más de resistencia y calidad al producto.

Este tipo de material, también utilizado para fabricar nuestras parrillas y barbacoas, nos garantiza los requisitos necesarios para el contacto alimentario.

Para conseguir el acabado brillante y limpio, todas las piezas son electropulidas. El electropulido es un tratamiento superficial que se realiza mediante un proceso electrolítico por disolución anódica de la superficie metálica a tratar, produciendo una nivelación del material base que permite mejorar las propiedades del acero inoxidable.

Stainless steel

In Sauvic we use 18/8 stainless steel (AISI 304) to manufacture most of our products. With a mechanical resistance of 60 kg/mm² and a hardness of 175-200 HB, it tolerates heat well up to 400 °C and is resistant to corrosion. In some clothes airers we also use 18/10 stainless steel (AISI 316), giving a little more resistance and quality to the product.

This type of material, also used to make our grills and barbecues, guarantees us the necessary requirements for food contact.

To achieve the bright and clean finish, all parts are electropolished. Electropolishing is a surface treatment that is carried out by an electrolytic process by anodic dissolution of the metal surface to be treated, producing a levelling of the base material that allows improving the properties of stainless steel.



Tendedero extensible de acero inoxidable con 10 varillas de aluminio

Stainless steel clothes airer with 10 aluminium rods

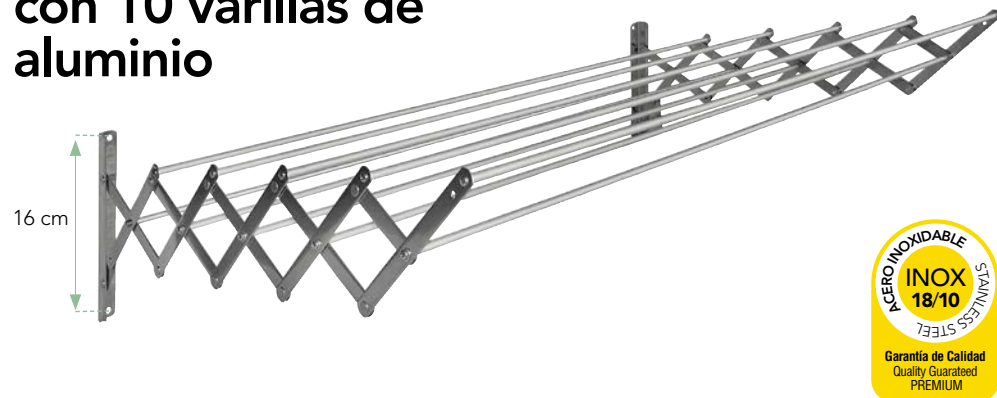

MATERIAL
Flexo de acero inoxidable 18/10 (AISI 316) y varillas de aluminio. Electropolished (AISI 316) 18/10 stainless steel strap and aluminium rods.

ANCHO ABIERTO
OPEN WIDTH
78 cm

ANCHO CERRADO
CLOSED WIDTH
13,5 cm

RETRACTILADO
SHRINK-WRAPPING

2 U./PACK

REF.	LONGITUD LENGTH (m)	CAPACIDAD CAPACITY (m)
90852	80	8
90855	100	10
90860	120	12
90865	140	14
90870	160	16

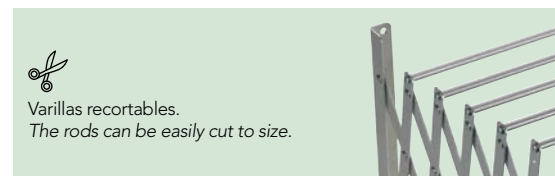

Varillas recortables.
The rods can be easily cut to size.

Material para su instalación incluido (tornillería inoxidable y tacos).
Material for its installation included (stainless steel screws and plugs).

Tendedero extensible plastificado con 10 varillas de aluminio

White plastic coated extendable clothes airer with 10 aluminium rods



MATERIAL
Flexo de acero con 0,5 mm. de recubrimiento plástico anticorrosivo y varillas de aluminio. Steel with 0,5 mm. anticorrosive plastic coated strap and aluminium rods.

ANCHO ABIERTO
OPEN WIDTH
78 cm

ANCHO CERRADO
CLOSED WIDTH
13,5 cm

RETRACTILADO
SHRINK-WRAPPING

2 U./PACK

REF.	LONGITUD LENGTH (m)	CAPACIDAD CAPACITY (m)
89755	80	8
89760	100	10
89765	120	12
89770	140	14
89775	160	16

Esta cobertura ofrece una protección duradera frente a la corrosión, los golpes y rasguños, inclemencias del tiempo y demás agentes contaminantes.

This cover offers long-lasting protection against corrosion, bumps and scratches, bad weather and other contaminating agents.

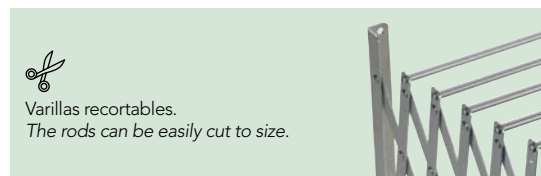

Varillas recortables.
The rods can be easily cut to size.

Tendedero extensible de aluminio con 10 varillas de aluminio

Aluminium extendable clothes airer with 10 rods



MATERIAL
MATERIAL
Aleación de aluminio inoxidable.
Aluminium alloy.

ANCHO ABIERTO
OPEN WIDTH
78 cm

ANCHO CERRADO
CLOSED WIDTH
13,5 cm

RETRACTILADO
SHRINK-WRAPPING

2 U./PACK

REF.	LONGITUD LENGTH	CAPACIDAD CAPACITY (m)
90846	80	8
90847	100	10
90848	120	12



Varillas recortables.
The rods can be easily cut to size.



Expositor para tendederos extensibles

Display stand for extendable clothes airers



CAJA
BOX

1 U./PACK

REF.	LONGITUD LENGTH
90900	68x56x80

PROMOCIÓN

Expositor de regalo con la compra de 1400 € en tendederos extensibles o comprando el expositor y descontando un 10% del importe de tendederos extensibles en cada factura hasta llegar al total.

PROMOTION

Display stand for free with a purchase of 1400 € in extendable clothes airers or buying this display stand and discounting a 10% in every invoice until the total cost.



Tendedero SISI plastificado blanco

White plastic-coated
steel Sisi clothes
airer

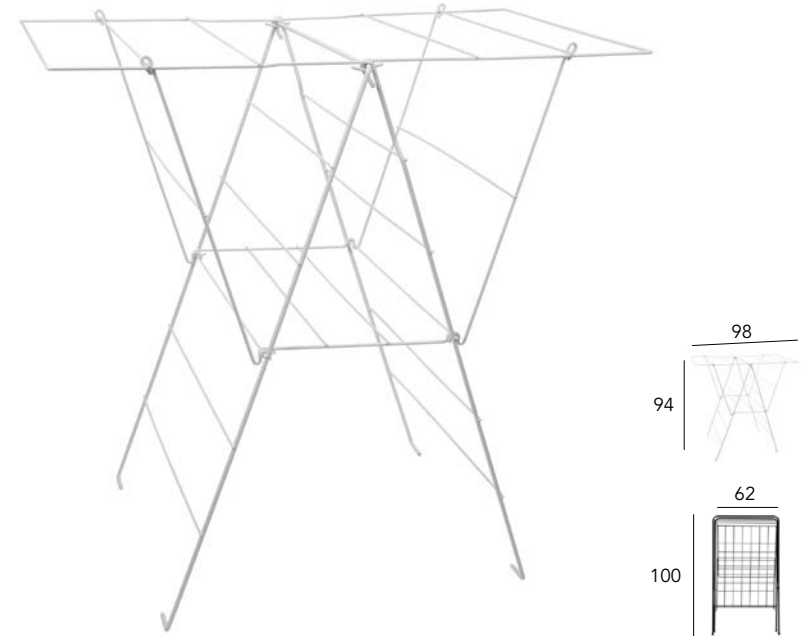

MATERIAL MATERIAL

Acero con 0,5 mm. de
recubrimiento plástico
anticorrosivo blanco.
Steel with 0,5 mm. white anti-
corrosive plastic coating



RETRACTILADO SHRINK-WRAPPING



3 U./PACK

REF.

CAPACIDAD
CAPACITY
(m)

88844

15

Ideal para colgar ropa pequeña
en las múltiples varillas que
tiene en toda la estructura.
Totalmente plegable.

*Ideal for hanging small clothes
on the many rods throughout
the structure.
Fully collapsible.*

Esta cobertura ofrece una
protección duradera frente
a la corrosión, los golpes y
rasguños, inclemencias del
tiempo y demás agentes
contaminantes.

*This cover offers long-lasting
protection against corrosion,
bumps and scratches,
bad weather and other
contaminating agents.*

Tendedero de balcón extensible plastificado blanco

White plastic-coated
steel extendable
balcony clothes airer

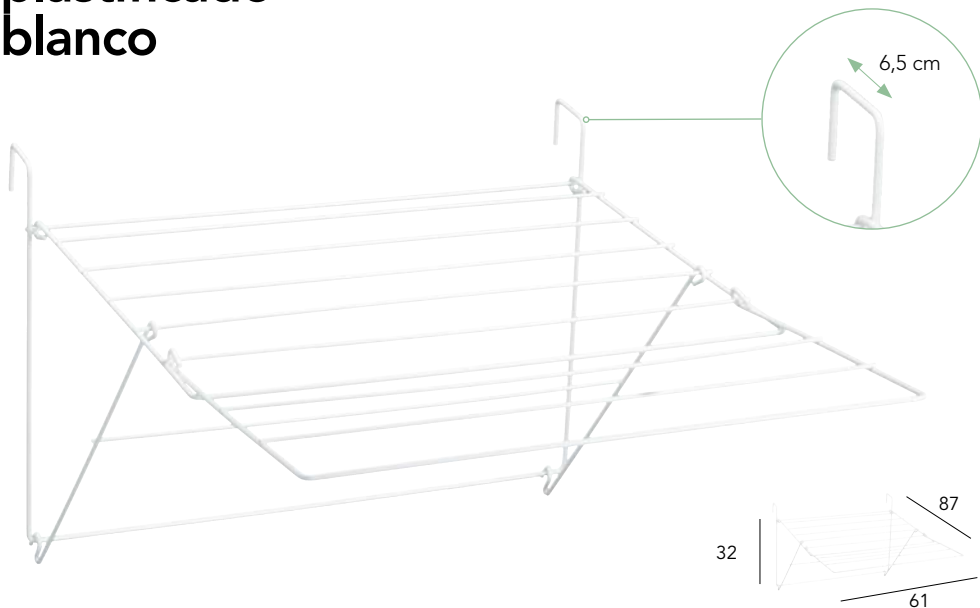

MATERIAL
MATERIAL

Acero con 0,5 mm. de recubrimiento plástico anticorrosivo blanco.
Steel with 0,5 mm. white anti-corrosive plastic coating

REF.

88827

CAPACIDAD
CAPACITY
(m)

6

Posición de tender a la altura de la barandilla.
Totalmente plegable.

Hanging out position at the height of the railing.
Fully collapsible.



RETRACTILADO
SHRINK-WRAPPING



6 U./PACK

Esta cobertura ofrece una protección duradera frente a la corrosión, los golpes y rasguños, inclemencias del tiempo y demás agentes contaminantes.

This cover offers long-lasting protection against corrosion, bumps and scratches, bad weather and other contaminating agents.

Tendedero de baranda adaptable blanco

White adaptable
galvanized steel
clothes airer for
railing

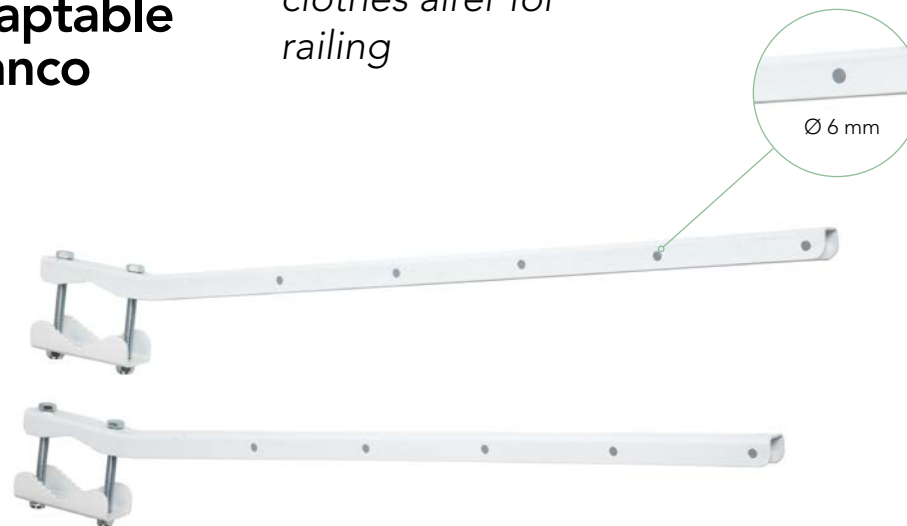

MATERIAL
MATERIAL

Acero galvanizado con pintura cerámica de color blanco.
Galvanized steel with white ceramic paint.

REF.

89410



66



CAJA SERIGRAFIADA
PRINTED BOX



3 U./PACK

Adaptable a cualquier perfil de barandilla (redonda, rectangular,...) con un ancho máximo de 5 cm. y una altura máxima de 7 cm.

Adaptable to any railing profile (round, rectangular, etc.) with a maximum width of 5 cm and a maximum height of 7 cm.

Material para su instalación incluido (tornillería y tacos).
Material for its installation included (rust-proof screws and plugs).

Tendedero de baranda adaptable y abatible

Adaptable and collapsible galvanized steel clothes airer for railing



MATERIAL
MATERIAL

Acero galvanizado con pintura cerámica.
Galvanized steel with ceramic paint.



CAJA SERIGRAFIADA
PRINTED BOX





3 U./PACK



63

REF.

ACABADO
FINISHED

89415		BLANCO / WHITE
89425		GRIS / GREY
89435		NEGRO / BLACK

Adaptable a cualquier perfil de barandilla (redonda, rectangular,...) con un ancho máximo de 5 cm. y una altura máxima de 7 cm.
Con brazos abatibles.

Adaptable to any railing profile (round, rectangular, etc.) with a maximum width of 5 cm and a maximum height of 7 cm.
With collapsible arms.

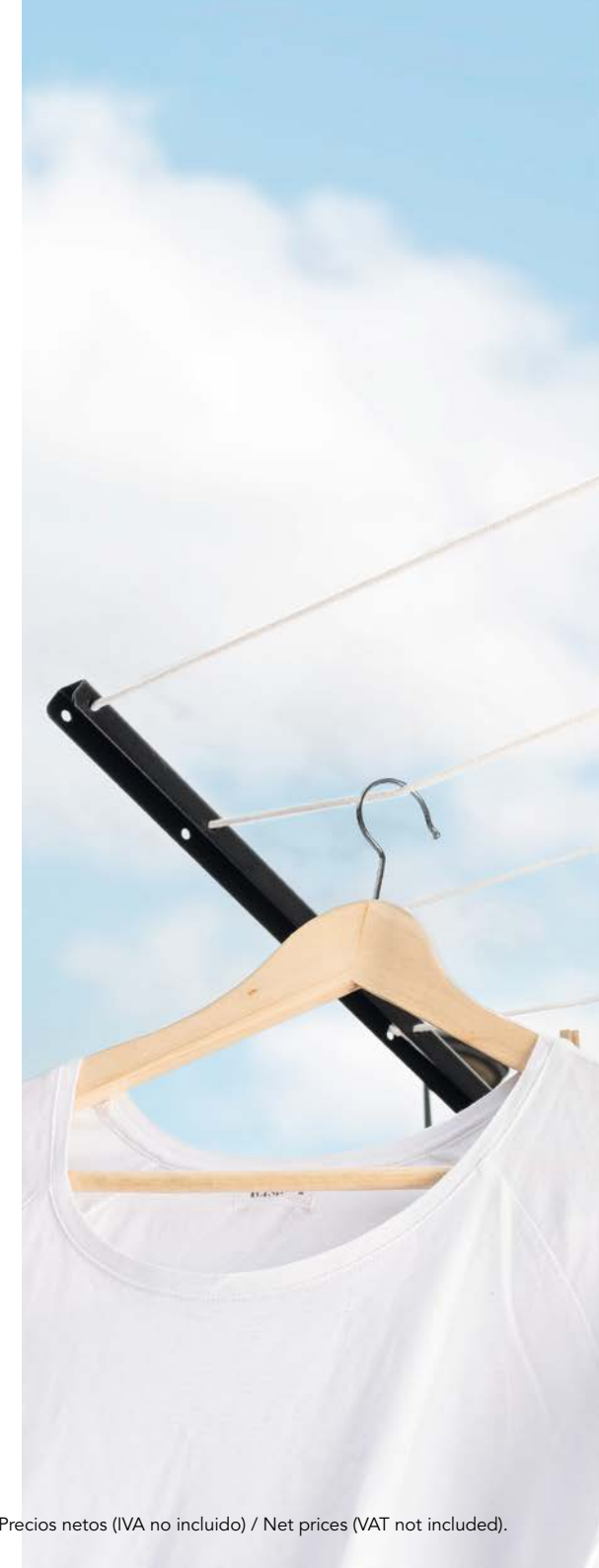



Tendedero de baranda adaptable y abatible de acero inoxidable 18/8

Adaptable and collapsible 18/8 stainless steel clothes airer for railing



MATERIAL
MATERIAL

Acero inoxidable 18/8 (AISI 304) electropulido.
Electropolished (AISI 304) 18/8 stainless steel.



63



CAJA SERIGRAFIADA
PRINTED BOX



3 U./PACK

REF.

ACABADO
FINISHED

89445

INOX

Adaptable a cualquier perfil de barandilla (redonda, rectangular,...) con un ancho máximo de 5 cm. y una altura máxima de 7 cm.
Con brazos abatibles.

Adaptable to any railing profile (round, rectangular, etc.) with a maximum width of 5cm and a maximum height of 7cm.
With collapsible arms.

Material para su instalación incluido (tornillería inoxidable y tacos).
Material for its installation included (stainless steel screws and plugs).

Tendedero de pared abatible

Foldable wall-mounted clothes airer



MATERIAL
MATERIAL

Acero galvanizado con pintura cerámica.
Galvanized steel with ceramic paint.



CAJA SERIGRAFIADA
PRINTED BOX



3 U./PACK

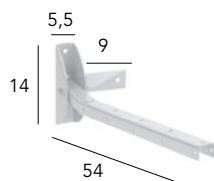

REF.

ACABADO
FINISHED

89420



BLANCO / WHITE

89430



GRIS / GREY

89440



NEGRO / BLACK

Abatible fácilmente.

Easily collapsible.

Material para su instalación incluido (tornillería y tacos).
Material for its installation included (rust-proof screws and plugs)





Tendedero de pared abatible de acero inoxidable 18/8

18/8 Stainless steel collapsible wall-mounted clothes airer

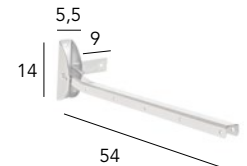
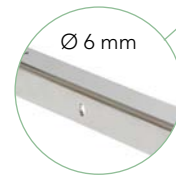
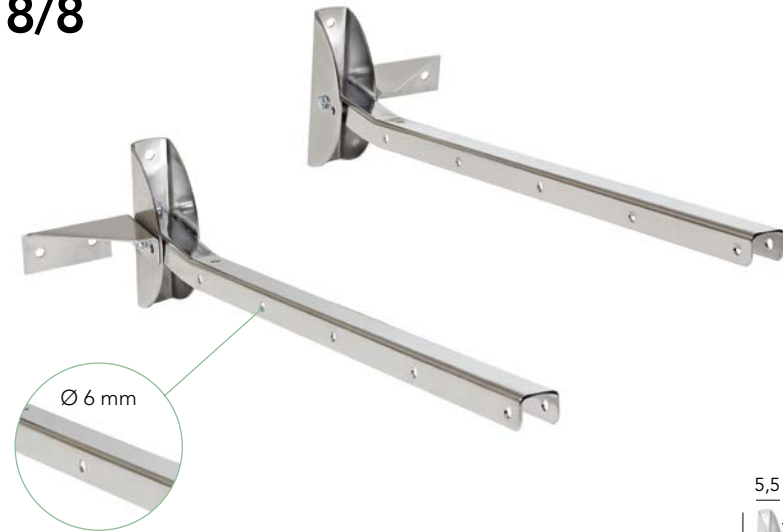

MATERIAL
MATERIAL

Acero inoxidable 18/8 (AISI 304) electropulido.
Electropolished (AISI 304) 18/8 stainless steel.

REF.

89450



CAJA SERIGRAFIADA
PRINTED BOX



3 U./PACK

Abatible fácilmente. *Easily collapsible.*

Material para su instalación incluido (tornillería inoxidable y tacos).
Material for its installation included (stainless steel screws and plugs).



Tendedero de pared con 8 poleas plastificado

White plastic-coated wall-mounted clothes airer with 8 pulleys



MATERIAL
MATERIAL

Acero con 0,5 mm. de recubrimiento plástico anticorrosivo.
Steel with 0,5 mm. anti-corrosive plastic coating.

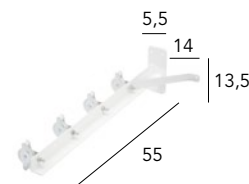

REF.

ACABADO
FINISHED

89396



BLANCO / WHITE

89399



NEGRO / BLACK

Ideal para tender la ropa en espacios de difícil acceso.

Ideal for hanging clothes in hard-to-reach spaces.



CAJA SERIGRAFIADA
PRINTED BOX



3 U./PACK

Esta cobertura ofrece una protección duradera frente a la corrosión, los golpes y rasguños, inclemencias del tiempo y demás agentes contaminantes.

This cover offers long-lasting protection against corrosion, bumps and scratches, bad weather and other contaminating agents.

Material para su instalación incluido (tornillería y tacos).
Material for its installation included (rust-proof screws and plugs)

Tendedero de pared con 6 poleas plastificado

White plastic-coated wall-mounted clothes airer with 6 pulleys



MATERIAL
MATERIAL

Acero con 0,5 mm. de recubrimiento plástico anticorrosivo.
Steel with 0,5 mm. anti-corrosive plastic coating.

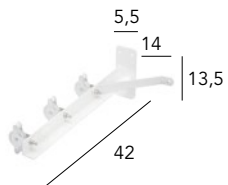

REF.

ACABADO
FINISHED

89398



BLANCO / WHITE

89401



NEGRO / BLACK

Ideal para tender la ropa en espacios de difícil acceso.

Ideal for hanging clothes in hard-to-reach spaces.

Esta cobertura ofrece una protección duradera frente a la corrosión, los golpes y rasguños, inclemencias del tiempo y demás agentes contaminantes.

This cover offers long-lasting protection against corrosion, bumps and scratches, bad weather and other contaminating agents.



CAJA SERIGRAFIADA
PRINTED BOX



3 U./PACK

Material para su instalación incluido (tornillería y tacos).
Material for its installation included (rust-proof screws and plugs)

Tendedero de pared con 8 poleas de acero inoxidable 18/8

18/8 Stainless steel wall-mounted clothes airer with 8 pulleys



MATERIAL
MATERIAL

Acero inoxidable 18/8 (AISI 304) electropulido.
Electropolished (AISI 304) 18/8 stainless steel.

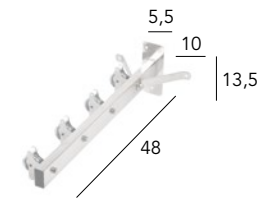

REF.

89405

Ideal para tender la ropa en espacios de difícil acceso.

Ideal for hanging clothes in hard-to-reach spaces.



CAJA SERIGRAFIADA
PRINTED BOX



3 U./PACK

Material para su instalación incluido (tornillería inoxidable y tacos).
Material for its installation included (stainless steel screws and plugs).







Escurreplatos

Dish drainers

Otro producto estrella de la casa. Los escurreplatos Sauvic están pensados para ser funcionales y ocupar poco espacio. Dentro de nuestra amplia gamma con diferentes diseños, acabados, colores y tamaños hay uno ideal para cada necesidad.

Con un diseño clásico en tendencia, le dará a cada cocina ese toque especial.

Another star product of Sauvic. Our dish drainers are designed to be functional and occupy little space. Within our wide range with different designs, finishes, colors, and sizes there is one ideal for every need.

With a trendy and classic design, you will give each kitchen that special touch.



Escurreplatos plastificado grande

Large plastic-coated
steel dish drainer



MATERIAL
MATERIAL

Acero con 0,5 mm de recubrimiento plástico anticorrosivo.
Steel with 0,5 mm anti-corrosive plastic coating.



CAPACIDAD
CAPACITY

18 platos
dishes



Con ganchos laterales para vasos y tazas.
With lateral hooks for glasses.

REF.

ACABADO
FINISHED

88980  BLANCO / WHITE

89010  GRIS / GREY

89023  NEGRO / BLACK

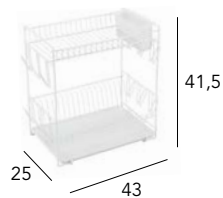

Esta cobertura ofrece una protección duradera frente a la corrosión, los golpes y rasguños, inclemencias del tiempo y demás agentes contaminantes.

This cover offers long-lasting protection against corrosion, bumps and scratches, bad weather and other contaminating agents.



RETRACTILADO
SCHRINK-WRAP



2 U./PACK

Escurreplatos plastificado pequeño

*Small plastic-coated steel
dish drainer*



MATERIAL
MATERIAL

Acero con 0,5 mm de recubrimiento
plástico anticorrosivo
Steel with 0,5 mm anticorrosive
plastic coating



CAPACIDAD
CAPACITY

18 platos
dishes

REF.

ACABADO
FINISHED

89000  BLANCO / WHITE

89015  GRIS / GREY

89024  NEGRO / BLACK

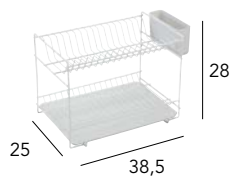

Esta cobertura ofrece una
protección duradera frente
la corrosión, los golpes y
rasguños, inclemencias del
tiempo y demás agentes
contaminantes.

*This cover offers long-lasting
protection against corrosion,
bumps and scratches,
bad weather and other
contaminating agents.*



RETRACTILADO
SCHRINK-WRAP



2 U./PACK

Escurreplatos plastificado plano

Flat plastic-coated
steel dish drainer



MATERIAL
MATERIAL

Acero con 0,5 mm de recubrimiento
plástico anticorrosivo
Steel with 0,5 mm anticorrosive
plastic coating



CAPACIDAD
CAPACITY

18 platos
dishes

REF.

ACABADO
FINISHED

89005



BLANCO / WHITE

89020



GRIS / GREY



Esta cobertura ofrece una
protección duradera frente
la corrosión, los golpes y
rasguños, inclemencias del
tiempo y demás agentes
contaminantes.

This cover offers long-lasting
protection against corrosion,
bumps and scratches,
bad weather and other
contaminating agents.



RETRACTILADO
SCHRINK-WRAP



4 U./PACK



SAUVIC

Escurreplatos vintage

Vintage dish drainer





MATERIAL
MATERIAL
Acero con pintura cerámica.
Steel with ceramic paint.

CAPACIDAD
CAPACITY
18 platos
dishes

REF.

ACABADO
FINISHED

89045		MENTA / MINT GREEN
89050		TURQUESA / TURQUOISE
89055		BRONCE / BRONZE



 RETRACTILADO
SCHRINK-WRAP

 2 U./PACK

Escurreplatos de acero inoxidable 18/8 grande

Large 18/8 stainless
steel dish drainer

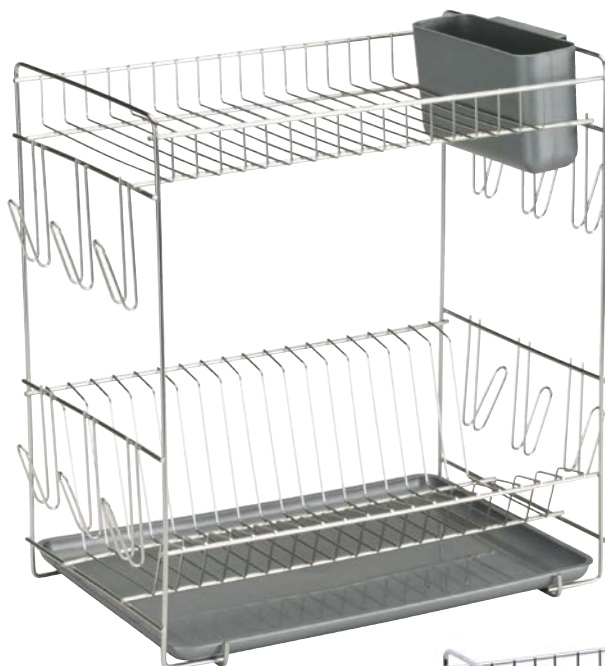

MATERIAL
MATERIAL

Acero inoxidable 18/8
(AISI 304) electropulido.
Electropolished (AISI 304)
18/8 stainless steel.



CAPACIDAD
CAPACITY

18 platos
dishes



Con ganchos
laterales para
vasos y tazas.
With lateral
hooks for
glasses.

REF.

ACABADO
FINISHED

90980		GRIS / GREY
91008		LILA / PURPLE
91010		VERDE / GREEN

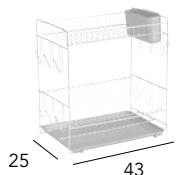

25

43

41,5

RETRACTILADO
SCHRINK-WRAP

2 U./PACK

Escurreplatos de acero inoxidable 18/8 pequeño

Small 18/8 stainless
steel dish drainer



MATERIAL
MATERIAL

Acero inoxidable 18/8
(AISI 304) electropulido.
Electropolished (AISI 304)
18/8 stainless steel.





CAPACIDAD
CAPACITY

18 platos
dishes

REF.

ACABADO
FINISHED

90985		GRIS / GREY
91018		LILA / PURPLE
91020		VERDE / GREEN



RETRACTILADO
SCHRINK-WRAP



2 U./PACK

Escurreplatos de acero inoxidable 18/8 plano

Flat 18/8 stainless
steel dish drainer



MATERIAL
MATERIAL

Acero inoxidable 18/8
(AISI 304) electropulido.
Electropolished (AISI 304)
18/8 stainless steel.



CAPACIDAD
CAPACITY

18 platos
dishes

REF.

ACABADO
FINISHED

90990		GRIS / GREY
91028		LILA / PURPLE*
91030		VERDE / GREEN*

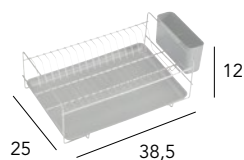

RETRACTILADO
SCHRINK-WRAP



4 U./PACK

* Bandeja translúcida / Translucent tray.

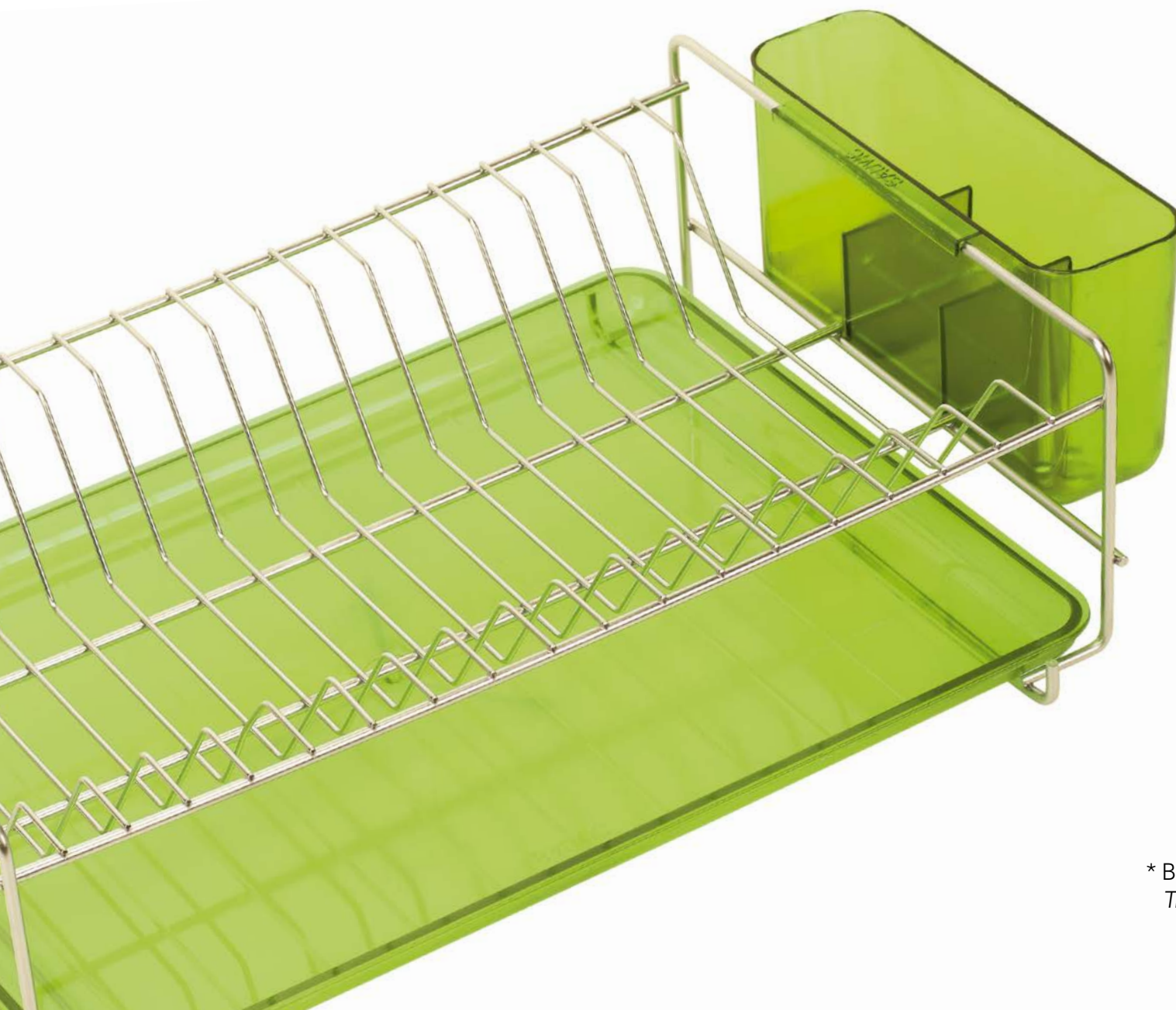

* Bandeja translúcida (en acabados lila y verde).
Translucent tray i(n purple and green finishes).

Escurreplatos inoxidable 18/8 cobre grande

Large 18/8 stainless
steel dish drainer with
copper finish



MATERIAL
MATERIAL

Acero inoxidable 18/8
(AISI 304) electropulido.
Electropolished (AISI 304)
18/8 stainless steel.



CAPACIDAD
CAPACITY

18 platos
dishes



Con ganchos
laterales para
vasos y tazas.
With lateral
hooks for
glasses.

REF.

ACABADO
FINISHED

90992



COBRE / COPPER

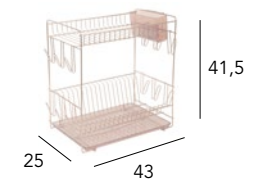

RETRACTILADO
SCHRINK-WRAP



2 U./PACK

Bandeja translúcida.
Translucent tray.

Escurreplatos inoxidable 18/8 cobre pequeño

Small 18/8 stainless steel dish drainer with copper finish



MATERIAL
MATERIAL
Acero inoxidable 18/8 (AISI 304) electropulido. Electropolished (AISI 304) 18/8 stainless steel.

CAPACIDAD
CAPACITY
18 platos
dishes

REF. ACABADO FINISHED
90994  COBRE / COPPER

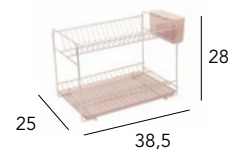

 **RETRACTILADO**
SCHRINK-WRAP

 **2 U./PACK**

Bandeja translúcida.
Translucent tray.

Escurreplatos inoxidable 18/8 cobre plano

Flat 18/8 stainless steel dish drainer with copper finish

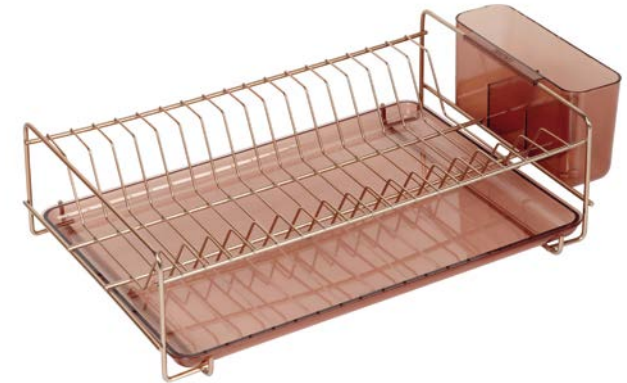

MATERIAL
MATERIAL
Acero inoxidable 18/8 (AISI 304) electropulido. Electropolished (AISI 304) 18/8 stainless steel.

CAPACIDAD
CAPACITY
18 platos
dishes

REF. ACABADO FINISHED
90996  COBRE / COPPER

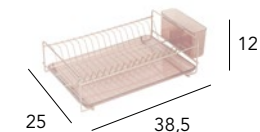

 **RETRACTILADO**
SCHRINK-WRAP

 **4 U./PACK**



Bandeja translúcida.
Translucent tray.







Escurreplatos plegable cromado

Chromed folding dish drainer



	MATERIAL MATERIAL		CAPACIDAD CAPACITY
	Acero cromado. Chromed steel.		16 platos dishes

REF.	ACABADO	FINISHED
89035		LILA / PURPLE*
89040		VERDE / GREEN*
89041		BLANCO / WHITE
89042		GRIS / GREY

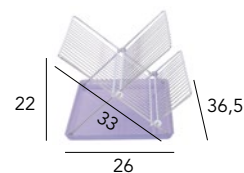

Bandeja translúcida (en acabados lila y verde).
Con un sistema de pliegue en forma de X, fácil y seguro que no se desmonta.
Con una pestaña extra para secar las tazas, vasos y demás utensilios pequeños.

Translucent tray (in purple and green finishes).
With an X-shaped folding system, easy and safe which does not come apart.
With an extra flap to dry cups, glasses and other small utensils.

	CAJA SERIGRAFIADA PRINTED BOX
	4 U./PACK

* Bandeja translúcida / Translucent tray.

Escurreplatos plegable inoxidable 18/8

18/8 stainless
steel folding dish
drainer



MATERIAL
MATERIAL

Acero inoxidable 18/8
(AISI 304) electropulido.
Electropolished (AISI 304)
18/8 stainless steel.



CAPACIDAD
CAPACITY

16 platos
dishes

REF.

ACABADO
FINISHED

91035		LILA / PURPLE*
91040		VERDE / GREEN*
91041		BLANCO / WHITE
91042		GRIS / GREY

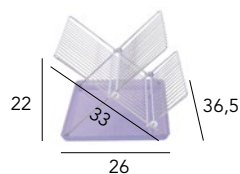

Bandeja translúcida (en acabados lila y verde).
Con un sistema de pliegue en forma de X, fácil y seguro que no se desmonta.
Con una pestaña extra para secar las tazas, vasos y demás utensilios pequeños.

Translucent tray (in purple and green finishes).
With an X-shaped folding system, easy and safe which does not come apart.
With an extra flap to dry cups, glasses and other small utensils.



CAJA SERIGRAFIADA
PRINTED BOX



4 U./PACK

* Bandeja translúcida / Translucent tray.

Escurreplatos de acero inoxidable 18/8 super

Super 18/8 stainless
steel dish drainer

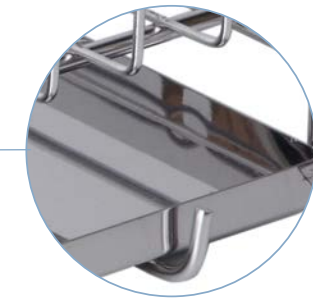
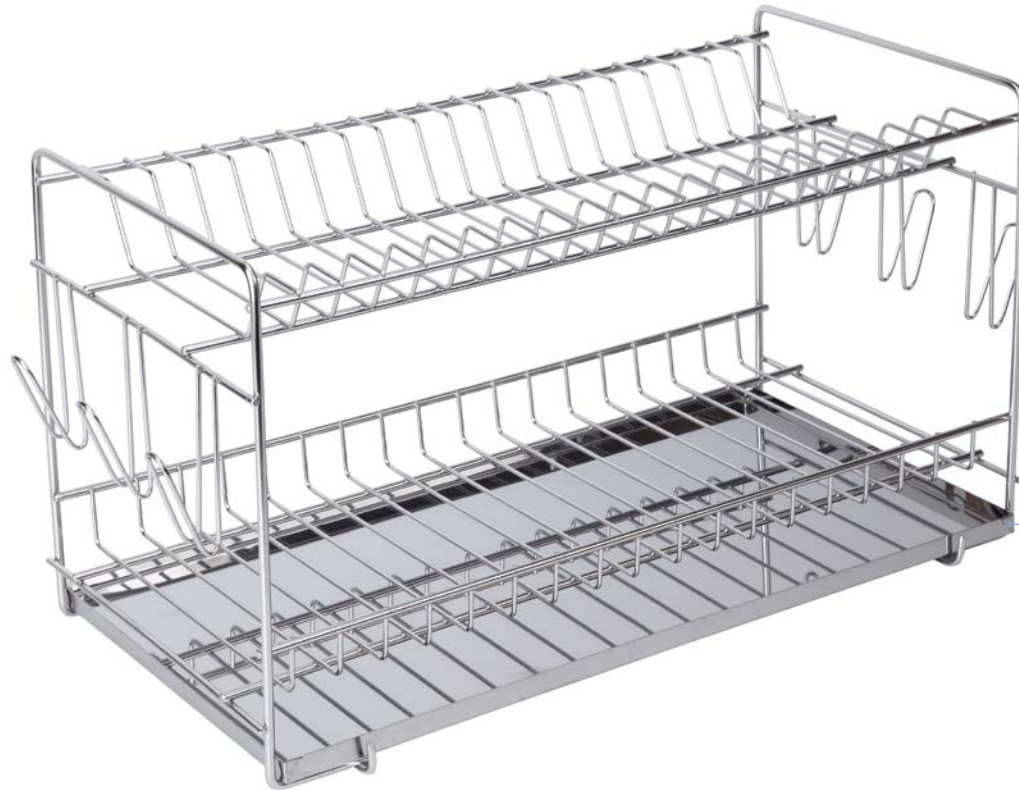

BANDEJA DE ACERO INOXIDABLE 18/8
18/8 STAINLESS STEEL TRAY



MATERIAL
MATERIAL

Acero inoxidable 18/8
(AISI 304) electropulido.
Electropolished (AISI
304) 18/8 stainless steel.



CAPACIDAD
CAPACITY

20 platos
dishes



Con ganchos
laterales para
vasos y tazas.
With lateral hooks
for glasses.

REF.

ACABADO
FINISHED

90970



INOX

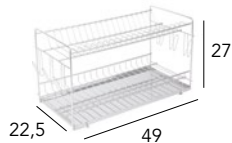

RETRACTILADO
SCHRINK-WRAP



2 U./PACK



Escurreplatos de armario plastificado blanco

White plastic-coated steel dish drainer for cabinets



MATERIAL
MATERIAL

Acero con 0,5 mm. de recubrimiento plástico anticorrosivo blanco.
Steel with 0,5 mm. white anti-corrosive plastic coating.

REF.	LONGITUD LENGTH	PIEZAS PIECES
92190	65	
92195	75	PLATOS PLATES
92200	85	

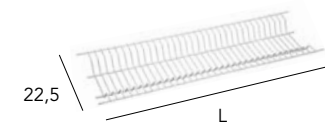

Incluye regletas para fijarlo al armario.

It includes strips to fix it to the cabinet.

Esta cobertura ofrece una protección duradera frente a la corrosión, los golpes y rasguños, inclemencias del tiempo y demás agentes contaminantes.

This cover offers long-lasting protection against corrosion, bumps and scratches, bad weather and other contaminating agents.



15 U./PACK

Escurrevasos de armario plastificado blanco

White plastic-coated steel glass drainer for cabinets



MATERIAL MATERIAL

Acero con 0,5 mm. de recubrimiento plástico anticorrosivo blanco.
Steel with 0,5 mm. white anti-corrosive plastic coating.

REF.	LONGITUD LENGTH	PIEZAS PIECES
92205	65	VASOS GLASS
92210	75	
92215	85	

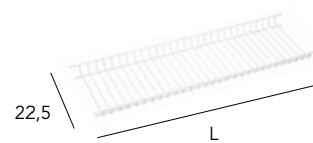

Incluye regletas para fijarlo al armario. *It includes strips to fix it to the cabinet.*

Esta cobertura ofrece una protección duradera frente la corrosión, los golpes y rasguños, inclemencias del tiempo y demás agentes contaminantes. *This cover offers long-lasting protection against corrosion, bumps and scratches, bad weather and other contaminating agents.*

 **15 U./PACK**

Juego de escurreplatos de armario plastificado blanco

Set of white plastic-coated steel dish drainer for cabinets

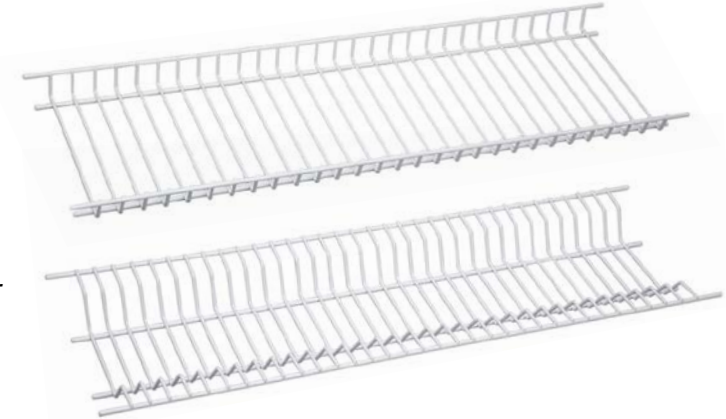

MATERIAL MATERIAL

Acero con 0,5 mm. de recubrimiento plástico anticorrosivo blanco.
Steel with 0,5 mm. white anti-corrosive plastic coating.

REF.	LONGITUD LENGTH
92220	65
92225	75
92230	85

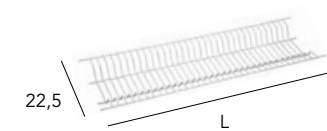

Incluye regletas para fijarlo al armario. *It includes strips to fix it to the cabinet.*

Esta cobertura ofrece una protección duradera frente la corrosión, los golpes y rasguños, inclemencias del tiempo y demás agentes contaminantes. *This cover offers long-lasting protection against corrosion, bumps and scratches, bad weather and other contaminating agents.*

 **RETRACTILADO SCHRINK-WRAP**

 **3 U./PACK**

Escurreplatos de armario de acero inoxidable 18/8



18/8 Stainless
steel dish drainer
for cabinets

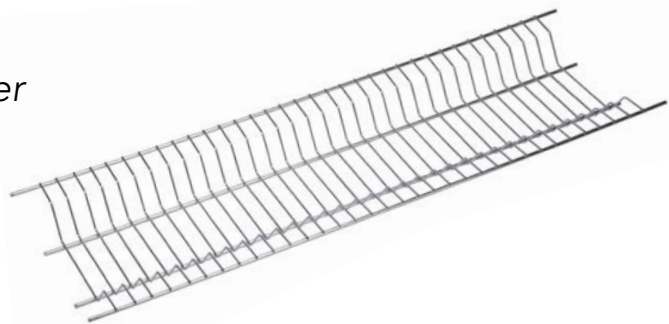

MATERIAL
MATERIAL

Acero inoxidable 18/8
(AISI 304) electropulido.
Electropolished (AISI 304)
18/8 stainless steel.

REF.	LONGITUD LENGTH
91055	55
91065	65
91075	75
91085	85



15 U./PACK

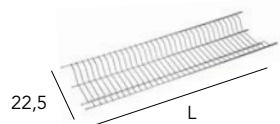

Incluye ganchos de acero
inoxidable para fijarlo al
armario (REF. 92189).

*It includes stainless steel
hooks to fix it to the
cabinet (REF. 92189).*

Escurrevasos de armario de acero inoxidable 18/8



18/8 Stainless
steel glass drainer
for cabinets

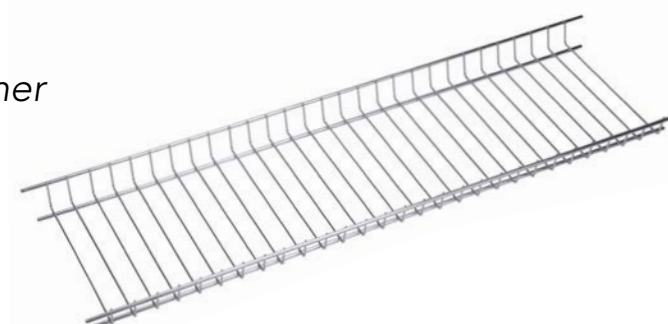

MATERIAL
MATERIAL

Acero inoxidable 18/8
(AISI 304) electropulido.
Electropolished (AISI 304)
18/8 stainless steel.

REF.	LONGITUD LENGTH
92055	55
92065	65
92075	75
92085	85



15 U./PACK

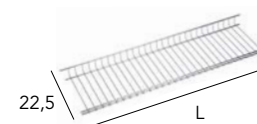

Incluye ganchos de acero
inoxidable para fijarlo al
armario (REF. 92189).

*It includes stainless steel
hooks to fix it to the
cabinet (REF. 92189).*

Juego de escurrer platos de armario de acero inoxidable 18/8

Set of 18/8 stainless steel dish drainer for cabinets

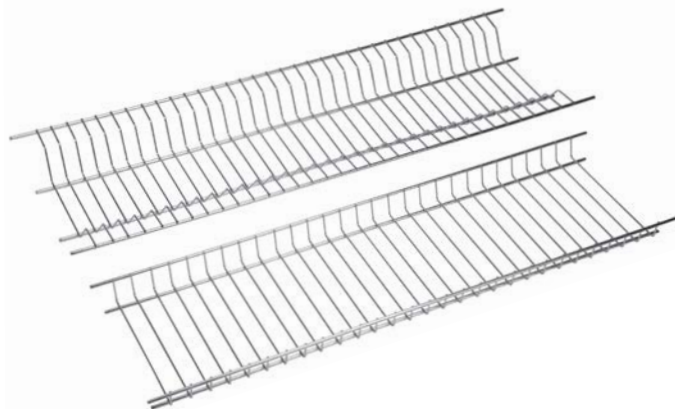

MATERIAL
MATERIAL

Acero inoxidable 18/8 (AISI 304) electropulido.
Electropolished (AISI 304) 18/8 stainless steel.

REF.	LONGITUD LENGTH
92155	55
92165	65
92175	75
92185	85

RETRACTILADO
SCHRINK-WRAP

3 U./PACK

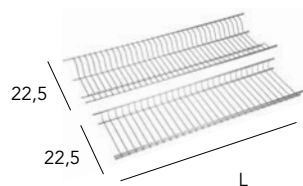

x 8

Incluye ganchos de acero inoxidable para fijarlo al armario (REF. 92189).

It includes stainless steel hooks to fix it to the cabinet (REF. 92189).



Regleta para escurrer platos de armario

Strip to fix dish drainers to the cabinets



MATERIAL
MATERIAL

Plástico.
Plastic.

REF.

92187

100 U./PACK

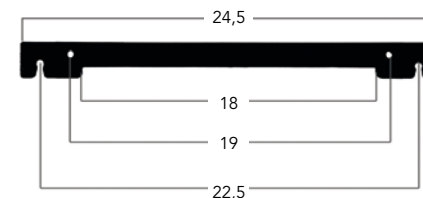

Soporte de acero inoxidable 18/8 para escurrer platos de armario

18/8 Stainless steel hook to fix dish drainers to the cabinets



MATERIAL
MATERIAL

Acero inoxidable 18/8 (AISI 304) electropulido.
Electropolished (AISI 304) 18/8 stainless steel.

REF.

92189





Soporte para 4 sartenes plastificado gris

Grey plastic-coated steel support for 4 frying pans



MATERIAL
MATERIAL

Acero con 0,5 mm de recubrimiento plástico anticorrosivo gris.
Steel with 0,5 mm grey anti-corrosive plastic coating.



CAPACIDAD
CAPACITY

4 sartenes.
4 frying pans.

REF.

ACABADO
FINISHED

03258



GRIS / GREY

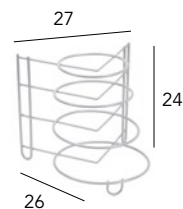

10 U./PACK

Ideal para organizar armarios de cocina, ya que permite almacenar de forma eficiente sartenes, tapas de ollas y otros utensilios de cocina. Al ser plastificado, evita que las paellas y los muebles de la cocina se rallen.

Ideal for organising kitchen cabinets as it allows you to efficiently store frying pans, pot lids and other kitchen utensils. As it is laminated, it prevents paella pans and kitchen furniture from getting scratched.

Esta cobertura ofrece una protección duradera frente a la corrosión, los golpes y rasguños, inclemencias del tiempo y demás agentes contaminantes.

This cover offers long-lasting protection against corrosion, bumps and scratches, bad weather and other contaminating agents.

Soporte para 4 piezas (sartenes, utensilios cocina) plastificado gris

Grey plastic-coated steel support for 4 pieces (frying pans, kitchen utensils)

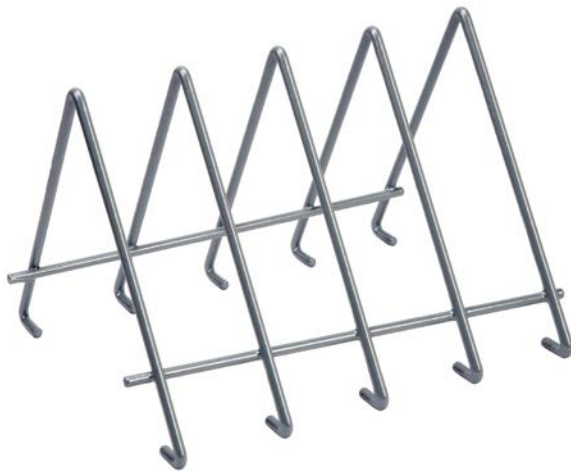

MATERIAL
MATERIAL

Acero con 0,5 mm de recubrimiento plástico anticorrosivo gris.
Steel with 0,5 mm grey anti-corrosive plastic coating.



CAPACIDAD
CAPACITY

4 piezas.
4 pieces.

REF.

ACABADO
FINISHED

03265



GRIS / GREY

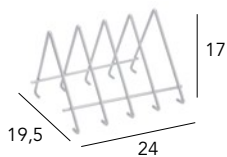

6 U./PACK

Ideal para organizar armarios de cocina, ya que permite almacenar de forma eficiente sartenes, tapas de ollas y otros utensilios de cocina.

Al ser plastificado, evita que las paellas y los muebles de la cocina se rallen.

Ideal for organising kitchen cabinets as it allows you to efficiently store frying pans, pot lids and other kitchen utensils.

As it is laminated, it prevents paella pans and kitchen furniture from getting scratched.

Esta cobertura ofrece una protección duradera frente la corrosión, los golpes y rasguños, inclemencias del tiempo y demás agentes contaminantes.

This cover offers long-lasting protection against corrosion, bumps and scratches, bad weather and other contaminating agents.





Desde rejillas para el horno hasta espátulas. En Sauvic ofrecemos todo tipo de accesorios de cocina de gran utilidad.

Artículos funcionales con valor añadido, cómo por ejemplo las rejillas de horno extensibles, más medidas con menos referencias; o las pinzas con guía, que evitan molestias durante su uso.

From oven racks to spatulas. In Sauvic we offer all types of useful kitchen accessories.

Functional articles with added value, such as extendable oven grids, more measures with fewer references; or guided tongs, which avoid discomfort during use.



Menaje

Household items



Rejilla de horno cromada extensible

Extendable chrome oven rack



ÚNICO EN EL MERCADO
UNIQUE IN THE MARKET



MATERIAL
MATERIAL
Acero cromado
Chromed steel

GRUESO VARILLAS
ROD THICKNESS
4-8 mm

EXTENSIBLE
EXTENSIBLE
38,5 → 55 cm

RETRACTILADO
SHRINK-WRAPPING

5 U./PACK

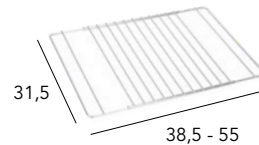

REF.	LONGITUD LENGTH
02545	38,5 - 55

La rejilla tiene una estructura muy estable y resistente gracias al grueso del acero utilizado en su fabricación y la poca separación existente entre varillas.
The rack has a very stable and hard-wearing structure thanks to the thickness of the steel used in its manufacture and the small gap between rods.

Adaptable a cualquier horno doméstico
Compatible with any oven

Rejilla de horno cromada extensible profesional

Professional extendable chrome oven rack



ÚNICO EN EL MERCADO
UNIQUE IN THE MARKET



MATERIAL
MATERIAL
Acero cromado
Chromed steel

GRUESO VARILLAS
ROD THICKNESS
5-8 mm

EXTENSIBLE
EXTENSIBLE
42 → 60 cm

RETRACTILADO
SHRINK-WRAPPING

5 U./PACK

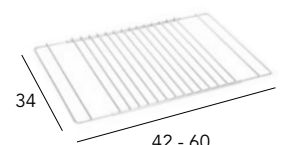

REF.	LONGITUD LENGTH
02547	42 - 60

La rejilla tiene una estructura muy estable y resistente gracias al grueso del acero utilizado en su fabricación y la poca separación existente entre varillas.
The rack has a very stable and hard-wearing structure thanks to the thickness of the steel used in its manufacture and the small gap between rods.

Adaptable a cualquier horno doméstico
Compatible with any oven

Rejilla de horno *Chrome oven rack*

cromada

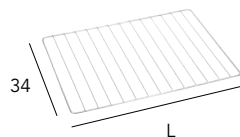
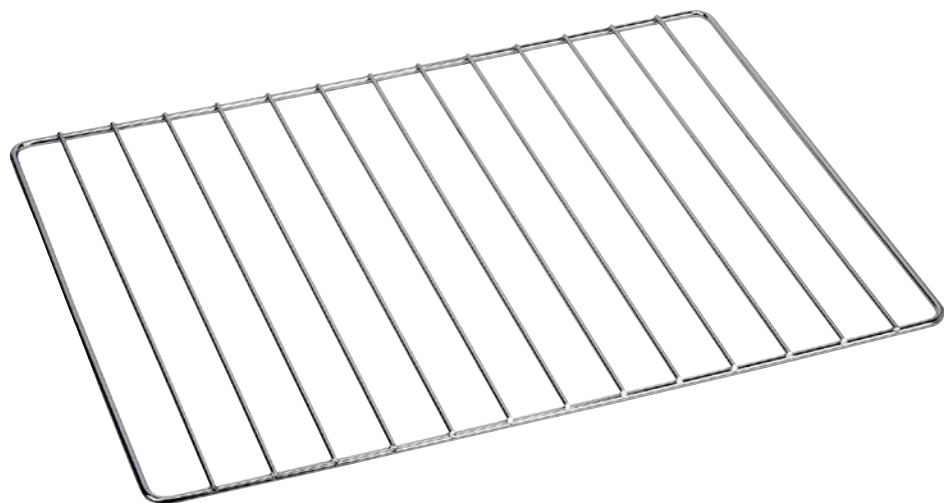

MATERIAL
MATERIAL

Acero cromado
Chromed steel



GRUESO VARILLAS
ROD THICKNESS

3-5 mm



RETRACTILADO
SHRINK-WRAPPING



5 U./PACK

REF.	LONGITUD LENGTH
02550	42,5
02555	43,5
02560	44,5
02565	45,5
02570	46,5

La rejilla tiene una estructura muy estable y resistente gracias al grueso del acero utilizado en su fabricación y la poca separación existente entre varillas.

The rack has a very stable and hard-wearing structure thanks to the thickness of the steel used in its manufacture and the small gap between rods.





Pinza de acero inoxidable con pala de nylon

Stainless steel kitchen tongs with nylon spatula



MATERIAL
MATERIAL

Acero inoxidable con pala de nylon
Stainless steel with nylon spatula

REF.



U./PACK

LONGITUD
LENGTH

04500

6/24

30

04505

6/24

35



GROSOR
THICKNESS

5 mm

Totalmente antiadherente, por lo que podemos utilizarlo con todo tipo de recipientes.
Apta para lavavajillas.

*Completely non-stick, so we can use it with all types of containers.
Dishwasher safe.*

Pinza de acero inoxidable con pala de silicona

Stainless steel kitchen tongs with silicone spatula



MATERIAL
MATERIAL

Acero inoxidable con pala de silicona
Stainless steel with silicone spatula

REF.



U./PACK

LONGITUD
LENGTH

04490

6/24

30

04495

6/24

35



GROSOR
THICKNESS

5 mm

Totalmente antiadherente, por lo que podemos utilizarlo con todo tipo de recipientes.
Apta para lavavajillas.

*Completely non-stick, so we can use it with all types of containers.
Dishwasher safe.*

Pinza para carne de acero inoxidable 18/8

18/8 Stainless steel meat kitchen tongs

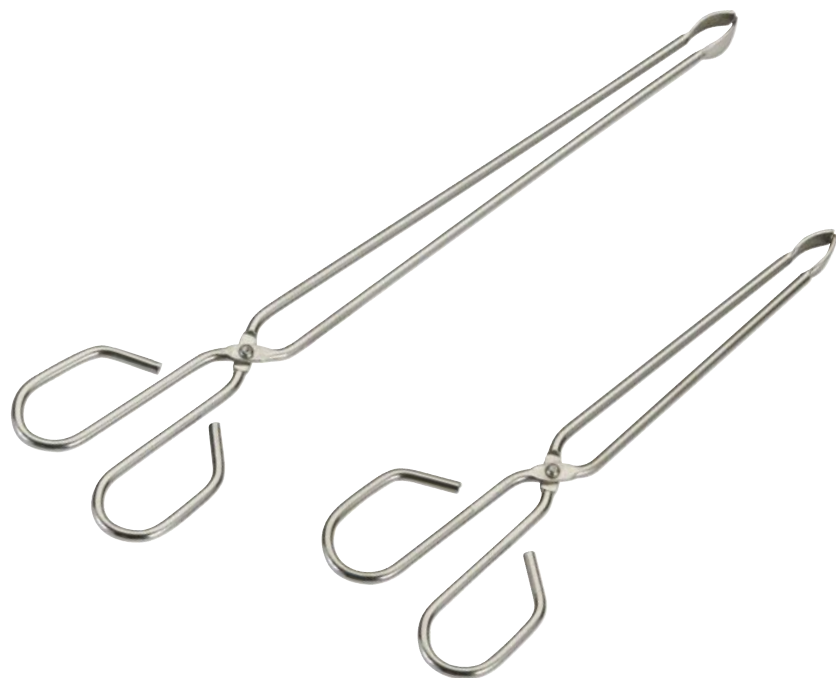

MATERIAL
Acero inoxidable 18/8
18/8 Stainless steel

GROSOR
THICKNESS
5 mm

REF.	U./PACK	LONGITUD LENGTH
04455	12/48	24
04459	12/36	33

Pinzas de punta estrecha ideales para carne. Apta para lavavajillas. *Narrow-tipped tongs ideal for meat. Dishwasher safe.*

Pinza con pala de acero inoxidable 18/8

18/8 Stainless steel kitchen tongs with spatula

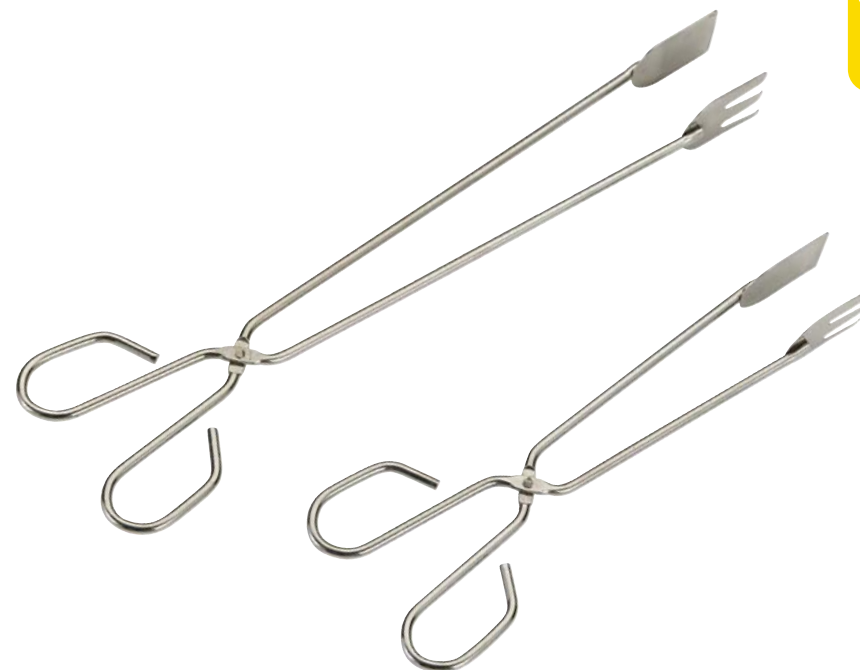

MATERIAL
Acero inoxidable 18/8
18/8 Stainless steel

GROSOR
THICKNESS
5 mm

REF.	U./PACK	LONGITUD LENGTH
04466	12/48	26
04468	12/36	35

Pinzas con pala ideales para carne o pescado. Apta para lavavajillas. *Tongs with spatula ideal for meat or fish. Dishwasher safe.*



Pinza de acero inoxidable 18/8 con guía 33 cm

18/8 Stainless steel kitchen tongs with guide 33 cm

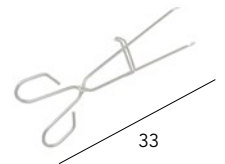
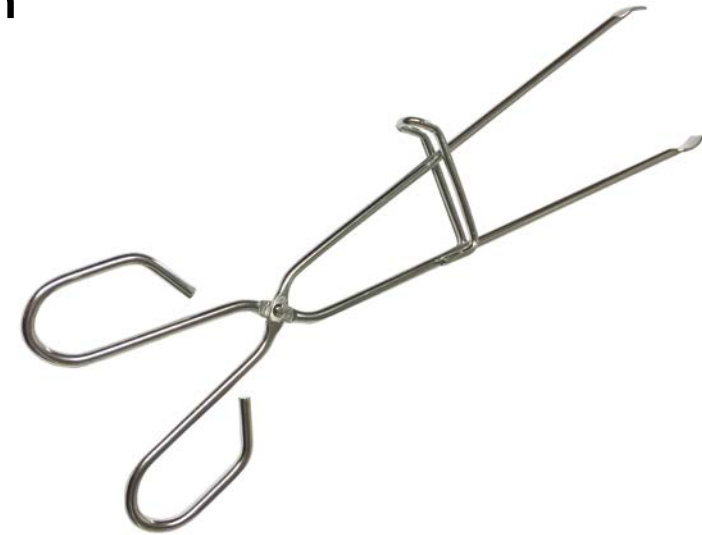

MATERIAL
MATERIAL

Acero inoxidable 18/8
18/8 Stainless steel



GROSOR
THICKNESS

5 mm



Con guía para evitar que se cruce.
With a guide to prevent crossing.



Con gancho para tirar de la parrilla sin quemarse.
With hook to pull the grill without burning yourself.

REF.



U./PACK

LONGITUD
LENGTH

04475

6/24

33

Pinzas de punta estrecha ideales para carne.
Apta para lavavajillas.

Narrow-tipped tongs ideal for meat.
Dishwasher safe.

Pinza barbacoa de acero inoxidable 18/8 con guía 45 cm

18/8 Stainless steel barbecue tongs with guide 45 cm

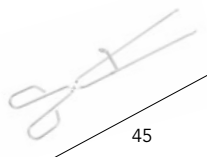
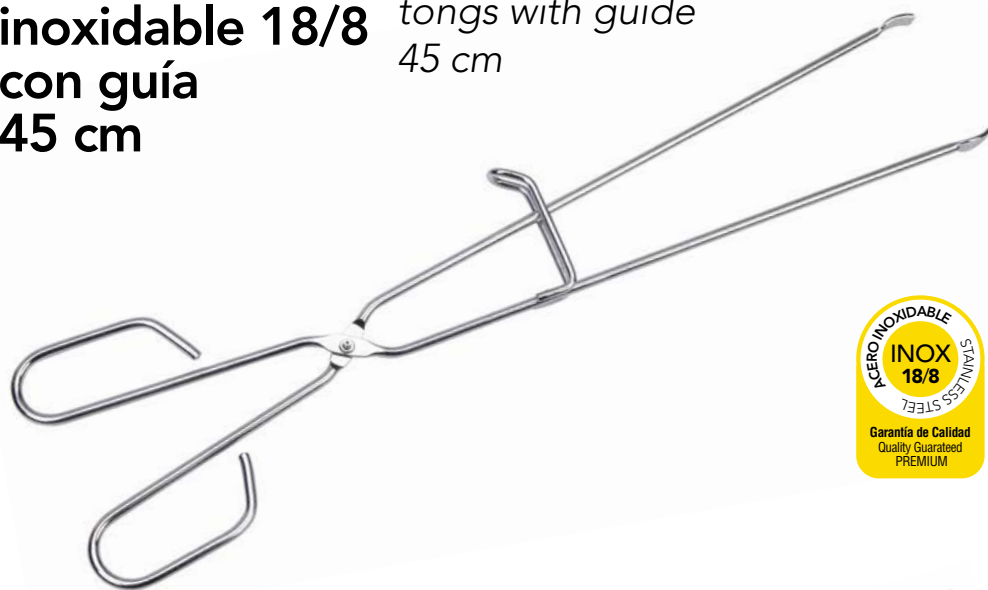

MATERIAL
MATERIAL
Acero inoxidable 18/8
18/8 Stainless steel

REF.	U./PACK	LONGITUD LENGTH
04476	6/24	45

GROSOR
THICKNESS
5 mm

Con guía para evitar que se cruce.
With a guide to prevent crossing.

Con gancho para tirar de la parrilla sin quemarse.
With hook to pull the grill without burning yourself.

Pinzas de punta estrecha ideales para carne.
Narrow-tipped tongs ideal for meat.
Apta para lavavajillas.
Dishwasher safe.

Pinza barbacoa de acero inoxidable 18/8 55 cm

18/8 Stainless steel barbecue tongs with guide 55 cm

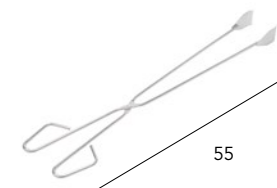
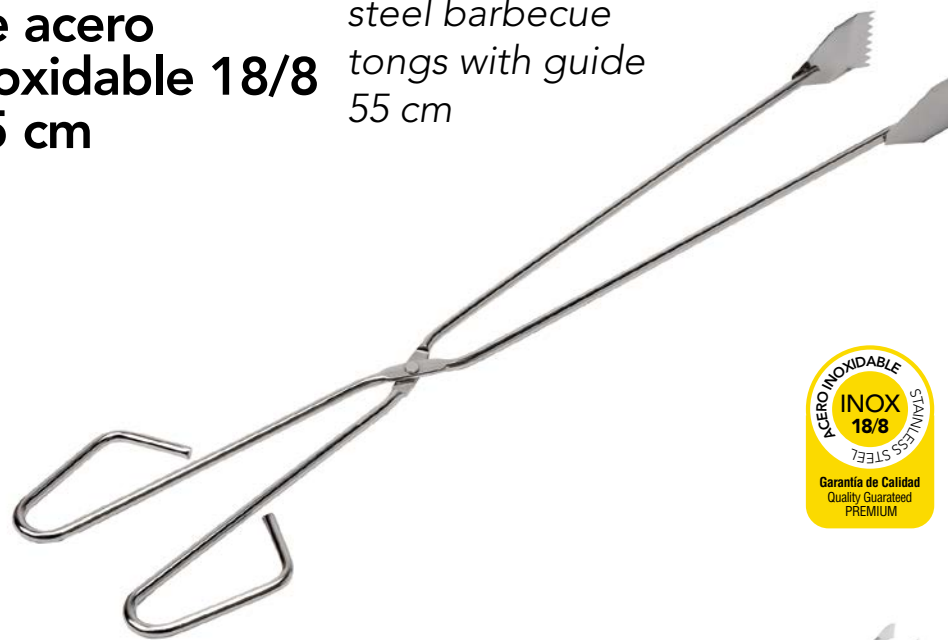

MATERIAL
MATERIAL
Acero inoxidable 18/8
18/8 Stainless steel

REF.	U./PACK	LONGITUD LENGTH
04470	6/36	55

GROSOR
THICKNESS
6 mm

Pinzas con pala ideales para carne o pescado.
Tongs with spatula ideal for meat or fish.
Apta para lavavajillas.
Dishwasher safe.

Pincho moruno de acero inoxidable 18/8

18/8 Stainless steel kebab spike

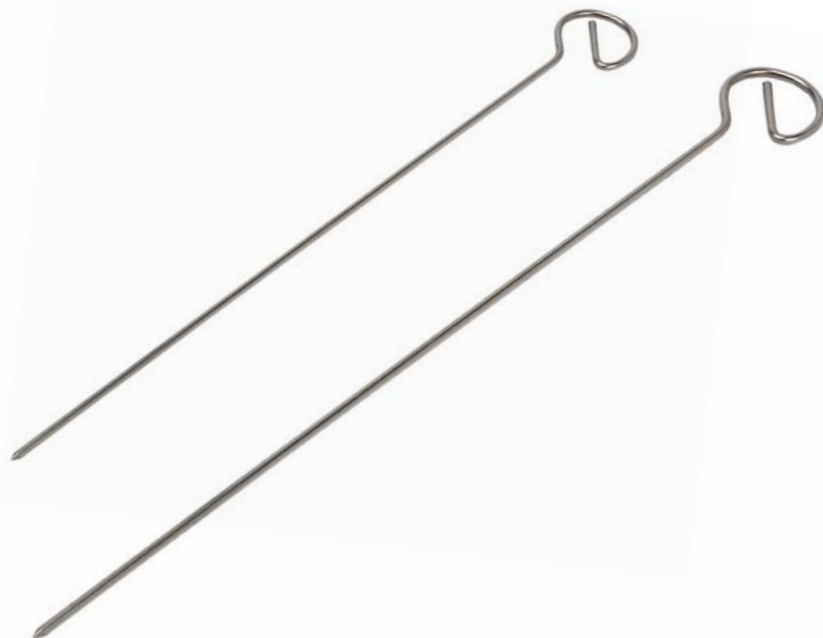

MATERIAL
MATERIAL

Acero inoxidable 18/8 (AISI 304) electropulido.
Electropolished (AISI 304) 18/8 stainless steel.

REF.



U./PACK

LONGITUD
LENGTH

04356

25/300

30

04357

25/300

35



GROSOR
THICKNESS

3 mm

Pincho aperitivo de acero inoxidable 18/8

18/8 Stainless steel aperitif spike



MATERIAL
MATERIAL

Acero inoxidable 18/8 (AISI 304) electropulido.
Electropolished (AISI 304) 18/8 stainless steel.

REF.



U./PACK

LONGITUD
LENGTH

04342

1000

9,5

Ganchos carnicero de acero inoxidable 18/8

18/8 Stainless
steel butcher's
hooks

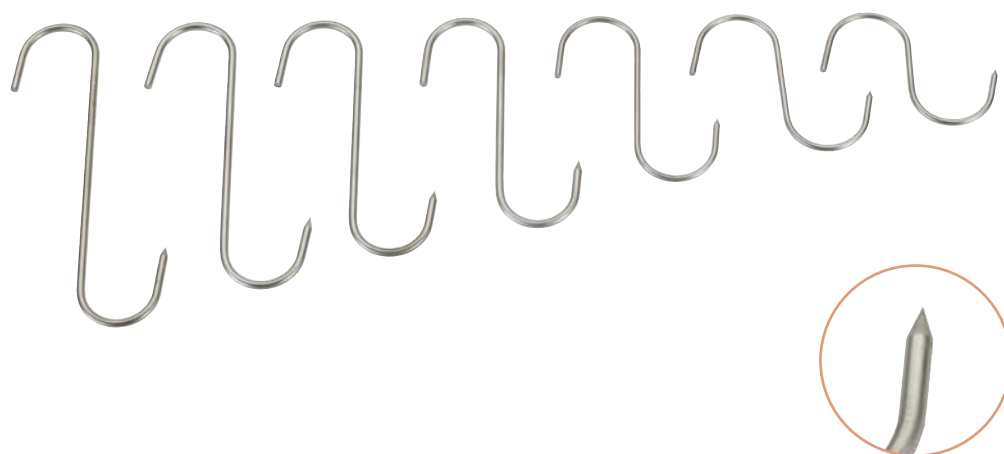

MATERIAL
MATERIAL
Acero inoxidable 18/8
(AISI 304) electropulido.
Electropolished (AISI
304) 18/8 stainless steel.

REF.	U./PACK	LONGITUD LENGTH	(mm)
01108	12/120	8	4
01110	12/120	10	4
01112	12/84	12	4
01114	12/84	14	5
01116	12/60	16	5
01118	12/60	18	5
01120	12/60	20	5

Ganchos multiusos

Multi-purpose
hooks

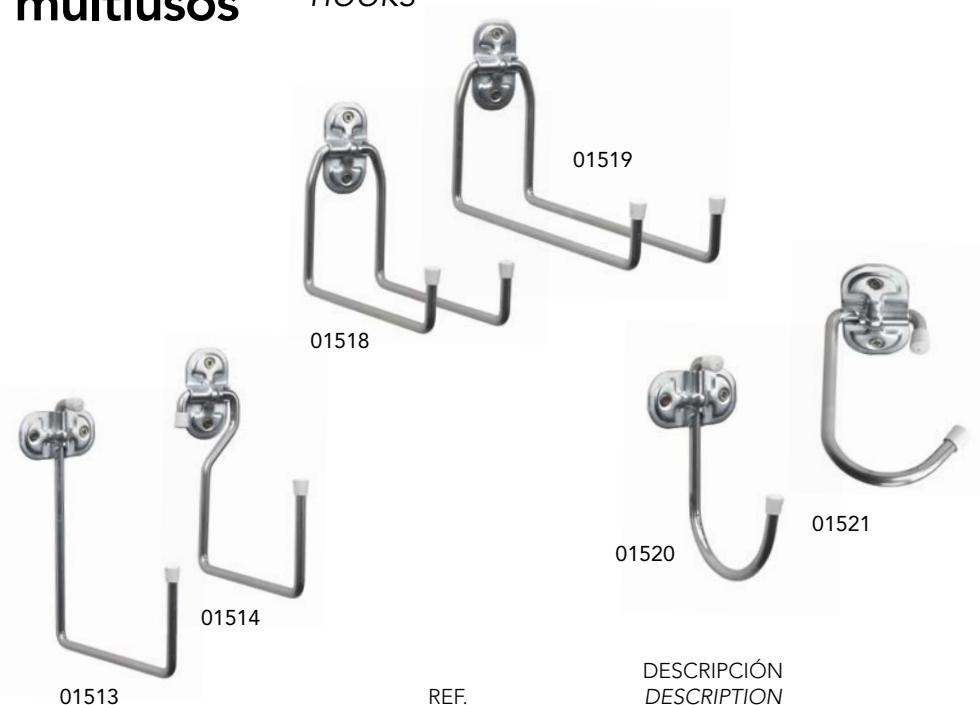

MATERIAL
MATERIAL
Hierro macizo de 8 mm.
de diámetro.
Solid iron with a diameter
of 8 mm.

10 U./PACK

REF.	DESCRIPCIÓN DESCRIPTION
01513	Forma U / U-shaped
01514	Pared corto / Wall short
01518	Doble corto / Double short
01519	Doble largo / Double long
01520	Colgador / Hanger-shaped
01521	Rueda bici (techo) / Bike (ceiling)

Ideal para colgar sillas
plegables, escaleras,
bicicletas, herramientas
eléctricas, etc.

Ideal for hanging folding
chairs, ladders, bicycles,
power tools, etc.

Incluyen el material necesario
para su instalación: pletina,
tornillos y tacos.

They include the necessary
material for installation: shim,
screws and plugs.

Cubiertos y utensilios de cocina en boj

Cutlery and kitchen utensils in boxwood



MATERIAL
MATERIAL

Madera de boj.
Boxwood.



6/24 U./PACK

REF.	LONGITUD LENGTH	DESCRIPCIÓN DESCRIPTION
01214	35	Espátula / Spatula
01215	30	Espátula / Spatula
01216	25	Espátula / Spatula
01230	22	Tenedor de mesa / Table fork
01231	22	Cuchara de mesa / Table spoon
01251	31	Pala con agujeros / Slice with holes
01255	31	Pala lisa / Smooth slice
01262	28	Cuchara / Spoon
01263	28	Tenedor / Fork

El boj es un arbusto escaso en la naturaleza. Un tipo de madera trabajada artesanalmente y apreciada por ser dura, noble y de larga duración. Se ha convertido en el material ideal para fabricar utensilios de cocina: no absorbe los líquidos y es de fácil limpieza, ya que se puede poner en el lavavajillas. Además, es un material no poroso, idóneo para evitar alérgenos.

Boxwood is a shrub scarce in nature. It is a type of wood handcrafted and appreciated for being hard, noble, and long lasting. It has become the ideal material for making kitchen utensils: it does not absorb liquids and is easy to clean, as it can be put in the dishwasher. In addition, it is a non-porous material, ideal to avoid allergens.



Jamonero de madera modelo Góndola

*Góndola model
wooden ham
holder*

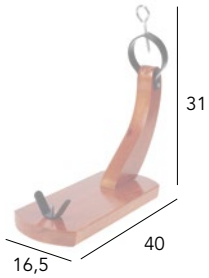

MATERIAL
MATERIAL

Madera nacional de primera
calidad con herrajes de hierro
pintados en negro epoxi.
*Top quality national wood with
iron fittings painted in black
epoxy.*

REF.

03438

LONGITUD
LENGTH

40



6 U./PACK

Jamonero ideal para cortar
en posición horizontal.

*Ham holder ideal for
cutting in a horizontal
position.*

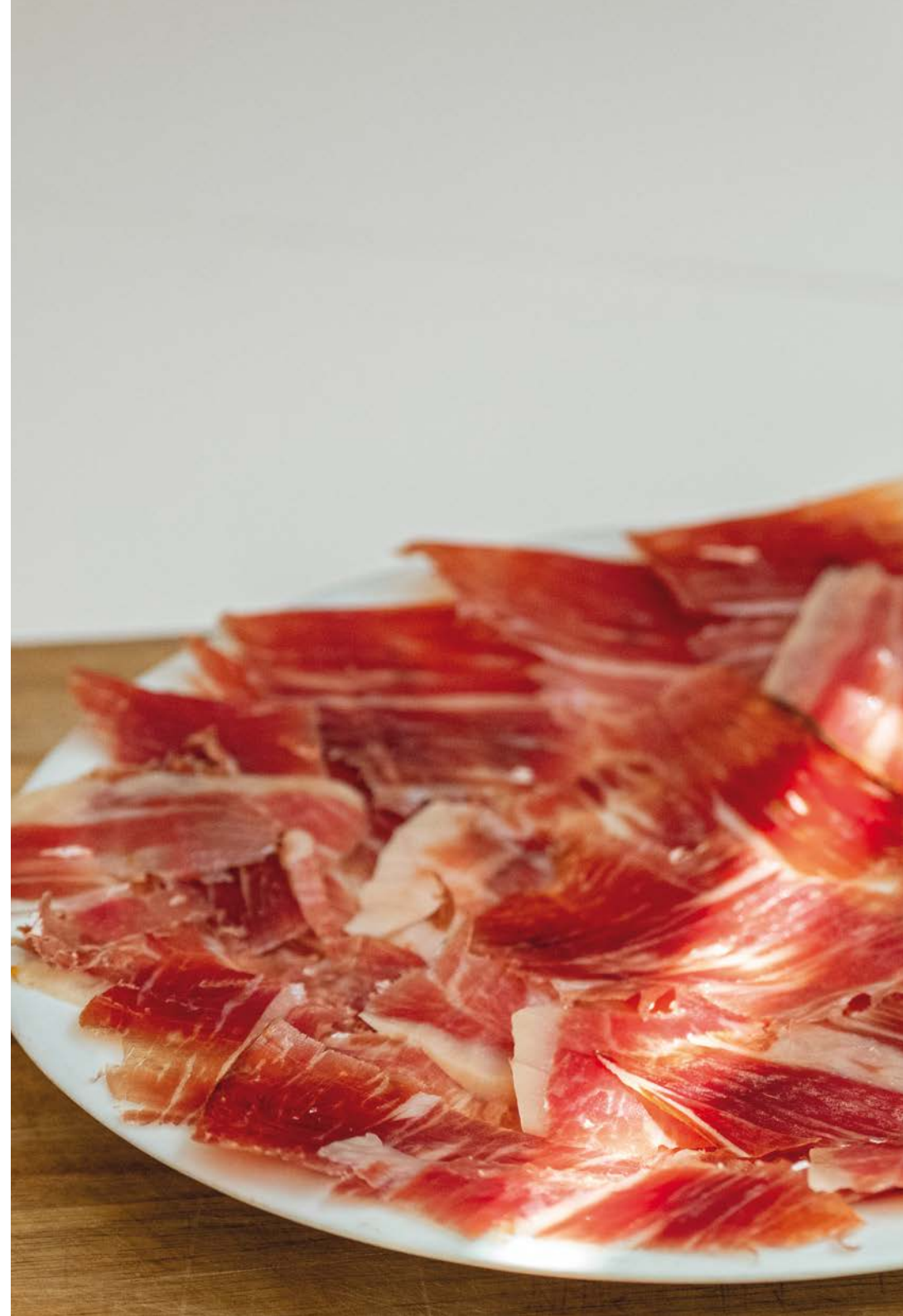



**Jamoneiro
de madera
modelo
Bodega**

*Bodega model
wooden ham
holder*

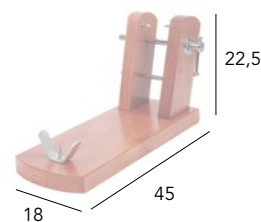

**MATERIAL
MATERIAL**

Madera nacional de primera calidad con herrajes de hierro pintados en negro epoxi.
Top quality national wood with iron fittings painted in black epoxy.

REF.	LONGITUD LENGTH
03440	45



3 U./PACK

Jamoneiro ideal para cortar en posición horizontal.

Ham holder ideal for cutting in a horizontal position.





La parrilla cumple con los requisitos del documento publicado en 2013 por el Consejo de Europa:

The grill complies with the requirements of the document published in 2013 by the Council of Europe:

"Metals and alloys used in food contact materials and articles"



PH<4,5

La parrilla cumple con los requisitos del documento publicado en 2013 por el Consejo de Europa excepto para alimentos ácidos (PH<4,5):

The grill complies with the requirements of the document published in 2013 by the Council of Europe except for acidic foods (PH<4.5):

"Metals and alloys used in food contact materials and articles"

Parrillas y BBQ

Grills and BBQ

En Sauvic tenemos la gama de parrillas más amplia del mercado. Pescado, carne, verduras, alcachofas... hay modelos para todo tipo de comidas.

Nuestras barbacoas de sobremesa están pensadas para poder disfrutar de una buena brasa en la mesa, al estilo "fondue". ¿Cocinar o mantener en caliente? ¡Tenemos todas las opciones!

Tanto las parrillas como las barbacoas están fabricadas con acero zincado o con acero inoxidable 18/8, garantizando una total seguridad al cocinar y asegurando una larga durabilidad.

In Sauvic we have the widest range of grills on the market. Fish, meat, vegetables, artichokes... there are models for all kinds of meals.

Our barbecues are designed to enjoy a good roast at the table, style "fondue". Cook or keep warm? We have all the options!

Both grills and barbecues are made of zinc-plated steel or 18/8 stainless steel, ensuring total safety when cooking and ensuring long durability.

Parrilla doble de acero inoxidable 18/8

18/8 Stainless steel double grill

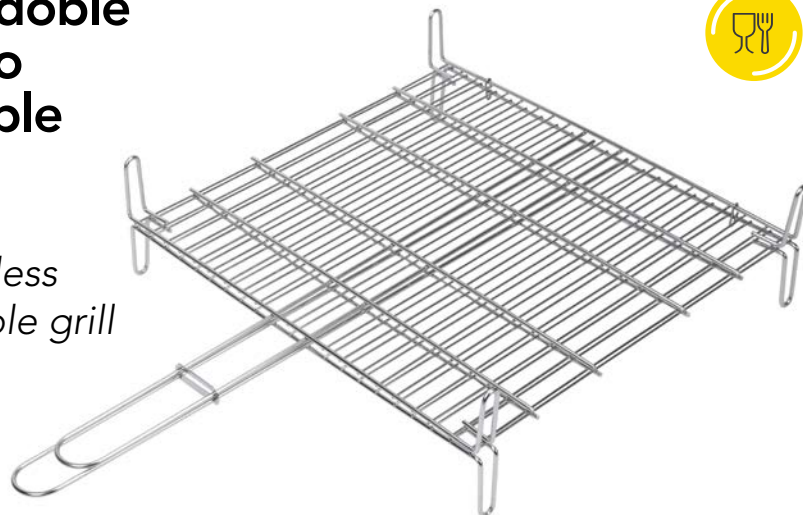

MATERIAL
MATERIAL

Acero inoxidable 18/8 (AISI 304) electropulido. Electropolished (AISI 304) 18/8 stainless steel.

GROSOR
THICKNESS
3 - 5 mm

REF.	MEDIDAS MESURES AxB	ALTURA HEIGHT C
02678	20 x 25	15,5
02679	25 x 30	15,5
02680	30 x 35	15,5
02682	35 x 40	15,5
02685	40 x 45	15,5
02686	50 x 50	15,5

3 U./PACK

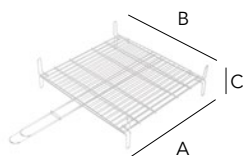

Parrilla reforzada, con más varillas y más gruesas que las parrillas convencionales.

Reinforced grill, with more rods and thicker than conventional grills.

Mango con cierre de seguridad, que permite un giro fácil y seguro. Apta para lavavajillas.

Handle with safety lock, which enables easy and safe turning. Dishwasher safe.

Parrilla doble

Double grill

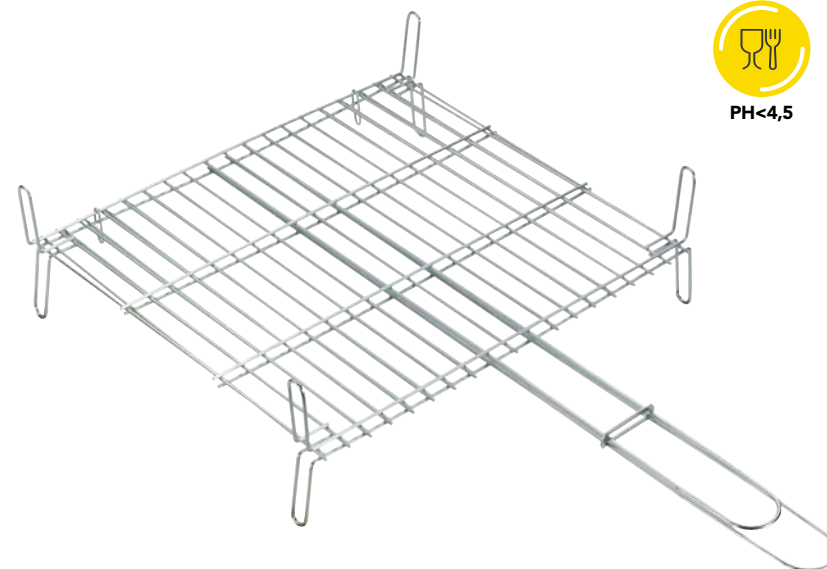

PH<4,5

MATERIAL
MATERIAL

Acero zincado
Zinc plated steel

GROSOR
THICKNESS
2,9 - 4,4 mm

REF.	MEDIDAS MESURES AxB	ALTURA HEIGHT C
02630	20 x 25	15,5
02635	25 x 30	15,5
02640	30 x 35	15,5
02645	35 x 40	15,5
02650	40 x 45	15,5
02655	50 x 50	15,5

5 U./PACK

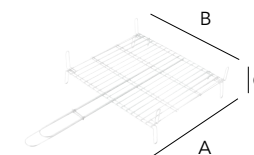

Mango con cierre de seguridad, que permite un giro fácil y seguro.

Handle with safety lock, which enables easy and safe turning.

Parrilla doble 65 x 40 cm

Double grill
65 x 40 cm



 MATERIAL
MATERIAL
Acero zincado
Zinc plated steel

 GROSOR
THICKNESS
3 - 5 mm

REF.	MEDIDAS MESURES AxB	ALTURA HEIGHT C
02657	40 x 65	20

 3 U./PACK

Mangos dobles con sistema de cierre de seguridad para facilitar su uso.

Double handles with safety locking system to facilitate its use.

Parrilla doble reforzada

Reinforced
double grill



 MATERIAL
MATERIAL
Acero zincado
Zinc plated steel

 GROSOR
THICKNESS
4 - 6 mm

REF.	MEDIDAS MESURES AxB	ALTURA HEIGHT C
2660	35 x 40	20
2665	40 x 45	20
2670	50 x 50	20

 3 U./PACK

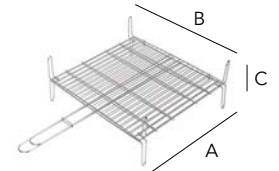

Parrilla reforzada, con más varillas y más gruesas que las parrillas convencionales.

Reinforced grill, with more rods and thicker than conventional grills.

Mango con cierre de seguridad, que permite un giro fácil y seguro. Patas más altas.

Handle with safety lock, which enables easy and safe turning. Higher legs



Parrilla zincada pescado, carne, verduras

Zinc plated grill
for meat, fish or
vegetables



PH<4,5

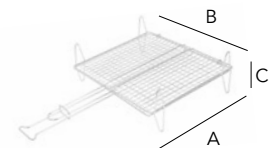
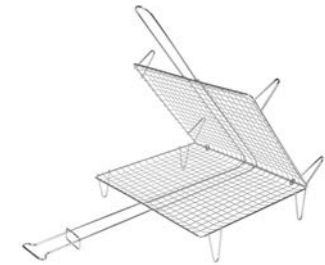
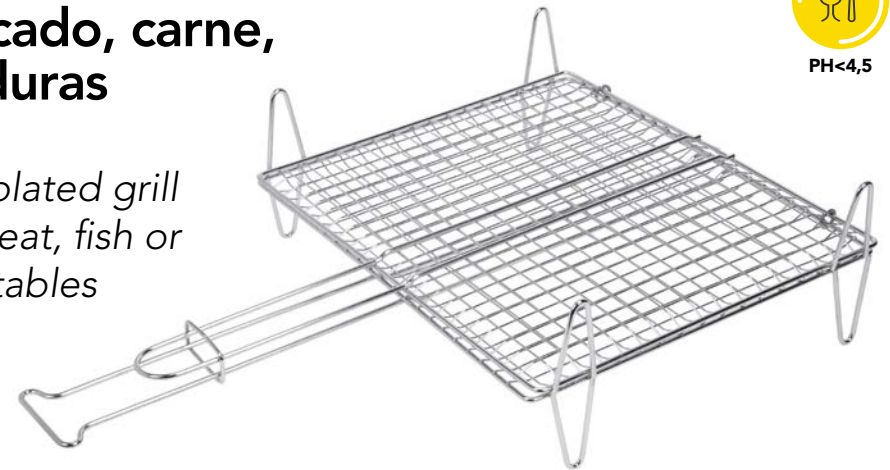

 MATERIAL
MATERIAL

Acero zincado
Zinc plated steel

 GROSOR
THICKNESS

2,4 - 4 mm

REF.	MEDIDAS MESURES AxB	ALTURA HEIGHT C
02588	20 x 25	17,5
02589	25 x 30	17,5
02590	30 x 35	17,5
02591	35 x 40	17,5
02593	40 x 45	17,5
02594	50 x 50	17,5

 3 U./PACK

Parrilla doble con forma abombada para no dañar la comida (pescado, carne, verduras,...).

Double grill with convex shape so as not to damage the food (fish, meat, vegetables, etc.).

Cuadrículada para evitar que los trozos pequeños se caigan al fuego. Mango con cierre de seguridad, que permite un giro fácil y seguro.

Gridded to prevent small pieces from falling into the fire. Handle with safety lock, which enables easy and safe turning.

Parrilla de acero inoxidable 18/8 pescado, carne, verduras



18/8 Stainless steel grill for meat, fish or vegetables

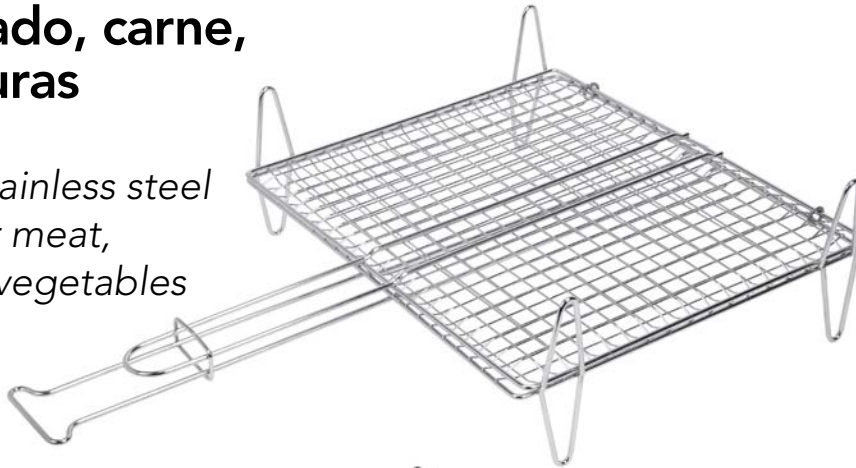

MATERIAL
MATERIAL

Acero inoxidable 18/8 (AISI 304) electropulido
Electropolished (AISI 304)
18/8 stainless steel

GROSOR
THICKNESS
2,4 - 4 mm

REF.	MEDIDAS MESURES Ax B	ALTURA HEIGHT C
02592	25 x 30	17,5
02595	30 x 35	17,5
02596	35 x 40	17,5
02597	40 x 45	17,5
02598	50 x 50	17,5

 **3 U./PACK**

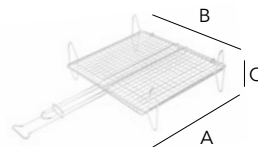
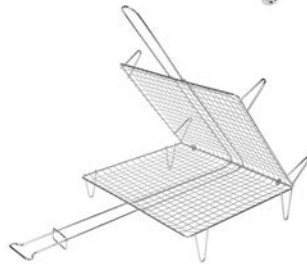

Parrilla doble con forma abombada para no dañar la comida (pescado, carne, verduras,...).
Apta para lavavajillas.

*Double grill with convex shape so as not to damage the food (fish, meat, vegetables, etc.).
Dishwasher safe.*

Cuadrículada para evitar que los trozos pequeños se caigan al fuego.
Mango con cierre de seguridad, que permite un giro fácil y seguro.

*Gridded to prevent small pieces from falling into the fire.
Handle with safety lock, which enables easy and safe turning.*

Parrilla zincada pescado, carne, verduras sin patas



PH<4,5

Zinc plated grill for meat, fish or vegetables without legs

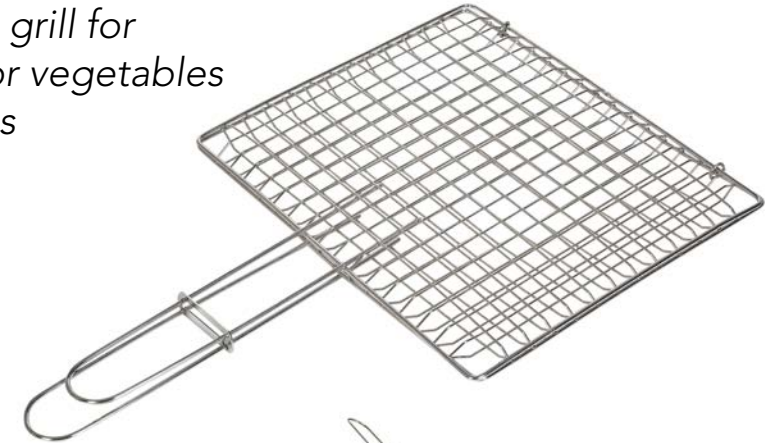

MATERIAL
MATERIAL

Acero zincado
Zinc plated steel

GROSOR
THICKNESS
2,4 - 4 mm

REF.	MEDIDAS MESURES Ax B
02600	30 x 35
02602	40 x 45

 **3 U./PACK**

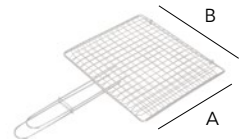

Parrilla doble con forma abombada para no dañar la comida (pescado, carne, verduras,...).

Double grill with convex shape so as not to damage the food (fish, meat, vegetables, etc.).

Cuadrículada para evitar que los trozos pequeños se caigan al fuego.
Mango con cierre de seguridad, que permite un giro fácil y seguro.

*Gridded to prevent small pieces from falling into the fire.
Handle with safety lock, which enables easy and safe turning.*



Parrilla besuguera de acero inoxidable 18/8

18/8 Stainless steel
fish grill

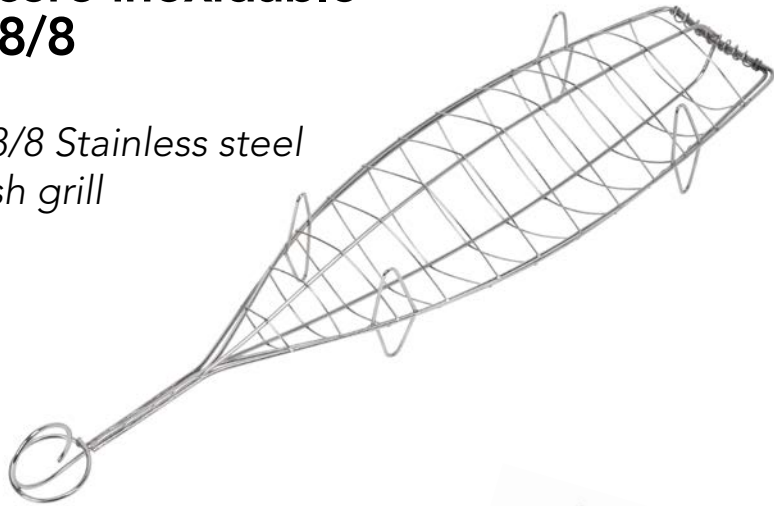

MATERIAL
MATERIAL

Acero inoxidable 18/8
(AISI 304) electropulido
Electropolished (AISI 304)
18/8 stainless steel

GROSOR
THICKNESS
2,5 - 3 mm

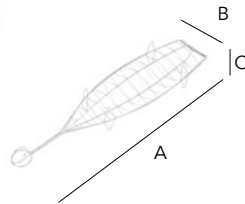

REF.	MEDIDAS MESURES AxB	ALTURA HEIGHT C
02610	54 x 13,5	8

3 U./PACK

Parrilla especial para piezas de pescado enteras, es doble, con forma abombada para no dañar el pescado.

Special grill for whole pieces of fish, it is double, with a convex shape so as not to damage the fish.

Mango con cierre de seguridad, que permite un giro fácil y seguro. Apta para lavavajillas.

Handle with safety lock, which enables easy and safe turning. Dishwasher safe.

Parrilla besuguera de acero inoxidable 18/8 para pescados grandes

18/8 Stainless steel
fish grill for
large fish



MATERIAL
MATERIAL

Acero inoxidable 18/8
(AISI 304) electropulido
Electropolished (AISI 304)
18/8 stainless steel

GROSOR
THICKNESS
2,5 - 3 mm

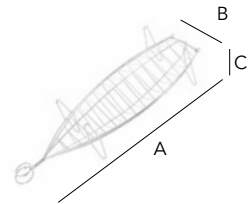

REF.	MEDIDAS MESURES AxB	ALTURA HEIGHT C
02612	60 x 19	14

2 U./PACK

Parrilla especial para piezas de pescado enteras, es doble, con forma abombada para no dañar el pescado.

Special grill for whole pieces of fish, it is double, with a convex shape so as not to damage the fish.

Mango con cierre de seguridad, que permite un giro fácil y seguro. Apta para lavavajillas.

Handle with safety lock, which enables easy and safe turning. Dishwasher safe.

Parrilla para verduras (alcachofas)

Grill for vegetables
(artichokes)



PH<4,5



MATERIAL
MATERIAL

Acero zincado
Zinc plated steel



GROSOR
THICKNESS

4,9 mm

REF.	CAVIDADES CAVITIES	MEDIDAS MESURES AxB	ALTURA HEIGHT C
02615	6	24,5 x 17,5	8,5
02620	9	25 x 25	8,5
02625	12	33,5 x 25	8,5



5 U./PACK

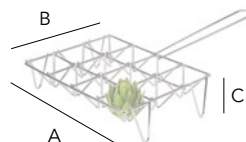

Parrilla especial para cocer verduras (alcachofas, pimientos, patatas, tomates, etc.) a la brasa.

Special grill to cook vegetables (artichokes, peppers, potatoes, tomatoes, etc.) on the grill.





Parrilla barbacoa redonda de acero inoxidable 18/8 (Ø47 cm)

18/8 Stainless steel round barbecue grill (Ø47 cm)

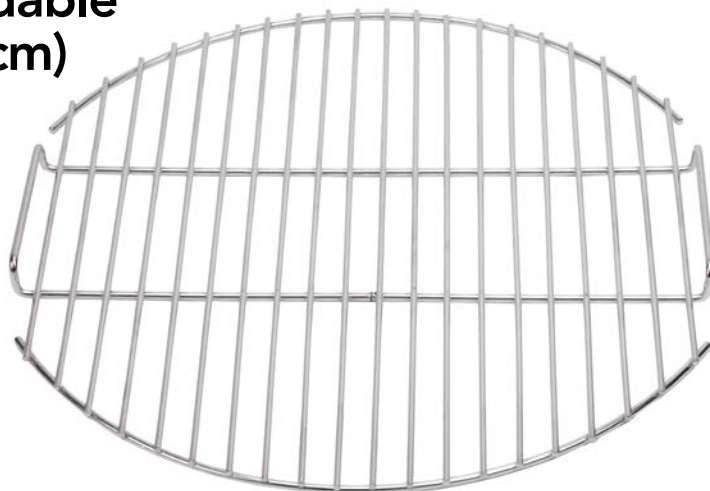

MATERIAL

Acero inoxidable 18/8 (AISI 304) electropulido
Electropolished (AISI 304)
18/8 stainless steel

GROSOR THICKNESS

4 - 5 mm

REF.	MEDIDAS MESURES
------	-----------------

02860	Ø 44,5
--------------	--------

3 U./PACK



Compatible con la mayoría de barbacoas de 47 cm. de diámetro del mercado. Apta para lavavajillas.

Compatible with most 47cm diameter barbecues on the market. Dishwasher safe.

Parrilla simple

Simple grill

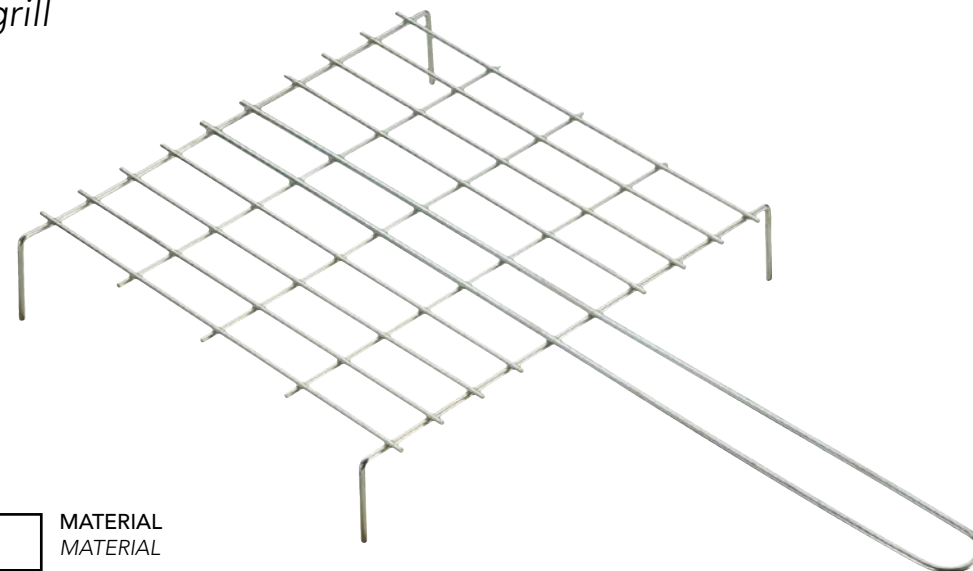

MATERIAL

Acero zincado
Zinc plated steel

GROSOR THICKNESS

2,9 - 4,4 mm

REF.	MEDIDAS MESURES AxB	ALTURA HEIGHT C
------	---------------------	-----------------

02715	35 x 35	7
02720	40 x 40	7,5

10 U./PACK



PH<4,5

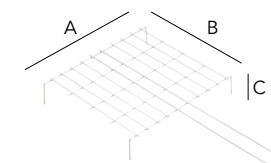

Parrilla chimenea con 3 patas

Fireplace grill with 3 legs

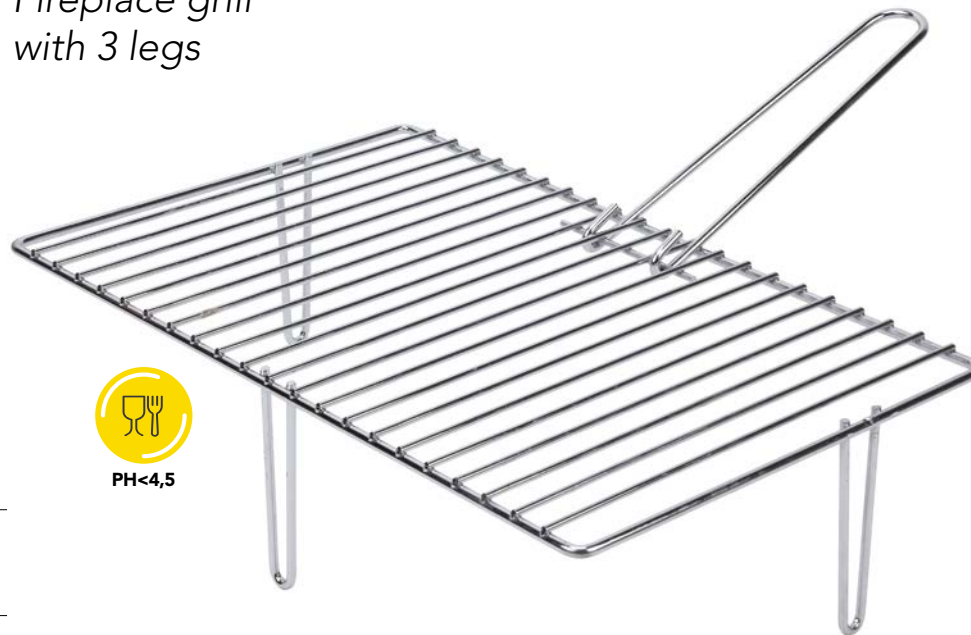

MATERIAL
MATERIAL
Acero zincado
Zinc plated steel



PH<4,5

GROSOR
THICKNESS
4 - 6 mm

REF.	MEDIDAS MESURES	ALTURA HEIGHT
------	--------------------	------------------

02864	46,6 x 28	12
--------------	-----------	----

MATERIAL
MATERIAL
Acero inoxidable 18/8
(AISI 304) electropulido
Electropolished (AISI 304)
18/8 stainless steel



GROSOR
THICKNESS
4 - 6 mm

REF.	MEDIDAS MESURES Ax B	ALTURA HEIGHT C
------	----------------------------	-----------------------

02866	46,6 x 28	12
--------------	-----------	----

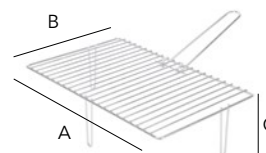

Con un mango extraíble, que se puede quitar una vez puesta la parrilla en el fuego y así, cuando se quiere mover o retirar la parrilla, se vuelve a colocar el mango y no te quemas al cogerlo.
Apta para lavavajillas.

With a removable handle, which can be removed once the grill has been placed on the fire and therefore, when you want to move or remove the grill, the handle is put back on and you do not burn yourself when you pick it up.
Dishwasher safe.

 **3 U./PACK**

Parrilla barbacoa zincada con patas

Zinc plated
barbecue grill
with legs

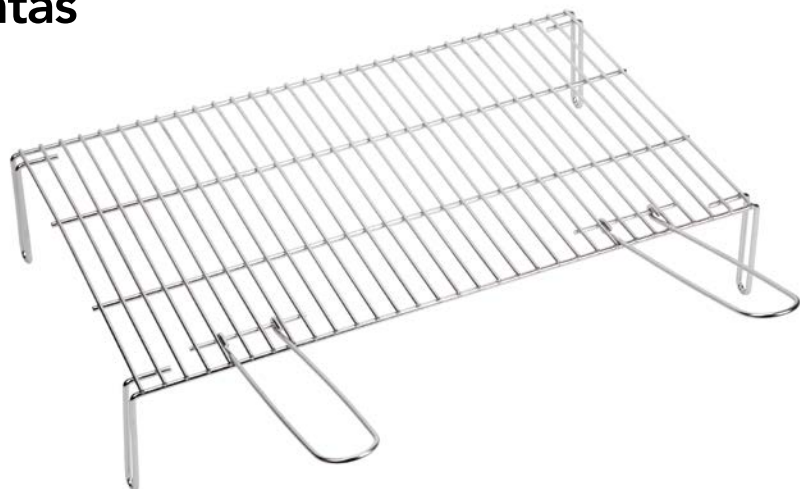

PH<4,5



MATERIAL
MATERIAL

Acero zincado
Zinc plated steel



GROSOR
THICKNESS

4 - 6 mm



MANGOS PLEGABLES
FOLDING HANDLES

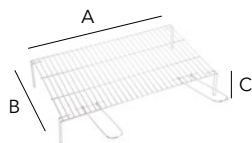

REF.	MEDIDAS MEASURES AxB	ALTURA HEIGHT C
02450	55 x 40	14
02455	65 x 40	14
02460	75 x 40	14

3 U./PACK

Mangos plegables.
Apta para lavavajillas.

Folding handles.
Dishwasher safe.

Parrilla barbacoa de acero inoxidable 18/8 con mangos plegables

18/8 Stainless
steel barbecue
grill with foldable
handles

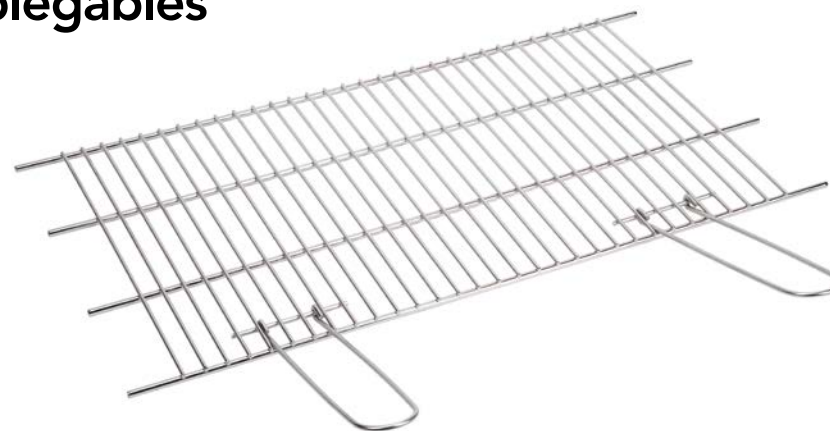

MATERIAL
MATERIAL

Acero inoxidable 18/8
(AISI 304) electropulido
Electropolished (AISI 304)
18/8 stainless steel



GROSOR
THICKNESS

4 - 6 mm

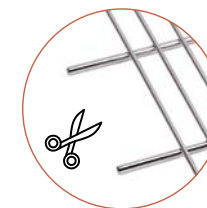

**VARILLAS
RECORTABLES**
CUT-OUT RODS

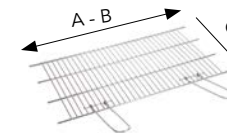

REF.	MEDIDAS MEASURES AxC	RECORTABLE CUT-OUT RODS A ↔ B
02745	60 x 40	52 - 62
02750	70 x 40	62,5 - 72,5
02755	80 x 40	73 - 82

3 U./PACK

Se puede cortar fácilmente a medida con la ayuda de una amoladora eléctrica o una sierra de arco con hoja para cortar acero.

It can be easily cut to size with the aid of an electric grinder or hand saw with a steel cutting blade.



Mangos plegables.
Apta para lavavajillas.

Folding handles.
Dishwasher safe.



Acero zincado

El acero zincado se caracteriza por contener zinc que protege al acero aportándole una mayor resistencia a la corrosión.

Este tipo de material, utilizado para fabricar algunas de nuestras parrillas y barbacoas, nos garantiza los requisitos necesarios para el contacto alimentario. Otra ventaja del acero zincado es que permite crear piezas más suaves y uniformes, fabricando así piezas más estéticas sin renunciar a la seguridad.

Zinc plated steel

The zinc plated steel is characterized by containing zinc that protects the steel giving it a greater resistance to corrosion. This type of material, used to make some of our grills and barbecues, guarantees us the necessary requirements for food contact.

Another advantage of zinc plated steel is that it allows to create softer and more uniform parts, thus manufacturing more aesthetic parts without renouncing safety.

Parrilla barbacoa zincada con mangos de madera

Zinc plated
barbecue grill
with wooden
handles



MATERIAL
MATERIAL
Acero zincado
Zinc plated steel

GROSOR
THICKNESS
4 - 6 mm

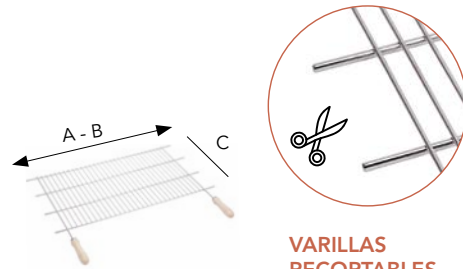

**VARILLAS
RECORTABLES
CUT-OUT RODS**

Se puede cortar fácilmente a medida con la ayuda de una amoladora eléctrica o una sierra de arco con hoja para cortar acero.

It can be easily cut to size with the aid of an electric grinder or hand saw with a steel cutting blade.



Con mangos de madera resistentes al calor que proporcionan un agarre seguro y cómodo.

With heat-resistant wooden handles that provide a secure and comfortable grip.

3 U./PACK

Parrilla barbacoa zincada grande con mangos de madera

Large zinc plated
barbecue grill
with wooden
handles

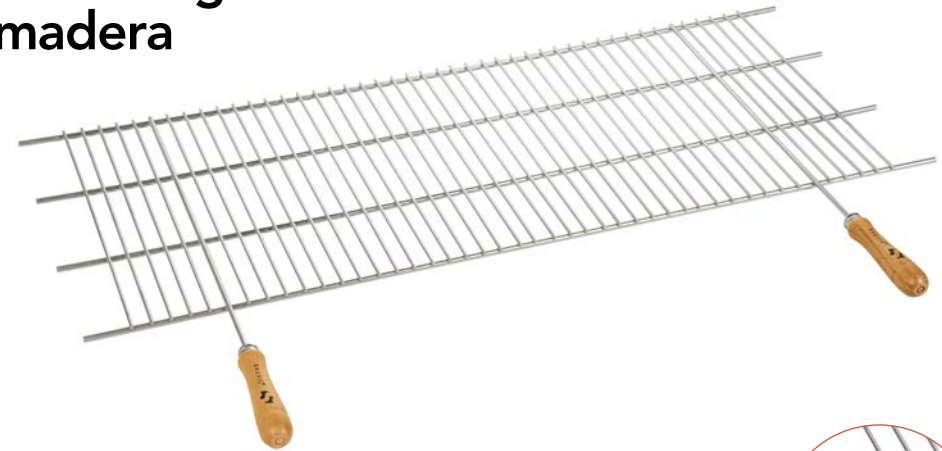

MATERIAL
MATERIAL
Acero zincado
Zinc plated steel

GROSOR
THICKNESS
4 - 7 mm

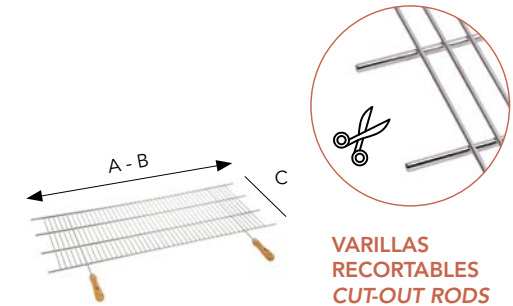

**VARILLAS
RECORTABLES
CUT-OUT RODS**

Se puede cortar fácilmente a medida con la ayuda de una amoladora eléctrica o una sierra de arco con hoja para cortar acero.

It can be easily cut to size with the aid of an electric grinder or hand saw with a steel cutting blade.



Con mangos de madera resistentes al calor que proporcionan un agarre seguro y cómodo.

With heat-resistant wooden handles that provide a secure and comfortable grip.

3 U./PACK

REF.	MEDIDAS MESURES AxC	RECORTABLE CUT-OUT RODS A ↔ B
02465	60 x 40	52 - 62
02470	70 x 40	62,5 - 72,5
02475	80 x 40	73 - 82

REF.	MEDIDAS MESURES AxC	RECORTABLE CUT-OUT RODS A ↔ B
02480	100 x 40	82 - 102
02485	100 x 50	82 - 102

Parrilla barbacoa de acero inoxidable 18/8 con mangos de madera

18/8 Stainless steel barbecue grill with wooden handles



MATERIAL

Acero inoxidable 18/8 (AISI 304) electropulido
Electropolished (AISI 304)
18/8 stainless steel

GROSOR

THICKNESS

4 - 6 mm

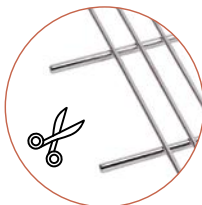
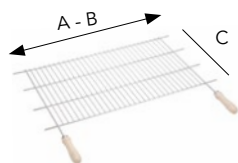

VARILLAS RECORTABLES
CUT-OUT RODS

Se puede cortar fácilmente a medida con la ayuda de una amoladora eléctrica o una sierra de arco con hoja para cortar acero.

It can be easily cut to size with the aid of an electric grinder or hand saw with a steel cutting blade.



Con mangos de madera resistentes al calor que proporcionan un agarre seguro y cómodo.

With heat-resistant wooden handles that provide a secure and comfortable grip.

3 U./PACK

Parrilla barbacoa de acero inoxidable 18/8 en V

V-shaped 18/8 stainless steel barbecue grill



MATERIAL

Acero inoxidable 18/8 (AISI 304) electropulido
Electropolished (AISI 304)
18/8 stainless steel

GROSOR

THICKNESS

4 - 7 mm

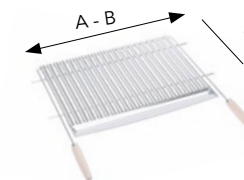

VARILLAS RECORTABLES
CUT-OUT RODS

Fabricada con planchas en forma de V que recogen la grasa y gracias a su inclinación, la conducen hasta el recogedor de la parte inferior, evitando que caiga en el fuego. Apta para lavavajillas.

Made with V-shaped plates that collect the fat and, thanks to its inclination, lead it to the catcher at the bottom, preventing it from falling into the fire. Dishwasher safe.

REF.	MEDIDAS MESURES AxC	RECORTABLE CUT-OUT RODS A ↔ B
02790	60 x 44	56,5 - 65,5
02795	70 x 44	66,5 - 75,5
02797	80 x 44	74,5 - 83,5

02790 60 x 44 56,5 - 65,5

02795 70 x 44 66,5 - 75,5

02797 80 x 44 74,5 - 83,5

3 U./PACK



Se puede cortar fácilmente a medida con la ayuda de una amoladora eléctrica o una sierra de arco con hoja para cortar acero.

It can be easily cut to size with the aid of an electric grinder or hand saw with a steel cutting blade.

Parrilla barbacoa extensible

Extendable barbecue grill



**EXTENSIBLE
EXTENSIBLE**

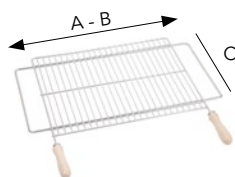

3 U./PACK

**ÚNICO EN EL MERCADO
UNIQUE IN THE MARKET**



MATERIAL
MATERIAL
Acero zincado
Zinc plated steel



GROSOR
THICKNESS
4 - 8 mm

REF.	MEDIDAS MESURES A x C	EXTENSIBLE EXTENDABLE A ↔ B
02722	50 x 40	52 - 62
02724	60 x 40	62 - 72
02726	70 x 40	72 - 82

MATERIAL
MATERIAL
Acero inoxidable 18/8
(AISI 304) electropulido
Electropolished (AISI 304)
18/8 stainless steel



GROSOR
THICKNESS
4 - 8 mm



REF.	MEDIDAS MESURES	EXTENSIBLE EXTENDABLE A ↔ B
02810	50 x 40	52 - 62
02815	60 x 40	62 - 72
02820	70 x 40	72 - 82

Parrilla con marco extensible que se adapta a cualquier medida de barbacoa sin necesidad de cortar o hacer una parrilla a medida.

Grill with extendable frame that adapts to any barbecue size without the need to cut or make a grill to size.

Con mangos de madera resistentes al calor que proporcionan un agarre seguro y cómodo.

With heat-resistant wooden handles that provide a secure and comfortable grip.



Parrilla extensible 60 x 40 cm. + 2 parrillas dobles extraíbles

Extendable grill
60 x 40 cm. +
2 removable
double grills



PH<4,5

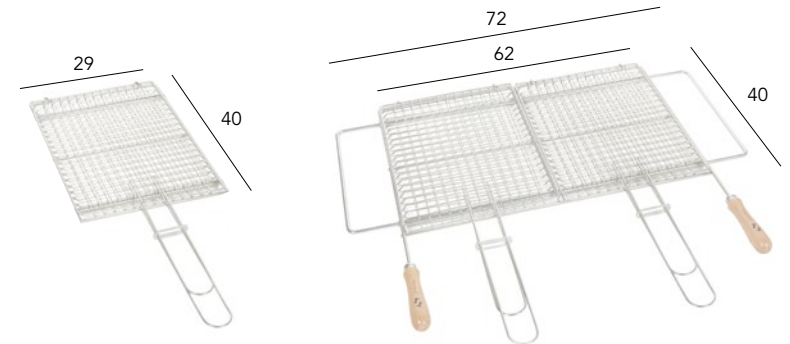

MATERIAL
MATERIAL
Acero zincado
Zinc plated steel

GROSOR
THICKNESS
4 - 8 mm

REF.	MEDIDAS MESURES	EXTENSIBLE EXTENDABLE A ↔ B
02585	60 x 40	62 - 72

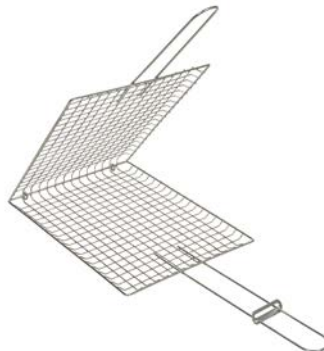

Con dos parrillas dobles extraíbles que se pueden usar con esta estructura o independientemente. Las parrillas dobles permiten girar la comida cómodamente y, además, tienen forma abombada para no dañar el pescado, la carne o las verduras, son cuadrículadas para evitar que los trozos pequeños se caigan al fuego y tienen cierre de seguridad.

With two removable double grills that can be used with this structure or independently. The double grills allow you to turn the food comfortably and, in addition, they have a convex shape so as not to damage the fish, meat or vegetables, they are gridded to prevent small pieces from falling into the fire and they have a safety lock.

Parrilla con marco extensible que se adapta a cualquier medida de barbacoa sin necesidad de cortar o hacer una parrilla a medida.

Apta para lavavajillas.
Grill with extendable frame that adapts to any barbecue size without the need to cut or make a grill to size.
Dishwasher safe.

Con mangos de madera resistentes al calor que proporcionan un agarre seguro y cómodo.

With heat-resistant wooden handles that provide a secure and comfortable grip.

2 U./PACK

Expositor de parrillas

Display stand for grills



REF.

02721

 **1 U./PACK**

Incluye pantallas de plástico para marcar los precios. Con cartel serigrafiado a todo color por las dos caras.



It includes the plastic screens to put the prices. With printed poster for both sides.



PROMOCIÓN

Expositor de regalo con la compra de 1400€ en parrillas o comprando el expositor y descontando un 10% del importe de parrillas en cada factura hasta llegar al total.

PROMOTION

Display stand for free with a purchase of 1400€ in grills or buying this display stand and discounting a 10% in every invoice until the total cost.

Barbacoa de sobremesa con parrilla inoxidable 18/8 de 30x25 cm.

Tabletop barbecue with 30x25 cm. 18/8 stainless steel grill



MATERIAL MATERIAL

Barbacoa robusta de hierro pintado con pintura anticálórica y parrilla de acero inoxidable 18/8 electropulido.
Sturdy iron barbecue painted with heat-resistant paint and electropolished 18/8 stainless steel grill.

REF.	MEDIDAS MESURES
02906	30 x 25 x 14

 1 U./PACK

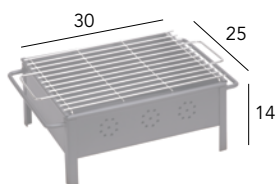

La barbacoa cumple con los requisitos de la normativa UNE-EN 1860-1 Aparatos, combustibles sólidos y sistemas de encendido para el asado en barbacoas. Parte 1: Barbacoas que utilizan combustibles sólidos.

The barbecue complies with the requirements of the UNE-EN 1860-1 standard on appliances, solid fuels and ignition systems for barbecues. Part 1: Barbecues that use solid fuels.



La parrilla cumple con los requisitos del documento publicado en 2013 por el Consejo de Europa:

The grill complies with the requirements of the document published in 2013 by the Council of Europe:

"Metals and alloys used in food contact materials and articles"

Ideal para poner encima de la mesa y disfrutar de una comida en familia o amigos, en la que cada comensal puede acabar de hacerse la comida a su punto.

Ideal to put on the table and enjoy a meal with family or friends, in which each dinner guest can cook their food the way they like it.

Con agujeros de ventilación que permiten la circulación de aire para que así el fuego se encienda más rápido y se mantenga. Incluye rejilla interior reforzada para el carbón.

With ventilation holes that allow air to circulate so that the fire lights up faster and is maintained. Includes reinforced inner grill for charcoal.

Incluye una base de madera para proteger la mesa del calor de las brasas.

It includes a wooden base to protect the table from the heat of the embers.



Barbacoa de sobremesa con parrilla inoxidable 18/8 de 25x20 cm.

Tabletop barbecue with 25x20 cm. 18/8 stainless steel grill



MATERIAL MATERIAL

Barbacoa robusta de hierro pintado con pintura anticorrosiva y parrilla de acero inoxidable 18/8 electropulido.
Sturdy iron barbecue painted with heat-resistant paint and electropolished 18/8 stainless steel grill.



Ideal para poner encima de la mesa y disfrutar de una comida en familia o amigos, en la que cada comensal puede acabar de hacerse la comida a su punto.

Ideal to put on the table and enjoy a meal with family or friends, in which each dinner guest can cook their food the way they like it.

Con agujeros de ventilación que permiten la circulación de aire para que así el fuego se encienda más rápido y se mantenga. Incluye rejilla interior reforzada para el carbón.

With ventilation holes that allow air to circulate so that the fire lights up faster and is maintained. Includes reinforced inner grill for charcoal.

Incluye una base de madera para proteger la mesa del calor de las brasas.

It includes a wooden base to protect the table from the heat of the embers.

REF.	MEDIDAS MESURES
02905	25 x 20 x 13,5

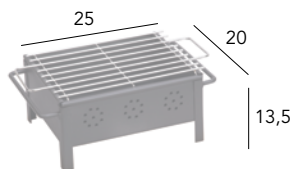

1 U./PACK



Barbacoa de sobremesa con parrilla inoxidable 18/8 de 15x15 cm.

Tabletop barbecue with 15x15 cm. 18/8 stainless steel grill



MATERIAL MATERIAL

Barbacoa robusta de hierro pintado con pintura anticorrosiva y parrilla de acero inoxidable 18/8 electropulido.

Sturdy iron barbecue painted with heat-resistant paint and electropolished 18/8 stainless steel grill.

REF. MEDIDAS
MESURES

02904 15 x 15 x 13,5

 **1 U./PACK**

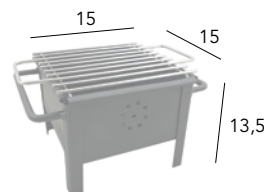

Ideal para poner encima de la mesa y disfrutar de una comida en familia o amigos, en la que cada comensal puede acabar de hacerse la comida a su punto.

Ideal to put on the table and enjoy a meal with family or friends, in which each dinner guest can cook their food the way they like it.

Con agujeros de ventilación que permiten la circulación de aire para que así el fuego se encienda más rápido y se mantenga. Incluye rejilla interior reforzada para el carbón.

With ventilation holes that allow air to circulate so that the fire lights up faster and is maintained. Includes reinforced inner grill for charcoal.

Incluye una base de madera para proteger la mesa del calor de las brasas.

It includes a wooden base to protect the table from the heat of the embers.



Parrilla de sobremesa de acero inoxidable 18/8 con cajón de 25x20 cm.

18/8 Stainless steel tabletop grill with drawer of 25x20 cm.



MATERIAL

Parrilla de acero inoxidable 18/8 (AISI 304) electropulido y cajón de acero con pintura anticorrosiva. Electropolished (AISI 304) 18/8 stainless steel grill and steel drawer with heat resistant paint.

REF. MEDIDAS

02900 25 x 20 x 12,5

 **1 U./PACK**

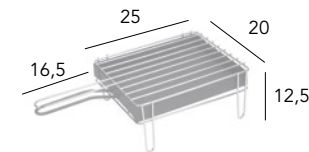

Ideal para colocar las brasas de la barbacoa en el cajón y de este modo acabar de cocer la comida en la mesa y al gusto de cada comensal o mantener la comida caliente.

Ideal for placing the barbecue embers in the drawer and in this way finish cooking the food on the table and to the taste of each diner or to keep the food warm.

Con un mango (tanto la parrilla como el cajón para las brasas) de 16,5 cm.
Con cajón brasa de acero con pintura anticorrosiva de color negro.

*With a handle (both the grill and the drawer for the embers) of 16.5 cm.
With steel ember drawer with black heat resistant paint.*





Cajón barbacoa con parrilla de acero inoxidable 18/8

Barbecue drawer with 18/8 stainless steel grill



MATERIAL

Barbacoa robusta de hierro pintado con pintura anticorrosiva y parrilla de acero inoxidable 18/8 electropulido.
Sturdy iron barbecue painted with heat-resistant paint and electropolished 18/8 stainless steel grill.

REF.	MEDIDAS MESURES A x B
02728	60 x 40 x 29
02729	70 x 40 x 29

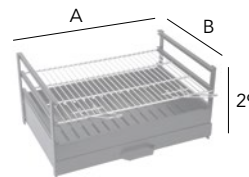

GROSOR
THICKNESS
4 - 8 mm

 **1 U./PACK**



Incluye una parrilla de acero inoxidable 18/8 (AISI 304) electropulido con los mangos plegables.

It includes a electropolished (AISI 304) 18/8 stainless steel grill with foldable handles.

Con cajón recoge cenizas, para facilitar la limpieza.
Con guías a 3 alturas para colocar la/s parrilla/s a diferentes distancias del fuego o las brasas.

With ash catcher, to facilitate cleaning.
With guides at 3 heights to place the grill/s at different distances from the fire or the hot coals.





Jardín Garden

En Sauvic tenemos los imprescindibles para el jardín. Complementos prácticos con diseños simples para llenar de plantas las paredes, ventanas y balcones de los hogares.

Contamos con una extensa gama de soportes para mangueras, de todas las medidas y acabados para mantener el orden en el jardín.

In Sauvic we have the essentials for the garden. Practical accessories with simple designs to fill the walls, windows, and balconies with plants.

We have an extensive range of hose holders, of all sizes and finishes to maintain order in the garden.

Jardineras plastificadas blancas

White plastic-
coated support
for planter

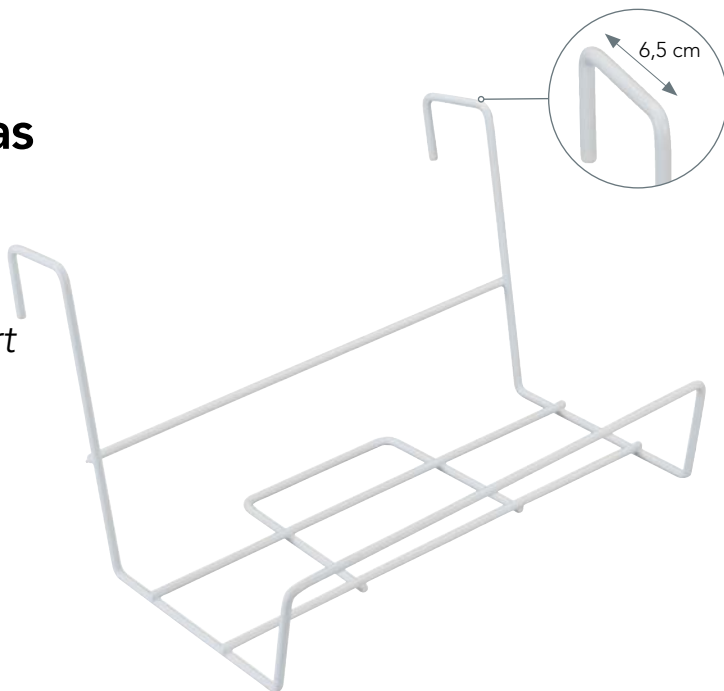
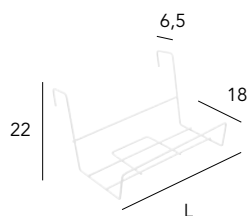

MATERIAL
MATERIAL

Acero con 0,5 mm. de recubrimiento plástico anticorrosivo blanco.
Steel with 0,5 mm. white anti-corrosive plastic coating.



GROSOR
THICKNESS
6 mm

REF.	LONGITUD LENGTH L
03220	40
03225	50
03230	60
03215	Estándar (41)

Soporte para balcones con una baranda de 6 cm de ancho como máximo. *Support for balconies with a maximum 6cm wide railing.*

Esta cobertura ofrece una protección duradera frente a la corrosión, los golpes y rasguños, inclemencias del tiempo y demás agentes contaminantes. *This cover offers long-lasting protection against corrosion, bumps and scratches, bad weather and other contaminating agents.*



10 U./PACK

Jardineras plastificadas negras

Black plastic-
coated support
for planter

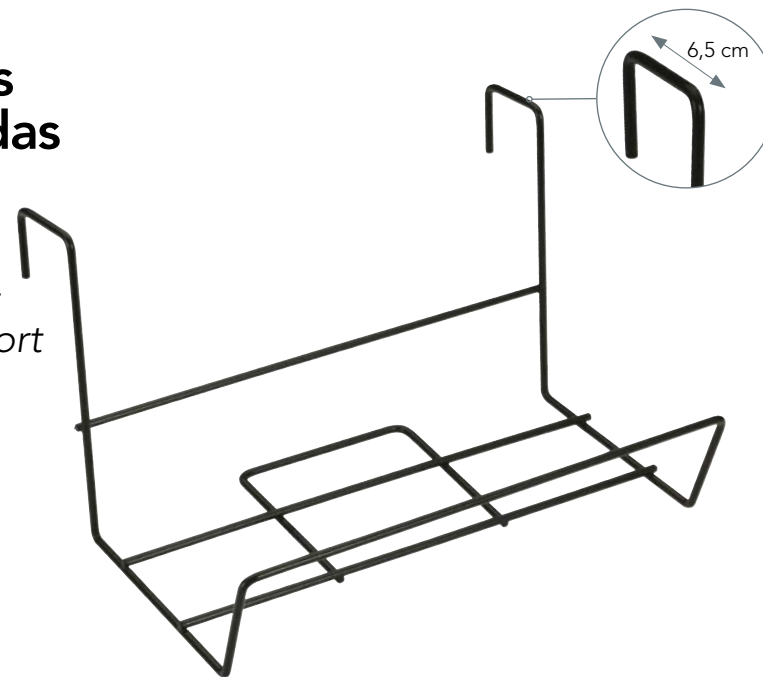
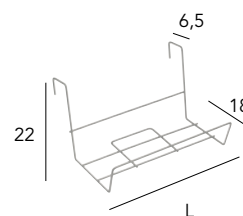

MATERIAL
MATERIAL

Acero con 0,5 mm. de recubrimiento plástico anticorrosivo negro.
Steel with 0,5 mm. black anti-corrosive plastic coating.



GROSOR
THICKNESS
6 mm

REF.	LONGITUD LENGTH L
03240	40
03245	50
03250	60
03235	Estándar (41)

Soporte para balcones con una baranda de 6 cm de ancho como máximo. *Support for balconies with a maximum 6cm wide railing.*

Esta cobertura ofrece una protección duradera frente a la corrosión, los golpes y rasguños, inclemencias del tiempo y demás agentes contaminantes. *This cover offers long-lasting protection against corrosion, bumps and scratches, bad weather and other contaminating agents.*



10 U./PACK

Maceteros de pie zincados

Zinc plated floor
planters

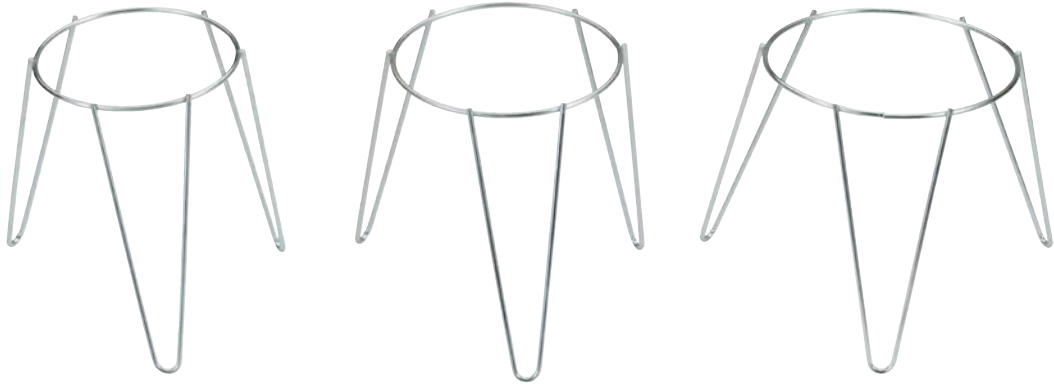

MATERIAL
MATERIAL

Acero zincado.
Zinc plated steel.



GROSOR
THICKNESS

5 - 6 mm



12 U./PACK

REF.	MEDIDAS MEASURES Ø	ALTURA HEIGHT
03060	16	22
03065	18	22
03070	20	22
03075	22	27
03080	24	27



Maceteros de pared zincados

Zinc plated wall planters

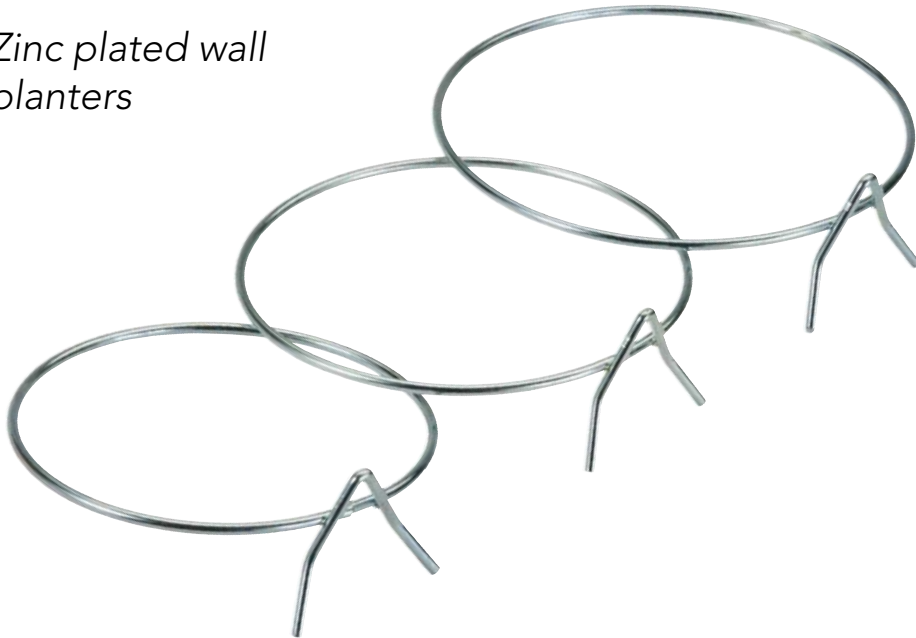

MATERIAL
MATERIAL

Acero zincado.
Zinc plated steel.



GROSOR
THICKNESS

5 - 6 mm



12/48 U./PACK

REF.	MEDIDAS MEASURES Ø
03165	12
03170	14
03175	16
03180	18
03185	20
03190	22
03195	24

Maceteros de balcón ancho zincados

Zinc plated wide balcony planters

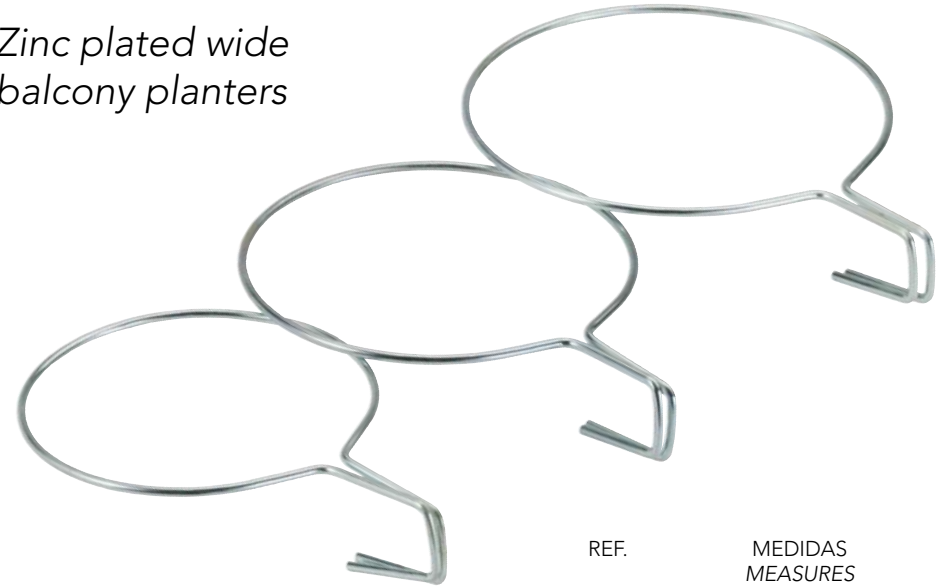

MATERIAL
MATERIAL

Acero zincado.
Zinc plated steel.



GROSOR
THICKNESS

5 - 6 mm



12/48 U./PACK

REF.	MEDIDAS MEASURES Ø
03095	12
03100	14
03105	16
03110	18
03115	20
03120	22
03125	24

Aro para colgar macetas en los balcones.

Apto para barandas de máximo 5 cm. de grueso y 3 cm. de alto.

Ring for hanging pots on the balconies.

Suitable for railings with a maximum thickness of 5 cm. and a height of 3 cm.

Maceteros de balcón estrecho zincados

Zinc plated narrow balcony planters

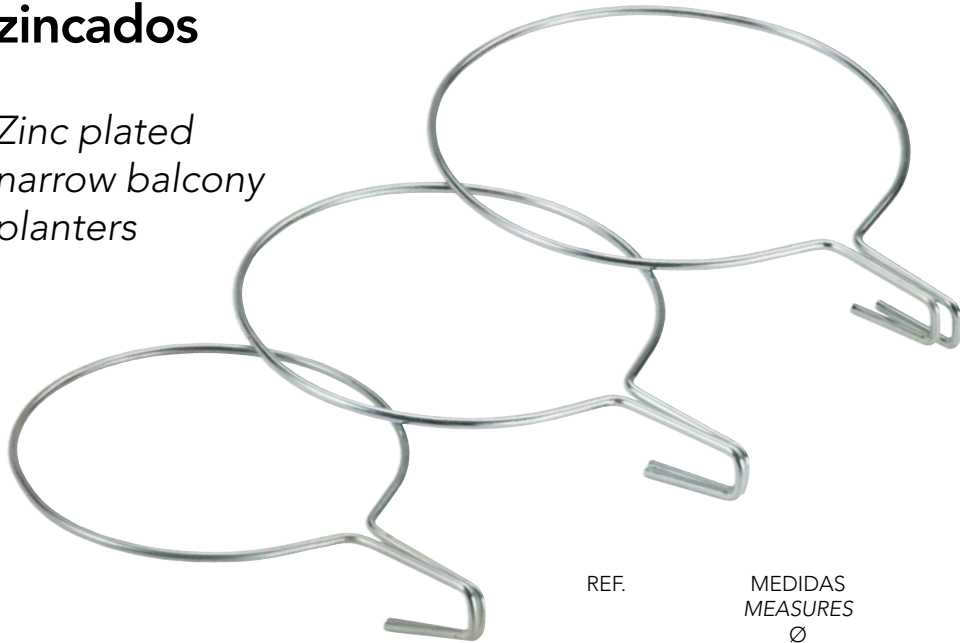

REF.	MEDIDAS MEASURES Ø
03128	12
03130	14
03135	16
03140	18
03145	20
03150	22
03155	24



MATERIAL
MATERIAL

Acero zincado.
Zinc plated steel.



GROSOR
THICKNESS

5 - 6 mm



12/48 U./PACK

Aro para colgar macetas en los balcones.
Ring for hanging pots on the balconies.
Apto para barandas de máximo 5 cm. de grueso y 1,5 cm. de alto.
Suitable for railings with a maximum thickness of 5 cm. and a height of 1,5 cm.



Maceteros de pie altos

Rust-effect planters with high legs

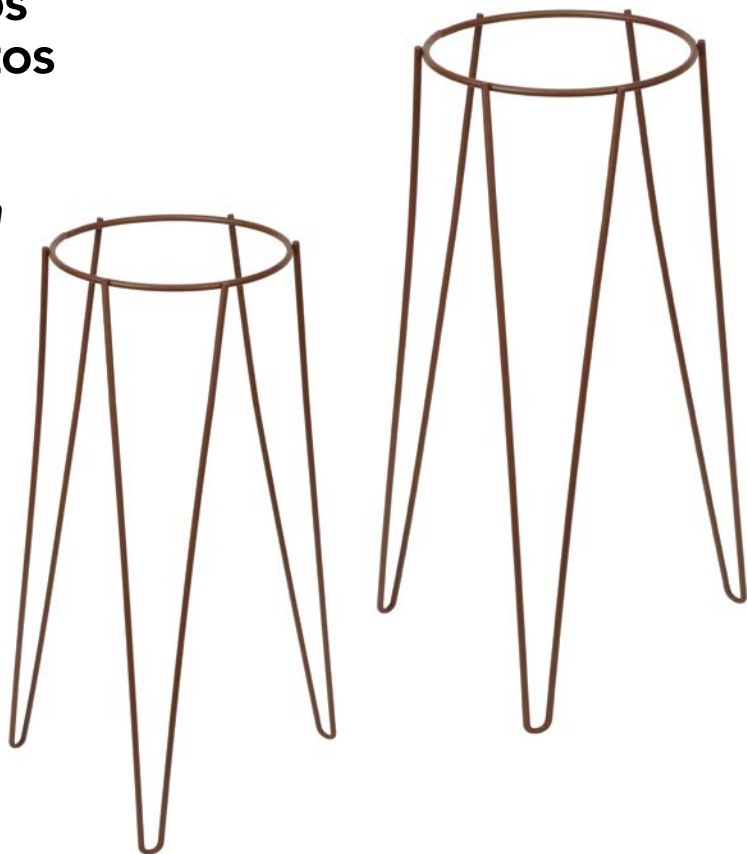

MATERIAL
MATERIAL

Acero de 7 mm. de grosor pintado con pintura cerámica efecto óxido.
7mm thick steel painted with rust-effect ceramic paint.



GROSOR
THICKNESS

7 mm



3 U./PACK

REF.	MEDIDAS MEASURES Ø	ALTURA HEIGHT
03082	20	60
03083	24	60
03085	20	80
03086	24	80

Ideal para plantas colgantes o para realizar una bonita composición de plantas a diferentes alturas.

Ideal for hanging plants or to create a lovely composition of plants at different heights.



Maceteros de pie forjados

Wrought iron planters with legs



MATERIAL
MATERIAL

Pletina de 3 cm. de ancho y 4 mm. de grosor pintada con pintura cerámica efecto óxido.
3 cm wide and 4mm thick shim plate painted with rust-effect ceramic paint.

 2 U./PACK

REF.	MEDIDAS MEASURES Ø	ALTURA HEIGHT
03090	30	30,5
03091	35	37



Soporte de manguera pequeño plastificado gris

Small grey plastic-coated steel hose holder

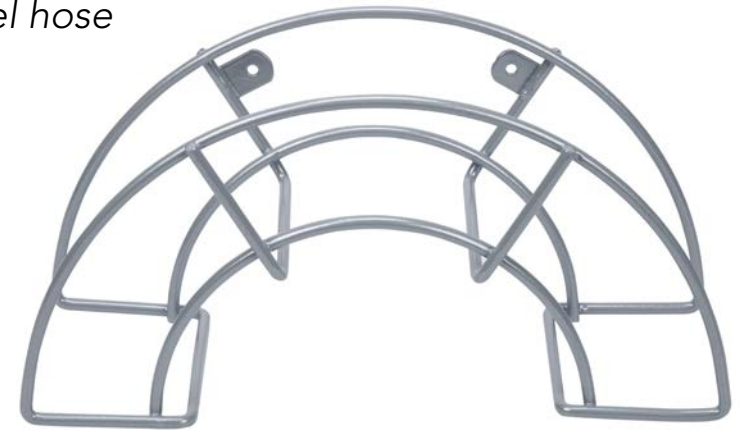

MATERIAL
MATERIAL

Acero con 0,5 mm. de recubrimiento plástico anticorrosivo gris.
Steel with 0,5 mm. grey anti-corrosive plastic coating.



GROSOR
THICKNESS

6 mm



AGUJERO
HOLE

5 mm

REF.

MEDIDAS
MEASURES

03305

36,5 x 19,5 x 13,5



CAPACIDAD MANGUERA
HOSE CAPACITY

25 m. 1/2"



6 U./PACK

Esta cobertura ofrece una protección duradera frente a la corrosión, los golpes y rasguños, inclemencias del tiempo y demás agentes contaminantes.

This cover offers long-lasting protection against corrosion, bumps and scratches, bad weather and other contaminating agents.

Soporte de manguera grande plastificado gris

Large grey plastic-coated steel hose holder

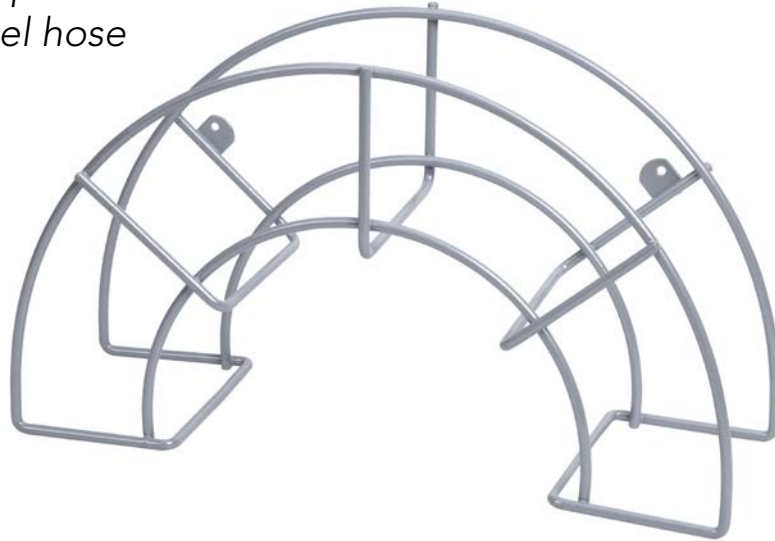

MATERIAL MATERIAL

Acero con 0,5 mm. de recubrimiento plástico anticorrosivo gris.
Steel with 0,5 mm. grey anti-corrosive plastic coating.



GROSOR THICKNESS
6 mm



AGUJERO HOLE
5 mm

REF.

MEDIDAS MEASURES

03310

46,5 x 24 x 16,5



CAPACIDAD MANGUERA HOSE CAPACITY
25 m. 3/4" / 50 m. 1/2"



4 U./PACK

Esta cobertura ofrece una protección duradera frente a la corrosión, los golpes y rasguños, inclemencias del tiempo y demás agentes contaminantes.

This cover offers long-lasting protection against corrosion, bumps and scratches, bad weather and other contaminating agents.

Soporte de manguera super plastificado gris

Super grey plastic-coated steel hose holder

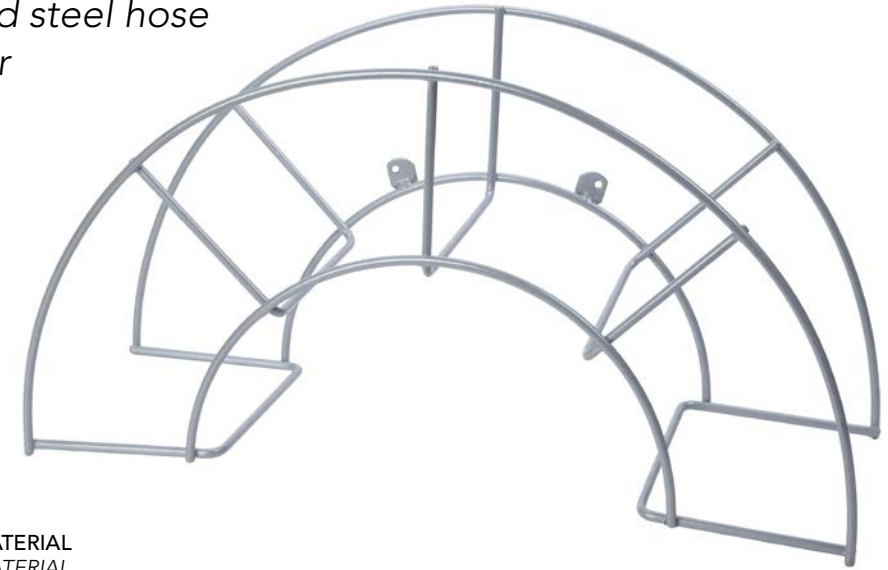

MATERIAL MATERIAL

Acero con 0,5 mm. de recubrimiento plástico anticorrosivo gris.
Steel with 0,5 mm. grey anti-corrosive plastic coating.



GROSOR THICKNESS
6 mm



AGUJERO HOLE
5 mm

REF.

MEDIDAS MEASURES

03312

60 x 30 x 20



CAPACIDAD MANGUERA HOSE CAPACITY
50 m. 1"



2 U./PACK

Esta cobertura ofrece una protección duradera frente a la corrosión, los golpes y rasguños, inclemencias del tiempo y demás agentes contaminantes.

This cover offers long-lasting protection against corrosion, bumps and scratches, bad weather and other contaminating agents.

Soporte de manguera pequeño plastificado negro

Small black plastic-coated steel hose holder



MATERIAL
MATERIAL

Acero con 0,5 mm. de recubrimiento plástico anticorrosivo negro.
Steel with 0,5 mm. black anti-corrosive plastic coating.



GROSOR
THICKNESS
6 mm



AGUJERO
HOLE
5 mm

REF.

MEDIDAS
MEASURES

03324

36,5 x 19,5 x 13,5



CAPACIDAD MANGUERA
HOSE CAPACITY
25 m. 1/2"



6 U./PACK

Esta cobertura ofrece una protección duradera frente a la corrosión, los golpes y rasguños, inclemencias del tiempo y demás agentes contaminantes.

This cover offers long-lasting protection against corrosion, bumps and scratches, bad weather and other contaminating agents.

Soporte de manguera grande plastificado negro

Large black plastic-coated steel hose holder

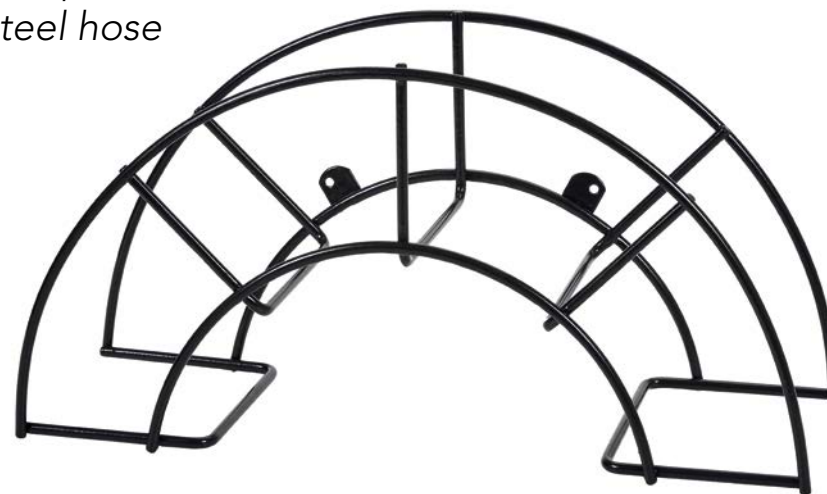

MATERIAL
MATERIAL

Acero con 0,5 mm. de recubrimiento plástico anticorrosivo negro.
Steel with 0,5 mm. black anti-corrosive plastic coating.



GROSOR
THICKNESS
6 mm



AGUJERO
HOLE
5 mm

REF.

MEDIDAS
MEASURES

03326

46,5 x 24 x 16,5



CAPACIDAD MANGUERA
HOSE CAPACITY
25 m. 3/4" / 50 m. 1/2"



4 U./PACK

Esta cobertura ofrece una protección duradera frente a la corrosión, los golpes y rasguños, inclemencias del tiempo y demás agentes contaminantes.

This cover offers long-lasting protection against corrosion, bumps and scratches, bad weather and other contaminating agents.

Soporte de manguera pequeño efecto óxido

Small rust effect hose holder

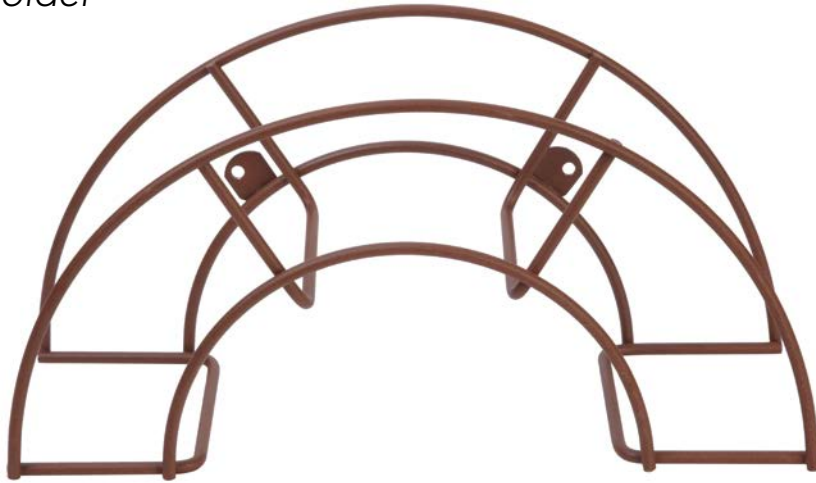

MATERIAL
MATERIAL

Acero pintado con pintura cerámica efecto óxido.
Steel with rust effect ceramic paint.



GROSOR
THICKNESS

6 mm



AGUJERO
HOLE

6 mm



CAPACIDAD MANGUERA
HOSE CAPACITY

25 m. 1/2"



6 U./PACK

REF.

MEDIDAS
MEASURES

03320

36,5 x 19,5 x 13,5

Soporte de manguera grande efecto óxido

Large rust effect hose holder

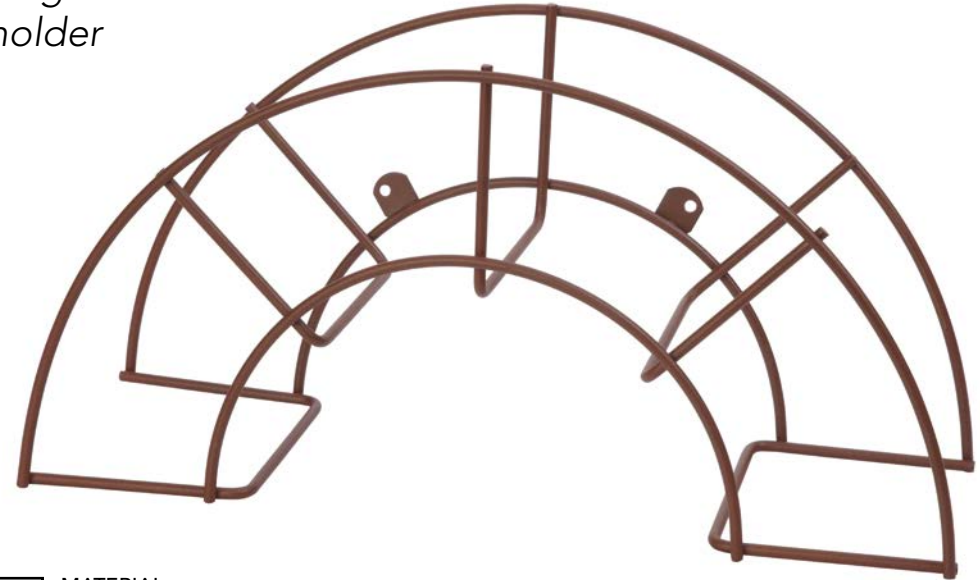

MATERIAL
MATERIAL

Acero pintado con pintura cerámica efecto óxido.
Steel with rust effect ceramic paint.



GROSOR
THICKNESS

6 mm



AGUJERO
HOLE

6 mm



CAPACIDAD MANGUERA
HOSE CAPACITY

25 m. 3/4" / 50 m. 1/2"



4 U./PACK

REF.

MEDIDAS
MEASURES

03322

46,5 x 24 x 16,5

Soporte de manguera pequeño de acero inoxidable 18/8

Small 18/8 stainless steel hose holder



MATERIAL

Acero inoxidable 18/8 (AISI 304) electropulido.
Electropolished (AISI 304) 18/8 stainless steel.

GROSOR THICKNESS 6 mm
AGUJERO HOLE 6 mm

CAPACIDAD MANGUERA HOSE CAPACITY
25 m. 1/2"

6 U./PACK

REF. MEDIDAS MEASURES

03302 36,5 x 19,5 x 13,5

Soporte de manguera grande de acero inoxidable 18/8

Large 18/8 stainless steel hose holder

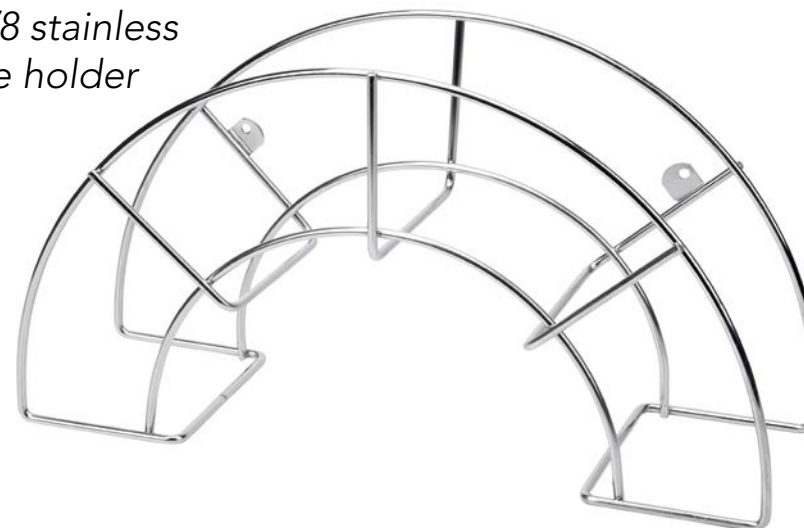

MATERIAL

Acero inoxidable 18/8 (AISI 304) electropulido.
Electropolished (AISI 304) 18/8 stainless steel.

GROSOR THICKNESS 6 mm
AGUJERO HOLE 6 mm

CAPACIDAD MANGUERA HOSE CAPACITY
25 m. 3/4" / 50 m. 1/2"

4 U./PACK

REF. MEDIDAS MEASURES

03303 46,5 x 24 x 16,5

Soporte de manguera super de acero inoxidable 18/8

Super 18/8 stainless steel hose holder

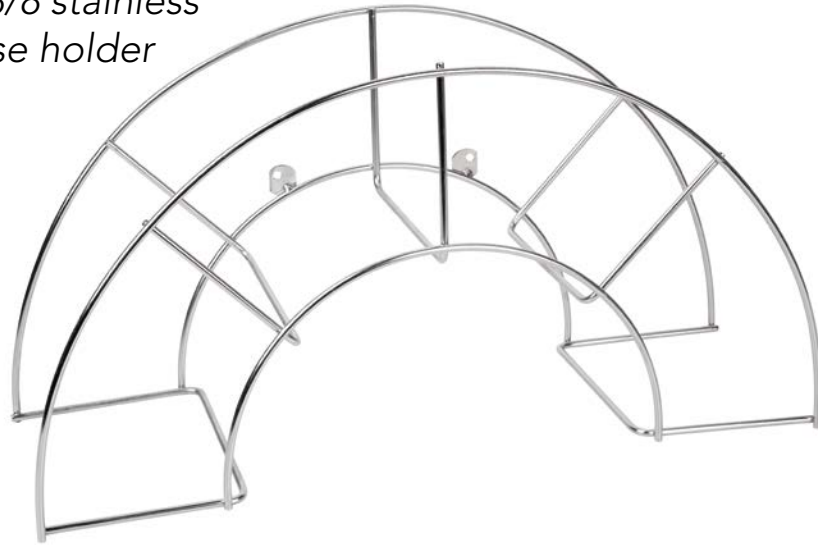

MATERIAL
MATERIAL

Acero inoxidable 18/8 (AISI 304) electropulido.
Electropolished (AISI 304) 18/8 stainless steel.



GROSOR
THICKNESS

6 mm



AGUJERO
HOLE

6 mm



CAPACIDAD MANGUERA
HOSE CAPACITY

50 m. 1"



2 U./PACK

REF.

MEDIDAS
MEASURES

03304

60 x 30 x 20



Soporte ventana extensible gris

Grey extendable window support



MATERIAL
MATERIAL

Acero pintado con pintura cerámica gris.
Steel with grey ceramic paint.

GROSOR THICKNESS **AGUJERO HOLE**
7 - 8 mm 6 mm

5 U./PACK

REF.	LONGITUD LENGTH L
03500	70 - 100
03505	100 - 150
03510	150 - 200

Soporte para evitar que las macetas se caigan del umbral de la ventana.
Se adapta fácilmente a la medida de su ventana, gracias a sus laterales extensibles.

Support to prevent pots from falling off the windowsill.
It easily adapts to the size of your window, thanks to its extendable sides.

Soporte ventana extensible blanco

White extendable window support



MATERIAL
MATERIAL

Acero pintado con pintura cerámica blanca.
Steel with white ceramic paint.

GROSOR THICKNESS **AGUJERO HOLE**
7 - 8 mm 6 mm

5 U./PACK

REF.	LONGITUD LENGTH L
03512	70 - 100
03514	100 - 150
03516	150 - 200

Soporte para evitar que las macetas se caigan del umbral de la ventana.
Se adapta fácilmente a la medida de su ventana, gracias a sus laterales extensibles.

Support to prevent pots from falling off the windowsill.
It easily adapts to the size of your window, thanks to its extendable sides.





Desde nuestros inicios fabricamos ratoneras con madera de pino insignis, 100% ecológica y reutilizable, cultivada especialmente para este fin. Este producto es inofensivo para niños y mascotas.

Nuestras trampas son fáciles de armar y hay opciones para atrapar a pequeños roedores sin dañarlos.

Since our beginnings we manufacture mousetraps with pine wood insignis, 100% ecological and reusable, cultivated especially for this purpose. This product is harmless for children and pets.

Our traps are easy to set and there are options to catch small rodents without hurting them.



Ratoneras

Mouse traps

Ratonera tabla de madera pequeña n°1

Small wooden mouse trap n°1



MATERIAL
MATERIAL

Madera de pino insignis, cultivada especialmente con este fin.
Insignis pine wood, grown especially for this purpose.

12/72 U./PACK

REF.

MEDIDAS
MEASURES

05125

11 x 4,8 x 1,2

Ratonera tabla de madera mediana n°2

Medium wooden mouse trap n°2



MATERIAL
MATERIAL

Madera de pino insignis, cultivada especialmente con este fin.
Insignis pine wood, grown especially for this purpose.

12/60 U./PACK

REF.

MEDIDAS
MEASURES

05130

13,5 x 6,2 x 1,2

Ratonera tabla de madera grande n°3

Large wooden mouse trap n°3



MATERIAL MATERIAL

Madera de pino insignis, cultivada especialmente con este fin.
Insignis pine wood, grown especially for this purpose.

REF.

MEDIDAS
MEASURES

05135

17,5 x 7,2 x 1,2

 **12/60** U./PACK

Ratonera tabla de madera en blíster

Wooden mouse traps in blister pack



MATERIAL MATERIAL

Madera de pino insignis, cultivada especialmente con este fin.
Insignis pine wood, grown especially for this purpose.

REF.

 U./PACK

MEDIDAS
MEASURES

15125

2/12

11 x 4,8 x 1,2

15135

1/12

17,5 x 7,2 x 1,2

Ratonera de madera con 2 agujeros pequeña

Small wooden mouse trap with 2 holes

MATERIAL MATERIAL

Madera de pino insignis, cultivada especialmente con este fin.
Insignis pine wood, grown especially for this purpose.

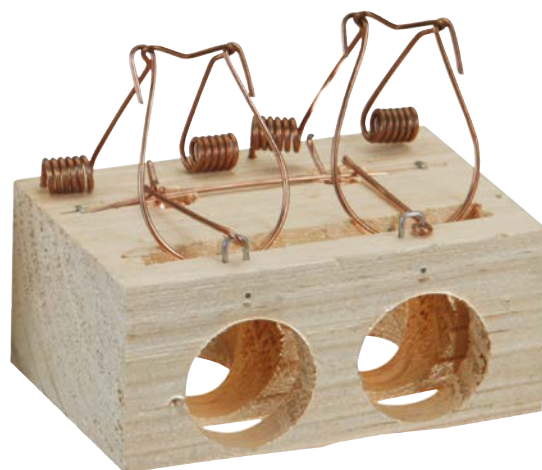

EXPOSITOR / CAJA
DISPLAY STAND / BOX

30 U./EXPOSITOR
DISPLAY STAND

120 U./PACK

REF.	MEDIDAS MEASURES	AGUJERO HOLE Ø
05235	9,5 x 6,5 x 4	2,8

Inofensiva para niños y mascotas.
100% Ecológica y reutilizable.
Muy fácil de armar.

Harmless to children and pets.
100% Ecological and reusable.
Very easy to assemble.

Ratonera de madera con 2 agujeros mediana

Medium wooden mouse trap with 2 holes

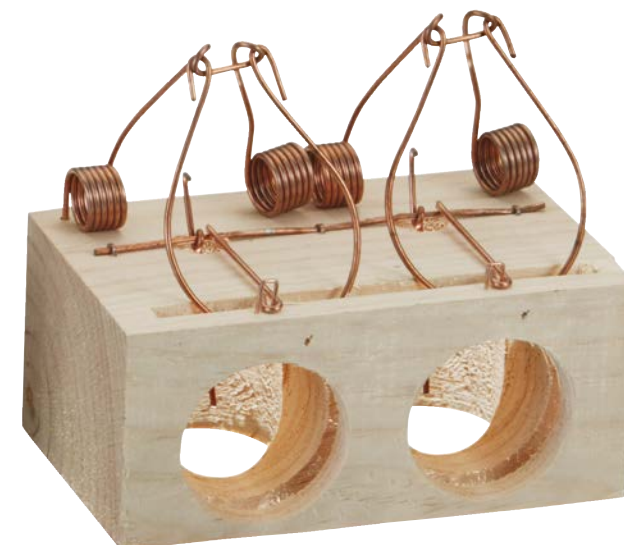

MATERIAL MATERIAL

Madera de pino insignis, cultivada especialmente con este fin.
Insignis pine wood, grown especially for this purpose.

REF.	MEDIDAS MEASURES	AGUJERO HOLE Ø
05252	12,5 x 8,5 x 6	3,7

Inofensiva para niños y mascotas.
100% Ecológica y reutilizable.
Muy fácil de armar.

Harmless to children and pets.
100% Ecological and reusable.
Very easy to assemble.

48 U./PACK

Ratonera de madera con 2 agujeros grande

Large wooden mouse trap with 2 holes

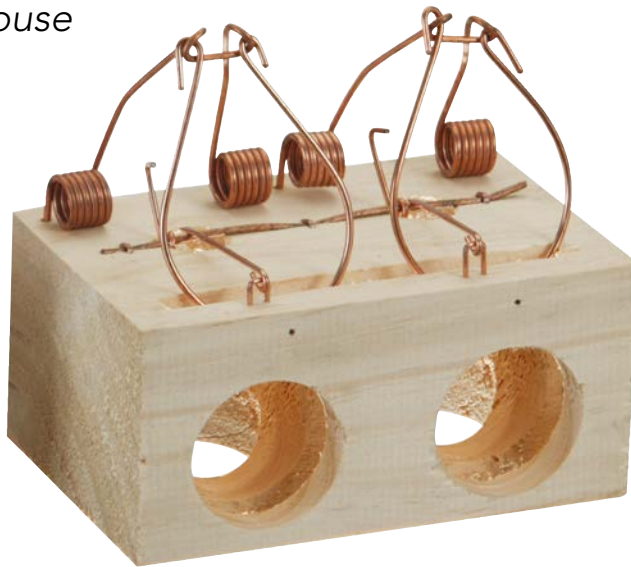

MATERIAL MATERIAL

Madera de pino insignis, cultivada especialmente con este fin.
Insignis pine wood, grown especially for this purpose.

 24 U./PACK

REF.	MEDIDAS MEASURES	AGUJERO HOLE Ø
05256	15 x 10 x 7	5

Inofensiva para niños y mascotas.
100% Ecológica y reutilizable.
Muy fácil de armar.

Harmless to children and pets.
100% Ecological and reusable.
Very easy to assemble.

Ratonera de madera con 2 agujeros pequeña en blíster

Small wooden mouse trap with 2 holes in blister pack



MATERIAL MATERIAL

Madera de pino insignis, cultivada especialmente con este fin.
Insignis pine wood, grown especially for this purpose.

 12/60 U./PACK

REF.	MEDIDAS MEASURES	U./PACK
15235	9,5 x 6,5 x 4	1/45

Inofensiva para niños y mascotas.
100% Ecológica y reutilizable.
Muy fácil de armar, con instrucciones de uso.

Harmless to children and pets.
100% Ecological and reusable.
Very easy to assemble, with instructions for use.

Ratonera de tela metálica de 18 cm.

Cage for rodents of 18 cm.



MATERIAL MATERIAL

Base de madera y estructura de malla electrosoldada de 18 cm. de largo y reforzada con perfil de aluminio.
Wooden base and an 18 cm long electro-welded mesh structure reinforced with an aluminium profile.

 4 U./PACK

REF.

MEDIDAS MEASURES

05190

12 x 18 x 9

Atrapa a pequeños roedores (ratones, topos,...) sin matarlos. La jaula de tela metálica atrapa al pequeño animal sin necesidad de usar veneno o golpearlo.

It catches small rodents (mice, moles, etc.) without killing them. The wire mesh cage traps the small animal without the need to use poison or hit it.

Elaborada con una puerta de acceso en guillotina, asegurando su cierre en la activación de la trampa. Reutilizable.

Made with a guillotine access door, ensuring its closure when the trap is activated. Reusable.

Ratonera de tela metálica de 21 cm.

Cage for rodents of 21 cm.



MATERIAL MATERIAL

Base de madera y estructura de malla electrosoldada de 21 cm. de largo y reforzada con perfil de aluminio.
Wooden base and an 21 cm long electro-welded mesh structure reinforced with an aluminium profile.

 4 U./PACK

REF.

MEDIDAS MEASURES

05195

12 x 21 x 9

Atrapa a pequeños roedores (ratones, topos,...) sin matarlos. La jaula de tela metálica atrapa al pequeño animal sin necesidad de usar veneno o golpearlo.

It catches small rodents (mice, moles, etc.) without killing them. The wire mesh cage traps the small animal without the need to use poison or hit it.

Elaborada con una puerta de acceso en guillotina, asegurando su cierre en la activación de la trampa. Reutilizable.

Made with a guillotine access door, ensuring its closure when the trap is activated. Reusable.

Ratonera de tela metálica de 30 cm. reforzada

Cage for rodents of 30 cm. reinforced



Malla electrosoldada reforzada
Reinforced electro-welded mesh structure

MATERIAL
MATERIAL

Base de madera y estructura de malla electrosoldada de 30 cm. de largo y reforzada con perfil de aluminio.
Wooden base and an 30 cm long electro-welded mesh structure reinforced with an aluminium profile.

REF. MEDIDAS
MEASURES

05200 30 x 12,5 x 12

Atrapa a pequeños roedores (ratones, topos,...) sin matarlos. La jaula de tela metálica atrapa al pequeño animal sin necesidad de usar veneno o golpearlo.

It catches small rodents (mice, moles, etc.) without killing them. The wire mesh cage traps the small animal without the need to use poison or hit it.

Elaborada con una puerta de acceso en guillotina, asegurando su cierre en la activación de la trampa. Reutilizable.

Made with a guillotine access door, ensuring its closure when the trap is activated. Reusable.

2 U./PACK

Ratonera de plástico pequeña

Small plastic mouse trap



MATERIAL
MATERIAL

Plástico resistente.
Resistant plastic.

REF. MEDIDAS
MEASURES

05260 5 x 45/90

2/32 U./PACK

Cebo permanente.
Fácil de armar.

Permanent bait. Easy to set up.

Pala matamoscas

Fly swatters



COLORES SURTIDOS
ASSORTED COLORS

MATERIAL
MATERIAL

Plástico resistente.
Resistant plastic.

REF. MEDIDAS
MEASURES

05100 40 x 13

60 U./PACK

Mango muy fuerte.
Plástico flexible muy resistente.

Very strong handle. Flexible plastic high-resistant.

Notas

Notes



Sauvic SL

B59455477

C. Josep Lladó i Quintana, 30
Pol. Ind. Font de tarrés
08560 Manlleu
(Barcelona) SPAIN

+34 93 850 75 06
+34 93 850 74 70

sauvic@sauvic.com

www.sauvic.com