

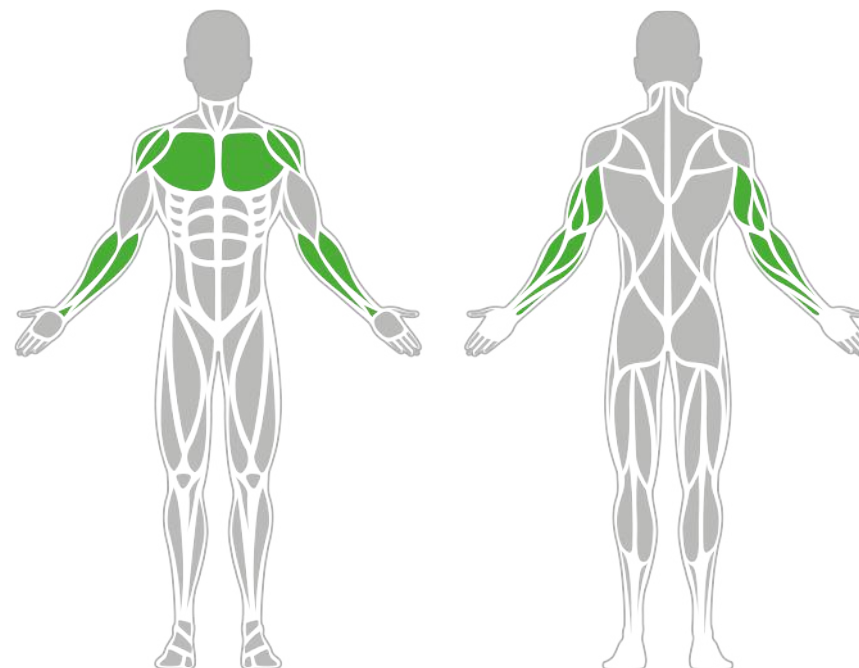

## Muscle Groups Focus



### Weighted Bench Press

The BESTRONG Weighted Bench Press is the perfect choice for targeted strengthening of the chest, deltoid, and triceps muscles. With adjustable resistance ranging from 33 lbs to 177 lbs, it accommodates users of all training levels, allowing them to select the appropriate setting for their needs. Its design ensures a simple, safe, and effective workout.

### Attributes

Product code	1-1-319
Certificate	EN 16630, ASTM F3101
Age group	14 + years
Capacity	1 person
Max. weight load	286.60 lbs
Type	Weighted
Difficulty level	Adjustable

## Side View

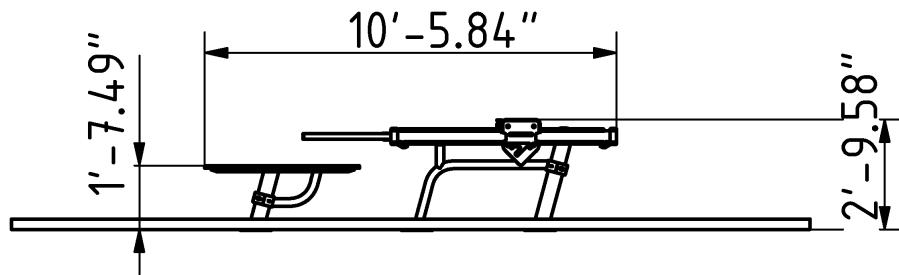

## Plan View

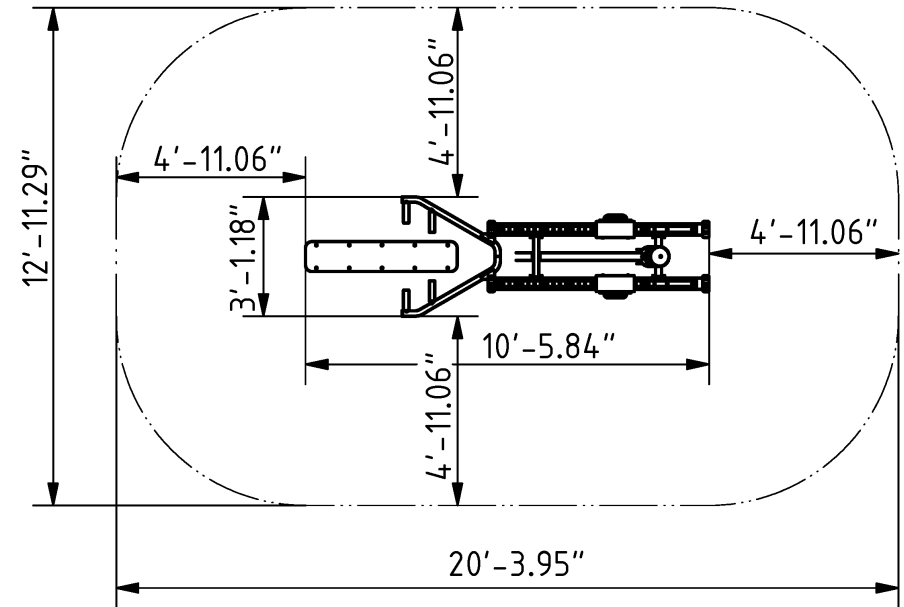

## Installation information

Number of installers (concrete)	At least 2 people
Total installation time (concrete)	80-140 min.
Number of installers (equipment)	At least 2 people
Total installation time (equipment)	60 min.
Excavation volume	57.21 ft <sup>3</sup>
Concrete volume	42.38 ft <sup>3</sup>
Size of the base structure	118,1 x 31,5 x 31,5"
Anchoring options	Surface mounted
In combined structures, the volume of concrete required varies.	

## Technical specification

Safety surface area	Around 4.92 ft radius
Net weight	577.61 lbs
Material	S235,S355,KO33,HDPE
Critic fall height	19.69"
Color options	



For more color options, discuss with your sales representative.

## Warranty

Structure	25-15 years
Steel	5-10 years
Paint	2 years
Plastic	5-10 years
Rubber	1-3 years
Moving parts	2 years
Detailed information in the warranty document	

# Material specification

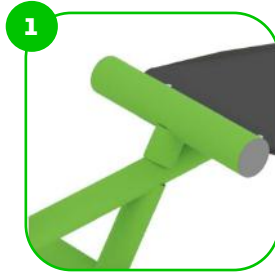

The element is made of high quality S235 steel, which has been cleaned via sandblasting. A corrosion resistant powder coating finish is then applied. Also available with galvanized surface for even greater protection and longevity!

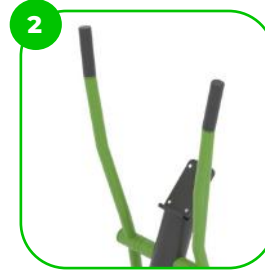

At the end of the arms, the handle is rubber-coated for a more comfortable and secure grip.

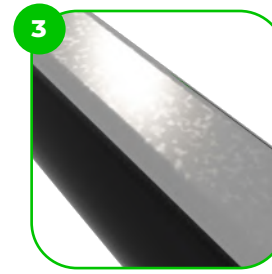

The sliding weight rail is made of high-quality stainless steel, which guarantees the product's long-term durability and resistance to weathering.

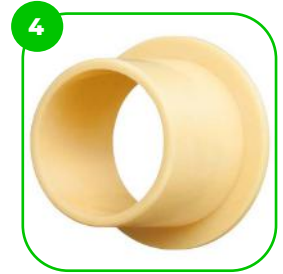

The device is fitted with composite bearings that are weather-resistant. The bearing does not require regular maintenance.

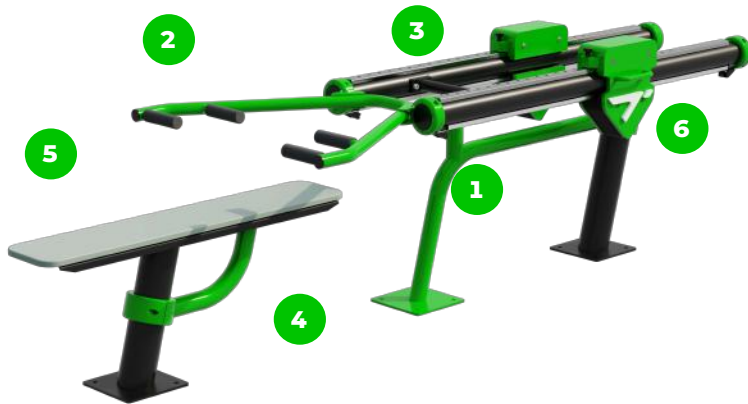

The seats and backrests are made of strong HDPE material. Which is fully heat, moisture and UV resistant.

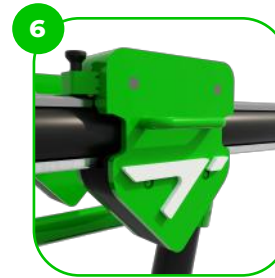

The device is equipped with two 110 lbs weights, which allow you to perform workouts of varying intensity.

# BESTRONG

 [bestrongworld](#)  [bestrongworld](#)  [usa.bestrong.com](#)  [usa@bestrong.com](#)

