















PRODUCT CATALOG



CUMBERLANDSUPPLY.COM

CATALOG INDEX

	Asphalt Shingles	91
	Caulks & Sealants.....	52
	Concrete & Accessories	243
	Cupolas & Weathervanes.....	192
	Decking & Railing.....	170
	Drywall	149
	Entry Doors	203
	Fasteners.....	162
	Gutters & Accessories.....	257
	Horse Stall Components.....	184
	House Wrap & Underlayment	106
	Insulation	235
	Interior Ceiling & Wall Panels.....	76
	Joist Hangers and Ties.....	121
	Lumber, Posts, & Trusses	111
	Metal Panels	4
	Metal Roofing Accessories	28
	Overhead Garage Doors	215
	Paint & Stain	156

●	Pipe & Fittings.....	251
●	Roll Track Sliding Doors.....	221
●	Roof Boots.....	61
●	Roofing Screws & Fasteners	41
●	Rubber Roofing	99
●	S-5!® Clamps	282
●	Siding & Accessories	135
●	Skylights & Sidelights	87
●	Snow Retention Systems.....	276
●	Trim Moulding	144
●	Ventilation & Closures.....	67
●	Welded Wire Fencing & Poultry Netting	248
●	Windows.....	200
●	Product Index	298



Metal Panels

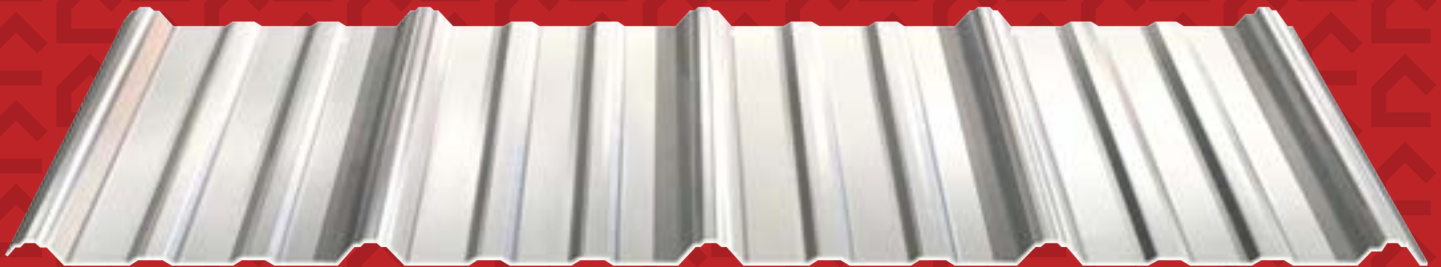
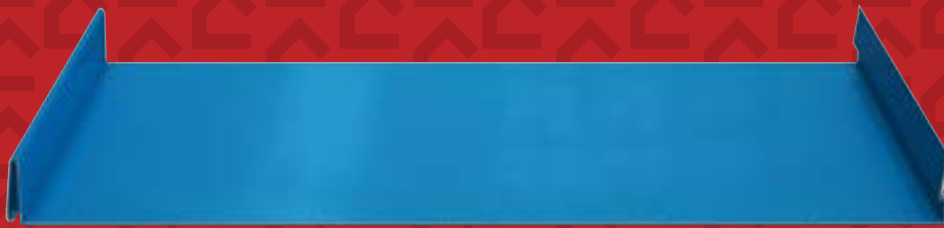



About the ABM Panel

Heavy-duty steel - in over 30 energy-efficient colors with 40-year paint warranties - heat-formed and rolled to custom lengths in hours... not days.

The ABM Panel provides 36" wide coverage, and it is rolled to custom lengths from 1' to 48' in 1/4" increments. This means you're not paying for that extra 2' or 1/2" that you don't need. Plus, think of all the time your saving.

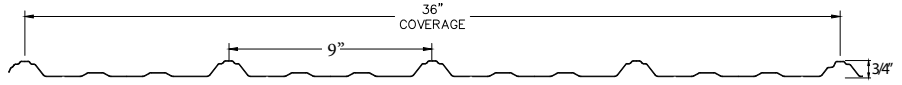

Approximately 3/4" high major ribs on 9" centers with two 1" wide minor between each major rib for extra strength. The overlap has an antisiphon break for leak-free application with a 3:12 slope and greater.

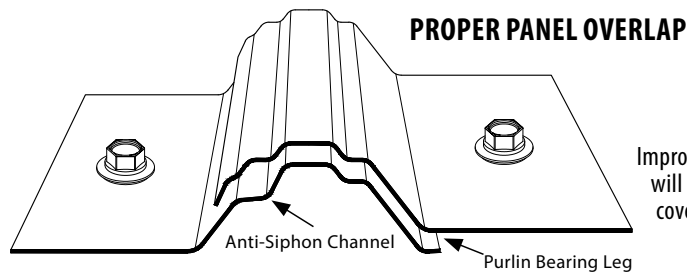

CAUTION!

Improper overlap installation will cause leaks and is not covered by the warranty.



SCREW PATTERN

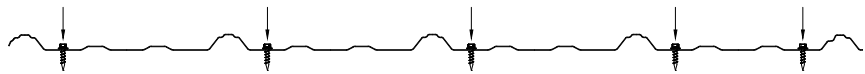

EAVE SCREW PATTERN

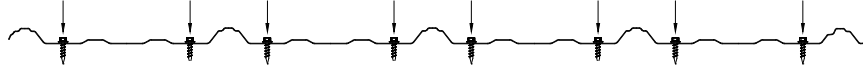

RIDGE CAP SCREW PATTERN

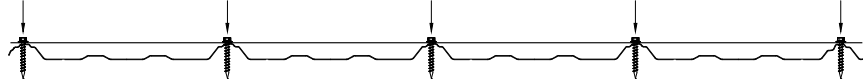

ABM Panel - 28 Gauge G-100 Galvanized Premium Panel



Acc

Galvanized steel is made by passing bare steel through a bath of molten zinc at 842 degrees Fahrenheit. The zinc coating that gives the steel sheet its resistance to weathering and rust, offers better cathodic (or sacrificial) protection for scratches and cut edges.

G-100 Galvanized steel is known to resist ammonia better than Galvalume. That means it is the best choice for use in animal confinement such as pig barns, dairy barns, horse barns, and chicken houses.

Available with 25 energy-efficient colors with 40-year paint warranties.

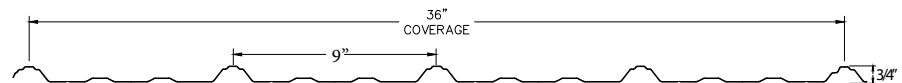



ABM Panel - 28 Gauge AZ50 Galvalume Standard Panel

Scc

Galvalume, which typically costs less than Galvanized, is made from bare steel covered with a mixture of zinc, aluminum, and trace amounts of silicon to improve its long-term weathering capabilities.

Painted Galvalume is known to exhibit more short-term edge rust and tension-bend stains than G-100 Galvanized, but has a reputation for better long-term weathering when compared to G-90 and lower-grade Galvanized panels.

It is very important to note that Galvalume can not be used with animal confinement.

Available in 25 energy-efficient colors with 40-year paint warranties.

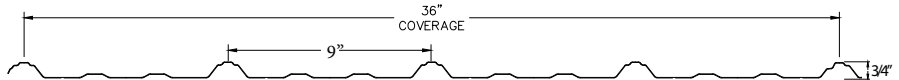

ABM Panel - 28 Gauge Seconds Panel

Xcc

ABM Panel seconds can be Galvanized or Galvalume steel that was rejected for unknown reasons to us from the steel mill. There could be a defect in the steel, pre-coat, or primer. The defects are usually not noticeable at first because the coils are painted with the same top-coat as our Premium and Standard panels. Because of the uncertainty of ultimate life expectancy of the panel, we recommend the ABM Panel for interior use and temporary shelters. There is NO WARRANTY on ABM Panel Seconds.

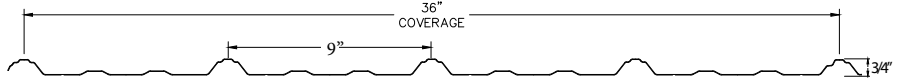

ABM Panel - 28 Gauge Perforated

APM

0.125" holes give 13.5% open-area across the ABM Perforated Panel. Because the perforation drastically decreases reverb, it is a great option for a ceiling panel in noisy environments such as offices, workshops, reception centers, or retail locations.

Available in white and made to custom lengths.

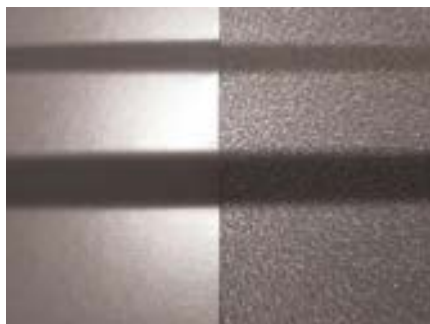
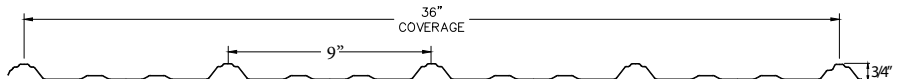

SMOOTH

TEXTURED

ABM Panel - 26 Gauge Textured AZ50 Galvalume

ATcc

Homeowners like it because the unique textured surface redirects sunlight for less glare than smooth panels. Contractors like it because the texture provides more grip during installation than smooth panels.

Available in 10 energy-efficient colors with 40-year paint warranties.

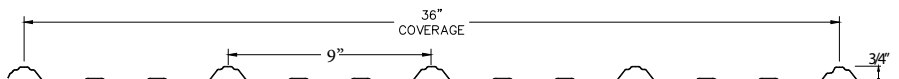

ABM Panel Trims

Ridge Cap

CPcc

Finish off your roof with the Universal Ridge Cap to allow the heat to escape the attic space and allow fresh air to infiltrate the building.

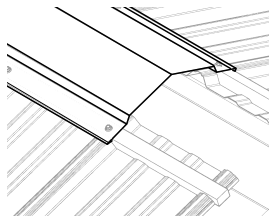

J Channel

Jcc

From trimming walls to trimming windows and doors, the J Channel is one of the most versatile and most used trim pieces.

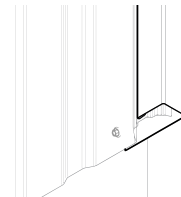

Rake & Corner

RCcc

Similar to but smaller than the Gable Flashing, the Rake & Corner is designed for an outside vertical corner. Can also be used for trimming a sloping roof with the lower level side wall.

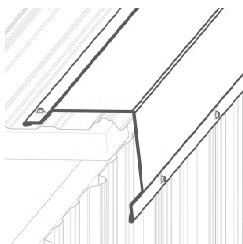

Double Angle

DAcc

Commonly used to provide a straight edge between multi-layers of panels such as when adding a wainscoting or finishing the gable.

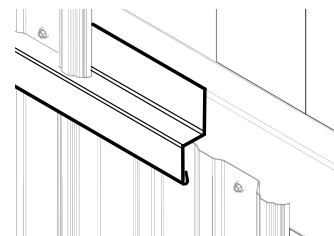

Base Angle

BAcc

Start with a Base Angle for an easy way to perfectly align the entire bottom row of wall panels.

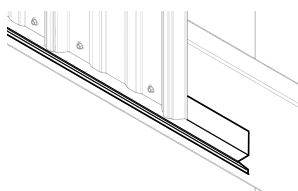

Universal Sidewall

SWcc

Flat end goes under your siding, while the hemmed end goes over your sloped roof panels.

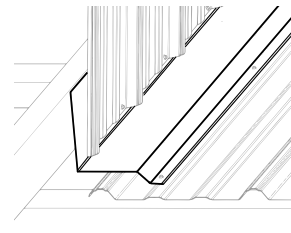

Gable Flashing

GFcc

Designed for trimming a sloping roof with the lower level side wall. An extra lip helps deflect precipitation from the wall panels.

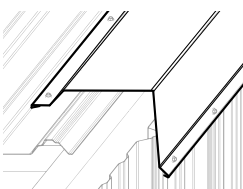

Drip Cap

DCcc

Commonly used above windows or doors to direct the precipitation away from the panel.

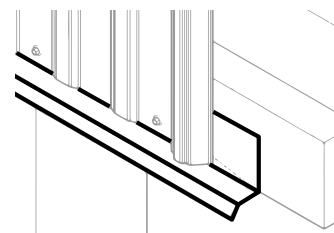

Post/Fascia Trim

PTcc

Multiple sizes to fit most headers and posts in stock.

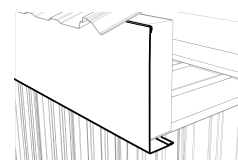

Universal Endwall

EWcc

Designed to finish off a wall that is aligned with the top of a sloping roof. For best results, make sure you use the Outside Foam Filler Strip to prevent driving wind from carrying rain and debris under the Universal Endwall.

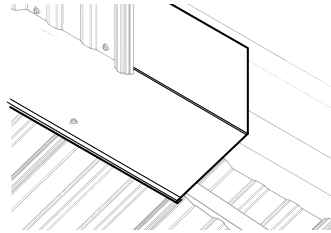

Door Trim

JTcc725 or JTcc925

Most often used to trim a sliding door opening.

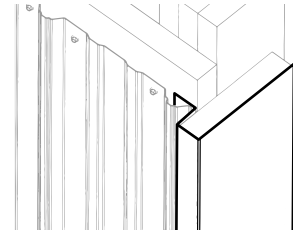

F & J Channel

FJcc

Commonly used to connect our steel or vinyl soffit with the ABM Panel. Also great for interior use when you need to connect the ceiling panels with the wall panels.

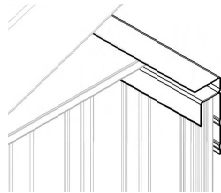

Track Cover

CTcc

Commonly used to cover the tracks of rolling/sliding doors. Get it in the color of your choice.

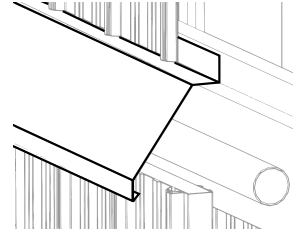

Inside Corner

ICcc

Used for finishing the inside corner of a wall.

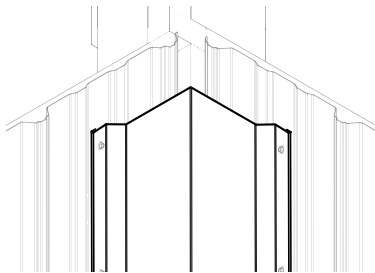

Gutter Apron

GAcc

Flat end goes under your roofing, while the hemmed end folds down to provide coverage over your header or post fascia trim.

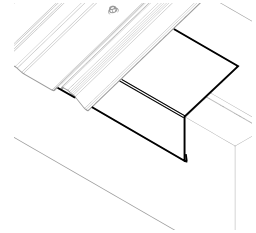

Overhead Garage Door Trim

ODcc

Designed for the sides and top of an overhead garage door entrance.

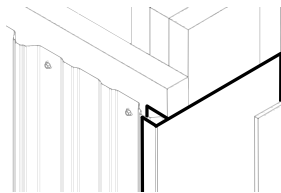

Gambrel Trim

GTcc

The Gambrel trim is the perfect trim for connecting two parts of a roof that have differing pitches.

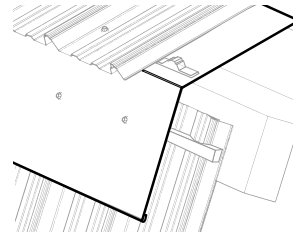

Residential Rake

RRcc

Designed for trimming a sloping roof with the lower level side wall. Can also be used as an outside vertical corner.

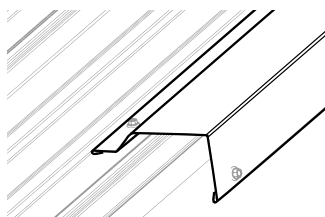

Drip Edge

DEcc

Similar to the Gutter Apron except that it includes an extra lip to deflect precipitation away from the wall below.

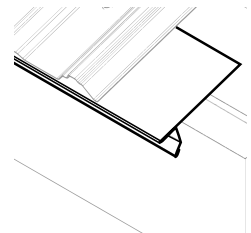

Formed Valley

WVcc

Wide enough to ensure proper overlap to prevent moisture from seeping up under the two opposing roofing panels.

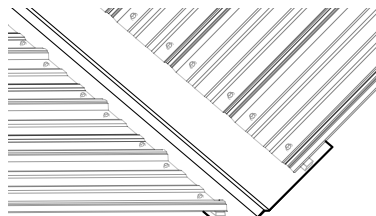

ABSeam Panel - 24 Gauge AZ50 Galvalume

ABScC

The ABSeam Panel, a hidden fastener standing seam roof system, is a popular choice for an aesthetically pleasing and long-lasting roof.

Thanks to the hidden clip system, no screws or punctures are visible to the eye or exposed to the elements for the ultimate beautiful and long-lasting metal roof.

Available in 16 energy-efficient colors with 40-year paint warranties.



- Coverage: 19.5"
- Rib Height: 1.5"
- NEW: Pre-notched is now standard
- Steel Thickness: 24 Gauge
- Substrate: AZ50 Galvalume
- Paint System: PDVF Fluoropon from Valspar
- Paint Warranty: 40 Years



About Fluoropon® - The industry standard in PDVF coatings

For over 50 years, panels using Sherwin-Williams' Fluoropon® coatings (made with 70% Kynar® 500/ Hylar® 5000 resins) have helped protect commercial, industrial, and residential buildings around the world. This high-performance fluoropolymer (PVDF resin) with its unmatched capability to retain color and gloss, keeps coated metal looking vibrant and appealing for decades.

Additional Options:



Custom Widths

Custom width panels down to 11 1/2" wide panels.



Double Striations

Approximately 4.5" wide striations for added rigidity.

This option is only available on panels manufactured at our Newville location.



Continuous Striations

Approximately 4.5" wide striations for added rigidity.

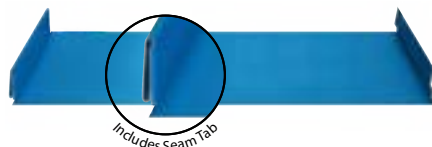

Includes Seam Tab

Pre-notched - Standard

Pre-notched at both ends with seam tab for faster installation. This option is now standard. Please let us know if you do not want your panels pre-notched.



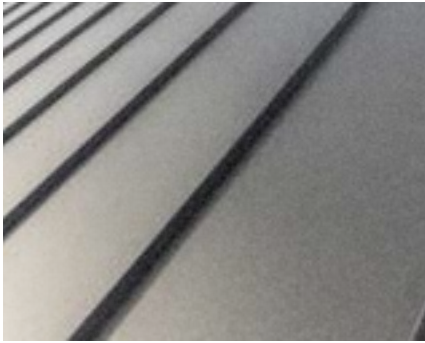

ABSeam Panel - 26 Gauge Textured AZ50 Galvalume

ABSTcc

The silicon-modified polyester (SMP) paint system provides strong resistance to scratching, chalking, fading, and weathering. Homeowners like the Textured ABSeam Panel because the unique textured surface redirects sunlight for less glare than smooth panels. Plus the textured panels are less prone to "oil canning" which makes for a more attractive roof. Contractors like it because the texture provides more grip during installation than smooth panels.

Coverage: 16.5"

Rib Height: 1.5"

Steel Thickness: 26 Gauge

Substrate: AZ50 Galvalume

Paint System: SMP Weather XL Textured from Sherwin-Williams

Paint Warranty: 40 Years

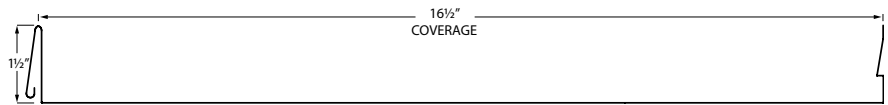

ABSeam Panel - 16 oz Copper

ABSCOPPER

The ABSeam panel is also available in copper. In order to keep its sheen, a copper roof must be coated with oils, waxes, or opaque paint coatings every few years. If left uncoated, copper goes through a natural oxidation process that eventually forms a unique protective patina (light green in color) on the metal that can last hundreds of years. Tests on European copper roofs from the 18th century showed that, in theory, copper roofs can last one thousand years!

Coverage: 13.5"

Rib Height: 1.5"

Thickness: 16 oz Solid Copper

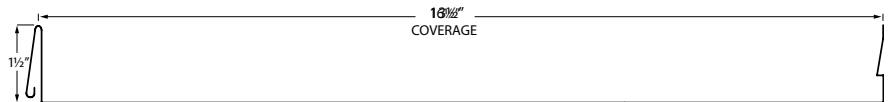

ABSeam Panel Trims

Drawings are not to scale.
 Exact dimensions may vary.
 Contact us about custom trims.
 Item codes are in brackets.
 cc = Color Code

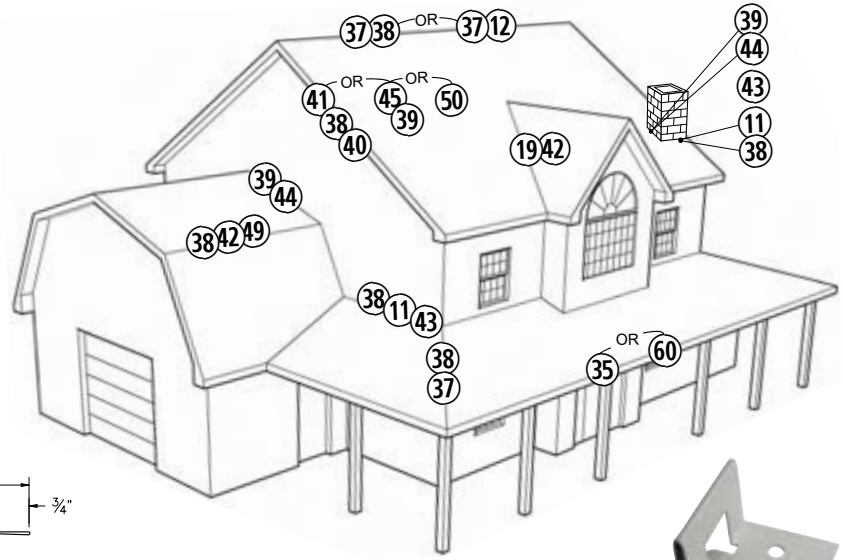

ABSeam Hidden Clip (ABSSC)

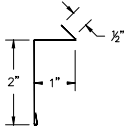

43 ABS Counter Flashing (ABSCFcc)

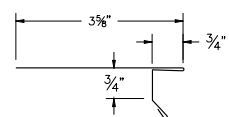

60 Drip Edge (ABSDEcc)

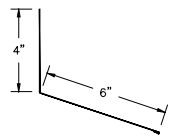

11 ABS Endwall (ABSEWcc)

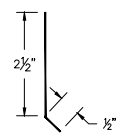

41 ABS Gable Cleat (ABSGCcc)

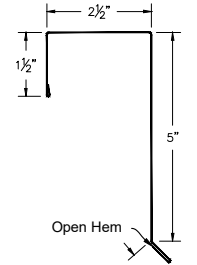

40 ABS Gable Flasing (ABSGFcc)

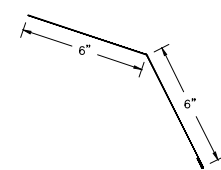

49 ABS Gambrel Trim (ABSGTcc)

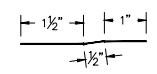

42 ABS Offset Cleat (ABSOCcc)

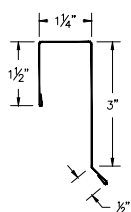

45 ABS Rake Trim (ABSRtcc)

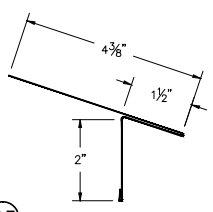

35 ABS Residential Eave (ABSREcc)

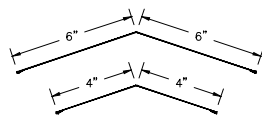

37 ABS 6" Ridge Cap (ABSCPcc)

31 ABS 4" Ridge Cap (ABSCP4cc)

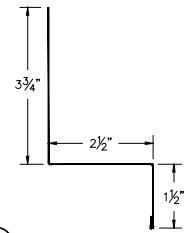

44 ABS Sidewall (ABSSWcc)

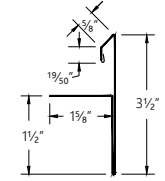

50 ABS Slim Line Rake (ABSSLRcc)

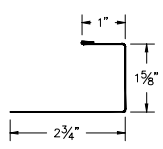

39 ABS Starter "J" (ABSSJcc)

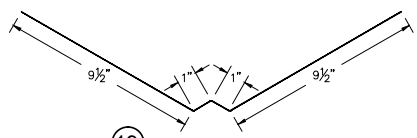

19 ABS W Valley (ABSWVcc)

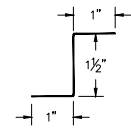

38 ABS Metal "Z" Closure (ABSZcc)

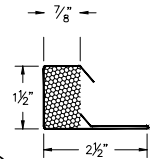

12 ABS Vented "Z" Closure (ABSZVcc)



Heritage Panel

AHcc

Get a classic look with this exposed-fastener panels.

Coverage: 36.5"

Rib Height: 3/4"

Steel Thickness: 26 Gauge

Substrate: AZ50 Galvalume or G100 Galvanized

Paint Warranty: 40 Years

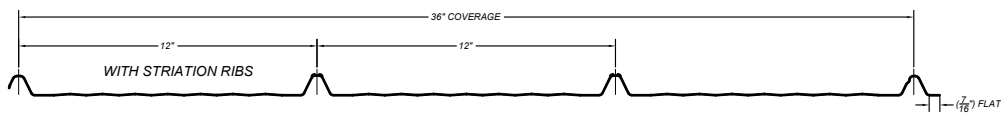



PBR Panel - 26 Gauge AZ50 Galvalume - Special Order

(Some Colors Available in 24 Gauge)

PBRcc

The PBR Panel is used mostly for steel-frame buildings, but can also be used on wood-frame buildings.

The PBR Panel is engineered and designed for maximum structural stability.

For excellent strength and leak resistance, the PBR Panel has full, 1-1/4" high major ribs every 12" on center which are 1" wide at the top and over 3" wide at the base. Available in 18 energy-efficient colors with 40-year paint warranties.

The PBR panel has a purlin-bearing-leg approximately 1" long at the underlap that rests on the purlin for extra support.

Sealant tape and stitch screws are recommended for improved leak protection.

The PBR Panel performs superbly on roof slopes as low as 1/12. The 26 gauge panels can span up to 4', and the heavier 24 gauge panels can span up to 5'.

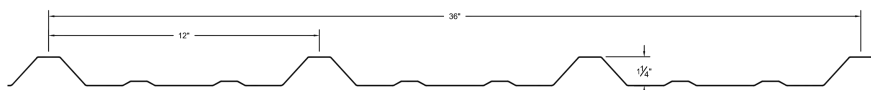

A Panel - 26 Gauge AZ50 Galvalume

PAcc

For an architecturally attractive look, try our A Panel on your side walls and interior liner. The A Panel is practically identical to PBR panel, but in reverse. The paint is on the opposite side and is meant to be installed upside-down, relatively speaking. The A Panel is used more frequently in siding commercial and industrial steel framed structures.

Available in 18 energy-efficient colors with 40-year paint warranties.

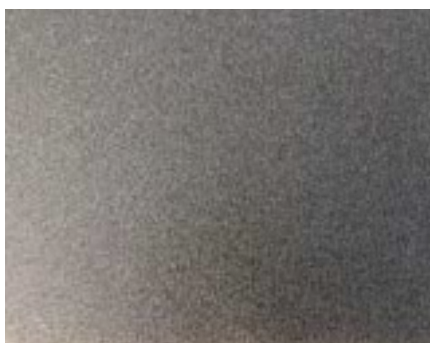
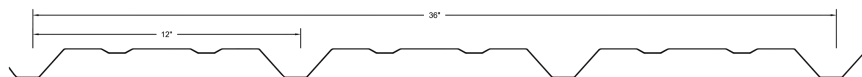

R Panel - 26 Gauge Textured AZ50 Galvalume

PRTcc

The R Panel is identical to the PBR Panel, but without the purlin-bearing-leg. Because of that, we only recommend the R Panel for sidewall applications and not for the roof.

Available in 10 energy-efficient colors with 40-year paint warranties.



Commercial Trims

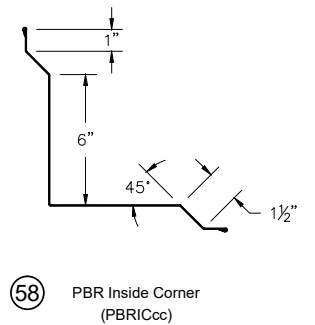
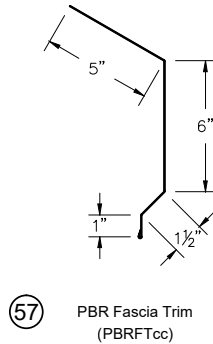
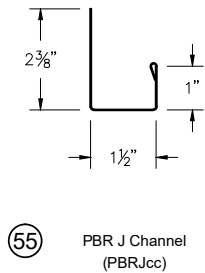
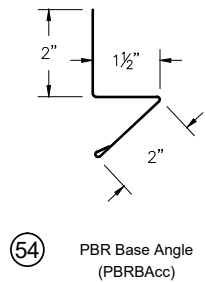
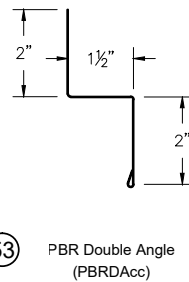
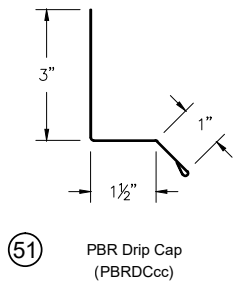
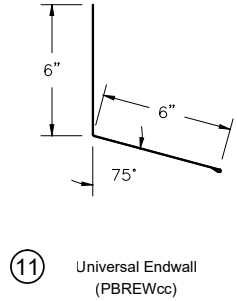
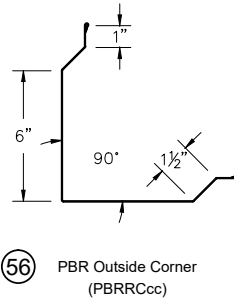
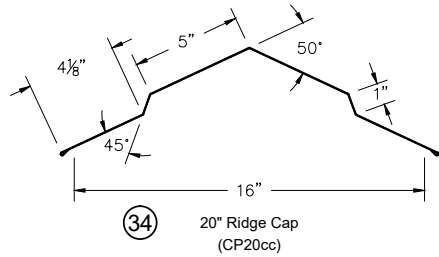

Proper Overlap

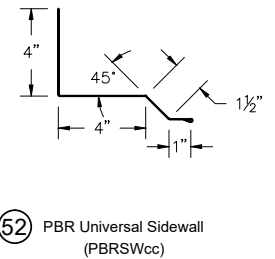
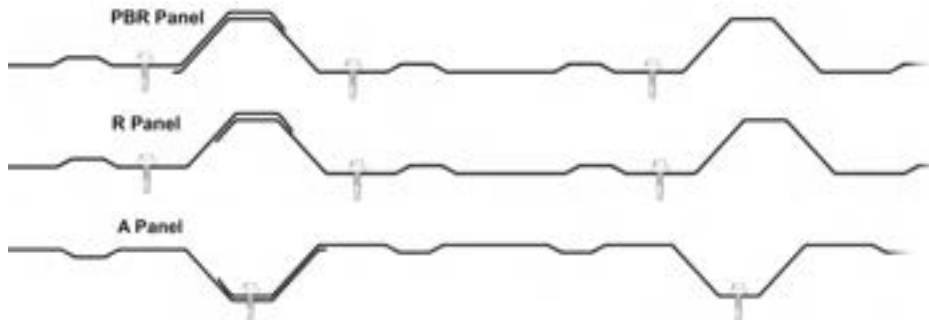



1-1/4" Corrugated - Steel

COMMON APPLICATIONS

- Interior Accent Walls and Wainscoting
- Exterior Siding and Wainscoting

FEATURES

- Maximum Coverage: 24"
- Rib Spacing: 1-1/4"
- Unpainted Substrate: G-90 Galvanized or AZ-55 Galvalume (not recommended for animal confinement)
- Painted Substrate: AZ-50 Galvalume (not recommended for animal confinement)
- Available in over 50 Energy-efficient Colors*
- Made to custom lengths
- 40-year warranty (see warranty for details)
- * Not all colors available in every gauge. See color chart for details and availability.
- Not recommended for roofing due to short rib height and no anti-siphon channel.

Part#	Description	Gauge	Cvg.	Length
FSC1258	1-1/4" Corrugated Pre-cut Galvanized Panel	29	24"	8'
FSC12510	1-1/4" Corrugated Pre-cut Galvanized Panel	29	24"	10'
FSC12512	1-1/4" Corrugated Pre-cut Galvanized Panel	29	24"	12'
C1Scc	1-1/4" Corrugated Galvalume Panel in AZ50 Colors	28	24"	Custom
C1STcc26	1-1/4" Corrugated Galvalume Panel in Textured Colors	26	24"	Custom
C1Scc26	1-1/4" Corrugated Galvalume Panel in 26 ga. AZ50 Colors	26	24"	Custom
C1SKcc26	1-1/4" Corrugated Galvalume Panel in Kynar Colors	26	24"	Custom



2-1/2" Corrugated - Steel

COMMON APPLICATIONS

- Interior Accent Walls and Wainscoting
- Exterior Siding and Wainscoting

FEATURES

- Maximum Coverage: 24"
- Rib Spacing: 2-1/2"
- Unpainted Substrate: G-90 Galvanized or AZ-55 Galvalume (not recommended for animal confinement)
- Painted Substrate: AZ-50 Galvalume (not recommended for animal confinement)
- Available in over 50 Energy-efficient Colors*
- Made to custom lengths
- 40-year warranty (see warranty for details)

* Not all colors available in every gauge. See color chart for details and availability.
Not recommended for roofing due to short rib height and no anti-siphon channel.

Part#	Description	Gauge	Cvg.	Length
FSC258	2-1/2" Corrugated Pre-cut Galvanized Panel	29	24"	8'
FSC2510	2-1/2" Corrugated Pre-cut Galvanized Panel	29	24"	10'
FSC2512	2-1/2" Corrugated Pre-cut Galvanized Panel	29	24"	12'
C2Scc	S.O. 2-1/2" Corrugated Galvalume Panel in AZ50 Colors	28	24"	Custom
C2STcc26	S.O. 2-1/2" Corrugated Galvalume Panel in Textured Colors	26	24"	Custom
C2Scc26	S.O. 2-1/2" Corrugated Galvalume Panel in 26 ga. AZ50 Colors	26	24"	Custom
C2SKcc26	S.O. 2-1/2" Corrugated Galvalume Panel in Kynar Colors	26	24"	Custom



5-V Crimp - Steel - Special Order



Part#	Description	Coverage	Length
FS5V8	Galvanized 5V Crimp (Spangle may vary)	24"	8'
FS5V10	Galvanized 5V Crimp (Spangle may vary)	24"	10'
FS5V12	Galvanized 5V Crimp (Spangle may vary)	24"	12'
C5CC	Painted 5V Crimp In All Our Colors	24"	

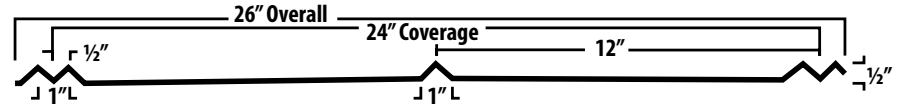

Everdrain - Steel - Special Order

Special order colors are as follows:

Ash Gray (AG), Black (BL), Beige (BG), Brown (BN), Burgundy (BU), Bronze (BZ), Charcoal (CH), Clay (CL), Galvalume (GV), Ivy (IV), Lightstone (LS), Ocean Blue (OB), Red (RD), Slate (SL), Tan (TN), and Bright White (WH). Allow 1-2 weeks lead time.



Part#	Description	Coverage	Length
EDGV12	Galvanized Everdrain Panels - 6" Rib Spacing	36"	12'
EDWH12	Brite White Everdrain Panels - 6" Rib Spacing	36"	12'
EDCC	Special Order Color Everdrain Panels - 6" Rib Spacing	36"	Custom



9" Double Rib - Aluminum

.018 Diamond Embossed Aluminum. Custom lengths available with 1-2 week lead times.



Part#	Description	Coverage	Length
FSARIBI8	Aluminum Panels 9" Double Rib Spacing	36"	8'
FSARIBI10	Aluminum Panels 9" Double Rib Spacing	36"	10'
FSARIBI12	Aluminum Panels 9" Double Rib Spacing	36"	12'
FSARIBI14	Aluminum Panels 9" Double Rib Spacing	36"	14'
FSARIBI16	Aluminum Panels 9" Double Rib Spacing	36"	16'

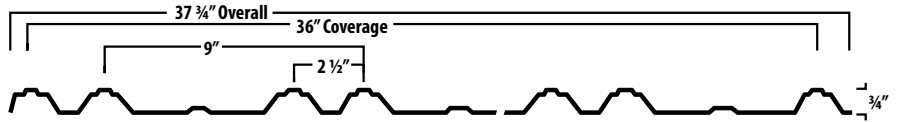

ABM Weatherstrong - Aluminum

.018 Diamond Embossed Aluminum. Custom lengths available with 1-3 day lead times.



Part#	Description	Coverage	Length
AWS0188	ABM Weatherstrong - Aluminum 12" Double Rib Spacing	36"	8'
AWS01810	ABM Weatherstrong - Aluminum 12" Double Rib Spacing	36"	10'
AWS01812	ABM Weatherstrong - Aluminum 12" Double Rib Spacing	36"	12'
AWS01814	ABM Weatherstrong - Aluminum 12" Double Rib Spacing	36"	14'
AWS01816	ABM Weatherstrong - Aluminum 12" Double Rib Spacing	36"	16'

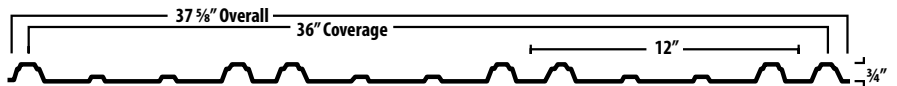



REALTREE



Realtree® Printed Camouflage

COMMON APPLICATIONS

- Interior Accent Walls and Wainscoting
- Exterior Siding and Wainscoting

FEATURES

- Substrate: AZ-50 Galvalume
- Made to custom lengths
- 29 Gauge Steel
- 25-year warranty

Part#	Description	Gauge	Cvg.
C1SCA	1-1/4" Corrugated Realtree Camo *	29	24"
C2SCA	2-1/2" Corrugated Realtree Camo *	29	24"
SCA	ABM Panel Realtree Camo	29	36"

* Continious corrugated panels not recommended for roofing due to short rib height and no anti-siphon channel.

CC = Color Code

S.O. = Special Order

★ = Size







AGED METAL

Painted-Rust Kynar Coating
with 40-Year Warranty

EXTERIOR DURABILITY • INTERIOR CHARM



ABM PANEL
36" wide coverage
Made to custom lengths



ABSEAM PANEL
16.5" wide standard coverage
Made to custom lengths



1-1/4" CORRUGATED*
24" wide coverage
Made to custom lengths



2-1/2" CORRUGATED*
24" wide coverage
Made to custom lengths

*CORRUGATED NOT RECOMMENDED FOR ROOFING DUE TO SHORT RIB HEIGHT AND NO ANTI-SIPHON CHANNEL

CC = Color Code

S.O. = Special Order

★ = Size

Metal Panels | 21



METAL BOARD & BATTEN

MADE TO LENGTH

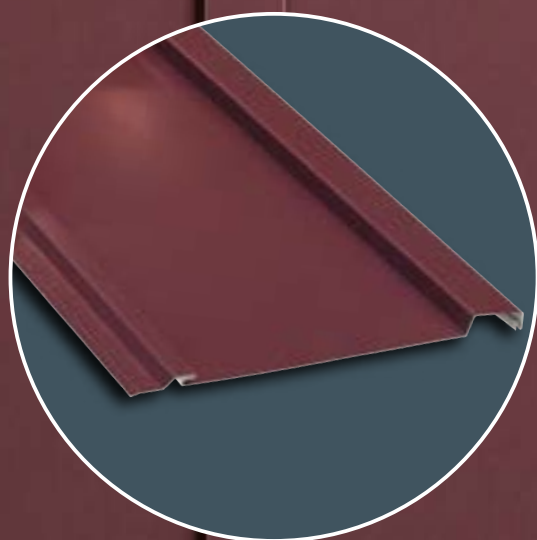

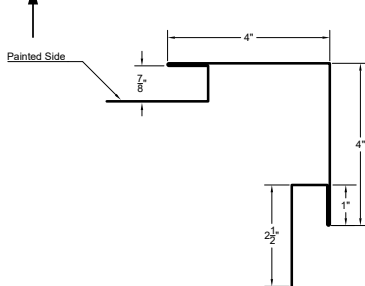
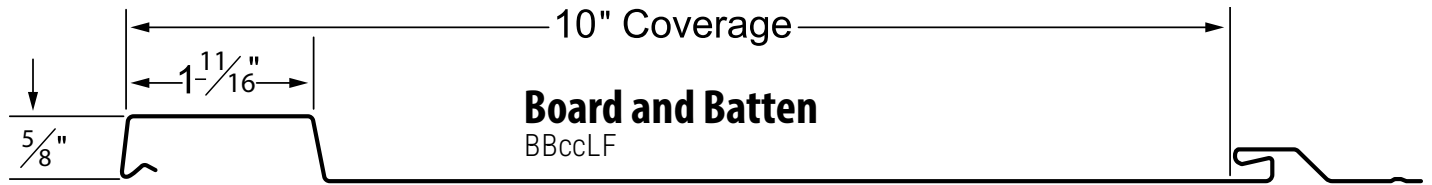
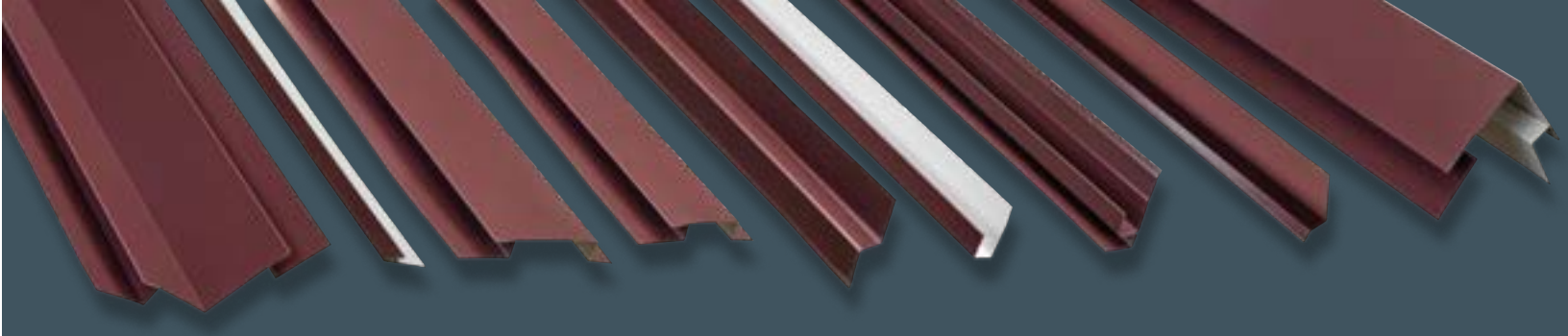

Outside Corner
BBOcc • 10' 2"

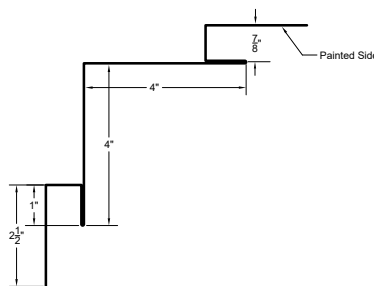

Inside Corner
BBIcc • 10' 2"

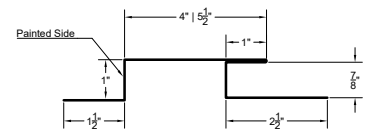

Band Board
BBBB*cc • 4" & 5 1/2" • 10' 2"



Utility Trim
BBUTcc • 10' 2"

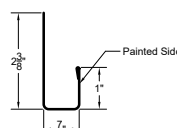

J Channel
Jcc • 10' 2"

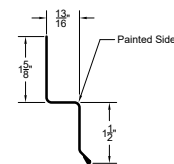

Double Angle
DAcc • 10' 2"

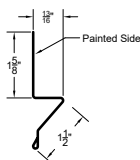

Base Angle
BAcc • 10' 2"

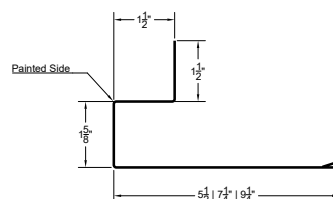

Door Trim
JTcc • 10' 2"

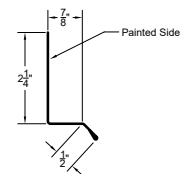

Drip Cap
DCcc • 10' 2"

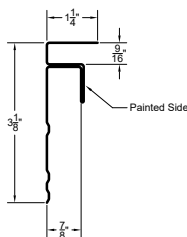

F & J Channel
FJcc • 10' 2"

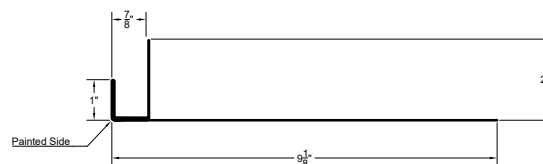

Overhead Door Trim
ODcc • 10' 2"



Same Awesome Look.
Unlimited Profiles.



TEXTURED SHADOW GRAY

TEXTURED BLACK

TEXTURED

LESS GLARE | MORE GRIP

SAME 40-YEAR WARRANTY

Why Choose Textured?

Our textured panels continue to be very popular in residential applications.

Homeowners like it because the unique textured surface redirects sunlight for less glare than smooth panels. Plus the textured panels are less prone to "oil canning" which makes for a more attractive roof.

Contractors like it because the texture provides more grip during installation than smooth panels.

Because the textured coating is baked into the metal coil at the factory, our textured panels carry the same 40-year film integrity warranty as our smooth panels.



Textured

Smooth

TEXTURED BLACK

CC = Color Code

S.O. = Special Order

★ = Size

Metal Panels | 25



NEW!



The HERITAGE Panel

Get a classic look with this exposed fastener roof panel!

- 28 Gauge or 26 Gauge
- 3/4" High Ribs with 12" Spacing
- 36" Coverage
- Made to custom lengths

TEXTURED BRONZE

CC = Color Code

S.O. = Special Order

★ = Size

Metal Panels | 27



Metal Roofing Accessories





Painted Steel Soffit

In order for the hot air to escape out of the ridge vent, fresh air needs to enter the building from somewhere, and our vented steel soffit allows the correct amount of fresh air to equalize the air pressure caused by the escaping heat. Our 29 gauge solid and vented steel soffit is available in over 45 of our metal colors. It's stocked in standard lengths, and available in custom lengths from 1.5' to 24'.

FEATURES

- Color-matched to our metal panel colors.
- Heavy-duty 29 gauge steel.
- Vented stocked in 12" wide coverage by 11.5" for 12" overhang.
- Solid made to order from 1.5 feet to 24 feet.

Part#	Description	Size
SOSVcc12	Vented Steel Soffit 12" Wide x 12" Overhang Triple Four	12" x 11.5"
SOSVccLF	Vented Steel Soffit 12" Wide Custom Length Triple Four	12" x
SOSSCC12	Solid Steel Soffit 12" Wide x 12" Overhang Triple Four	12" x 11.5"
SOSScc18	Solid Steel Soffit 12" Wide x 18" Overhang Triple Four	12" x 17.5"
SOSSCCLF	Solid Steel Soffit 12" Wide Custom Length Triple Four	12" x



CSAWH

Coil Stock

Stocked in popular colors.

Part#	Description	Thickness	Size
CSAcc	Aluminum Coil Stock - Mastic	0.019	24" x 50'
CSScc	Steel Coil Stock	29 ga / 26 ga	21" x 50'
CSSTcc	Textured Steel Coil Stock	26 ga	21" x 50'
CSSGV	Acrylic-Coated Galvanized Steel	29 ga	27.5" x 50'

Touch Up Paint

As careful as you might try to be, even the very best installers might not make it throughout the installation process without a scratch. And since the paint is the first line of defense against a rusting metal panel, it is imperative that the scratch be repaired. That's where our touch up paint comes in. A word of caution though. Because the performance of touch up paint is rarely the same as the factory-applied finish, it should always be used in moderation and only as much as is necessary.

FEATURES

- Color-matched to our metal panel colors.
- Available in 4 oz cans with a lid brush for our ABM Panel colors, and 0.3 oz paint pens for our ABM Panel and ABSeam Panel colors.



Part#	Description	Size
PTUABMcc	Touch Up Paint for ABM Colors - Can	4 oz
PTUABMccP	Touch Up Paint for ABM Colors - Pen	0.3 oz
PTUABSc	Touch Up Paint for ABSeam Kynar Colors - Pen	0.3 oz



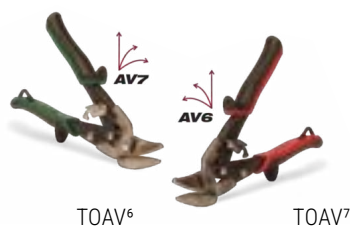

Offset Aviation Snips - Malco

Malco Offset AV Aviation Snips feature grooved non-slip POWER-FIT™ performance hand grips that naturally distribute pressure evenly across the user's hand, resulting in a more natural feel with less fatigue and increased strength. Safety hand guards allow the user to cut quickly into sheet metal, while preventing the hand from slipping forward over the blades. A self-opening latch provides convenience for the user to quickly open.

Part#	Description	Handling/Cutting	Color
TOAV6	Offset Aviation Snip	Right Hand/Left Cut	Red
TOAV7	Offset Aviation Snip	Left Hand/Right Cut	Green

Capacities				
Aluminum	Copper	Stainless Steel	Galvanized Steel	Milled Steel
.062 (1.57)	.054 (1.37)	.036 (0.91) 20 Ga.	.052 (1.32) 18 Ga.	.048 (1.22) 18 Ga.



Mini Aviation Snips - Malco

With an overall length of only 7-1/8 inches (181 mm), the AVsMini easily goes to work in tight or awkward spaces where full-size aviation snips are challenged. A 3/4 inch (19 mm) length of cut provides the optimum speed for confined cutting applications where this small, maneuverable snip excels. Each snip is made with forged steel jaws that contain precision-ground serrations on the lower blade, which produces a sharply defined edge for cutting accuracy and control.

Part#	Description	Handling/Cutting	Color
TOAVM6	Mini Aviation Snip	Right Hand/Left Cut	Red
TOAVM7	Mini Aviation Snip	Left Hand/Right Cut	Green

Capacities	
Cold Rolled Steel	Stainless Steel
.024 (0.61) 24 Ga.	.028 (0.38) 28 Ga.

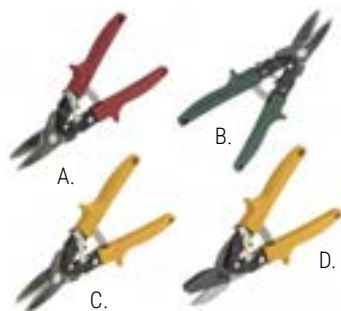

MAX Snips - Malco

Features superior hardened blade edges for maximum cutting life. Riveted, head-to-handle compound linkage multiplies hand leverage applied by user. Linkage will not rattle or loosen ever! And an easily adjustable pivot bolt, with nylon locking nut, holds its adjustment securely for these hard-working aviation snips.

Part#	Description	Handling/Cutting	Color
A. TOM2001	MAX 2001 Snip	Right Hand/Left Cut	Red
B. TOM2002	MAX 2002 Snip	Left Hand/Right Cut	Green
C. TOM2003	MAX 2003 Snip	Combo Cut	Yellow
D. TOM2004	MAX 2004 Snip	Double Cut	Yellow

Capacities				
Aluminum	Copper	Galvanized Steel	Milled Steel	Stainless Steel
.062 (1.57)	.054 (1.37)	.054 (1.37) 18 Ga.	.048 (1.22) 18 GA.	.038 (0.97) 20 Ga.



MAX Offset Snips - Malco

Features superior hardened blade edges for maximum cutting life. Riveted, head-to-handle compound linkage multiplies hand leverage applied by user. Linkage will not rattle or loosen ever! And an easily adjustable pivot bolt, with nylon locking nut, holds its adjustment securely for these hard-working aviation snips.

Part#	Description	Handling/Cutting	Color
TOM2006	Offset MAX 2006 Snip	Right Hand/Left Cut	Red
TOM2007	Offset MAX 2007 Snip	Left Hand/Right Cut	Green

Capacities				
Aluminum	Copper	Galvanized Steel	Milled Steel	Stainless Steel
.062 (1.57)	.054 (1.37)	.054 (1.37) 18 Ga.	.048 (1.22) 18 GA.	.038 (0.97) 20 Ga.

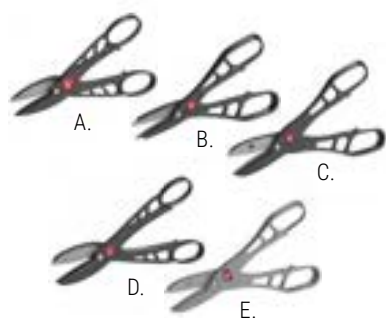

Andy Snips - Malco

Sleek styling, easy blade replacement and larger handles make the Andy™ Snip more versatile. A sleek head design improves maneuverability. Ideal for making cuts in vinyl siding, aluminum, copper, or sheet metal.

Part#	Description
A. TOMC12A	12" Andy Classic Snip
B. TOMC12N	12" Lightweight Andy Snip
C. TOMC14N	14" Aluminum Andy Snip
D. TOMC14A	14" Aluminum Snip
E. TOM14N	14" Aluminum Andy Snips

Capacities				
Aluminum	Copper	Stainless Steel	Galvanized Steel	Mild Steel
.035 (0.89)	.023 (0.58)	.018 (0.46) 26 Ga	.028 (0.71) 24 Ga	.024 (0.61) 24 Ga

Hand Notcher - Malco

Specialized for folding and fabricating metal, including metal ductwork. The N2R Hand Notcher makes a full 1-inch (25.4 mm) deep "V" shaped cut.



Part#	Description
TON²R	1" Hand Notcher

Capacities				
Aluminum	Copper	Stainless Steel	Galvanized Steel	Mild Steel
.035 (0.89)	.023 (0.58)	.018 (0.46) 26 Ga	.028 (0.71) 24 Ga	.024 (0.61) 24 Ga

Power Shears - Malco



Part#	Description
TOTS1	Metal Cutting Shear Attachment
TOTSCM	Corrugated Metal Turbo Shear Attachment
TOTSHD	Heavy Duty Turbo Shear Attachment
TOTSHD1A	Pneumatic Metal Shear





Single Crimper - Malco

Fast, easy to use, and lightweight. Handy lock makes tool pocket sized. Zinc plated steel. Red grips.

Part#	Description			
TOSC2	Single Crimper			
Capacities				
Aluminum	Copper	Stainless Steel	Galvanized Steel	Mild Steel
.035 (0.89)	.023 (0.58)	.018 (0.46) 26 Ga	.028 (0.71) 24 Ga	.024 (0.61) 24 Ga



Snap Lock Punch - Malco

The Malco model SL2R Adjustable Snap Lock Punch can be used as a gutter end cap crimper or for use in creating locking tabs in light sheet metals. A slide adjustment for throat depth allows settings from 1/4 to 5/8 inch (6 to 16 mm) depth. An Engineered handle opening compliments the natural power stroke of any user's hand and maximizes the powerful 7:1 mechanical advantage of compound-leverage head to handle linkage.

Part#	Description
TOSL2R	Snap Lock Punch



J-Channel Cutter - Malco

Use the versatile Malco J-Channel Cutter to make drain tabs, downstream notch cutouts and miter trim cuts in vinyl channel. Light hand pressure produces a single handle click signal to ensure perfect drain tabs every time. Use either side of the jaws to cut a 45-degree miter for a professional finished look.

Part#	Description	Blade Depth
TOJCCR	J-Channel Cutter	5/8" - 1-1/4"



Replacement Blades - Malco

Part#	Description	Blade Depth
TOM14ARB	Replacement Blades For M14A	
TOM14NRB	Replacement Blades For M14N # M14NRB	
TOMC12NRB	Replacement Blades For Mc12n/Mc12ng	
TOMC14ARB	Replacement Blade For Mc14a Snips	
TOMC14NRB	Replacement Blades For Mc14n	
TOMC14RB	Replacement Blades For MC14	
TOTS1RB	Turbo Shear Replacement Blades For Small Turbo Shear	
TOTSCMRB	Turbo Shear Replacement Blades For TSCM	
TOTSHDRB	Replacement Blades For Hd Turbo Shear	



Aviation Snips - Malco

Part#	Description	Handling/Cutting	Color
A. TOAV33	Long Cut Aviation Snips	Right Hand/Straight Cut	Red
B. TOAV63	Long Cut Aviation Snips	Right Hand/Left Cut	Green
C. TOAV73	Long Cut Aviation Snips	Left Hand/Right Cut	Blue



Milwaukee Nibbler and Shears

Part#	Description	Gauge
Y2476-20	M12 Fuel Variable Speed Nibbler Milwaukee (Bare Tool)	16
Y6852-20	Heavy Duty 360 Swivel Power Shear 6.8amp (Bare Tool)	18
Y2637-20	M18 Single Cut Shear (Bare Tool)	18
Y2637-22	M18 Single Cut Shear Kit	18



Mag Snips - Midwest

Part#	Description	Handling/Cutting	Color
TOM2110L	Mag Snips	Left Hand/Right Cut	Red
TOM2210R	Mag Snips	Right Hand/Left Cut	Green

Cold Rolled Steel	Stainless Steel
24 Ga.	28 Ga.

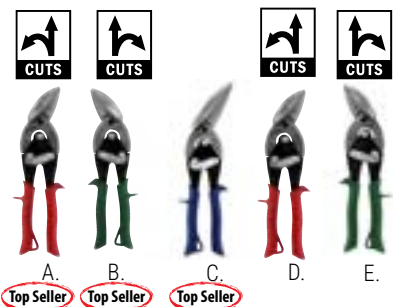

Offset Snips - Midwest

Part#	Description	Handling/Cutting	Color
A. TOP6510L	18 Ga. Offset Snips	Right Hand/Left Cut	Red
B. TOP6510R	18 Ga. Offset Snips	Left Hand/Right Cut	Green
C. TOP6516	20 Ga. Power Cutter Offset Long Cut		Blue
D. TOSSP6510L	22 Ga. Stainless Steel Offset Snips	Right Hand/Left Cut	Red
E. TOSSP6510R	22 Ga. Stainless Steel Offset Snips	Left Hand/Right Cut	Green



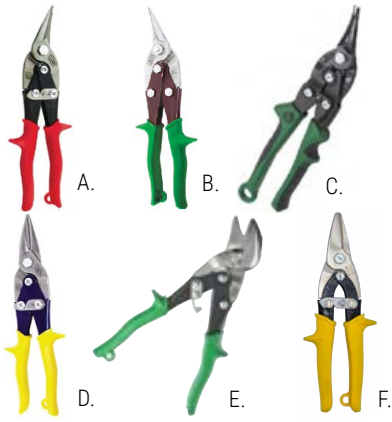

Aviation Snips - Wiss

Part#	Description	Handling/Cutting	Color
A. YM1R	9-3/4" 18 Ga. Aviation Snips	Left Cut	Red
B. YM2R	9-3/4" 18 Ga. Aviation Snips	Right Cut	Green
C. YM2X	4-1/4" 18 Ga. Aviation Snips	Right Cut	Green
D. YM3R	9-3/4" 18 Ga. Aviation Snips	Straight Cut	Yellow
E. YM7R	9-3/4" 18 Ga. Aviation Snips	Left Cut	Green
F. YMPC3N	20 Ga. Multi-Purpose Aviation Snips		Yellow



Offset Snips - Wiss

Part#	Description	Handling/Cutting	Color
A. TOM6R	9" Offset Snips	Left Cut	Red
B. YM300	12-1/4" 20 Ga. Utility Snips		Orange
D.			

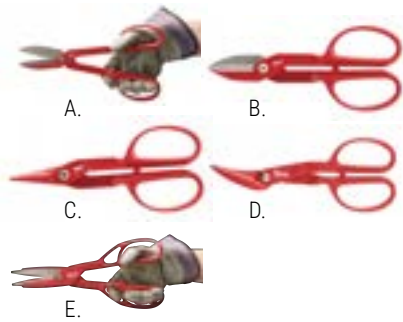

Tinners - Milwaukee

Part#	Description
A. Y48-22-4002	12" 20 Ga. Classic Tinner
B. Y48-22-4003	10" 22 Ga. Classic Tinner
C. Y48-22-4004	10" 22 Ga. Duckbill Tinner
D. Y48-22-4005	10" 18 Ga. Compound Tinner
E. Y48-22-4006	13" 24 Ga. Lightweight Tinner
F. Y48-22-4007	Lightweight Tinner Replacement Blades



Cutting Snips - Milwaukee

Part#	Description	Handling/Cutting	Color
Y48-22-4510	Cutting Snips	Left Cut	Red
Y48-22-4520	Cutting Snips	Right Cut	Green
Y48-22-4530	Cutting Snips	Straight Cut	Yellow

Cold Rolled Steel	Stainless Steel
18 Ga.	22 Ga.



18 Gauge Cutting Snips - Milwaukee

Part#	Description	Handling/Cutting	Color
Y48-22-4512	18 Ga. Cutting Snips	Left Cut	Red
Y48-22-4522	18 Ga. Cutting Snips	Right Cut	Green



24 Gauge Cutting Snips - Milwaukee

Part#	Description	Handling/Cutting	Color
Y48-22-4511	24 Ga. Cutting Angle Snips	Left Cut	Red
Y48-22-4521	24 Ga. Cutting Angle Snips	Right Cut	Green



Aviation Snips - Milwaukee

Part#	Description	Handling/Cutting	Color
A. Y48-22-4532	22 GA. OFFSET AVIATION SNIPS	Straight Cut	Yellow
B. Y48-22-4537	20 GA. AVIATION SNIPS	Long Straight Cut	Yellow
C. Y48-22-4538	22 GA. OFFSET AVIATION SNIPS	Long Straight Cut	Red
D. Y48-22-4533	3 PIECE AVIATION SNIPS	Set	R/Y/G





Hand Seamers - Malco

Part#	Description
A. TOS2R	3" Hand Seamer Redline
B. TOS3R	3" Offset Hand Seamer Redline
C. TOS5R	5" Hand Seamer Redline
D. TOS6R	6" Hand Seamer Redline
E. TOS9	9" Hand Seamer Redline



Seamer and Tongs - Malco

Part#	Description	Type
TOSG10	Seamer & Tongs	Straight Gripped Jaws
TOSG11	Offset Seamer & Tongs	Gripped Jaws



Folding Tool - Malco

Part#	Description	Size
ABSBT	Abs Bending Tool {Hemming Tool}	24"
ABSBTH18	Abs Bending Tool {Hemming Tool With Handle}	18"
ABSBTH24	Abs Bending Tool {Hemming Tool With Handle}	24"

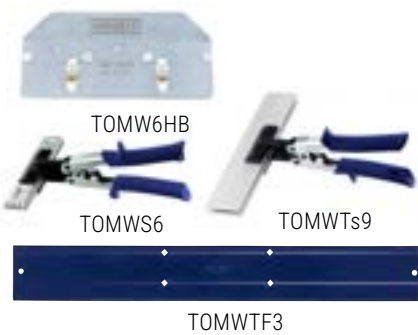

Folding Tool - Midwest

Part#	Description
TOMW6HB	6" Adjustable Hand Brake
TOMWS6	6" Hand Seamer
TOMWTS9	9" Hand Seamer
TOMWTF3	24" Folding Tool



Folding Tool - Wiss

Part#	Description
YWF18	18" Folding Tool
YWF24	24" Folding Tool
YWS4	3" Offset Hand Seamer
YWS6	6" Hand Seamer



James Way Slitter

Heavy-duty hand-operated metal slitter for Aluminum, Steel, and Vinyl. Easily and smoothly cuts up to 24 gauge metal. Made from 3/4" milled aluminum for long-lasting performance.

Part#	Description
JWS	James Way Slitter
JWSRW	Replacement wheels / James Way Slitter Metal & Vinyl



James Way Valley Square

Aluminum frame with stainless steel hardware. Invented and manufactured by the Amish in Pennsylvania. This square is designed to improve speed and quality when installing metal roofing in valleys. It eliminates the need for chalking vertical lines for each piece of metal and countless times of pulling out a tape measure. The tabbed side of the square is placed against the last roofing panel, and the side leg is aligned with the valley and secured with the adjustment leg. The square is then laid on the next piece, instantly transferring the angle of the valley.

Part#	Description
JWVS	James Way Valley Squaretool



Metal Man Valley Super Square

Take the guesswork out of complex roof geometries with the Metal Man Valley Super Square. Specifically engineered for the metal roofing industry, this rugged, American-made tool is designed to drastically reduce layout time while ensuring flawless accuracy on every cut.

Part#	Description
SSQUARE	Metal Man Valley Super Square



Rib Runner Metal Roofing And Siding Tool

The Rib Runner® tool is a patented new and innovative tool for the pre-installation of 9-inch metal roofing and siding (AG Panel).

Part#	Description	Specification
RRUNNER	Rib Runner Metal Roofing and Siding Tool - 9" Rib Panel	9"





Vanmark Industrial Metal Master Brake

The Industrial Metal Master® 20 EZ comes with the latest in manufacturing to provide the best one-stop-shop for all your job site bending, from "W" style valley-pan & rake edges, to soffits & roof flashings, including wide hip and ridge cap, to HVAC duct & plenum work. POWERlock™ provides a strong clamping without need for adjusting. POWERslot™ hinge "auto-measures" 5 / 8" hem with ease. Increased bending radius simplifies hemming & over-bending resulting in faster, easier operations. Stand included.

Part#	Description	Length	Throat	Frame	Max Gauge	Stand
TOBIM1065	VanMark Industrial Metal Master	10' 6"	20"	7 C-Frames	20-24 Ga. Steel/.05 Alum.	•



Vanmark Metal Master Brake

The Metal Master® 20 was originally designed for the metal roofing industry and this why it is engineered the largest throat depth portable bending brake available. POWERlock™ provides a strong clamping without need for adjusting. POWERslot™ hinge "auto-measures" 5 / 8" hem with ease. Increased bending radius simplifies hemming resulting in faster, easier operations.

Part#	Description	Length	Throat	Frame	Max Gauge
TOBMM1060	VanMark Metal Master	10' 6"	20"	4 C-Frames	29 Ga. Galv./ .027 Alum.
TOBMM1061	VanMark Metal Master	10' 6"	20"	5 C-Frames	26 Ga. Galv./ .032 Alum.

TOBMM1061 Pictured

Stands or legs sold separately



Vanmark TrimMaster Mark II

The POWERslot™ Hinge "auto-measures" to a 5 / 8" bend to make tight pockets for vinyl siding and fiber cement boards. The durable Cam-Locking has proven year after year to be reliable without constant adjustments. POWERlock™ provides a strong clamping without need for adjusting. POWERslot™ hinge "auto-measures" 5 / 8" hem with ease. Increased bending radius simplifies hemming resulting in faster, easier operations.

Part#	Description	Length	Throat	Frame	Max Gauge
TOBTM1060	VanMark TrimMaster Mark II	10' 6"	14"	5 C-Frames	29 Ga. Galv./ .032 Alum.
TOBTM1061	VanMark Heavy Duty TrimMaster Mark II	10' 6"	14"	9 C-Frames	26 Ga. Galv./ .032 Alum.
TOBTM6	VanMark TrimMaster Mark II	6' 6"	14"	3 C-Frames	26 Ga. Max
TOBTM8	VanMark TrimMaster Mark II	8' 6"	14"	4 C-Frames	26 Ga. Max

TOBTM1060 Pictured

Stands or legs sold separately



Vanmark Trim-A-Brake II

Great for bending basic shapes to trim out windows, doors, and much more. The simple design makes it easy for even the novice user to bend metal. Hinge pockets help prevent damage to the brake while scoring. Full loop handle provides uniform bending along entire piece. Material stops allow repeat bending without re-measuring. Design with a 3 / 8" x 13" working pocket.

Part#	Description	Length	Throat	Frame	Max Gauge
TOBT1050	VanMark Trim-A-Brake II	10' 6"	13"	5 C-Frames	26 Ga. Galv./ .024 Alum
TOBT ⁸⁵⁰	VanMark Trim-A-Brake II	8' 6"	13"	4 C-Frames	26 Ga. Galv./ .024 Alum

Stands or legs sold separately

MORE SPECIAL ORDER BRAKES AVAILABLE



Vanmark TrimCutter

Its unique low-profile and 4-point track system keeps the tool adjacent to the brake and cutting accurately. The hardened steel knives cut up to 24 ga. Painted Steel Grade D and are design to cut through thousands of feet of material without getting dull while leaving a "factory" smooth edge that is free of sharp points.

Part#	Description
TOB3017TRIM	TrimCutter for VanMark





Vanmark UniStand

The UniStand™ Adjustable was designed to provide a stand as strong as Van Mark's bending brakes are. It has a stand that is both rigid, durable, and adjustable to meet the user's need. The wheels now make it easy to transport your tool anywhere on the jobsite.

Part#	Description
TOBUSA1LEG	USA1 UniStand w/ Wheels for Brakes, Up to 14" Throat
TOBUSA2LEG	USA2 UniStand w/ Wheels 20 Series Brakes, 20" Throat



Vanmark Leg Kit

The Van Mark Steel Folding Legs are a strong and durable stand that folds up for transport and storage. It is easily installed using a Phillips screwdriver.

Part#	Description
TOB3001LEG	Steel Leg Kit for Trim A Brake I & II
TOB3002LEG	Steel Leg Kit for Mark I & II



Vanmark Wheel Kit

The Van Mark Wheel Kit can be quickly installed on any Van Mark Brake. The durable wheel kit will make it easier to move a bending brake around the jobsite.

Part#	Description
TOB3004WHL	Wheel Kit fits USA1 & USA2 Stands



Vanmark UniLeg

The UniLeg™ was engineered to make a simple, yet durable leg kit for any contractor. The 2-piece design makes it easy for one user to setup at any jobsite without needing any tools. The 100% Steel Welded Construction will allow the legs to last as long as the Van Mark tool does.

Part#	Description
TOBUNL1	UniLeg UNL1 for 14" Throat Brakes
TOBUNL2	UniLeg UNL2 for 20" Throat Brakes

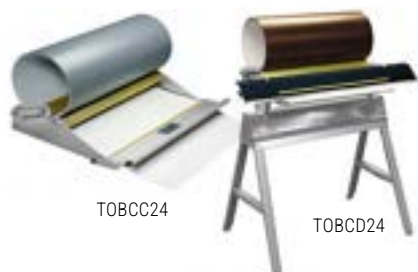

TOBCC24

TOBCD24

Vanmark Coil Cradle and Dispenser

Part#	Description
TOBCC24	Coil Cradle (Holds up to 24" Coil Stock up to 300 lbs)
TOBCD24	Coil Dispenser (24" With Score Guide)



Vanmark Angle and Trim Cutter Guide

The Multi Gauge™ is one of those tools that any Van Mark brake user should not be without. Its lightweight design and versatility makes it easy to set up and easy to use. No more guessing on bend angles, no more measuring 1 ½" out for your TrimCutter™. Speed up your jobs and make your bends more accurate. The Multi Gauge™ is sold as a pair.

Part#	Description
TOBMGA	Multi-Gauge, Angle & Trim Cutter Guide (3978 Vanmark)



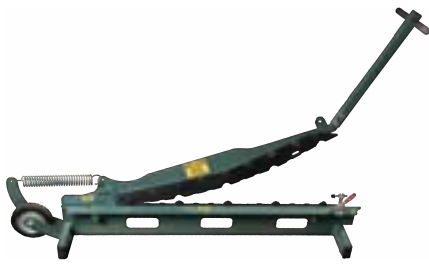

Ag Panel Shear with Detachable Blades Special Order

This portable shear is a great, affordable tool for cutting metal roofing and siding panels quickly and easily. This shear can cut multiple profiles and angles by changing the blades. Straight and angle cuts with gable pitches up to $5/12$ can be accomplished with only one tool by using 2 sets of blades.

A handy rubber tipped clamp firmly holds the panel in place for accurate, and fast cutting.

Part#	Description	Max Gauge
ABMACD	Dyna Cut Panel Chop Shear with Detachable Blades	24 gauge



ABMBLADESTRAIGHT

Panel Shear Replacement Blades - Special Order

Part#	Description
ABMBLADE	Set of Replaceable Angle Cut Blades - S.O.
ABMBLADESTRAIGHT	Set of Replaceable Straight Cut Blades - S.O.

MORE SPECIAL ORDER SHEARS AND PROFILE BLADES AVAILABLE

Roofing Screws & Fasteners



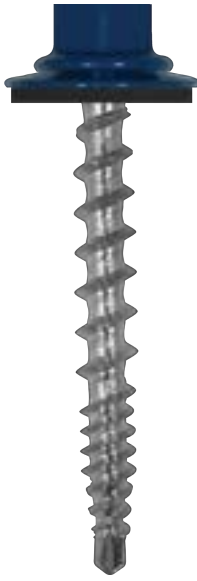

WoodBinder - ST Fastening Systems

Our most popular screw by far is the WoodBinder screw from ST Fastening Systems. We supply millions of these screws each year – most of which are used to attach our ABM Panel to post frame and residential metal roofing and siding applications. We use our buying power to get you better pricing - even on direct ship orders.

Sold in bags of 100 and 250. Color-matched colors in stock, with many more colors available for direct ship.

FEATURES

- Fastener designed to attach steel roofing & siding used in post-frame & residential metal roofing applications.
- Powder Coated for exceptional corrosion resistance.
- Threads transition from fine to coarse to generate superior holding strength in various wood substrates.
- Micro-Bit™ point reduces metal shavings that can embed themselves in the rubber washer.
- EPDM rubber is vulcanized to a steel washer to form an excellent seal even when driven at an angle.

Part#	Description	Carton Qty	Head Size	Size
S1cc	1" WoodBinder Metal-to-Wood Screw	3000	1/4"	#10 x 1"
S15cc	1-1/2" WoodBinder Metal-to-Wood Screw	2500	1/4"	#10 x 1-1/2"
S2cc	2" WoodBinder Metal-to-Wood Screw	2000	1/4"	#10 x 2"
S25cc	2-1/2" WoodBinder Metal-to-Wood Screw	1500	1/4"	#10 x 2-1/2"
S3cc	3" WoodBinder Metal-to-Wood Screw	1000	1/4"	#10 x 3"
SD34cc	3/4" WoodBinder Metal-to-Wood Stitch Screw	2500	1/4"	#12 x 3/4"



IMPACT DRIVER

FOR PROPER INSTALLATION, THE USE OF IMPACT DRIVERS ARE NOT RECOMMENDED FOR POWDER COATED OR ANY WET PAINTED FASTENER.

MB™ New Micro-Bit™ Engineering



Easy Multi-Layer Penetration

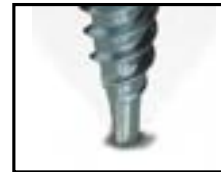

Eliminates Slow or No Drill



Minimizes Pigtails

TECHNICAL INFORMATION	DRILL POINT	MAJOR DIAMETER	MINOR DIAMETER	WASHER/HEAD DIAMETER	HEAD ACROSS FLATS	ULT. TENSILE STRENGTH	MIN. TORSIONAL STRENGTH	NOM. SHEAR STRENGTH
10-16/8	MICRO-BIT	.205/.191	.121/.116	.348/.322	NOM. .250"	1904 LBS.	56 IN.-LBS.	1547 LBS.
#12-14 STITCH	MICRO-BIT	.215/.209	.160/.153	.348/.322	NOM. .250"	2900 LBS.	88 IN.-LBS.	1962 LBS.

PULL OUT STRENGTH VALUE (LBS. ULT.)	NOM. GAUGE	MATERIAL			SUBSTRATE													
		HRS PRIMED ONLY			3/4" PLY		5/8" PLY		1/2" PLY		7/16" OSB		2X Y.PINE		2X SPF			
		THICKNESS	.060	.075	.105	(3)	(4)	(3)	(4)	(3)	(4)	(3)	(4)	(1)	(2)	(4)	(1)	(2)
10-16/8	N/A	N/A	N/A	N/A	636	N/A	441	N/A	368	N/A	210	N/A	713	1526	N/A	466	1216	N/A
#12-14 STITCH	N/A	N/A	N/A	N/A	N/A	N/A	297	N/A	329	N/A	217	N/A	N/A	495	N/A	N/A	N/A	162

PULL OVER STRENGTH VALUE (LBS. ULT.) (EPDM ONLY)	DESIGNATION	MATERIAL							
		A255 GALVALUME				G90	ALUMINUM	SLOT EDGE PANEL	
		NOM. GAUGE	THICKNESS	THICKNESS	THICKNESS	THICKNESS	THICKNESS	THICKNESS	
#10 W/ BONDED 12 MM WASHER		29	.014	.018	.024	.030	.036	.028	.014
#12-14 STITCH W/ BONDED 12 MM WASHER		29	.014	.018	.024	.030	.036	.028	.014

Powder Coated Paint Zinc Plating and Chromate Sealer

EPDM Rubber Seal

Hex Washer Head with EPDM rubber washer provides a watertight seal on roof applications. ST Fastening Systems sockets are designed to allow for the added thickness of the powder coat.

The combination of the Micro-Bit point & transition thread from fine to coarse generates superior drill speed in metal & holding strength in wood substrates.

NOTES: 1. All strength values shown below are ultimate values, expressed in LBS. Apply an appropriate safety factor to obtain design limit



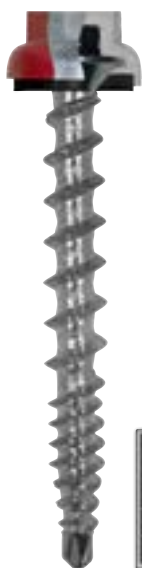

No Red-Rust Guaranteed!



IMPACT DRIVER

FOR PROPER INSTALLATION, THE USE OF IMPACT DRIVERS ARE NOT RECOMMENDED FOR POWDER COATED OR ANY WET PAINTED FASTENER.

ZXL WoodBinder with 40-Year Warranty ST Fastening Systems

If your metal roofing has a 40-year warranty, your screw should too. That's the thinking behind the ZXL WoodBinder from ST Fastening Systems. The ZXL screw has a $\frac{5}{16}$ zinc/aluminum molded head that offers lifetime protection against red rust. That means, even if the powder coating is chipped during installation, the screw is not going to cause rust streaks down the panel. Plus, the molded head covers the washer – protecting it from damaging UV rays. The ZXL screw is an excellent choice for any long-lasting Galvanized or Galvalume roof system.

Sold in bags of 100 and by the carton. Color-matched colors in stock, with many more colors available for direct ship.

FEATURES

- Designed to fasten steel roofing plywood or OSB used in residential construction, and to wood purlins used in post-frame construction.
- $\frac{5}{16}$ " cupped HWH with a molded ZAMAC 5 Zinc-Aluminum alloy provides lifetime protection against red rust on the head & washer. The ZAMAC 5 alloy provides more strength than more common ZAMAC 3 alloy. (You may obtain a free copy of the written warranty upon request.)
- Threads transition from fine to coarse to generate superior holding strength in various wood substrates.
- Micro-Bit point reduces metal shavings that can embed themselves in the rubber washer.

Part#	Description	Carton Qty	Head Size	Size
S1Zcc	1" WoodBinder Metal-to-Wood Screw	3000	5/16"	#10 x 1"
S15Zcc	1-1/2" WoodBinder Metal-to-Wood Screw	2500	5/16"	#10 x 1-1/2"
S2Zcc	2" WoodBinder Metal-to-Wood Screw	2000	5/16"	#10 x 2"
S25Zcc	2-1/2" WoodBinder Metal-to-Wood Screw	1500	5/16"	#10 x 2-1/2"
S3Zcc	3" WoodBinder Metal-to-Wood Screw	1000	5/16"	#10 x 3"

MB™ New Micro-Bit™ Engineering



Easy Multi-Layer Penetration

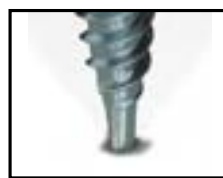

Eliminates Slow or No Drill



Minimizes Pigtails

TECHNICAL INFORMATION	DRILL POINT	MAJOR DIAMETER	MINOR DIAMETER	WASHER/HEAD DIAMETER	HEAD ACROSS FLATS	ULT. TENSILE STRENGTH	MIN. TORSIONAL STRENGTH	NOM. SHEAR STRENGTH
10-16/8	MICRO-BIT	.210/.191	.121/116	.500"	NOM .312"	1585*** LBS.	60 IN.-LBS.	1574 LBS.
#12-14 STITCH	MICRO-BIT	.215/.209	.160/.153	.500"	NOM .312"	2900 LBS.*	88 IN.-LBS.	1962 LBS.

PULL OUT STRENGTH VALUE (LBS. ULT.)	NOM. GAUGE	MATERIAL			SUBSTRATE													
		HRS PRIMED ONLY			(1) 1" PENETRATION				(2) 1 1/2" PENETRATION				(3) FULL PENETRATION					
		16	14	12	3/4" PLY		5/8" PLY		1/2" PLY		7/16" OSB		2X Y.PINE		2X SPF			
	THICKNESS	.060	.075	.105	(3)	(4)	(3)	(4)	(3)	(4)	(3)	(4)	(1)	(2)	(4)	(1)	(2)	(4)
10-16/8		N/A	N/A	N/A	636	N/A	441	N/A	368	N/A	210	N/A	713	1526	N/A	466	1216	N/A
#12-14 STITCH		N/A	N/A	N/A	N/A	N/A	297	N/A	329	N/A	217	N/A	N/A	N/A	495	N/A	N/A	162

PULL OVER STRENGTH VALUE (LBS. ULT.) (EPDM ONLY)	DESIGNATION	MATERIAL						
		AZ55 GALVALUME				G90	ALUMINUM	SLOT EDGE PANEL
		NOM. GAUGE	29	26	24	22	20	21
	THICKNESS	.014	.018	.024	.030	.036	.028	.014
10-16/8 (EPDM ONLY)		658	927	1035	1386	N/A	N/A	N/A
#12-14 STITCHSD (EPDM ONLY)		658	927	1035	1386	N/A	N/A	N/A

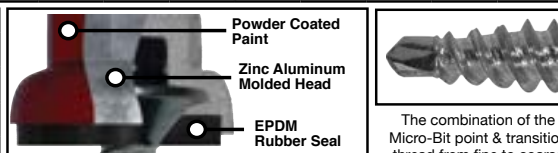

The Zinc-Aluminum alloy HWH prevents red rust from ever starting. ST Fastening Systems spring retainer sockets are designed to allow for the added thickness of the powder coat and are recommended.

NOTES: 1. All strength values shown below are ultimate values, expressed in LBS. Apply an appropriate safety factor to obtain design limit





OSB WoodBinder - ST Fastening Systems

If you are going to be fastening metal roofing into soft OSB, ST Fastening Systems has developed a special WoodBinder with extra grip for better OSB performance.

Sold in bags of 250. Stocked in 3/4" Galvanized (GV), Black (BL), Brown (BN), Burgundy (BU), Bronze (BZ), Charcoal (CH), Clay (CL), Colonial Red (CR), Evergreen (EG), Forest Green (FG), Barn Red (RD), Slate Blue (SB), and Bright White (BW) with more colors and sizes available for special order.

FEATURES

- Fastener designed to attach steel roofing to OSB sheeting.
- Powder Coated for exceptional corrosion resistance.
- EPDM rubber is vulcanized to a steel washer to form an excellent seal even when driven at an angle.



IMPACT DRIVER

FOR PROPER INSTALLATION, THE USE OF IMPACT DRIVERS ARE NOT RECOMMENDED FOR POWDER COATED OR ANY WET PAINTED FASTENER.

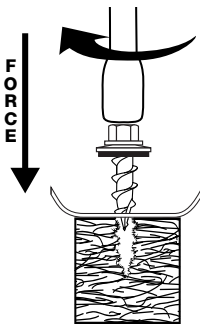

Rescue Screw with Anti-Strip Out Technology



Residential

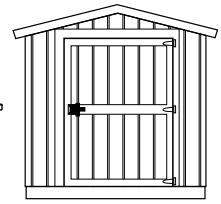

Backyard Sheds

TECHNICAL INFORMATION	DRILL POINT	MAJOR DIAMETER	MINOR DIAMETER	WASHER/HEAD DIAMETER	HEAD ACROSS FLATS	ULT. TENSILE STRENGTH	MIN. TORSIONAL STRENGTH	NOM. SHEAR STRENGTH							
#12 TYPE 17	Sharp Point	.215/.210	.130/.135	.348/.322	.250 NOM	2450 LBS.	65 IN.-LBS.	2100 LBS.							
PULL OUT STRENGTH VALUE (LBS. ULT.)	MATERIAL			SUBSTRATE											
	HRS PRIMED ONLY			3/4" PLY		5/8" PLY		1/2" PLY		7/16" OSB		2X Y.PINE		2X SPF	
	NOM. GAUGE	16	14	12	(1)	(2)	(1)	(2)	(1)	(2)	(1)	(2)	(1)	(2)	
THICKNESS	.060	.075	.105	(1)	(2)	(1)	(2)	(1)	(2)	(1)	(2)	(1)	(2)	(1)	(2)
#12 TYPE 17	N/A	N/A	N/A	380	585	453	588	297	390	198	212	438	1090	378	739

NOTES: 1-1/2" LENGTH FULLY PENETRATES OSB AND PLYWOOD SHEETING

PULL OVER STRENGTH VALUE (LBS. ULT.) (EPDM ONLY)	DESIGNATION	MATERIAL			
		AZ55 GALVALUME			
	NOM. GAUGE	29	26	24	22
THICKNESS	.015	.019	.024	.032	
#12 TYPE 17 (EPDM WASHER ONLY)	378	629	721	N/A	

NOTES: 26 AND 29 GA. VALUES SHOWN WERE OBTAINED USING 80 KSI STEEL SHEETING. 24, 22, AND 20 GA. VALUES WERE OBTAINED USING 50 KSI MINIMUM STEEL SHEETING.

BMT DENOTES BASE METAL THICKNESS AFTER REMOVAL OF PAINT FINISH AND METALLIC PROTECTIVE COATING.

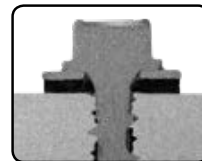

KS V-Neck
Anatomy of the KS V-neck weather tight system



Strip-Loc thread to point technology grips the fiber of OSB



SteelBinder - ST Fastening Systems

Fastener designed to attach metal roof and sidewall panels used in pre-engineered metal building applications.

FEATURES

- #12 Diameter 5/16" Cupped HWH self-drilling fastener easily penetrates steel up to .210" in thickness with no "point walking." 1/4" Stitch will securely fasten 2 layers of 26 GA with no strip-out.
- Cupped head & washer encapsulate EPDM rubber washer & provide a secure seal even when driven at an angle.
- All unpainted maxx steelbinder® fasteners come standard with duraseal® plus enhanced corrosion resistance coating.



IMPACT DRIVER

FOR PROPER INSTALLATION, THE USE OF IMPACT DRIVERS ARE NOT RECOMMENDED FOR POWDER COATED OR ANY WET PAINTED FASTENER.

Part#	Description	Carton Qty	Head Size	Size
SD34cc	3/4" Self-Drill Stitch Screw	2500	1/4"	#12 x 3/4"
SD78cc	7/8" Self-Drill Stitch Screw	2500	5/16"	#12 x 7/8"
SD1cc	1" SteelBinder Self-Dill Metal-to-Metal Screw	2500	5/16"	#12 x 1"
SD125cc	1-1/4" SteelBinder Self-Dill Metal-to-Metal Screw	2500	5/16"	#12 x 1-1/4"
SD15cc	1-1/2" SteelBinder Self-Dill Metal-to-Metal Screw	2000	5/16"	#12 x 1-1/2"
SD2cc	2" SteelBinder Self-Dill Metal-to-Metal Screw	1500	5/16"	#12 x 2"
SD25cc	2-1/2" SteelBinder Self-Dill Metal-to-Metal Screw	1500	5/16"	#12 x 2-1/2"
SD3cc	3" SteelBinder Self-Dill Metal-to-Metal Screw	1000	5/16"	#12 x 3"

TECHNICAL INFORMATION	DRILL POINT (DIA)	MAJOR DIAMETER	MINOR DIAMETER	WASHER FACE DIAMETER	HEAD ACROSS FLATS	NOM. TENSILE STRENGTH	MIN. TORSIONAL STRENGTH	NOM. SHEAR STRENGTH
#12	.181/.177	.215/.209	.164/.157	.560/.545	NOM .312"	2900 LBS.	92 IN.-LBS.	1962 LBS.
1/4" STITCH	.156/.150	.246/.240	.192/.185	.560/.545	NOM .312"	3800 LBS.	150 IN.-LBS.	2850 LBS.

PULL OUT STRENGTH VALUE (LBS. ULT.)	NOM. GAUGE	MATERIAL													
		HRS PRIMED ONLY			AZ55 GALVALUME				G-90 GALVANIZED				HRS. PLATE		
		16	14	12	26	24	22	18	20	18	16	14	12	3/16"	1/4"
THICKNESS	.060	.075	.105	.018	.024	.030	.048	.036	.048	.060	.075	.105	.187	.250	
#12	927	958	1678	N/A	N/A	N/A	N/A	N/A	N/A	729	787	1041	1372	N/A	N/A
1/4" STITCH	N/A	N/A	N/A	342	378	418	1038	620	N/A	N/A	N/A	N/A	N/A	N/A	N/A

PULL OVER STRENGTH VALUE (LBS. ULT.)	DESIGNATION	MATERIAL						
		AZ55 GALVALUME				G90	ALUMINUM	SLOT EDGE PANEL
		29	26	24	22	20	21	29
THICKNESS	.014	.018	.024	.030	.036	.028	.014	
#12	687	1090	1299	1562	N/A	N/A	N/A	
1/4" STITCH	746	960	1261	1376	N/A	N/A	N/A	

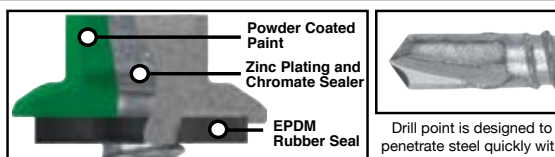

Cupped HWH head design improves Pull over strength versus standard HWH & Bonded Washer. ST Fastening Systems sockets are designed to allow for the added thickness of the powder coat.

Drill point is designed to penetrate steel quickly with no "point walking"

- NOTES:
1. HRS (Hot Rolled Steel)
 2. Pull over values calculated with EPDM rubber washer assembled to cupped head screw with .555" washer face.
 3. All strength values shown are ultimate values, expressed in LBS. Apply an appropriate safety factor to obtain design limits.





HWH SteelBinder with Washer - ST Fastening System

Self-drilling screws that are designed for general construction applications

FEATURES

- Drill points are designed to penetrate a wide variety of metal thicknesses from thin sheet metal to 0.250".
- Applications include HVAC, roof deck to steel framing, and roof clips to steel framing.
- #10 and #14 HWH are available with or without a bonded sealing washer. The #12 HWH is available only without a sealing washer. The #12 MAXX® cupped head is available for applications requiring a washer.

Part#	Description	Carton Qty	Head Size	Size
SD1415GV	1-1/2" #14 Galvanized Metal-to-Metal Screws	1500	3/8"	#14 x 1-1/2"
SD142GV	2" #14 Galvanized Metal-to-Metal Screws	1000	3/8"	#14 x 2"
SD1425GV	2-1/2" #14 Galvanized Metal-to-Metal Screws	1000	3/8"	#14 x 2-1/2"

HWH SteelBinder - ST Fastening Systems

Self-drilling screws that are designed for general construction applications

FEATURES

- Drill points are designed to penetrate a wide variety of metal thicknesses from thin sheet metal to 0.250".
- Applications include HVAC, roof deck to steel framing, and roof clips to steel framing.

Part#	Description	Carton Qty	Head Size	Size
SDNW34WH	3/4" #12 Galv. Metal-to-Metal Screws - White	3000	5/16"	#12 x 3/4"
SDNW1	1" #12 Galvanized Metal-to-Metal Screws	2500	5/16"	#12 x 1"
SDNW15	1-1/2" #12 Galvanized Metal-to-Metal Screws	2000	5/16"	#12 x 1-1/2"
SDNW2	2" #12 Galvanized Metal-to-Metal Screws	1500	5/16"	#12 x 2"
SDNW25	2-1/2" #12 Galvanized Metal-to-Metal Screws	1500	5/16"	#12 x 2-1/2"
SDNW3	3" #12 Galvanized Metal-to-Metal Screws	1000	5/16"	#12 x 3"
SDNW4	4" #14 Galvanized Metal-to-Metal Screws	500	3/8"	#14 x 4"
SDNW5	5" #14 Galvanized Metal-to-Metal Screws	500	3/8"	#14 x 5"
SDNW6	6" #14 Galvanized Metal-to-Metal Screws	500	3/8"	#14 x 6"



TECHNICAL INFORMATION	DRILL POINT (DIA)	MAJOR DIAMETER	MINOR DIAMETER	WASHER FACE DIAMETER	HEAD ACROSS FLATS	NOM. TENSILE STRENGTH	MIN. TORSIONAL STRENGTH	NOM. SHEAR STRENGTH
#1/4-14 (3/8" AF)	.216/.210	.246/.240	.192/.185	.520/.480	NOM .375"	3697 LBS.	150 IN-LBS.	2682 LBS.
#12-14 (5/16" AF)	.180/.175	.215/.209	.164/.157	.432/.398	NOM .312"	2900 LBS.	92 IN-LBS.	1962 LBS.
#1/4-14 (5/16" AF)	.156/.150	.246/.240	.192/.185	.432/.398	NOM .312"	3697 LBS.	150 IN-LBS.	2682 LBS.

PULL OUT STRENGTH VALUE (LBS. ULT.)	NOM. GAUGE	MATERIAL													
		HRS PRIMED ONLY				AZ55 GALVALUME				G-90 GALVANIZED				HRS. PLATE	
		16	14	12	26	24	22	18	20	18	16	14	12	3/16"	1/4"
	THICKNESS	.060	.075	.105	.018	.024	.030	.048	.036	.048	.060	.075	.105	.187	.250
#14-14 (3/8" AF)		986	1070	2003	342	418	486	1038	620	868	890	1107	1327	N/A	N/A
#12-14 (5/16" AF)		927	958	1678	N/A	N/A	N/A	N/A	N/A	729	787	1041	1372	N/A	N/A
#14-14 (5/16" AF)		986	1070	2003	342	418	486	1038	620	868	890	1107	1327	N/A	N/A

PULL OVER STRENGTH VALUE (LBS. ULT.)	DESIGNATION	MATERIAL						
		AZ55 GALVALUME				G90	ALUMINUM	SLOT EDGE PANEL
		29	26	24	22	20	21	29
	THICKNESS	.014	.018	.024	.030	.036	.028	.014
#14-14 (3/8" AF) BONDED WASHER (16mm)		N/A	1001	1206	1649	N/A	N/A	N/A
#12-14 (5/16" AF) BONDED WASHER (14mm)		N/A	780	1078	1355	1608	N/A	N/A
#14-14 (5/16" AF) STITCH BONDED WASHER (14mm)		N/A	892	1076	1243	1916	N/A	N/A

#10 and 1/4" HWH are available with or without a bonded sealing washer. The #12 HWH is available only without a sealing washer. The #12 MAXX™ Steelbinder fastener is available for applications requiring a washer.

PULLOUT & PULLOVER VALUES ARE DETERMINED IN THE ST FASTENING SYSTEMS ENGINEERING LABORATORY USING STEEL PANELS/FRAMING & WOOD DENSITIES WHOSE STRUCTURAL PROPERTIES ARE FOUND IN PRESENT DAY PRODUCTS.

NOTES: 1. *HRS (Hot Rolled Steel)
2. All values shown are ultimate values, expressed in LBS. Apply an appropriate safety factor to obtain design limits.



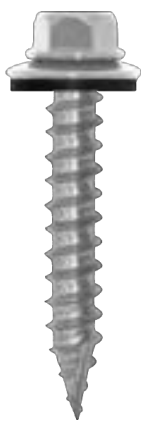

#14 WoodBinder Nail-Replacement ST Fastening Systems

Designed to be used as a “rescue screw”. This fastener will replace nails or smaller diameter fasteners that have loosened & backed out of steel roofing over time.

FEATURES

- 5/16" HWH with bonded sealing washer will completely cover existing hole, even if elongated by movement in the metal roof.
- EPDM rubber is vulcanized to the steel washer to prevent delamination & form an excellent seal even when driven at an angle.
- Type 17 point will help clean the existing hole so that oversized threads can tap & generate maximum holding strength.
- Sold in 100/count bags and cartons.
- Stocked in Galvanized with special order colors available.



IMPACT DRIVER

FOR PROPER INSTALLATION, THE USE OF IMPACT DRIVERS ARE NOT RECOMMENDED FOR POWDER COATED OR ANY WET PAINTED FASTENER.

Part#	Description	Carton Qty	Head Size	Size
S14**S0	#14 Special Order Color Screws			
S1434	3/4" #14 Galvanized Metal-to-Wood Screws		5/16"	#14 x 3/4"
S141	1" #14 Galvanized Metal-to-Wood Screws	2000	5/16"	#14 x 1"
S1415	1-1/2" #14 Galvanized Metal-to-Wood Screws	1500	5/16"	#14 x 1-1/2"
S142	2" #14 Galvanized Metal-to-Wood Screws	2500	5/16"	#14 x 2"
S1425	2-1/2" #14 Galvanized Metal-to-Wood Screws	1000	5/16"	#14 x 2-1/2"

TECHNICAL INFORMATION	DRILL POINT	MAJOR DIAMETER	MINOR DIAMETER	WASHER/HEAD DIAMETER	HEAD ACROSS FLATS	ULT TENSILE STRENGTH	MIN. TORSIONAL STRENGTH	NOM. SHEAR STRENGTH
#14-10	30° SHARP POINT T-17	.254/.248	.185/.178	.398/.432	NOM .312"	4270 LBS.	125 IN.-LBS.	2997 LBS.

PULL OUT STRENGTH VALUE (LBS. ULT.)	MATERIAL			SUBSTRATE														
	HRS PRIMED ONLY			(1) 1" PENETRATION				(2) 1 1/2" PENETRATION				(3) FULL PENETRATION						
	NOM. GAUGE	16	14	12	3/4" PLY		5/8" PLY		1/2" PLY		7/16" OSB		2X Y.PINE		2X SPF			
#14-10	THICKNESS	.060	.075	.105	(3)	(4)	(3)	(4)	(3)	(4)	(3)	(4)	(1)	(2)	(4)	(1)	(2)	(4)
#14-10		800	1250	2017	723	N/A	487	N/A	391	N/A	227	N/A	856	1669	N/A	594	1235	N/A

PULL OVER STRENGTH VALUE (LBS. ULT.) (EPDM ONLY)	DESIGNATION	MATERIAL						
		AZ55 GALVALUME				G90	ALUMINUM	SLOT EDGE PANEL
	NOM. GAUGE	29	26	24	22	20	21	29
#14 -10 (14MM O.D. BONDED WASHER)	THICKNESS	.014	.018	.024	.030	.036	.028	.014
#14 -10 (W/ NO WASHER)		N/A	722	1040	1197	1419	N/A	N/A



Hex Washer Head with EPDM rubber will completely cover the existing hole to provide a watertight seal.



The Type 17 point will clean the existing hole of metal burrs & the oversized threads will generate increased holding strength.

NOTES: All strength values shown below are ultimate values, expressed in LBS. Apply an appropriate safety factor to obtain design limits.





Nail Replacement Screw Levi's Building Components

Choose from mechanical galvanized or stainless steel options in 1-1/2", 2" or 2-1/2" sizes when looking to replace nails or screws that have failed. The sharp point drills easily and oversized 5/8" EPDM washer seals tightly. Fasten aluminum panels effortlessly using the SS screw. Stocked in Galvanized in all sizes. Stocked in 1.5" and 2" in Black (BL), Brown (BN), Burgundy (BU), Bronze (BZ), Charcoal (CH), Clay (CL), Colonial Red (CR), Evergreen (EG), Barn Red (RD), Slate Blue (SB), and White (WH). More special order colors and sizes available for special order.

FEATURES

- Mechanical Galvanized in Colors or Bare Stainless Steel
- EPDM washer 5/8" OD
- Replace failing nails or screws
- Ask about in-stock colors for quick shipment



IMPACT DRIVER

FOR PROPER INSTALLATION, THE USE OF IMPACT DRIVERS ARE NOT RECOMMENDED FOR POWDER COATED OR ANY WET PAINTED FASTENER.

Part#	Description	Carton Qty	Head Size	Size
SNR15CC	1-1/2" Nail Replacement Screw	2500	5/16"	#12 x 1-1/2"
SNR2CC	2" Nail Replacement Screw	1500	5/16"	#12 x 2"
SNR25CC	2-1/2" Nail Replacement Screw	1000	5/16"	#12 x 2-1/2"
SSNR15	1-1/2" Nail Replacement Screw - Stainless	2500	5/16"	#12 x 1-1/2"
SSNR2	2" Nail Replacement Screw - Stainless	1500	5/16"	#12 x 2"
SSNR25	2-1/2" Nail Replacement Screw - Stainless	1000	5/16"	#12 x 2-1/2"



White Eclipse Pan Head Screw

Available in white with a washer for exterior applications. Uses a #25 Torx drive. applications and without a washer for interior

Part#	Description	Carton Qty	Drill Pt.	Head	Size
S1WHP	1" White Eclipse Pan Head Screws W/Washer	3000	Micro-bit	Truss	1"
S1WHPXW	1" White Eclipse Pan Head Screws Withoutwasher	3000	Micro-bit	Truss	1"
S15WHP	1-1/2" White Eclipse Pan Head Screws W/Washer	2500	Micro-bit	Truss	1-1/2"



SPA*

SDPA*

SSPA*



Pancake Screw

Ideal for fastening standing seam clips.

Part#	Description	Carton Qty	Drill Pt.	Head Style	Size
SPA1	1" Pancake Sharp Point Screw - Zinc Plated	5000	SP	Phillips/Square	#10 x 1"
SPA15	1-1/2" Pancake Sharp Point Screw - Zinc Plated	2500	SP	Phillips/Square	#10 x 1-1/2"
SPA2	2" Pancake Sharp Point Screw - Zinc Plated	2000	SP	Phillips/Square	#10 x 2"
SDPA1	1" Pancake Self-Drill Screw - Zinc Plated	5000	SD	Phillips/Square	#10 x 1"
SDPA15	1-1/2" Pancake Self-Drill Screw - Zinc Plated	2000	SD	Phillips/Square	#10 x 1-1/2"
SDPA2	2" Pancake Self-Drill Screw - Zinc Plated	2000	SD	Phillips/Square	#10 x 2"
SSPANC1	1" Pancake Sharp Point Screw - Stainless	5000	SP	#2 Square	#10 x 1"
SSPANC15	1-1/2" Pancake Sharp Point Screw - Stainless	2000	SP	#2 Square	#10 x 1-1/2"
SSPANC2	2" Pancake Sharp Point Screw - Stainless	2000	SP	#2 Square	#10 x 2"





Stainless Steel Trim Nails

FEATURES

- Type 204 Cu Stainless Steel for better corrosion resistance
- Plain 15 gauge shank
- Made in the USA
- Color-matched to our metal roofing colors

Stocked Colors: Ash Gray, Pebble Beige, Black, Brown, Burgundy, Bronze, Charcoal, Clay, Copper Penny, Colonial Red, Barn Red, Dark Blue, Evergreen/Forest Green, Gallery Blue, Lightstone (Almond), Patina Green, Pewter Gray, Barn Red, Slate Blue, Tan, and Bright White. Also stocking 14 Gauge Copper Trim Nails.

Part#	Description	Package Qty	Head Size	Length
NTRcc	1-1/4" Stainless Steel Trim Nails	1 lb (Approx. 620)	3/16"	1-1/4"

Hammer Caps

Reduce chipping on painted nails with the hammer cap 2 pack. Fits 16 oz. and 20 oz. round hammers.



Part#	Description	Package Qty
NTRHC	2 Hammer Caps Reduce Chipping on Painted Nails	2



Stainless Steel Zip Screws

Stocked #7 Colors: Bright White, Ash Gray, Avocado Green, Brown, Beige, Matte Black, Bright Red/Scarlet Red, Burgundy, Bone White, Classic Green/Evergreen, Charcoal, Clay, Copper Penny, Colonial Red, Dark Blue, Gallery Blue, Hawaiian Blue/Slate Blue, Hartford Green, Dark Bronze/Bronze, Light Stone, Mansard Brown, Medium Bronze, Musket Gray, Patina Green, Barn Red, Slate Gray, Sierra Tan, and Tan.

Also stocked in #8 Brass, and #10 Mill Finish Stainless and Bright White.

Part#	Description	Package Qty	Size	Length
SZIPcc	1/2" Zip Screws	100	#7	1/2"



Stainless Steel Pop Rivets

FEATURES

- Color-matched to our ABSeam Panel metal roofing colors
- Pre-drill with 1/8" Drill Bit
- Made in the USA

Stocked Colors: Stainless Steel, Matte Black, Brown, Bright Red, Burgundy, Classic Green, Charcoal, Copper Penny, Colonial Red, Dark Bronze, Gallery Blue, Hawaiian Blue, Hartford Green, Mansard Brown, Medium Bronze, Musket Gray, Slate Gray, Sierra Tan, and White.

Part#	Description	Package Qty	Head Size	Length
ABSRB	1/8" - 3/16" Stainless Steel Pop Rivets	100/Bag 100 bags/Box	3/16	1-1/2"
ABSRPc	1/8" - 3/16" Painted Stainless Steel Pop Rivets	100/Bag 100 bags/Box	3/16	1-1/2"
ABSRB42	1/8" - 1/8" #42 Stainless Steel Pop Rivets	100/Bag	3/16	1-1/2"
ABSRB48	3/8" - 1/2" #48 Stainless Steel Pop Rivets	100/Bag	3/16	2"

Copper Pop Rivets

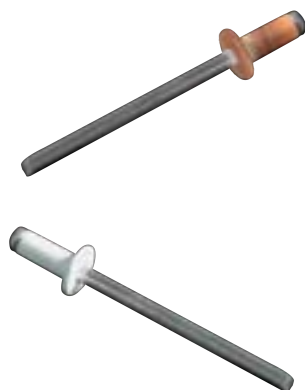

Part#	Description	Package Qty	Size
HCPR	Copper Pop Rivets	100/Bag 10 bags/Box	1-1/2"

Aluminum Pop Rivets

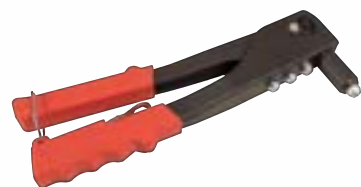

Part#	Description	Size	Pack Qt.
KPRW	White Pop Rivets - Aluminum	1-1/2"	100
KPRB	Brown Pop Rivets - Aluminum	1-1/2"	100

Hand Pop Riveter - Malco

FEATURES

- Short ratchet action power stroke
- Lightweight, compact size and slim nose projection
- Four rivet nosepieces (3/32-inch, 1/8-inch, 5/32-inch and 3/16-inch)
- Ideally suited for blind riveting applications in aluminum windows, gutter and downspout
- Spring return handles and comfortable contour grip

Part#	Description
TOCR18	Hand Pop Riveter Malco

M12 Rivet Tool - Milwaukee

FEATURES

- Pull Force: 2,000 lbs
- Stroke Length: 0.8"
- Rivet Sizes: 3/32" - 3/16"
- Rivet Material: Aluminum, Steel & Stainless Steel
- Nose Pieces: 3/32", 1/8", 5/32", & 3/16"
- Height/Width: 10.75" / 2.63"
- Length without mandrel collector: 6.5"
- Weight (w/ battery): 4.54 lbs



Part#	Description	Capacity
Y2550-22	M12 Rivet Tool Kit with 2 Batteries and Charger	3/32" - 3/16"
Y2550-20	M12 Rivet Tool - Tool Only	3/32" - 3/16"



Caulks & Sealants



2300® Construction Tripolymer Sealant - Geocel

The 2300® Construction Tripolymer Sealant in the 10.3 oz tubes are a single component, high-performance elastomeric sealant for use in a wide variety of roofing, trim, architectural metal, manufacturing, underdeck systems, solar roof systems, and general construction applications.



FEATURES

- Recommended for A.B Martin Metal Roofing
- Exceptional elongation and flexibility
- Excellent adhesion to many building surfaces, even when damp
- Remains flexible
- UV resistant
- Resealable, may be applied over itself
- Paintable
- Asphalt shingle compatible
- Easily applied, non-stringing formulation
- Cured sealant is mildew resistant

FOR USE ON

- Asphalt shingles, coated steel (Kynar 500® based finishes), concrete, vinyl, steel, and other common roofing substrates.

Available Colors and Case Quantities: Clear (24), Black (24), and White (24). Stocked in 10.3 oz. Other colors subject to availability.

Part#	Description	Case Qty	Tube Size
2300cc	2300 Geocel Caulking	Varies	10.3 oz
2300ccP	2300 Geocel Caulking in Plastic Tubes	24 Tubes	10.3 oz

Limitations: Do not use on traffic-bearing surfaces. Do not use on extruded polystyrene insulating sheathing (Styrofoam, etc.). Do not use on acrylic skylight glazing surfaces. Do not use in areas where food is processed or stored. Do not use for interior applications. Do not use for potable water applications. This product may not be sold in SCAQMD counties. This product in colors may not be sold in the state of California. The clear product is exempt from this rule, except in SCAQMD counties.

2310® Tripolymer Brushable Repair Coating - Geocel



2310® Tripolymer Brushable Repair Coating is a single-component, brushable elastic coating with rubber-like flexibility for small area use in many construction, roofing, manufacturing, and industrial applications.

FEATURES

- Exhibits adhesion to many common construction materials including damp, oily, or dirty surfaces
- Withstands water contact quickly after application to stop leaks
- Prevents rust on metal surfaces
- Cured coating is mildew resistant
- Paintable
- Crystal clear
- Resealable
- Applies in adverse weather
- Stays flexible
- Lever-lock lids on 3-gallon pails

FOR USE ON

- Asphalt shingles, coated steel (Kynar 500® based finishes), concrete, steel, vinyl, and other common building substrates.

Part#	Description	Case Qty	Size
2310G	2310 Tripolymer Brushable Repair Coating Clear	4 Cans	Gallon
2310Q	2310 Tripolymer Brushable Repair Coating Clear	6 Cans	Quart

Limitations: Do not use on traffic-bearing surfaces. Do not use on polystyrene insulation sheathing or EPDM. Do not use in areas where food is processed or stored. Product contains solvents that may craze some plastic materials. Do not use as a complete surface coating or in continuous underwater applications. For exterior use only due to odor emitted during cure. Do not use for potable water applications.





2315LRF® Leak Repair-Fibered Brushable Coating - Geocel

2315LRF® Leak Repair-Fibered Brushable Sealant is a single-component, elastic sealant with rubber-like flexibility for small area use. It is an ideal solution to stop roof leaks fast, even in damp conditions.

FEATURES

- Stops leaks fast
- Fibered for strength
- Will function in UV, heat, and intermittent foot traffic
- Withstands water contact quickly after application to stop leaks
- One-step application with no primer required
- Applies in adverse temperature ranges, including damp and icy conditions
- Cured sealant is mildew resistant
- Repairs small areas on slate, tile, shingles, and asphalt roofs
- Exhibits adhesion to many roofing materials, including damp, oily, or slightly dirty surfaces

FOR USE ON

- Asphalt shingles, coated steel (Kynar 500® based finishes), concrete, steel, vinyl, and other common building substrates.

Part#	Description	Case Qty	Can Size
2315G	2315LRF Leak Repair-Fibered Brushable Coating	4 Cans	Gallon
2315Q	2315LRF Leak Repair-Fibered Brushable Coating	6 Cans	Quart

Limitations: Do not use on polystyrene insulation sheathing or EPDM. Do not use in areas where food is processed or stored. Do not use as a complete surface coating or in continuous underwater applications. For exterior use only due to odor emitted during cure. Product contains solvents which may craze some plastic materials or discolor some light colored asphalt materials. Do not use for potable water applications.



2320® Construction Tripolymer Narrow Seam Sealant - Geocel

2320® Gutter and Narrow Seam Sealant is a single-component, elastomeric, semi-self-leveling, high performance tripolymer sealant designed to prevent the passage of air and moisture through small joints or seams.

FEATURES

- Excellent adhesion to many building surfaces, even when damp or oily
- Exceptional ultraviolet resistance
- Paintable
- Semi-self-leveling
- Cleans up easily
- Asphalt shingle compatible

FOR USE ON

- Asphalt shingles, brick (masonry), concrete, glass, vinyl, wood, sheet metal, and other common building substrates.

Part#	Description	Case Qty	Tube Size
2320	2320 Tripolymer Narrow Seam Sealant - Clear	24 Tubes	10.3 oz
2320A	2320 Tripolymer Narrow Seam Sealant - Aluminum Gray	24 Tubes	10.3 oz
2320W	2320 Tripolymer Narrow Seam Sealant - White	24 Tubes	10.3 oz

Limitations: Not recommended for joints larger than 1/4" x 1/4". Do not use on traffic-bearing surfaces. Do not use in contact with Styrofoam. Do not use for potable water applications. For exterior use only due to odor emitted during cure. This product may not be sold in the State of California.





4500® Roof Bonding Sealant - Geocel

Geocel 4500® Roof Bonding Sealant is a premium Scypolymer® one-component, proprietary bonding sealant specifically designed for roofing applications and systems. The advanced technology of Geocel 4500® Roof Bonding Sealant results in a product that quickly withstands ponding water while bonding to many common roofing substrates.

FEATURES

- Applies, adheres, and cures underwater
- 2 products in 1 - lap adhesive & scrim edge sealant
- No additional adhesives or sealants needed
- Remains flexible
- Works with EPDM membranes, tapes, and patches
- Can also be used as a night seal and for core/test cuts
- Non-flammable formulation

FOR USE ON

- Asphalt shingles, steel, concrete, EPDM, primed TPO, primed PVC, Hypalon (black only), metal, wood, and other common building substrates.

Part#	Description	Case Qty	Tube Size
4500BL	4500 Geocel Bonding Sealant - Black	24 Tubes	10 oz
4500WH	4500 Geocel Bonding Sealant - White	24 Tubes	10 oz

Limitations: Do not use on unprimed TPO or PVC membranes. Do not use black Geocel 4500 Roof Sealant on white EPDM. Do not use white Geocel 4500 Roof Sealant on black EPDM. Do not use for potable water applications. Do not use in areas where food is processed or stored.



8150® 100% Silicone High Performance Neutral Cure - Geocel

8150® 100% High Performance Neutral Cure Sealant is a high modulus, one-component silicone with excellent adhesion to both porous and non-porous surfaces. It provides joint movement capability of $\pm 25\%$ with excellent weatherability. Ideal for a variety of construction and industrial applications.

FEATURES

- 100% Silicone
- Neutral cure, high modulus
- Versatile, high performance
- Excellent adhesion to porous and non-porous surfaces
- High movement capability of $\pm 25\%$ -Excellent weatherability

FOR USE ON

- Aluminum, glass, wood, plastic, metal, concrete, etc.

Part#	Description	Case Qty	Tube Size
8150	8150 Geocel Construction Silicone - Clear	12 Tubes	10 oz

Limitations: Product is not recommended for exterior, below-grade use. Product is not recommended for continuous water immersion. Do not use in applications over tar, asphalt, or materials that bleed oils, plasticizers, or solvents. Do not use on marble substrates. Do not use in applications in airtight enclosures as the sealant requires atmospheric moisture to cure. Do not use on horizontal traffic joints. Do not use on brass, copper, or other sensitive metals as discoloration may occur. Product may stress-craze polycarbonate materials. Do not use for potable water applications.





Metal Roofing Sealant - NovaFlex

NovaFlex Metal Roof Sealant is a single-component, high-solid, low-odor material. It cures to a medium modulus, flexible, and durable rubber-like solid. NovaFlex Metal Roof Sealant will develop primerless adhesion to most common construction substrates, and the neutral cure is compatible with most materials.

Recommended for Sealing: Metal siding/metal roofs, gutters, wood, steel, chimney flashing, snow guards, pipe boots, and downspouts/trim.

FEATURES

- Great for exterior and interior sealing
- Permanently flexible
- Will not shrink or crack
- Waterproof
- Mold/mildew resistant
- Invisible to UV light
- Excellent adhesion to most building substrates
- Will not sag or slump
- Completely cured within 48 hours
- Tack-free in 10 minutes
- Excellent tooling properties
 - No solvents or odor (50-state VOC compliant)
 - Will not freeze

FOR USE ON

- Lap Joints
- Pipe Boots
- Trim
- Copper (exposed areas)
- Metal Siding
- Stucco
- Roof Flashing
- Downspouts
- Roof Tile
- Termination Bars
- Metal Roof
- PVC/PVDF
- Snow Guards
- Single-Ply
- Gutters
- Aluminum

Part#	Description	Case Qty	Tube Size
NOVAcc	NovaFlex Silicone Metal Roof Sealant	12 Tubes	10 oz
NOVACL	NovaFlex Silicone Metal Roof Sealant - Clear	12 Tubes	10 oz
NOVAWH	NovaFlex Silicone Metal Roof Sealant - White	12 Tubes	10 oz
NOVACH	NovaFlex Silicone Metal Roof Sealant - Charcoal	12 Tubes	10 oz
NOVABL	NovaFlex Silicone Metal Roof Sealant - Black	12 Tubes	10 oz
NOVABN	NovaFlex Silicone Metal Roof Sealant - Brown	12 Tubes	10 oz
NOVAEG	NovaFlex Silicone Metal Roof Sealant - Evergreen	12 Tubes	10 oz



WeatherMaster Metal Roof Sealant

Titebond WeatherMaster Metal Roof Sealant is a premium-grade, superior polymer formula that offers unbeatable adhesion to all metals including Kynar™ coated metals, aluminum, galvanized steel, copper and most common building materials. It can be extruded in extreme temperatures, remains permanently flexible and will not shrink, adheres well to wet and damp surfaces and is dust and dirt resistant.

FEATURES

- Flexible
- Will not crack
- Works in extreme temperatures
- Adheres to all metals, including coated and painted
- Does not shrink
- Paintable in 1 hour

FOR USE ON

- Metal Roofs, Windows, Doors, Siding, Gutters, Vents

Part#	Description	Case Qty	Tube Size
TBBL	Black Titebond WeatherMaster Metal Roof Sealant	12	9.5 oz
TBAG	Ash Gray Titebond WeatherMaster Metal Roof Sealant	12	9.5 oz
TBBN	Brown Titebond WeatherMaster Metal Roof Sealant	12	9.5 oz
TBBU	Burgundy Titebond WeatherMaster Metal Roof Sealant	12	9.5 oz
TBBW	Bone White Titebond WeatherMaster Metal Roof Sealant	12	9.5 oz
TBBZ	Bronze Titebond WeatherMaster Metal Roof Sealant	12	9.5 oz
TBCH	Charcoal Titebond WeatherMaster Metal Roof Sealant	12	9.5 oz
TBCL	Clear Titebond WeatherMaster Metal Roof Sealant	12	9.5 oz
TBCLA	Clay Titebond WeatherMaster Metal Roof Sealant	12	9.5 oz
TBCR	Colonial Red Titebond WeatherMaster Metal Roof Sealant	12	9.5 oz
TBDB	Dark Bronze Titebond WeatherMaster Metal Roof Sealant	12	9.5 oz
TBEG	Evergreen Titebond WeatherMaster Metal Roof Sealant	12	9.5 oz
TBGB	Gallery Blue Titebond WeatherMaster Metal Roof Sealant	12	9.5 oz
TBLS	Light Stone Titebond WeatherMaster Metal Roof Sealant	12	9.5 oz
TBMB	Medium Bronze Titebond WeatherMaster Metal Roof Sealant	12	9.5 oz
TBRD	Barn Red WeatherMaster Metal Roof Sealant	12	9.5 oz
TBSB	Slate Blue WeatherMaster Metal Roof Sealant	12	9.5 oz
TBSG	Slate Gray Titebond WeatherMaster Metal Roof Sealant	12	9.5 oz
TBWH	White Titebond WeatherMaster Metal Roof Sealant	12	9.5 oz

Limitations: Not designed for continuous submersion or use below the waterline. Air, sealant and surface temperature should be above 0°F. Copper should be coated to eliminate oxidation before sealing. Sealant is intended for exterior use. If used indoors, sealant may need to be painted. In most cases, painting may occur one hour after application with a high-quality acrylic, water-based (latex) paint that is plasticizer-free/resistant. Once sealant is applied, do not wipe with solvents. DO NOT TOOL – DO NOT SMEAR.





Lexel® - Sashco

Lexel® is the “duct tape” of all caulks. Super-elastic. Superior adhesion. Paintable. It seals around anything: tubs and shower stalls, sinks and counter tops, window frames and door frames, PVC and metal pipes. Apply to wet or dry surfaces, indoors and outdoors. It’s tough and can handle up to 400% joint movement. It’s scrubbable. It sticks to just about anything. Lexel® clear caulk is 19 times clearer than silicone and won’t yellow or cloud up over time. Lexel® won’t let you down.

FEATURES

- Tough: Survives routine scrubbing with household cleaners, including abrasive cleaners.
- Super elastic: When the surface moves, Lexel moves. No cracking, tearing, or pulling away for a lasting, permanent seal.
- Instantly waterproof: No waiting and wondering necessary. Use the sink or shower right away.
- Cured sealant is mold and mildew resistant: Keep unsightly and unhealthy growths where they belong – in a lab, not on your caulk.
- Sticks to wet surfaces: Dry weather may be days away. Lexel can be applied today.
- Ultra clear sealant: In fact, it’s 19x clearer than silicone. It won’t yellow and won’t go cloudy.
- Won’t freeze: Feel free to leave it in your truck or garage overnight. It’ll be fine in the morning.

FOR USE ON

Lexel® is excellent for use in a variety of areas and sticks to almost anything, including: Kitchen & bathroom fixtures, Countertops & backsplashes, Wallpaper (helps prevent curling), Around trim, Around windows & doors, Thresholds, Sills, Siding, Vents, Pipes & air conditioners, Around ductwork & HVAC, Wood & moulding/trim, and Masonry. Adheres to most roofing materials, including **Metals:** Aluminum, Brass, Steel, and Anodized Windows. **Plastics:** ABS, Nylon, PVC, Acrylic Sheet, Plexiglass, Urethane, Fiberglass, Polycarbonate, Vinyl, Lexan, and Polystyrene. **Other Surfaces:** Asphalt, Stone, Brick, Fiber Cement, Stucco, Tile, Concrete, Glass, Wood, Porcelain, and Mortar.

Part#	Description	Case Qty	Size
Y13043	General Purpose Lexel Caulk - White - 5 oz Tube	12 Tubes	5 oz
Y13013	General Purpose Lexel Caulk - Clear - 5 oz Tube	12 Tubes	5 oz
Y13080	VOC General Purpose Lexel Caulk - White - 10.5 oz Tube	12 Tubes	10.5 oz
Y13010	VOC General Purpose Lexel Caulk - Clear - 10.5 oz Tube	12 Tubes	10.5 oz

Limitations: Do not use on polystyrene insulation, where temperatures exceed 200°F, or in containment applications. Product will not adhere to or is incompatible with Aquaseal®, Kynar®, polypropylene, polystyrene foam insulation, polyethylene, rubber, silicone, Styrofoam® (it dissolves it), Teflon®, vulcanized rubber, and waxes.

RP-400® Plastic Wet-Dry Surface Roof Cement - Geocel

RP-400® Construction Plastic Wet-Dry Surface Roof Cement is a single-component, asbestos-free, asphalt-based cement designed for many construction, roofing, manufacturing, and industrial applications.

FEATURES

- Use on wet or dry roof surfaces, even underwater
- Formulated to seal quickly; will not pull apart or lose its bond
- Remains soft and pliable
- Resists temperature change

FOR USE ON

- Asphalt, steel, brick, wood, aluminum, and other common building substrates.



Part#	Description	Case Qty	Tube Size
RP400	RP400 Plastic Wet-/Dry Surface Roof Cement	24 Tubes	10 oz

Limitations: Do not paint or thin. Do not use with single-ply membranes such as EPDM, PVC, CSPE, etc. Product contains solvents that may craze some plastic materials. Store at room temperature for 24 hours before use to improve ease of application. Do not use in areas where food is processed or stored. Do not use in potable water applications. This product may not be sold in the state of California.



Through The Roof - Sashco

Make persistent leaks and repeated repairs a thing of the past. Get Through the ROOF!® This ultra-clear roof, gutter, and flashing caulk goes on easy and remains elastic year after year to permanently seal those nagging leaks. It can even be applied in the middle of a rain storm! It's proven to last 20 times longer than roof cement. Just say NO to leaks and repeated repairs and change your tune to "Five year leak GONE!"

FEATURES

- Permanently fixes nagging leaks: Proven to last 20 times longer than asphalt. Remains elastic and water-tight year after year.
- Do repairs today, even in a rain storm: Sticks to surfaces wet or dry, in temperatures down to 0° and up to 120°F.
- Repairs stick, but don't stick out: Tenacious adhesion to a wide variety of roofing materials and won't discolor them. Goes on crystal clear and stays clear.
- Easy to use: Easy to apply for professional-looking results every time.
- OK to leave in your unheated garage overnight: Through the ROOF!® won't freeze.
- Paintable with water-based paint after 24 hours. Paintable with oil-based paint after 1 week.

FOR USE ON

For repairs that stick, but won't stick out, use Through The ROOF! on common roofing fixtures and materials, including: Flashing, Gutters, Vents, PVC & ABS vent pipe, Skylights, Ductwork, Chimneys, Brick/block/mortar, Shingles & shakes, Roof jacks, cables, air conditioning units, and more.

Adheres to most roofing materials, including **Metals:** Aluminum, Brass, Steel, and Anodized Windows. **Plastics:** ABS, Nylon, PVC, Acrylic Sheet, Plexiglass, Urethane, Fiberglass, Polycarbonate, Vinyl, Lexan, and Polystyrene. **Other Surfaces:** Asphalt, Stone, Brick, Fiber Cement, Stucco, Tile, Concrete, Glass, Wood, Porcelain, and Mortar.



Part#	Description	Case Qty	Size
PTRC	Through The Roof Sealant - Clear - 10.1 OZ Tube	12 Tubes	10.1 oz
PTRQ	Through The Roof Sealant - Clear - Quart	6 Bottles	Quart
PTRG	Through The Roof Sealant - Clear -Gallon	2 Cans	Gallon
PTRBL	Through The Roof Sealant - Black - 10.1 OZ Tube		10.1 oz
PTRWH	Through The Roof Sealant - White - 10.1 OZ Tube		10.1 oz

Limitations: Do not use in areas of submersion or frequent, prolonged puddling, with polystyrene insulation, or in containment applications. Plastics not listed should be tested for compatibility before use. Product will not adhere to or is incompatible with Aquaseal®, Kynar®, polypropylene, polyethylene, silicone, Styrofoam® (it dissolves it), Teflon®, and waxes.

Sealant Tape

A 100% solid, asbestos free butyl tape sealant in roll form. Available for direct ship from ST Fastening Solutions.



FEATURES

- Applications include metal roof endlaps, sidelaps, vents, gutters, pipe flashings, skylights.
- Service temperature range is -40 Degrees F- +180 Degrees F
- Material will not become brittle or crack.

Part#	Description	Case Qty	Size
IST38	3/8 inch Sealant Tape	40 Rolls	3/32" x 3/8" x 45'
IST12	1/2 inch Sealant Tape	32 Rolls	3/32" x 1/2" x 45'
IST34	3/4 inch Sealant Tape	24 Rolls	3/32" x 3/4" x 45'
IST1	1 inch Sealant Tape	20 Rolls	3/32" x 1" x 45'
IST25	2-1/2 inch Sealant Tape	6 Rolls	3/16" x 2-1/2" x 20'





QUAD® Window, Door, and Vinyl Siding Caulk - OSI

QUAD® All Season Formula sealant is designed for superior performance on exterior window, door, siding & trim applications. Self tooling, paintable and dust/dirt resistant with over 3,500 colors to ensure perfect color matches every time.

Stocked in Clear (CL), Black (BL), Brown (BN), Bronze (BZ), Charcoal (CH), Clay (CLA), Desert Sand (DS), Evergreen (EG), Harbor Gray (HG), White (WH), and Wiker (WI).

FEATURES

- All-weather, self-tooling, permanently flexible formula sealant
- Designed for diverse window, door, siding and trim applications
- Resists dirt, dust and bonds without primer to common substrates

FOR USE ON

- Exterior Windows and Doors
- Fiber-cement and Vinyl Siding
- PVC Trim
- Roofing and Gutters

Adherers without primer to most common substrates like Cedar, Painted or Stained Woods, Fiberglass, Vinyl, Coated Aluminum, Steel, Metal, Brick, Masonry, and Concrete

Part#	Description	Case Qty	Tube Size
QUADcc	Quad Window, Door, and Siding Sealant	12 Tubes	10 oz

Limitations: Do not use for sealing expansion joints, including butt joint. Not compatible with polystyrene foams and polypropylene or polyethylene plastics. Do not use in applications requiring continuous water immersion. Do not use as a traffic bearing sealant, on log homes or inside occupied structures. For best results, should not be used in applications less than ¼" in depth in order to maintain the integrity of the sealant. Do not use to fill nail holes. For joints deeper than ¾" (9.5 mm), a backing material should be used. Tooling, feathering or smearing of the sealant is not necessary or recommended.

Quad® MAX Window, Door, and Vinyl Siding Caulk - OSI

Discover the First Line of Defense Against the Elements. Simply put, OSI QUAD® MAX siding & window sealant delivers the toughness that really makes a job last. QUAD® MAX is the next generation of siding and window sealants, providing maximum durability and superior application performance for use in any condition.

Stocked in Clear (CL), and White (WH).

FEATURES

- Proven Wet Surface Application
- Better Flexibility: 5x Stretch & 50% Joint Movement
- Consistent Bead in Hot or Cold Temperatures: 0°F to 140°F Application
- 24 Hour Fast Cure for Quicker Protection
- Paintable in 1 Hour
- Strong Adhesion to More Building Materials Without Primer
- Enhanced UV Resistance

FOR USE ON

- Designed for sealing around interior/exterior windows, doors and siding.
- Adherers without primer to most common substrates like fiber cement, cedar, brick, stone, coated aluminum, fiberglass, vinyl, PVC, stucco, EIFS, wood, glass, and flashing tapes and Kynar® coatings.

Part#	Description	Case Qty	Tube Size
QUADCLM	Quad Max Window, Door, and Siding Sealant - Clear	12 Tubes	10 oz
QUADWHM	Quad Max Window, Door, and Siding Sealant - White	12 Tubes	10 oz

Limitations: Do not use joints immersed in water or applications requiring continuous water immersion. Do not use as a traffic bearing sealant or in log homes. For joints deeper than ¾" (9.5 mm), a backing material should be used.



Roof Boots





Round Roof Boot - MasterFlash

Manufactured from EPDM or silicone rubber, the Round MasterFlash Roof Boot is compounded for maximum resistance to ozone, UV light, & temperature extremes.

FEATURES

- Flexible aluminum base will allow the flashing to conform to any metal roof configuration. Pipe location can be centered in the flat of the panel or the rib.
- Urethane sealant & self-drilling screws complete the installation.
- MasterFlash Roof Boots are well marked so they can easily be cut with shears to fit exactly the pipe size used.
- MasterFlash Roof Boots are available in multiple colors of EPDM as well as Red or Gray high-temperature Silicone.

Part#	Description	Pipe Size	Base Size	Case Qty
MF1	#1 Gray MasterFlash Round Roof Boot - EPDM	1/4" -2-1/2"	4.75" (120.7mm)	15
MF2	#2 Gray MasterFlash Round Roof Boot - EPDM	1-3/4"-3"	6.21" (157.7mm)	15
MF3	#3 Gray MasterFlash Round Roof Boot - EPDM	1/4"-5"	7.74" (196.6mm)	15
MF3cc	#3 Color MasterFlash Round Roof Boot - EPDM	1/4"-5"	7.74" (196.6mm)	15
MF4	#4 Gray MasterFlash Round Roof Boot - EPDM	3"-6-1/4"	9.26" (235.2mm)	10
MF5	#5 Gray MasterFlash Round Roof Boot - EPDM	4-1/4"-7-3/4"	10.75" (273.0mm)	10
MF6	#6 Gray MasterFlash Round Roof Boot - EPDM	5" - 9"	12.50" (317.5mm)	10
MF7	#7 Gray MasterFlash Round Roof Boot - EPDM	6" - 11"	14.60" (370.8mm)	10
MF8	#8 Gray MasterFlash Round Roof Boot - EPDM	7" - 13"	16.5" (419.1mm)	5
MF9	#9 Gray MasterFlash Round Roof Boot - EPDM	9" - 19"	25.25" (641.1mm)	5
MF10	#10 Gray MasterFlash Round Roof Boot - EPDM	13" - 26"	34" (863.6mm)	5

EASY INSTALLATION



1. Choose pipe opening and trim 2. Slide over pipe 3. Form to roof profile 4. Apply sealant 5. Fasten to complete

	EPDM 500	SILICONE
Advanced Ozone Resistance Tested to...	70 hr @500 pphm	70 hr @ 500 pphm
High Temperature Resistance Tested to Intermittent Continuous	+135°C (+275°F) +100°C (+212°F)	+260°C (+500°F) +225°C (+500°F)
Low Temperature Resistance tested to...	-55°C (-65°F)	-74°C (-100°F)
Tensile Set Maximum... Compression Set Maximum...	10MPa (1450psi) 25%	5MPa (700psi) 50%

#3 Stocked EPDM Color Options



★ = stocked Colors in #3 only. Other colors and sizes available for Special Order



Stocked in Black EPDM



Stocked in High-Temperature Red Silicone

Square Roof Boot - MasterFlash

Manufactured from EPDM or silicone rubber, the Square MasterFlash Roof Boot is compounded for maximum resistance to ozone, UV light, & temperature extremes.

FEATURES

- Flexible aluminum base will allow the flashing to conform to any metal roof configuration. Pipe location can be centered in the flat of the panel or the rib.
- MasterFlash Roof Boots are well marked so they can easily be cut with shears to fit exactly the pipe size used.
- MasterFlash Roof Boots are available in multiple colors EPDM as well as Red high-temperature Silicone.
- Urethane sealant & self-drilling screws complete the installation
- The advantage of the square base is that it can be angled so the corner is pointing up the roof to act as a water diverter.

EASY INSTALLATION



1. Choose pipe opening and trim



2. Slide over pipe



3. Form to roof profile



4. Apply sealant



5. Fasten to complete

Part#	Description	Pipe Size	Base Size	Case Qty
MF2SB	#2 Black MasterFlash Square Roof Boot - EPDM	7/8"-4"	6" (152mm)	15
MF3SB	#3 Black MasterFlash Square Roof Boot - EPDM	1/4"-5-3/4"	8" (203mm)	15
MF4SB	#4 Black MasterFlash Square Roof Boot - EPDM	2-3/4"-7"	10" (254mm)	10
MF5SB	#5 Black MasterFlash Square Roof Boot - EPDM	4"-8-1/4"	11" (279mm)	10
MF6SB	#6 Black MasterFlash Square Roof Boot - EPDM	4-3/4"-10"	12" (304mm)	10
MF7SB	#7 Black MasterFlash Square Roof Boot - EPDM	5-1/2"-11-1/2"	14" (355mm)	10
MF8SB	#8 Black MasterFlash Square Roof Boot - EPDM	6-3/4"-13-1/2"	17" (431mm)	5
MF9SB	#9 Black MasterFlash Square Roof Boot - EPDM	9-1/2"-20-1/2"	25" (635mm)	5
MFHT3	#3 High-Temperature Red Master Flash Square Roof Boot - Silicone	1/4"-5-3/4"	8" (203mm)	15
MFHT4	#4 High-Temperature Red Master Flash Square Roof Boot - Silicone	2-3/4"-7"	10" (254mm)	10
MFHT5	#5 High-Temperature Red Master Flash Square Roof Boot - Silicone	4"-8-1/4"	11" (279mm)	10
MFHT6	#6 High-Temperature Red Master Flash Square Roof Boot - Silicone	4-3/4"-10"	12" (304mm)	10
MFHT7	#7 High-Temperature Red Master Flash Square Roof Boot - Silicone	5-1/2"-11-1/2"	14" (355mm)	10
MFHT8	#8 High-Temperature Red Master Flash Square Roof Boot - Silicone	6-3/4"-13-1/2"	17" (431mm)	5
MFHT9	#9 High-Temperature Red Master Flash Square Roof Boot - Silicone	9-1/2"-20-1/2"	25" (635mm)	5
MFHT10-MAXI	#10 Maxi-High-Temperature Red Master Flash Square Roof Boot - Silicone	12"-28-1/2"	34" (863mm)	5
MF*Sc	Special Order Colors Available in All Sizes			

Special Order EPDM Color Options

TERRA COTTA LIGHT BLUE BRIGHT RED LIGHT GREEN DARK GREEN WHITE BROWN DARK BLUE



	EPDM 500	SILICONE
Advanced Ozone Resistance Tested to...	70 hr @500 pphm	70 hr @ 500 pphm
High Temperature Resistance Tested to Intermittent Continuous	+135°C (+275°F) +100°C (+212°F)	+260°C (+500°F) +225°C (+500°F)
Low Temperature Resistance tested to...	-55°C (-65°F)	-74°C (-100°F)
Tensile Set Maximum... Compression Set Maximum...	10MPa (1450psi) 25%	5MPa (700psi) 50%





Retrofit Round Roof Boot - MasterFlash - Special Order

Manufactured from EPDM or silicone rubber, the Retrofit Round MasterFlash Roof Boot is compounded for maximum resistance to ozone, UV light, & temperature extremes.

FEATURES

- Flexible aluminum base will allow the flashing to conform easily be cut with shears to fit exactly the pipe size used.
- Stainless steel teeth grip the material & secure it tightly.
- Urethane sealant & self-drilling screws complete the installation
- Retrofit Round Roof Boots are well marked so they can



1. Using tin snips, cut the cone to fit pipe.

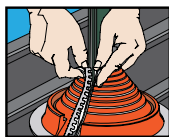

2. Wrap Retrofit around pipe, join the interlocking teeth



3. Squeeze joiner tightly with pliers to crimp

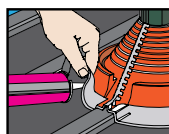

4. Apply sealant shape Retrofit to roof



5. Fasten Retrofit to roof

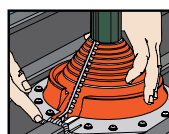

6. Apply additional sealant to mechanical locking joiner seam

Part#	Description	Pipe Size	Base Size	Case Qty
MFRJ1	#1 MasterFlash Retrofit Round Roof Boot	3/4" - 2-3/4" (19 - 70 mm)	6-3/10" (160mm)	5
MFRJ2	#2 MasterFlash Retrofit Round Roof Boot	2" - 7-1/4" (50.8 - 184 mm)	10-3/4" (273.1mm)	5
MFRJ3	#3 MasterFlash Retrofit Round Roof Boot	3-1/4" - 10" (95 - 254 mm)	14-1/2" (641.4mm)	5

	EPDM 500	SILICONE
Advanced Ozone Resistance Tested to...	70 hr @500 pphm	70 hr @ 500 pphm
High Temperature Resistance Tested to		
Intermittent	+135°C (+275°F)	+260°C (+500°F)
Continuous	+100°C (+212°F)	+225°C (+430°F)
Low Temperature Resistance tested to...		
	-55°C (-65°F)	-74°C (-100°F)
Tensile Set Maximum...	10MPa (1450psi)	5MPa (700psi)
Compression Set Maximum...	25%	50%



Covent Exhaust Fan

The CoVent® Exhaust Fan Vent is an all in one exhaust fan vent designed for metal roofs. CoVent is ideal for interior exhaust fans equipped with a 3" or 4" flex hose. This exhaust vent is intended for bathroom and attic venting. CoVent is not designed for dryer vents. Packed and ready for installation.

FEATURES

- Targeted Ventilation
- All-in-One Solution
- Simplified Installation
- Superior Seal

Part#	Description	Pipe Size	Case Qty
A.	MFCV40 Exhaust Fan Vent - Gray	4"	NA
B.	MFCV40B Exhaust Fan Vent - Black	4"	NA

Simple Installation



Retrofit Square Roof Boot - MasterFlash

Manufactured from EPDM or silicone rubber, the Retrofit Square MasterFlash Roof Boot is compounded for maximum resistance to ozone, UV light, & temperature extremes.

FEATURES

- Flexible aluminum base will allow the flashing to conform to any metal roof configuration. Pipe location can be centered in the flat of the panel or the rib. Urethane sealant & self-drilling screws complete the installation.
- Retrofit Square Roof Boots are well marked so they can easily be cut with shears to fit exactly the pipe size used.
- Retrofit Square Roof Boots are used in applications for which a standard flashing will not work. It wraps around the pipe instead of pulling down over the pipe. Hardware is included to ensure a watertight connection.
- Fastener snaps & cable tie are included.
- Available in EPDM and Silicone.

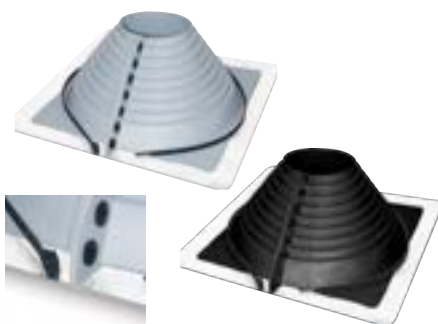

1. Trim to Fit



2. Wrap and Snap



3. Press and Mold

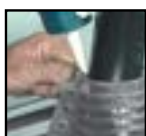

4. Add Urethane Sealant.



5. Fasten



6. Install Cable Tie

**Special Order
Red Silicone
Retrofit
Roofjack**



Extreme Angle Roof Boot - MasterFlash

The built-in 40° degree pitch allows to handle any extreme roof pitch (35° - 65°), sleeve flexibility accommodates vibration and pipe movement caused by expansion/contraction. Easy on-site customization accommodates all normal installations.

FEATURES

- Weather Resistance Designed to withstand the damaging effects of ultra violet light and ozone.
- Modification made simple easy to see pipe diameters make for painless on-site customization.
- Adaptable Base. The base is designed to mold to most panel configurations and roof pitches regardless of pipe location.
- Stocked in Black EPDM. Also available in Red Silicone.

Part#	Description	Pipe Size	Base Size	Case Qty
MFEA	MasterFlash Extreme Angle Roof Boot Black - EPDM	1/4" - 5-3/4" (6 - 146mm)	11" (279mm)	5

Black EPDM

High-Temp Red Silicon

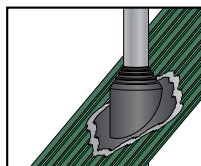

Special Order

	EPDM 500	SILICONE
Advanced Ozone Resistance Tested to...	70 hr @500 pphm	70 hr @ 500 pphm
High Temperature Resistance Tested to	+135°C (+275°F) +100°C (+212°F)	+260°C (+500°F) +225°C (+450°F)
Low Temperature Resistance tested to...	-55°C (-65°F)	-74°C (-100°F)
Tensile Set Maximum... Compression Set Maximum...	10MPa (1450psi) 25%	5MPa (700psi) 50%





Oatey Roof Flashing

Part#	Description	Pipe Size
Y11898	Oatey Roof Flashing 1-1/4" x 1-1/2" Black	1.25" - 1.5"
Y11899	Oatey Roof Flashing 2" Black	2"
Y11919	Oatey Roof Flashing 1", 2", and 3" Black	1", 2", & 3"
Y11931	Oatey Roof Flashing 3" - 4"	3" - 4"



Nevercaulk Residential Roof Flashing

Part#	Description	Pipe Size
MFRS13	Nevercaulk Residential Roof Flashing with Aluminium Base	1.25" - 3"
MFRS34	Nevercaulk Residential Roof Flashing with Aluminium Base	3" - 4"



Lifetime Ultimate Pipe Flashing

Part#	Description	Pipe Size
UPF15B	Lifetime Ultimate Pipe Flashing - Kynar Bronze Base	1.5"
UPF2B	Lifetime Ultimate Pipe Flashing - Kynar Bronze Base	2"
UPF3B	Lifetime Ultimate Pipe Flashing - Kynar Bronze Base	3"

Ventilation & Closures

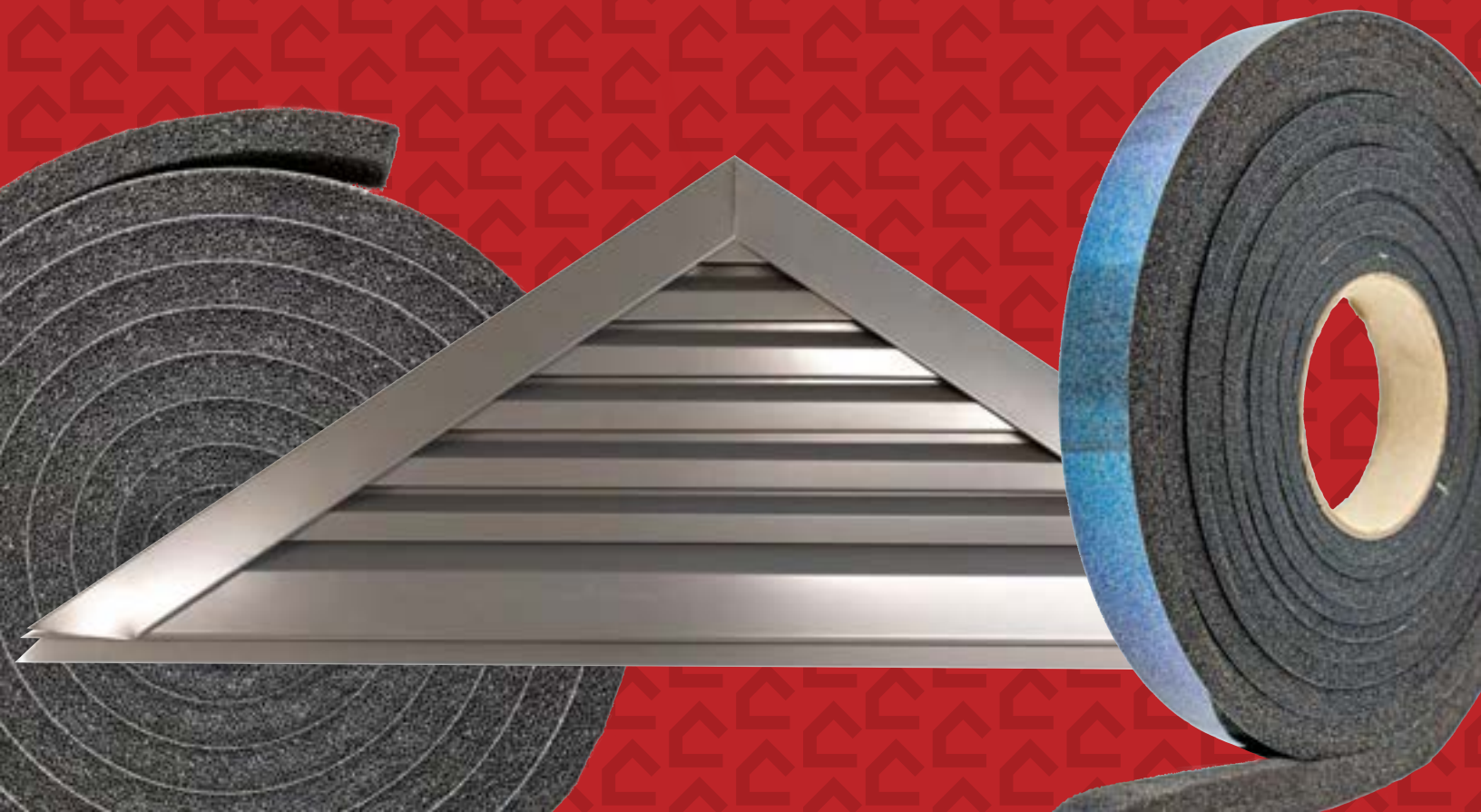



SHIPPING NATION-WIDE



RIDGECAP DETAIL



MATERIAL DETAIL



FITS ANY PROFILE

Ultra Vent

The ultimate in vent closures is now tested in up to 90 mph wind-driven rain with NO measurable leakage!

Meet the Ultra-Vent: the universal ventilation system that conforms to any roof panel. It compresses and fills every void between your ridge cap and the roof panel. Factory applied glue strips allow the installer to roll out Ultra-Vent and apply it to the roof panel, even in windy conditions. Can be used between panels with a gable overlap or with a ridge cap system.

FEATURES

- Pure Polyurethane Foam
- Vinyl Coating
- UV Stabilized/Fire Retardant
- Continuous Double Glue Strip
- Use on any roof pitch from $2/12$ to $20/12$
- Independent Testing
- Air Permeability: 840 Cu. FT. / MIN
- Now you can stock one product to match any roof panel configuration

Part#	Description	Skid Qty	Height	Width	Length
UV	Ultra Vent Under Ridge Cap Ventilation	135	1"	1.5"	20'
UV ¹⁵	Ultra Vent Under Ridge Cap Ventilation	56	1.5"	2	25'

Allow a minimum of a 1-1/2" wide opening at the peak of the roof.

For proper air flow, the downhill edge of the Ultra-Vent™ should be no more than 1/2" above the lower edge of the ridge cap

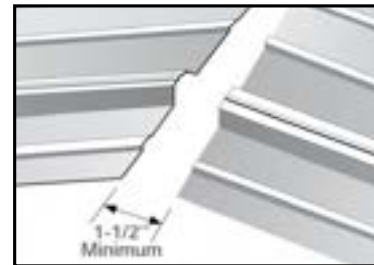
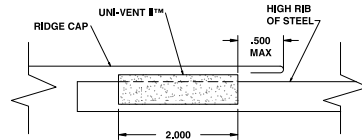

Roll out Ultra-Vent™ over the high ribs with a slight droop in the middle.



Ultra-Vent™ should stick initially at high ribs and at low point in between



After the Ultra-Vent™ is rolled out over the high ribs, the installer must press down between the high ribs for full adhesion.



Ultra-Vent™ will compress at the major and minor ribs to fill all gaps. The installer can utilize the same fasteners that would be used for a normal ridge cap installation.

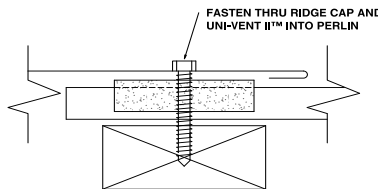

Independent Testing

PROPERTY	TEST	RESULTS
90 mph Wind Driven	CRL 6875	No Leakage
Rain Net Free Area	1" nom. Thickness	8.5 sq. in. per lin. Ft. per side (17 sq. in. per lin. Ft. ridge)
Air Permeability	ASTM D737	840 cu. ft. / min.
Cold Crack	F87260 Sec. 4-C14	Resistance to -55° C
Snow Infiltration	CRL 5704	-0-
Tear Strength	ASTM D3574	3.5 p.p.i.
Tensile Strength	ASTM D3574	16 p.s.i. - Elong 175%
Attic Dust	ASTM D1739-98	No Clogging
Dust Exposure	ICBO AC132	No Clogging
Compressive Strength	ASTM D3574	1.8 p.s.i. @ 75%
UV Stable	Chamber Test	No change to color or materials
Abrasion	ASTM D1175	No damage



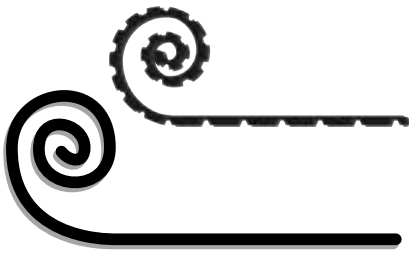

SHIPPING NATION-WIDE



MATERIAL DETAIL

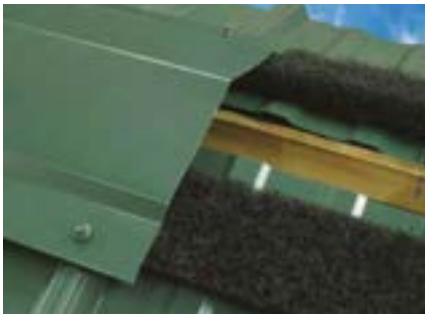

Perform Vent

FEATURES

- One person roll-out installation
- Won't crack, dent or rust during shipping or installation
- Won't scratch panel finish
- Won't clog from airborne dust
- Prevents insect infiltration
- Prevents snow infiltration
- Provides proven roof ventilation
- Invisible from the curb
- Will not support a flame
- Made in USA
- Made from over 90% recycled fiber; over 30% post-consumer content
- Sold by the piece and also

Part#	Description	Pck. Qty.	Height	Width	Length
CVP2	Perform Vent II with Continues Glue Strip	4	1"	2"	50'
CVP	Perform Vent Notched for ABM Panel with Glue Dot	2	1"	2"	50'

Perform Vent Installation Instructions

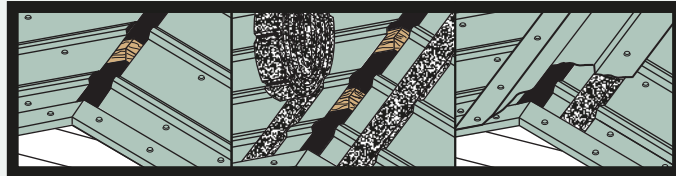

1. Allow a 2" opening at ridge for ventilation. Perform Vent is rolled out along the ridge, gable to gable. Install Perform Vent about 1/2" to 1" up-slope from the edge of the ridge cap.
2. Perform Vent can be cut with scissors or utility knife. When splicing Perform Vent, make the splice at the center top of the high rib and use caulk or sealant along the splice.
3. Screw through ridge cap into top of each panel rib.

Python Vent

FEATURES

- Easy to handle & install - It's light, flexible and there's no difficulty fitting or wrapping.
- No fabric wrap, no external baffle - Nothing to cause clogging, deterioration, or dirt and snow trapping. Yet, Python helps keep out insects, dust, and moisture.
- Made from more than 90% recycled plastic - material (more than 30% post consumer content). And since Python can help draw cool air into the attic and hot air out in summer, it can help reduce utility costs.
- Strong and durable - Python is non-woven, non-wicking and resists damage from ice, hail, and other weather, which means fewer warping and loosening problems.
- Economical - Python's flexibility means there's no shipping or installation crack or dent damage. There's no waste with Python— you can use every piece. And its durability means it lasts for a long time.



Part#	Description	Pck. Qty.	Height	Width	Length
CV	Perform Vent for Hip/Ridge	2	1"	3"	50'





Em-Seal Closure - AST Hi-Acrylic

Em-Seal is a self-adhering tape seal made from resilient, open-cell polyurethane foam impregnated with a water-based acrylic-modified asphalt emulsion and then compressed to a sealing density level appropriate to the application. Typically, higher compression levels are required for watertightness in water run-off applications; lower compression can be used, for example, for snow seals at roof ridges.

Em-Seal replaces and outperforms liquid and butyl-tape sealants as well as closed-cell and unimpregnated open-cell foam closures.

Em-Seal sealant tape is used to seal out dust, air, wind-driven snow, and moisture through joint details in metal buildings and roofs. Em-Seal is ideal as a filler in expansion/compression joints subject to movement from thermal expansion and contraction, and as a gasket in mechanically fastened, non-moving applications such as lap seams. Em-Seal is suitable for use against metal, plastic, wood, concrete, and other materials common in metal building structures.

Valleys

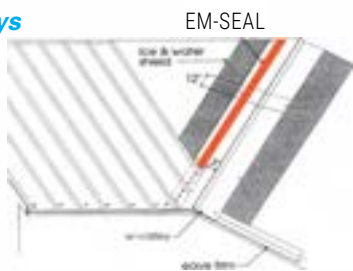

Hips

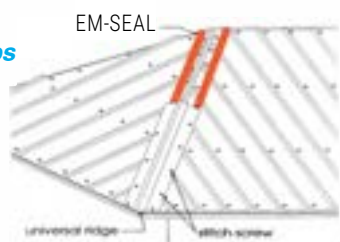

Ridges



MATERIAL DETAIL

FEATURES

- Watertight at 80% Compressed
- Stops Flowing Water at 75% Compressed
- Blocks Air and Acoustic at 68%
- Restricts Hot, Cold, Dust at 18%
- Will not dry out and become brittle
- UV-stable
- Highly resistant to bugs and vermin
- Will not extrude from between joints like caulk or butyl tapes
- Conforms to contours and fills gaps
- Maintains a seal during thermal expansion and contraction of building panels
- Excellent compressibility and recovery (minimal compression set)
- Good thermal and sound insulator
- No shrinkage or blow-out due to closed-cell breakage
- Supplied with self-adhesive on one side. After removal of packaging, material begins gradual expansion - more slowly in cold weather than in hot.
- Sold by the piece.

Part#	Description	Pck. Qty.	Height	Width	Length
EMS	Em-Seal Expandable Closure	26	1"	1"	19.68'
EMS1.5	Em-Seal Expandable Closure for PBR	16	1.5"	1.5"	13.12'

Property	Value	Test Method
Base Material	Open cell, high density, polyurethane foam	N/A
Impregnation	Acrylic-modified asphalt	N/A
Color	Black	N/A
Tensile strength	21 psi min (145 kPa)	ASTM D3574
Elongation - ultimate	150% min	ASTM D3574
Temperature range	High - permanent High - short term Low	
	185°F (85°C) 203°F (95°C) -40°F (-40°C)	
Softening point	140°F min (60°C)	ASTM D816
UV resistance	Excellent	
Mildew resistance	Excellent	
Resistance to aging	Excellent	
Bleeding	None (when compressed down to 20% of uncompressed thickness)	
	-40°F to 180°F (-40°C to 85°C)	
Compression set	3% max	ASTM D3574
	70°C 50% RH after 72hrs	
Thermal conductivity	0.34 Btu. in/hr. ft ² .°F (0.05 W/m.°C)	ASTM C518
Low temp. flexibility	No cracking or splitting	ASTM C711
	32°F to -10°F (0°C to -23°C)	
Water vapor transmission at 25% compression	0.011 perms	ASTM C355-64



Foam Closure Strips

Designed to close gaps in roof & sidewall applications. Material is pre-cut to conform to metal panel configurations.

FEATURES

- Applications include closing the openings at the ridge (peak of the building) or at the eave (gutter-line of a building).
- 1.8 lb. Density polyethylene foam is designed to withstand harsh weather elements including moisture & ultraviolet rays.
- Optional pre-applied adhesive helps to keep closure in place before roof panel is fastened.
- Interlocking dovetails provide a secure end-to-end fit, eliminating any potential gaps
- Other profiles are available.

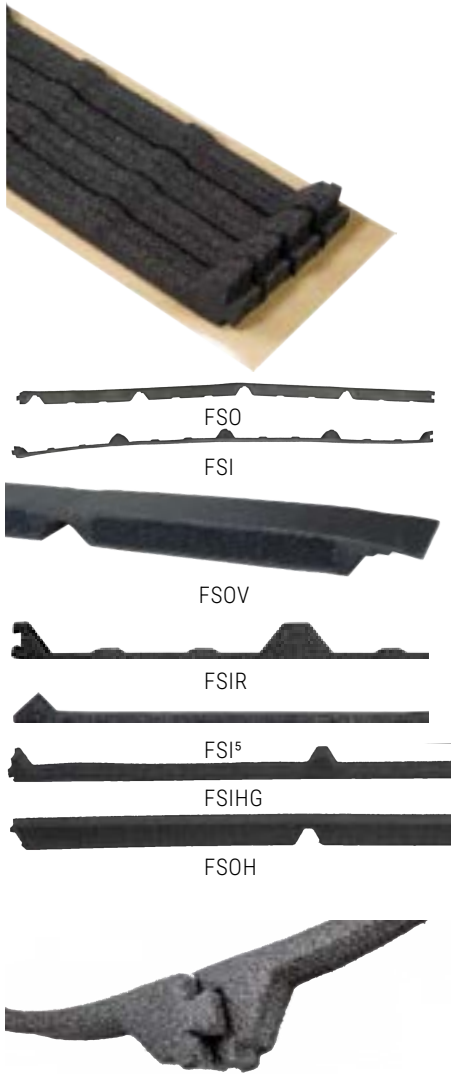

Interlocking dovetails provide a secure end-to-end fit, eliminating any potential gaps

EASY 4 STEP INSTALLATION

STEP 1	PEEL PAPER FROM ADHESIVE 
STEP 2	FIT TO METAL PANEL 
STEP 3	FIRMLY APPLY 
STEP 4	LINK NEW CLOSURE 

Part#	Description	Pck. Qty.	Rib Spacing	Size
FSI	ABM Panel Inside Filler Strip - No Adhesive	100	9"	7/8" x 3/4" x 36"
FSIG	ABM Panel Inside Filler Strip - With Adhesive	100	9"	7/8" x 3/4" x 36"
FSO	ABM Panel Outside Filler Strip - With Adhesive	100	9"	7/8" x 3/4" x 36"
FSOV	ABM Panel Vented Outside Filler Strip - With Adhesive	50	9"	1-3/4" x 3/4" x 36"
FSIR	PBR Panel Inside Filler Strip - No Adhesive	100	12"	7/8" x 1-1/4" x 36"
FSOR	PBR Panel Outside Filler Strip - With Adhesive	100	12"	7/8" x 1-1/4" x 36"
FSI5	5-V Crimp Panel Inside Filler Strip - No Adhesive	100	12"	7/8" x 1/2" x 24"
FSO5V	5-V Crimp Panel Outside Filler Strip - With Adhesive	100	12"	7/8" x 1/2" x 24"
FSO14	1-1/4" Cont. Corrugated Panel Filler Strip - No Adhesive	100	1-1/4"	7/8" x 7/8" x 36"
FSO25	2-1/2" Cont. Corrugated Panel Filler Strip - No Adhesive	100	2-1/2"	7/8" x 7/8" x 36"
FSIHG	Heritage Panel Inside Closure Strip - With Adhesive	100	12"	7/8" x 3/4" x 36"
FSOH	Heritage Panel Outside Closure Strip - With Adhesive	100	12"	7/8" x 3/4" x 36"

PHYSICAL PROPERTIES	TEST METHODS	REQUIREMENT
Density (lb./cf)	ASTM D 3574	1.8 - 2.0
110 mph Wind Driven Rain Test	AS 100(A)	NA
Air Permeability (ft3/m./ft2 of Surface)	ASTM D737	NA
Tear Resistance (lb./in. min.)	ASTM D 3574	6 machine direction
	ASTM D 3574	11 cross direction
Tensile Strength (lbs/in2 min.)	ASTM D 3574	60 machine direction
	ASTM D 3574	38 cross direction
Compress Force Deflection (lbs/in2 @ 25%)	ASTM D 3574	5
Compress Force Deflection (lbs/in2 @ 50%)	ASTM D 3574	15
Compression Set (% Original Thickness)	ASTM D 3574	24 - 28
Elongation (% min.)		124 machine direction
		88 Cross Direction
Shore Hardness (00 Scale)	ASTM 2240	51
Thermal Stability (% Max)	Machine Direction	-2.0
	Cross Direction	-1.0
(24 hour @ 158oF)		
Thermal Conductivity (K Factor)	ASTM C177	0.25
BTU in./F Hr oF		
Water Absorption (Lbs/SqFt Cut Surface)	ASTM D-1667	0.04
Working Temperature Range (Fo)		-40 to 160
Flammability	AVSS 302	Pass





AB35 Ridge Vent - Special Order

Proper ventilation in your ceiling or attic has been known to extend the life of your building and decrease heating and cooling costs. The AB35 Ridge Vent does double-duty as a ridge cap and ventilation system combined.

The heavy-duty system is also completely water proof with the clear poly rain diverter that also doubles as a small skylight. A steel rain diverter is available upon request. Available in all of our color options.

FEATURES

- **Sub-straight:** 29 Ga. Galvanized Steel
- **Length:** 10'
- **Width:** 13.5"
- **Ventilation:** 36 square inches of airflow per linear foot.

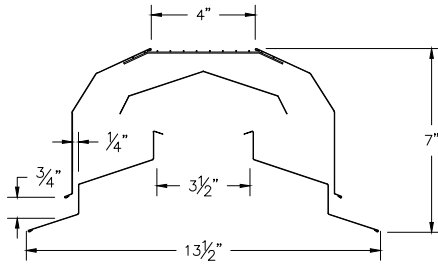

Part#	Description	Height	Width	Length
RV35FCC	AB35 Ridge Vent with Clear Skylight Diverter	7"	13.5"	10'
RV35cc	AB35 Ridge Vent with Metal Diverter	7"	13.5"	10'

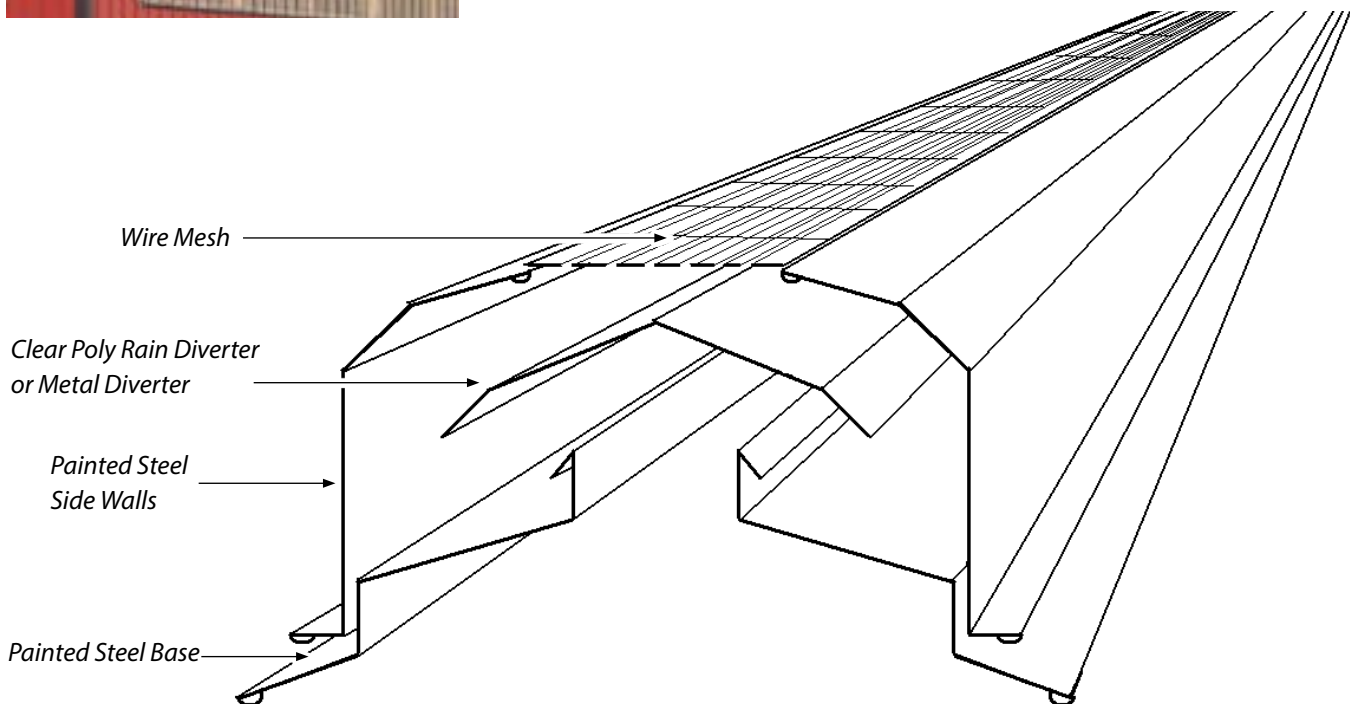

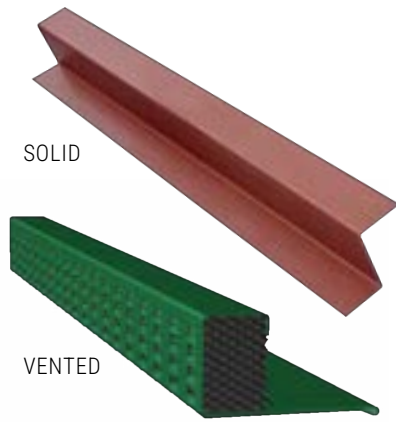

Z-Closure

Use Z Closures to fill the void between standing seam panel ribs before fastening hip and ridge caps. Available in precut lengths for common panel widths and in color-matched colors. Stocked in solid steel and perforated steel with the Python Vent pre-installed for filtered ventilation.

FEATURES

- Made with 26 Gauge Galvalume Steel
- Available in precut lengths
- Color-matched to roof panels
- Available in solid or vented

Part#	Description	Height	Length
ABSZcc	Solid Z-Closure	1-1/2"	19-1/8"
ABSZccLF	Solid Z-Closure	1-1/2"	LF
ABSZcc10	Solid Z-Closure	1-1/2"	10'
ABSZTcc	Solid Z-Closure - Textured Colors	1-1/2"	16-1/8"
ABSZVTccLF	Solid Z-Closure - Textured Colors Made to Length up to ^{36"}	1-1/2"	LF
ABSZAM	Solid Z-Closure - Aged Metal	1-1/2"	16-1/8"
ABSZCCLF1	Solid Z-Closure for 1" High Standing Seam Ribs	1"	LF
ABSZVcc	Vented Z-Closure	1-1/2"	19-1/8"
ABSZVccLF	Vented Z-Closure - Made to Length up to ^{36"}	1-1/2"	LF
ABSZVTcc	Vented Z-Closure - Textured Colors	1-1/2"	16-1/8"
ABSZVAM	Vented Z-Closure - Aged Metal	1-1/2"	16-1/8"
ABSZVCCLF1	Vented Z-Closure for 1" High Standing Seam Ribs	1"	LF



Snap-Z

Save time with the pre-applied butyl tape and pre-punched design of the Snap-Z vented z-closure. Get an extra advantage when you use an open-hemmed ridge cap to snap over the wide flange of the Snap-Z and cut down on the amount of pop rivets needed. The wide flange holds the ridge cap in place with half as many pop rivets for less potential oil canning.



FEATURES

- Requires only 3 pairs of pop rivets per 10 feet of ridge cap when used with an open-hemmed ridge cap
- Made with 26 Gauge Steel
- Precut for simpler installation
- Stocked in black
- Pre-punched for easy fastening
- Pre-applied butyl tape



BEFORE

AFTER

Part#	Description	Height	Length
ABSSZBL19	Snap-Z Vented Z-Closure - Black	1-1/2"	19-1/8"
ABSSZS019	Snap-Z Vented Z-Closure - Special Order Colors	1-1/2"	19-1/8"
ABSSZBL16	Snap-Z Vented Z-Closure - Black	1-1/2"	16-1/8"
ABSSZS016	Snap-Z Vented Z-Closure - Special Order Colors	1-1/2"	16-1/8"





Steel Louvers

Louvers serve the double purpose of enabling airflow while keeping out pests, and accenting the appearance of the structure. Wood louvers have been a popular choice for centuries, but require constant maintenance to keep from rotting. Now you can enjoy the function of wood louvers, but without the maintenance when you get the ABM Painted-Steel Louvers. Each louver is handmade by an in-house craftsman and is customized to the size you specify and available in all our painted steel colors. Because it is custom made, you can get it to fit an existing opening.

FEATURES

- Custom made to size in various styles
- Made with integral J-channel for new construction
- Made without integral J-channel for retrofitting
- 2" between louvers with 1" face
- 2-1/2" boarder
- 1" depth
- Size is measured from edge of visible face (including integral J)

Part# Description

SL*	Custom Made Steel Louver
SLT	Triangular- Custom Made Louvers

Common Designs

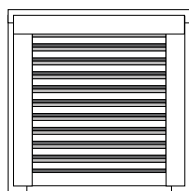

Rectangle

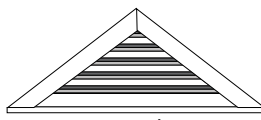

Triangle

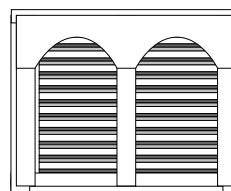

Inverse Double Arch

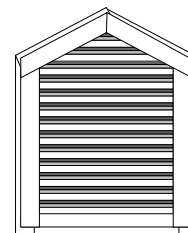

Peaked Rectangle

Custom Options

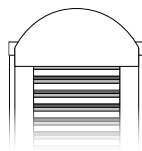

Dome



Peak

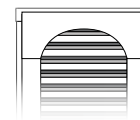

Inverse Arch

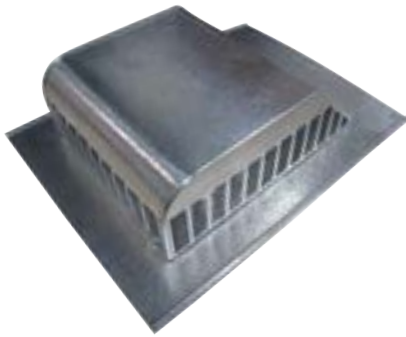

Aluminum Slant Back Roof Louver

Part#	Description	NFA	Vent Size
YSSB960AWW	Slant Back Aluminum Roof Louver - Weathered Wood	60 sq. in.	11" x 14" x 5"
YSSB960A	Slant Back Aluminum Roof Louver - Mill Finish	60 sq. in.	11" x 14" x 5"
YSSB960ABL	Slant Back Aluminum Roof Louver - Black	60 sq. in.	11" x 14" x 5"
YSSB960ABR	Slant Back Aluminum Roof Louver - Brown	60 sq. in.	11" x 14" x 5"



Painted Steel Soffit

In order for the hot air to escape out of the ridge vent, fresh air needs to enter the building from somewhere, and our vented steel soffit allows the correct amount of fresh air to equalize the air pressure caused by the escaping heat. Our 29 gauge solid and vented steel soffit is available in over 45 of our metal colors. It's stocked in standard lengths, and available in custom lengths from 1.5' to 24'.

FEATURES

- Color-matched to our metal panel colors.
- Heavy-duty 29 gauge steel.
- Vented stocked in 12" wide coverage by 11.5" for 12" overhang.
- Solid made to order from 1.5 feet to 24 feet.



Part#	Description	Size
SOSVCC12	Vented Steel Soffit 12" Wide x 12" Overhang Triple Four	12" x 11.5"
SOSVCCLF	Vented Steel Soffit 12" Wide Custom Length Triple Four	12" x
SOSSCC12	Solid Steel Soffit 12" Wide x 12" Overhang Triple Four	12" x 11.5"
SOSSCC18	Solid Steel Soffit 12" Wide x 18" Overhang Triple Four	12" x 17.5"
SOSSCCLF	Solid Steel Soffit 12" Wide Custom Length Triple Four	12" x



Interior Ceiling & Wall Panels





Tri-Ply Ceiling

One of the most cost-effective ceilings on the market

Great for use as a ceiling or sidewalls of your agricultural building. This washable, durable, flexible, woven poly material has a coating of poly on both sides of the woven material with one side white and one side black. Insulation can be blown on top of the Tri-ply with ease.

Part#	Description	Size
TPFC	Tri-Ply Fabrene Cloth - One Side Black One Side White	52' x 700'

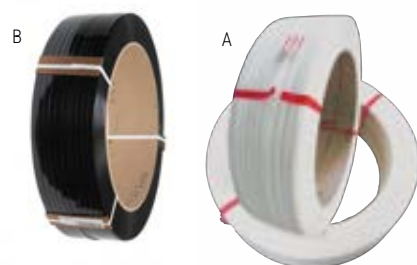

Tri-Ply Strapping

Part#	Description	Size	Length
A	TPSP Tri-Ply White Poly Strapping - 12" on center spacing	1/2" wide	7200'
B	TPSPB Tri-Ply Black Poly Strapping - 12" on center spacing - S.O.	1/2" wide	7200'

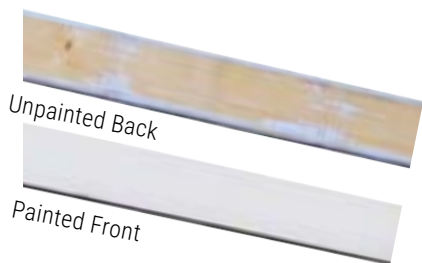

Tri-Ply Lath

Part#	Description	Size	Length
TPLPW	Tri-Ply Lath - White Painted 1 Side	1/2" x 1-1/2"	12'



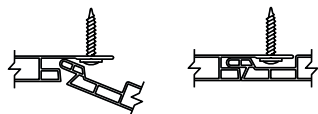
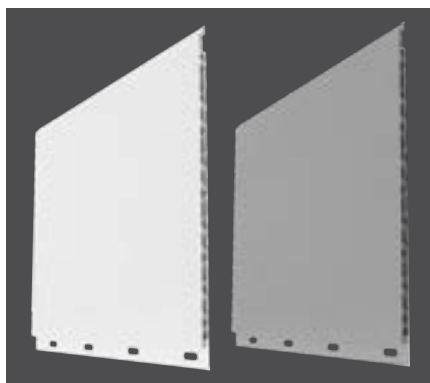

trusscore

Wall&CeilingBoard

Wherever you need a smooth finish that is easy to clean, low-maintenance, and abuse-resistant, TRUSSCORE PVC Wall&CeilingBoard has your project covered. The panels are 16" wide, 1/2" thick, and come in standard lengths of: 8', 10', 12', 14', 16', and 20' (custom lengths are also available). Trusscore's unique tongue-and-groove interlocking system makes both vertical and horizontal installation quick and easy.

Stocked in White (W) and Grey (G).

FEATURES

- Trusscore Wall&CeilingBoard is an ideal drywall replacement that is easy to use, easy to clean, and doesn't yellow or fade
- Unique high strength truss design provides outstanding spanning capability. It can support attic insulation loads.
- Highly durable surface that is resistant to scratches, bacteria, chemicals, mold, and moisture.
- Class A Fire Rating - flame spread index of 15, as per ASTM E84-18.

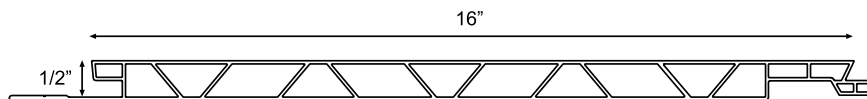

Trusscore Wall&CeilingBoard

Part#	Description	Coverage	Length
TCCC8	TrussCore Wall&CeilingBoard PVC Liner Panel - 1/2" Thick	16"	8'
TCcc10	TrussCore Wall&CeilingBoard PVC Liner Panel - 1/2" Thick	16"	10'
TCcc12	TrussCore Wall&CeilingBoard PVC Liner Panel - 1/2" Thick	16"	12'
TCcc14	TrussCore Wall&CeilingBoard PVC Liner Panel - 1/2" Thick	16"	14'
TCcc16	TrussCore Wall&CeilingBoard PVC Liner Panel - 1/2" Thick	16"	16'
TCcc20	TrussCore Wall&CeilingBoard PVC Liner Panel - 1/2" Thick	16"	20'



STOCKED IN WHITE AND GREY

Trusscore Trims

Part#	Description	Length
TCcclCTRIM	Trusscore PVC Inside Corner Trim - 1/2" Cove	10'
TCccbTRIM	Trusscore PVC Base Trim - 1-1/4" x 7/8" x 1/4" Face	10'
TCcclOCTRIM	Trusscore PVC Inside/Outside Corner - Rounded	10'
TCccJTRIM	Trusscore PVC J Channel - 1/2" Cove with 3/4" Face	10'
TCccOCSTRIM	Trusscore PVC Small Outside Corner - 1-1/2" x 1-1/2"	10'
TCccOCLTRIM	Trusscore PVC Large Outside Corner - 2" x 2"	10'
TCccHTRIM	Trusscore PVC H Divider - 1/2" Coves with 1-1/2" Face	10'
TCccHTRIM ⁴⁵	Trusscore PVC 45 Degree H Divider with 1-1/2" or 2-22/32" Face	10'
TCccFTRIM	Trusscore PVC F Trim - 1/2" Cove	10'

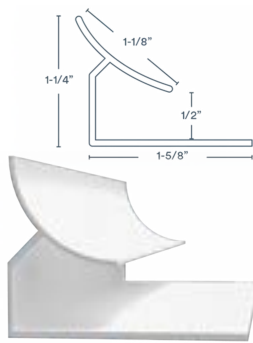

Inside Corner

TCcclCTRIM

1/2" Cove

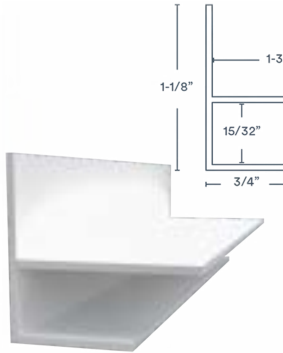

F Trim

TCccFTRIM

1/2" Cove

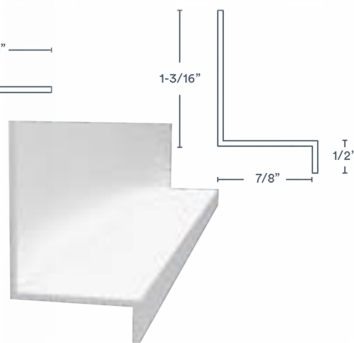

Base Trim

TCccbTRIM

1-1/4" x 7/8" x 1/4" Face

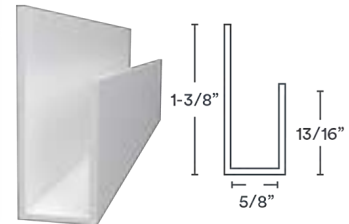

J Channel

TCccJTRIM

1/2" Cove with 3/4" Face

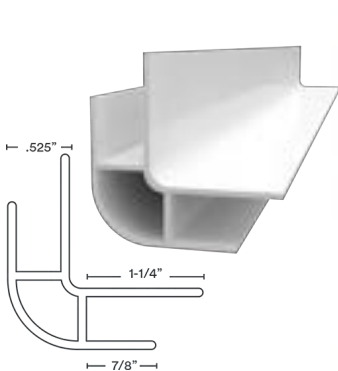

Inside/Outside Corner - Rounded

TCcclOCTRIM

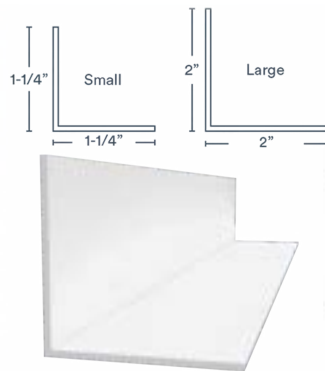

Outside Corner

TCccOC*TRIM

1-1/4" x 1-1/4" | 2" x 2"



H Divider

TCWH2PTRIM

1/2" Coves with 1-1/2" Face

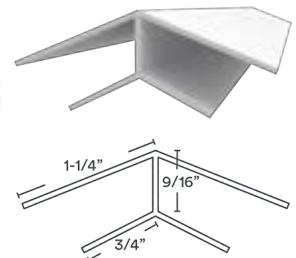

45 H Divider

TCccHTRIM45

1/2" Coves with 1-1/2" or 2-22/32" Face





trusscore

SlatWall

Special Order

Whether installed in a commercial or a do-it-yourself project, Trusscore SlatWall will add value and functionality to any space you choose. Made from a high-strength polymer formulation, the Trusscore SlatWall system supports weights up to 75lbs per square foot and is designed to install seamlessly with Trusscore Wall&CeilingBoard. It is the perfect organizational alternative to traditional drywall and slatwall solutions. If you're looking for an organized, accessible solution, the Trusscore SlatWall system is easy to install and has many different available hooks for your storage needs.

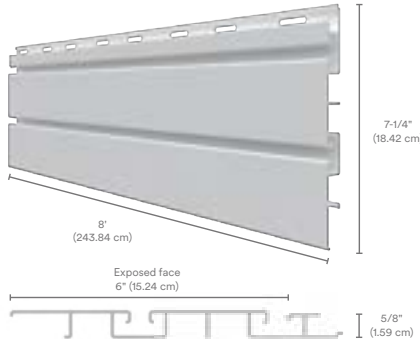

Part#	Description	Coverage	Length
TCWSW	Trusscore SlatWall PVC Interlocking Panels - 1/2" Thick - White	6"	8'
TCGSW	Trusscore SlatWall PVC Interlocking Panels - 1/2" Thick - Gray	6"	8'
TCSWDH4	Trusscore Slatwall Double Hook	4"	
TCSWDH6	Trusscore Slatwall Double Hook	6"	
TCSWSH4	Trusscore Slatwall Simple Hook	4"	
TCSWSH6	Trusscore Slatwall Simple Hook	6"	



18" Basket | CRO.P18



24" Shelf | CRO.T24



Hose Hook | CRO.H



Bike Hook | CRO.V



4" and 6" Double Hook
CRO.D4 | CRO.D6

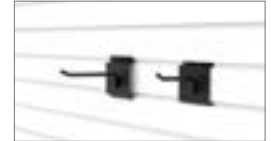

4" and 6" Simple Hook
CRO.S4 | CRO.S6

SlatWall Trims

Part#	Description	Size	Length
TCWSWCAP	Trusscore SlatWall PVC Top Cap - White	5/8" x 1-5/16"	8'
TCGSWCAP	Trusscore SlatWall PVC Top Cap - Gray	5/8" x 1-5/16"	8'
TCWSWJ34	Trusscore SlatWall PVC 3/4" J - White	1-3/8" x 3/4" x 13/16"	10'
TCGSWJ34	Trusscore SlatWall PVC 3/4" J - Gray	1-3/8" x 3/4" x 13/16"	10'

Top Cap



3/4" J

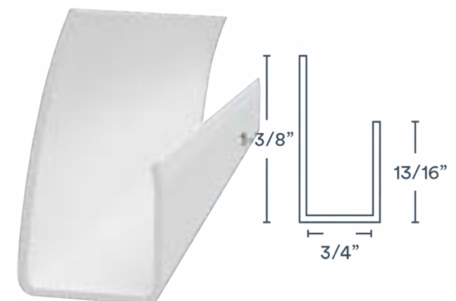



Ag-Tuf® / Ag-Tuf® UV

Ag-Tuf® corrugated PVC liner panel allows efficient cladding of structures with many benefits for all types of agricultural professionals. From hog barns to dairy sheds, from poultry houses to wineries and more, Ag-Tuf® and Ag-Tuf® UV hold up where other products won't. Ag-Tuf®'s resistance to chemicals allows for frequent cleaning and sanitary maintenance, as well as extended service in harsh chemical environments.



Ag-Tuf® panels are extremely easy to install and maintain using ordinary tools, while preserving its attractive glossy appearance over a long period of time.

Ag-Tuf® carries a 10-Year Manufacturer's Limited Warranty.

Ag-Tuf® UV carries a 5-Year Limited Warranty.



Ag-Tuf® UV 9" Rib Spacing (to match ABM Panel)

Part#	Description	Thickness	Coverage	Length
ATHWH8	White PVC Ag-Tuf UV - 9" Rib Centers - 3/4" High	1mm	36"	8'-2"
ATHWH10	White PVC Ag-Tuf UV - 9" Rib Centers - 3/4" High	1mm	36"	10'-2"
ATHWH12	White PVC Ag-Tuf UV - 9" Rib Centers - 3/4" High	1mm	36"	12'-2"
ATHWH14	White PVC Ag-Tuf UV - 9" Rib Centers - 3/4" High	1mm	36"	14'-2"
ATHWH16	White PVC Ag-Tuf UV - 9" Rib Centers - 3/4" High	1mm	36"	16'-4"
ATHWH20	White PVC Ag-Tuf UV - 9" Rib Centers - 3/4" High	1mm	36"	20'-4"

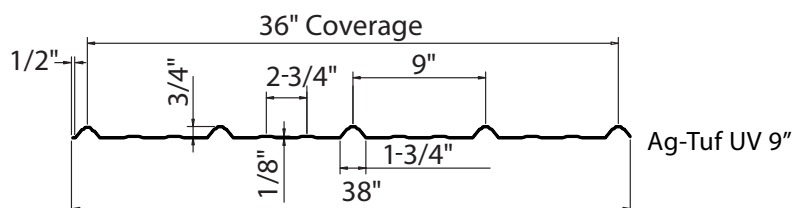

Ag-Tuf® 3" Rib Spacing

Part#	Description	Thickness	Coverage	Length
ATWH8	White PVC Ag-Tuf - 3" Rib Centers - 3/4" High	.8 mm	36"	8'-2"
ATWH10	White PVC Ag-Tuf - 3" Rib Centers - 3/4" High	.8 mm	36"	10'-2"
ATWH12	White PVC Ag-Tuf - 3" Rib Centers - 3/4" High	.8 mm	36"	12'-2"
ATWH14	White PVC Ag-Tuf - 3" Rib Centers - 3/4" High	.8 mm	36"	14'-2"
ATWH16	White PVC Ag-Tuf - 3" Rib Centers - 3/4" High	.8 mm	36"	16'-4"
ATWH20	White PVC Ag-Tuf - 3" Rib Centers - 3/4" High	.8 mm	36"	20'-4"

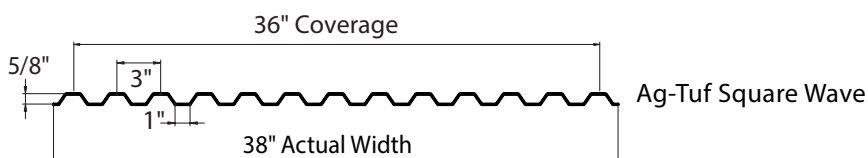



AgTuf J Channel

Part#	Description	Size	Length
ATWJ	PVC Ag-Tuf J-Channel - White	7/8" x 2"	10'



AgTuf Inside Corner/F&J Channel

Part#	Description	Size	Length
ATWIC	PVC Ag-Tuf Inside Corner or F&J-Channel - White	1-3/4" x 2-3/4"	10'

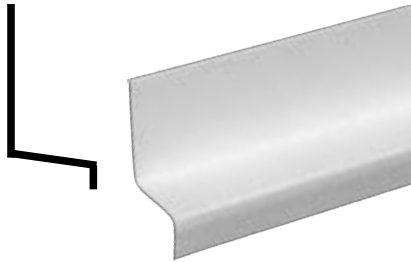

AgTuf Base Trim

Part#	Description	Size	Length
ATWBT	PVC Ag-Tuf Base Trim - White		10'



Polycarbonate Flat Sheet

Part#	Description	Thickness	Size
SKFS	Clear Polycarbonate Flat Sheet - UV 1 Side	1mm / .039"	4' x 8'
SKFS10	Clear Polycarbonate Flat Sheet - UV 1 Side	1mm / .039"	4' x 10'
SKFS12	Clear Polycarbonate Flat Sheet - UV 1 Side	1mm / .039"	4' x 12'
SKFS83	Clear Polycarbonate Flat Sheet - UV Both Side	3mm / .118"	4' x 8'
SKFS84.5	Clear Polycarbonate Flat Sheet - UV Both Side	4.5mm / .177"	4' x 8'
SKFS85.6	Clear Polycarbonate Flat Sheet - UV Both Side	5.6mm / .220"	4' x 8'



FRP/Glassboard - A Grade

Sequentia fiberglass reinforced wall and ceiling panels are durable, clean and easy to install. Sequentia FRP Panels are ideal for areas where cleanable and sanitary finish are essential.

COMMON APPLICATIONS	FEATURES
<ul style="list-style-type: none"> • Commercial Kitchens • Restaurants • Restrooms • Convenience Stores • Locker Rooms • Food Processing Plants 	<ul style="list-style-type: none"> • Mold & Mildew Resistant • Meets USDA/FSIS Requirements • Easy To Install • Cleanable • Durable



PEBBLED EMBOSSED TEXTURE



WHITE | 1130

SMOOTH TEXTURE

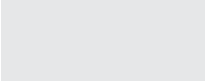

WHITE | 1130

Part#	Description	Grade	Size
GBWP8	White Pebbled Glassboard - .090	A	4' x 8'
GBWS8	White Smooth Glassboard - .090	A	4' x 8'
GBWP10	White Pebbled Glassboard - .090	A	4' x 10'
GBWS10	White Smooth Glassboard - .090	A	4' x 10'

B-grade FRP/Glassboard subject to availability.

ACTUAL COLORS MAY VARY.

REQUEST FREE COLOR SAMPLES.





FRP/Glassboard End Caps

Part#	Description	Size
GBCW	White Glassboard End Cap	10'



FRP/Glassboard Division Bar

Part#	Description	Size
GBDBW	White Glassboard Division Bar	10'



GBIW



GBLICW

FRP/Glassboard Inside Corners

Part#	Description	Size
GBICW	White Glassboard Inside Corner	10'
GBLICW	White Glassboard Large Inside Corner	1.5" x 1.5" 10'



GBOCW



GBLOCW

FRP/Glassboard Outside Corners

Part#	Description	Size
GBOCW	White Glassboard Outside Corner	10'
GBLOCW	White Glassboard Large Outside Corner	1.5" x 1.5" 10'



FRP/Glassboard Cove Moulding

Part#	Description	Size
GBCM	White Glassboard Cove Moulding	3" x 10'



FRP/Glassboard Stainless Steel Pan-head Screws

Part#	Description	Qty/Bag	Size
GBS1	#8 Stainless Steel Pan-Head FRP Screws White	100	1"
GBS15	#8 Stainless Steel Pan-Head FRP Screws White	100	1-1/2"
GBS2	#8 Stainless Steel Pan-Head FRP Screws White	100	2"



FRP/Glassboard Plastic Pop Rivets

Part#	Description	Qty/Bag	Size
GBR75	White Glassboard Rivets	100	3/4"
GBR1	White Glassboard Rivets	100	1"
GBR15	White Glassboard Rivets	100	1-1/2"



FRP/Glassboard Adhesive

Part#	Description	Coverage	Size
GBGL	FRP Construction Adhesive - 1 Gallon Can	60 sq ft	1 Gal
GBGL5	FRP Construction Adhesive - 5 Gallon Bucket	300 sq ft	5 Gal

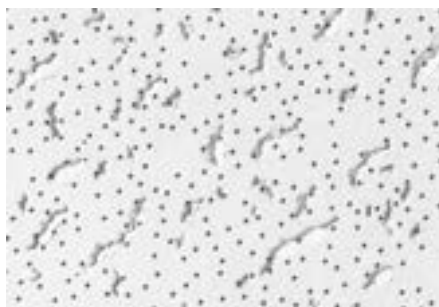

USG Fifth Avenue Series Drop Ceiling Panel

Part#	Description	Size
Y270	USG Fifth Avenue Series 280 Drop Ceiling Panel - White	24" x 24" x 5/8"
Y280	USG Fifth Avenue Series 280 Drop Ceiling Panel - White	48" x 24" x 5/8"
YSDX/SDXL216	Drop Ceiling Cross Tee - White	2'
YSDX/SDXL424	Drop Ceiling Cross Tee - White	4'
YSDXL24	Drop Ceiling Main Tee Runner - White	12'
YSM7	Drop Ceiling Wall Moulding - White	12'
Y05122	300' Hanger Wire	18 Ga.
Y7891	12' Hanger Wire	12 Ga.





White Klar® PVC Panel



Klar® Multilayer thermo-acoustic panels are composed of a series of layers, manufactured with the most advanced co-extrusion technology, which provide excellent resistance to impact and extreme climates, ensuring their long useful life. Ideal for retrofitting. Used for interior roofing, cladding and partitions inside farm buildings.

FEATURES

- Panels will never rust
- Excellent "R-Value"
- Noise reduction up to 12 decibels
- Fire resistant (Class B1: no drip, no spread.)
- Resistant to humidity, chemical, and microbiologicals.
- UV protected for a very long lifetime.
- Easy to install and maintain.

Part#	Description	Coverage	Thickness	Size
KPWH8	White KLAR PVC Panel - 9" Rib Centers	36"	1.5mm	8' 1"
KPWH10	White KLAR PVC Panel - 9" Rib Centers	36"	1.5mm	10' 1"
KPWH12	White KLAR PVC Panel - 9" Rib Centers	36"	1.5mm	12' 2"
KPWH14	White KLAR PVC Panel - 9" Rib Centers	36"	1.5mm	14' 2"
KPWH16	White KLAR PVC Panel - 9" Rib Centers	36"	1.5mm	16' 2"
KPWH20	White KLAR PVC Panel - 9" Rib Centers	36"	1.5mm	20' 2"
KPWHBA	White KLAR PVC Base Trim			12'
KPWHFJ	White KLAR PVC F&J (Outside/Inside Corner)			12'
KPWHJC	White KLAR J-Channel Trim			12'



EZ-Grip Screws (For Polycarbonate)



Part# Description

S15WHEZG 1-1/2" White EZ Grip Screws with Washer (For Polycarbonate)

Skylights & Sidelights

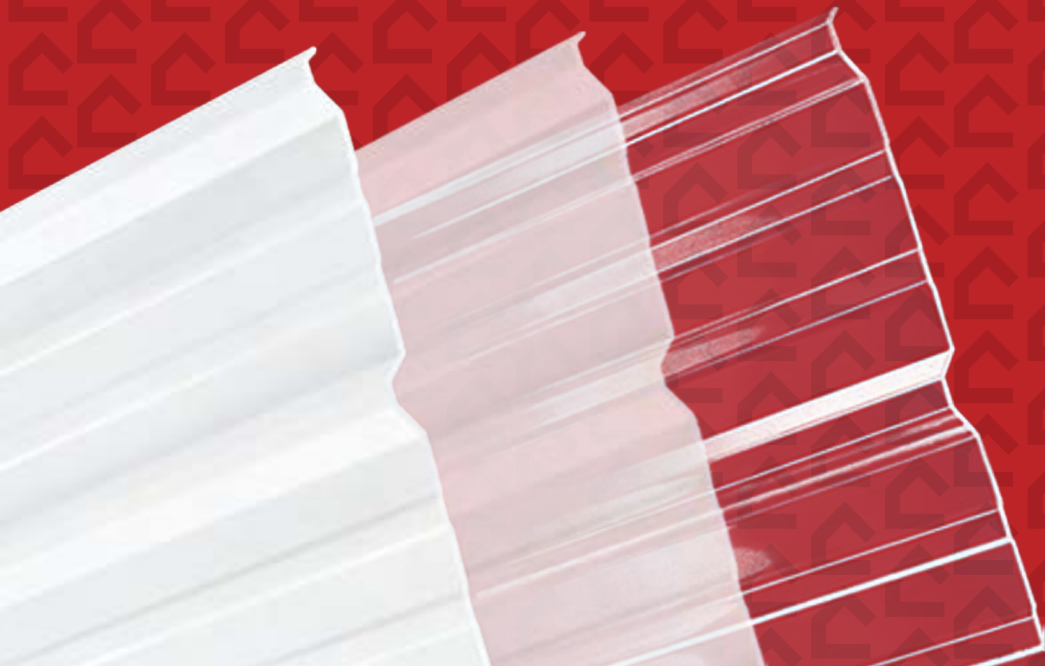



CLEAR - 90% LIGHT TRANSMISSION



SOFT WHITE - 85% LIGHT TRANSMISSION



WHITE (OPAL) - 45% LIGHT TRANSMISSION



SOLAR GRAY - 35% LIGHT TRANSMISSION



Sunsky® Skylight



SunSky corrugated polycarbonate panels stand up to punishing exterior applications and offer multiple advantages over traditional fiberglass corrugated panels. SunSky provides up to 20 times greater impact resistance, warranted protection against yellowing, excellent load ratings, and the highest resistance to wind uplift—outstanding properties confirmed by independent laboratory tests and in installations worldwide since 1984. SunSky is available in soft white for maximum light transmission without glare, as well as clear and a range of colors to filter light or reduce heat loads.

NOTICE: To prevent cracking caused by expansion and contraction, all skylights should be pre-drilled. For panels longer than 12', pre-drill panels at all fastening points with a 3/8" hole to allow for increased expansion and contraction due to longer length. For panels 12' in length or less, pre-drill a hole 1/16" larger than the diameter of the fastener shank. Palram recommends that SunSky panels are not installed below 40°F or above 80°F. For best results, use screws designed for polycarbonate with a 3/4" (19mm) washer - large enough to seal the pre-drilled hole and to allow for movement.

ABM Profile Skylight

Part#	Description	Coverage	Length
SKSTCL8	Clear Polycarbonate Skylight - 90% Light Transmission	36"	8'
SKSTCL10	Clear Polycarbonate Skylight - 90% Light Transmission	36"	10'
SKSTCL12	Clear Polycarbonate Skylight - 90% Light Transmission	36"	12'
SKSTCL14	Clear Polycarbonate Skylight - 90% Light Transmission	36"	14'
SKSTCL16	Clear Polycarbonate Skylight - 90% Light Transmission	36"	16'
SKSTSW8	Soft White Polycarbonate Skylight - 85% Light Transmission	36"	8'
SKSTSW10	Soft White Polycarbonate Skylight - 85% Light Transmission	36"	10'
SKSTSW12	Soft White Polycarbonate Skylight - 85% Light Transmission	36"	12'
SKSTSW14	Soft White Polycarbonate Skylight - 85% Light Transmission	36"	14'
SKSTSW16	Soft White Polycarbonate Skylight - 85% Light Transmission	36"	16'
SKSTWH8	White (Opal) Polycarbonate Skylight - 45% Light Transmission	36"	8'
SKSTWH10	White (Opal) Polycarbonate Skylight - 45% Light Transmission	36"	10'
SKSTWH12	White (Opal) Polycarbonate Skylight - 45% Light Transmission	36"	12'
SKSTSG12	Solar Gray Polycarbonate Skylight - 35% Light Transmission	36"	12'



ABM Skylight Ridgecap

Part#	Description	Coverage	Length
SKRLP	Clear Polycarbonate Skylight Ridge Light	24"	10'-6"

Everdrain Skylight

Part#	Description	Coverage	Length
SKCD8	Clear Polycarbonate Skylight For Everdrain Profile 6" Ribs	36"	8'
SKCD10	Clear Polycarbonate Skylight For Everdrain Profile 6" Ribs	36"	10'
SKCD12	Clear Polycarbonate Skylight For Everdrain Profile 6" Ribs	36"	12'





5V Crimp Skylight

Part#	Description	Coverage	Length
SK5V8	5V Crimp Skylight For 24" Coverage Clear Polycarbonate	24"	8'
SK5V12	5V Crimp Skylight For 24" Coverage Clear Polycarbonate	24"	12'



1-1/4" Corrugated Skylight

Note: Not a perfect match for our rollformed 1-1/4" Corrugated.

Part#	Description	Coverage	Length
SKCOR125	Clear Polycarbonate Skylight 1.25" Corrugated	24"	12'

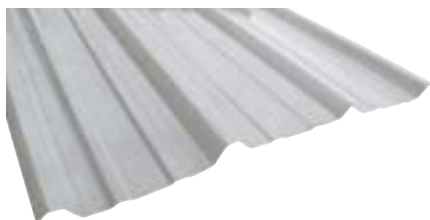

PBR Skylight

Part#	Description	Coverage	Length
SKSTRCL8	Clear Polycarbonate Skylight 1mm Thick 12" Rib Spacing	36"	8'
SKSTRCL10	Clear Polycarbonate Skylight 1mm Thick 12" Rib Spacing	36"	10'
SKSTRCL12	Clear Polycarbonate Skylight 1mm Thick 12" Rib Spacing	36"	12'
SKSTRSW12	Soft White Polycarbonate PBR 85% Light Transmission	36"	12'
SKSTRW12	White (Opal) Polycarbonate PBR 12" Ribs	36"	12'



Geocel 8150 Skylight Neutral Cure Caulk

To prevent deterioration of the polycarbonate skylights and for proper adhesion, use only 100% silicone neutral cure caulk like Geocel's 8150.

Part#	Description	Size
8150	8150 Geocel Construction Silicone - Clear	10 oz.



Polycarbonate Screws

To prevent cracking caused by expansion and contraction, all skylights should be pre-drilled. For panels longer than 12', pre-drill panels at all fastening points with a 3/8" hole to allow for increased expansion and contraction due to longer length. For panels 12' in length or less, pre-drill a hole 1/16" larger than the diameter of the fastener shank. Palram recommends that SunSky panels are not installed below 40°F or above 80°F. For best results, use screws designed for polycarbonate with a 3/4" (19mm) washer - large enough to seal the pre-drilled hole and to allow for movement.

Part#	Description	Length
S1415P	#14 Galvanized Screws w/ 3/4" Washer - to Wood	1.5"
SD1415P	#14 Galvanized Self-Drilling Screws w/ 3/4" Washer - to Metal	1.5"



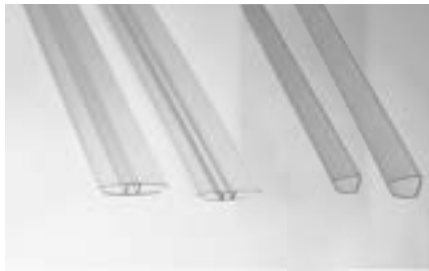

Multi-Wall

Part#	Description	Coverage	Length
SKSM648	6mm (1/4") Multi-Wall Polycarbonate	4'	8'
SKSM6410	6mm (1/4") Multi-Wall Polycarbonate	4'	10'
SKSM6412	6mm (1/4") Multi-Wall Polycarbonate	4'	12'
SKSM848	8mm (5/16") Multi-Wall Polycarbonate	4'	8'
SKSM8410	8mm (5/16") Multi-Wall Polycarbonate	4'	10'
SKSM8412	8mm (5/16") Multi-Wall Polycarbonate	4'	12'

Multi-Wall Trims

Part#	Description	Length
SK6H	6mm H Channel Clear for Multi-Wall connector/divider	12'
SK6J	6mm J Cap Clear Polycarbonate for Multi-Wall	12'
SK8H	8mm H Channel Clear for Multi-Wall connector/divider	12'
SK8J	8mm J Cap Clear Polycarbonate for Multi-Wall	12'

Asphalt Shingles



TITAN XT[®]

WHERE INNOVATION MEETS EXTREME TECHNOLOGY™

Tamko[®] Titan XT Shingles

Titan XT™ shingles feature some of the most advanced innovative technology in the industry. With powerful engineering, Titan XT shingles are designed to offer an advantage for both homeowners and contractors, combining in-demand product features into one Extreme Technology shingle designed to help weather extreme conditions

FEATURES

- Ultramax Weathering™ Layer increases top coating
- Power Core™ fiberglass mat for strength
- Ceramic granules embedded for beauty and protection
- Rapid Fire Nailing Zone up to 5x larger than Tamko's standard Heritage nailing area
- 160 MPH wind protection
- Improves the look and value of your home without the high costs associated with wood
- Limited Lifetime Warranty
- 10-year Full Start
- 15-year limited warranty against damage from wind up to 160 mph**



Part#	Description	Dimensions	Exposure
STTcc	Tamko Titan Shingles - 3 Bundles Per Square	39.375" x 13.25"	5.625"
SHICAPcc	Tamko Hip & Ridge Cap - Covers 33'		
SHTWBSS	Tamko 10" Starter Shingles Coverage 100' per bundle		10" x 40"



OLDE ENGLISH PEWTER (OP)

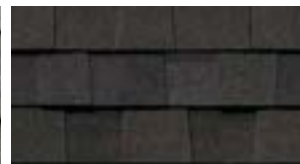

RUSTIC BLACK (RB)



VIRGINIA SLATE (VS)



RUSTIC CEDAR (RC)



RUSTIC REDWOOD (RR)



OXFORD GRAY (OG)



WEATHERED WOOD (WW)

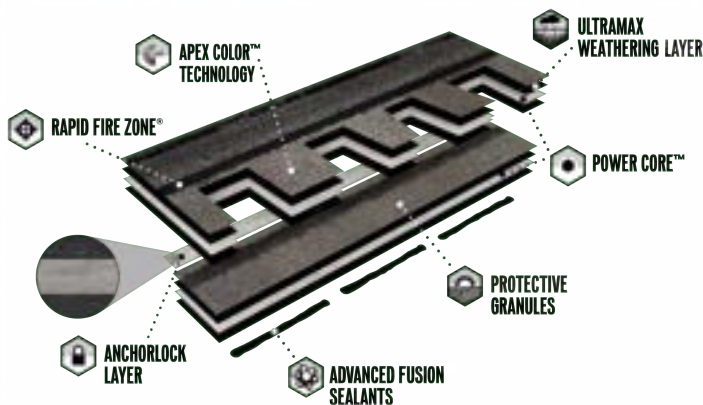

ACTUAL COLORS MAY VARY.
REQUEST FREE COLOR SAMPLES.





GAF Roofing Shingles Timberline HDZ®

- Patented High Definition® shadow bands create exceptional depth and dimension.
- Patented LayerLock™ Technology and the StrikeZone™ nailing area help your roofer do their best work.
- Proprietary GAF Time-Release algae protection technology resists algae in a whole new way.

Part#	Description	Size
SGTBW	GAF Timberline HDZ Shingles - Barkwood	13 1/4" x 39 3/8"
SGTCH	GAF Timberline HDZ Shingles - Charcoal	13 1/4" x 39 3/8"
SGTPG	GAF Timberline HDZ Shingles - Pewter Gray	13 1/4" x 39 3/8"
SGTSL	GAF Timberline HDZ Shingles - Slate	13 1/4" x 39 3/8"
SGTSW	GAF Timberline HDZ Shingles - Shakedown	13 1/4" x 39 3/8"
SGTWW	GAF Timberline HDZ Shingles - Weathered Wood	13 1/4" x 39 3/8"

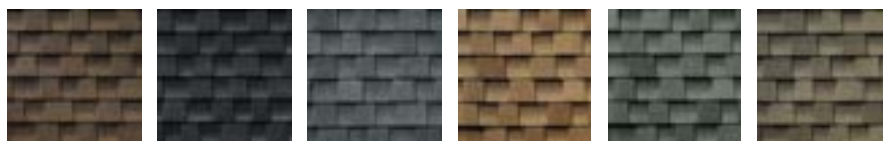

BARKWOOD CHARCOAL PEWTER GRAY SHAKEDOWN SLATE WEATHERED WOOD



GAF Seal-A-Ridge Shingles

- Machine cut design provides a much cleaner finished look than hand-cut 3-tab strip shingles.
- A high-quality, less labor-intensive option to using cut-up 3-tab shingles as your ridge cap.
- Unlike cut-up 3 tab strip shingles, they're designed to complement the color of your GAF shingles.

Part#	Description
SGTCBW	GAF Timberline Seal-A-Ridge Shingles - Barkwood
SGTCCH	GAF Timberline Seal-A-Ridge Shingles - Charcoal
SGTCPG	GAF Timberline Seal-A-Ridge Shingles - Pewter Gray
SGTCSL	GAF Timberline Seal-A-Ridge Shingles - Slate
SGTCSW	GAF Timberline Seal-A-Ridge Shingles - Shakedown
SGTCWW	GAF Timberline Seal-A-Ridge Shingles - Weathered Wood



SGTSWB



SGTSPS

GAF Starter Shingles

Part#	Description
SGTSPS	GAF Pro-Start Starter Shingles - 120'
SGTSWB	GAF Weather Blocker Starter Shingles - 50'





Owens Corning® Duration® Shingles

Duration® Series Shingles are unrivaled by any other architectural shingles because they feature our patented SureNail® Technology - a technological breakthrough in shingle design.

The Series highlights our popular Duration® Shingles, along with up to 7 other Duration styles, depending on where you live, that feature unique performance characteristics. It's no wonder why 9 out of 10 professional roofing contractors prefer to install Duration® Series Shingles with SureNail® Technology.

FEATURES

- A "NO GUESS" nailing zone for a consistent and quality installation
- Outstanding gripping power to the shingle below so your water-shedding roof stays intact
- A unique triple layer of reinforcement in the nailing zone for excellent fastener holding power against wind uplift
- A 130mph wind warranty

Part#	Description	Dimensions
SOCDBW	Brownwood Duration Shingles	39.375" x 13.25" 5.625"
SOCDDR	Desert Rose Duration Shingles	
SOCDDW	Driftwood Duration Shingles	10" x 40"
SOCDEG	Estate Gray Duration Shingles	
SOCDOB	Onyx Black Duration Shingles	10" x 40"
SOCDSG	Slate Gray Duration Shingles	

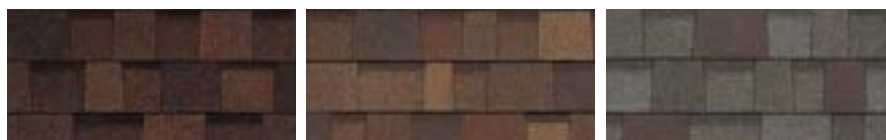

BROWNWOOD

DESERT ROSE

DRIFTWOOD



ESTATE GRAY

ONYX BLACK

SLATE GRAY



BROWNWOOD

DESERT ROSE

DRIFTWOOD



ESTATE GRAY

ONYX BLACK

SLATE GRAY





Owens Corning® Duration® ProEdge® Hip and Ridge Cap Shingles

Attention to detail matters. ProEdge® Hip & Ridge Shingles provide a clean and consistent look. Their enhanced aesthetics add distinction to your roof line.

Part#	Description	Length
SOCDCSBW	Brownwood Duration ProEdge Hip & Ridge Cap Shingles	33'
SOCDCSDR	Desert Rose Duration ProEdge Hip & Ridge Cap Shingles	33'
SOCDCSDW	Driftwood Duration ProEdge Hip & Ridge Cap Shingles	33'
SOCDCSEG	Estate Gray Duration ProEdge Hip & Ridge Cap Shingles	33'
SOCDCSOB	Onyx Black Duration ProEdge Hip & Ridge Cap Shingles	33'
SOCDCSSG	Slate Gray Duration ProEdge Hip & Ridge Cap Shingles	33'



Owens Corning® Duration® Starter Strip Shingles

Starter Strip Plus Shingle helps save time by eliminating the need to cut shingles to create a starter row. Starter Strip Plus Shingle is packaged two pieces per shingle, and perforated down the center for easy separation.

Part#	Description	Length
SOCDCSS	Duration Starter Strip Shingles	105'

ROOFTOP DELIVERY AVAILABLE!

Call us for a quick delivery directly to your jobsite rooftop.





Lomanco Lo-Omniroll Shingle Vent

- 30' Roll
- Comes with two coils of 1.75" nails
- Suitable for $2/12$ to $16/12$ pitch
- 14.5" wide for a 12" cap shingle
- Lifetime Warranty

Part#	Description	Size
SHTVL	Lomanco Lo-Omniroll Shingle Vent w/ 1.75" Nails	14.5" x 30"



Viper Ridge Vent

VIPER RIDGE VENT™ is a patented, light weight, ridge vent that provides an industry leading 15 square inches of net free vent area (NFVA) per linear foot (15 in²/LF).

Part#	Description	Size
CV10.5	Roof Saver Viper Vent for a Durable Roof	11" x 20"

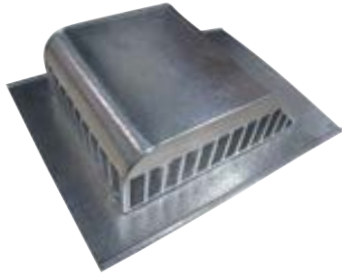

Aluminum Slant Back Roof Louver

Part#	Description	NFA	Vent Size
YSSB960AWW	Slant Back Aluminum Roof Louver - Weathered Wood	60 sq. in.	11" x 14" x 5"
YSSB960A	Slant Back Aluminum Roof Louver - Mill Finish	60 sq. in.	11" x 14" x 5"
YSSB960ABL	Slant Back Aluminum Roof Louver - Black	60 sq. in.	11" x 14" x 5"
YSSB960ABR	Slant Back Aluminum Roof Louver - Brown	60 sq. in.	11" x 14" x 5"

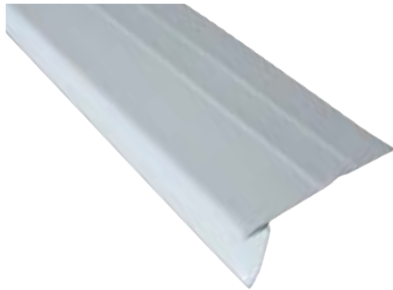

Aluminum Drip Edge

Part#	Description	Face	Length
SOFDEBL	Black F4 Aluminum Drip Edge - .014	1"	10'
SOFDEBN	Brown F4 Aluminum Drip Edge - .014	1"	10'
SOFDECL	Clay F4 Aluminum Drip Edge - .014	1"	10'
SOFDEWH	White F4 Aluminum Drip Edge - .014	1"	10'
ODEBN	Royal Brown ODE Drip Edge Aluminum - .019	2"	10'
ODEWH	White ODE Drip Edge Aluminum - .019	2"	10'

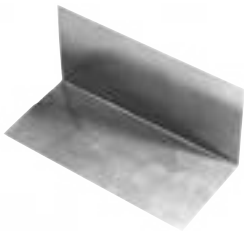

Aluminum Step Flashing

Part#	Description	Size
ISF	Aluminum Step Flashing - .018 100 Per Pack	2" x 3" x 7"
ISF337	Aluminum Step Flashing - .018 100 Per Pack	3" x 3" x 7"
ISF57	Flat Aluminum Step Flashing - .012 100 Per Pack	5" x 7"



Electro-Galvanized Roofing Coil Nails

Part#	Description	Size
NACR151	EG Roofing 15 Degree Coil Nails - 60 Coils 7200/box	.120 1"
NACR15125	EG Roofing 15 Degree Coil Nails - 60 Coils 7200/box	.120 1-1/4"
NACR1515	EG Roofing 15 Degree Coil Nails - 60 Coils 7200/box	.120 1-1/2"
NACR15175	EG Roofing 15 Degree Coil Nails - 60 Coils 7200/box	.120 1-3/4"



Stainless steel coil nails

Part#	Description	Qt	Dimensions
NACR15125SS	15 Degree Stainless Steel Ring Shank Roofing Coil Nails	1800/Box	1-1/4"X.120
NACR1515SS	15 Degree Stainless Steel Ring Shank Roofing Coil Nails	1800/Box	1-1/2"X.120





Oatey Roof Flashing

Part#	Description	Pipe Size
Y11898	Oatey Roof Flashing 1-1/4" x 1-1/2" Black	1.25" - 1.5"
Y11899	Oatey Roof Flashing 2" Black	2"
Y11919	Oatey Roof Flashing 1", 2", and 3" Black	1", 2", & 3"
Y11931	Oatey Roof Flashing 3" - 4"	3" - 4"

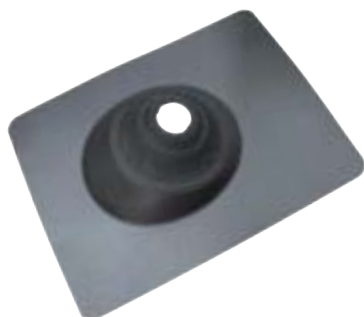

Nevercaulk Residential Roof Flashing

Part#	Description	Pipe Size
MFRS13	Nevercaulk Residential Roof Flashing with Aluminium Base	1.25" - 3"
MFRS34	Nevercaulk Residential Roof Flashing with Aluminium Base	3" - 4"



Perma-Boot® Roof Flashing - Retrofit

The Perma-Boot is a high-performance roof flashing for replacing existing roof boots without removing shingles.

FEATURES

- Installs in minutes
- No tools required
- $\frac{3}{12}$ to $\frac{12}{12}$ Slope
- Lifetime Warranty

Part#	Description	Pipe Size
MFPB15B	Perma-Boot Repair Roof Flashing 1.5" Black	1.5"
MFPB2B	Perma-Boot Repair Roof Flashing 2" Black	2"
MFPB3B	Perma-Boot Repair Roof Flashing 3" Black	3"



Lifetime Ultimate Pipe Flashing

Part#	Description	Pipe Size
UPF15B	Lifetime Ultimate Pipe Flashing - Kynar Bronze Base	1.5"
UPF2B	Lifetime Ultimate Pipe Flashing - Kynar Bronze Base	2"
UPF3B	Lifetime Ultimate Pipe Flashing - Kynar Bronze Base	3"





GAF® Cobra® SnowCountry® Roof Ridge Exhaust Vent

Remove excess heat and moisture from the attic and protect the roof system from premature deterioration.

FEATURES

- Allows heat and moisture to escape
- Shingle-over design
- Engineered for durability
- External baffles
- Snow Guard™ filter

Part#	Description	Dimensions
SGTSCRV	GAF® 11.5" x 48" Ridge Vent	11.5" x 48"



Owens Corning® Ventsure® Heat & Moisture Strip Ridge Vent

VentSure® 4-Foot Strip Ridge Vents work with intake ventilation to help improve airflow through the attic. They are flexible enough to conform to virtually any roof slope and provide a sturdy construction and design to help provide outstanding performance in all seasons.

FEATURES

- Outstanding airflow
- Unique design
- Excellent versatility

Part#	Description	Dimensions
SOCDVSRV	Owens Corning® 11.5" x 48" Ridge Vent	11.5" x 48"

Rubber Roofing

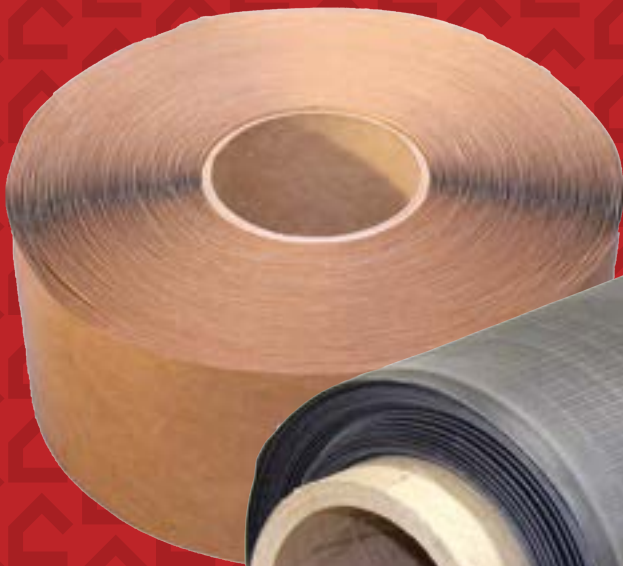



WEATHERBOND

A DIVISION OF
CARLISLE CONSTRUCTION MATERIALS



Black Rubber Roofing - Weatherbond

WeatherBond's EPDM provides building owners with a long-lasting, dependable roof system and applicators with a fast and easy installation. Its black surface can assist with snow melt and heat gain in colder climates. Its elasticity is great for freeze/thaw conditions and hail-prone areas.

FEATURES

- Fast and easy installation
- Proven performance for 40+ years
- Includes a full line of black accessories

Part#	Description	Thickness	Roll or LF	Size
RRB1045	Black Rubber Roofing - WeatherBond	.045"	•	10' X 100'
RRB104550	Black Rubber Roofing - WeatherBond	.045"		10' X 50'
RRB2045	Black Rubber Roofing - WeatherBond	.045"	•	20' X 100'
RRB204550	Black Rubber Roofing - WeatherBond	.045"		20' X 50'
RRB1060	Black Rubber Roofing - WeatherBond	.060"	•	10' X 100'
RRB106050	Black Rubber Roofing - WeatherBond	.060"		10' X 50'
RRB2060	Black Rubber Roofing - WeatherBond	.060"	•	20' X 100'
RRB206050	Black Rubber Roofing - WeatherBond	.060"		20' X 50'

WEATHERBOND ROOFING IS A DIVISION OF CARLISLE CONSTRUCTION MATERIALS, A WHOLLY OWNED SUBSIDIARY OF CARLISLE COMPANIES (NYSE: CSL)

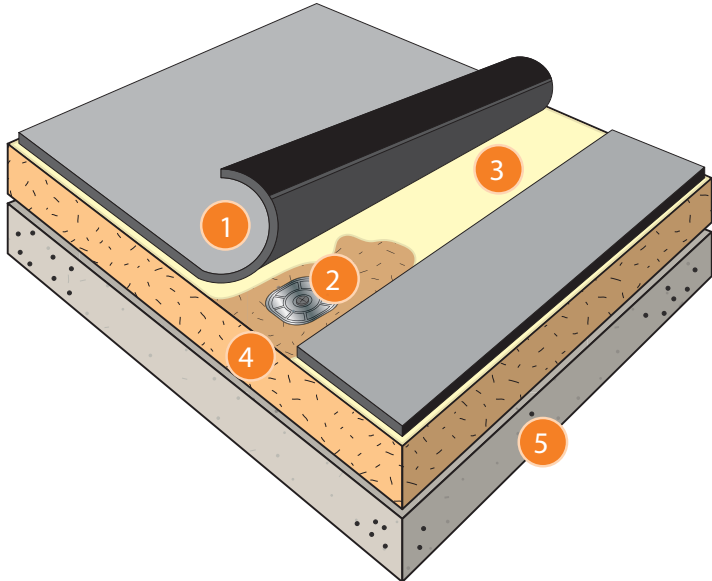

Typical Application

- 1 WeatherBond EPDM Membrane
- 2 Fasteners and Plates
- 3 EPDM Bonding Adhesive
- 4 Acceptable Insulation
- 5 Approved Roof Deck

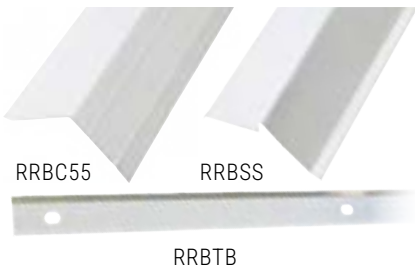

Rubber Roofing Trims

Part#	Description	Size	Length
RRBC55	1/2" Drip Edge - .019 White Aluminum - Berger C5	2-3/4" Face x 2 3/4"	10'
RRBS	1/2" Slag Stop w/11/16" Stop - .019 White Aluminum - Berger H5	2.3/8" Face x 2"	10'
RRBTB	Termination Bar - Aluminum		10'



Rubber Roofing Flashing Tape

Sticky on one side, the flashing tape is uncured rubber used to flash around chimneys, corners, pipes, and curved objects.

Part#	Description	Size
RRBFS1250	Fastape Flashing - Uncured Peel & Stick Self Adhesive	12" X 50'
RRBFS6100	Fastape Flashing - Uncured Peel & Stick Self Adhesive	6" X 100'



Rubber Roofing Seam Tape

Sticky on both sides, the seam tape is used in joining two pieces of rubber roofing.

Part#	Description	Size
RRBST3100	Seam Tape	3" X 100'
RRBST6	Seam Tape	6" X 100'



Rubber Roofing Cover Tape

Sticky on one side, the cover tape is cured rubber used to cover seams in rubber roofing and to cover drip edge.

Part#	Description	Size
RRBST5100	Cover Strip - Cured Peel & Stick	5" X 100'
RRBST1250	Cover Strip - Cured Peel & Stick	12" X 50'



Rubber Roofing Reinforced Strip

Cured rubber used when anchoring rubber roofing around the perimeter.

Part#	Description	Size
RRBRS6100	Reinforced Strip - Cured Sticky One Side - Peel & Stick	6" X 100'



Rubber Roofing Corner Flashing

Part#	Description
RRBCF	Universal Corner Flashing - Uncured Peel & Stick Roof Patch





PL5025SPRAY



RRBCLEANER



Cleaners

Part#	Description	Size
PL5025SPRAY	5025 Splice & Seam Cleaner Aerosol Spray - Lucas	
RRBCLEANER	Weathered Rubber Cleaner	1 Gal.

Primer

Part#	Description	Low VOC	Size
RRBSPPT	1 Pint Rubber Seam Fast Clean Primer	No	1 Pint
RRBSP1	1 Gal. Rubber Seam Fast Clean Primer	Yes	1 Gal.

Adhesive

Part#	Description	Low VOC	Size
RRBSA1	All Purpose Adhesive Rubber Splice Cement & Substrate - Fasseal	No	0.95 Gal.
RRBSA5	8800 Water-based Bonding Adhesive/ Substrate Glue - Lucas	N/A	5 Gal.
RRBSAL5	Rubber Substrate Adhesive - Weather Bond	Yes	5 Gal.

Black Neoprene Roof Cement

Part#	Description	Low VOC	Size
Y1329-GA	Black Neoprene Roof Cement - Black Jack	N/A	10.5 Oz.

Sealants

Part#	Description	Size
4500WH	4500 WHITE BONDING SEALANT - GEOCEL	10 Oz. Tube
4500BL	4500 Black Bonding Sealant - Geocel	10 Oz. Tube
RRBLS	Rubber Roofing Black Lap Sealant	10 Oz. Tube
RRBWCOM	Fasdri Water Cut-Off Caulking - Mastic	10.5 Oz. Tube

Self-Leveling Sealer - Black 2 Liter

Part#	Description	Size
PL4500	#4500 self-leveling sealer black	2 Liter.



Rubber Roofing Pipe Boot

Part#	Description	Pipe Size
RRBVGPB	Rubber Roof Pipe Boots - Peel & Stick	1" - 6"



Rubber Roofing Plastic Drain Strainer

Part#	Description	Pipe Size
RRBPS	Plastic Strainer for Rubber Roofing Drain - Dura	3" - 4"



Rubber Roofing Drain Insert

Part#	Description	Size
RRBDIS3	Roof Drain Insert for Rubber Roofing	3"
RRBDIS4	Roof Drain Insert for Rubber Roofing	4"



Rubber Roofing Drain Insert - Enpoco-Pak

Part#	Description	Size
RRBEP3	Marathon Enpoco-Pak drain for Rubber Roofing	3"
RRBEP4	Marathon Enpoco-Pak drain for Rubber Roofing	4"



Chip Brush

Part#	Description	Size
YCB3	Chip Brush	3"
YCBX4	Chip Brush Double Thick	4"





Rubber Roofing Scouring Pad

Part#	Description	Width
Y86-X	Green Heavy Duty Scouring Pad	6" x 9"



Y36772032

YJR008

Rubber Roofing Rollers and Covers

Part#	Description	Width
Y36772032	Steel Single Fork Seam Roller	2" x 2"
YJR008	J Roller Plastic Marshalltown	1-1/2"x3"



YRC 139



YR204-4

Roller Covers

Part#	Description	Width
YRC 139	Roller Cover 6 pk	3/8" x 9"
YR204-4	Wooster Roller Cover, 1/2 in Nap, 4"	1/2" x 4"

Roller Handles



PHANDTH

YRP 548 HM

Y3165M

Part#	Description	Length
PHANDTH	Wood Handle Threaded	48"
YRP 548 HM	Wood Handle with Metal Tip	48"
Y3165M	Universal Handles Metal Thread	60"



Fiberboard - Rubber Roofing Insulation

Part#	Description	R-Value	Size	Thick.
ISO12A	Fiber Board Celotex High Density Structodek	1.3	4' x 8'	1/2"
ISO1	Felt Faced ISO Insulation - AC Foam-II A grade	5.7	4' x 8'	1"
ISO15	Felt Faced ISO Insulation - AC Foam-II A grade	8.6	4' x 8'	1-1/2"
ISO2	Felt Faced ISO Insulation - AC Foam-II A grade	11.4	4' x 8'	2"



Insulation Plates

Part#	Description	Diameter
RRBIPP	Round Plastic Insulation Plates	3"
RRBIP	Round Galvalume Insulation Plates	3"
RRBIP2	Round Galvalume Insulation Plates	2"



Insulation Fasteners

Part#	Description	Shaft Size	Length
SD158	Dekfast Insulation Fastener Screw #3 Phillips Head	#12	1-5/8"
SD2	Dekfast Insulation Fastener Screw #3 Phillips Head	#12	2-1/4"
SD3	Dekfast Insulation Fastener Screw #3 Phillips Head	#12	3"
SD4	Dekfast Insulation Fastener Screw #3 Phillips Head	#12	4"
SD5	Dekfast Insulation Fastener Screw #3 Phillips Head	#12	5"
SD6	Dekfast Insulation Fastener Screw #3 Phillips Head	#12	6"
SD7	Dekfast Insulation Fastener Screw #3 Phillips Head	#12	7"
SD8	Dekfast Insulation Fastener Screw #3 Phillips Head	#12	8"
SD10	Dekfast Insulation Fastener Screw #3 Phillips Head	#14	10"
SD12	Dekfast Insulation Fastener Screw #3 Phillips Head	#14	12"



House Wrap & Underlayment





Rexwrap Plus House Wrap

Part#	Description	Size
IHWR	House Wrap - Rexwrap Plus	9' x 100'



Tyvek® House Wrap

Unique material science helps prevent the infiltration of air and water, but lets water vapor escape to prevent rot and mold inside walls.

- 10-year limited warranty from DuPont
- Easy to install

Part#	Description	Size
IHWT	House Wrap - Tyvek	9' x 100'
IHWT10	House Wrap - Tyvek	10' x 100'



Tyvek® StuccoWrap®

Tyvek® StuccoWrap® WRB has an engineered, grooved surface that is designed to be installed as a drainage plane behind stucco facades and EIFS systems.

- 10-year limited warranty from DuPont.
- Superior water management that promotes stronger facades.

Part#	Description	Size
IHWTS	Stucco Wrap - Tyvek	5' x 200'



Warrior Felt Paper

Part#	Description	Covers
IFP15	15# Warrior Felt Paper	4 sq.
IFP30	30# Warrior Felt Paper	2 sq.



IIWHT

IIWS

Ice & Water Protector Underlayment

- Great for metal roofs

Part#	Description	Size
IIWHT	CMI PS MAX HT Ice & Water Protector - Secure Grip Surface	36" x 66.7'
IIWS	45 MIL Class A Fire -40F - 260F High Temperature - UV to 6 months Synthetic Ice & Water Protector - Epiplay Plystik	36" x 66.7'





DuPont® Roof Protector

DuPont Roof Protector preserves the roof deck during installation, and with a high strength to weight ratio provides a lightweight yet durable barrier against water. Unlike other value synthetics, DuPont Roof Protector is much less prone to wind pull-up and tearing at fastener points during installation. With its slip-resistant surface, DuPont Roof Protector is ideal for steep slopes under asphalt shingle and metal panel roof materials. 90-day UV resistance, and 20-year limited warranty with Class "A" fire rating per ASTM E108.

Part#	Description	Size	Covers
IULP	Tyvek Roof Protector Synthetic Roofing Underlayment	42" X 286'	10 sq.



Tyvek® Protec™ 120

DuPont™ Tyvek® Protec™ engineered synthetic roofing underlayments offer high-performance with a variety of roofing materials, from metal roofing to asphalt shingles. The unique embossed pattern allows for better traction and grip while walking on the roof. The bottom layer includes a slip-resistance coating providing grip to the roof deck. Accepts and holds chalk marks for more visible lines and a better-finished product. 3-month UV exposure and 40-year warranty with Class "A" fire rating per ASTM E108.

Part#	Description	Size	Covers
IUL30	Tyvek Protec 120 Synthetic Roofing Underlayment	48" X 250'	10 sq.



Tyvek® Protec™ 160

Tyvek® Protec™ 160 is an engineered synthetic roofing underlayment with industry-leading walkability from DuPont. Ideal for slopes 2:12 or higher under a variety of roofing materials in repair, re-roofing and new construction. The unique embossed pattern allows for better traction and grip while walking on the roof. The bottom layer includes a slip-resistance coating providing grip to the roof deck. Accepts and holds chalk marks for more visible lines. 6-month UV exposure and 40-year warranty with Class "A" fire rating per ASTM E108.

Part#	Description	Size	Covers
IUL40	Tyvek Protec 160 Synthetic Roofing Underlayment	48" X 250'	10 sq.



Elephant Skin Synthetic Roofing Underlayment

- .ASTM D226 & D4869 approved
- One of the best anti-slip surfaces on the market
- 180 day UV exposure
- Temp -30° to 220° Fahrenheit

Part#	Description	Size	Covers
IULE	Elephant Skin Synthetic Underlayment	42" x 286'	10 sq.



Henry Eaveguard Shingle Underlayment

- Split face backer
- Meets ASTM D1970
- Works for metal
- Granulated

Part#	Description	Size	Covers
IIWGH	Henry Eaveguard Shingle Underlayment (Blue Roll)	36" x 65'	195 sqft





Tyvek® Flashing Tape

Part#	Description	Size
IWW4T	Window Flashing Tape Tyvek Brand	4" x 75'
IWW6T	Window Flashing Tape Tyvek Brand	6" x 75'

Tyvek® FlexWrap Flashing Tape

Part#	Description	Size
IWWF6T	Flexwrap Self-adhering Flashing Tape for Curved Windows	6" x 75'
IWWF3T	Flexwrap Self-adhering Flashing Tape for Pipes	2.75" x 15'

Tyvek® House Wrap Tape

Part#	Description	Size
IHWTAPE	Tyvek House Wrap Tape - 2"	2" x 165'
IHWTAPE3	Tyvek House Wrap Tape - 3"	3" x 165'

Window Wrap Flashing Tape

Part#	Description	Size
IWW4	Window Wrap Self-adhering Flashing Tape for Window/Door	4" x 75'
IWW6	Window Wrap Self-adhering Flashing Tape for Window/Door	6" x 100'

ZIP System Huber Flashing Tape

Part#	Description	Size
TAPEZIP	Huber Zip Tape	3-3/4" x 90'

ZIP System Huber Stretch Tape

Part#	Description	Size
TAPEZIPS	Huber Zip Stretch Tape	6" x 75'

Huber ZIP System™ Flashing Tape Roller

"Z" impression on tape provides visual indicator of where tape has been rolled.

Part#	Description	Size	Covers
TAPEZIPR	Huber ZIP System Flashing Tape Roller	42" X 286"	10 sq.





GAF® FeltBuster® Synthetic Roofing Underlayment

Cost-effective upgrade to typical asphalt felts that provides a secondary layer of wind-driven rain protection.

Part#	Description	Size	Covers
IULFB	Synthetic Roofing Underlayment	48" X 250'	10 sq.



Owens Corning® ProArmor® Synthetic Roofing Underlayment

Owens Corning® ProArmor® Synthetic Roof Underlayment with Fusion Back Coating Technology™ is strong, durable and repels water unlike 15 lb felt. It's also light, easy to install and contributes to safe working conditions.

Part#	Description	Size	Covers
IULPA	Synthetic Roofing Underlayment	42" X 286'	10 sq.

Lumber, Posts, & Trusses

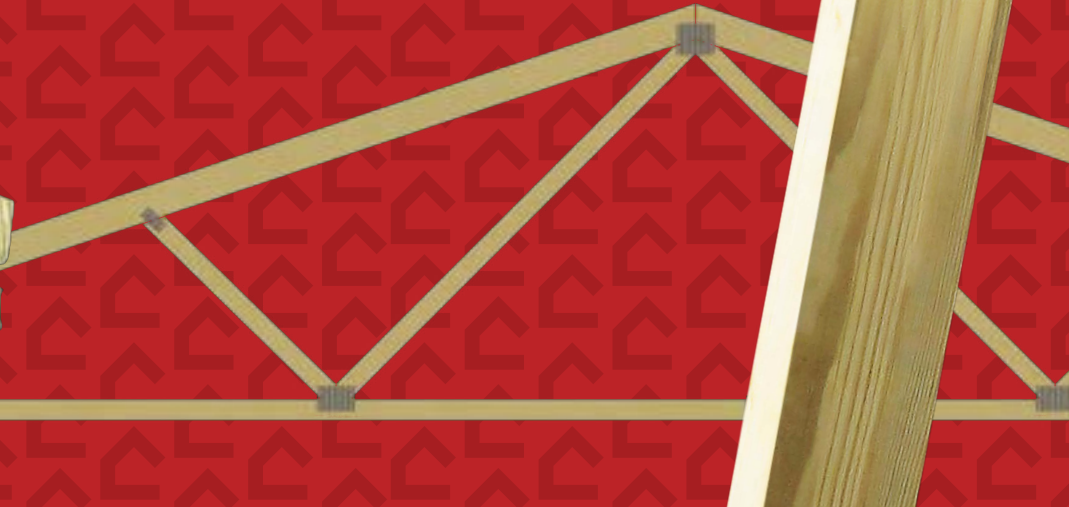
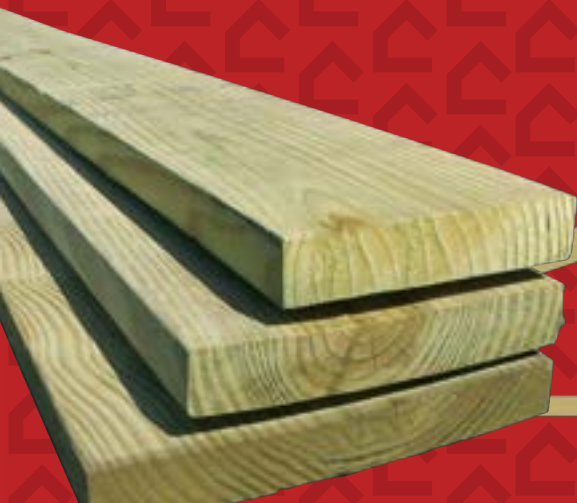



Spruce/Pine/Fir Dimensional Lumber

Available in 2' increments

Part#	Description	Size	Lengths
L23**	SPF	2 x 3	8', and 16'
L249258	SPF	2 x 4	92-5/8"
L2410458	SPF	2 x 4	104-5/8"
L24**	SPF	2 x 4	8' - 20'
L269258	SPF	2 x 6	92-5/8"
L2610458	SPF	2 x 6	104-5/8"
L26**	SPF	2 x 6	8' - 24'
L28**	SPF	2 x 8	8' - 24'
L210**	SPF	2 x 10	8' - 24'
L212**	SPF	2 x 12	12'-18', 20', 24'
L13**	Furring Lath	1 x 3	8', 12', 16'
L14123	Furring Lath #3	1 x 4	12'



LVL Headers

Available in 2' increments

Part#	Description	Size	Lengths
LVL95**	LVL 9-1/4 in. Header	1-3/4 x 9-1/4	8' - 48'
LVL1178**	LVL 11-7/8 in. Header	1-3/4 x 11-7/8	8' - 38', and 48'
LVL14**	LVL 14 in. Header	1-3/4 x 14	8' - 38', and 48'
LVL16**	LVL 16 in. Header	1-3/4 x 16	8' - 36', and 48'
LVL18**	LVL 18 in. Header	1-3/4 x 18	8' - 32', 36', and 48'
LVL24**	LVL 24 in. Header	1-3/4 x 24	16', 20', 36', and 48'
LVL1125**	LVL 11-1/4 in. Header	1-3/4 x 11-1/4	8' - 48'



Yellow Pine Machine Stress Rated

Part#	Description	Size	Lengths
LMSR2816	Yellow Pine MSR - Special Order	2 x 8	16'
LMSR210**	Yellow Pine MSR	2 x 10	10' - 20'
LMSR212**	Yellow Pine MSR	2 x 12	10' - 20'



#1 Yellow Pine

Available in 2' increments

Part#	Description	Size	Lengths
LYP24	#1 Yellow Pine	2 x 4	16'
LYP26**	#1 Yellow Pine	2 x 6	10' - 16'
LYP28**	#1 Yellow Pine	2 x 8	10' - 24'
LYP210**	#1 Yellow Pine	2 x 10	10' - 24'
LYP212**	#1 Yellow Pine	2 x 12	10' - 24'



#2 Yellow Pine

Available in 2' increments

Part#	Description	Size	Lengths
LYP28**	#2 Yellow Pine	2 x 8	10' - 16'



Treated Yellow Pine

Available in 2' increments

Part#	Description	Size	Lengths
LT1412	Treated Yellow Pine	1 x 4	12'
LT1612	Treated Yellow Pine	1 x 6	12'
LT1812	Treated Yellow Pine	1 x 8	12'
LT54616RRFB	Treated Rough Ranch Fence Board	1 x 6	16'
LT546**	Standard Treated Yellow Pine - Rounded Edges	5/4 x 6	8' - 16'
LT546**1	Premium Treated Yellow Pine - Rounded Edges	5/4 x 6	12', 16', and 20'
LT24**	Treated Yellow Pine	2 x 4	8' - 16'
LT26**GC	Treated Yellow Pine Ground Contact	2 x 6	10', 12', 14', 16', and 20'
LT28**GC	Treated Yellow Pine Ground Contact	2 x 8	8' - 20'
LT210**GC	Treated Yellow Pine Ground Contact	2 x 10	8' - 20'
LT212**GC	Treated Yellow Pine Ground Contact	2 x 12	10', 12', 16', and 20'

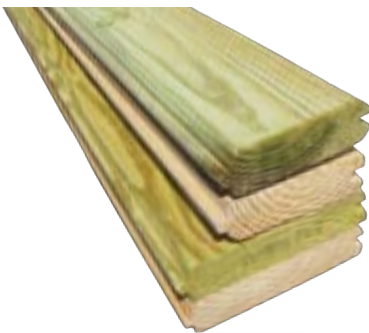

Tongue & Groove Yellow Pine

Available in 2' increments

Part#	Description	Size	Lengths
LYP26**TG	#1 T&G Yellow Pine	2 x 6	10' - 16'
LYP28**1TG	#1 T&G Yellow Pine	2 x 8	10' - 16'
LYP28**TG	#2 T&G Yellow Pine	2 x 8	10' - 16'
LYP2816TGNOV	T. & G. { NO V GROOVE } # 2 Southern Yellow Pine	2 x 8	16'



Treated Tongue & Groove Yellow Pine

Available in 2' increments

Part#	Description	Size	Lengths
LT26**TG	Treated T&G Yellow Pine	2 x 6	10' - 16'
LT28**TG	Treated T&G Yellow Pine	2 x 8	12' and 16'

Treated Dog Eared Fence Boards

Part#	Description
LT5866	5/8 x 6 x 6' Treated Dog Eared Fence Boards





Shiplap Rough Sawn Pine

Part#	Description	Size	Length
L11010SL	RS Shiplap	1 x 10	10'
L11012SL	RS Shiplap	1 x 10	12'
L11014SL	RS Shiplap	1 x 10	14'
L11016SL	RS Shiplap	1 x 10	16'
L1516SL	RS Shiplap	1 x 5	16'

Tongue & Groove Pine Barn Siding

Available in 2' increments

Part#	Description	Size	Lengths
L16**TG	T&G Beaded Barn Siding w/ V Groove	1 x 6	8' - 16'
L18**TG	T&G Beaded Barn Siding w/ V Groove	1 x 8	8' - 16'

Eastern White Pine Rough Sawn

Available in 2' increments. Some sizes subject to availability.

Part#	Description	Size	Lengths
L110**RS	EWP S1S RS Siding	1 x 10	8' - 16'
L112**RS	EWP S1S RS Siding	1 x 12	8' - 16'

#2 White Pine

Part#	Description	Size	Lengths
L14***	#2 White Pine Board	1 x 4	8', 10', 12', and 16'
L16**	#2 White Pine Board	1 x 6	6', 8', 10', 12', and 16'
L18**	#2 White Pine Board	1 x 8	12' and 16'
L110**	#2 White Pine Board	1 x 10	12' and 16'
L112**	#2 White Pine Board	1 x 12	12' and 16'

Rough Cut

Available in 2' increments

Part#	Description	Size	Length
LYP1416	Southern Yellow Pine Rough Cut	1 x 4	16'
L1416RCSP	Spruce Rough Cut	1 x 4	16'



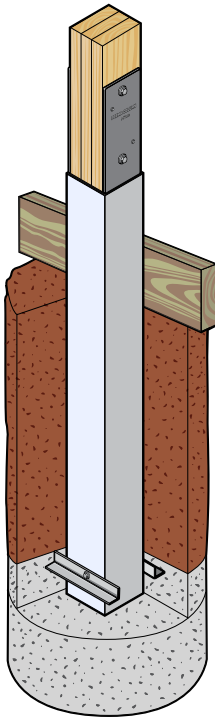

SHOWN WITH UPLIFT HARDWARE
(SOLD SEPARATELY)

Glue Laminated SYP Posts

Available in 2' increments • Southern Yellow Pine.

Part#	Description	Size	Lengths
LGL6**	3-ply Glu-Lam Post - w/ Bottom 6' Treated	2 x 6	12' - 32'
LGL8**	3-ply Glu-Lam Post - w/ Bottom 6' Treated	2 x 8	16' - 32'
LGL46**	4-ply Glu-Lam Post - w/ Bottom 6' Treated	2 x 6	14' - 32'
LGL48**	4-ply Glu-Lam Post - w/ Bottom 6' Treated	2 x 8	16' x 40'
LGLFT**	3-ply and 4-ply Glu-Lam Post - Fully Treated	*	8' - 40'

Many 2-ply, 4-ply, and 5-ply Glu-lams also available for special order in many lengths

The Green Post - Special Order

The most affordable In-Ground Solution to Post Decay. Provides superior protection from the harmful effects of concrete, rot & decay, corrosive soils agents, soil nutrients, moisture, and oxygen. Available in 2' increments • Southern Yellow Pine with bottom 6' treated

Part#	Description	Size	Lengths
LGLPS6**	Green Post - 3-ply Glu-Lam	2 x 6	14' - 28'
LTPS46**	Green Post - Fully Treated	4 x 6	12' - 18'
LTPS6616	Green Post - Fully Treated	6 x 6	16'

Many 3-ply, 4-ply, and 5-ply Green Posts also available for special order in many lengths

Treated Solid Sawn Post

Part#	Description	Size	Length
LT44**	Treated Post - .14 Ground Contact	4 x 4	8', 10', 12', & 16'
LT46**	Treated Post - C.C.A. .60	4 x 6	8' - 20'
LT66**	Treated Post - C.C.A. .60	6 x 6	8' - 20', & 24'
LT88**	Treated Post C.C.A. .60	8 x 8	12, 16

Perma Column

Perma-Column® outperforms treated wood – guaranteed. Insist on the environmentally friendly solution that will outlast a treated wood foundation every time. Only Perma-Column® precast concrete columns provide your building a foundation engineered to last for generations to come. Perma-Column® is 3x stronger than concrete. Perma-Column® piers are precast concrete, reinforced with 60,000 psi rebar welded to a ¼" steel bracket. Perma-Column® is the unmatched post-frame foundation solution for homes and municipal, commercial, and agricultural buildings. Perma-Column® protects the value of your building. Post-frame construction materials have come a long way. Your building deserves the lasting durability of a permanent foundation. Perma-Column® is engineered to protect the structural integrity of your post-frame building and is backed by a lifetime warranty.

Part#	Description	W/Hardware	Post Size	Column Size
LPC36	Perma-Column	•	3 Ply 2 x 6	5'
LPC38	Perma-Column	•	3 Ply 2 x 8	5'
LPC46	Perma-Column	•	4 Ply 2 x 6	5'
LPC46S	Perma-Column	•	4 x 6	5'
LPC48	Perma-Column	•	4 Ply 2 x 8	5'
LPC58	Perma-Column	•	5 Ply 2 x 8	5'
LPC66	Perma-Column	•	6 x 6	5'
LPC44S	Perma-Column Deck Post Base		4 x 4	40"
LPC66S	Perma-Column Deck Post Base		6 x 6	40"



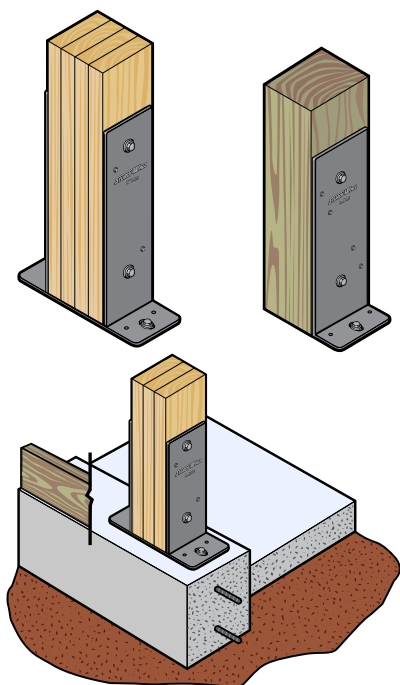

Sturdi-Wall Drill Set Bracket

Useful in situations where concrete foundation has already been poured. Reduces placement errors when a concrete subcontractor is used. Tools required: hammer drill, masonry bit, and concrete fasteners

Part#	Description	W/Hardware	Post Size
LPCSW46	Sturdi-Wall Drill Set Bracket	•	4 x 6
LPCSW63	Sturdi-Wall Drill Set Bracket	•	3 Ply 2 x 6
LPCSW66P	Sturdi-Wall Drill Set Bracket	•	4 Ply 2 x 6 & 6 x 6
LPCSW83	Sturdi-Wall Drill Set Bracket	•	3 Ply 2 x 8
LPCSW84	Sturdi-Wall Drill Set Bracket	•	4 Ply 2 x 8
LPCSW6L	Drill Set Universal Angle Bracket - 5" x 13"		
LPCSW6LCORNER	Drill Set Corner Angle Bracket - 4" x 13"		
LPCSW8L	Drill Set Universal Angle Bracket - 7" x 18"		
LPCSW60FLATS	6000 Series Flat End Wall Bracket - 5" x 30-5/8"		
LPCSW80FLATS	8000 Series Flat End Wall Bracket - 7" x 40-5/8"		

Sturdi-Wall Wet Set Bracket

Provides the highest ultimate strength connection to your foundation, but requires installation of the bracket with the attached 18" rebar while concrete is still wet. Avoids time-consuming drilling with a masonry bit and expensive concrete anchors. Sturdi-Wall® Plus brackets require less concrete coverage than normal Sturdi-Walls, allowing them to work well in pier foundations.

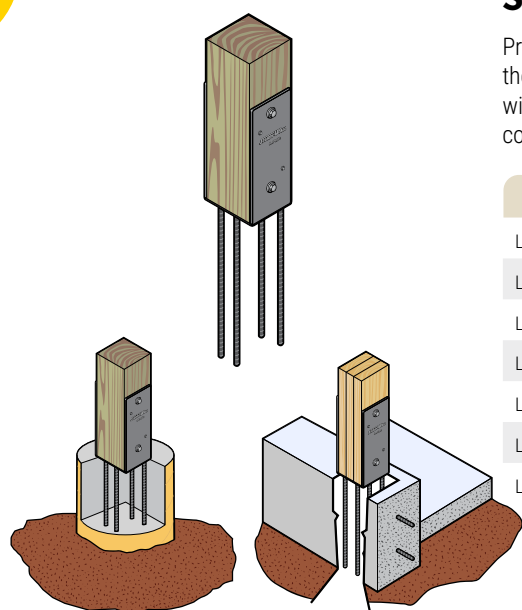

Part#	Description	W/Hardware	Post Size
LPCSWP46	Sturdi-Wall Wet Set Bracket	•	4 x 6
LPCSWP63	Sturdi-Wall Wet Set Bracket	•	3 Ply 2 x 6
LPCSWP64	Sturdi-Wall Wet Set Bracket	•	4 Ply 2 x 6
LPCSWP66	Sturdi-Wall Wet Set Bracket	•	6 x 6
LPCSWP83	Sturdi-Wall Wet Set Bracket	•	3 Ply 2 x 8
LPCSWP84	Sturdi-Wall Wet Set Bracket	•	4 Ply 2 x 8
LPCSWP85	Sturdi-Wall Wet Set Bracket	•	5 Ply 2 x 8

Perma Column Hardware



Part#	Description	Series
LPC6U	Perma-Column- Uplift Hardware	4000/6000
LPC8U	Perma-Column- Uplift Hardware	8000
LPCDA	2-1/2" Hot Dipped Galvanized Masonry Nail Anchors - to fasten skirt board to Perma-Column - 100 count bag	
LPCFP ¹²	12" Composite Footing Pad for Posts And Perma Column	
LPCFP ²⁰	20" Composite Footing Pad for Posts And Perma Column	
LPCFP ²⁴	24" Composite Footing Pad for Posts And Perma Column	



Yellow Pine Stair Treads

- Rounded one side

Part#	Description	Size
LYPTRE12	Yellow Pine Treads	5/4 x 12 x 12'
LYPTRE16	Yellow Pine Treads	5/4 x 12 x 16'



Treated Yellow Pine Deck Boards

Rounded edges. Available in 2' increments

Part#	Description	Size	Lengths
LT546**	Standard Treated Yellow Pine	5/4 x 6	8' - 16'
LT546**1	Premium Treated Yellow Pine	5/4 x 6	12', 16', & 20'



Treated Stair Stringer

Part#	Description	Size
LTSS3	3-Step Treated Stair Stringer	2 x 12
LTSS4	4-Step Treated Stair Stringer	2 x 12



Treated Wood Balusters

Part#	Description	Size
LT2242	Treated Wood Balusters - Tapered 1 End	2 x 2 x 42"



T1-11 Siding

Part#	Description	Size	Thickness
LT111	SO T1 11 Yellow Pine Plywood Siding	4' x 8'	5/8



LP SmartSide Siding

LP® SmartSide® Trim & Siding products are treated with our proprietary SmartGuard® process. With four components of protection, the process adds strength and helps our products withstand impacts, freeze/thaw cycles, high humidity and fungal decay.

Part#	Description	Size	Thickness
LSS48	LP SmartSide Siding 8" On Center Primed Cedar Texture	4' x 8'	3/8
LSST1416	LP SmartSide Trim Board - Primed Cedar Texture	4' x 16'	1"



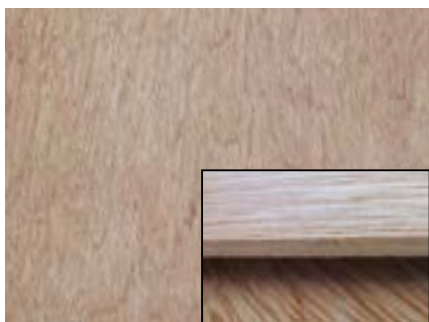

Luan Plywood

Part#	Description	Size	Thickness
L14P	Luan Plywood	4' x 8'	1/4



CDX GRADE

Yellow Pine Plywood

Part#	Description	Size	Thickness
L124P	4-ply Yellow Pine Plywood CDX	4' x 8'	1/2
L38P	Yellow Pine Plywood CDX	4' x 8'	3/8
L58P	Yellow Pine Plywood CDX	4' x 8'	5/8
L34P	Yellow Pine Plywood CDX	4' x 8'	3/4
L12PBC	Yellow Pine Plywood BC (sanded one side)	4' x 8'	1/2
L34PBC	Yellow Pine Plywood BC (sanded one side)	4' x 8'	3/4
L58TG	Tongue & Groove Yellow Pine Plywood UL	4' x 8'	5/8
L34TG	Tongue & Groove Yellow Pine Plywood UL	4' x 8'	3/4



BC GRADE



Fir Plywood

Part#	Description	Size	Thickness
L34PTGF	Tongue & Groove Fir Plywood UL	4' x 8'	3/4
L124PFT	Fire-Treated Plywood	4' x 8'	1/2



Treated Plywood

Part#	Description	Size	Thickness
L12PT	Treated Plywood 0.14GC	4' x 8'	1/2
L58PT	Treated Plywood 0.14GC	4' x 8'	5/8
L34PT	Treated Plywood 0.14GC	4' x 8'	3/4



OSB

Part#	Description	Size	Thickness
L7160	OSB	4' x 8'	7/16
L71609	OSB	4' x 9'	7/16
L120	OSB	4' x 8'	1/2
L580	OSB	4' x 8'	5/8
L340	OSB Tongue & Groove	4' x 8'	3/4



Top Notch 350 Tongue and Groove OSB

Part#	Description	Size	Thickness
L340G	Top Notch T&G OSB	4' x 8'	3/4

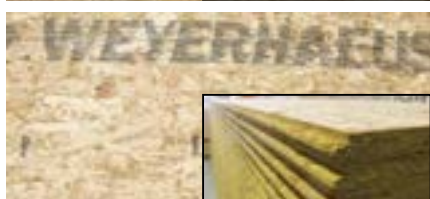

Gold Edge Tongue and Groove OSB

Part#	Description	Size	Thickness
L340TGGOLD	Gold Edge T&G OSB	4' x 8'	3/4

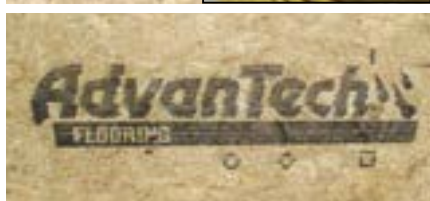

AdvanTech Tongue and Groove OSB

Part#	Description	Size	Thickness
L340A	AdvanTech T&G OSB	4' x 8'	3/4



Zip System OSB

Part#	Description	Size	Thickness
L120Z	Zip System OSB	4' x 8'	1/2
L580Z	Zip System OSB	4' x 8'	5/8



ZIP System Huber Stretch Tape

Part#	Description	Size
TAPEZIPS	Huber Zip Stretch Tape	6" x 75'



Huber ZIP System™ Flashing Tape Roller

"Z" impression on tape provides visual indicator of where tape has been rolled.



Part#	Description	Size	Covers
TAPEZIPR	Huber ZIP System Flashing Tape Roller	42" X 286'	10 sq.





Standard Truss (in-stock)

Designed to be installed 4' on center

110 MPH wind load and 30-5-5 pound load rating with no deductions

Other custom order trusses are available with varying lead times

Part#	Description	Pitch	Length
TRU16	Standard Truss - 4' O/C - 10-1/2" T/C - 0/H	4/12	16'
TRU20	Standard Truss - 4' O/C - 10-1/2" T/C - 0/H	4/12	20'
TRU24	Standard Truss - 4' O/C - 10-1/2" T/C - 0/H	4/12	24'
TRU26	Standard Truss - 4' O/C - 10-1/2" T/C - 0/H	4/12	26'
TRU28	Standard Truss - 4' O/C - 10-1/2" T/C - 0/H	4/12	28'
TRU30	Standard Truss - 4' O/C - 10-1/2" T/C - 0/H	4/12	30'
TRU32	Standard Truss - 4' O/C - 10-1/2" T/C - 0/H	4/12	32'
TRU36	Standard Truss - 4' O/C - 10-1/2" T/C - 0/H	4/12	36'
TRU40	Standard Truss - 4' O/C - 10-1/2" T/C - 0/H	4/12	40'
TRU50	Standard Truss - 4' O/C - 10-1/2" T/C - 0/H	3.75/12	50'
TRUS0	Special Order Truss		
TRU30G	Standard Truss - Gable	4/12	30'
TRU40G	Standard Truss - Gable	4/12	40'
TRU50G	Standard Truss - Gable	3.75/12	50'

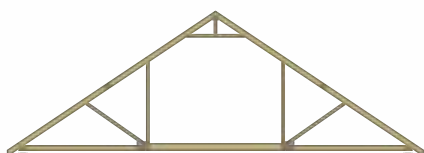

Attic Truss

Part#	Description
TRUS0	Special Order Truss

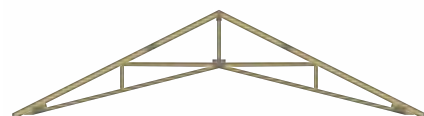

Scissors Truss

Part#	Description
TRUS0	Special Order Truss

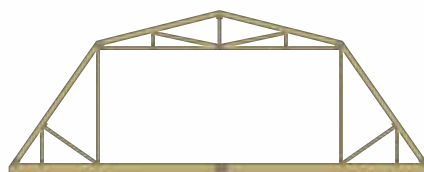

Gambrel Truss

Part#	Description
TRUS0	Special Order Truss

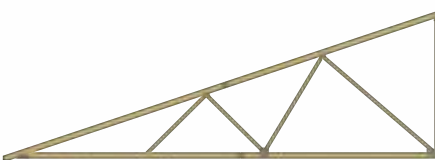

Mono Truss

Part#	Description
TRUS0	Special Order Truss

Joist Hangers and Ties

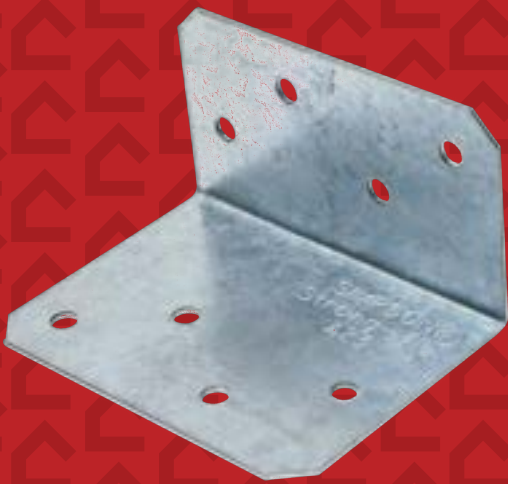

SIMPSON

Strong-Tie

Outdoor Accents[®]

**Timeless Beauty.
Tested Strength.**





JHAPA21

JHAPA4

JHAPA6

Outdoor Accents® Angles

90 Degree Angle Zmax Textured Powder Coated Flat Black.

Part#	Description	Length	Width ¹	Width ²	Gauge	Pk. Size	Case Qty
JHAPA21	Light Rafter Tie 2X	1 3/8"	2"	1 1/2"	14	Ea.	90
JHAPA4	Heavy Angle 4X	3"	3 1/4"	3"	12	Ea.	12
JHAPA6	Heavy Angle 6X	5"	3 1/4"	3 1/2"	12	Ea.	12



JHAPB44

JHAPB66

Outdoor Accents® Post Bases

12 gauge. Zmax Textured Powder Coated Flat Black.

Part#	Description	Length	Width	Height	Pack Size	Case Qty
JHAPB44	4X4 Post Base	3"	3 9/16"	7"	Ea.	8
JHAPB66	6X6 Post Base	5"	5 1/2"	7 1/2"	Ea.	6



Outdoor Accents® Deck Joists

12 gauge. Zmax Textured Powder Coated Flat Black.

Part#	Description	Joist Width	Width	Height	Pack Size	Case Qty
JHAPDJT1.75-4	Deck Joist Tie	1 3/4"	3"	9 3/4"	Ea.	24
JHAPDJT1.75-6	Deck Joist Tie	1 3/4"	5"	8 1/4"	Ea.	12
JHAPDJT2-4	2X Deck Joist Tie	1 1/2"	3"	10"	Ea.	24
JHAPDJT2-6	2X Deck Joist Tie	1 1/2"	5"	8 1/2"	Ea.	12
JHAPDJT2R-6	2X Deck Joist Tie - For rough cut lumber	2"	5"	8"	Ea.	12



JHAPDMW56

STN22-R8

Outdoor Accents® Decorative Washers

When combined with structural wood screws, these decorative washers deliver increased strength with the decorative appeal of a bolted connection.

Part#	Description	Width	Hole Dia.	Gauge	Pk. Size	Case Qty
JHAPDMW56	Decorative Mission Washer Zmax Textured Powder Coated Flat Black	3"	9/16"	12	Ea.	24
STN22-R8	Hex-Head Washer Powder Coated Black 8pc				Ea.	10





JHAPL4



JHAPL⁶



JHAPT4



JHAPT⁶

Outdoor Accents® Beam-to-Column Ties

12 gauge. Zmax Textured Powder Coated Flat Black.

Part#	Description	Length	Width	Height	Pack Size	Case Qty
JHAPL4	4X L Strap	8 1/4"	3"	8 1/4"	Ea.	8
JHAPL6	6X L Strap	10 1/2"	5"	10 1/2"	Ea.	8
JHAPT4	4X T Strap	13 1/2"	3"	8 1/4"	Ea.	8
JHAPT6	6X T Strap	16"	5"	10 1/2"	Ea.	8



JHAPLH24



JHAPLH26



JHAPLH210

Outdoor Accents® Joist Hangers

14 gauge. Textured Powder Coated Flat Black.

Part#	Description	Width	Height	Board	Pk. Size	Case Qty
JHAPLH24	2 x 4 Concealed Face Mount	1 9/16"	5 3/16"	1 7/8"	Ea.	12
JHAPLH26	2 x 6 Concealed Face Mount	1 9/16"	5 1/8"	1 7/8"	Ea.	24
JHAPLH210	2 x 10 Concealed Face Mount	1 9/16"	8"	1 7/8"	Ea.	12



SD10112DBBR50



SDWS22312*



SDWS22512DBBRC¹²

Outdoor Accents® Wood Screws

When combined with the Outdoor Accents hex-head washers, these structural wood screws deliver increased strength and the decorative appeal of a bolted connection with the installation ease of a screw.

Part#	Description	Size	Pack Size	Case Qty
SD10112DBBR50	Connector Wood Screw Black 50pc	#10 x 1 1/2"	50pc	5
SDWS22312DBB-R50	Structural Wood Screw Black 50pc	3 1/2"	50pc	6
SDWS22312DBBRC12	Structural Wood Screw Black 12pc	3 1/2"	12pc	10
SDWS22512DBBRC12	Structural Wood Screw Black ¹² pc	5 1/2"	12pc	10

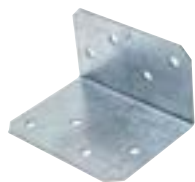

ANGLE



FRAMING ANGLE

Angles

Part#	Vendor#	Description	Size	Pack Size	Case Qty
JHA21Z	A21Z	Angle Zmax	2" x 1"	Ea.	200
JHA23Z	A23Z	Angle Zmax	2" x 1-1/2"	Ea.	200
JHA24Z	A24Z	Angle Zmax	2" X 3-7/8"	Ea.	25
JHA33	A33	Angle Simpson	3" X 3"	Ea.	25
JHA35Z	A35Z	Framing Angle Zmax		Ea.	100
JHA44	A44	Angle	4-9/16" X 4-3/8"	Ea.	25

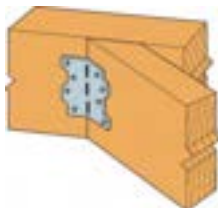

Light Skewable Angle

Part#	Vendor#	Description	Size	Pk. Size	Case Qty
JHLS50Z	LS50Z	Light Skewable Reinforcing Angle Zmax	4-7/8" long	Ea.	50
JHLS70Z	LS70Z	Light Skewable Reinforcing Angle Zmax	6-3/8" long for 2x8	Ea.	25
JHLS90Z	LS90Z	Light Skewable Angle Zmax	9" long for 2x10	Ea.	50



L-Angle

Part#	Vendor#	Description	Size	Pk. Size	Case Qty
JHL50Z	L50Z	L- Angle Zmax	5" long for 2x6	Ea.	100
JHL70Z	L70Z	L- Angle Zmax	7" long for 2x8	Ea.	50
JHL90Z	L90Z	L- Angle Zmax	9" long for 2x10	Ea.	50

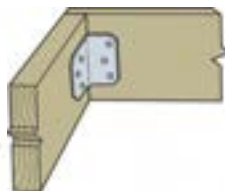

Medium L-Angle

Part#	Vendor#	Description	Size	Pack Size	Case Qty
JHML24Z	ML24Z	Medium L-Angle Zmax	2" x 4"	Ea.	15
JHML26Z	ML26Z	Medium L- Angle Zmax	2" x 6"	Ea.	15

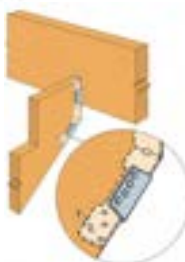

Adjustable Stair Stringer Connector

Part#	Vendor#	Description	Pack Size	Case Qty
JHLS CZ	LSCZ	Adjustable Stair Stringer Connector Zmax	Ea.	25



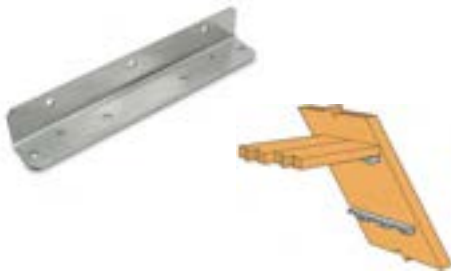

Tread Angle

For use in structurally sound staircase framing. Eliminates costly conventional notching.

Part#	Vendor#	Description	Size	Pack Size	Case Qty
JHTA10Z-R	TA10Z-R	Tread Angle Zmax	10"	Ea.	20



Deck Ties

Part#	Vendor#	Description	Size	Pk. Size	Case Qty
JHDJT14Z	DJT14Z	Deck Joist Tie one Zmax	2x to 4x or larger	Ea.	25
JHDTT1Z	DTT1Z	Deck Tension Tie Zmax		Ea.	40
SDWH27800GMB		Exterior HDG Structural Timber-Hex Screw - for use with JHDTT1Z	.270 x 8"	Ea.	150
JHDTT1Z-KT	DTT1Z-KT	Deck Tension Tie with 8" SDWH Timber-Hex HDG Screw and #9x1-1/2" SD Connector Screws Zmax		1 Kit	4
JHDTT2Z	DTT2Z	Deck Tension Tie with 1.5" SDS screws Zmax - Through bolt		Ea.	20
JHDTT2Z-SDS2.5	DTT2Z-SDS2.5	Deck Tension Tie with 2.5" SDS screws Zmax - Through bolt		Ea.	20



Hurricane Ties

Simpson Strong-Tie hurricane ties provide a positive connection between truss/rafter and the wall of the structure to resist wind and seismic forces.

Part#	Vendor#	Description	Pack Size	Case Qty
JHH1	H1	Hurricane Tie - up to 400 lbs. allowable uplift in SPF	Ea.	100
JHH10A	H10A	Hurricane Tie - up to 1015 lbs. allowable uplift in SPF	Ea.	50
JHH10S	H10S	Hurricane Tie on Stud 870 lbs. uplift	Ea.	25
JHH16	H16	Hurricane Tie pre-sloped 5/12	Ea.	10
JHH2.5A	H2.5A	Hurricane Tie 535 lb allowable uplift when installed in SPF with (10) 8d nails	Ea.	100
JHH2.5AZ	H2.5AZ	Hurricane Tie 535 lb allowable uplift when installed in SPF with (10) 8d nails Zmax	Ea.	100
JHH2.5T	H2.5T	Hurricane Tie 545 lb allowable uplift when installed in SPF with (10) 8d nails	Ea.	100
JHH3	H3	Hurricane Tie Each 320 lbs. Uplift	Ea.	100
JHH8	H8	Hurricane Tie - up to 565 lbs. allowable uplift in SPF	Ea.	100

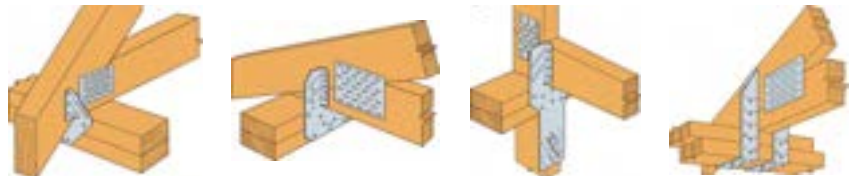
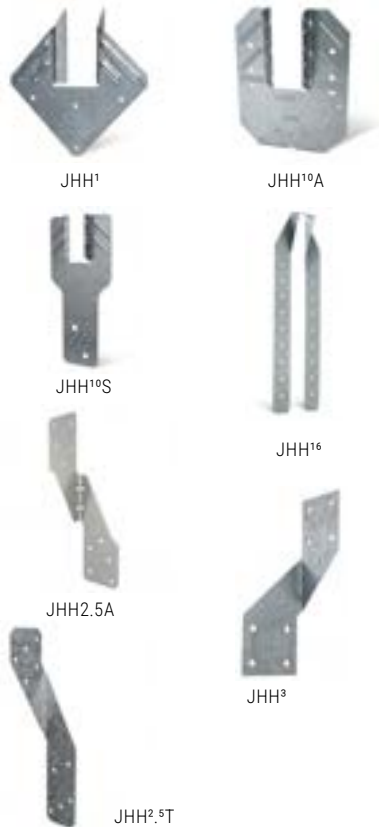



Hurricane Tie Kit

Part#	Vendor#	Description	Pack Size	Case Qty
JHHGA10KT	HGA10KT	Hurricane Tie Kit of 10 angles with screws	Ea.	6
JHHGAM10KTA	HGAM10KTA	Hurricane Tie Kit of 10 angles for masonry	Ea.	6



Coil Wall Bracing

Offers effective options to resist racking during construction. Sold by the roll.

Part#	Vendor#	Description	Size	Pack Size
JHWB126C	WB126C	Coil Wall Bracing	11' 4-3/4" per coil	1 Roll



Wall Brace Coiled Metal Strap

This utility strap comes on one continuous coil which can be cut to length on the jobsite.

Part#	Vendor#	Description	Size
JHCS20	CS20	Simpson Wall Brace Coiled Metal Strap - 20ga	250'



Insulation Support

Cut from carbon steel spring wire for optimum flexibility and strength.

Part#	Vendor#	Description	Size	Pack Size	Case Qty
JHIS16	IS16-R100	Insulation Support	16" on center	100	15
JHIS24	IS24-R100	Insulation Support	24" on center	100	10



JHABA**



JHABW**



Adjustable Post Base

Part#	Vendor#	Description	Size	Pack Size	Case Qty
JHABA44Z	ABA44Z	Adjustable Post Base Zmax	4x4	Ea.	20
JHABA46Z	ABA46Z	Adjustable Post Base Zmax	4x6	Ea.	10
JHABA66Z	ABA66Z	Adjustable Post Base Zmax	6x6	Ea.	10
JHABW44Z	ABW44Z	Adjustable Post Base with Washer Zmax	4x4	Ea.	10
JHABW66Z	ABW66Z	Adjustable Post Base with Washer Zmax	6x6	Ea.	10





Base/Caps

Part#	Vendor#	Description	Size	Pk. Size	Case Qty
JHBC40Z	BC40Z	Base/Cap Zmax	4X	Ea.	50
JHBC60Z	BC60Z	Base/Cap Zmax	6X	Ea.	10
JHBC6Z	BC6Z	Post Cap Connectors - To Larger Base	6"	Ea.	10
JHBCS2-2/4Z	BCS2-2/4Z	Base/Cap For Double 2X Zmax	2x over 4x	Ea.	20
JHBCS2-3/6Z	BCS2-3/6Z	Base/Cap For Triple 2X Zmax	2x over 6x	Ea.	10



Standoff Post Base

Part#	Vendor#	Description	Size	Pk. Size	Case Qty
JHCPS4	CPS4	Composite Plastic Standoff Post Base	4x4	Ea.	25
JHCPS5	CPS5	Composite Plastic Standoff Post Base	5x5	Ea.	25
JHCPS6	CPS6	Composite Plastic Standoff Post Base	6x6	Ea.	25

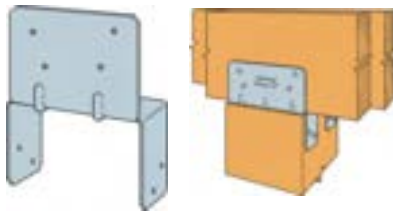

Light Post Cap

Part#	Vendor#	Description	Pk. Size	Case Qty
JHLPC4Z	LPC4Z	Light Post Cap Adjustable for 4x Post Zmax	Ea.	40
JHLPC6Z	LPC6Z	Light Post Cap Adjustable for 6x Post Zmax	Ea.	40



Retrofit Post Base

Part#	Vendor#	Description	Size	Pack Size	Case Qty
JHRPBZ	RPBZ	Retrofit Post Base Zmax	For 4x or 6x Post	Ea.	12



Vertical Hold Downs

To tie post to footer or wall to foundation. Can be used vertically or horizontally.

Part#	Vendor#	Description	Size	Pk. Size	Case Qty
JHHDU2-SDS2.5	HDU2-SDS2.5	Predeflected Vertical Hold Downs w/ Screws	8-11/16"	Ea.	20
JHHDU4-SDS2.5	HDU4-SDS2.5	Predeflected Vertical Hold Downs w/ Screws	10-15/16"	Ea.	15
JHHDU5-SDS2.5	HDU5-SDS2.5	Predeflected Vertical Hold Downs w/ Screws	13-3/16"	Ea.	15

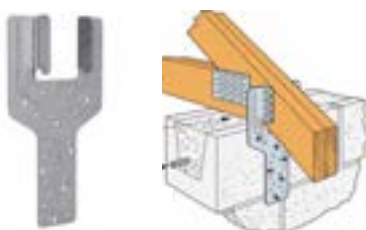

Light Girder Tiedown

Provides a low profile connection to the wall for easy installation of drywall.

Part#	Vendor#	Description	Pack Size	Case Qty
JHLGT2	LGT2	Light Girder Tiedown for 2 ply	Ea.	10



Top Mount Single Hanger

Can weld to steel

Part#	Vendor#	Description	Size	Pk. Size	Case Qty
JHLB210AZ	LB210AZ	Top Mount Single Hanger Zmax	2x10	Ea.	25
JHLB212AZ	LB212AZ	Top Mount Single Hanger Zmax	2x12	Ea.	25

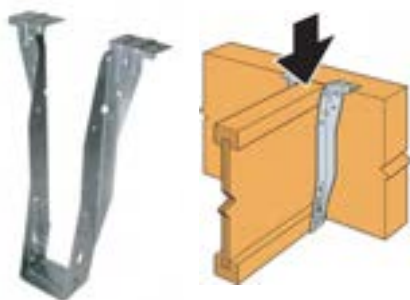

Top Flange I Joist Hanger

Installs faster and uses fewer nails than other engineered wood product top-flange hangers.

Part#	Vendor#	Description	Pk. Size	Case Qty
JHITS2.56/11.88	ITS2.56/11.88	Top Flange I Joist Hanger	Ea.	25
JHITS2.56/14	ITS2.56/14	Top Flange I Joist Hanger	Ea.	25
JHITS2.56/9.5	ITS2.56/9.5	Top Flange I Joist Hanger	Ea.	25

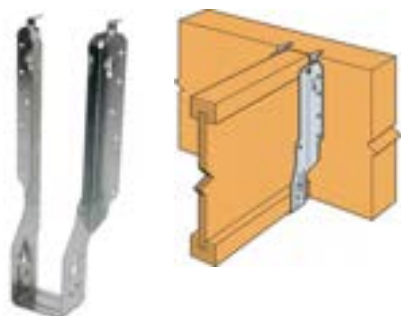

Face Mount I Joist Hanger

A hybrid hanger that incorporates the advantages of the face-mount and top-mount hanger.

Part#	Vendor#	Description	Pk. Size	Case Qty
JHIUS2.56/11.88	IUS2.56/11.88	Face Mount I Joist Hanger	Ea.	25
JHIUS2.56/14	IUS2.56/14	Face Mount I Joist Hanger	Ea.	25
JHIUS2.56/9.5	IUS2.56/9.5	Face Mount I Joist Hanger	Ea.	25



Skewable Jack Hanger

Part#	Vendor#	Description	Size	Pk. Size	Case Qty
JHLSSR210	LSSR210Z	Light Slopeable/Skewable Hanger	2x10	Ea.	25
JHLSSJ210LZ	LSSJ210LZ	Light Adjustable Slopeable Left Zmax	2x10	Ea.	25
JHLSSJ210RZ	LSSJ210RZ	Light Adjustable Slopeable Right Zmax	2x10	Ea.	25
JHLSSR210Z	LSSR210Z	Light Slopeable/Skewable Hanger Zmax	2x10	Ea.	20
JHLSSR28Z	LSSR28Z	Light Slopeable/Skewable Hanger Zmax	2x8	Ea.	25
JHLSSJ26LZ	LSSJ26LZ	Light Adjustable Slopeable Left Zmax	2x6	Ea.	25
JHLSSJ26RZ	LSSJ26RZ	Light Adjustable Slopeable Right Zmax	2x6	Ea.	25

JHLSSJ**

JHLSSR28Z

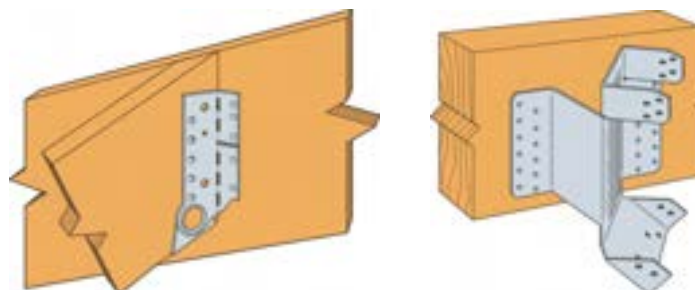



JHSUL**



Skewed Hanger

Skewed 45 degrees left or right.

Part#	Vendor#	Description	Size	Pk. Size	Case Qty
JHSUL210Z	SUL210Z	Skewed Left 2x10 Hanger Zmax	2x10	Ea.	10
JHSUL26Z	SUL26Z	Skewed Left Hanger Zmax	2x6	Ea.	10
JHSUR210Z	SUR210Z	Skewed Right Hanger Zmax	2x10	Ea.	10
JHSUR26Z	SUR26Z	Skewed Right Hanger Zmax	2x6	Ea.	10

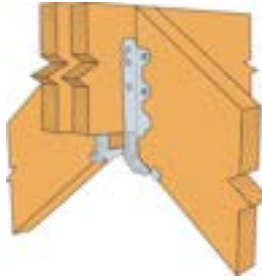

Light Retro Fit U Hanger

Part#	Vendor#	Description	Size	Pk. Size	Case Qty
JHLRU210Z	LRU210Z	Light Retro Fit U Hanger Slopeable Zmax	2x10	Ea.	25
JHLRU26Z	LRU26Z	Light Retro Fit U Hanger Slopeable Zmax	2x6	Ea.	25
JHLRU28Z	LRU28Z	Light Retro Fit U Hanger Slopeable Zmax	2x8	Ea.	25



Concealed Hanger

Part#	Vendor#	Description	Size	Pk. Size	Case Qty
JHHUC210-2Z	HUC210-2Z	Concealed Hanger for Double 2X10 Zmax	2x10	Ea.	25
JHHUC28-2Z	HUC28-2Z	Concealed Hanger for Double 2X8 Zmax	2x8	Ea.	25
JHLUC210Z	LUC210Z	Concealed Hanger Zmax	2x10	Ea.	25
JHLUC26Z	LUC26Z	Concealed Hanger Zmax	2x6 or 2x8	Ea.	25



JHLUS210-2Z

JHLUS210-3Z



JHLUS210Z



JHLUS24Z

Face Mount Hanger

Part#	Vendor#	Description	Size	Pk. Size	Case Qty
JHHUS410	HHUS410	Face Mount Double LVL Hanger	9 1/2" to 14"	Ea.	25
JHHUS5.50/10	HHUS5.50/10	Face Mount Triple LVL Hanger	5-1/2" x 9"	Ea.	25
JHHUS1.81/10	HUS1.81/10	Face Mount Single LVL Hanger	9 1/2" to 14"	Ea.	25
JHHUS26	HUS26	Face Mount Single Truss Hanger	2x6	Ea.	50
JHLUS210-2Z	LUS210-2Z	Face Mount Double Hanger Zmax	2x10 or 2x12	Ea.	25
JHLUS210-3Z	LUS210-3Z	Face Mount Triple Hanger Zmax	2x10	Ea.	25
JHLUS210Z	LUS210Z	Face Mount Single Hanger Zmax	2x10 to 2x14	Ea.	50
JHLUS24Z	LUS24Z	Face Mount Single Hanger Zmax	2x4	Ea.	100
JHLUS26-2Z	LUS26-2Z	Face Mount Double Hanger Zmax	2x6	Ea.	25
JHLUS26Z	LUS26Z	Face Mount Single Hanger Zmax	2x6	Ea.	100
JHLUS28-2Z	LUS28-2Z	Face Mount Double Hanger Zmax	2x8	Ea.	25
JHLUS28-3Z	LUS28-3Z	Face Mount Triple Hanger Zmax	2x8	Ea.	15
JHLUS28Z	LUS28Z	Face Mount Single Hanger Zmax	2x8	Ea.	50

Mending Plate

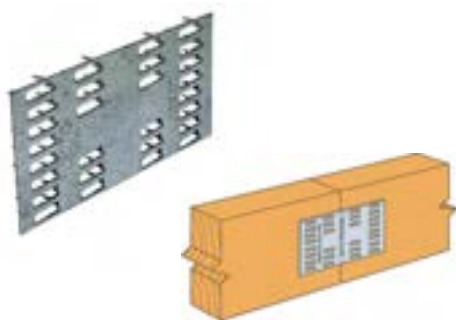

Part#	Vendor#	Description	Size	Pack Size	Case Qty
JHMP24	MP24	Mending Plate	2 X 4	Ea.	100
JHMP36	MP36	Mending Plate	3 X 6	Ea.	100

Tie Plate

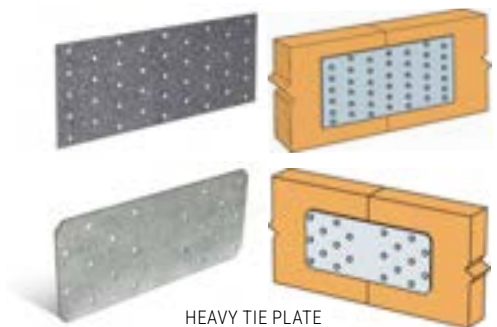

HEAVY TIE PLATE

Part#	Vendor#	Description	Size	Pack Size	Case Qty
JHTP15	TP15	Tie Plate	1-3/16" x 5"	Ea.	150
JHTP35	TP35	Tie Plate	3x5	Ea.	100
JHTP47	TP47	Tie Plate	4x7	Ea.	150
JHHTP37Z	HTP37Z	Heavy Tie Plate Zmax	3 x 7	Ea.	25

Lateral Tie Plate

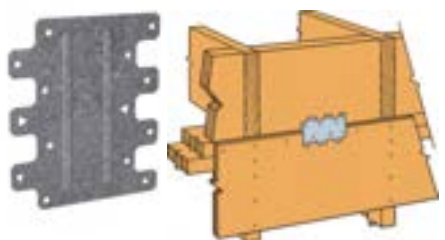

Part#	Vendor#	Description	Size	Pack Size	Case Qty
JHLTP4Z	LTP4Z	Lateral Tie Plate	3" X 4 1/4"	Ea.	200

H Clips for Plywood

Used to brace unsupported sheathing edges and provide a 1/8" gap to address shrinkage and expansion of roof sheathing.

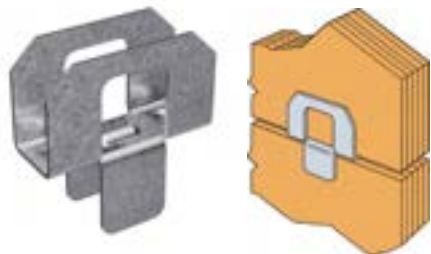

Part#	Vendor#	Description	Size	Pack Size	Case Qty
JHPSC1/2	PSCL 1/2	H Clips For Plywood	1/2"	Ea.	250
JHPSC15/32	PSC;L 15/32	H Clips For Plywood	15/32"	Ea.	250
JHPSC3/4	PSCL 3/4	H Clips For Plywood	3/4"	Ea.	250
JHPSC5/8	PSCL 5/8	H Clips For Plywood or OSB	5/8"	Ea.	250
JHPSC7/16	PSCL 7/16	H Clips For Plywood	7/16"	Ea.	250

Truss Spacer



JHTSBR2-24

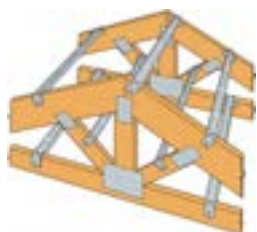

Part#	Vendor#	Description	Size	Pk. Size	Case Qty
JHTSBR2-24	TSBR2-24	Truss Spacer Restraint For 24" Spacing		Ea.	50
JHTSF2-24	TSF2-24	Truss Spacer for 24" Spacing	10'	Ea.	20



JHTSF2-24

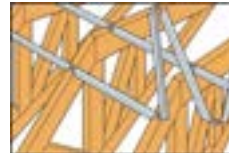

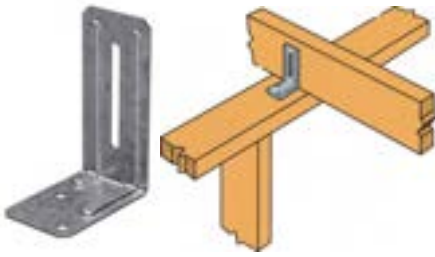

Single Roof Truss Clip

For alignment control between a roof truss and nonbearing walls.

Part#	Vendor#	Description	Pack Size	Case Qty
JHSTC	STC	Single Roof Truss Clip	Ea.	200

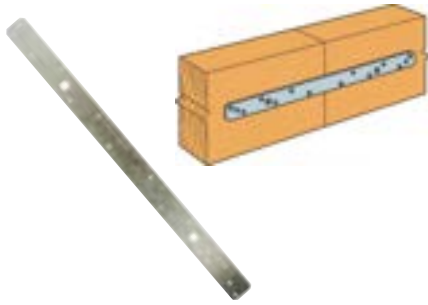

Strap Tie (Medium)

Part#	Vendor#	Description	Size	Pk. Size	Case Qty
JHMSTA18Z	MSTA18Z	Simpson Strap Tie (Tension Load 1130 lbs.) Zmax	18"	Ea.	50
JHMSTA36Z	MSTA36Z	Simpson Strap Tie (Tension Load 2050 lbs.) Zmax	36"	Ea.	50
JHMSTC28	MSTC28	Simpson Strap Tie (Tension Load 2980 lbs.)	28"	Ea.	10

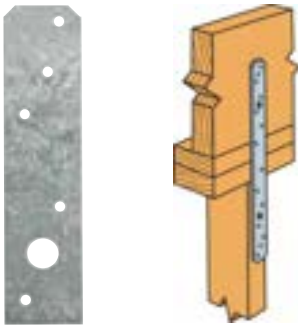

Strap Tie (Light)

Part#	Vendor#	Description	Size	Pk. Size	Case Qty
JHLSTA18	LSTA18	Simpson Strap Tie (Tension Load 1110 lbs.)	18"	Ea.	50
JHLSTA24	LSTA24	Simpson Strap Tie (Tension Load 1235 lbs.)	24"	Ea.	50
JHLSTA30	LSTA30	Simpson Strap Tie (Tension Load 1640 lbs.)	30"	Ea.	50
JHLSTA36	LSTA36	Simpson Strap Tie (Tension Load 1640 lbs.)	36"	Ea.	50

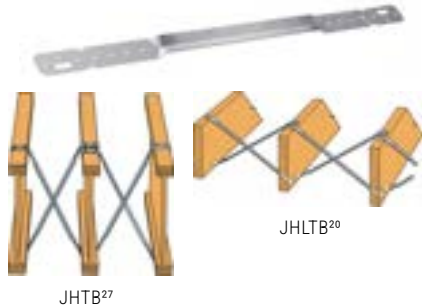

Tension Bridging

JHTB27 has maximum nailing flexibility - just use two of the seven nail holes at each end. JHLTB20 has a staggered nail pattern to accommodate 2x8 and 2x10 joists.

Part#	Vendor#	Description	Size	Pk. Size	Case Qty
JHTB27	TB27	Tension Bridging for 2x12, or I joist	For 2x12	Ea.	50
JHLTB20	LTB20	Light Tension Bridging	For 2x8 or 2x10	Ea.	200

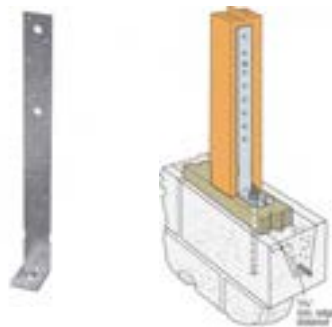

Tension Tie

Part#	Vendor#	Description	Pack Size	Case Qty
JHLTT19	LTT19	Light Tension Tie	Ea.	10



Quickstick

Part#	Description
QUIKSTIK	Simpson Quikstik Tool Attachment To Install SDWC15600 Screws For H2.5A Clip Replacement



Hanger Screws

Part#	Vendor#	Description	Size	Pk. Size	Carton Qty
SD10112R100	SD10112R100	Simpson Stong Drive Hanger Screws	#10 x 1-1/2"	100	10/Pks
SD10112R500	SD10112R500	Simpson Stong Drive Hanger Screws	#10 x 1-1/2"	500	3/Pks
SD10212R100	SD10212R100-R	Simpson Stong Drive Hanger Screws	#10 x 2-1/2"	100	4/Pks
SD10212R500	SD10212R500	Simpson Stong Drive Hanger Screws	#10 x 2-1/2"	500	2/Pks
SD9112R100	SD9112R100	Simpson Stong Drive Hanger Screws	#9 x 1-1/2"	100	10/Pks
SD9112R500	SD9112R500	Simpson Stong Drive Hanger Screws	#9 x 1-1/2"	500	3/Pks
SD9212R100	SD9212R100-R	Simpson Stong Drive Hanger Screws	#9 x 2-1/2"	100	4/Pks
SD9212R500	SD9212R500	Simpson Stong Drive Hanger Screws	#9 x 2-1/2"	500	2/Pks





Heavy Duty Connector Screws

Part#	Description	Size	Pk. Size	Carton Qty
SDS25112MB	Simpson Strong Drive SDS Heavy Duty Connector Screws	1/4" x 1/2"	300	3/Pks
SDS25112-R25	Simpson Strong Drive SDS Heavy Duty Connector Screws	1/4" x 1/2"	25	12/Pks
SDS25212MB	Simpson Strong Drive SDS Heavy Duty Connector Screws	1/4" x 2-1/2"	200	3/Pks
SDS25212-R25	Simpson Strong Drive SDS Heavy Duty Connector Screws	1/4" x 2-1/2"	25	12/Pks
SDS25300MB	Simpson Strong Drive SDS Heavy Duty Connector Screws	1/4" x 3"	150	3/Pks
SDS25300-R25	Simpson Strong Drive SDS Heavy Duty Connector Screws	1/4" x 3"	25	12/Pks
SDS25312MB	Simpson Strong Drive SDS Heavy Duty Connector Screws	1/4" x 3-1/2"	125	3/Pks
SDS25312-R25L	Simpson Strong Drive SDS Heavy Duty Connector Screws	1/4" x 3-1/2"	25	12/Pks
SDS25412MB	Simpson Strong Drive SDS Heavy Duty Connector Screws	1/2" x 4-1/2"	100	3/Pks
SDS25412-R10	Simpson Strong Drive SDS Heavy Duty Connector Screws	1/4" x 4-1/2"	10	6/Pks
SDS25500MB	Simpson Strong Drive SDS Heavy Duty Connector Screws	1/4" x 5"	100	3/Pks
SDS25500-R25L	Simpson Strong Drive SDS Heavy Duty Connector Screws	1/4" x 5"	25	6/Pks
SDS25600MB	Simpson Strong Drive SDS Heavy Duty Connector Screws	1/4" x 6"	100	3/Pks
SDS25600-R10	Simpson Strong Drive SDS Heavy Duty Connector Screws	1/4" x 6"	10	6/Pks



Siding & Accessories





ABM Panel - 28 Gauge Steel

Acc

Heavy-duty 28 gauge steel - in over 30 energy-efficient colors with 40-year paint warranties - heat-formed and rolled to custom lengths in hours... not days.

The ABM Panel provides 36" wide coverage. It is rolled to custom lengths from 1' to 48' in 1/4" increments. This means you're not paying for that extra 2' or 1/2" that you don't need. Plus think of all the time your saving.



Steel Board and Batten

BBccLF

Steel Board and Batten gives you siding a classic look without the maintenance of painted or stained wood siding. It's made to custom lengths from 32" to 20'.

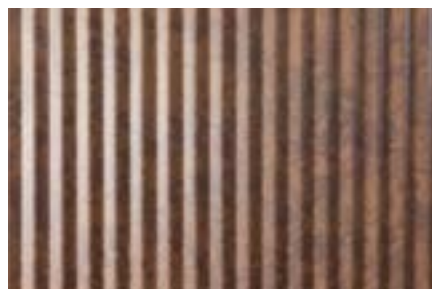

Continuous Corrugated

C1cc & C2cc

One of the earliest panel profiles dating back to before the colonial days, the continuous corrugated panels have transcended time to become one of the most popular stylistic panels on the market. Though not recommended for roofing because of the low rib height and lack of an anti-siphon channel, the continuous corrugated panel is great for interior decorating and siding applications.

And it is now available in all 50+ of our colors and textures!



LP Smartside Siding

LP® SmartSide® Trim & Siding products are treated with our proprietary SmartGuard® process. With four components of protection, the process adds strength and helps our products withstand impacts, freeze/thaw cycles, high humidity and fungal decay.

Part#	Description	Size	Thickness
LSS48	LP SmartSide Siding 8" On Center Primed Cedar Texture	4' x 8'	3/8



Shiplap Rough Sawn Pine

Part#	Description	Size	Length
L11010SL	Rough Sawn Shiplap	1" x 10"	10'
L11012SL	Rough Sawn Shiplap	1" x 10"	12'
L11016SL	Rough Sawn Shiplap	1" x 10"	16'



Tongue & Groove Pine Barn Siding

- Available in 2' increments from 8' to 16'
- The T&G barn siding gives you the option of smooth with v-groove or beaded with v-groove

Part#	Description	Size	Lengths
L16**TG	T&G Beaded Barn Siding w/ V-groove	1 x 6	8' - 16'
L18**TG	T&G Beaded Barn Siding w/ V-groove	1 x 8	8' - 16'





Georgia Pacific® Shadow Ridge - Vinyl Siding

- 4" Dutch Lap profile vinyl siding
- Easy maintenance
- Sturdy .042" thickness with a 1/2" projection
- Limited Lifetime Transferable Warranty



Part#	Description	Size	Box Qty.
VGPScc	GP Shadow Ridge D/4 Dutch Lapp Vinyl Siding	.042" x 11	24
VOCcc	GP Vinyl Woodgrain 3" X 3/4 Outside Corner	3" x 3/4" x 10'	10
VICcc	GP 3/4" Vinyl Inside Corner Pebbled Finish	3/4" x 10'	10
VJCcc	GP Vinyl 5/8" J Channel	5/8" x 12'	40
VFcc	Vinyl F Channel	1/2" x 12'	24-40
VUScc	Undersill Trim Or Finish Trim Pebble Finish	12'	40
VDUcc	GP Dual Undersill Trim	12'	24
VGPSS	GP Sturdy Vinyl Starter ³⁰³	10'	50
VSRLBcc	Mid American Split Block MINI J-Block Mounting Box	5.25" x 7"	10
VEVcc	Mid American Louvered Exhaust Vent Block for 4" Pipe	7" x 7"	



VSRLBcc



VEVcc

In-stock Colors



ALMOND

FLINT

CLAY

WHITE

TAN

ACTUAL COLORS MAY VARY. REQUEST FREE COLOR SAMPLES.

Vinyl Louvers



Part#	Description	Shape	Size
VSOL18	Mid American Vinyl Louver - White	Octagon	18"
VSOL22	Mid American Vinyl Louver - White	Octagon	22"
VSRL ²²	Mid American Vinyl Louver - White	Round	22"
VSRL1218	Mid American Vinyl Louver - White	Rectangle	12" x 18"
VSRL1824	Mid American Vinyl Louver - White	Rectangle	18" x 24"
VSRL2030	Mid American Vinyl Louver - White	Rectangle	20" x 30"
VSHR3422	Mid American Vinyl Louver - White	Half Round	34" x 22"





CENTER VENT



SOLID



FULLY VENTED

ACTUAL COLORS MAY VARY.
REQUEST FREE COLOR SAMPLES.

Vinyl Soffit

Part#	Description	Box Qty.	Cvg.	Length
VSCVWH	Vinyl Soffit - Center Vent - White - Provia	16	12"	12'
VSSWH	Vinyl Soffit - Solid - White - Provia	16	12"	12'
VSFVWH	Vinyl Soffit - Fully Vented - Provia	16	12"	12'
VSCVAD	Vinyl Soffit - Center Vent - Almond/Lightstone - GP	16	12"	12'
VSSAD	Vinyl Soffit - Solid - Almond/Lightstone - GP	16	12"	12'
VSCVBN	Vinyl Soffit - Fully Vented - Brown - Provia	16	12"	12'
VSSBN	Vinyl Soffit - Solid - Brown - Provia	16	12"	12'
VSCVFT	Vinyl Soffit - Fully Vented - Flint/Ash Gray - GP	16	12"	12'
VSSFT	Vinyl Soffit - Solid - Flint/Ash Gray - GP	16	12"	12'
VSCVCL	Vinyl Soffit - Center Vent - Clay - GP	16	12"	12'
VSSCL	Vinyl Soffit - Solid - Clay - GP	16	12"	12'
VSCVTN	Vinyl Soffit - Center Vent - Tan - GP	16	12"	12'
VSSTN	Vinyl Soffit - Solid - Tan - GP	16	12"	12'
VPSSCL	Vinyl Soffit - Solid - Clay - Provia	16	12"	12'
VPCVCL	Vinyl Soffit - Center Vent - Clay - Provia	16	12"	12'
VPSSGRAY	Vinyl Soffit - Solid - Gray - Provia	16	12"	12'
VPCVGRAY	Vinyl Soffit - Center Vent - Gray - Provia	16	12"	12'
VPSSPE	Vinyl Soffit - Solid - Pewter - Provia	16	12"	12'
VPCVPE	Vinyl Soffit - Center Vent - Pewter - Provia	16	12"	12'
VPSSCSW	Vinyl Soffit - Solid - Sandalwood - Provia	16	12"	12'
VPCVSW	Vinyl Soffit - Center Vent - Sandalwood - Provia	16	12"	12'
VSSBL	Vinyl Soffit - Solid - Black - Provia	16	12"	12'
VSCVBL	Vinyl Soffit - Center Vent - Black - Provia	16	12"	12'

Aluminum Soffit - Holmes



Part#	Description	Box Qty.	Cvg.	Length
SOA12V	Aluminum Soffit - White Vented	16	12"	12'
SOA12S	Aluminum Soffit - White Solid	16	12"	12'
SOFAW	1/2" Aluminum F Channel - White	25		12'
SOJAW	1/2" Aluminum J Channel - White	25		12'
SOF6W	Berger 6 Inch Aluminum Fascia .024 - White	25		12'
SOF8W	Berger 8 Inch Aluminum Fascia .024 - White	25		12'
SOA12SB	Aluminum Soffit - Solid - Brown	16	12"	12'
SOA12VB	Aluminum Soffit - Vented - Brown	16	12"	12'
SOA12SC	Aluminum Soffit - Solid - Charcoal	16	12"	12'
SOA12VC	Aluminum Soffit - Vented - Charcoal	16	12"	12'
SOA12SE	Aluminum Soffit - Solid - Evergreen	16	12"	12'
SOA12VE	Aluminum Soffit - Vented - Evergreen	16	12"	12'
SOFABN	1/2" Aluminum F Channel - Brown	25		12'
SOJABN	1/2" Aluminum J Channel - Brown	25		12'
SOFACH	1/2" Aluminum F Channel - Charcoal	25		12'
SOJACH	1/2" Aluminum J Channel - Charcoal	25		12'
SOFAEG	1/2" Aluminum F Channel - Evergreen	25		12'
SOJAEG	1/2" Aluminum J Channel - Evergreen	25		12'





BLACK

MUSKET
BROWNTUXEDO
GRAYBURGUNDY
REDFOREST
GREEN

MID AMERICAN COLOR NAMES DO NOT ALWAYS MATCH OUR METAL PANEL COLOR NAMES.

Raised Panel Shutters Mid American

Boldly designed and available in a wide range of colors, the standard Williamsburg raised panel shutter is an excellent choice for Cape Cod, Federal, Shingle, Foursquare and other style homes. The deep texture and precise construction provides the look of authentic raised double panels. Customize color, length and width for precisely the look you desire.

Many special order sizes and colors available.

Part#	Description	Box Qty.	Width	Length
SHU31BL	31" Pair Black Mid American Raised Panel Shutters	2	14.75"	31"
SHU35BL	35" Pair Black Mid American Raised Panel Shutters	2	14.75"	35"
SHU39BL	39" Pair Black Mid American Raised Panel Shutters	2	14.75"	39"
SHU43BL	43" Pair Black Mid American Raised Panel Shutters	2	14.75"	43"
SHU43BU	43" Pair Red (Barn Red) Mid American Raised Panel Shutters	2	14.75"	43"
SHU43FG	43" Pair Forest Green (Evergreen) Mid American Raised Panel Shutters	2	14.75"	43"
SHU43MB	43" Pair Musket Brown (Bronze) Mid American Raised Panel Shutters	2	14.75"	43"
SHU43TG	43" Pair Tuxedo Gray (Charcoal) Mid American Raised Panel Shutters	2	14.75"	43"
SHU47BL	47" Pair Black Mid American Raised Panel Shutters	2	14.75"	47"
SHU47BU	47" Pair Red (Barn Red) Mid American Raised Panel Shutters	2	14.75"	47"
SHU47FG	47" Pair Forest Green (Evergreen) Mid American Raised Panel Shutters	2	14.75"	47"
SHU47MB	47" Pair Musket Brown (Bronze) Mid American Raised Panel Shutters	2	14.75"	47"
SHU47TG	47" Pair Tuxedo Gray (Charcoal) Mid American Raised Panel Shutters	2	14.75"	47"
SHU51BL	51" Pair Black Mid American Raised Panel Shutters	2	14.75"	51"
SHU55BL	55" Pair Black Mid American Raised Panel Shutters	2	14.75"	55"
SHU59BL	59" Pair Black Mid American Raised Panel Shutters	2	14.75"	59"
SHU59BU	59" Pair Red (Barn Red) Mid American Raised Panel Shutters	2	14.75"	59"
SHU59FG	59" Forest Green (Evergreen) Mid American Raised Panel Shutters	2	14.75"	59"
SHU59MB	59" Pair Musket Brown (Bronze) Mid American Raised Panel Shutters	2	14.75"	59"
SHU59TG	59" Pair Tuxedo Gray (Charcoal) Mid American Raised Panel Shutters	2	14.75"	59"
SHU63BL	63" Pair Black Mid American Raised Panel Shutters	2	14.75"	63"
SHU67BL	67" Pair Black Mid American Raised Panel Shutters	2	14.75"	67"
SHUPLUGcc	Shutter Plugs - 12 Pack	12	14.75"	





Boral® Versetta Stone - Special Order

Available to special order.

- The beauty of stone and the simplicity of siding
- Mortarless, cement-based stone veneer
- Installed with mechanical fasteners
- Can be installed in cold weather
- 50-year transferable limited warranty



SPECIFICATIONS

- Panels measure 8" high by 36" wide
- 2 square feet per piece
- 2 pieces per pack

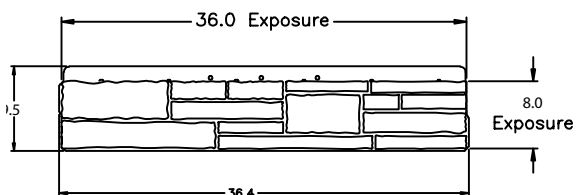

Mission Point



Sterling

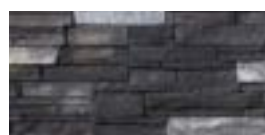

Graphite



Plum Creek

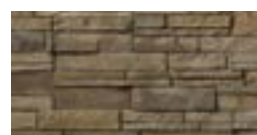

Terra Rosa

Ledgestone



Part#	Description	Pcs/Pack	H	L
BVSLFPC	Boral Versetta Stone Ledgestone Flat Plum Creek - Stock	2 pc	8"	36"
BVSLFS	Boral Versetta Stone Ledgestone Flat Sterling	2 pc	8"	36"
BVSLFTR	Boral Versetta Stone Ledgestone Flat Terra Rosa	2 pc	8"	36"
BVSLUCM	Boral Versetta Stone Ledgestone Universal Corner Mission	2 pc	8"	36"
BVSLUCPC	Boral Versetta Stone Ledgestone Universal Corner Plum Creek	2 pc	8"	36"
BVSLUCS	Boral Versetta Stone Ledgestone Universal Corner Sterling	2 pc	8"	36"
BVSLUCTR	Boral Versetta Stone Ledgestone Universal Corner Terra Rosa	2 pc	8"	36"

Tight Cut



Part#	Description	Pcs/Pack	H	L
BVSTCFM	Boral Versetta Stone Tight-cut Flat Mission	2 pc	8"	36"
BVSTCFPC	Boral Versetta Stone Tight-cut Flat Plum Creek - Stock	2 pc	8"	36"
BVSTCFS	Boral Versetta Stone Tight-cut Flat Sterling	2 pc	8"	36"
BVSTCFTR	Boral Versetta Stone Tight-cut Flat Terra Rosa	2 pc	8"	36"
BVSTCUCPC	Boral Versetta Stone Tight-cut Universal Corner Plum Creek - Stock	2 pc	8"	36"
BVSTCUCS	Boral Versetta Stone Tight-cut Universal Corner Sterling	2 pc	8"	36"
BVSTCUCTR	Boral Versetta Stone Tight-cut Universal Corner Terra Rosa	2 pc	8"	36"

Trims and Accessories



J-CHANNEL



STARTER STRIP



WAINSCOT CAP



TRIM STONE

Part#	Description	H	L
BVSTS	Boral Versetta Stone Trim Stone Taupe	8"	36"
BVSWCcc	Boral Versetta Stone Wainscot Cap		36"
BVSWCB*	Boral Versetta Stone Wainscot Cap Bracket		
BVSSST	Boral Versetta Stone Starter Strip Taupe		10'
BVSJCT	Boral Versetta Stone J Channel		10'
BVSFAC	Boral Versetta Stone Touch Up/Finish Adhesive Charcoal ^{10,1} Oz Caulk Tube		
BVSFAT	Boral Versetta Stone Touch Up/Finish Adhesive Taupe ^{10,1} Oz Caulk Tube		



Royal® Celect - Cellular Composite Special Order

- Premium PVC with interlocking joints
- Thicker than typical vinyl to replicate the look of wood, but without the maintenance
- UV-resistant Kynar Aquatec® coating with 25 year warranty (including trims)
- Easy to install without caulking



ACTUAL COLORS MAY VARY.
REQUEST FREE COLOR SAMPLES.

Part#	Description	Box Qty.	Cvrg.	Size
VR7HLS	Royal Celect 7" Horizontal Lap PVC Cellular Siding	14	1 Sq	1/2" x 7" x 148"
VRCS	Royal Celect Shake PVC Cellular Siding	42	1 Sq.	.68" x 8.5" x 49"
VRCSBB	Royal Celect Vertical Board & Batten PVC Cellular Siding	15	1 Sq.	8" x 10"



Part#	Description	Box Qty.	Size ²	Length
VRCCSS	Royal Celect PVC Cellular Starter Strip	24	3.5"	12'
VRDFS16	Royal Celect PVC Cellular Furring Strip	2	1" x 2"	16'
VRCC10	Royal Celect PVC Cellular Outside Corner	2	5.5" x 5.5"	10'
VRCC20	Royal Celect PVC Cellular Outside Corner	2	5.5" x 5.5"	20'
VRCTBM	Royal Celect Brick Mould PVC Cellular	2	1-3/32 x 2.75"	16'
VRCTBM16	Royal Celect Brick Mould PVC Cellular Outside Corner	2	1-3/32 x 2.75"	16'
VRCT16	Royal Celect Finish Trim PVC Cellular Outside Corner	2	1-7/64" x 2-37/64"	16'
VRCT10	Royal Celect PVC Cellular Inside Corner	2	2" x 2"	10'
VRCTB581016	Royal Celect Trim Board PVC Cellular	2	5/8" x 10"	16'
VRCTB58416	Royal Celect Trim Board PVC Cellular	2	5/8" x 4"	16'
VRCTB58616	Royal Celect Trim Board PVC Cellular	2	5/8" x 6"	16'
VRCTB58816	Royal Celect Trim Board PVC Cellular	2	5/8" x 8"	16'
VRCTG16	Royal Celect PVC Cellular Gable Trim	2	1-3/32 x 2.75"	16'
VRCTWT	Royal Celect Window Trim PVC Cellular	2	2" Pocket	16'
VRCCS	Royal Celect Cortex Pro Plug Screws for Trim Color		250 LF	





Willowbrook™- Vinyl Siding



- 4-1/2" Dutch Lap profile vinyl siding
- 4-1/2" Straight Lap profile vinyl siding (white and clay only)

The long-lasting durability of .042" Willowbrook™ Super Polymer Vinyl Siding means your home will keep its charm and value for years to come, with very little exterior maintenance required.

Willowbrook features a brushed cedar woodgrain finish and utilizes our Super Polymer Formulation, which offers excellent weather resistance, impact resistance and color retention. Plus, it's backed by a Lifetime Limited Warranty.

Part#	Description	Size	Box Qty.
V PUB**	Original MountMaster Box		
V PRB**	Recessed Mini Mounting Block		
V PSRB**	Split Mini Mounting Block		
V PHV**	Hooded Vent	4"	
V PEV**	Master Exhaust Vent		
V PIEVWH	Intake/Exhaust Vent Block	4"	
V PFC12**	Provia Vinyl Soffit F-Channel	1/2" x 12'	
V PJC**	Provia Vinyl Soffit J-Channel	5/8" x 12'	
V PUS**	Provia Vinyl Soffit Undersill Trim	12'	
V PIC**	Provia Vinyl Siding Outside Corner	3-3/4" x 3/4" x 10'	
V POC**	Provia Vinyl Siding Outside Corner	3-3/4" x 3/4" x 10'	
V PSCV**	Provia Centervent Vinyl Universal Soffit	12" x 12'	
V PSS**	Provia Solid Vinyl Universal Soffit	12" x 12'	
V PW**	Provia WillowBrook 4.5DL Dutch Lap Vinyl Siding	.042	11
V PSS	Vinyl Siding Steel Starter Strip	10'	
V GPSS	Gp Sturdy Vinyl Starter ³⁰³	10'	

Colors



WHITE

GRAY

PEWTER

SANDALWOOD

GRANITE

CLAY

ACTUAL COLORS MAY VARY. REQUEST FREE COLOR SAMPLES.



VENTED & SOLID SOFFIT



OUTSIDE CORNER



J CHANNEL



Cedar Peaks™ Board & Batten Siding



• 1/2" x 8" x 96" Vinyl Board & Batten Siding

The long-lasting durability of .042" Willowbrook™ Super Polymer Vinyl Siding means your home will keep its charm and value for years to come, with very little exterior maintenance required.

Willowbrook features a brushed cedar woodgrain finish and utilizes our Super Polymer Formulation, which offers excellent weather resistance, impact resistance and color retention. Plus, it's backed by a Lifetime Limited Warranty.

Part#	Description	Size
VPCPBWH-LIFESTYLE	White Board and Batten Siding	1/2" x 8" x 96"

SPECIAL ORDER - VARYING LEAD TIMES



Exterior Stone

ProVia delivers beautiful curb appeal with manufactured stone veneer, including home exterior stone applications. When used as the exclusive exterior cladding, our stone veneer provides the timeless and classic appearance of a manor home or country cottage. Paired with vinyl siding, manufactured stone offers a dramatic, earthy variation in texture that makes any style or color stand out.

ProVia offers stone veneer styles that enable you to achieve whatever design aesthetic you desire.



Trim Moulding



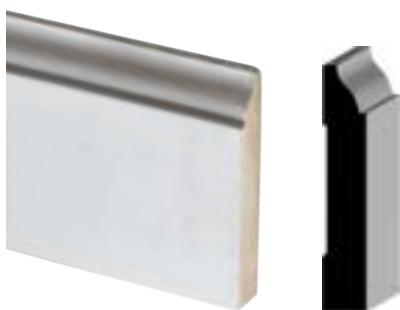

Base Trim Moulding - WM 623

Finger joint pine with a white primer coat.

Part#	Description	Size	Length
TBWM623	Base Trim Moulding Primed Finger Joint Pine WM 623	9/16" x 3-1/4"	16'



Base Trim Moulding - WM 663

Finger joint pine with a white primer coat.

Part#	Description	Size	Length
TBWM663	Base Trim Moulding Primed Finger Joint Pine WM 663	9/16" x 3-1/4"	16'



Base Trim Moulding - LWM 163E

Finger joint pine with a white primer coat.

Part#	Description	Size	Length
TBWM163E	Base Trim Moulding Primed Finger Joint Pine LWM 163E	9/16" x 5-1/4"	16'

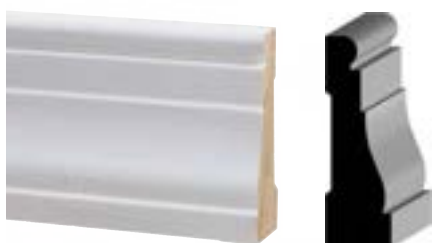

Casing - WM 376

Finger joint pine with a white primer coat.

Part#	Description	Size	Length
TBWM376	Casing Trim Moulding Primed Finger Joint Pine WM 376	11/16" x 2-1/4"	14'

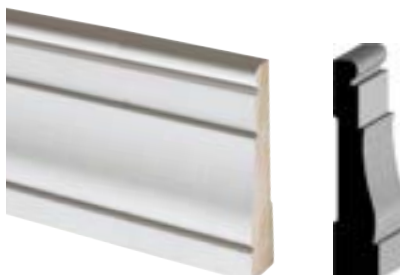

Casing - WM 445

Finger joint pine with a white primer coat.

Part#	Description	Size	Length
TBWM445	Casing Trim Moulding Primed Finger Joint Pine WM 445	11/16" x 3-1/4"	15'



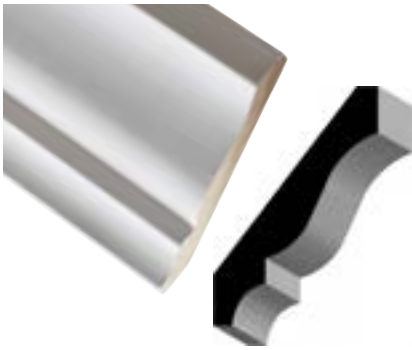

Crown Moulding - LWM 49

Finger joint pine with a white primer coat.

Part#	Description	Size	Length
TBWM49	Crown Moulding Primed Finger Joint Pine LWM 49	9/16" x 3-5/8"	16'

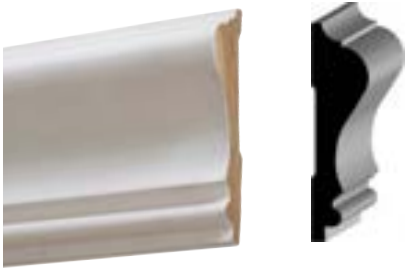

Chair Rail Moulding - WM 390

Finger jointed pine with a white primer coat.

Part#	Description	Size	Length
TBWM390	Chair Rail Moulding Primed Finger Joint Pine - WM 390	11/16" x 2-5/8"	16'

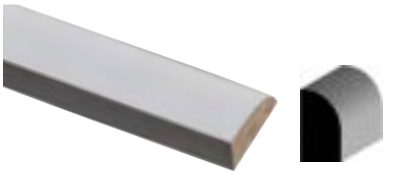

Base Shoe - WM 127

Finger joint pine with a white primer coat.

Part#	Description	Size	Length
TBWM127	Base Shoe Moulding Primed Finger Joint Pine WM 127	7/16" x 3/4"	16'

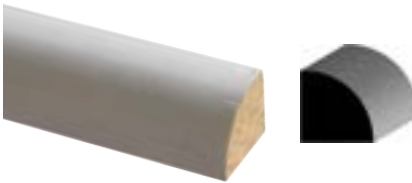

Quarter Round - WM 106

Finger joint pine with a white primer coat.

Part#	Description	Size	Length
TBWM106	Quarter Round Moulding Primed Finger Joint Pine	11/16" x 11/16"	16'



Cove Moulding - WM 100

Finger joint pine with a white primer coat.

Part#	Description	Size	Length
TBWM100	Cove Moulding Primed Finger Joint Pine	11/16" x 11/16"	16'



Hand Rail - WM 240

Part#	Description	Size	Length
TBWM24012	Solid Pine Hand Rail - WM 240	1-1/4" x 2-1/4"	12'
TBWM24014	Solid Pine Hand Rail - WM 240	1-1/4" x 2-1/4"	14'
TBWM24016	Solid Pine Hand Rail - WM 240	1-1/4" x 2-1/4"	16'

PrimeLinX



Primed Finger-Jointed Pine Trim Boards

Genuine PrimeLinX Primed Trim Boards are a multi-purpose, real wood, ready-to-paint product manufactured with an exterior primer and exterior glue. Use PrimeLinX Primed Trim Boards to provide your home with the Craftsman's Style appearance.

FEATURES

- 16 Ft. lengths for less seams
- Real wood
- Primed with industry leading finish and ready-to-paint
- Available in a variety of widths
- Ideal for interior applications

Part#	Description	Size	Act. Size	Length
TBW148	Primed Finger Jointed Pine Trim Boards	1 x 4	23/32" x 3-1/2"	8'
TBW1416	Primed Finger Jointed Pine Trim Boards	1 x 4	23/32" x 3-1/2"	16'
TBW168	Primed Finger Jointed Pine Trim Boards	1 x 6	23/32" x 5-1/2"	8'
TBW1616	Primed Finger Jointed Pine Trim Boards	1 x 6	23/32" x 5-1/2"	16'
TBW1816	Primed Finger Jointed Pine Trim Boards	1 x 8	23/32" x 7-1/4"	8'
TBW1816	Primed Finger Jointed Pine Trim Boards	1 x 8	23/32" x 7-1/4"	16'



PVC Bendable Brick Mould

Bendable up to 180°.

Part#	Description	Act. Size	Length
TBBM125217	White WM 180 Bendable Brick Mould - PVC	1.25" x 2"	17'

Christy's Red Hot Clear Vinyl Adhesive

- Clear Vinyl Adhesive specially formulated for use on Vinyl/PVC fence, deck, windows or furniture
- Long-term UV stabilized, high strength and superior adhesion
- Formulated to retain and maintain clear color integrity in all applications
- High viscosity for optimum gap filling between bonding surfaces



Part#	Description	Size
RHFWMB	Christy's Mitre Bond 2 Part Adhesive	1.5 Oz.
RHFV15	Christy's Vinyl/PVC Trim Adhesive	1.5 Oz.
RHFV4	Christy's Vinyl/PVC Trim Adhesive	4 Oz.
RHFV8	Christy's Vinyl/PVC Trim Adhesive	8 Oz.
RHFV10	Christy's Vinyl/PVC Trim Adhesive	10 Oz.



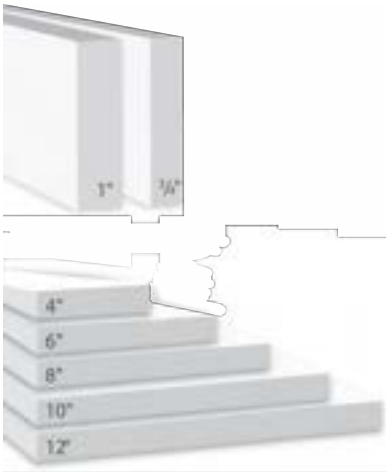

PVC Trim Boards

PVC trim boards can be used in countless ways to trim a home and add long-lasting beauty and value. Its smooth, durable, 4-sided finish resists dirt buildup, while its "true square" edges provide cleaner installation. Cannot be painted with dark colors.

Part#	Description	Size	Act. Size	Length
TB44418	PVC Trimboard - Reversible Woodgrain/Smooth	1 x 4	.75" x 3.5"	18'
TB44618	PVC Trimboard - Reversible Woodgrain/Smooth	1 x 6	.75" x 5.5"	18'
TB44818	PVC Trimboard - Reversible Woodgrain/Smooth	1 x 8	.75" x 7.25"	18'
TBS441018	PVC Trimboard - Reversible Smooth/Smooth	1 x 10	.75" x 9.25"	18'
TBS441218	PVC Trimboard - Reversible Smooth/Smooth	1 x 12	.75" x 11.25"	18'
TBS44418	PVC Trimboard - Reversible Smooth/Smooth	1 x 4	.75" x 3.5"	18'
TBS44618	PVC Trimboard - Reversible Smooth/Smooth	1 x 6	.75" x 5.5"	18'
TBS44818	PVC Trimboard - Reversible Smooth/Smooth	1 x 8	.75" x 7.25"	18'
TBS54418	PVC Trimboard - Reversible Smooth/Smooth	5/4 x 4	1" x 3.5"	18'
TBS54618	PVC Trimboard - Reversible Smooth/Smooth	5/4 x 6	1" x 5.5"	18'
TBS54818	PVC Trimboard - Reversible Smooth/Smooth	5/4 x 8	1" x 7.25"	18'
TBSS388	PVC TrimBoard Sheetstock - S2S		0.375" x 48"	8'
TBSS348	PVC TrimBoard Sheetstock - S2S		0.75" x 48"	8'



Drywall



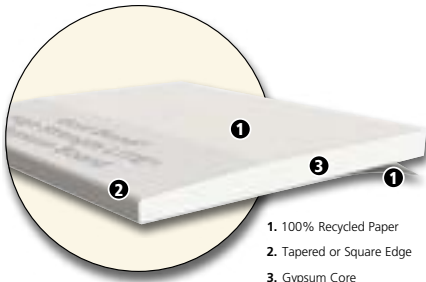

1. 100% Recycled Paper
2. Tapered or Square Edge
3. Gypsum Core

National Gypsum Gold Bond High Strength LITE Drywall

- For interior, non-fire-rated walls and ceilings
- 25% lighter than standard gypsum board
- Provides excellent sag resistance

Part#	Description	Thick	Size
DW1248	High Strength LITE Drywall w/ Gypsum Core	1/2"	4' x 8'
DW12412	High Strength LITE Drywall w/ Gypsum Core	1/2"	4' x 12'



1. Heavy Abrasion Mold and Moisture Resistant Face Paper
2. Enhanced Mold and Moisture Resistant Type X Core
3. Heavy Mold and Moisture Resistant Back Paper

National Gypsum Gold Bond Moisture & Mold Resistant Drywall

- Inhibits mold growth
- Installs fast and easy with tapered edges and less weight
- Resists moisture better
- Resists abuse

Part#	Description	Thick	Size
DW1248MR	Purple Drywall w/ Gypsum Core - Moisture and Mold Resistant	1/2"	4' x 8'

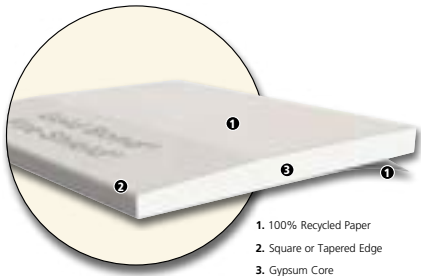

1. 100% Recycled Paper
2. Square or Tapered Edge
3. Gypsum Core

National Gypsum Gold Bond Fire Resistive Drywall

- Approved component in specific UL-rated designs.
- Lightweight and cost-efficient material that is compatible with a wide range of decorative finishes.
- Cuts easily for quick installation, permitting painting or other decoration and the installation of metal or wood trim almost immediately.
- Fire-resistant material with a gypsum core that will not support combustion or transmit temperatures greatly in excess of 212°F (100°C) until completely calcined, a slow process.
- Dimensionally stable under changes in temperature and relative humidity and resists warping, rippling, buckling and sagging.
- Features the GridMarX® preprinted fastening

guide on the board to allow for faster and more accurate installation.

- Achieves GREENGUARD and GREENGUARD Gold Certification. GREENGUARD Certified products are certified to GREENGUARD standards for low chemical emissions into indoor air during product usage. For more information, visit: ul.com/gg.
- Qualifies as a low-VOC emitting material by meeting California Specification 01350. For more information, visit: <http://www.calrecycle.ca.gov/greenbuilding/specs/section01350/>.
- 40-minute fire protection with proper installation.

Part#	Description	Thick	Size
DW5848X	Type X Fire Resistive Drywall with Grid MarX	5/8"	4' x 8'



Drywall Corner Bead

Dent-resistant reinforcement for finishing gypsum board corners in high abuse and moisture-prone areas.

Part#	Description	Size	Length
YVLCB	Drywall Corner Bead - Rip Bead Tearaway	1/2"	10'



Vinyl Drywall Corner Bead

Dent-resistant reinforcement for finishing gypsum board corners in high abuse and moisture-prone areas.

Part#	Description	Size	Length
DWACBV8	Vinyl Drywall Corner Bead	1-1/4"	8'





DWA311692



DWA382175020

Paper Drywall Seam Tape

Delivers perfect straight lines for challenging off-angles and long spans. Flexible hinge forms to any inside or outside corner angle. Flange width hides irregular framing.

Part#	Description	Size	Length
DWA311692	Flexible Drywall Corner No-Coat	3-1/4"	100'



Fiberglass Drywall Seam Tape

Part#	Description	Size	Length
DWAFDW6583-U	Fiberglass Drywall Joint Tape - FibaTape Self Adhesive	1-7/8"	500'
DWAFDW6581-U	White Fiberglass Drywall Joint Tape Self Adhesive	1-7/8"	300'
DWAFDW6578-U	White Fiberglass Joint Tape - FibaTape Self Adhesive	1-7/8"	150'



Fibafuse Drywall Tape

Mold-resistant glass mat drywall tape is ideal for high-humidity and moisture-prone applications. Easy to cut and designed to retain its folds. Good for corners or patches.

Part#	Description	Size	Length
DWAFDW8652-U	Drywall Joint Tape - Fibafuse	2"	250'



Drywall Roll Lifter

Part#	Description	Size
DWA151523L	Drywall Roll Lifter	15.5" x 2.25"



Drywall Ribbon Blade Mixer

Part#	Description	Size
DWARM772	Mud Mixer Ribbon Blade	4" x24"



Drywall Knife

Part#	Description	Size
DWACC766	Drywall Circle Cutter Hardened Steel	8-1/2"



Drywall Pole Sander

Part#	Description	Size
DWA7155	Drywall Pole Sander Hook/Loop with Handle	4"x10"



Drywall Rasp

Part#	Description	Size
DWA14389	Drywall Rasp W/Rails	5-1/2"





Ready Mixed Joint Compound Base & Top Coat

For hand-applied simple texturing and cracks in interior plaster and masonry. Fast, easy and smooth finish. Low shrinkage. Easy to apply and sand.

Part#	Description	Size
DWAMG5G	Green Lid - Joint Compound - Ready Mixed - USG	5 Gal.



Light-Weight Ready Mixed Joint Compound Top Coat

Very low shrinkage. Excellent for hand and mechanical tool application.

Part#	Description	Size
DWAMB5G	Blue Lid Light+3 Joint Compound - Ready Mixed - USG	4.5 Gal.



Mid-Weight Ready Mixed Joint Compound Base & Top Coat

Very low shrinkage. Excellent for hand and mechanical tool application.

Part#	Description	Size
DWAMP5G	Purple Lid Mid-Weight Joint Compound - Ready Mixed - USG	4.5 Gal.



Wallboard Joint Compound

For smooth, high quality finishing of gypsum panel joints. White color.

Part#	Description	Size
DWA10100	Wallboard Joint Compound - DAP	1 Qt.



Vinyl Drywall Compound

Heavy-duty all purpose formula that is perfect for household repairs and professional jobs. Resists cracking, sands easily and spreads smoothly. Interior/exterior use.

Part#	Description	Size
DWA12130	Vinyl Spackling - White - DAP	1/2 pt.
DWA12132	Vinyl Spackling - White - DAP	1 Qt.
DWA12133	Vinyl Spackling - White - DAP	1 Gal.



Drywall Compound

Part#	Description	Size
DWAMP5G	Purple Lid USG Mid-Weight Joint Compound - Ready Mixed	4-1/2 Gal
DWAMB5G	Blue Lid USG Light+3 Joint Compound -Ready Mixed	4-1/2 Gal
DWAMG5G	USG L. Green Lid - Joint Compound - Ready Mixed (finish)	5 Gal



Paint & Stain





WOOD PROTECTOR

SEALER

Cabot - Clear

Tough waterproofing without added color

Description	Size
Cabot Wood Protector	Gallon
Cabot Waterproofing Sealer	Gallon



Cabot - Wood Toned Stain

Hint of natural color to show the most wood texture and grain

Description	Size
Wood Toned Deck and Siding Stain	Gallon



Cabot - Australian Timber Oil

Penetrating protection from blazing sun and driving rain

- Available in Multiple Colors

Description	Size
Cabot Australian Timber Oil	5 Gallon / Gallon



Cabot - Gold

The look of hardwood floors outdoors

Description	Size
Cabot Gold Series Satin Exterior Wood Finish	Gallon



DECK & SIDING STAIN

ACRYLIC STAIN

Cabot Semi-Transparent

Subtle color that highlights the beauty of the wood texture and grain

Description	Size
Cabot Semi-Transparent Oil Based Deck & Siding Stain	Qt., Gal., 5 Gal.
Cabot Semi-Transparent Acrylic Stain	Qt., Gal., 5 Gal.





Cabot - Semi-Solid

Full color that shows wood texture and some grain

Description	Size
Cabot Semi-Solid Oil Based Deck & Siding Stain	Qt., Gal., 5 Gallon



ACRYLIC DECK STAIN ACRYLIC SIDING STAIN OIL-BASED DECK STAIN

Cabot - Solid

Full color and coverage that shows wood texture without grain

Description	Size
Cabot Solid Color Acrylic Deck Stain	Qt., Gal., 5 Gal.
Cabot Solid Color Acrylic Siding Stain	Gallon
Cabot Solid Color Oil-Based Deck Stain	Gallon



Cabot - Waterproofing Sealer

Description	Size
Cabot Waterproofing Sealer	5 Gallon



INTERIOR

EXTERIOR

Valspar Pro-Hide - Contractor Grade - Tintable

Description	Size
Valspar Interior and Exterior Pro-Hide Gold Ultra - Sheens: Flat, Eggshell, Satin, Semi-Gloss	Gallon
Valspar Interior and Exterior Pro-Hide Gold Ultra - Sheens: Flat, Eggshell, Satin, Semi-Gloss	5 Gallon



INTERIOR PAINT & PRIMER



EXTERIOR

Valspar Medallion Plus - Tintable

- Engineered for ultimate stain-blocking & maximum durability
- Interior/exterior available in flat, eggshell, satin, and semi-gloss sheens
- Advanced stain-blocking & stain-resistance formula
- Computerized color matching

Description	Size
Valspar Medallion Plus Interior and Exterior - Flat, Eggshell, Satin, Semi-gloss	Quart
Valspar Medallion Plus Interior and Exterior - Flat, Eggshell, Satin, Semi-gloss	Gallon
Valspar Medallion Plus Interior and Exterior - Flat, Eggshell, Satin, Semi-gloss	5 Gallon



SEMI-GLOSS INTERIOR



SATIN INTERIOR

Valspar Accolade - Tintable

- Super premium paint - ultra bonding - stain resistant
- Interior available in matte, satin, and semi-gloss sheens
- Computerized color matching

Description	Size
Valspar Matte Accolade Interior 100% Acrylic Paint Interior and Exterior - Matte, Satin, Semi-Gloss	Quart
Valspar Semi-Gloss Accolade Interior 100% Acrylic Paint Interior and Exterior - Matte, Satin, Semi-Gloss	Gallon
Valspar Satin Accolade Exterior 100% Acrylic Paint Interior and Exterior - Matte, Satin, Semi-Gloss	5 Gallon



GardZ Sealer

Problem surface sealer - penetrates seals and binds unstable surfaces

Part#	Description	Size
Y02301 GAL	"GARDZ" Interior Water-Based Drywall Sealer	Gallon



Y13002



Y20041



YL¹⁰¹²¹¹/10091

KILZ Primers

All-purpose primers and specialty primers to tackle the toughest problems

Part#	Description	Size
Y10036	Kilz Original Interior Low VOC Primer Sealer	Gallon
Y13002	Kilz Stain Block Premium Primer Water Based	Gallon
Y20041	Kilz 2 Premium All-Purpose Latex Primer Interior/Exterior	Gallon
YL ¹⁰¹²¹¹ /10091	Kilz Complete Oil Based Primer	Gallon
YL ²⁰⁴⁵¹¹	Kilz Kitchen & Bath Primer	Gallon



BondZ Primer

Maximum adhesion primer bonds any top coat to hard dense surfaces

Part#	Description	Size
Y256261-GAL	BONDZ Maximum Adhesion Interior/Exterior Primer	Gallon





Y249729



Y305928



Y276049



Y60001



P123G



P123GG

Zinsser Primers

Project specific primers for a variety of surface challenges and special applications

Part#	Description	Size
Y249729	Zinsser "Smart Prime" Interior/Exterior Primer/Sealer - sticks to all surfaces, blocks all stains	Gallon
Y305928	Zinsser Odor Killing Primer	Gallon
Y276049	Zinsser Mold Killing Primer	Gallon
Y60001	Zinsser Peel Stop Binding Primer Sealer - Clear	Gallon

Bull's Eye Primers

Water-based primers for all surfaces

Part#	Description	Size
P123G	Bull's Eye 1-2-3 Interior/Exterior Primer - White	Qt., Gal., 5 Gal.
P123GG	Bull's Eye 1-2-3 Interior/Exterior Primer - Gray	Gal.



GALLON QUART

Defi-Rust Acrylic Enamel

- Colors matched to many ABM panels - ready off the shelf
- Provides a tough coating to protect from moisture, corrosion, and wear
- Made with specially chosen rust inhibitors for long lasting protection
- Interior/exterior for wood or metal

Description	Size
Defi-Rust Acrylic	Gallon
Defi-Rust Acrylic	Quart



PROFESSIONAL ULTRA COVER 2X



STOPS RUST

Rust-Oleum Spray Paint

Description	Size
Rust-Oleum Professional High Performance Protective Enamels	15 oz
Rust-Oleum Ultra Cover 2X - twice the coverage as other brands	12 oz
Rust-Oleum High-Performance Stops Rust® Spray Paint	12 oz



Y252625



TINT BASE CLOSEUP

Epoxy - Water Based

Brighten your garage with a clean, glossy, showroom-quality floor—in the color of your choice. Rust-Oleum EPOXYSHIELD Garage Floor Coating Kit applies in one easy coat and protects against gasoline, salt, hot tire pick-up, cracking and more—for years to come.

Part#	Description
Y252625	Epoxy Shield Garage Floor Tint Base
Y292514	Epoxy Shield Garage Floor Clear Gloss



Outlast Q8 Log Oil Wood Preservative

Build, heal end-cuts, stain, and preserve your deck all on the same day. An EPA registered wood preservative specifically designed to control decay-causing organisms in log homes, decking, fencing – even pressure treated. It provides unsurpassed water repellency and sheer trans-oxide color with one coat coverage. Unlike traditional surface coatings, Q8 penetrates deep into the log to provide guaranteed protection and guarantees no peeling or cracking.

- Stains and preserves in a single application
- Guaranteed to never crack, chip, or peel
- Repels water, controls rot, mold, and decay
- Toxic to termites and powder post beetles

Part#	Description	Size
YQ8BG1G	Outlast Q8 Log Oil - Barn Gray	Gallon
YQ8CL1G	Outlast Q8 Log Oil - Clear	Gallon
YQ8DB1G	Outlast Q8 Log Oil - Dark Brown	Gallon
YQ8LG1G	Outlast Q8 Log Oil - Light Gold	Gallon
YQ8MG1G	Outlast Q8 Log Oil - Medium Gold	Gallon
YQ8NB1G	Outlast Q8 Log Oil - Natural Base	Gallon
YQ8RB1G	Outlast Q8 Log Oil - Reddish Brown	Gallon
YQ8BG5G	Outlast Q8 Log Oil - Barn Gray	5 Gallon
YQ8CL5G	Outlast Q8 Log Oil - Clear	5 Gallon
YQ8DB5G	Outlast Q8 Log Oil - Dark Brown	5 Gallon
YQ8LG5G	Outlast Q8 Log Oil - Light Gold	5 Gallon
YQ8MG5G	Outlast Q8 Log Oil - Medium Gold	5 Gallon
YQ8NB5G	Outlast Q8 Log Oil - Natural Base	5 Gallon
YQ8RB5G	Outlast Q8 Log Oil - Reddish Brown	5 Gallon



NBS 30® Additive - Repels Insects

Designed to deter and inhibit insects from burrowing through or crawling on exterior coatings. For use in residential applications like log homes, decks, and fences.

- Repels nuisance, nesting insects and discourages carpenter ants and carpenter bees from dilling
- Reduces ladybug infestations
- Safe for pets and people, extremely low toxicity
- Will not harm plants
- Mixes easily with both oil and water-based paints and stains

Part#	Description	Size
YNBS30	Outlast NBS 30 Insect Repellent Additive	Pint



Fasteners





GRK Structural Screws

GRK Fasteners RSS screw is Climatek coated hardened steel for use in treated wood. Its sharp threads and point bite instantly into material (including hardwood), reducing the splitting effect caused by smaller shanks. Its washer type head has no sharp edges like conventional lag screws, and the added shoulder underneath the washer has the ability to center the RSS screw in predrilled hardware.

FEATURES

- Ideal for ledger boards and more
- Self-tapping
- W-cut thread design
- May be used as a lag screw alternative
- 1 step install, no pre-drilling
- Superior clamping force on the first drive
- 20% faster drive time
- 3-1/8" - 6" screws have 5/16" diameter shank, and the 8" and 12" screws have a 3/8" diameter shank.

Part#	Description	Carton Qty	Driver Size	Size	Length
SHS2-50	2" GRK Structural Screws - Climatek Coated	50	T30	1/4"	2"
SHS2	2" GRK Structural Screws - Climatek Coated	800	T30	1/4"	2"
SHS25-50	2-1/2" GRK Structural Screws - Climatek Coated	50	T30	#10	2-1/2"
SHS25	2-1/2" GRK Structural Screws - Climatek Coated	1000	T30	#10	2-1/2"
SHS318-50	3-1/8" GRK Structural Screws - Climatek Coated	50	T30	#10	3-1/8"
SHS3-100	3-1/8" GRK Structural Screws - Climatek Coated	100	T30	5/16"	3-1/8"
SHS3	3-1/8" GRK Structural Screws - Climatek Coated	500	T30	#10	3-1/8"
SHS318	3-1/8" GRK Structural Screws - Climatek Coated	800	T30	5/16"	3-1/8"
SHS35-100	3-1/2" GRK Structural Screws - Climatek Coated	100	T30	5/16"	3-1/2"
SHs35	3-1/2" GRK Structural Screws - Climatek Coated	500	T30	5/16"	3-1/2"
SHS4-25	4" GRK Structural Screws - Climatek Coated	25	T30	5/16"	4"
SHS4-100	4" GRK Structural Screws - Climatek Coated for	100	T30	5/16"	4"
SHS4	4" GRK Structural Screws - Climatek Coated for	400	T30	5/16"	4"
SHS5-20	5-1/8" GRK Structural Screws - Climatek Coated	20	T30	5/16"	5-1/8"
SHS5-50	5-1/8" GRK Structural Screws - Climatek Coated	50	T30	5/16"	5-1/8"
SHS5	5-1/8" GRK Structural Screws - Climatek Coated	300	T30	5/16"	5-1/8"
SHS6-20	6" GRK Structural Screws - Climatek Coated	20	T30	5/16"	6"
SHS6-50	6" GRK Structural Screws - Climatek Coated	50	T30	5/16"	6"
SHS6	6" GRK Structural Screws - Climatek Coated	300	T30	5/16"	6"
SHS725	7-1/4" GRK Structural Screws - Climatek Coated	200	T40	3/8"	7-1/4"
SHS8	8" GRK Structural Screws - Climatek Coated	300	T40	3/8"	8"
SHS10	10" GRK Structural Screws - Climatek Coated	300	T40	3/8"	10"
SHS12	12" GRK Structural Screws - Climatek Coated	300	T40*	3/8"	12"
SHS4ss	4" GRK Structural Screws - Stainless Steel	400	T30	5/16"	4"
SHS6SS	6" GRK Structural Screws - Stainless Steel	300	T30	5/16"	6"





LedgerLOK Screws - FastenMaster

Save time, money, and labor costs. LedgerLOK is the first fastener engineered to attach deck ledger boards to the rim board of the house with no predrilling. No need to predrill and hand-ratchet in 1/2 inch galvanized lags and washers. LedgerLOK also has stronger shear values than 1/2 inch galvanized lag screws. Plus, with LedgerLOK's smaller shank diameter, even a cordless drill (14.4 volts or higher) zips them right in, saving on battery life and additional tooling costs. Each pack size contains a free 5/16 inch driver bit. LedgerLOK fasteners are American made.

FEATURES

- Manufactured in United States
- Easy to use
- Highly durable
- Nationally code compliant ESR #1078
- Head-stamped for easy code inspection
- Built in washer hex-head design eliminates the need for additional washers
- Costs significantly less per piece than 1/2 inch galvanized lags and washers
- Guaranteed corrosion resistance for the life of the project; ACQ approved

Part#	Description	Pack Qty	Carton Qty	Size
SL358	3-5/8" Fastenmaster LedgerLOK Hexhead Screws	50	6 Boxes	3-5/8"
SL358B	3-5/8" Fastenmaster LedgerLOK Hexhead Screws	250		3-5/8"
SL5	5" Fastenmaster LedgerLOK Hexhead Screws	50	6 Boxes	5"
SL5B	5" Fastenmaster LedgerLOK Hexhead Screws	250		5"
SL358FH-12	3-5/8 " Fastenmaster LedgerLOK Flathead Screws	12		3-5/8"
SL5FH-12q	5" Fastenmaster LedgerLOK Flathead Screws	12		5"



TimberLOK Heavy-Duty Screws - FastenMaster

Save time, money, and labor costs. TimberLOK's sharp point and aggressive threads penetrate the densest woods without predrilling and provide stronger shear values than 3/8 inch galvanized lag screws. TimberLOK's unique countersinking head design is perfect for your next wood-to-wood project, whether it be deck framing, fencing, or any post to beam connections. It's also perfect for replacing galvanized spikes in raised flower beds, landscaping, or retaining walls. No need to predrill and sledge a spike. TimberLOK just zips right in. Each pack size contains a free 5/16 inch driver bit. TimberLOK fasteners are American made.

FEATURES

- Easy to use
- Highly durable
- Nationally code compliant IBC/IRC ESR #1078
- Head-stamped for easy code inspection
- Unique tapered head countersinks easily into wood
- Guaranteed corrosion resistance for the life of the project
- ACQ approved

Part#	Description	Pack Qty	Carton Qty	Size
ST25	2-1/2" Fastenmaster TimberLOK Hexhead Screws	50		2-1/2"
ST4	4" Fastenmaster TimberLOK Hexhead Screws	50	6 Boxes	4"
ST4B	4" Fastenmaster TimberLOK Hexhead Screws	250		4"
ST6	6" Fastenmaster TimberLOK Hexhead Screws	50	6 Boxes	6"
ST6B	6" Fastenmaster TimberLOK Hexhead Screws	250		6"
ST8	8" Fastenmaster TimberLOK Hexhead Screws	50	3 Boxes	8"
ST8B	8" Fastenmaster TimberLOK Hexhead Screws	250		8"
ST10	10" Fastenmaster TimberLOK Hexhead Screws	50	3 Boxes	10"
ST10B	10" Fastenmaster TimberLOK Hexhead Screws	250		10"



ThruLOK Screw Bolt Fastening System - FastenMaster

Meet code and lower installed costs! FastenMaster's ThruLOK Screw Bolt Fastening System replaces 1/2 inch carriage or through-bolts without predrilling. ThruLOK installs quickly with an 18 volt cordless drill and doesn't require special bits or wrenches. The three part kit assembly includes a ThruLOK fastener featuring the patent pending Paddle Point, engineered washer, and LOK-Nut. No need to count out bolts, nuts, and washers. The product's galvanized coating meets current IRC ACQ corrosion requirements and is guaranteed for the life of the project. ThruLOK is also a code compliant replacement for 1/2 inch carriage or through-bolts. This fastener comes in specific lengths to tackle primary deck applications. Installation instructions and code documentation are included in each box. ThruLOK products are manufactured in specific lengths to tackle primary deck applications. The 6-1/4 inch fastener is used for single 2x to 4x decking posts.

FEATURES

- Manufactured in United states
- Easy to use
- Highly durable
- Replaces 1/2 inch carriage or through-bolts without predrilling
- Installs with an 18 volt cordless drill
- No special bits or wrenches needed
- Meets all corrosion requirements and is guaranteed for the life of the project
- Code compliant fastening method with current code documentation

Part#	Description	Pack Qty	Carton Qty	Size
STH614-1	6-1/4 " --Single-- Fastenmaster - ThruLok Screw			6-1/4"
STH7-1	7 " --Single-- Fastenmaster - ThruLok Screw			7"
STH62524	6-1/4" Fastenmaster ThruLOK Hexhead Screws	24	4 Boxes	6-1/4"
STH724	7" Fastenmaster ThruLOK Hexhead Screws	24	4 Boxes	7"
STH824	8" Fastenmaster ThruLOK Hexhead Screws	24	4 Boxes	8"

Headlok Flathead Screws - FastenMaster

Save time, money, and labor costs. HeadLOK eliminates the need to predrill and hand-ratchet in 3/8 inch galvanized lag screws in wood-to-wood projects. HeadLOK's aggressive threading and sharp gimlet point allows it to zip right into wood or OSB without predrilling. Plus, the wafer head eliminates the need for washers and offers increased pull through strength. Perfect for deck framing, stair stringers, fencing, cabinets, and more! Sizes are perfect for virtually any dimensional wood-to-wood project. HeadLOK fasteners are American made.

FEATURES

- Nationally code compliant stronger design shear values than 3/8 inch lag screws
- No predrilling--zips right in
- Patented Spider Drive virtually eliminates cam-out
- Guaranteed corrosion resistance for the life of the project; ACQ approved
- Free Spider Driver bit in every package



Part#	Description	Pack Qty	Carton Qty	Size
SH278	2-7/8" Fastenmaster Headlok Flathead Screws	50	6 Boxes	2-7/8"
SH278B	2-7/8" Fastenmaster Headlok Flathead Screws	500		2-7/8"
SH45	4-1/2" Fastenmaster Headlok Flathead Screws	50	6 Boxes	4-1/2"
SH45B	4-1/2" Fastenmaster Headlok Flathead Screws	250		4-1/2"
SH6	6" Fastenmaster Headlok Flathead Screws	50	6 Boxes	6"
SH6B	6" Fastenmaster Headlok Flathead Screws	250		6"
SNSD	Spider Drive 2/pk		2	





Concrete Screw

Available in Blue Rustpert Coating or Stainless Steel in various sizes. Includes masonry bit.

Part#	Description	Pack Size	Diameter	Length
SRC*	Hex Head Concrete Screw	100 ct.	3/16" & 1/4"	1-1/4" - 6"
SRCF*	Flat Head Concrete Screw	100 ct.	3/16" & 1/4"	1-1/4" - 6"
SCR*SS	Hex Head Concrete Screw - Stainless	100 ct.	1/4"	1-1/4" - 3-3/4"
SRCF*SS	Flat Head Concrete Screw - Stainless	100 ct.	1/4"	1-1/4" - 3-3/4"



Titen Heavy-Duty Concrete Anchor - Zinc

Hole size required same as shaft diameter.

Part#	Description	Pack Size	Diameter	Length
JHTHDB25178H	Heavy-Duty Concrete Anchor	100 ct.	1/4"	1-7/8"
JHTHDB25*	Heavy-Duty Concrete Anchor	50 ct.	1/4"	2-3/4", 3", 3-1/2", & 4"
JHTHD37*	Heavy-Duty Concrete Anchor	50 ct.	3/8"	3", 4", 5", & 6"
JHTHD50300H	Heavy-Duty Concrete Anchor	25 ct.	1/2"	3"
JHTHD50*	Heavy-Duty Concrete Anchor	20 ct.	1/2"	4", 5", 6", & 8"
JHTHDB62*	Heavy-Duty Concrete Anchor	10 ct.	5/8"	4", 5", 6", & 8"
JHTHD75*	Heavy-Duty Concrete Anchor	5 ct.	3/4"	5" & 8-1/2"



Wedge Anchor - Galvanized

Part#	Description	Coating	Pack Size	Case Qty	Diameter	Length
BWA12275G	Concrete Wedge Anchor	Galvanized	25 ct.	8 Boxes	1/2"	2-3/4"
BWA38275G	Concrete Wedge Anchor	Galvanized	50 ct.	8 Boxes	3/8"	2-3/4"
BWA12375G	Concrete Wedge Anchor	Galvanized	25 ct.	8 Boxes	1/2"	3-3/4"
BWA38375G	Concrete Wedge Anchor	Galvanized	50 ct.	8 Boxes	3/8"	3-3/4"
BWA12425G	Concrete Wedge Anchor	Galvanized	25 ct.	8 Boxes	1/2"	4-1/4"
BWA385G	Concrete Wedge Anchor	Galvanized	50 ct.	8 Boxes	3/8"	5"
BWA1255G	Concrete Wedge Anchor	Galvanized	25 ct.	6 Boxes	1/2"	5-1/2"
BWA586G	Concrete Wedge Anchor	Galvanized	10 ct.	8 Boxes	5/8"	6"



Wedge Anchor - Stainless

Part#	Description	Coating	Pack Size	Case Qty	Diameter	Length
BWA5812G	Concrete Wedge Anchor	Galvanized	10 ct.	4 Boxes	5/8"	12"
BWA12275SS	Concrete Wedge Anchor	Stainless	25 ct.	8 Boxes	1/2"	2-3/4"
BWA38275SS	Concrete Wedge Anchor	Stainless	50 ct.	8 Boxes	3/8"	2-3/4"
BWA12375SS	Concrete Wedge Anchor	Stainless	25 ct.	8 Boxes	1/2"	3-3/4"
BWA38375SS	Concrete Wedge Anchor	Stainless	50 ct.	8 Boxes	3/8"	3-3/4"
BWA12425SS	Concrete Wedge Anchor	Stainless	25 ct.	8 Boxes	1/2"	4-1/4"
BWA385SS	Concrete Wedge Anchor	Stainless	50 ct.	8 Boxes	3/8"	5"
BWA1255SS	Concrete Wedge Anchor	Stainless	25 ct.	6 Boxes	1/2"	5-1/2"
BWA3455SS	Concrete Wedge Anchor	Stainless	10 ct.	6 Boxes	3/4"	5-1/2"
BWA586SS	Concrete Wedge Anchor	Stainless	10 ct.	8 Boxes	5/8"	6"
BWA127SS	Concrete Wedge Anchor	Stainless	25 ct.	6 Boxes	1/2"	7"
BWA347SS	Concrete Wedge Anchor	Stainless	10 ct.	6 Boxes	3/4"	7"



Wedge Anchor - Zinc

Part#	Description	Coating	Pack Size	Case Qty	Diameter	Length
BWA387SS	Concrete Wedge Anchor	Stainless	50 ct.	6 Boxes	3/8"	7"
BWA5885SS	Concrete Wedge Anchor	Stainless	10 ct.	4 Boxes	5/8"	8-1/2"
BWA38225	Concrete Wedge Anchor	Zinc	50 ct.	8 Boxes	3/8"	2-1/4"
BWA12275	Concrete Wedge Anchor	Zinc	25 ct.	8 Boxes	1/2"	2-3/4"
BWA38275	Concrete Wedge Anchor	Zinc	50 ct.	8 Boxes	3/8"	2-3/4"
BWA383	Concrete Wedge Anchor	Zinc	50 ct.	8 Boxes	3/8"	3"
BWA12375	Concrete Wedge Anchor	Zinc	25 ct.	8 Boxes	1/2"	3-3/4"
BWA38375	Concrete Wedge Anchor	Zinc	50 ct.	8 Boxes	3/8"	3-3/4"
BWA12425	Concrete Wedge Anchor	Zinc	25 ct.	8 Boxes	1/2"	4-1/4"
BWA34425	Concrete Wedge Anchor	Zinc	10 ct.	8 Boxes	3/4"	4-1/4"
BWA385	Concrete Wedge Anchor	Zinc	50 ct.	8 Boxes	3/8"	5"
BWA585	Concrete Wedge Anchor	Zinc	10 ct.	8 Boxes	5/8"	5"
BWA1255	Concrete Wedge Anchor	Zinc	25 ct.	6 Boxes	1/2"	5-1/2"
BWA3455	Concrete Wedge Anchor	Zinc	10 ct.	6 Boxes	3/4"	5-1/2"
BWA586	Concrete Wedge Anchor	Zinc	10 ct.	8 Boxes	5/8"	6"
BWA34625	Concrete Wedge Anchor	Zinc	10 ct.	6 Boxes	3/4"	6-1/4"
BWA127	Concrete Wedge Anchor	Zinc	25 ct.	6 Boxes	1/2"	7"
BWA347	Concrete Wedge Anchor	Zinc	10 ct.	6 Boxes	3/4"	7"
BWA587	Concrete Wedge Anchor	Zinc	10 ct.	8 Boxes	5/8"	7"
BWA3485	Concrete Wedge Anchor	Zinc	10 ct.	4 Boxes	3/4"	8-1/2"
BWA5885	Concrete Wedge Anchor	Zinc	10 ct.	4 Boxes	5/8"	8-1/2"
BWA1210	Concrete Wedge Anchor	Zinc	25 ct.	4 Boxes	1/2"	10"



Exterior Structural Screw - Simpson Strong-Tie

Part#	Description	Pack Size	Case Qty.	Length
SDWS22300DB-R50	Exterior Structural Screw - 50 ct.	50	6/Case	3"
SDWS22300DB-RC12	Exterior Structural Screw - 12 ct.	12	10/Case	3"
SDWS22400DB-MB(250)	Exterior Structural Screw - 250 ct.	250	250/Case	4"
SDWS22400DB-R50	Exterior Structural Screw - 50 ct.	50	6/Case	4"
SDWS22400DB-RC12	Exterior Structural Screw - 12 ct.	12		4"
SDWS22500DB-MB(250)	Exterior Structural Screw - 250 CT.	250	250/Case	5"
SDWS22500DB-R50	Exterior Structural Screw - 50 ct.	50	6/Case	5"
SDWS22500DB-RC12	Exterior Structural Screw - 12 ct.	12	10/Case	5"
SDWS22600DB-R12	Exterior Structural Screw - 12 ct.	12	10/Case	6"
SDWS22600DB-R50	Exterior Structural Screw - 50 ct.	50	6/Case	6"
SDWS22800DB-R50	Exterior Structural Screw - 50 ct.	50	6/Case	8"
SDWS22800DB-RC12	Exterior Structural Screw - 12 ct.	12	10/Case	8"
SDWS221000DB-R50	Exterior Structural Screw - 50 ct.	50	6/Case	10"
SDWS221000DB-RC12	Exterior Structural Screw - 12 ct.	12	10/Case	10"





Structural Truss Screw - Simpson Strong-Tie

Part#	Description	Pack Size	Case Qty.	Length
SDWC15450-KT	Structural Truss Screw - replacement for H2.5A	50	6/Case	4-1/2"
SDWC15600-KT(50)	Structural Truss Screw - replacement for H2.5A	50	6/Case	6"
SDWC15600B-KT	Structural Truss Screw - replacement for H2.5A	500/Bucket		6"



FlatLOK Structural Wood Screw - FastenMaster

Part#	Description	Pack Size	Case Qty.	Length
SF45	FlatLOK Flathead Screw	50	6/Case	4-1/2"
SF45B	FlatLOK Flathead Screw Bucket	250		4-1/2"



Tan Deck Screws - PrimeGuard Plus

The PrimeGuard Plus name represents quality and value to professional contractors on jobsites across north America, including the Caribbean. First introduced in 1975, Grip-rite is now the top-selling brand of fasteners in America.

FEATURES

- Rust-oleum certified lifetime guarantee against rust, including when used with treated lumber
- Star drive (driver bit included)
- Type 17 point reduces need to pre-drill boards

Part#	Description	Container Size	Lengths
SDST*	Tan Deck Screw	1 lb, 5 lb, & 25 lb	1-1/4" - 4"



Camo Deck Screws - National Nail

Efficiently constructed to ensure a superior driving force and holding power. Designed to easily penetrate surfaces and provide a clean, professional looking finish. Ideal for a variety of fastening applications.

FEATURES

- Manufactured with quality materials and a solid construction
- Easily penetrates surfaces
- Provides a clean, professional looking finish
- Ideal for treated lumber

Part#	Description	Lengths
SDSC*	Camo Deck Screw	1-1/4" - 4"



Big Timber Construction Screws

	Part#	Description	Length
A	Y1CAB**	Round Washer Head Screw	1 1/4" - 3"
B	Y1FHD**	FH SD Bronze Reamer Screw	1 5/8" - 3 1/4"
C	Y1FS7**	Finish Screw Bronze	1 1/4" - 3"
D	Y1FSR**	Reverse Thread T-10 Finish Screw White	1 1/2" - 3"
E	Y1STH**	316 Stainless Trim Head Screw	2" - 3"
F	Y1TH**	Trim Head Wood Screw Bronze	1-5/8" - 6"
G	YBL1**	Hex Head Log Screw Black	2" - 14"
H	YCTX**	Lag Screw Bronze	1" - 16"
I	YSWD**	Softwood Deck Screw Bronze	2-5/8" - 3-1/8"
J	YWTX**	Wafer Head Screw Black	3" - 8"

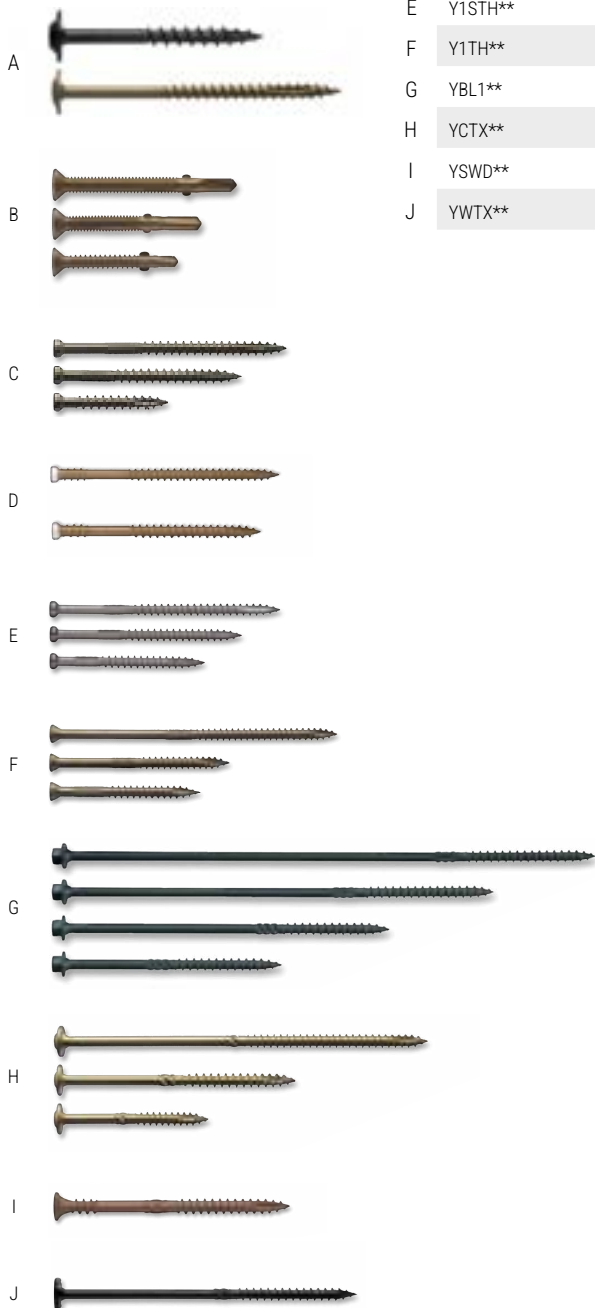

Decking & Railing





SHOWN IN MULTI-CHROMATIC BUNGALOW



SQUARE EDGE



GROOVED EDGE

ACTUAL COLORS MAY VARY.
REQUEST FREE COLOR SAMPLES.

Fiberon® Good Life Composite Deck Board

- Available in 4 two-toned colors
- Also available in 2 standard colors
- 25-year residential limited warranty
- Capped on 3 sides with a tough protective finish
- Never needs staining or painting
- Offers the low maintenance of a composite at a price that's closer to wood

Part#	Description	Size	Length
DGLBG12cc	Fiberon Good Life Deck Board Grooved Edge	0.93" x 5.25"	12'
DGLBG16cc	Fiberon Good Life Deck Board Grooved Edge	0.93" x 5.25"	16'
DGLBG20cc	Fiberon Good Life Deck Board Grooved Edge	0.93" x 5.25"	20'
DGLBS20cc	Fiberon Good Life Deck Board Square Edge	0.93" x 5.25"	20'
DGLF12cc	Fiberon Good Life Fascia Board	0.75" x 11.25"	12'
DGLR12c	Fiberon Good Life Riser Board	0.75" x 7.25"	12'



SHOWN IN WARM SIENNA



SQUARE EDGE



GROOVED EDGE

ACTUAL COLORS MAY VARY.
REQUEST FREE COLOR SAMPLES.

Fiberon® Horizon Composite Deck Board

- Stocked in 4 premium, 2-toned colors
- 50-year residential limited warranty
- Capped on all 4 sides with a tough protective finish for more durability
- Never needs staining or painting
- The perfect combination of natural beauty and advanced composite technology
- Reversible with 2 different patterns top and bottom for more options and less waste

Part#	Description	Size	Length
DHORBG12cc	Fiberon Horizon Deck Board Grooved Edge	0.94" x 5.4"	12'
DHORBG16cc	Fiberon Horizon Deck Board Grooved Edge	0.94" x 5.4"	16'
DHORBG20cc	Fiberon Horizon Deck Board Grooved Edge	0.94" x 5.4"	20'
DHORBS20cc	Fiberon Horizon Deck Board Square Edge	0.94" x 5.4"	20'
DHORF12cc	Fiberon Horizon Fascia Board	0.75" x 11.25"	12'



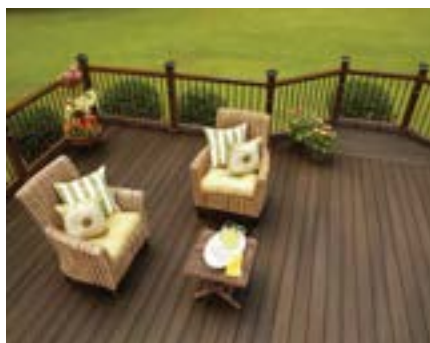

SHOWN IN ESPRESSO



SQUARE EDGE



GROOVED EDGE

ACTUAL COLORS MAY VARY.
REQUEST FREE COLOR SAMPLES.

Fiberon® Sanctuary Composite Deck Board

- Available in 2 multi-toned colors
- 40-year performance warranty and a 40-year stain and fade warranty
- Never needs staining or painting
- Three-sided PermaTech® cap layer provides superior stain and fade resistance.
- The flat-profile bottom provides a sturdy feel, reminiscent of traditional lumber

Part#	Description	Size	Length
DSANBG12cc	Fiberon Sanctuary Deck Board Grooved Edge	0.93" x 5.3"	12'
DSANBG16cc	Fiberon Sanctuary Deck Board Grooved Edge	0.93" x 5.3"	16'
DSANG20cc	Fiberon Sanctuary Deck Board Grooved Edge	0.93" x 5.3"	20'
DSANBS20cc	Fiberon Sanctuary Deck Board Square Edge	0.93" x 5.3"	20'
DSANF12cc	Fiberon Sanctuary Fascia Board	0.75" x 11.25"	12'
DSANR12CC	Fiberon Sanctuary Riser Board	0.75" X 7.25"	12'



SHOWN IN CLIFFSIDE



SQUARE EDGE



GROOVED EDGE

ACTUAL COLORS MAY VARY.
REQUEST FREE COLOR SAMPLES.

Deckorators® Summit Composite Deck Board

Discover the perfect blend of durability and affordability with Summit Decking, crafted with Surestone® technology. Designed to resemble the rich textures of natural wood, it features a low-gloss finish and mineral-based composite construction, ensuring stunning looks and lasting performance.

Part#	Description	Size	Length
DBDSUM12Gcc	Deckorators Summit Deck Board Grooved Edge	0.93" x 5.3"	12'
DBDSUM16GCC	Deckorators Summit Deck Board Grooved Edge	0.93" x 5.3"	16'
DBDSUM20GCC	Deckorators Summit Deck Board Grooved Edge	0.93" x 5.3"	20'
DBDSUM20Scc	Deckorators Summit Deck Board Square Edge	0.93" x 5.3"	20'
DBDSUM12Fcc	Deckorators Summit Fascia Board	0.75" x 11.25"	12'



SHOWN IN DRIFTWOOD

Timbertech® Reserve Collection Composite Deck Board

Bring the charm of reclaimed wood to your space without the rigorous maintenance of wood. Featuring the rustic character and natural beauty of aged wood, our premium polymer capped composite boards deliver real wood aesthetics you'll never have to sand, stain, or seal.

- Made of a mix of high-performance and recycled polymers and reclaimed wood fibers
- Fade, stain, and mold resistant
- Protected with Fade & Stain Limited Warranties for up to 30 years
- Made in the USA from approximately 85% recycled material including plastic bags, milk jugs, and other discarded plastics for an eco-friendly choice



SQUARE EDGE



GROOVED EDGE

ACTUAL COLORS MAY VARY.
REQUEST FREE COLOR SAMPLES.

Part#	Description	Size	Length
DBRESCC12G	Timbertech Reserve Deck Board Grooved Edge	0.94" x 5.36"	12'
DBRESCC16G	Timbertech Reserve Deck Board Grooved Edge	0.94" x 5.36"	16'
DBRESCC20G	Timbertech Reserve Deck Board Grooved Edge	0.94" x 5.36"	20'
DBRESCC20S	Timbertech Reserve Deck Board Square Edge	0.94" x 5.36"	20'
DBRESCC12F	Timbertech Reserve Fascia Board	0.58" x 11.95"	12'
DBRESCC12R	Timbertech Reserve Riser Board	0.58" x 11.95"	12'

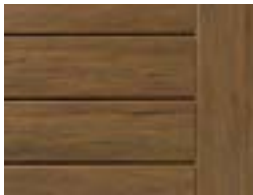



Aluminum Railing - American Series

Outstanding Performance, Exceptional Style

If you're dreaming of beautiful, stress-free outdoor living spaces, our low-maintenance aluminum railing, designed to provide long-lasting attractiveness and safety, is one way to make that outdoor dream a reality. The American Series aluminum railing is engineered to our exacting standards and fabricated and tested in the USA. Both top and bottom railings contain vinyl channels to help secure the balusters and prevent metal-on-metal rattling.

Powder Coating for Durability

Each piece of our aluminum rail is expertly coated with AAMA 2604 powder coating for resistance to sun, heat, and humidity. This powder coating is one of the most economical, longest-lasting, and color-durable finishes on the market today. AAMA 2605 coating is available for architectural projects that require long-term cosmetic and functional protection.

American Series: Smooth and Contemporary

The American Series, with its flat-top railing and contemporary profile, is ideal for any outdoor space.

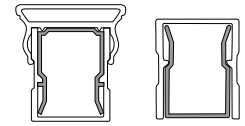

Railing Profile



Aluminum Railing - Level Kit - American Series

Part#	Description	Size
DRA6L36	American Series Aluminum Level Railing Kit with Square Balusters and Hardware - Textured Black	6' x 36"
DRA6L42	SPECIAL ORDER - American Series Aluminum Level Railing Kit with Square Balusters and Hardware - Textured Black	6' x 42"
DRA8L36	American Series Aluminum Level Railing Kit with Square Balusters and Hardware - Textured Black	8' x 36"
DRA8L42	SPECIAL ORDER - American Series Aluminum Level Railing Kit with Square Balusters and Hardware - Textured Black	8' x 42"



Aluminum Railing - Stair Kit - American Series

Part#	Description	Size
DRA6S36	American Series Aluminum Stair Railing Kit with Square Balusters and Hardware - Textured Black	6' x 36"
DRA6S42	SPECIAL ORDER - American Series Aluminum Stair Railing Kit with Square Balusters and Hardware - Textured Black	6' x 42"
DRA8S36	American Series Aluminum Stair Railing Kit with Square Balusters and Hardware - Textured Black	8' x 36"
DRA8S42	SPECIAL ORDER - American Series Aluminum Stair Railing Kit with Square Balusters and Hardware - Textured Black	8' x 42"





Aluminum Railing - Gate - American Series

Part#	Description	Size
DRAG3636	American Series Aluminum Gate - Textured Black	36" x 36"



Gate Hinge

Part#	Description
DRAH	Multi-Adjust Gate Hinge - Black



Gate Latch

Part#	Description
DRAL	Lockable Gate Latch - Black



Aluminum Railing - Posts and Caps - American Series

Part#	Description	Post Size
DRAP**-25	2-1/2" American Series Aluminum Post - Textured Black	38" or 48"
DRAP**-325	3-1/4" American Series Aluminum Post - Textured Black	38" or 48"
DRACF-25	American Series Aluminum Flat Cap - Textured Black	2-1/2"
DRACF-325	American Series Aluminum Flat Cap - Textured Black	3-1/4"
DRAPT-25	American Series Aluminum Post Trim - Textured Black	2-1/2"
DRAPT-325	American Series Aluminum Post Trim - Textured Black	3-1/4"



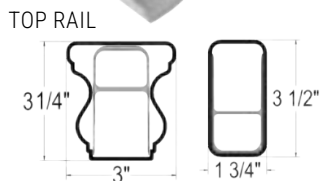
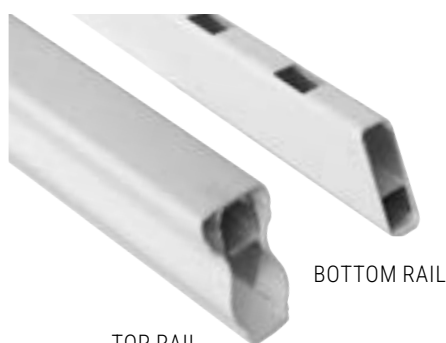

Vinyl Railing - 3000 Series

- 3" Wide Flat-top Rail
- Low Maintenance Premium Vinyl
- Square Balusters
- Aluminum Reinforced Rails
- Easy to Install
- Limited Lifetime Warranty
- Performance Engineered & Tested to ICC Standards
- Boxed Kit Includes: Top & Bottom Rails, Balusters, Mounting Brackets, and Hardware

Part#	Description	Size	Length
DRV6LWM	Vinyl Railing Boxed Level Section - White	36"	6'
DRV8LWM	Vinyl Railing Boxed Level Section - White	36"	8'
DRV10LWM	Vinyl Railing Boxed Level Section - White	36"	10'
DRV6SWM	Vinyl Railing Boxed Stair Section - White	36"	6'
DRV8SWM	Vinyl Railing Boxed Stair Section - White	36"	8'
DRVG4836WM	Vinyl Gate with White Model Balusters	36"	48"



Vinyl Classic Structural Porch Post

Part#	Description	Size	Height
DRVSC	Vinyl Classic Structural Porch Post	4.5 x 4.5	9'

Vinyl Post Sleeves

Part#	Description	Size	Height
VPS444W	Vinyl White Post Sleeve - 0.115 thick	4 x 4	4'
VPS4410W	Vinyl White Post Sleeve - 0.115 thick	4 x 4	10'
VPS9W	Vinyl White Post Sleeve - 0.100 thick	6 x 6	9'
VPS11W	Vinyl White Post Sleeve - 0.100 thick	6 x 6	11'

Galvanized Post Support

Part#	Description	Size
VPM3	Galvanized Post Mount w/ Mounting Supports - Works for 36" and 42"	4"



Vinyl Railing - 3000 Series York

- 3" Wide Flat-top Rail
- Low Maintenance Premium Vinyl
- Black Round Balusters
- Aluminum Reinforced Rails
- Easy to Install
- Limited Lifetime Warranty
- Performance Engineered & Tested to ICC Standards
- Boxed Kit Includes: Top & Bottom Rails, Balusters, Mounting Brackets, and Hardware



Part#	Description	Size	Lg.
DRV6LWYS	York Vinyl Railing Boxed Level Section - White w/ Round Black Balusters	36"	6'
DRV8LWYS	York Vinyl Railing Boxed Level Section - White w/ Round Black Balusters	36"	8'
DRV10LWYS	York Vinyl Railing Boxed Level Section - White w/ Round Black Balusters	36"	10'
DRV6SWYS	York Vinyl Railing Boxed Stair Section - White w/ Round Black Balusters	36"	6'
DRV8SWYS	York Vinyl Railing Boxed Stair Section - White w/ Round Black Balusters	36"	8'
DRVG4836WYS	York Vinyl Gate - White w/ Round Black Balusters	36"	48"



Deckorators® Contemporary Cable Railing

Give your deck project the clean, minimalist lines you're looking for without it blocking the view. With Deckorators® Contemporary Cable Deck Railing, you can add a sleek, finished line to the edges of your deck, making your outdoor space safe and enjoyable year-round.



Part#	Description	Size
DRDC6L36	Cable Railing Level Section Textured Black Aluminum Hardware Included	36"
DRDC6S36	Cable Railing Stair Section Textured Black Aluminum Hardware Included	36"
DRDC8L36	Cable Railing Level Section Textured Black Aluminum Hardware Included	36"
DRDC8S36	Cable Railing Stair Section Textured Black Aluminum Hardware Included	36"
DRDCC10	10' Cable Rail Stainless Steel W/ Hardware	10'
DRDCC20	20' Cable Rail Stainless Steel W/ Hardware	20'
DRDCC30	30' Cable Rail Stainless Steel W/ Hardware	30'
DRDCC50	50' Cable Rail Stainless Steel W/ Hardware	50'
DRDCPC39	Cable Railing Corner Post Textured Black Aluminum Kit W/ Trim Ring & Cap	2-1/2" x 39"
DRDCPE39	Cable Railing End Post Textured Black Aluminum Kit W/ Trim Ring & Cap	2-1/2" x 39"
DRDCPL39	Cable Railing Line Post Textured Black Aluminum Kit W/ Trim Ring & Cap	2-1/2" x 39"
DRDCPSB49	Cable Railing Stair Bottom Post Textured Black Aluminum Kit W/ Trim Ring & Cap	2-1/2" x 49"
DRDCPSM49	Cable Railing Stair Top Post Textured Black Aluminum Kit W/ Trim Ring & Cap	2-1/2" x 49"
DRDCPST39	Cable Railing Stair Top Post Textured Black Aluminum Kit W/ Trim Ring & Cap	2-1/2" x 39"
Y402869	Cable Rail Cut Off Tool	
Y402870	Cable Rail Cable Release Tool	





Vinyl Level Rail Mounting Brackets 3000 Series

Part#	Description
DRVMB-4PER	White Top and Bottom Rail Mounting Brackets - 2 pairs



Vinyl Stair Rail Mounting Brackets 3000 Series

Part#	Description
DRVMBS	White 32°- 36° Stair Railing Brackets - 2 pairs



Vinyl Universal Stair Rail Mounting Bracket 3000 Series

Part#	Description
DRVMBU	White Universal Stair Bracket - 28° to 45°

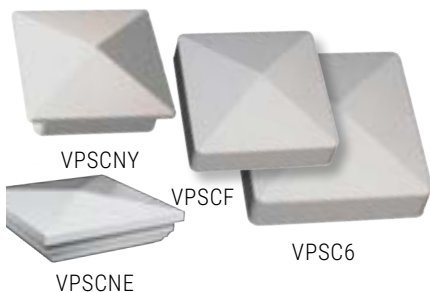

Vinyl Post Cap

Part#	Description	Size
VPSCF	Vinyl Post Cap for 4 x 4 Post - White	4 x 4
VPSC6	Vinyl Post Cap for 6 x 6 Post - White	6 x 6
VPSCNY	Vinyl New York Post Cap for 4 x 4 Post - White	4 x 4
VPSCNE	Vinyl New England Post Cap for 4 x 4 Post - White	4 x 4



Vinyl Post Base Trims

The adjustable base trim comes in 4 pieces 3" x 6.5" that connect together to fit either a 4 x 4 post or a 6 x 6 post

Part#	Description	Size
VPST4	Vinyl Post Plain Trim for 4 x 4 Post - White	4 x 4
VPST6	Vinyl Post Plain Trim for 6 x 6 - White	6 x 6
VPSTM	Vinyl Post Trim Modular Adjustable for 4 x 4 or 6 x 6 Posts - White	-
VPSTN ⁶	Non-Stock Vinyl New England Post Trim for 6 x 6 - White	6 x 6



Always check with your local building code official prior to the installation of railing

Secondary Handrail - 1-1/2" White Aluminum

- Limited lifetime warranty
- Low maintenance
- Easy to install
- Added safety

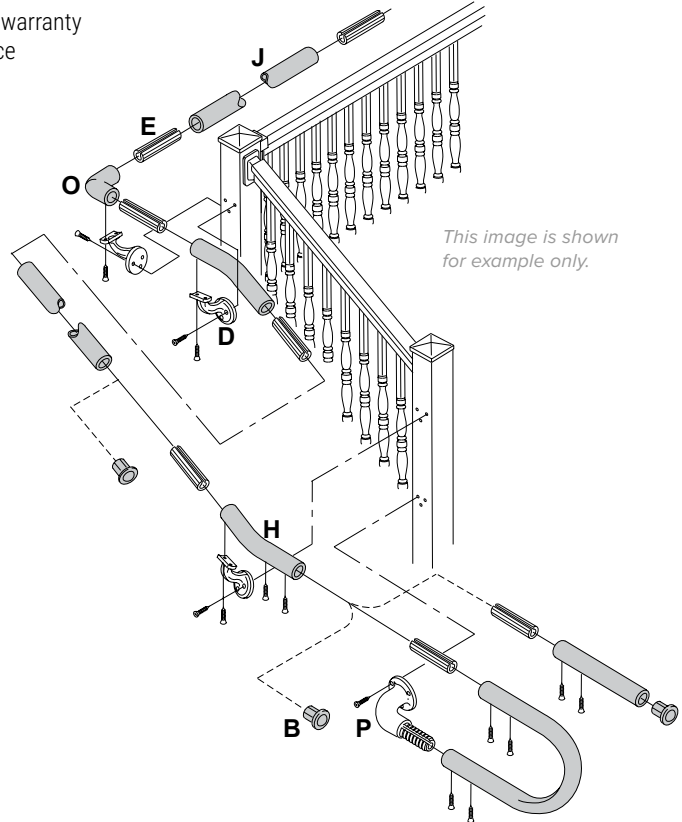

White Vinyl Railing - Superior 200 Series

When you select the 200 Series vinyl railing, you can be confident that you're making an economical choice - without sacrificing performance. Then, when you take a look at this series' baluster, color, and post cap possibilities, you'll see how just how one-of-a-kind your rail can be.

The 200 Series top rail is flat and has an unobstructive $3 \frac{3}{16}$ " profile, while the bottom rail is a simple rectangle. When properly installed, the 200 Series has no visible screws.

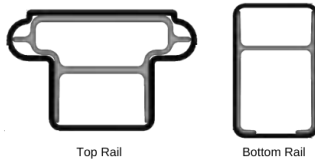

Part#	Description	Size	Lg.
DRV20010LWMS	White Vinyl Railing -Level Section W/ Model Balusters & Hardware Included	36"	10'
DRV2006LWMS	White Vinyl Railing -Level Section W/ Model Balusters & Hardware Included	36"	6"
DRV2006SWMS	White Vinyl Railing -Stair Section W/ Model Balusters & Hardware Included	36"	6"
DRV2008LWMS	White Vinyl Railing -Level Section W/ Model Balusters & Hardware Included	36"	8"
DRV2008SWMS	White Vinyl Railing -Stair Section W/ Model Balusters & Hardware Included	36"	8"
DRV200G4836WMS	White Vinyl Gate - W/ White Model Balusters - Hardware not Included	48" x 36"	
DRV200G4836WWS	White Vinyl Gate - W/ Black Witmer Balusters - Hardware not Included	48" x 36"	
DRV20010LWWS	White Vinyl Railing - Level Section W/ Black Witmer Balusters & Hardware Inc.	36"	10'
DRV2006LWWS	White Vinyl Railing - Level Section W/ Black Witmer Balusters & Hardware Inc.	36"	6'
DRV2006SWWS	White Vinyl Railing - Stair Section W/ Black Witmer Balusters & Hardware Inc.	36"	6'
DRV2008LWWS	White Vinyl Railing - Level Section W/ Black Witmer Balusters & Hardware Inc.	36"	8'
DRV2008SWWS	White Vinyl Railing - Stair Section W/ Black Witmer Balusters & Hardware Inc.	36"	8'
DRV200MBSS	Stair Rail Mounting Bracket 32° - 36° (2-pairs) For 200 Series White Vinyl Rail.		
DRV200MB-4PERS	Level Rail Mounting Bracket (2-pairs)(For 200 Series White Vinyl Railing)		





Secondary Handrail - End Cap

Part#	Description
DRASBEC	Secondary Handrail - (B) End Cap - White

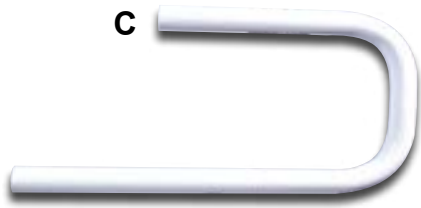

Secondary Handrail - P-Loop Return

Part#	Description
DRASCLR	Secondary Handrail - (C) P-Loop Return - White



Secondary Handrail - Mounting Bracket

Part#	Description
DRASDMB	Secondary Handrail - (D) 3" Mounting Bracket - White
DRASLCM	Secondary Handrail - (L) 6" Corner Mounting Bracket - White
DRASNMB	Secondary Handrail - (N) Mounting Bracket Insert

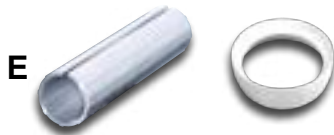

Secondary Handrail - Aluminum Connector Rail

Part#	Description
DRASEAC	Secondary Handrail - (E) Aluminum Connector Rail - White



Secondary Handrail - Straight Handrail

Part#	Description	Size
DRASJHR	Secondary Handrail - (J) 104" Straight Handrail with Aluminum Insert - White	1-1/2" x 104"



Secondary Handrail - Elbows

Part#	Description	Size
DRASFHE	Secondary Handrail - (F) 5 Degree Radius Elbow - White Aluminum	24"
DRASHSE	Secondary Handrail - (H) 34 Degree Radius Elbow - White Aluminum	24"
DRASKIE	Secondary Handrail - (K) 90 Degree Inside Elbow - White Aluminum	24"
DRASOOE	Secondary Handrail - (O) Outside Elbow - White Aluminum	
DRASPEB	Secondary Handrail - (P) 90 Degree Elbow Bracket - White Aluminum	
DRASMUE	Secondary Handrail - (M) 0 to 90 Degree Universal Elbow - Aluminum	

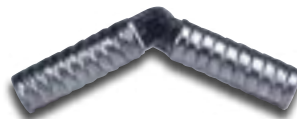
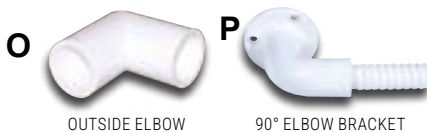

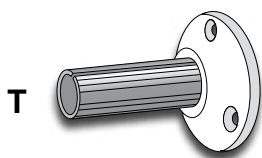

Secondary Handrai Straight Aluminum Wall Bracket

Part#	Description
-------	-------------

DRASTWB	Secondary Handrail - (T) Straight Aluminum Wall Bracket - White
---------	---

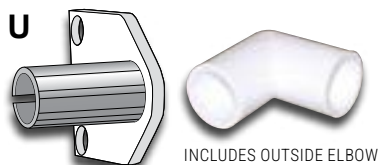

Secondary Handrail - Aluminum Gate Return Kit

Part#	Description
-------	-------------

DRASUGR	Secondary Handrail - (U) Aluminum Gate Return Kit with Outside Elbow - White
---------	--



Treated Wood Balusters

Part#	Description	Size
-------	-------------	------

LT2242	Treated Wood Balusters - Tapered 1 End	2 x 2 x 42"
--------	--	-------------



4 x 4 Treated Post

Part#	Description	Size	Length
-------	-------------	------	--------

LT448	Treated Post - .15 Ground Contact	4 x 4	8'
LT4410	Treated Post - .15 Ground Contact	4 x 4	10'
LT4412	Treated Post - .15 Ground Contact	4 x 4	12'
LT4416	Treated Post - .15 Ground Contact	4 x 4	16'



Treated Yellow Pine Deck Boards

Rounded edges. Available in 2' increments

Part#	Description	Size	Lengths
-------	-------------	------	---------

LT546**	Standard Treated Yellow Pine	5/4 x 6	8' - 16'
LT546**1	Premium Treated Yellow Pine	5/4 x 6	12', 16', & 20'



Deck Joist Tape

DECK JOIST TAPE™ is a self-adhering, cold-applied tape used as flashing on deck ledger boards and joists to help prevent moisture penetration around properly installed fasteners. Provides a non-corrosive barrier between treated lumber and metal hangers. Its Super Stick Technology™ adhesive can stick to damp wood joists, doesn't require a primer and can be applied down to -20°F (-28°C) and also used in high temperature applications.

Part#	Description	Size
-------	-------------	------

DTAPE2	Protecto Super Stick Deck Joist Tape Down	2" x 50'
DTAPE4	Protecto Super Stick Deck Joist Tape Down	4" x 50'
DTAPE158	Camo Deck Joist Tape	1-5/8" x 65'
DTAPE318	Camo Deck Joist Tape	3-1/8" x 65'
DTAPE6	Camo Deck Joist Tape	6" x 65'





T&G KDAT Porch Flooring

3" Coverage. Kiln Dried After Treatment

Part#	Description	Size	Lengths
LKDAT54412	T&G KDAT Porch Flooring	5/4 x 4	12
LKDAT54416	T&G KDAT Porch Flooring	5/4 x 4	16



Camo Drive Deck Fastening Tool Attachment

Part#	Description
DCD	Camo Drive Deck Fastening Tool Attachment For Collated Screws And Edge Clip
DCDBT15	Replacement T15 Drive Long Bit For Camo Drive Deck Fastening Tool - 2-pack
DCDBT20	Replacement T ²⁰ Drive Long Bit For Camo Drive Deck Fastening Tool - 2-pack



EDGE GUIDE



CLIP GUIDE



FACE GUIDE



Tiger Claw Hidden Deck Fastener



Part#	Description	Box Qt.
DTC90	TC-G Deck Fastener for Grooved Boards - w/ Screws	90



Tiger Claw Pneumatic Screws

Part#	Description	Box Qt.
DTCS	Tiger Claw Screws	930
DTC900	TC-G Deck Fastener for Grooved Boards - No Screws	900



Tiger Claw Pneumatic Gun

Part#	Description
DTCGUN	Tiger Claw Pneumatic Gun



Edge Clip Hidden Deck Fasteners

For EdgeClip, setting the clip could not be easier. Simply attach each clip to each joist, slide the board in place, then move to the next board. You can set multiple boards before driving the screws. For use with common 90° decking pattern. Includes (1) Never-Miss™ Guide and (1) Driver Bit.

Part#	Description	Qty.	Size
DCDE90	Edge Clip Hidden Deck Fasteners Compatible With Camo Drive	90 pcs.	2-3/8"
DCDE450	Edge Clip Hidden Deck Fasteners Compatible With Camo Drive	450 pcs.	2-3/8"
DCDE900	Edge Clip Hidden Deck Fasteners Compatible With Camo Drive	900 pcs.	2-3/8"



WEDGE™ Clips - CAMO Fasteners

- WEDGE Clips are for grooved wood, composite, and PVC deck board installations in any deck pattern on wood joists
- Clips are designed and warranted for use with the leading grooved deck boards
- Pre-assembled, one-pass fasteners require no partial installation—clips stay in place until you're ready to fasten
- Stronger than competitors' clips in reducing lateral movement and superior in uplift holding power
- Do not use impact drivers to fasten CAMO Clips
- Plastic spacer creates $\frac{3}{16}$ in. (4.7mm) spacing
- T-15 Driver Bit included



Part#	Description	Qty.	Size
DCDW90	Wedge Clip Hidden Deck Fasteners	90 pcs.	1-3/4"
DCDW450	Wedge Clip Hidden Deck Fasteners	450 pcs.	1-3/4"
DCDW900	Wedge Clip Hidden Deck Fasteners	900 pcs.	1-3/4"
DCDW90M	Wedge Clip Hidden Deck Fasteners - SD Metal Screws	90 pcs.	1-3/4"
DCDW450M	Wedge Clip Hidden Deck Fasteners - SD Metal Screws	450 pcs.	1-3/4"

Phantom Universal Hidden Deck Fasteners- Fiberon

The Fiberon Phantom Universal Hidden Fastener is easy to install, helps minimize lateral board movement, and is priced right. The Universal Fastener is constructed of polypropylene and comes equipped with a pre-inserted screw that enables easy 1 touch installation.

- Screw removes easily to swap out a damaged board
- Carbon steel-coated screw helps prevent rust and corrosion.
- Black HDPE fastener with pre-inserted screw practically disappears between deck boards.
- Self-gapping design ensures consistent $\frac{3}{16}$ in. spacing between every board.
- For use with PE decking only

Part#	Description	Qty.
DCDP90	Phantom Universal Hidden Deck Fasteners	90 pcs.



DCDES



DCDFS

Collated Deck Fasteners

Part#	Description	Qty.	Size
DCDES	Collated Edge Screws For Camo Drive	1000 pcs.	2-3/8"
DCDFS	Collated Face Screws For Camo Drive	1000 pcs.	3"



Horse Stall Components

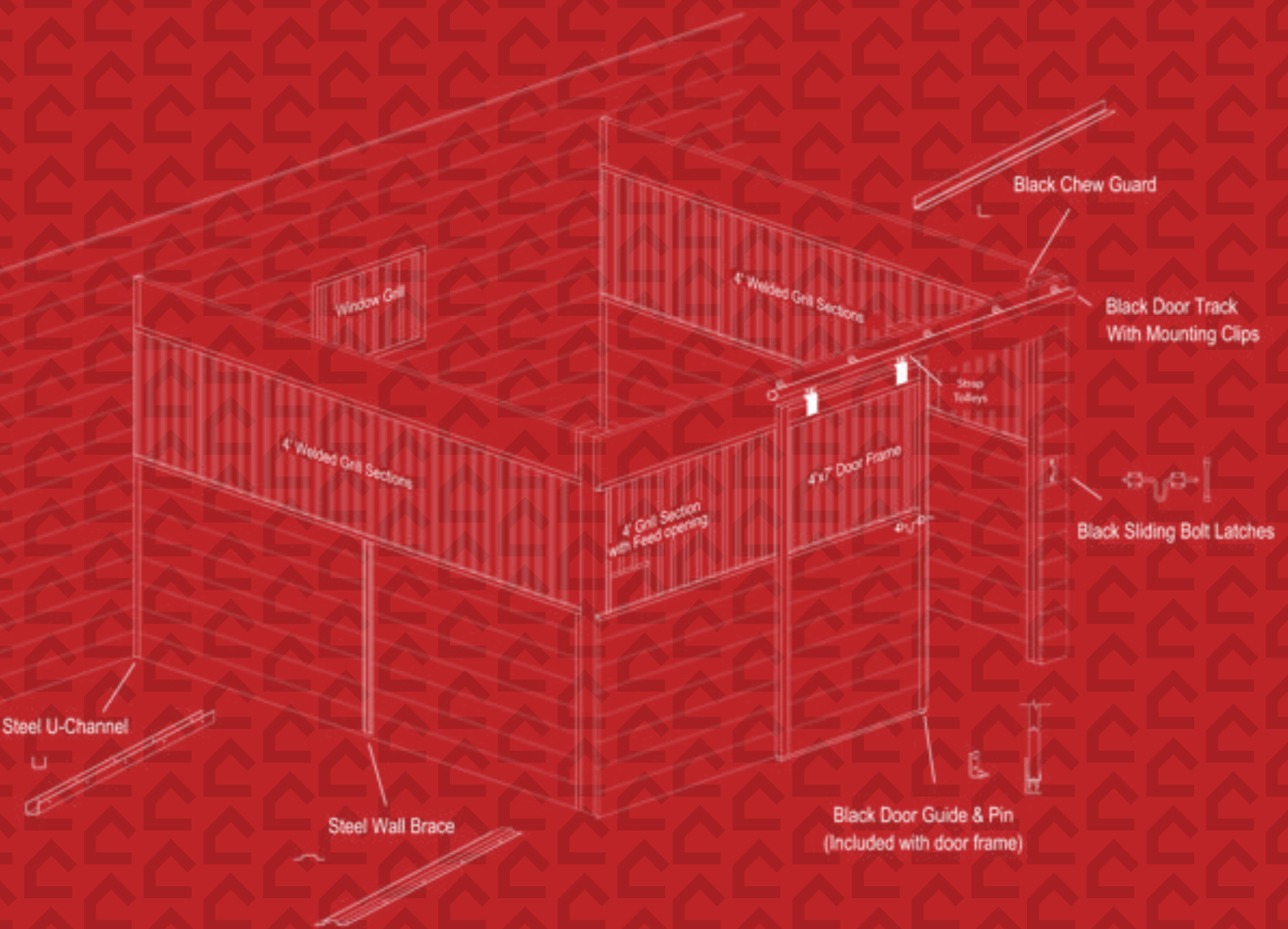

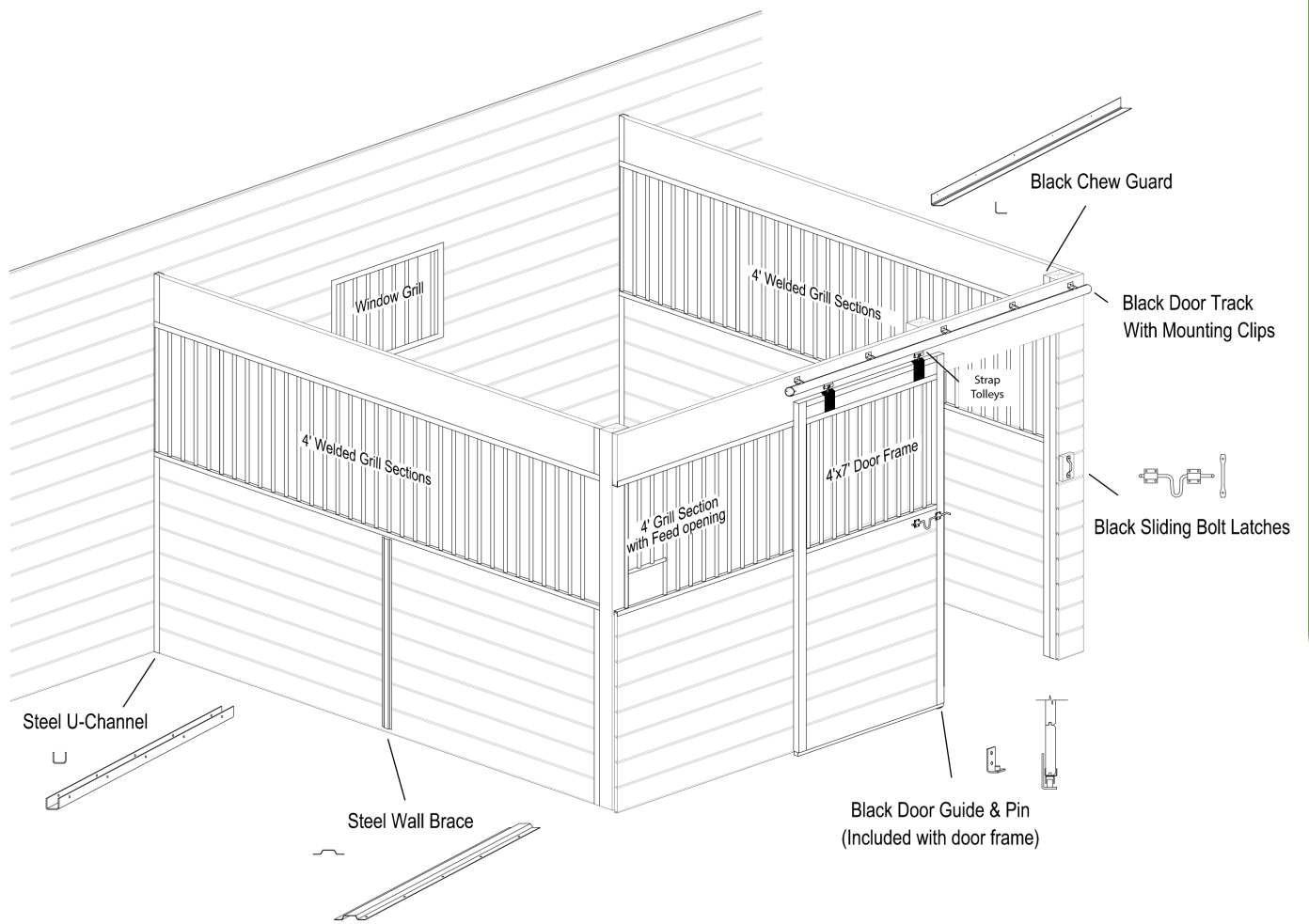

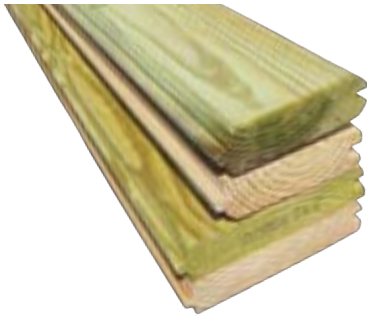

Tongue and Groove Pine (see Lumber)

Beautiful & durable horse stalls are constructed with tongue & groove southern yellow pine 2x6 or 2x8 lumber fronts and partitions. All wood is surfaced on 4 sides for a smooth finish. Use treated lumber for the bottom two rows to resist rot and decay from contact with ground and manure. Yellow Pine is a beautiful wood that provides unequalled strength and accepts finishes well. The tongue and groove design provides a unified construction for strength and durability. Combine this with our powder-coated grilles and accessories for a truly finished appearance.



Rubber Horse Stall Mat

Part#	Description	Size
HSMAT	Rubber Horse Stall Mat	72" x 48" x 3/4"



Chew Guard/Corner Angle

Part#	Description	Size	Length
HSCG4	Powder Coated Black Chew Guard - 20 Ga. Steel	1-1/2" x 1-1/2"	4'
HSCG	Powder Coated Black Chew Guard - 20 Ga. Steel	1-1/2" x 1-1/2"	8'



U-Channel

Part#	Description	Length
HSUC4	Powder Coated Black U Channel - 14 Ga. Steel	4'
HSUC8	Powder Coated Black U Channel - 14 Ga. Steel	8'



Wall Brace/Hat Channel

Part#	Description	Length
HSWB4	Powder Coated Black Wall Brace	4'
HSWB	Powder Coated Black Wall Brace	8'



Window Grill

Part#	Description	Size (w h)
HSWG32	Powder Coated Black Window Grill	35.5" x 23.5"
HSWG33	Powder Coated Black Window Grill	35.5" x 35.5"
HSWG3644	Powder Coated Black Window Grill	35.5" x 43.5"
HSWG3648	Powder Coated Black Window Grill	35.5" x 47.5"
HSWG43	Powder Coated Black Window Grill	47.5" x 35.5"



Solid Grill

Part#	Description	Size (w h)
HSGS2	Powder Coated Black Solid Grill - 14 ga	24" x 34"
HSGS4	Powder Coated Black Solid Grill - 14 ga	48" x 34"



Grill with Feeder Opening

Part#	Description	Feeder Opening	Size (w h)
HSG4FO	Powder Coated Black Grill with Feeder Opening	10" x 11"	48" x 34"



Swing-out Feeder Door

Part#	Description	Size (w h)
HSG2FD	Powder Coated Black Feeder Door	24" x 34"



Black Philip Pan Head Screw

Part#	Description	Length
HSS1BL	#12 Horse Stall Pan Head #3 Philip Screw Black - 100/bag	1-1/4"





Wall Hay Rack

Part#	Description	Width	Height	Depth
HSWHR	Powder Coated Black Wall Hay Rack	25"	26"	12"



Corner Hay Rack

Part#	Description	Width	Height	Depth
HSCHR	Powder Coated Black Corner Hay Rack	28-1/2"	26"	18-1/4"



Blanket Bar

Part#	Description	Width
HSBB	Powder Coated Black Blanket Bar w/ Bridle Hook	36"

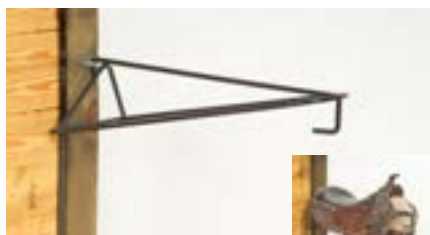

Portable Saddle Rack

Part#	Description	Width	Height	Length
HSPSR	Powder Coated Black Portable Saddle Rack	12-1/4"	14-2/8"	31-3/16"



Portable Wall Mount Pail Holder

Part#	Description	O. Diameter	Height
HSPFMPH	Powder Coated Black Portable Wall Mount Pail Holder	14-1/4"	9-5/8"



Door Frame with Grill

Includes powder coated black Top Cap, Guide Channel, and Guide Pin.
Tongue and Groove Lumber Not Included.

Part#	Description	Size
HSD4G	Powder Coated Black Door Frame with Grill	4' x 7'



Door Frame with Yoke Grill

Includes powder coated black Top Cap, Guide Channel, and Guide Pin.
Tongue and Groove Lumber Not Included.

Part#	Description	Size
HSYD	Powder Coated Black Door Frame with Yoke Grill	4' x 7'



Top Mount Door Latch

Part#	Description	Size
HSTML	Top Mount Door Latch for Sliding Horse Stall Door	38.5" x 15"



Sliding Bolt Latch

Part#	Description	Size
HSBSBL	Powder Coated Black Sliding Bolt Latch	10" x 5"
HSBBLH	Powder Coated Black Horseshoe Sliding Bolt Latch	10" x 6"





Black Track and Trolley Systems

Part#	Description	Length
HSBWDT	Pair Black Strap Trolley (Endcaps Sold Separately)	
HSBT8	Black Side Mount Track W/Hangers	8'
HSBTEC	Black End Cap	



Black Non-Adjustable Door Stop

Part#	Description
HSBDS	Black Non-Adjustable Door Stop



Guide Pin

Part#	Description
HSGPO	Powder Coated Black Guide Pin



Black Flat Track Rails - Exterior or Interior

Part#	Description	Length
TFT6	Black Flat Track Rail with Mounting Hardware	6'
TFT8	Black Flat Track Rail with Mounting Hardware	8'
TFT10	Black Flat Track Rail with Mounting Hardware	10'

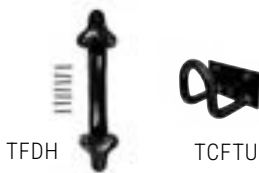

Black Flat Track Accessories - Exterior or Interior

Part#	Description	Size
TCFDH	Black Flat Track Door Handle with Six 1-1/4" Screws	11" x 2"
TCFTU	Black Flat Track Bottom Guide U Keeper	2-1/4"
TCFDG	Black Flat Track Bottom Door Guide Stay Roller	
HSSRB	Black Adjustable Small Stay Roller	

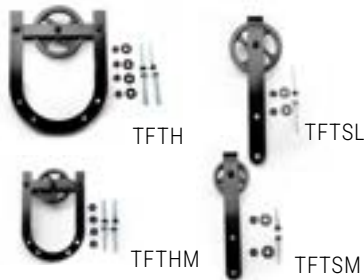

Black Flat Track Trolleys - Exterior or Interior

Part#	Description	Size
TFTH	Black Flat Track U-Trolley	11.5" L x 9" W x 2.75" D
TFTHM	Mini Black Flat Track U-Trolley	7.5" L x 5.25" W x 2.75" D
TFTS	Black Flat Track Strap Trolley	14" L x 1.5" W x 3.5" D
TFTSM	Mini Black Flat Track Strap Trolley	11" L x 1.25" W x 2.75" D





DDWR

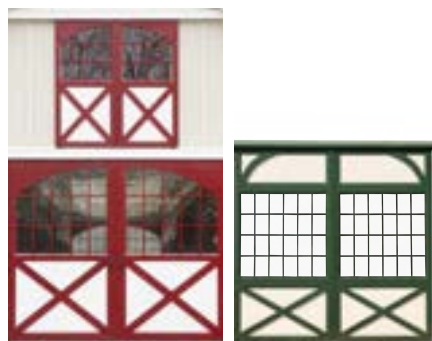

Wood Dutch Door

- Comes with black latch and hinges and black chew guard.
- Hinges on Left or Right when standing on the outside, facing the door
- This Tongue & Groove door can be painted or stained to match your building colors
- Easy to install and easy to use

Part#	Description	Rough Opening	Size
DDW44	Wood Dutch Door With Cross Buck		4' x 4'
DDWL	Wood Dutch Door With Cross Buck	52" x 86.5"	4' x 7'
DDWR	Wood Dutch Door With Cross Buck	52" x 86.5"	4' x 7'

Steel Dutch Door

- Powder-coated to the color combination of your choice
- Will not rot
- Heavy-duty

Part#	Description	Rough Opening*	Size
DDS44	Classic Steel Dutch Door - Half	48.25" X 42.75"	4' x 42"
DDS	Classic Steel Dutch Door	48.75" X 84.75"	4' x 7'

*Rough Opening size is 1/2" larger than actual size.

Aluminum Dutch Door

- Lightweight but equal in strength to steel
- Rust and rot proof
- Window options available
- Made to the color combination of your choice

Part#	Description	Rough Opening*	Size
DDA	Economy Aluminum Dutch Door	48.75" X 84.75"	4' x 7'

*Rough Opening size is 1/2" larger than actual size.

Aluminum Split Slider Dutch Door - Special Order

- Economy or Elite Grade
- Lightweight but equal in strength to steel
- Rust and rot proof
- Tempered glass window options available including arch tops
- Many size and color combinations available

Part#	Description
DDSS	Aluminum Split Slider Dutch Door with Window



Cupolas & Weathervanes





16" Cupola

- Preassembled in 2 pieces for fast installation
- Only available with vented louvers

Part#	Description	Size	Height
CUP16	16" Standard Cupola	16" x 16"	25"

All cupolas are made-to-order. Please reference our color charts for cupola color options.
Height measured from roof peak to cupola roof peak.



24" Cupola

- Preassembled in 2 pieces for fast installation
- Available with vented louvers or windows
- Copper roof upgrade also available

Part#	Description	Size	Height
CUP24	24" Cupola	24" x 24"	36"

All cupolas are made-to-order. Please reference our color charts for cupola color options.
Height measured from roof peak to cupola roof peak.



36" Cupola

- Preassembled in 2 pieces for fast installation
- Available with vented louvers or windows
- Copper roof upgrade also available

Part#	Description	Size	Height
CUP36	36" Cupola	36" x 36"	48"

All cupolas are made-to-order. Please reference our color charts for cupola color options.
Height measured from roof peak to cupola roof peak.



48" Cupola

- Fully assembled for fast installation
- Available with vented louvers or windows
- Copper roof upgrade also available

Part#	Description	Size	Height
CUP48	48" Cupola	48" x 48"	61"

All cupolas are made-to-order. Please reference our color charts for cupola color options.
Height measured from roof peak to cupola roof peak.



Replacement Cupola Cap

Part#	Description	Size
CUPCAP	Black Aluminum Cupola Top Cap with Screw Pack	4" x 4"





46" Eagle Weathervane

Painted Gold Bronze Ornament on Black Cast Aluminum.

Part#	Description	Ornament Size	Height
CUPWV46EAG	Eagle Gold Bronze - Cast Aluminum Weathervane	15" L x 17" H	46"



46" Yacht Weathervane

Painted Gold Bronze Ornament on Black Cast Aluminum.

Part#	Description	Ornament Size	Height
CUPWV46SAI	Sailboat Gold Bronze - Cast Aluminum Weathervane	18.25" L x 13.75" H	46"



46" Rooster Weathervane

Painted Gold Bronze Ornament on Black Cast Aluminum.

Part#	Description	Ornament Size	Height
CUPWV46ROO	Rooster Gold Bronze - Cast Aluminum Weathervane	12.5" L x 12" H	46"



46" Horse Weathervane

Painted Gold Bronze Ornament on Black Cast Aluminum.

Part#	Description	Ornament Size	Height
CUPWV46HOR	Horse Gold Bronze - Cast Aluminum Weathervane	14" L x 11.25" H	46"



Horse Weathervane

Rust-proof cast aluminum that is painted black.

Part#	Description	Ornament Size	Height
CUPWV24HOR	Horse Black - Cast Aluminum Weathervane	10" L x 7" H	24"
CUPWV30HOR	Horse Black - Cast Aluminum Weathervane	10.5" L x 7" H	30"

Rooster Weathervane

Rust-proof cast aluminum that is painted black.



Part#	Description	Ornament Size	Height
CUPWV24R00	Rooster Black - Cast Aluminum Weathervane	6" L x 7" H	24"
CUPWV30R00	Rooster Black - Cast Aluminum Weathervane	7" L x 8.5" H	30"

30" Sailboat Weathervane

Rust-proof cast aluminum that is painted black.



Part#	Description	Ornament Size	Height
CUPWV30SAI	Sailboat Black - Cast Aluminum Weathervane	7" L x 8" H	30"

30" Pheasant Weathervane

Rust-proof cast aluminum that is painted black.



Part#	Description	Ornament Size	Height
CUPWV30PHE	Pheasant Black - Cast Aluminum Weathervane	13.5" L x 8.75" H	30"

30" Tractor Weathervane

Rust-proof cast aluminum that is painted black.



Part#	Description	Ornament Size	Height
CUPWV30TRA	Tractor Black - Cast Aluminum Weathervane	6" L x 8" H	30"





30" Buck Weathervane

Rust-proof cast aluminum that is painted black.

Part#	Description	Ornament Size	Height
CUPWV30BUC	Buck Black - Cast Aluminum Weathervane	9.5" L x 10.75" H	30"



30" Cow Weathervane

Rust-proof cast aluminum that is painted black.

Part#	Description	Ornament Size	Height
CUPWV30COW	Cow Black - Cast Aluminum Weathervane	11" L x 7" H	30"



30" Duck Weathervane

Rust-proof cast aluminum that is painted black.

Part#	Description	Ornament Size	Height
CUPWV30DUC	Duck Black - Cast Aluminum Weathervane	8" L x 11" H	30"



Eagle Weathervane

Rust-proof cast aluminum that is painted black.

Part#	Description	Ornament Size	Height
CUPWV24EAG	Eagle Black - Cast Aluminum Weathervane	5.5" L x 8.75" H	24"
CUPWV30EAG	Eagle Black - Cast Aluminum Weathervane	9.75" L x 11.25" H	30"



30" Pig Weathervane

Rust-proof cast aluminum that is painted black.

Part#	Description	Ornament Size	Height
CUPWV30PIG	Pig Black - Cast Aluminum Weathervane	9.5" L x 5.5" H	30"



30" Antique Auto Weathervane

Rust-proof cast aluminum that is painted black.

Part#	Description	Ornament Size	Height
CUPWV30CAR	Antique Auto Black - Cast Aluminum Weathervane	11" L x 6" H	30"



Country Doctor Weathervane

Rust-proof cast aluminum that is painted black.

Part#	Description	Ornament Size	Height
CUPWV24DOC	Country Doctor Black - Cast Aluminum Weathervane	12.5" L x 6.25" H	24"
CUPWV30DOC	Country Doctor Black - Cast Aluminum Weathervane	13.5" L x 6" H	30"



Spear Weathervane

Get the classic look with the spear weathervane. Can be installed with or without the directionals.

Part#	Description	Ornament Size	Height
CUPWV30SPE	Spear Black - Cast Aluminum Weathervane	15.5" H	30"



30" Black Lab Weathervane

Rust-proof cast aluminum that is painted black.

Part#	Description	Ornament Size	Height
CUPWV30LAB	Black Lab Black - Cast Aluminum Weathervane	10.25" L x 8.5" H	30"



30" Golden Retriever Weathervane

Rust-proof cast aluminum that is painted black.

Part#	Description	Ornament Size	Height
CUPWV30GOL	Golden Retriever Black - Cast Aluminum Weathervane	11.5" L x 8.5" H	30"





Flat Base

Part#	Description
CUPWVBF	Flat Base For Mounting Weathervane On Flat Surface

PLEASE NOTE: The Flat Base comes by default with all weathervane orders. If another mounting option is desired, please specify when you place your order.

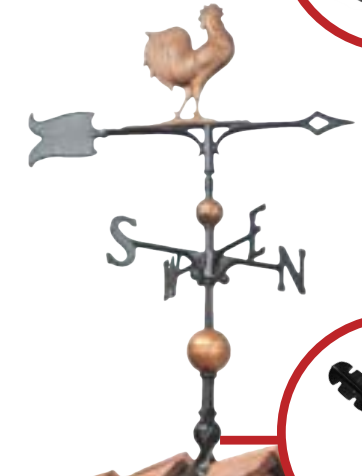
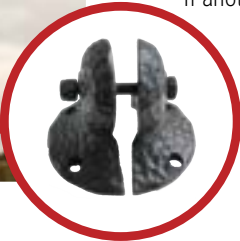

Clutch Base

Part#	Description
CUPWVBC	Clutch Base For Mounting Weathervane On Roof Peak

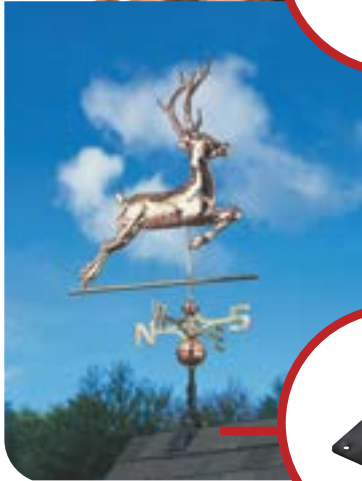

Flat Base for Copper Weathervanes

Designed for attaching Copper weathervanes to the top of ABMartin Cupolas. Heavy-duty stainless steel that is powder coated black. Attaches to the top of an ABMartin Cupola and receives the 3/4" weathervane rod.

Part#	Description
CUPWVBF	Flat Base for Copper Weathervanes (Rod-Based) Stainless Steel Powder Coated Black



Replacement Directionals

Part#	Description
CUPWVDNS	North-South Directional for 30" Weathervane
CUPWVDEW	East-West Directional for 30" Weathervane
CUPWVDNS46	North-South Directional for 46" Weathervane
CUPWVDEW46	East-West Directional for 46" Weathervane

Special Order Weathervanes

The following weathervane options are available for special order:

46" Traditional Full-Bodied Weathervanes (Gold-Bronze, Painted Copper, or Painted Verdigris)

- Eagle
- Yacht
- Horse
- Rooster

30" Full-Bodied Weathervanes (Gold-Bronze, Painted Copper, or Painted Verdigris)

- Rooster
- Eagle
- Horse
- Country Doctor

30" Weathervanes (Black for Rooftop or Garden)

- Pheasant
- Tractor
- Buck
- Cow
- Duck
- Eagle
- Pig
- Antique Auto
- Country Doctor
- Clipper Ship
- Mare & Colt
- Trout
- Moose
- Schooner
- Bear
- Cat
- Golfer
- Lighthouse
- Locomotive
- Elk
- German Shepherd
- Fire Wagon

24" Weathervanes (Black)

- Retriever
- Sailboat
- Pheasant



Windows





3500 Single-Hung Vinyl Window - Mi Windows

The 3500 Single-Hung Window is one of MI's best vinyl windows. This vinyl single-hung window offers handcrafted quality, exceptional durability, and optimal energy efficiency. With standard features that include a pre-punched mounting fin and removable sash, our 3500 window is ideal for any new construction project. A full-length lift rail and metal reinforcements at the meeting rail provide aesthetic and performance benefits that complement the window's builder-friendly attributes.

FEATURES

- Vinyl Tilt Single Hung
- Coil Spring Balance System
- Two Cam Locks at Meeting Rail
- Easy Sash and Fixed Glass Removal for Drywall Pass-through
- Decorative Grids Between the Glass
- Half Screen Available in Char-Fiber, Char-Alum or Brite-Alum Mesh
- Complete Specialty Window and Mulling Accessories Available
- Continuous Head and Sill Available
- Continuous Jamb Available
- Intercept™ Insulating Glass Spacer System on Single Hung Units
- DuraSeal® Spacer System on Specialties
- Snap-in Brickmould Profiles Available
- Integral J-Channel Available at no Extra Cost (Must Specify When Ordering)
- Double-hung windows available for special order.
- High DP Version Available
- AAMA and NFRC Labeled
- Energy Star Qualified

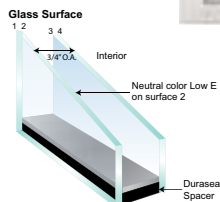

Meets ENERGY STAR® requirements in North, North-Central, and South Central Zones.



Part#	Description	J Type	W/Grids	Size	R/O Size
WSH2436	Single Hung Vinyl Window - White	Integral	•	23¾" x 35¾"	24" x 36"
WSH2836	Single Hung Vinyl Window - White	Integral	•	27¾" x 35¾"	28" x 36"
WSH2844	Single Hung Vinyl Window - White	Integral	•	27¾" x 43¾"	28" x 44"
WSH2848	Single Hung Vinyl Window - White	Integral	•	27¾" x 27¾"	28" x 48"
WSH3236	Single Hung Vinyl Window - White	Integral	•	31¾" x 35¾"	32" x 36"
WSH3636	Single Hung Vinyl Window - White	Integral	•	35¾" x 35¾"	36" x 36"
WSH3644	Single Hung Vinyl Window - White	Snap-on	•	35¾" x 43¾"	36" x 44"
WSH3644B	Single Hung Vinyl Window - Beige/Almond	Snap-on	•	35¾" x 43¾"	36" x 44"
WSH3644J	Single Hung Vinyl Window - White	Snap-on	•	35¾" x 43¾"	36" x 44"
WSH3648	Single Hung Vinyl Window - White	Integral	•	35¾" x 47¾"	36" x 48"
WSH3648J	Single Hung Vinyl Window - White	Snap-on	•	35¾" x 47¾"	36" x 48"
WSH3648SJ	Single Hung Vinyl Window - White	Snap-on		35¾" x 47¾"	36" x 48"

Many Additional Sizes and Color Options available for Special Order



3580 Single Side-Slider Vinyl Window - Mi Windows

Dual-cam locks, brass roller system, and metal reinforcements at the meeting rail provide aesthetic and performance benefits that complement the window's builder-friendly attributes.

Part#	Description	J Type	Size	R/O Size
WSS3020	Single Side-Slider Vinyl Window - White	Integral	35¾" x 23¾"	36" x 24"
WSS3030	Single Side-Slider Vinyl Window - White	Integral	35¾" x 35¾"	36" x 36"
WSS4030	Single Side-Slider Vinyl Window - White	Integral	47¾" x 35¾"	48" x 36"
WSS4040	Single Side-Slider Vinyl Window - White	Integral	47¾" x 47¾"	48" x 48"





Double-Hung Vinyl Window

The 1556 vinyl double-hung new construction window offers crafted features that provide exceptional durability, energy efficiency, and ease of installation. Featuring a stylish beveled exterior profile, true-sloped sill, tilt-in sashes, and brickmould accessory, the 1556 is an aesthetically pleasing window that offers enhanced curb appeal for any building. Includes half screen.

Part#	Description	W/Grids	Size	R/O Size
WDH3648	Double-Hung Vinyl Window - White	•	35¾" x 47¾"	36" x 48"
WDH3660	Double-Hung Vinyl Window - White	•	35¾" x 59¾"	36" x 60"
WDH ³⁶⁴⁸ NG	Double-Hung Vinyl Window - White - No Grids		35¾" x 47¾"	36" x 48"
WDH ³⁶⁶⁰ NG	Double-Hung Vinyl Window - White - No Grids		35¾" x 59¾"	36" x 60"

SPECIAL ORDER - VARYING LEAD TIMES



If it seems like everyone in your neighborhood has double hung windows, that's because they are the most popular window type in the U.S.

ProVia double hung replacement windows are available with a wide variety of options, depending on the brand you choose. Window options include clear, decorative or stained window glass, privacy or tinted glass, grids, interior blinds, and energy-efficient glass packages.



Non-Insulated Single-Hung Aluminum Window

- Interlocking meeting rails provide additional security and structural performance
- Quality pile weather-stripping at sash head and jambs for maximum weather resistance
- Soft vinyl bulb gasket for additional weather seal
- Sloped sill and large built-in weep holes for superior drainage
- Jambs notched for multiple opening positions with spring loaded latches
- Nylon glides enable easy window sash operation
- Attractive angled glazing bead
- (.154") Thicker standard glass
- UV Protected

Part#	Description	W/Grids	Size	R/O Size
WNSH1823	Non-insulated Single-Hung Aluminum Window - White	•	18¼" x 23¼"	18" x 23"
WNSH2436	Non-insulated Single-Hung Aluminum Window - White	•	24¼" x 36¼"	24" x 36"

Entry Doors



Door Swing Guide

To determine **OUTSWING** - Face door from outside building "looking in"

Left Hinge Outswing

Hinges are on the left.
Door opens toward you.



STANDING OUTSIDE BUILDING

Right Hinge Outswing

Hinges are on the right.
Door opens toward you.



STANDING OUTSIDE BUILDING

To determine **INSWING** - Face door from inside building "looking out"

Left Hinge Inswing

Hinges are on the left.
Door opens toward you.



STANDING INSIDE BUILDING

Right Hinge Inswing

Hinges are on the right.
Door opens toward you.



STANDING INSIDE BUILDING





DRWF30BL



DRWF6BR



DRWF39L



DRWF69R

SRD 6 Panel Pre Hung Door with Vinyl Jamb

The SAT SRD Series Door features a vinyl jamb and brick moulding and fiberglass door skin which creates a long lasting, paintable door. An excellent choice for residential, agricultural, and storage applications.

- Exposed surfaces are vinyl or fiberglass that can be painted and will not rot.
- Comes with vinyl brick mold.
- Pre-hung for easy installation.
- Insulated door panels.
- Prepped for lockset with a 2.75" backset.
- Weatherstrip ensures weather-tight installation.
- 25 year limited warranty.

Part#	Description	Size	Handing	R/O Size
DRWF26BL	6 Panel Pre Hung Door 4-1/2" Vinyl Jamb - Inswing	26 68	Left Hinge	32½" x 82¾"
DRWF26BR	6 Panel Pre Hung Door 4-1/2" Vinyl Jamb - Inswing	26 68	Right Hinge	32½" x 82¾"
DRWF28BL	6 Panel Pre Hung Door 4-1/2" Vinyl Jamb - Inswing	28 68	Left Hinge	34½" x 82¾"
DRWF28BR	6 Panel Pre Hung Door 4-1/2" Vinyl Jamb - Inswing	28 68	Right Hinge	34½" x 82¾"
DRWF3BL	6 Panel Pre Hung Door 4-1/2" Vinyl Jamb - Inswing	30 68	Left Hinge	38½" x 82¾"
DRWF3BL6J	6 Panel Pre Hung Door 6-9/16" Vinyl Jamb - Inswing	30 68	Left Hinge	38½" x 82¾"
DRWF3BLO	6 Panel Pre Hung Door 4-1/2" Vinyl Jamb - Outswing	30 68	Left Hinge	38½" x 82¾"
DRWF3BR	6 Panel Pre Hung Door 4-1/2" Vinyl Jamb - Inswing	30 68	Right Hinge	38½" x 82¾"
DRWF3BR6J	6 Panel Pre Hung Door 6-9/16" Vinyl Jamb - Inswing	30 68	Right Hinge	38½" x 82¾"
DRWF3BRO	6 Panel Pre Hung Door 4-1/2" Vinyl Jamb - Outswing	30 68	Right Hinge	38½" x 82¾"
DRWF6BL	6 Panel Pre Hung Door 4-1/2" Vinyl Jamb - Inswing	60 68	Left Active	75" x 82¾"
DRWF6BR	6 Panel Pre Hung Door 4-1/2" Vinyl Jamb - Inswing	60 68	Right Active	75" x 82¾"
DRWF-FIRE-20L	6 panel Fire Rated Door 4 1/2" Vinyl Jamb- Inswing	30 68	Left Hinge	38.5x82.75
DRWF-FIRE-20R	6 panel Fire Rated Door 4 1/2" Vinyl Jamb- Inswing	30 68	Right Hinge	38.5x82.75

SRD 9 Lite Pre Hung Door with Vinyl Jamb

- Exposed surfaces are vinyl or fiberglass that can be painted and will not rot.
- Comes with vinyl brick mold.
- Pre-hung for easy installation.
- Insulated door panels.
- Prepped for lockset with a 2.75" backset.
- Weatherstrip ensures weather-tight installation.
- 25 year limited warranty.

Part#	Description	Size	Handing	R/O Size
DRWF289L	9 Lite Pre Hung Door 4-1/2" Vinyl Jamb - Inswing	28 68	Left Hinge	34¾" x 82¾"
DRWF289R	9 Lite Pre Hung Door 4-1/2" Vinyl Jamb - Inswing	28 68	Right Hinge	34¾" x 82¾"
DRWF39L	9 Lite Pre Hung Door 4-1/2" Vinyl Jamb - Inswing	30 68	Left Hinge	38½" x 82¾"
DRWF39R6J	9 Lite Pre Hung Door 6-9/16" Vinyl Jamb - Inswing	30 68	Right Hinge	38½" x 82¾"
DRWF39LO	9 Lite Pre Hung Door 4-1/2" Vinyl Jamb - Outswing	30 68	Left Hinge	38½" x 82¾"
DRWF39R	9 Lite Pre Hung Door 4-1/2" Vinyl Jamb - Inswing	30 68	Right Hinge	38½" x 82¾"
DRWF39L6J	9 Lite Pre Hung Door 6-9/16" Vinyl Jamb - Inswing	30 68	Left Hinge	38½" x 82¾"
DRWF39RO	9 Lite Pre Hung Door 4-1/2" Vinyl Jamb - Outswing	30 68	Right Hinge	38½" x 82¾"
DRWF69L	9 Lite Pre Hung Door 4-1/2" Vinyl Jamb - Inswing	60 68	Left Active	75" x 82¾"
DRWF69R	9 Lite Pre Hung Door 4-1/2" Vinyl Jamb - Inswing	60 68	Right Active	75" x 82¾"
DRWF69LO	9-Lite Pre Hung Door 4-1/2" Vinyl Jamb - Outswing	60 68	Left Active	75" x 82.75"
DRWF69RO	9-Lite Pre Hung Door 4-1/2" Vinyl Jamb - Outswing	60 68	Right Active	75" x 82.75"





SRD 1 Lite Pre Hung Door with Vinyl Jamb

- Exposed surfaces are vinyl or fiberglass that can be painted and will not rot.
- Comes with vinyl brick mold.
- Pre-hung for easy installation.
- Insulated door panels.
- Prepped for lockset with a 2.75" backset.
- Weatherstrip ensures weather-tight installation.
- 25 year limited warranty.

Part#	Description	Size	Handing	R/O Size
DRWF31L	1-Lite Pre Hung Door 4-1/2" Vinyl Jamb - Inswing	30 68	Left Hinge	38.5" x 82.75"
DRWF31L6J	1-Lite Pre Hung Door 6-9/16" Vinyl Jamb - Inswing	30 68	Left Hinge	38.5" x 82.75"
DRWF31LO	1-Lite Pre Hung Door 4-1/2" Vinyl Jamb - Outswing	30 68	Left Hinge	38.5" x 82.75"
DRWF31R	1-Lite Pre Hung Door 4-1/2" Vinyl Jamb - Inswing	30 68	Right Hinge	38.5" x 82.75"
DRWF31R6J	1-Lite Pre Hung Door 6-9/16" Vinyl Jamb - Inswing	30 68	Right Hinge	38.5" x 82.75"
DRWF31RO	1-Lite Pre Hung Door 4-1/2" Vinyl Jamb - Outswing	30 68	Right Hinge	38.5" x 82.75"



Cannonball Fiberglass Door - #52

- 1-5/8" thick insulated capped edge panel with aluminum jamb, header, and threshold.
- Pre-hung on 3 fixed-pin hinges with universal swing.
- Bored for 2-1/8" lockset, nylon lockset insert, and fully weather-stripped.
- All doors individually packaged.

Part#	Description	Size	Handing	R/O Size
D523068F	#52 Fiberglass Door Blank	30 68	Universal	38 ⁹ / ₁₆ " x 82 ³ / ₄ "
D523068FLB	#52 Fiberglass Door w/ 22" x 36" Window	30 68	Left Hinge	38 ⁹ / ₁₆ " x 82 ³ / ₄ "
D523068FRB	#52 Fiberglass Door w/ 22" x 36" Window	30 68	Right Hinge	38 ⁹ / ₁₆ " x 82 ³ / ₄ "
D524068F	#52 Fiberglass Door Blank	40 68	Universal	50 ⁹ / ₁₆ " x 82 ³ / ₄ "
D524068FLB	#52 Fiberglass Door w/ 22" x 36" Window	40 68	Left Hinge	50 ⁹ / ₁₆ " x 82 ³ / ₄ "
D524068FRB	#52 Fiberglass Door w/ 22" x 36" Window	40 68	Right Hinge	50 ⁹ / ₁₆ " x 82 ³ / ₄ "



Cannonball Steel Door - #1734

- Ideal for installing in sliding door.
- 1-3/4" thick insulated rolled edge panel.
- Pre-painted aluminum jamb with nailing flange jambs, header, and threshold.
- Pre-hung on 3 fixed-pin hinges.
- All doors individually packaged.
- Bored for 2-1/8" lockset, nylon lockset insert, and fully weather-stripped.
- Screw holes pre-punched and screws included.
- Embossed 26 gauge steel skin.
- Universal swing (can be switched from outswing to inswing prior to installation)

Part#	Description	Size	Handing	R/O Size
D573060S	#1734 Steel Door Blank w/ 1-7/8" Jamb	30 60	Universal	37 ¹³ / ₁₆ " x 73 ⁵ / ₈ "
D573068S	#1734 Steel Door Blank w/ 1-7/8" Jamb	30 68	Universal	37 ¹³ / ₁₆ " x 81 ⁵ / ₈ "



9 LITE



BLANK

AJ R51 Series White Steel Doors

- Prehung on a 16 ga galvanized steel frame.
- Mounted to the frame by three, 12 ga zinc plated steel 4" x 4-1/2" fixed pin hinges.
- Master frame comes weatherstripped with bulb gasket.
- Universal swing (can be switched from outswing to inswing prior to installation)

Part#	Description	Size	Handing	R/O Size
D513068S	AJ R51 White Steel Door Blank	30 68	Universal	39 1/16" x 81 3/8"
D513068S9L	AJ R51 White Steel Door w/ 22" x 30" 9 Lite	30 68	Left Hinge	39 1/16" x 81 3/8"
D513068S9R	AJ R51 White Steel Door w/ 22" x 30" 9 Lite	30 68	Right Hinge	39 1/16" x 81 3/8"



9 LITE



BLANK

AJ 5100 Series White Commercial Steel Doors

- Pre-hung on a 16 ga 3-1/2" galvanized steel frame.
- 24 ga hot-dipped galvanized smooth steel panels.
- ADA compliant threshold.
- Door panels is strengthened with extruded aluminum reinforcing block at locations for entry lock, dead bolt, panic hardware, and closer.
- High-strength internal fiberglass reinforced protruded stiles and rails for thermal break.
- Mounted to the frame by three, 12 ga stainless steel 4" x 4-1/2" fixed pin hinges.
- Master frame comes weatherstripped with bulb gasket.
- Universal swing (can be switched from outswing to inswing prior to installation)

Part#	Description	Size	Handing	R/O Size
D51003068S	A J 5100 Series White Steel Door - Blank	30 68	Universal	40-5/16" x 81-1/8"
D51003068S9L	A J 5100 Series White Steel Door w/ 22" x 30" 9-lite	30 68	Left Hinge	40-5/16" x 81-1/8"
D51003068S9R	A J 5100 Series White Steel Door w/ 22" x 30" 9-lite	30 68	Right Hinge	40-5/16" x 81-1/8"
D51006068S9L	A J 5100 Series White Steel Door w/ 22" x 30" 9-lite	60 68	Left Active	77-5/8" x 81-1/8"
D51006068S9R	A J 5100 Series White Steel Door w/ 22" x 30" 9-lite	60 68	Right Active	77-5/8" x 81-1/8"
D51006068SL	A J 5100 Series White Steel Door - Blank	60 68	Left Active	77-5/8" x 81-1/8"
D51006068SR	A J 5100 Series White Steel Door - Blank	60 68	Right Active	77-5/8" x 81-1/8"
D5100SO	Special Order AJ 5100 Door - Size and Color			



AJ Ceiling Access Door

This high performance double wall ceiling access door is for buildings with an interior ceiling liner. The white 1" thick steel door panel has a white self-flashing pre-hung aluminum frame that can be mounted in trusses 24" or 48" on center.

- Hot dipped galvanized G60 steel skin
- 1" thick steel door with an expanded polystyrene core.
- White polyester painted steel sheet creates a seamless rigid panel with an insulating value of R6.5.

Part#	Description	Size	R/O Size
DCAD	AJ Ceiling Access Door	2' x 4'	22 9/16" x 46 1/16"



SPECIAL ORDER - VARYING LEAD TIMES

- Solid core option to reduce sound from traveling through your home and give you the feel of a solid wood door
- Textured and smooth surface options
- Doors are primed, ready to paint any color you choose
- Matching bifold doors available



Uncle Park
Ledge
Wiche



Bethel
Hazel
Moloz



Chryse
Borale
Sudbrook



2, 4 and 6 Panel
2 Panel Slane
2 Panel Arch Top
6 Panel Petroland

Interior Sliding Door

Part#	Description	Size
YN700003	Decorative Interior Sliding Door Hardware - Matte Black	72"
YN700002	Decorative Interior Sliding Door Hardware - Satin Nickel	72"



SPECIAL ORDER - VARYING LEAD TIMES



Whether you're seeking the timeless characteristics of real wood or the unmatched strength of 20-gauge steel, ProVia® has entry doors and front doors that are just right for your home.

Our steel entry doors are available in either a woodgrain texture or an unbelievably smooth, professionally painted finish. In addition to being beautifully finished, our entry doors offer superior durability and outstanding energy efficiency.





SPECIAL ORDER - VARYING LEAD TIMES

Special Order Exterior Fiberglass Door Window Options

- Non-stock special order fiberglass doors with unique window options.
- Pre-hung with either primed wood, pine, or vinyl jambs.
- Insulated door with wood grained fiberglass skin.
- Available in white (pre-finished or easily painted) and Tan (best for staining).
- 4-9/16" and 6-9/16" jambs.
- Allow 1-2 week lead times.

Part#	Description
D00S0	Special Order Entry Door

6 PANEL

9-LITE/2 PANEL

1-LITE 2236/2 PANEL

4-LITE/4 PANEL

11-LITE/2 PANEL

1-LITE ARCH/2 PANEL

5-LITE/4 PANEL

3-LITE ARCH 2210/2 PANEL

17-LITE

1-LITE ARCH 2264

15-LITE

1-LITE 2264

6-LITE/4 PANEL

VENT LITE 2236/ 2 PANEL

1-LITE HALF ARCH 2264 (LH/RH)

15-LITE HALF ARCH (LH/RH)

Available options
 Frame/Grid Color Options:
 White | Tan
 GBG (Grids between glass)
 also available
 BBG: (Blinds between glass)
 Rainglass
 Decorative Glass (Oval, Etc.)
 More options available -
 Please ask





Door Sweep

Part#	Description
D51DS	Door Sweeps 3100 Style for R51 series Doors - Top and Bottom the Same



Header Snap Cap

Part#	Description	Size
D51WSH	Header Snap Cap Parting Stop with Weatherstripping - fits R51 Door	36"



Bulb Style Weatherstrip

Part#	Description	Size
D51WSSIDE	Side Weatherstrip Bulb Style Self Adhesive Fits AJ R51 Door	79.94'
D51WSTOP	Header Weatherstrip Bulb Style Self Adhesive Fits AJ R51 Door	36"



Single Cylinder Deadbolt

Part#	Description
DLD	Single Cylinder Deadbolt Stainless Steel
DLDB	Single Cylinder Deadbolt Black



Semi Flush Lock Set

A low profile lock set with a small lever for use with an inset in a sliding door.

Part#	Description
DLF	Semi Flush Lock Set For Entry Door Set In Sliding Doors



Keyed Entrance Lever/Lever Latch

Part#	Description
DLLS	Keyed Entrance Lever/Lever Latch Stainless Steel
DLLSB	Keyed Entrance Lever/Lever Latch Black



Passage Lever/Lever Latch

Part#	Description
DLLPA	Passage Lever/Lever Latch Stainless Steel
DLLPAB	Passage Lever/Lever Latch Black



Privacy Lever/Lever Latch

Part#	Description
DLLP	Privacy Lever/Lever Latch Stainless Steel
DLLPB	Privacy Lever/Lever Latch Black





Entry Lockset and Deadbolt Combo

Part#	Description
DLC	Entry Lockset And Deadbolt Combo



Commercial 2 3/4" Keyed Lockset

Heavy-duty, backset, keyed lockset for commercial applications.

Part#	Description	Size
DLS	Commercial Heavy-duty Keyed Backset Lockset	2.75"

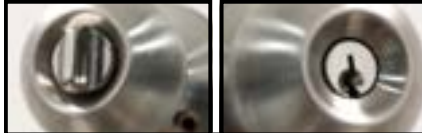

Standard Keyed Lockset

A good quality keyed lockset with an adjustable backset.

Part#	Description
DLOCK	Standard Keyed Door Lockset w/ Adjustable Backset

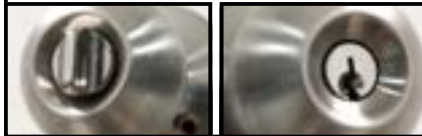

Interior Privacy Lockset

Part#	Description
DLPI	Interior Privacy Lockset - Knob Both Sides



Keyed Lever with Hidden Cylinder for Panic Bar

- The key cylinder is inside the lever handle.
- For panic bar only.

Part#	Description
DLEVER	Keyed Lever w/ Key Cylinder in Lever Handle for Panic Bar Only Stainless Steel
DLEVERB	Keyed Lever w/ Key Cylinder in Lever Handle for Panic Bar Only Black



Keyed Lever with Exposed Cylinder for Panic Bar

- The key cylinder is above the lever handle.
- For panic bar only.

Part#	Description
DLEVERM	Keyed Lever w/ Key Cylinder Above Lever Handle for Panic Bar Only



DDT100007



DDT100008

Kick Down Door Holders

Part#	Description	Size
DDT100007	Kick Down Door Holder - Cast Brass	4"
DDT100008	Kick Down Door Holder - Cast Aluminum	4"



Panic Bar

Part#	Description
DPANIC	Panic Bar Stainless Steel
DPANICB	Panic Bar Black



Through Bolt for Closer and Panic Bar

Part#	Description	Size
DTB	Thru Bolt for Closer and Panic Bar - 4 PK	1.75"



DHG100020



DHG100004

Commercial Door Hinges

Part#	Description	Size
DHG100020	Commercial Door Hinge	4.5" x 5"
DHG100004	Commercial Door Hinge w/ Ballbearing	4.5" x 4.5"
DHG100330	Commercial Door Hinge w/ Ballbearing Black	4.5" x 4.5"



Pull Plate with Pull

Part#	Description	Size
DDT100067	Pull Plate with Pull Stainless Steel	3.5" x 15"
DDT101943	Pull Plate with Pull Black	3.5" x 15"



Stainless Steel Commercial Push Plate

Part#	Description	Size
DDT100072	Commercial Push Plate Satin Stainless Steel	3.5" x 15"
DDT101944	Commercial Push Plate Satin Black	3.5" x 15"



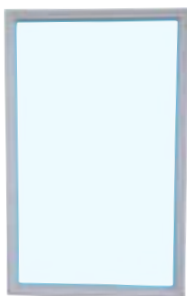

DLKB

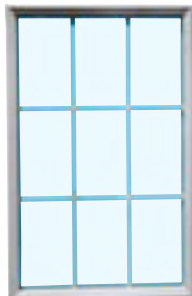

DLKB9



Stainless Steel Kick Plate

Part#	Description	Size
DDT100055	Kick Plate Satin Stainless Steel	6" x 30"
DDT100056	Kick Plate Satin Stainless Steel	6" x 34"
DDT100072	Kick Plate Satin Stainless Steel	8" x 34"
DDT101945	Kick Plate Satin Black	8" x 34"

Overlapping Strike Plate for Double Doors

Part#	Description
DSP	Overlapping Strike Plate For Double Doors

Grizzly Lite Kit

Part#	Description	Size
DLKB	Window Lite Kit For Residential Doors - One Lite - No Grids	22" x 36"
DLKB9	Window Lite Kit to fit Vinyl Jamb 9 Lite Door	22" x 36"

Cannonball Lite Kits

Part#	Description	Size
DLKA	Non-insulated Lite Kit - Fits #52 Series Door	20" x 24"

600 Series Hydraulic Door Closer

- Heavy-duty commercial grade hydraulic door closer.
- 1 adjustable 1-4 spring power.
- Includes standard arm.

Part#	Description
DCLOSE	Hydraulic Door Closer 600 Series w/ Standard Arm Stainless Steel
DCLOSEMB	Hydraulic Door Closer 600 Series w/ Standard Arm Black

600 Series Hydraulic Door Closer Arm

Part#	Description
DCLOSEARM	Hold Open Arm Only for 600 Series Door Closer

Overhead Garage Doors



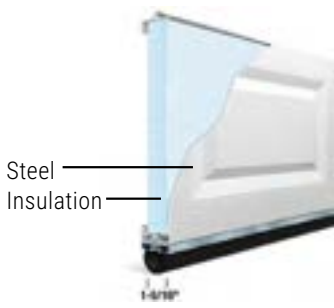

Decorative panel edging and natural embossed woodgrain texture improve appearance close-up and from the curb.



N/S = non-stock. All non-stock doors are available for special order. Call for lead times.

*Overhead doors are available in 3" height increments between 6' - 7' and 7.5' - 12' high.

*Overhead doors are available in 2" wide increments starting at 6'.

(7'3" doors are not available.)

Special Order Colors



ALMOND



DESERT TAN



SANDTONE



CHOCOLATE

Silver Series Garage Doors - Stocked

- Two-layer construction for energy efficiency and enhanced durability
- Thick vinyl-backed polystyrene insulation for added energy efficiency
- 5500 has 1-5/16" polystyrene insulation (R-value = 6.3)



Plain - Traditional Window Option



Sunset 503 - Special Order Window

Option



5500 Series Garage Door - Stocked in White

Part#	Description	Window	Size
OH88	5500 Overhead Door Blank		8' x 8'
OH88W	5500 Overhead Door With Windows	•	8' x 8'
OH97	5500 Overhead Door Blank		9' x 7'
OH97W	5500 Overhead Door With Windows	•	9' x 7'
OH98	5500 Overhead Door Blank		9' x 8'
OH98W	5500 Overhead Door With Windows	•	9' x 8'
OH108	5500 Overhead Door Blank		10' x 8'
OH108W	5500 Overhead Door With Windows	•	10' x 8'
OH109	5500 Overhead Door Blank		10' x 9'
OH109W	5500 Overhead Door With Windows	•	10' x 9'
OH1010	5500 Overhead Door Blank		10' x 10'
OH1010W	5500 Overhead Door With Windows	•	10' x 10'
OH1012	5500 Overhead Door Blank		10' x 12'
OH1012W	5500 Overhead Door With Windows	•	10' x 12'
OH1210	5500 Overhead Door Blank		12' x 10'
OH1210W	5500 Overhead Door With Windows	•	12' x 10'
OH1212	5500 Overhead Door Blank		12' x 12'
OH1212W	5500 Overhead Door With Windows	•	12' x 12'
OH1214	5500 Overhead Door Blank		12' x 14'
OH1214W	5500 Overhead Door With Windows	•	12' x 14'
OH1414	5500 Overhead Door Blank		14' x 14'
OH1414W	5500 Overhead Door With Windows	•	14' x 14'
OH168	5500 Overhead Door Blank		16' x 8'
OH168W	5500 Overhead Door With Windows	•	16' x 8'
OHSO	N/S Special Order 5500 Series Garage Door		



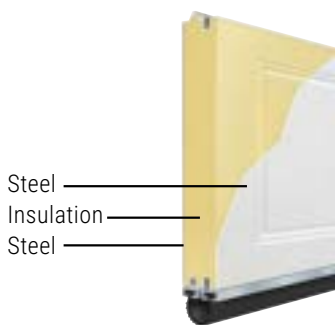

Decorative panel edging and natural embossed woodgrain texture improve appearance close-up and from the curb.



Gold Series Garage Doors - Stocked

- Not currently in-stock, but available for special order
- Elegant raised, long and flush panel designs for improved curb appeal
- Three-layer construction provides maximum energy efficiency, the quietest operation and superior durability
- Prefinished, stucco textured flush interior for beauty inside and out
- 7200 has 2" Intellicore® polyurethane insulation (R-value = 18.4)
- Can be painted to match your home's exterior.

Please visit <http://info.garagedoors.com/lrv> for paint instructions on Intellicore® models.



7200 Series Garage Door - Stocked in White

Part#	Description	Windows	Size
OH9872	7200 Overhead Door Blank		9' x 8'
OH98W72	7200 Overhead Door With Windows	•	9' x 8'
OH101072	7200 Overhead Door Blank		10' x 10'
OH1010W72	7200 Overhead Door With Windows	•	10' x 10'
OH101272	7200 Overhead Door Blank		10' x 12'
OH1012W72	7200 Overhead Door With Windows	•	10' x 12'
OH121272	7200 Overhead Door Blank		12' x 12'
OH1212W72	7200 Overhead Door With Windows	•	12' x 12'
OH16872	7200 Overhead Door Blank		16' x 8'
OH168W72	7200 Overhead Door With Windows	•	16' x 8'
OHSO	N/S 7200 Special Order Overhead Door		

6200 Series Garage Door (non-stock)

Part#	Description
OHSO	N/S 6200 Special Order Overhead Door



ALMOND



CHOCOLATE



HUNTER GREEN



DESERT TAN



SANDTONE



BLACK**



MOCHA BROWN



BRONZE



STANDARD WHITE



GRAY



CHARCOAL

N/S = non-stock. All non-stock doors are available for special order. Call for lead times.

*Overhead doors are available in 3" height increments between 6' - 7' and 7.5' - 12' high.

**Decorative colors with additional cost.

*Overhead doors are available in 2" wide increments starting at 6'.

(7'3" doors are not available.)





Decorative panel edging and natural embossed woodgrain texture improve appearance close-up and from the curb.

Bronze Series Garage Doors

- Not currently in-stock, but available for special order
- One-layer (non-insulated) 25 gauge steel construction that is durable and economical



PAINT SYSTEM LIMITED WARRANTY 15 YEAR	WINDOW LIMITED WARRANTY 10 YEAR	HARDWARE LIMITED WARRANTY 3 YEAR
--	--	---

4200 Series Garage Door (non-stock)

Part#	Description
-------	-------------

OHSO N/S 4200 Special Order Overhead Door



STANDARD WHITE ALMOND DESERT TAN SANDTONE CHOCOLATE

N/S = non-stock. All non-stock doors are available for special order. Call for lead times.

*Overhead doors are available in 3" height increments between 6' - 7' and 7.5' - 12' high.

*Overhead doors are available in 2" wide increments starting at 6'.
(7'3" doors are not available.)

Vinyl Door Stop



Part#	Description	Size
VDS8	White Vinyl Door Stop for Overhead Doors	8'
VDS9	White Vinyl Door Stop for Overhead Doors	9'
VDS10	White Vinyl Door Stop for Overhead Doors	10'
VDS12	White Vinyl Door Stop for Overhead Doors	12'
VDS16	White Vinyl Door Stop for Overhead Doors	16'
VDS16BN	Brown Vinyl Door Stop for Overhead Doors	16'
VDS16CLAY	Clay Vinyl Door Stop for Overhead Doors	16'
VDS16AL	Almond Vinyl Door Stop for Overhead Doors	16'

Mounting Angle



Part#	Description	Size
OHMOUNT	Mounting Angle for Overhead Doors	10'





Artistry® Steel (non-stock)

Artistry® Steel garage doors are available in multiple insulation options including our high R-value Intellicore® polyurethane, polystyrene insulation and also non-insulated. Select from several design choices including Ultra-Grain®, our beautiful, one of a kind woodgrain paint finish.

Available in short or long deep embossed panel designs and several window options, you are sure to find the right style for your home. Doors come standard with decorative hardware with also several other decorative hardware options available. These models offer the ultimate performance in durability, strength, energy efficiency and beauty.



Specialty Glass Options:

Glass is available in different designs depending on door model. Options include acrylic, clear, frosted, seeded, obscure and rain, as well as insulated versions for a more energy efficient door.

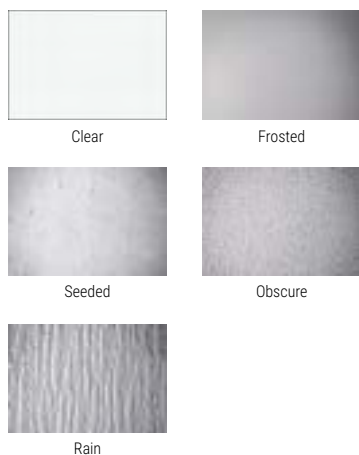

Part#	Description
AR2SU/AR2LU	2" Intellicore® Polyurethane Insulation
AR1SU/AR1LU	1-3/8" Intellicore® Polyurethane Insulation
AR2SP/AR2LP	2" Polystyrene Insulation
AR1SP/AR1LP	1-3/8" Polystyrene Insulation
AR4SV/AR4LV	24 Gauge - 1-5/16" Vinyl-Backed Polystyrene Insulation
AR5SV/AR5LV	25 Gauge - 1-5/16" Vinyl-Backed Polystyrene Insulation
AR4S/AR4L	24 Gauge - Steel (Non-Insulated)
AR5S/AR5L	25 Gauge - Steel (Non-Insulated)



AR²SU/AR²LU, AR¹SU/AR¹LU, AR²SP/AR²LP,
AR¹SP/AR¹LP, AR⁴SV/AR⁴LV, AR⁴S/AR⁴L

AR⁵SV/AR⁵S, AR⁵LV/AR⁵L

Color Options

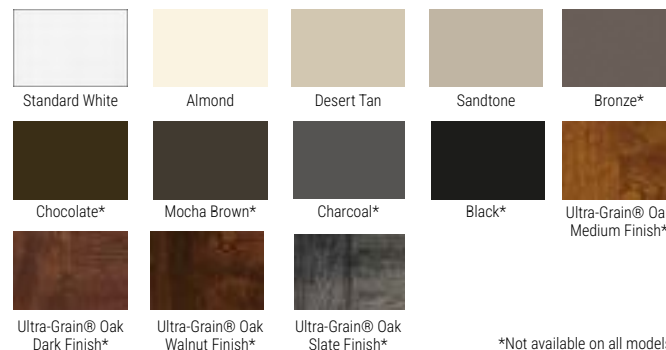

*Not available on all models.

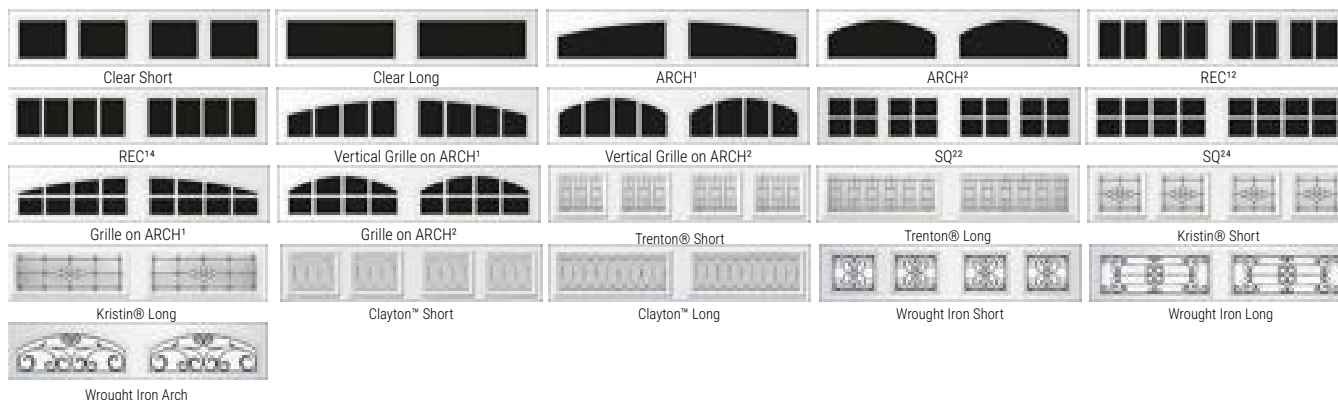



Integral section joint seal for further reduction of air and water infiltration.

Smooth flat frame edge design for a more contemporary look.

*Reinforcing fin included on doors wider than 14'. Standard doors 12' and under do not use built-in reinforcing fin. Usage on widths 12'2" to 14' depend upon glass weight. WindCode® doors may vary.



Modern Flush Panel



Modern Grooved Panel

Contemporary Aluminum (non-stock)

Contemporary Aluminum garage doors combine aluminum and glass to create a sleek, modern look. Many glass and panel combinations are available for varying degrees of privacy.

Part#	Description
AX	Non-Insulated
AXU	Insulated



Color Options



Contemporary Aluminum Sleek(non-stock)

Contemporary Aluminum Sleek garage doors are the perfect choice to modernize any home. Not only can they transform garages, they can also be used as an indoor loft partition or as versatile solarium doors.

Part#	Description
AZ5/AZ6	Non-Insulated
AZ5U/AZ6U	Insulated



Contemporary Steel (non-stock)

Contemporary Steel garage doors complement contemporary and mid-century modern home styles. Doors are available with or without windows and with or without grooves.

Part#	Description
7202/7201/7208/7205/7209	2" Intellicore® Polyurethane Insulation
7132/7131/7138/7139	1-3/8" Intellicore® Polyurethane Insulation
6202/6201/6208/6205/6209	2" Polystyrene Insulation
6132/6131/6138	1-3/8" Polystyrene Insulation



Color Options



Roll Track Sliding Doors

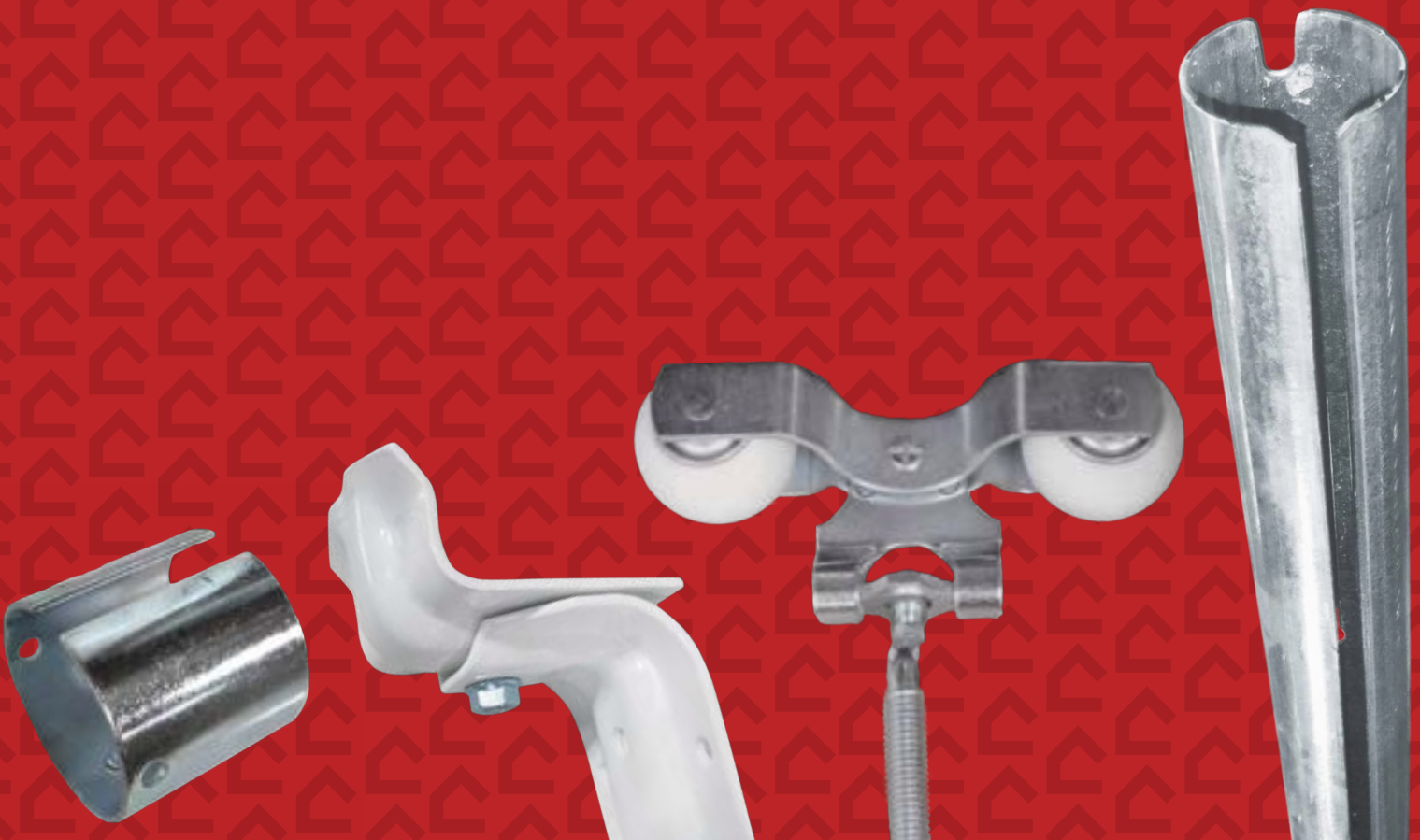



Round Keyhole Track

Keyhole track offers versatility, strength and ease of use. This adaptable track style can be used with any sliding door variety or bracket type – and installs with a simple connection of brackets into keyholes before mounting.

FEATURES:

- Keyhole Track can be utilized in both wood and metal frame construction for commercial, agriculture and metal building projects.
- When paired with available Delrin wheel trolleys, Keyhole Track can manage sliding doorsthe track's center and pushing away any dirt or weighing up to 600 pounds.
- Choose from a variety of bracket styles to accommodate track cover additions on doors up to 2-1/2" thick.
- Cylindrical design allows for self-cleaning and aligning with every use, positioning trolleys in the track's center and pushing away any dirt or debris build-up.

Part#	Description	Size
TCB**	Round Track - 14 ga Galvanized	8', 10', 12', 14', 16', 18', & 20'



Pendant Bolt Trolleys

The Pendant Bolt installs through the top of the horizontal, allowing for easy adjustment and a perfect fit. For maximum flexibility, the offset bolt version offers four directions of adjustment: up, down, in and out.

Part#	Description	Size
T5302	Derlin Bolt Trolley	9"
T53026	Derlin Bolt Trolley - 4 Way Adjustable Pendant	6-1/2"



Double Truck Trolleys

Built to handle the heaviest sliding door panels, Double Truck Trolleys are the perfect choice for steel frame doors on Heavy Duty Tubular Track with Universal Bracketry.

FEATURES

- The product design features four wheels per center trolley, allowing it to support door weights up to 1200 pounds. Brackets spaced every 12" on preventing the bolt hole from distorting.
- An optional plate sits just below the top girt,

Part#	Description	Size
TTTR	Derlin Double Truck Trolley	9"



T714876

T5330

T5332

Strap Trolleys

Strap Trolleys attach to the front face of wood panel doors, with bolts that go through the panel for a solid hold.

Part#	Description
T714876	Derlin Trolley With Front & Back Strap - Includes End Caps
T5330	Strap Trolleys for Round Track - Top Adjustable - Includes End Caps
T5332	Side Bolt Trolley for Round Track





TTC



TFB

Face Mount Brackets

Designed for use on CannonBall's Keyhole Track line, Face Mount Brackets contain an integral rivet that interlocks into the keyhole slot. Simply tap the bracket into each slot and mount to the face of the header board.

FEATURES:

- Simple assembly provides an easy way to install track on your building project.
- Use 1 bracket for every 2 feet of track.

Part#	Description
TTC	Track & Cover Bracket
TFB	Face Mount Bracket - (no cover)



Universal Double Bracket

The Universal Double Bracket – an ideal choice for double track runs – allows two lengths of Heavy Duty or Keyhole track to be installed in parallel for bypass sliding doors.

FEATURES:

- Like the Universal Side Bracket, the Universal Double supports doors with weights over 600 pounds.
- The versatile design of the bracket allows for use as an end bracket, intermediate bracket or splice collar – depending on your building project's needs.
- Highly recommended for bypass sliding door configurations.

Part#	Description
TCBSBD	Double Side Bracket



TCBBHB



TSB



TTB



T⁵¹⁵¹FLASH

Universal Bolt Bracket & Adapters

Created to bridge post frame components into metal building projects, the Universal Bolt Bracket allow builders to convert Keyhole Track into Bolt Hung Track functionality.

Part#	Description	Size
TCBBHB	Bolt Hung Bracket 1/2" Bolt Welded to Loop Bracket	
TSB	Stud Bolts for Triangle Brackets with 2-3/8" Flat Washer	1-3/8"
TTB	Triangle Bracket with 2 Stud Bolts	
T ⁵¹⁵¹ FLASH	Double Flashing Brackets	

Universal Brackets

Designed for use on heavy weight sliding door projects utilizing Keyhole Track varieties, Universal Side Brackets and Universal Ceiling Brackets mount easily.

FEATURES:

- Universal Ceiling Brackets can be utilized to mount directly to a ceiling beam or truss for added flexibility in tight spaces with limited headroom with weights over 600 pounds (when used in room).
- Both Universal Brackets support sliding doors conjunction with appropriate Heavy Duty Track and spaced every foot on center).
- The versatile design of these brackets allow for use as end brackets, intermediate brackets,

Part#	Description
TCBSB	Side Bracket - Not Keyhole
TCBCB	Ceiling Bracket - Not Keyhole





Splice Collar

Connects track lengths together to make a single, elongated track. NOTE: Shorter track lengths utilizing Splice Collars save on shipping and install easier than long track lengths.

Part#	Description
TCBS	Splice Collar



TEC



TCBET

End Cap

Attaches to open ends of track, preventing birds from nesting as well as dirt and debris build-up. NOTE: End Caps cannot be used as door stops.

Part#	Description
TEC	End Cap with Bolt
TCBET	White Face Mount Cover End Trim - Pair



Adjustable Door Stop

Prevents door panels from opening or closing further than a predefined stopping point.

Part#	Description
TADJ	White Adjustable Door Stop Bumper
TADJBG	Galvanized Adjustable Door Stop Bumper



Non Adjustable Door Stop

Prevents door panels from opening or closing further than a predefined stopping point

Part#	Description
TDS	Galvanized Non Adjustable Door Stop Bumper



Jamb Mount Door Stop

Part#	Description
TJMS	Galvanized Jamb Mount Stop



Chain Snugger

Prevents door panels from moving or rattling when closed and tightens as the door moves. Available in several styles based on intended use.

Part#	Description
TCS	Chain Snugger for Sliding Doors



Latches

Locks doors from the inside and pulls panels tighter against the building to reduce rattle.

Part#	Description
TJL	Adjustable Jamb Latch
TJLOS	Outside Handle Jamb Latch
TCL	Cam Latch



Door Pull

Assists with door opening and closing; a handle attached to door panels.

Part#	Description
TPW	White Door Pull Handle
TPG	Galvanized Door Pull Handle





Adjustable Door Guide/Stop

Guides the door along the building, reduces the amount of door sway and prevents opening or closing beyond a predefined stopping point.

Part#	Description
TDGSW	White Adjustable Door Guide/Stop
TDGSG	Galvanized Adjustable Door Guide/Stop



Floor Mount Door Guide/Stop

Part#	Description
T322	Pair 322 Floor Mount Guide

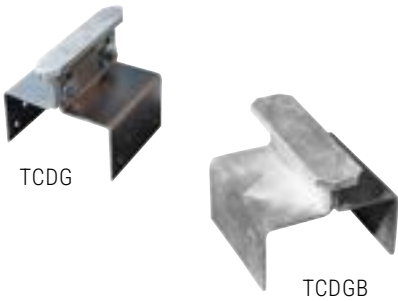

Center Door Guide

Part#	Description
TCDG	Center Door Guide for on Post
TCDGB	Big Center Door Guide for on Post



Stay Roller

Functions similarly to a guide rail, but recommended for Kwik Frame Door Systems or solid wood panel doors smaller than 140 sq. ft.

Part#	Description
TSMS	Small Stay Roller
HSSRB	Black Adjustable Small Stay Roller
TLGS	Galvanized Adjustable Large Stay Roller
N131524	Stay Roller With Lag and Shield



Door Seals

Part#	Description	Size
TWSSR	White Vinyl Weather Strip for Side Rails	1-1/4"
TWSBR	White Vinyl Weather Strip for #244 Bottom Rails	2"
TBS	Black Brush Seal Strip for #244 Bottom Rails	



Side Rail

White, Black (BL), Bronze (BZ), Brown (B), Evergreen (EG), and Charcoal (CH) stocked in 8' -16' lengths.

Part#	Description	Length
TSR8cc	Side Rail for Sliding Doors - Color	8'
TSR10cc	Side Rail for Sliding Doors - Color	10'
TSR12cc	Side Rail for Sliding Doors - Color	12'
TSR14cc	Side Rail for Sliding Doors - Color	14'
TSR16cc	Side Rail for Sliding Doors - Color	16'
TSR20	Side Rail for Sliding Doors - White	20'



Side Connector Rail

White, Black (BL), Bronze (BZ), Brown (B), Evergreen (EG), and Charcoal (CH) stocked in 8' -16' lengths.

Part#	Description	Length
TCR8cc	Side Connector Rail for Sliding Doors - Color	8'
TCR10cc	Side Connector Rail for Sliding Doors - Color	10'
TCR12cc	Side Connector Rail for Sliding Doors - Color	12'
TCR14cc	Side Connector Rail for Sliding Doors - Color	14'
TCR16cc	Side Connector Rail for Sliding Doors - Color	16'
TSR20	Side Connector Rail for Sliding Doors - White	20'



Bottom Rail for Guide

White, Black (BL), Bronze (BZ), Brown (B), Evergreen (EG), and Charcoal (CH) stocked in 8' -16' lengths.

Part#	Description	Length
TBRG8cc	Bottom Rail for Guide for Sliding Doors - Color	8'
TBRG10cc	Bottom Rail for Guide for Sliding Doors - Color	10'
TBRG12cc	Bottom Rail for Guide for Sliding Doors - Color	12'
TBRG14cc	Bottom Rail for Guide for Sliding Doors - Color	14'
TBRG16cc	Bottom Rail for Guide for Sliding Doors - Color	16'
TBRG20	Bottom Rail for Guide for Sliding Doors - White	20'



Bottom Guide Rail

Reduces the amount of door sway, helps prevent wind damage and provides easier door operation. Stay Guide lengths should measure 60% of the door panel width.

Part#	Description	Size
TGR5	Guide Rail System with 2 Brackets	5'
TGR10	Guide Rail System with 3 Brackets	10'





Big Side Connector Rail - Special Order

Part#	Description	Size	Length
TCRB12	White - Big Side Connector Rail for Sliding Doors	3-1/2"	12'
TCRB14	White - Big Side Connector Rail for Sliding Doors	3-1/2"	14'
TCRB16	White - Big Side Connector Rail for Sliding Doors	3-1/2"	16'
TCRB20	White - Big Side Connector Rail for Sliding Doors	3-1/2"	20'



391 Big Side Rail - Special Order

Part#	Description	Size	Length
TSRB12	# 391 - Big Side Rail for Sliding Doors	3-1/2"	12'
TSRB14	# 391 - Big Side Rail for Sliding Doors	3-1/2"	14'
TSRB16	# 391 - Big Side Rail for Sliding Doors	3-1/2"	16'
TSRB20	# 391 - Big Side Rail for Sliding Doors	3-1/2"	20'



244 Big Bottom Rail

Part#	Description	Length
TBRGN8	# 244 - Bottom Rail for Guide for Sliding Doors	8'
TBRGN10	# 244 - Bottom Rail for Guide for Sliding Doors	10'
TBRGN12	# 244 - Bottom Rail for Guide for Sliding Doors	12'
TBRGN14	# 244 - Bottom Rail for Guide for Sliding Doors	14'
TBRGN16	# 244 - Bottom Rail for Guide for Sliding Doors	16'
TBRGN20	# 244 - Bottom Rail for Guide for Sliding Doors	20'



Big Guide Rail

Part#	Description	Length
TGRB6	Big Guide Rail with 3 Brackets for Sliding Doors	6'
TGRB8	Big Guide Rail with 3 Brackets for Sliding Doors	8'
TGRB10	Big Guide Rail with 3 Brackets for Sliding Doors	10'



235 Steel Girt (Horizontal)

Provides horizontal support on sliding door frames. Steel girts are manufactured with 20-gauge galvanized steel for long lasting, light weight, rust-free doors.

Part#	Description	Size	Length
TSG8	# 235 - 20 Gauge Steel Girts for Sliding Doors	1.5" x 3.5"	8'
TSG10	# 235 - 20 Gauge Steel Girts for Sliding Doors	1.5" x 3.5"	10'
TSG12	# 235 - 20 Gauge Steel Girts for Sliding Doors	1.5" x 3.5"	12'
TSG14	# 235 - 20 Gauge Steel Girts for Sliding Doors	1.5" x 3.5"	14'
TSG16	# 235 - 20 Gauge Steel Girts for Sliding Doors	1.5" x 3.5"	16'
TSG18	# 235 - 20 Gauge Steel Girts for Sliding Doors	1.5" x 3.5"	18'
TSG20	# 235 - 20 Gauge Steel Girts for Sliding Doors	1.5" x 3.5"	20'



394 Big Bottom Rail - Special Order

Part#	Description	Size	Length
TBRGB10	# 394 - Big Bottom Rail for Guide for Sliding Doors	3-1/2"	10'
TBRGB12	# 394 - Big Bottom Rail for Guide for Sliding Doors	3-1/2"	12'
TBRGB14	# 394 - Big Bottom Rail for Guide for Sliding Doors	3-1/2"	14'
TBRGB16	# 394 - Big Bottom Rail for Guide for Sliding Doors	3-1/2"	16'
TBRGB18	# 394 - Big Bottom Rail for Guide for Sliding Doors	3-1/2"	18'
TBRGB20	# 394 - Big Bottom Rail for Guide for Sliding Doors	3-1/2"	20'



201 Bottom Rail

Part#	Description	Length
TBR8	White # 201 - Bottom Rail for Sliding Doors	8'
TBR10	White # 201 - Bottom Rail for Sliding Doors	10'
TBR12	White # 201 - Bottom Rail for Sliding Doors	12'
TBR14	White # 201 - Bottom Rail for Sliding Doors	14'
TBR16	White # 201 - Bottom Rail for Sliding Doors	16'
TBR20	White # 201 - Bottom Rail for Sliding Doors	20'



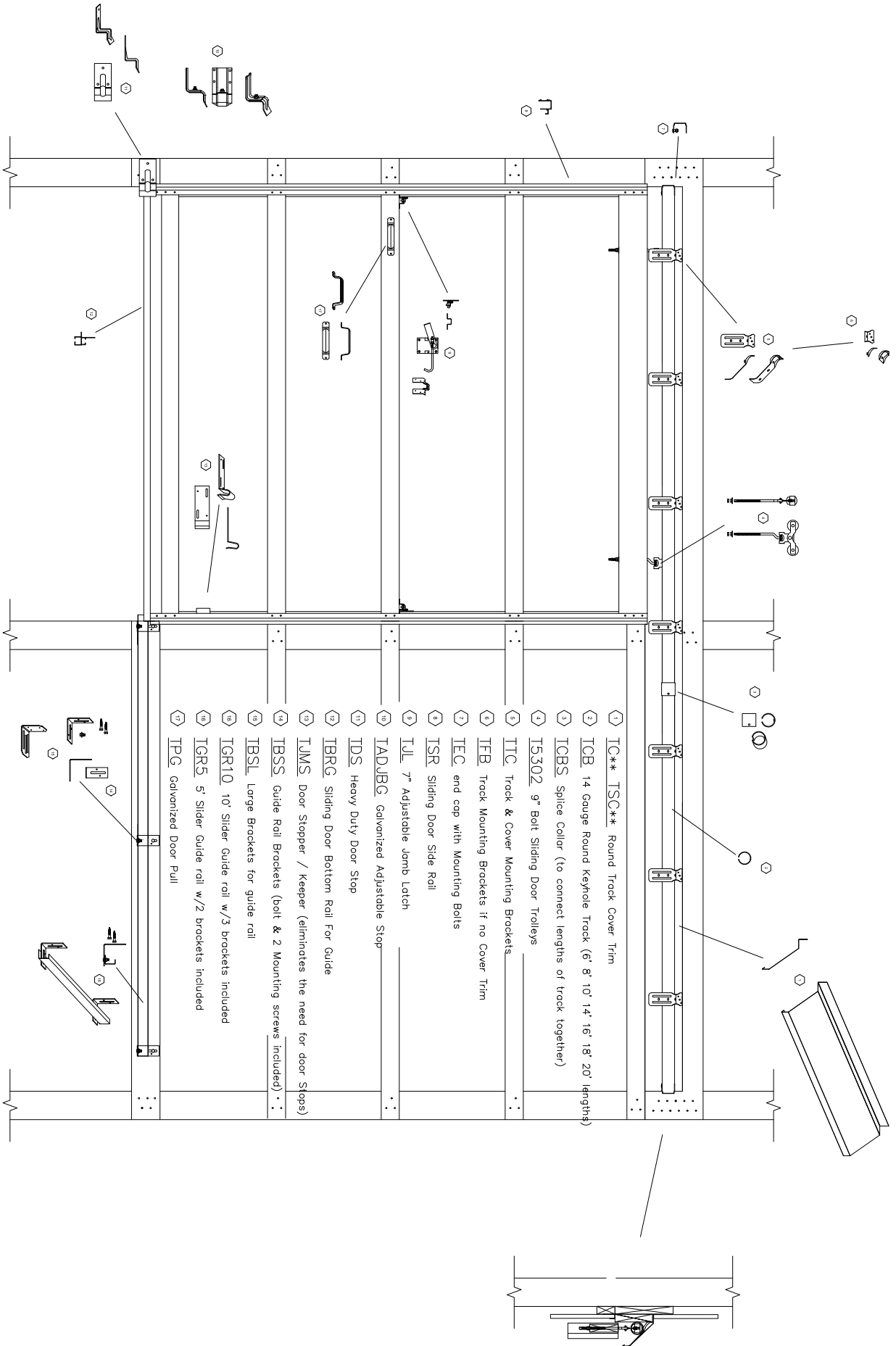

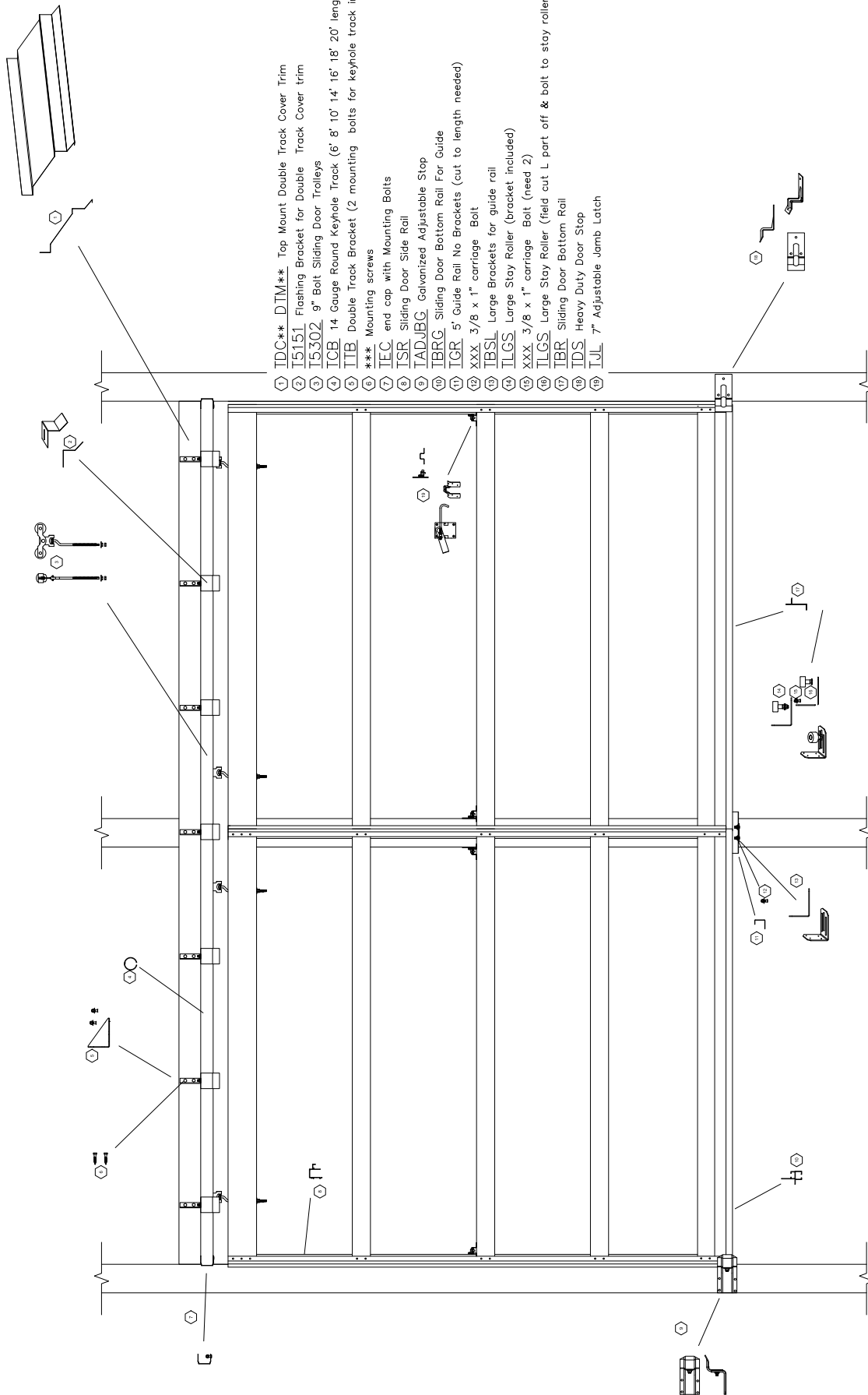

Square Track Sliding Doors





Square Track

Part#	Description	Length
TSQ8	Galvanized Square Track - 16 Gauge	8'
TSQ10	Galvanized Square Track - 16 Gauge	10'
TSQ12	Galvanized Square Track - 16 Gauge	12'
TSQ14	Galvanized Square Track - 16 Gauge	14'
TSQ16	Galvanized Square Track - 16 Gauge	16'
TSQ20	Galvanized Square Track - 16 Gauge	20'



TSSB



TSSSB

Square Track Brackets

Part#	Description
TSSB	Square Track Bracket
TSSSB	Square Track Splice Bracket



TDB



TDBS

Square Track Double Brackets

Part#	Description
TDB	Square Track Double Bracket
TDBS	Square Track Double Splice Bracket



T5042



T5047

Adjustable Square Track Trolleys

Part#	Description	Lbs. Rating
T32LB	Side Adjustable Square Track Trolleys - Pair	35 lbs. each
T5042	5042 Side Adjustable Square Track Trolleys - Pair - Includes End Caps	
T5047	5047 Top Adjustable Square Track Trolleys - Pair	32 lbs. each



T5022

Square Track Bolt Trolleys

Part#	Description	Size
T38T9	Square Track Bolt Trolleys w/ Threaded Bolt - Pair	9"
T5022	Square Track Bolt Trolleys w/ Delrin Bearings - Pair - Includes End Caps	9"



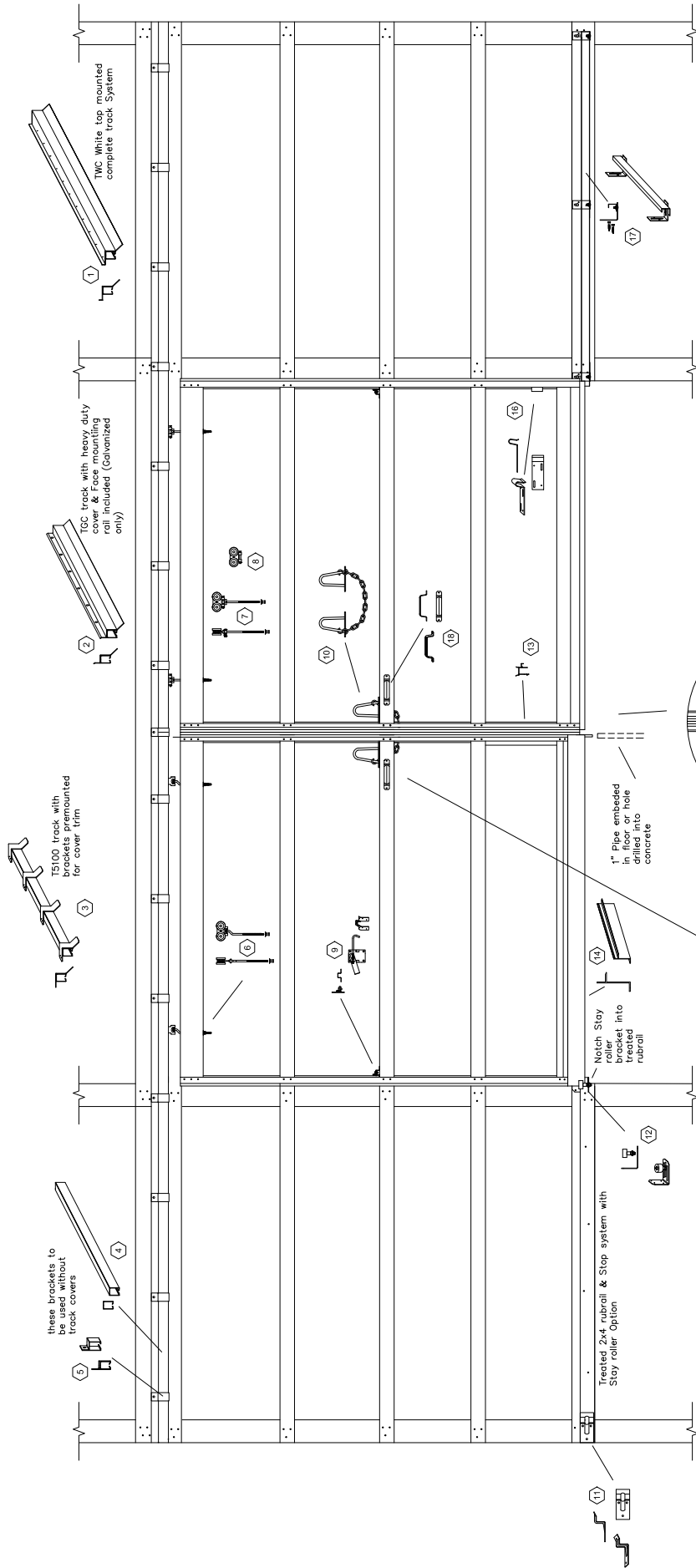

- ① TWC White Top Mount Square track System (8' 10' 12' 16' 20' Length)
- ② TGC Galvanized Covered Face Mount track System (8' 10' 14' 16' 20' lengths)
- ③ T5100 Square track System With Track & Cover brackets preinstalled
- ④ SQR Plain 16 Gauge square track (needs mounting brackets)
- ⑤ ISSB Square Track Hanger
- ⑥ T5022 Square 9" bolt trolley
- ⑦ T3819 Square Trolley (Lawrence)
- ⑧ T32REPLACE Replacement trolley for T3819
- ⑨ TUL 7" Adjustable Jamb Latch
- ⑩ ICS Chain Snugger
- ⑪ TDS Heavy Duty Door Stop
- ⑫ TLGS Large Stay Roller
- ⑬ TCR Connector Rail
- ⑭ TBR Bottom Rail
- ⑮ TCANE Cane Bolt
- ⑯ TJMS Door Keeper Stopper (jamb mounted door stop)
- ⑰ TGR10 10' Slider Guide rail w/3 brackets included
- ⑱ TPC Galvanized Door Pull
- ⑲ TPW White Door Pull



Insulation





FOIL/WHITE (F/W)



FOIL/FOIL (F/F)



MATERIAL DETAIL



Double Bubble Insulation

Double Bubble Reflective Insulation is a double layer of polyethylene bubbles bonded to and sandwiched between a radiant barrier metalized foil and/or white polyethylene sheet. Double Bubble is specifically designed to control heat gain or loss, and prevent interior condensation, in all types of metal and metal-clad buildings.

FEATURES

- Blocks 96% of Radiant Heat Transfer
- Prevents Interior Condensation
- Class 1 / Class A Fire-Rated (ASTM E84-09)
- Puncture and Tear-Resistant
- Unaffected by Humidity
- Will not Promote Mold and Mildew
- Safe, Non-Toxic and Non-Carcinogenic
- Easy to Handle and Install
- Various Tab Options
- UV-Resistant

Part#	Description	Sq. Ft.	Material	Width	Length
IDB16	16" Double Bubble Square Edge	167	F/F	16"	125'
IDB16T	16" Double Bubble - With Staple Tabs	167	F/F	16"	125'
IDB24	24" Double Bubble	250	F/F	24"	125'
IDB475	48" Double Bubble	300	F/F	48"	75'
IDB48	48" Double Bubble	500	F/F	48"	125'
IDB48W	48" Double Bubble	500	F/W	48"	125'
IDB72	72" Double Bubble	750	F/F	72"	125'
IDB72W	72" Double Bubble	750	F/W	72"	125'
IDBCB	48" Ultra Concrete Barrier Double Bubble	500	F/F	48"	125'

Part#	Description	Sq. Ft.	Material	Width	Length
IFT2	2" Metalized Reflective Seam Tape		F	2"	150'
IFT3	3" Metalized Reflective Seam Tape		F	3"	150'
TWT	2" White Seam Tape		W	2"	150'
TWT3	3" White Seam Tape		W	3"	150'

FEATURES

BENEFITS

Reflective Metalized Surface Facing	<ul style="list-style-type: none"> - Reduces Radiant Heat Gain and Loss - Blocks 96% of Radiant Heat Transfer - Saves Energy Use - Lowers Heating/Cooling Costs - Improves Interior Comfort
Multi-Layer Bubble Core	<ul style="list-style-type: none"> - Provides Continuous Thermal Break - Lowers Risk of Interior Surface Condensation - Durable and Long-Lasting - Superior Puncture, Tensile and Tear Strength - Will Not Absorb Water or Vapor - Does Not Harbor Moisture or Mold - Clean, Safe, No-Itch Material
White Interior Facing Option	<ul style="list-style-type: none"> - Brightens Building Interior - Attractive Appearance - Easy to Clean
Practical Tab/Edge Options	<ul style="list-style-type: none"> - Various Options for All Metal Building Applications - Simplifies Installations - Improves Vapor-Sealing Efforts
QuickSeam (Adhesive Tape on Tab)	<ul style="list-style-type: none"> - Saves Time and Labor - Ensures a Continuous Vapor and Condensation Barrier - Simplifies and Speeds Installation

PRODUCTS

SPECIFICATIONS

- AVAILABLE IN:**
- Single or Double Bubble
 - Square Edge, Tab 1 Side, Tab 2 Sides, Quick Seam Adhesive Strip
 - Width: 12", 16", 18", 24", 48" and 72"
 - Length: 102' and 125'



Physical Properties	Test	Double Layer	Single Layer
NOMINAL THICKNESS	—	5/16"	3/16"
FIRE RATING	ASTM E84-09	CLASS 1 / CLASS A	
EMISSIVITY	ASTM C1371-04A	0.04	0.04
REFLECTIVITY	ASTM E903	0.96	0.96
WATER VAPOR PERMEABILITY	ASTM E96	0.42 Perms	0.01 Perms
RESISTANCE TO FUNGI & BACTERIA	ASTM C1149	DOES NOT PROMOTE GROWTH	
PLIABILITY	ASTM C1224-03	NO CRACKING	
BLEEDING AND DELAMINATION	ASTM C1224-03	NO BLEEDING OR DELAMINATION	
CORROSIVENESS	ASTM D3310-00	PASSES	
FIRE RATING - FULL ROOM BURN TEST	NFPA 286	PASSES	



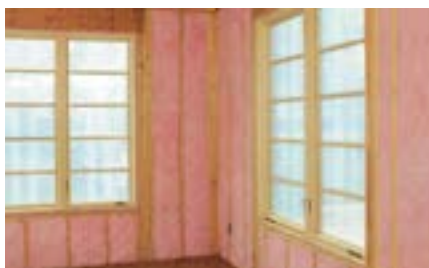

Fiberglass Insulation - Owens Corning™

New EcoTouch® insulation with PureFiber® Technology raises the bar on sustainability while enhancing the performance qualities that have made Owens Corning the most preferred brand in insulation. In fact, Owens Corning™ EcoTouch® insulation is rated #1 for handleability and ease of installation by contractors and is preferred by 2 out of 3 professional installers over all other brands.

FEATURES

- Exceptional stiffness and recovery characteristics with no additional handwork needed so you can achieve high-quality, inspection-ready installs
- Easier to cut and split with less dust, allowing you to properly insulate irregular cavities and around common obstructions
- Installs faster to help you get more done in less time

Part#	Description	R Value	Faced	Bndl. Qty.	Bndl. Sq Ft	Batt D x W x L
IR1315	R-13 Fiberglass Insulation	R-13	Kraft	9 Batts	88.12	4" x 15" x 94"
IR1323	R-13 Fiberglass Insulation	R-13	Kraft	10 Batts	148.54	4" x 24" x 94"
IR1915	R-19 Fiberglass Insulation	R-19	Kraft	1 Roll	49	6" x 15" x 39'-2"
IR1923	R-19 Fiberglass Insulation	R-19	Kraft	1 Roll	75.07	6" x 23" x 39'-2"
IR3016	R-30 Fiberglass Insulation	R-30	Kraft	11 Batts	58.67	10" x 16" x 48"
IR3024	R-30 Fiberglass Insulation	R-30	Kraft	11 Batts	88	10" x 24" x 48"
IR3816	R-38 Fiberglass Insulation	R-38	Kraft	8 Batts	42.67	12" x 16" x 48"
IR3824	R-38 Fiberglass Insulation	R-38	Kraft	8 Batts	64	12" x 24" x 48"
IR4916	R-49 Fiberglass Insulation	R-49	Kraft	5 Batts	32	14" x 16" x 48"
IR4924	R-49 Fiberglass Insulation	R-49	Kraft	4 Batts	48	14" x 24" x 48"
IR2115	R-21 High Density Fiberglass Insulation	R-21	Kraft	7 Batts	67.81	5.5" x 15" x 93"
IR2123	R-21 High Density Fiberglass Insulation	R-21	Kraft	6 Batts	103.98	5.5" x 23" x 93"



Many sizes, thicknesses, and custom lengths available for special order.

Vinyl Backed Insulation

Part#	Description	R Value	Thick.	Size
IVH648STOCK50	WMP-10 Std Vinyl Backed 6" Fiberglass Insulation Rolls	R-19	6"	4' x 50'
IVHT	White Vinyl Backed Metal Building Insulation Tape		3"	x 150'

ACFoam® II - GRF Roof Insulation



Closed-cell polyisocyanurate (polyiso) foam core integrally bonded to non-asphaltic, fiber-reinforced organic felt facers. Offered in a variety of thicknesses, providing long-term thermal resistance (LTTR) values from 5.7 to 26.8.

FEATURES

- Available in 20 or 25 psi
- Zero ozone depletion potential (ODP) and virtually no global warming potential (GWP).
- Responsibly manufactured with zero CFCs, HCFCs, and HFCs.
- Contains between 52.9% and 27.6% recycled materials by weight.

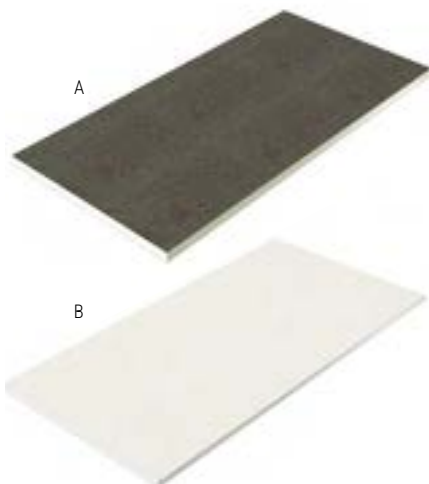

Part#	Description	R Value	Thick.	Size
A ISO1	Felt Faced ISO Insulation - ACFoam-II A Grade	R 5.7	1"	4' x 8'
A ISO15	Felt Faced ISO Insulation - ACFoam-II A Grade	R 8.6	1.5"	4' x 8'
A ISO2	Felt Faced ISO Insulation - ACFoam-II A Grade	R 11.4	2"	4' x 8'
A ISO3	Felt Faced ISO Insulation - ACFoam-II A Grade	R 17.4	3"	4' x 8'
B ISO12	White Fiber Faced HD Cover Board Insulation	R 2.5	0.5"	4' x 8'





Mineral Wool Insulation RockWool Comfort Batt

Stone wool has several properties that make it an excellent insulation. The ROCKWOOL manufacturing process transforms basalt rock and recycled slag into insulation that combines the physical properties of stone with many of the characteristics of typical insulation wool. ROCKWOOL is easier to handle and install than fiberglass insulation. It is more water resistant, fire resistant, and sound resistant than any other insulation.

FEATURES

- Energy Efficient: ROCKWOOL stone wool will not excessively shrink, expand, or sag over time, even after exposure to large temperature swings and varying levels of moisture exposure
- Water Resistant: Stone wool is resistant to water infiltration; therefore bulk water that contacts the outer surface of the insulation will largely drain away and will not be absorbed.
- Mold Resistant: Does not support mold or fungal growth
- Non-combustible: Fire resistant up to 2150 °F
- Environmentally Responsible: ROCKWOOL products are created from natural volcanic rock and contain up to 40% recycled content in the form of slag from steel production
- Sound Proofing: ROCKWOOL stone wool insulation is spun out of multi-directional stone fibers that effectively absorb low-frequency sound. Stone wool is also denser than many other insulation materials

Part#	Description	R Value	Bndl. Qty.	Bndl. Sq Ft	Batt D x W x L
IM1516	R-15 Mineral Wool Comfort Batt	R-15	12 Batts	59.73	3.5" x 15.25" x 47"
IM1524	R-15 Mineral Wool Comfort Batt	R-15	8 Batts	60.06	3.5" x 23" x 47"
IM2316	R-23 Mineral Wool Comfort Batt	R-23	8 Batts	39.82	5.5" x 15.25" x 47"
IM2324	R-23 Mineral Wool Comfort Batt	R-23	5 Batts	37.53	5.5" x 23" x 47"

Great Stuff Spray Foam



Part#	Description	Case Qty.	W/Straw	Size
IEBK12	Black Multi-Purpose Foam Sealant		•	12 Oz
IEFBG12	Big Gap Filler - Triple Expanding Foam Sealant	12	•	12 Oz
IEFBG20	Big Gap Filler - Triple Expanding Foam Sealant	12	•	20 Oz
IEFFBGS12	Fireblock Insulating Foam Sealant, Orange		•	12 Oz
IEFGCGS12	Gaps & Cracks Foam Sealant - Fills up to 1" Gaps	12	•	12 Oz
	Gaps & Cracks Foam Sealant - Gun Foam- Fireblock - Sealant			
IEFGC	Has Identifiable Orange Color	12		24 Oz
IEFGCL	Foam Gun Tool Cleaners			12 Oz
IEFPB12	Pest Block Expanding Foam		•	12 Oz
IEFWDGS12	Window & Door Foam		•	12 Oz
IEFWD	Window & Door Foam - Gun Foam			20 Oz
IEFWDGS20	Window & Door Foam	12	•	20 Oz
IEFWF	Gun Foam - Wall & Subfloor Adhesive - Heavy Duty			26.5 Oz

Froth Pak Spray Foam

For professional use. Quick 30 second cure time. Class A fire rated.



Part#	Description	Coverage	Skid Qty.
IEFFP200F	Twin Tank Spray Foam Insulation	210 Board Ft	26
IEFFP620F	Twin Tank Spray Foam Insulation, 2 - 60 Lb. Tank	620 Board Ft	9

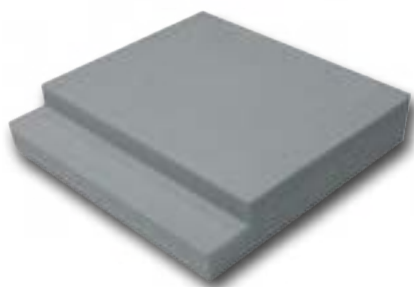

Dupont Styrofoam Insulation

STYROFOAM™ Brand Insulation is an extruded polystyrene foam insulation board that meets the needs of the commercial foundation and building floor slab market. This insulation can also be used for attics, foundations/slabs and crawl spaces in residential applications. STYROFOAM™ Extruded Polystyrene Foam (XPS) Insulation has more than 60 years of proven performance in wet environments. The closed-cell structure of STYROFOAM™ Extruded Polystyrene Foam (XPS) Insulation resists water pickup, enabling it to retain a high R-value over time – a necessary property in wet, below-grade commercial foundation applications.



Part#	Description	R Value	Skid Qty.	PSI	Size
IS12	1/2 in Film-Faced Styrofoam	R-2.5	160	25	4"x8"
IS34	3/4 in Styrofoam Tongue & Groove	R-3.75	128	25	4"x8"
IS1	1 in Styrofoam Tongue & Groove	R-5	96	25	4"x8"
IS2	2 in Styrofoam Tongue & Groove	R-10	48	25	4"x8"
IS15	1 1/2" Styrofoam Tongue & Groove	R-7.5	64	25	4"x8"



Expanded Polystyrene Insulation

EPS Insulation sheets are the perfect solution for continuous insulation applications due to its polymeric film facers and polystyrene core.

FEATURES

- Designed specifically to be installed in place of, or over wood sheathing/purlins on new construction applications.
- Polymeric film facer on one side, with a reflective barrier on the other.
- Class II vapor retarder, over 1 perm.
- Limited Lifetime Warranty.
- Foil on back and clear white on front.

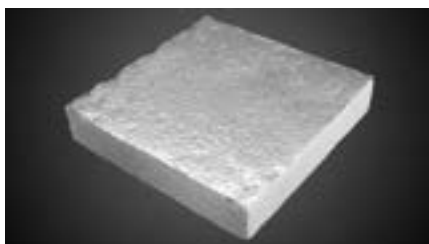

Part#	Description	R Value	PSI	Facing	Bndl. Qty.	D x W x L
IPSC12W	ESP White Poly/Foil Insulation	R-2.1	25	Poly/Foil	25	1/2" x 4' x 8'
IPSC1	ESP White Poly/Foil Insulation	R-3.2	10	Poly/Foil	12	1" x 4' x 8'
IPSC115	ESP White Poly/Foil Insulation	R-4.8	10	Poly/Foil	8	1-1/2" x 4' x 8'
IPSC240	ESP White Poly/Gray Insulation Below Grade with Termite Inhibitor	R-10	40	Poly/Clear	5	2.25" x 4' x 8'



Green Guard Fan Fold Insulation

White on one side.

Part#	Description	R Value	Thick.	Size
IFF	Fan Fold Insulation - Green Guard	R-1.5	3/8"	4' x 50'





Blown Cellulose Insulation - Sanctuary

Increased coverage area and decrease job site times with this 25 lbs. bag of Sanctuary low-dust insulation. The loose fill fibers fill gaps and voids to create an energy saving thermal blanket that keeps homes comfortable in extreme cold and hot temperatures while reducing outside noise. Fire resistant treated insulation is made with up to 85% recycled material that meets Class 1 Fire Rating to protect homes; providing more time for evacuation.

FEATURES

- Less expensive than Fiberglass
- Made in the USA with 85% recycled content.
- Dense for minimal settling
- Treated for fire resistance

Part#	Description	Sq. Ft. @ R30	Weight
IBWC	Cellulose Blowing Insulation	25.9	25 lbs



Blown Fiberglass Insulation - ProPink L77

Highest coverage: High Performance Fiberizing Technology allows ProPink®L77 Loosefill to provide the highest yield of any loosefill insulation available. One 32-lb bag can cover 77 square feet at R-30.

FEATURES

- Less mess than Cellulose
- Noncombustible and non-corrosive
- Ultra-performance - no settling
- Will not rot, mildew, or deteriorate.
- Blows fast and smooth

Part#	Description	Sq. Ft. @ R30	Weight
IBWF	Fiberglass Blowing Insulation	77	30 lbs

See coverage charts on the next page



Durovent Attic Vent Baffle

An economical way to meet energy code requirements for air flow.

FEATURES

- 18.7 sq in net free vent
- Perforated for use at 16" on center
- 24" on center max width
- Wide nailing flange and center strut

Part#	Description	Bag Qty.	Size
IRV	Polystyrene Attic Vent Insulation Baffle	50	22" x 48"



Accuvent Attic Vent Baffle

The dual function design creates ventilation channels under the roof sheathing for healthy air circulation while integral baffles prevent wind-washing. AccuVent offers a quick and inexpensive solution for architects, builders, and renovators to ensure proper insulation performance for better energy efficiency and indoor air quality. AccuVent baffles are adaptable for any application, roof pitch, or truss size and install quickly and easily with just a few staples. They are manufactured from 100% recycled, flame-retardant PVC – a material that is compatible with all insulation types, including spray foam.

Part#	Description	Bundle Qty.	Size
IAV	PVC Attic Vent Insulation Baffle	50	22.5" x 48"

Insulation Coverage Charts



ATTIC COVERAGE CHART – LOOSE-FILL AND STABILIZED APPLICATIONS

Tabla de Cobertura de Ático - Aplicaciones de Relleno Suelto y Aplicaciones Estabilizadas

25lbs (11.3kg)						SANCTUARY®	
R-Value at 75° F Mean Temp. <small>Valor de resistencia térmica (valor R) at 75° F de temperatura media</small>	Minimum Thickness (inches) <small>Espesor mínimo (en pulgadas)</small>		Net Coverage (no adjustment for framing) <small>Cobertura neta (sin compensación para la estructura)</small>			Net Coverage (adjusted for 2" x 6" framing on 16" centers) <small>Cobertura neta (con compensación para una estructura de 2" x 6" en centros de 16")</small>	
	Initial Installed Thickness <small>Espesor inicial instalado</small>	Settled Thickness <small>Espesor asentado</small>	Maximum Sq. Ft. per Bag <small>Pies cuadrados máximos por bolsa</small>	Minimum Bags per 1,000 Sq. Ft. <small>Cantidad mínima de bolsas por 1,000 pies cuadrados</small>	Minimum Weight per Sq. Ft. <small>Peso mínimo por pie cuadrado</small>	Maximum Sq. Ft. per Bag <small>Pies cuadrados máximos por bolsa</small>	Minimum Bags per 1,000 Sq. Ft. <small>Cantidad mínima de bolsas por 1,000 pies cuadrados</small>
11	3.3	3.0	78.6	12.7	0.32	86.7	11.5
13	3.9	3.6	65.8	15.2	0.38	72.6	13.8
19	5.7	5.3	44.2	22.6	0.57	48.8	20.5
22	6.6	6.1	38.0	26.3	0.66	41.2	24.2
26	7.7	7.2	31.2	32.1	0.80	33.4	30.0
30	8.9	8.3	25.9	38.6	0.97	27.4	36.5
32	9.5	8.8	23.8	42.0	1.05	25.2	39.7
38	11.2	10.4	19.0	52.6	1.32	19.9	50.1
40	11.8	10.9	17.7	56.5	1.41	18.6	53.8
44	12.9	12.0	15.7	63.5	1.59	16.5	60.8
48	14.0	13.0	14.1	70.8	1.77	14.6	68.5
49	14.3	13.3	13.8	72.6	1.81	14.2	70.2
50	14.6	13.5	13.5	74.3	1.86	14.0	71.4
60	17.3	16.1	10.8	92.5	2.31	11.1	89.8

LOOSE-FILL APPLICATIONS

THE ABOVE COVERAGE CHART IS BASED ON A NOMINAL BAG WEIGHT OF 25 LBS USING A VOLUMATIC III, 3RD GEAR AND 8" GATE. THE CHART IS BASED ON SETTLED THICKNESS AND IS FOR ESTIMATING PURPOSES ONLY. DO NOT EXCEED MAXIMUM SQUARE FEET COVERAGE PER BAG. THE APPLICATOR MUST INSTALL BOTH THE MINIMUM NUMBER OF BAGS PER 1000 SQ. FT. AND THE MINIMUM INSTALLED THICKNESS TO ENSURE THE STATED R-VALUE HAS BEEN REACHED. FAILURE TO MEET BOTH THESE REQUIREMENTS MAY PREVENT THE APPLICATION OF SPECIFIED R-VALUE. JOB CONDITIONS, APPLICATION TECHNIQUES, EQUIPMENT AND SETTINGS CAN INFLUENCE ACTUAL COVERAGE. MINIMUM NET WEIGHT IS 23.75 LBS.

STABILIZED APPLICATIONS

THE ABOVE COVERAGE CHART IS BASED ON A NOMINAL BAG WEIGHT OF 25.0 LBS USING A VOLUMATIC III, 3RD GEAR AND 6" GATE. THE CHART IS BASED ON SETTLED THICKNESS AND IS FOR ESTIMATING PURPOSES ONLY. DO NOT EXCEED MAXIMUM SQUARE FEET COVERAGE PER BAG. THE APPLICATOR MUST INSTALL BOTH THE MINIMUM NUMBER OF BAGS PER 1000 SQ. FT. AND THE MINIMUM INSTALLED THICKNESS TO ENSURE THE STATED R-VALUE HAS BEEN REACHED. FAILURE TO MEET BOTH THESE REQUIREMENTS MAY PREVENT THE APPLICATION OF SPECIFIED R-VALUE. THE INSTALLED MOISTURE CONTENT MUST BE BETWEEN 16% AND 25% IN ATTIC APPLICATIONS. JOB CONDITIONS, APPLICATION TECHNIQUES, EQUIPMENT, AND SETTINGS CAN INFLUENCE ACTUAL COVERAGE. MINIMUM NET WEIGHT IS 23.75 LBS.



Attics

Nominal Bag Weight 32 lbs.

R-VALUE	MINIMUM INITIAL INSTALLED THICKNESS (IN.)	MINIMUM SETTLED THICKNESS*	MAXIMUM COVERAGE PER BAG (SQ. FT.)	MINIMUM BAGS PER 1000 SQ. FT.	MINIMUM WEIGHT (LBS PER SQ. FT.)
13	4.75	4.75	184.6	5.4	0.173
19	7.00	7.00	125.0	8.0	0.256
22	8.00	8.00	106.3	9.4	0.301
26	9.25	9.25	89.6	11.2	0.357
30	10.50	10.50	77.0	13.0	0.416
38	13.25	13.25	59.9	16.7	0.534
44	15.00	15.00	50.7	19.7	0.631
49	16.75	16.75	45.0	22.2	0.711
60	20.00	20.00	35.8	28.0	0.895





AFCAT Pro-Shield Insulation



TECHNICAL DATASHEET

USES

- Metal Building
- Post Frame Building
- Mini Storage
- Agricultural Building
- Livestock

INSTALL INSTRUCTIONS & NOTES

- NOT for outdoor use
- Do not expose to temperatures in excess of 180 °F
- Use caution when using around electrical wiring

BENEFITS

- Superior Strength
- Class 1/A Fire Rating
- Vapor Barrier
- 95% Reflectivity
- Contains UV Inhibitors
- Easy to Install & Maintain
- Birds Cannot Nest or Puncture
- Can Be Power Washed

R-VALUES

- Downward: 14.2
- Upward: 5.6
- Horizontal: 7.5

WARRANTY AND SHELF LIFE

AFCAT Group Inc. warrants this product for ten years from date of purchase and that product shall meet its specifications and be free of defects in workmanship. See afcatusa.com for full warranty

PHYSICAL PROPERTIES

Emittance / Product / Metalized Film	ASTM C1371 / 0.057 / 0.033
Water Vapor Transmission (Perm)	ASTM E96 / 0.050
Temperature & Humidity Resistance	ASTM C1258 / PASS
Water Vapor Transmission (perm) (after C1258)	ASTM E96 / 0.059
Adhesive Performance - Bleeding & Delamination	ASTM C1224 / PASS
Adhesive Performance - Pliability	ASTM C1224 / PASS
Fungi Resistance / White Side / Metal Side	ASTM C1338 / PASS / PASS
Surface Burning Characteristics	ASTM E84
Flame Spread Index / Smoke Developed Index	PASS / PASS
Tensile Strength * (lb / in ²)	ASTM D882*
Machine Direction / Cross Machine Direction	618.1 / 403.8
Penetration Resistance *	ASTM F1306*
Penetration Load (lb) / Energy at Penetration (lb in)	10.2 / 1.37

Part#	Description	Unit Type	Size
ASFR48X125SE	Scrim/Foam/Reflective	each	48" x 125'
ASFR72X125SE	Scrim/Foam/Reflective	each	72" x 125'

Concrete & Accessories





Concrete Mix

QUIKRETE® Concrete Mix is the original 4000 psi average compressive strength blend of portland cement, sand, and gravel or stone. Just add water and mix well. Use for any general concrete work. Achieves 2500 psi in 7 days and a maximum of 4000 psi in 28 days.

Part#	Description	CF/bag	PSI	Pallet Qty	Weight
QCM	Quikrete Concrete Mix	.06	4000	42	80 lbs



Fast-setting

QUIKRETE® Fast-Setting Concrete Mix is a special blend of fast-setting cements, sand and gravel designed to set hard in approx. 20 to 40 minutes. Sets posts without mixing. Pour dry mix into hole and soak with water.

Part#	Description	PSI	Pallet Qty	Weight
QFS	Quikrete Redbag Fast-Setting Concrete Mix	4000	64	50 lbs



Mason Type S

QUIKRETE® Mason Mix is a high strength Commercial Grade dry pre-blended mixture of sand and cements specially selected for masonry applications. Meets N, S, M requirements as specified in ASTM C270. Just add water.

Part#	Description	Pallet Qty	Weight
QMM	Quikrete Mason Mix Type S Mortar Just Add Water	42	80 lbs
QMM-N	Quikrete Mason Mix TYPE N Mortar		80 lbs
QMCS	Masonry Cement Type S - White Bag		70 lbs



Mason Sand

Part#	Description	Weight
QSAND	Fine Mason Sand - Super Sack	2000 lbs
QMS	Fine Mason Sand	50 lbs



Portland Cement

QUIKRETE® Portland Cement complies with current ASTM C150 and Federal Specifications for portland cement. Can be mixed with aggregate and other ingredients to make concrete mix, mortar mix, and base coat stucco. Available in Type I, Type I/II and Type III.

Part#	Description	Pallet Qty.	Weight
QPC	Quikrete Portland Cement Type I/II Gray	35	94 lbs



Play Sand

Part#	Description	Pallet Qty.	Weight
QPS	Quikrete Play Sand	56	50 lbs





Concrete Wire

Part#	Description	Skid Qty	Thickness	Gauge	Grid	Length
WCW510	Concrete Wire	100	0.134"	10 Ga	6" x 6"	5' x 10'
WCW5108	Concrete Wire	100	0.164"	8 Ga	6" x 6"	5' x 10'
WCW5106	Concrete Wire	100	0.192"	6 Ga	6" x 6"	5' x 10'

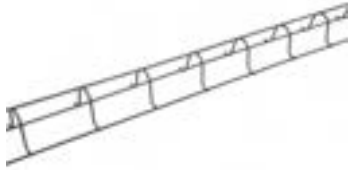

Concrete Rebar Wire Chairs

Part#	Description	Size
WCSB2	Wire Rebar Chairs - Upper Slab Bolster	2" x 5"
WCSB3	Wire Rebar Chairs - Upper Slab Bolster	3" x 5"



Concrete Rebar

Part#	Description	#	Thickness	Length
REBAR12	Concrete Rebar	4	1/2"	12"
REBAR18	Concrete Rebar	4	1/2"	18"
REBAR24	Concrete Rebar	4	1/2"	24"
REBAR36	Concrete Rebar	4	1/2"	36"
REBAR1220	Concrete Rebar	4	1/2"	20'
REBAR5820	Concrete Rebar	5	5/8"	20'
REBAR1210	Concrete Rebar	4	1/2"	10"



BT1761**

TW16312EAR

Concrete Rebar Wire Tie

Part#	Description	Length	Qty.
BT176100R	6" Concrete Rebar Wire Tie	6"	100
BT1661MR	6" Concrete Rebar Wire Tie	6"	1000
TW16312EAR	16 Gauge Concrete Rebar Wire Tie		10
TWREAR	Reel Concrete Rebar Wire Tie		



Wire Tie Twister

Part#	Description	Length	Qty.
BTTWEAR	Tie Wire Twister Tool		





Y14640-2



Y14640-4



Concrete Rebar Cap

Part#	Description	Fits Rebar
Y14640-2	Concrete Rebar Large Cap	1/2" - 2"
Y14640-4	Concrete Rebar Orange Osha	1/2" - 1-1/2"

Concrete Form Pins

Part#	Description	Pack Qty	Size
FP3424	Concrete Form Pin	10	3/4" X 24"
FP3430	Concrete Form Pin	10	3/4" X 30"
FP3436	Concrete Form Pin	10	3/4" X 36"

Concrete Pole Pills

Part#	Description	Skid Qty	Thickness	Diameter
POLPIL12	Concrete Pole Pills	54	5"	12"
POLPIL16	Concrete Pole Pills	24	5"	16"
POLPIL616	Concrete Pole Pills	30	6"	16"



Concrete Block

Part#	Description	Depth	Height	Length	Skid Qty.
B2816S	Solid Block	2"	8"	16"	270
B4816H	Hollow Block	4"	8"	16"	144
B4816S	Solid Block	4"	8"	16"	144
B6816H	Hollow Block	6"	8"	16"	144
B8816H	Hollow Block	8"	8"	16"	108
B10816H	Hollow Block	10"	8"	16"	90
B12816H	Hollow Block	12"	8"	16"	78





Quik-tube Concrete Form

Part#	Description	Size
QFT8	Concrete Form Tube	8" x 48"
QFT12	Concrete Form Tube	12" x 48"
QFT18	Concrete Form Tube	18" x 48"



Concrete Expansion Joint

Part#	Description	Size
Y6917-03	Concrete Expansion Joint Strips - 1/2" Thick	4" x 5'
EXP04050	Concrete Expansion Joint Roll - 1/2" Thick	4" x 50'
EXP06050	Concrete Expansion Joint Roll - 1/2" Thick	6" x 50'



DryLok Masonry Waterproofer

Part#	Description	Coverage	Size
PDLWW	Drylok Latex Base Masonry Waterproofer	Up To 125 Sq Ft	1 Gal.
PDLWW5	Drylok Latex Base Masonry Waterproofer	Up To 625 Sq Ft	5 Gal.
PDLEWW	Drylok Extreme Latex Base Masonry Waterproofer	Up To 125 Sq Ft	1 Gal.
PDLEWW5	Drylok Extreme Latex Base Masonry Waterproofer	Up To 625 Sq Ft	5 Gal.
Y90237	Synthetic Drylok Paint Brush		4"



Concrete and Masonry Sealer

Part#	Description	Coverage	Gal.
DECO20-1	Deco 20 Penetrating Sealer for concrete or masonry	Up To 125 sqft	1 gal
DECO20	Deco 20 Penetrating Sealer for concrete or masonry	Up To 600 sqft	5 gal
DECO30-1	Deco 30 Penetrating Brick Sealer and Stucco Sealer	Up To 200 sqft	1 gal
DECO30	Deco 30 Penetrating Brick Sealer and Stucco Sealer	Up To 1000 sqft	5 gal



Composite Footing Pads

Part#	Description	Skid Qty	Diameter
LPCFP12	Composite Footing Pad for Posts And Perma Column	300	12"
LPCFP20	Composite Footing Pad for Posts And Perma Column	80	20"
LPCFP24	Composite Footing Pad for Posts And Perma Column	68	24"



Welded Wire Fencing & Poultry Netting



1/2" x 1" Grid

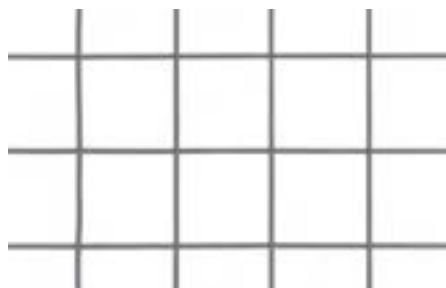

1" x 1" Grid



1" x 2" Grid

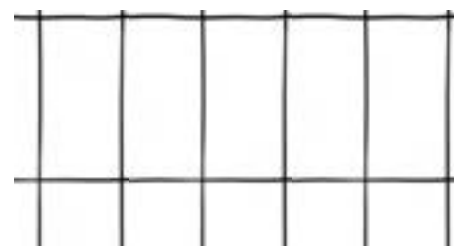

2" x 4" Grid

Galvanized Welded Wire Fencing

Part#	Description	Gauge	Grid	Height	Length
WW2412116	Galvanized Welded Wire Fencing	16	1/2"x1"	24"	100'
WW3612116	Galvanized Welded Wire Fencing	16	1/2"x1"	36"	100'
WW4812116	Galvanized Welded Wire Fencing	16	1/2"x1"	48"	100'
WW361114	Galvanized Welded Wire Fencing	14	1"x1"	36"	100'
WW481114	Galvanized Welded Wire Fencing	14	1"x1"	48"	100'
WW601114	Galvanized Welded Wire Fencing	14	1"x1"	60"	100'
WW181214	Galvanized Welded Wire Fencing	14	1"x2"	18"	100'
WW241214	Galvanized Welded Wire Fencing	14	1"x2"	24"	100'
WW36121450	Galvanized Welded Wire Fencing	14	1"x2"	36"	50'
WW361214	Galvanized Welded Wire Fencing	14	1"x2"	36"	100'
WW48121450	Galvanized Welded Wire Fencing	14	1"x2"	48"	50'
WW481214	Galvanized Welded Wire Fencing	14	1"x2"	48"	100'
WW601214	Galvanized Welded Wire Fencing	14	1"x2"	60"	100'
WW721214	Galvanized Welded Wire Fencing	14	1"x2"	72"	100'
WW483250	Galvanized Welded Wire Fencing	16	3"x2"	48"	50'
WW2424125	Galvanized Welded Wire Fencing	12.5	2"x4"	24"	100'
WW362450	Galvanized Welded Wire Fencing	12.5	2"x4"	36"	50'
WW3624125	Galvanized Welded Wire Fencing	12.5	2"x4"	36"	100'
WW4824125	Galvanized Welded Wire Fencing	12.5	2"x4"	48"	100'
WW6024125	Galvanized Welded Wire Fencing	12.5	2"x4"	60"	100'
WW7224125	Galvanized Welded Wire Fencing	12.5	2"x4"	72"	100'



Galvanized Hardware Cloth

Part#	Description	Gauge	Grid	Height	Length
WHC361810	Galvanized Hardware Cloth	27 Ga.	1/8"	36"	10'
WHC24145	Galvanized Hardware Cloth	23 Ga.	1/4"	24"	5'
WHC241450	Galvanized Hardware Cloth	23 Ga.	1/4"	24"	50'
WHC241210	Galvanized Hardware Cloth	19 Ga.	1/2"	24"	10'
WHC241250	Galvanized Hardware Cloth	19 Ga.	1/2"	24"	50'
WHC361250	Galvanized Hardware Cloth	19 Ga.	1/2"	36"	50'
WHC481250	Galvanized Hardware Cloth	19 Ga.	1/2"	48"	50'





Galvanized Poultry Netting

Part#	Description	Gauge	Grid	Height	Length
WPN24150	Galvanized Poultry Netting	20	1"	24"	50'
WPN241	Galvanized Poultry Netting	20	1"	24"	150'
WPN36150	Galvanized Poultry Netting	20	1"	36"	50'
WPN361	Galvanized Poultry Netting	20	1"	36"	150'
WPN48150	Galvanized Poultry Netting	20	1"	48"	50'
WPN481	Galvanized Poultry Netting	20	1"	48"	150'
WPN60150	Galvanized Poultry Netting	20	1"	60"	50'
WPN601	Galvanized Poultry Netting	20	1"	60"	150'
WPN72150	Galvanized Poultry Netting	20	1"	72"	50'
WPN721	Galvanized Poultry Netting	20	1"	72"	150'

Black Vinyl Coated Poultry Netting

Part#	Description	Gauge	Grid	Height	Length
WPPN241-50	Vinyl Coated Poultry Netting	20	1"	24"	50'
WPPN241-150	Vinyl Coated Poultry Netting	20	1"	24"	150'
WPPN361-50	Vinyl Coated Poultry Netting	20	1"	36"	50'
WPPN361-150	Vinyl Coated Poultry Netting	20	1"	36"	150'
WPPN481-50	Vinyl Coated Poultry Netting	20	1"	48"	50'
WPPN481-150	Vinyl Coated Poultry Netting	20	1"	48"	150'
WPPN601-150	Vinyl Coated Poultry Netting	20	1"	60"	150'
WPPN721-150	Vinyl Coated Poultry Netting	20	1"	72"	150'



Pipe & Fittings





Black Poly Water Pipe

Part#	Description	LB Rating	Size	Length
PBP12100160	Black Poly Water Pipe	160	1/2"	100'
PBP34100160	Black Poly Water Pipe	160	3/4"	100'
PBP34400160	Black Poly Water Pipe	160	3/4"	400'
PBP1100160	Black Poly Water Pipe	160	1"	100'
PBP1300160	Black Poly Water Pipe	160	1"	300'
PBP125100160	Black Poly Water Pipe	160	1-1/4"	100'
PBP125300160	Black Poly Water Pipe	160	1-1/4"	300'



YPE-SSFA**



YUMASS-**

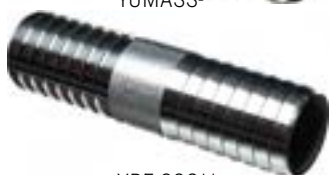

YPE-SSC**



YPE-SST**



YPE-SSE**

Stainless Steel Water Pipe Fittings

Part#	Description	Size
YPE-SSFA07	3/4" Stainless Steel Insert X FMT Adapter	3/4"
YPE-SSFA10	1" Stainless Steel Insert X FMT Adapter	1"
YUMASS-10	1" Stainless Steel Insert X MTH Adapter	1"
YUMASS-12	1-1/4" Stainless Steel Insert X MTH Adapter	1-1/4"
YUMASS-15	1-1/2" Stainless Steel Insert X MTH Adapter	1-1/2"
YPE-SSC05	1/2" Stainless Steel Insert Coupling	1/2"
YPE-SSC07	3/4" Stainless Steel Insert Coupling	3/4"
YPE-SSC10	1" Stainless Steel Insert Coupling	1"
YPE-SST07	3/4" Stainless Steel Insert Tee	3/4"
YPE-SST10	1" Stainless Steel Insert Tee	1"
YPE-SST12	1-1/4" Stainless Steel Insert Tee	1-1/4"
YPE-SST15	1-1/2" Stainless Steel Insert Tee	1-1/2"
YPE-SSE07	3/4" Stainless Steel Insert Elbow	3/4"
YPE-SSE10	1" Stainless Steel Insert Elbow	1"
YPE-SSE15	1-1/2" Stainless Steel Insert Elbow	1-1/2"

Stainless Steel Hoseclamps

Part#	Description	Size
Y6810053	#10 Stainless Steel Hoseclamp	1/2" - 1-1/16"
Y6812053	#12 Stainless Steel Hoseclamp	1/2" - 1-1/4"
Y6816053	#16 Stainless Steel Hoseclamp	11/16" - 1-1/2"
Y6820053	#20 Stainless Steel Hoseclamp	3/4" - 1-3/4"
Y6824053	#24 Stainless Steel Hoseclamp	1" - 2"
Y6828053	#28 Stainless Steel Hoseclamp	1-1/4" - 2-1/4"





Schedule 40 PVC DWV Pipe

Part#	Description	Size	Length
PVC1210	Sch 40 PVC DWV Pipe	1/2"	10'
PVC3410	Sch 40 PVC DWV Pipe	3/4"	10'
PVC110	Sch 40 PVC DWV Pipe	1"	10'
PVC12510	Sch 40 PVC DWV Pipe	1-1/4"	10'
PVC1510	Sch 40 PVC DWV Pipe	1-1/2"	10'
PVC210	Sch 40 PVC DWV Pipe	2"	10'
PVC310	Sch 40 PVC DWV Pipe	3"	10'
PVC320BE	Sch 40 PVC DWV Pipe - Bell End	3"	20'
PVC410	Sch 40 PVC DWV Pipe	4"	10'
PVC410BE	Sch 40 PVC DWV Pipe - Bell End	4"	10'
PVC420	Sch 40 PVC DWV Pipe - Newville Only	4"	20'
PVC420BE	Sch 40 PVC DWV Pipe - Bell End	4"	20'
PVC610	Sch 40 PVC DWV Pipe	6"	10'
PVC620	Sch 40 PVC DWV Pipe - Bell End - Newville Only	6"	20'



Schedule 40 PVC DWV Pipe Fittings

Part#	Description	Pipe Size
PVC**22	PVC DWV 22-1/2 Degree Elbow	1-1/2" • 2" • 3" • 4"
PVC**S22	PVC DWV 22-1/2 Degree Street Elbow	2" • 3" • 4"
PVC**45	PVC DWV 45 Degree Elbow	1-1/2" • 2" • 3" • 4" • 6"
PVC**S45	PVC DWV 45 Degree Street Elbow	1-1/2" • 2" • 3" • 4" • 6"
PVC**60	PVC DWV 60 Degree Elbow	1-1/2" • 2" • 3" • 4"
PVC**90	PVC DWV 90 Degree Elbow	1-1/2" • 2" • 3" • 4" • 6"
PVC**S90	PVC DWV 90 Degree Street Elbow	1-1/2" • 2" • 3" • 4" • 6"
PVC**L90	PVC DWV 90 Degree Long Sweep Elbow	4"
PVC**V90	PVC DWV 90 Degree Vent Elbow	2" • 3"
PVC**Y	PVC DWV Wye	1-1/2" • 2" • 3" • 4"
PVC33*TY	PVC DWV Tee/Wye	3"x3"x1-1/2" • 3"x3"x2" • 3"
PVC33*T	PVC DWV Reducing Tee	3"x3"x1-1/2" • 3"x3"x2"
PVC33*Y	PVC DWV Reducing Wye	3"x3"x1-1/2" • 3"x3"x2"





PVC**C



PVC**EC



PVC**T



PVC*FS



PVC43RC



Y42097



Y43495



Y43633



Y70232



Y716*0

Schedule 40 PVC DWV Pipe Fittings - Continued

Part#	Description	Pipe Size
PVC**C	PVC DWV Coupling	1-1/2" • 2" • 3" • 4" • 6"
PVC**EC	PVC DWV End Cap	1-1/2" • 2" • 3" • 4" • 6"
PVC**T	PVC DWV Sanitary Tee	1-1/2" • 2" • 3" • 4" • 6"
PVC*FS	PVC Vinyl Floor Strainer	3" • 4"
PVC43RC	4" to 3" PVC DWV Reducer Coupling	4" to 3"
Y42097	PVC Shower Stall Drain	2"
Y43495	PVC Closet Flange W/SS Ring	3" • 4"
Y43633	9"X9" PVC Bell Trap Drain	3"
Y70232	3" to 2" PVC Dww Reducer Bushing	3" to 2"
Y716*0	PVC DWV Cleanout Body with Plug	2" • 3" • 4"



Y30757



Y31014

PVC Pipe Primer and Cement

Part#	Description
Y30757	Low VOC Purple Primer - 16oz
Y31014	Low VOC PVC Reg Clear Cement - 16oz

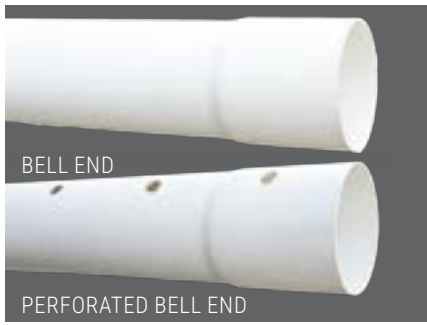

Sewer & Drain PVC Pipe

Part#	Description	Size	Length
PVC310SDBE	Sewer & Drain Solid PVC Pipe - Bell End	3"	10'
PVC410SDBE	Sewer & Drain Solid PVC Pipe - Bell End	4"	10'
PVC410SDPBE	Sewer & Drain Perforated PVC Pipe - Bell End	4"	10'
PVC610SDBE	Sewer & Drain Solid PVC Pipe - Bell End	6"	10'
PVC410SDR35BE	SDR35 Green Solid Pvc Pipe (Bell End)	4"	10'
PVC410SDR35PBE	SDR35 Green Perforated Pvc Pipe (Bell End)	4"	10'

Sewer & Drain PVC Pipe Fittings

Part#	Description	Pipe Size
PVC445SD	PVC Sewer & Drain 45 Degree Elbow	4"
PVC4YSD	PVC Sewer & Drain 45 Degree Wye	4"
PVC4BNTSD	PVC Sewer & Drain Bull Nose Tee	4"
PVC4TSD	PVC Sewer & Drain Sanitary Tee	4"
PVC4S90SD	PVC Sewer & Drain Street 90 Degree Elbow	4"
PVC490SD	PVC Sewer & Drain 90 Degree Sanitary Elbow	4"
PVC4S45SD	PVC Sewer & Drain 45 Degree Street Elbow	4"
PVC422SD	PVC Sewer & Drain 22-1/2 Degree	4"
PVC*COsd	PVC Sewer & Drain Coupling	3" • 4"
PVC43COsd	4" to 3" PVC Sewer & Drain Coupling	4" to 3"
PVC4CSD	PVC Sewer & Drain Drain Cap	4"
pVC4Fssd	PVC Sewer & Drain Floor Strainer	4"
Y422G-AST	NDS 422G Pop-Up Drain Emitter With Elbow	4"
YVC4	Screw On Vent Cap	4"





Tuff-Tite Channel Floor Drain

Interlocking design.

Part#	Description	Size	Length
FD35	Tuff-Tite Channel Floor Drain - Interlocking	5"	36"



Black Perforated Corrugated Pipe

Sold by the roll or by the linear foot.

Part#	Description	Size	Length
PBCP3100	Black Perforated Corrugated Pipe	3"	100'
PBCP410	Black Perforated Corrugated Pipe - Newville Only	4"	10'
PBCP4100	Black Perforated Corrugated Pipe	4"	100'
PBCP6100	Black Perforated Corrugated Pipe	6"	100'
PBCP4250	Black Perforated Corrugated Pipe	4"	250'



Black Solid Corrugated Pipe

Sold by the roll or by the linear foot.

Part#	Description	Size	Length
PBC3100	Black Solid Corrugated Pipe	3"	100'
PBC410	Black Solid Corrugated Pipe - Newville Only	4"	10'
PBC4100	Black Solid Corrugated Pipe	4"	100'
PBC6100	Black Solid Corrugated Pipe	6"	100'
PBC4250	Black Solid Corrugated Pipe	4"	250'



ELBOW



END CAP



TEE



INTERNAL COUPLING

Black Corrugated Pipe Fittings

Part#	Description	Pipe Size
PBC*EC	Black Corrugated Snap End Cap	3" • 4" • 6"
PBC**L	Black Corrugated Snap Elbow	3" • 4"
PBC4T	Black Corrugated Snap Tee	4"
PBC**IC	Black Corrugated Snap Internal Coupling	3" • 4" • 6"
PBC4Y	Black Corrugated Snap Wye	4"
PBC6X4RC	6" to 4" Black Corrugated Snap Reducing Coupling	6" to 4"
PBC233DA	2" x 3" x 3" Black Corrugated Snap Downspout Adapter	2" x 3" to 3"
PBC234DA	2" x 3" x 4" Black Corrugated Snap Downspout Adapter	2" x 3" to 4"
PBC344DA	3" x 4" x 4" Black Corrugated Snap Large Downspout Adapter	3" x 4" to 4"
Y0462AA	Black Corrugated Snap PVC Adapter	4"



PBC*Y



PBC²³³DA



PBC²³⁴DA



PBC³⁴⁴DA



Y⁰⁴⁶²AA

Gutters & Accessories





Half Round Gutter

Part#	Description	Size	Length
H510W	White H/R Gutter 10' - .027 Aluminum	5"	10'
H510B	Brown H/R Gutter 10' - .027 Aluminum	5"	10'
H510G	Galvanized H/R Gutter 10' - 26 Gauge Steel	5"	10'
H520W	White H/R Gutter 20' - .027 Aluminum	5"	20'
H520B	Brown H/R Gutter 20' - .027 Aluminum	5"	20'
H520G	Galvanized H/R Gutter 20' - 26 Gauge Steel	5"	20'
H610W	White H/R Gutter 10' - .027 Aluminum	6"	10'
H610B	Brown H/R Gutter 10' - .027 Aluminum	6"	10'
H610G	Galvanized H/R Gutter 10' - 26 Gauge Steel	6"	10'
H620W	White H/R Gutter 20' - .027 Aluminum	6"	20'
H620B	Brown H/R Gutter 20' - .027 Aluminum	6"	20'
H620G	Galvanized H/R Gutter 20' - 26 Gauge Steel	6"	20'



K-Style Gutter

Part#	Description	Size	Length
K5W	White K Gutter - .032 Aluminum (sold by the linear foot)	5"	LF
K5B	Brown K Gutter - .032 Aluminum (sold by the linear foot)	5"	LF
K610W	White K Gutter 10' - .032 Aluminum	6"	10'
K620W	White K Gutter 20' - .032 Aluminum	6"	20'



Round Corrugated Downspout

Part#	Description	Size	Length
H3DW	White R/C Downspout - .019 Aluminum	3"	10'
H3DB	Brown R/C Downspout - .019 Aluminum	3"	10'
H3DG	Galvanized R/C Downspout - 26 Gauge	3"	10'
H4DW	White R/C Downspout - .024 Aluminum	4"	10'
H4DB	Brown R/C Downspout - .024 Aluminum	4"	10'
H4DG	Galvanized R/C Downspout - 26 Gauge	4"	10'



Rectangle Corrugated Downspout

Part#	Description	Size	Length
K23DW	White 2x3 Downspout - .019 Aluminum	2" x 3"	10'
K23DB	Brown 2x3 Downspout - .019 Aluminum	2" x 3"	10'
K34DW	White 3x4 Downspout - .024 Aluminum	3" x 4"	10'
K34DB	Brown 3x4 Downspout - .024 Aluminum	3" x 4"	10'
K45DW	White 4x5 Downspout - .024 Aluminum	4" x 5"	10'





Round Corrugated Elbow

Part#	Description	Size
H3EBW	White R/C Elbow - .019 Aluminum	3"
H3EBB	Brown R/C Elbow - .019 Aluminum	3"
H3EBG	Galvanized R/C Elbow - 26 Gauge	3"
H4EBW	White R/C Elbow - .024 Aluminum	4"
H4EBB	Brown R/C Elbow - .024 Aluminum	4"
H4EBG	Galvanized R/C Elbow - 26 Gauge	4"



A-STYLE



B-STYLE

Rectangle Corrugated Elbow

Part#	Description	Style	Size
K23AW	White A Elbow - .016 Aluminum	A	2" x 3"
K23AB	Brown A Elbow - .016 Aluminum	A	2" x 3"
K23BW	White B Elbow - .016 Aluminum	B	2" x 3"
K23BB	Brown B Elbow - .016 Aluminum	B	2" x 3"
K34AW	White A Elbow - .019 Aluminum	A	3" x 4"
K34AB	Brown A Elbow - .019 Aluminum	A	3" x 4"
K34BW	White B Elbow - .019 Aluminum	B	3" x 4"
K34BB	Brown B Elbow - .019 Aluminum	B	3" x 4"
K45AW	White A Elbow - .024 Aluminum	A	4" x 5"
K45BW	White B Elbow - .024 Aluminum	B	4" x 5"

A Style Square Corrugated Elbow Offset



Part#	Description	Style	Size
K23A0B2	2" x 3" Brown A Elbow Offset 2"	A	2" x 3"
K23A0B3	2" x 3" Brown A Elbow Offset 3"	A	2" x 3"
K23A0W2	2" x 3" White A Elbow Offset 2"	A	2" x 3"
K23A0W3	2" x 3" White A Elbow Offset 3"	A	2" x 3"
K34A0B2	3" x 4" Brown A Elbow Offset 2"	A	3" x 4"
K34A0B3	3" x 4" Brown A Elbow Offset 3"	A	3" x 4"
K34A0W2	3" x 4" White A Elbow Offset 2"	A	3" x 4"
K34A0W3	3" x 4" White A Elbow Offset 3"	A	3" x 4"





#10 Combination Hanger Circle & Shank for Half Round Gutter

Part#	Description	Size
H5CHWS	White H/R #10 Combination Hanger - Steel	5"
H5CHW	White H/R #10 Combination Hanger - Aluminum	5"
H5CHB	Brown H/R #10 Combination Hanger - Aluminum	5"
H5CHG	Galvanized H/R #10 Combination Hanger - Galvanized Steel	5"
H6CHWS	White H/R #10 Combination Hanger - Steel	6"
H6CHW	White H/R #10 Combination Hanger - Aluminum	6"
H6CHB	Brown H/R #10 Combination Hanger - Aluminum	6"
H6CHG	Galvanized H/R #10 Combination Hanger - Galvanized Steel	6"



Gem Circle for Half Round Gutter

Part#	Description	Size
H5CWS	White H/R Circle - Steel	5"
H5CW	White H/R Circle - Aluminum	5"
H5CB	Brown H/R Circle - Aluminum	5"
H5CG	Galvanized H/R Circle - Steel	5"
H6CWS	White H/R Circle - Steel	6"
H6CW	White H/R Circle - Aluminum	6"
H6CB	Brown H/R Circle - Aluminum	6"
H6CG	Galvanized H/R Circle - Steel	6"



Hidden Hanger for K-Gutter with 1/4" Screw

Part#	Description	Size
K5H	Aluminum Hidden Hangers w/ Screw	5"
K6H	Aluminum Hidden Hangers w/ Screw	6"

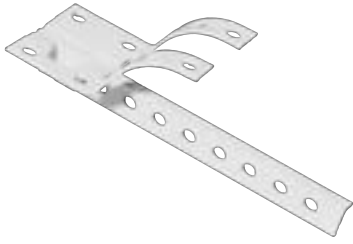

#6 Shank - Steel

Part#	Description
H6SW	White #6 Shank - Steel
H6SB	Brown #6 Shank - Steel
H6SG	Galvanized #6 Shank - Steel



#8 Shank

Part#	Description
H8G	Galvanized #8 Shank



#10 Shank for Fascia

Part#	Description
H10W	White #10 Shank - Painted Galvanized Steel
H10B	Brown #10 Shank - Painted Galvanized Steel
H10G	Galvanized #10 Shank - Steel



#11 Shank for Nailing to Exposed Rafter

Part#	Description
H11W	White #11 Shank - Aluminum
H11B	Brown #11 Shank - Aluminum
H11G	Galvanized #11 Shank - Steel



#12 Shank for Nailing to Sheeting - 1/3 Pitch

Part#	Description
H12W	White #12 Shank - Painted Galvanized Steel
H12B	Brown #12 Shank - Painted Galvanized Steel
H12G	Galvanized #12 Shank - Steel





#30 Shank for Adjustable Pitch Rafters & Fascia

Part#	Description
H30W	White #30 Shank - Aluminum
H30B	Brown #30 Shank - Aluminum
H30G	Galvanized #30 Shank - Steel



Extension Shank

Part#	Description	Size
HESW	White Extension Shank - Aluminum	6-3/4"
HESB	Brown Extension Shank - Aluminum	6-3/4"
HESG	Galvanized Extension Shank - Steel	6-3/4"



End Cap for Half Round Gutter

Part#	Description	Size
H5ECW	White H/R End Cap - Aluminum	5"
H5ECB	Brown H/R End Cap - Aluminum	5"
H5ECG	Galvanized H/R End Cap - Steel	5"
H6ECW	White H/R End Cap - Aluminum	6"
H6ECB	Brown H/R End Cap - Aluminum	6"
H6ECG	Galvanized H/R End Cap - Steel	6"



End Cap for K-Gutter

Part#	Description	Size
K5ECWL	White K-style Left End Cap - Aluminum	5"
K5ECWR	White K-style Right End Cap - Aluminum	5"
K5ECBL	Brown K-style Left End Cap - Aluminum	5"
K5ECBR	Brown K-style Right End Cap - Aluminum	5"
K6ELW	White K-style Left End Cap - Aluminum	6"
K6ERW	White K-style Right End Cap - Aluminum	6"
K6ECB	Brown K-style End Cap - Aluminum	6"





Inside Miter for Half Round Gutter

Part#	Description	Size
H5MISW	White Inside H/R Miter - Aluminum	5"
H5MISB	Brown Inside H/R Miter - Aluminum	5"
H5MISG	Galvanized Inside H/R Miter - 26 Gauge	5"
H6MISW	White Inside H/R Miter - Aluminum	6"
H6MISB	Brown Inside H/R Miter - Aluminum	6"
H6MISG	Galvanized Inside H/R Miter - 26 Gauge	6"



Outside Miter for Half Round Gutter

Part#	Description	Size
H5MOSW	White Outside H/R Miter - Aluminum	5"
H5MOSB	Brown Outside H/R Miter - Aluminum	5"
H5MOSG	Galvanized Outside H/R Miter - 26 Gauge	5"
H6MOSW	White Outside H/R Miter - Aluminum	6"
H6MOSB	Brown Outside H/R Miter - Aluminum	6"
H6MOSG	Galvanized Outside H/R Miter - 26 Gauge	6"



Inside Miter for K-Gutter

Part#	Description	Size
K5MISW	White Inside K-style Miter - Aluminum	5"
K5MISB	Brown Inside K-style Miter - Aluminum	5"
K6MISW	White Inside K-style Miter - Aluminum	6"
K6MISB	Brown Inside K-style Miter - Aluminum	6"



Outside Miter for K-Gutter

Part#	Description	Size
K5MOSW	White Outside K-style Miter - Aluminum	5"
K5MOSB	Brown Outside K-style Miter - Aluminum	5"
K6MOSW	White Outside K-style Miter - Aluminum	6"
K6MOSB	Brown Outside K-style Miter - Aluminum	6"



Cut Off Diverter for K-Gutter

Part#	Description	Size
K23CW	White Cut Off Diverter - Aluminum	2" x 3"
K34CW	White Cut Off Diverter - Aluminum	3" x 4"





Slip Joint for Half Round Gutter

Part#	Description	Size
H5SJW	White H/R Slip Joint - Aluminum	5"
H5SJB	Brown H/R Slip Joint - Aluminum	5"
H5SJG	Galvanized H/R Slip Joint - 26 Gauge	5"
H6SJW	White H/R Slip Joint - Aluminum	6"
H6SJB	Brown H/R Slip Joint - Aluminum	6"
H6SJG	Galvanized H/R Slip Joint- 26 Gauge	6"

Slip Joint for K-Gutter

Part#	Description	Size
K5SJW	White K-style Slip Joint - Aluminum	5"
K5SJB	Brown K-style Slip Joint - Aluminum	5"

End Piece for Half Round Gutter

Part#	Description	Size
H30EW	White H/R End Piece - Aluminum	5" x 3"
H30EB	Brown H/R End Piece - Aluminum	5" x 3"
H30EG	Galvanized H/R End Piece - Steel	5" x 3"
H40EG	Galvanized H/R End Piece - Steel	6" x 4"

End Piece for K-Gutter

Part#	Description	Size
K230EW	White K-style End Piece - Aluminum	5" x 3"
K230EB	Brown K-style End Piece - Aluminum	5" x 3"

Oval Funnel

Part#	Description	Size
H3FW	White Oval Funnel - Aluminum	3"
H3FB	Brown Oval Funnel - Aluminum	3"
H3FG	Galvanized Oval Funnel - Steel	3"
H4FW	White Oval Funnel - Aluminum	4"
H4FB	Brown Oval Funnel - Aluminum	4"
H4FG	Galvanized Oval Funnel- Steel	4"



Wide Flange Pop Rivet Oval Outlet for 5" K-Gutter

Part#	Description	Size
K230T	K-style WF Oval Outlet - Aluminum	2" x 3"



Wide Flange Pop Rivet Oval Outlet for 5" or 6" K-Gutter

Part#	Description	Size
K340T	K-Style WF Oval Outlet - Aluminum	3" x 4"



H30TG

H40TG

Wide Flange Round Outlet for Half Round Gutter

Part#	Description	Size
H30TG	Galvanized - H/R WF Round Outlet - Steel	3"
H40TG	Galvanized - H/R WF Round Outlet - Steel	4"



Wide Flange B-style Outlet for Half Round Gutter

Part#	Description	Size
H30TW	White H/R WF B-style Outlet - Aluminum	3"
H30TB	Brown H/R WF B-style Outlet - Aluminum	3"
H40TW	White H/R WF B-style Outlet - Aluminum	4"
H40TB	Brown H/R WF B-style Outlet - Aluminum	4"





Stamped Round Sickle Hook for Wood

Part#	Description	Size
HSH3W	White H/R Sickle Hook - Painted Galvanized Steel	3"
HSH3G	Galvanized H/R Sickle Hook - Steel	3"
HSH4W	White H/R Sickle Hook - Painted Galvanized Steel	4"
HSH4B	Brown H/R Sickle Hook - Painted Galvanized Steel	4"
HSH4G	Galvanized H/R Sickle Hook - Steel	4"



Rack & Key

Part#	Description
HRKW	White Rack and Key - Aluminum
HRKB	Brown Rack and Key - Aluminum
HRKG	Galvanized Rack and Key - Steel
HKEY	Key Only - Aluminum



#0

#4

Masonry & Wood Drives

Part#	Description
HD0	Galvanized #0 Masonry Drive - Steel
HD4	Galvanized #4 Wood Drive - Steel



#6 Drive

Part#	Description
HD6W	White #6 Drive - Aluminum
HD6B	Brown #6 Drive - Aluminum
HD6G	Galvanized #6 Drive - Steel



Pipe Clip

Part#	Description	Size
KPC3W	White Pipe Clip - Aluminum	2" x 3"
KPC3B	Brown Pipe Clip - Aluminum	2" x 3"
KPC4W	White Pipe Clip - Aluminum	3" x 4"
KPC4B	Brown Pipe Clip - Aluminum	3" x 4"



Wire Strainers

Part#	Description	Size
H3WS	Wire Strainer - Aluminum	3"
H4WS	Wire Strainer - Aluminum	4"

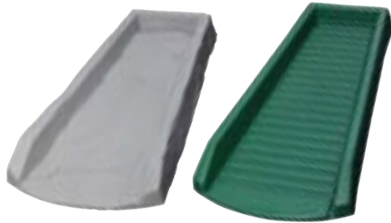

Y3004-12

Y3002-12

PVC Splash Blocks

Part#	Description	Size
Y3004-12	Slate Gray Splash Block - PVC	12" x 24"
Y3002-12	Green Splash Block - PVC	12" x 24"

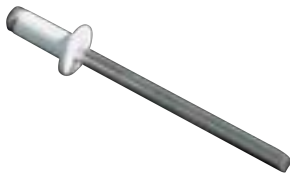

Aluminum Pop Rivets

Part#	Description	Size	Pack Qt.
KPRW	White Pop Rivets - Aluminum	1-1/2"	100
KPRB	Brown Pop Rivets - Aluminum	1-1/2"	100



5 oz. Pliogrip Seam Sealer Tube

Part#	Description	Size
PG	Pliogrip Seam Sealer Tube	5 Oz



Spring Clip

Part#	Description
HWCW	White Spring Clips - Aluminum
HWCB	Brown Spring Clips - Aluminum
HWCG	Galvanized Spring Clips - Steel



Nuts & Bolts

Part#	Description
HNB	Stainless Nuts and Bolts 50 pack - Steel



Universal Conductor Band

• 2 Bands Recommended every 10' of downspout

Part#	Description	Size
KUBW	White Universal Conductor Band - Aluminum	1.5" x 12.5"
KUBB	Brown Universal Conductor Band - Aluminum	1.5" x 12.5"
KUBG	Galvanized Universal Conductor Band - Steel	1.5" x 12.5"



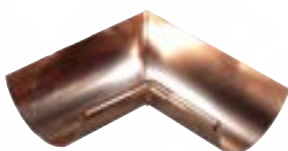

INSIDE MITER

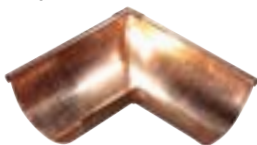

OUTSIDE MITER



Copper Half Round Gutter

Part#	Description	Size	Length
HC510	Copper H/R Gutter 10' - 16 Oz	5"	10'
HC520	Copper H/R Gutter 20' - 16 Oz	5"	20'
HC610	Copper H/R Gutter 10' - 16 Oz	6"	10'
HC620	Copper H/R Gutter 20' - 16 Oz	6"	20'

Copper Slip Joint for Half Round Gutter

Part#	Description	Size
HC5SJ	Copper H/R Slip Joint - 16 Oz	5"
HC6SJ	Copper H/R Slip Joint - 16 Oz	6"

Copper End Caps for Half Round Gutter

Part#	Description	Size
HC5EC	Copper H/R End Caps - 16 Oz	5"
HC6EC	Copper H/R End Caps - 16 Oz	6"

Copper Miters for Half Round Gutter

Part#	Description	Size
HC5MIS	Copper H/R Inside Miter - 16 Oz	5"
HC6MIS	Copper H/R Inside Miter - 16 Oz	6"
HC5MOS	Copper H/R Outside Miter - 16 Oz	5"
HC6MOS	Copper H/R Outside Miter - 16 Oz	6"

Copper Round Wire Strainer

Part#	Description	Size
HC3WS	Copper Wire Strainer	3"
HC4WS	Copper Wire Strainer	4"





ROUND CORRUGATED



SMOOTH ROUND



ROUND CORRUGATED



SMOOTH ROUND

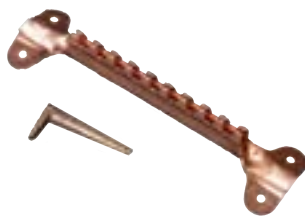

Copper Downspout

Part#	Description	Size
HC3DS	Copper Round Corrugated Downspout 10' - 16 Oz	3" x 10'
HC3DSS	Copper Smooth Round Downspout 10' - 16 Oz	3" x 10'

Copper Elbows

Part#	Description	Size
HC3EB	Copper Round Corrugated Elbow - 16 Oz	3"
HC3EBS	Copper Smooth Round Elbow - 16 Oz	3"
HC4EB	Copper Round Corrugated Elbow - 16 Oz	4"
HC4EBS	Copper Smooth Round Elbow - 16 Oz	4"

Copper Funnel

Part#	Description	Size
HC3F	Copper Funnel - 16 Oz	3"

Copper Round B-Style Outlet

Part#	Description	Size
HC30T	Copper B-Style Outlet for 5" H/R Gutter - 16 Oz	3"
HC40T	Copper B-Style Outlet for 5" & 6" H/R Gutter - 16 Oz	4"

Copper Rack & Brass Key

Part#	Description
HCRK	Copper Rack and Key
HCKEY	Brass Key Only





Copper #10 Combination Hanger - Circle & Shank

Part#	Description	Size
HC5CH	Copper H/R #10 Combination Hanger	5"
HC6CH	Copper H/R #10 Combination Hanger	6"



Copper Gem Circle

Part#	Description	Size
HC5C	Copper H/R Circle	5"
HC6C	Copper H/R Circle	6"



#6 Copper Shank for Ogee or Crown Molding

Part#	Description
HC6S	Copper #6 Shank



#10 Copper Shank for Fascia

Part#	Description
HC10S	Copper #10 Shank



#11 Copper Shank for Nailing to Exposed Rafter

Part#	Description
HC11S	Copper #11 Shank



#12 Copper Shank for Nailing to Sheeting 1/3 Pitch

Part#	Description
HC12S	Copper #12 Shank



#30 Copper Shank for Adjustable Pitch Rafters and Fascia

Part#	Description
HC30S	Copper #30 Shank



Copper Shank Extension

Part#	Description
HCES	Copper Shank Extension



#0



#4

Copper Masonry & Wood Drives

Part#	Description
HC0D	Bronze #0 Masonry Drive
HC4D	Copper #4 Wood Drive



Copper #6 Drive

Part#	Description
HC6D	Copper #6 Drive





Brass Spring Clip for Half Round Gutter

Part#	Description
HCWC	Brass H/R Spring Clip



Brass Nuts & Bolts

Part#	Description
HCNB50	Brass Nuts and Bolts - 50 pack

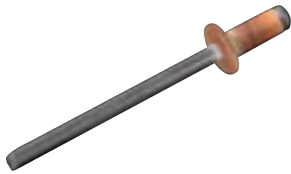

Copper Pop Rivets

Part#	Description	Size
HCPR	Copper Pop Rivets	1-1/2"



Hinged Gutter Guard for Half Round Gutter

Part#	Description	Size	Length
H5GG	Hinged H/R Gutter Guard 3' - Aluminum	5"	3'
H6GG	Hinged H/R Gutter Guard 3' - Aluminum	6"	3'
HC5GG	Copper H/R Hinged Gutter Guard 3'	5"	3'
HC6GG	Copper H/R Hinged Gutter Guard 3'	6"	3'



RayTec Gutter Guard for K-Gutter

Part#	Description	Size	Length
K5GG	RayTec K-style Gutter Guard 4' - Aluminum	5"	4'
K5GG10	RayTec K-style Gutter Guard 10' - Aluminum	5"	10'
K6GG	RayTec K-style Gutter Guard 4' - Aluminum	6"	4'



Leaf Relief Gutter Guard

Part#	Description	Size	Length
K5GGLR	Leaf Relief K-style Gutter Guard 10' - Aluminum	5"	10'
K6GGLR	Leaf Relief K-style Gutter Guard 10' - Aluminum	6"	10'



Half Round Gutter Exploded View

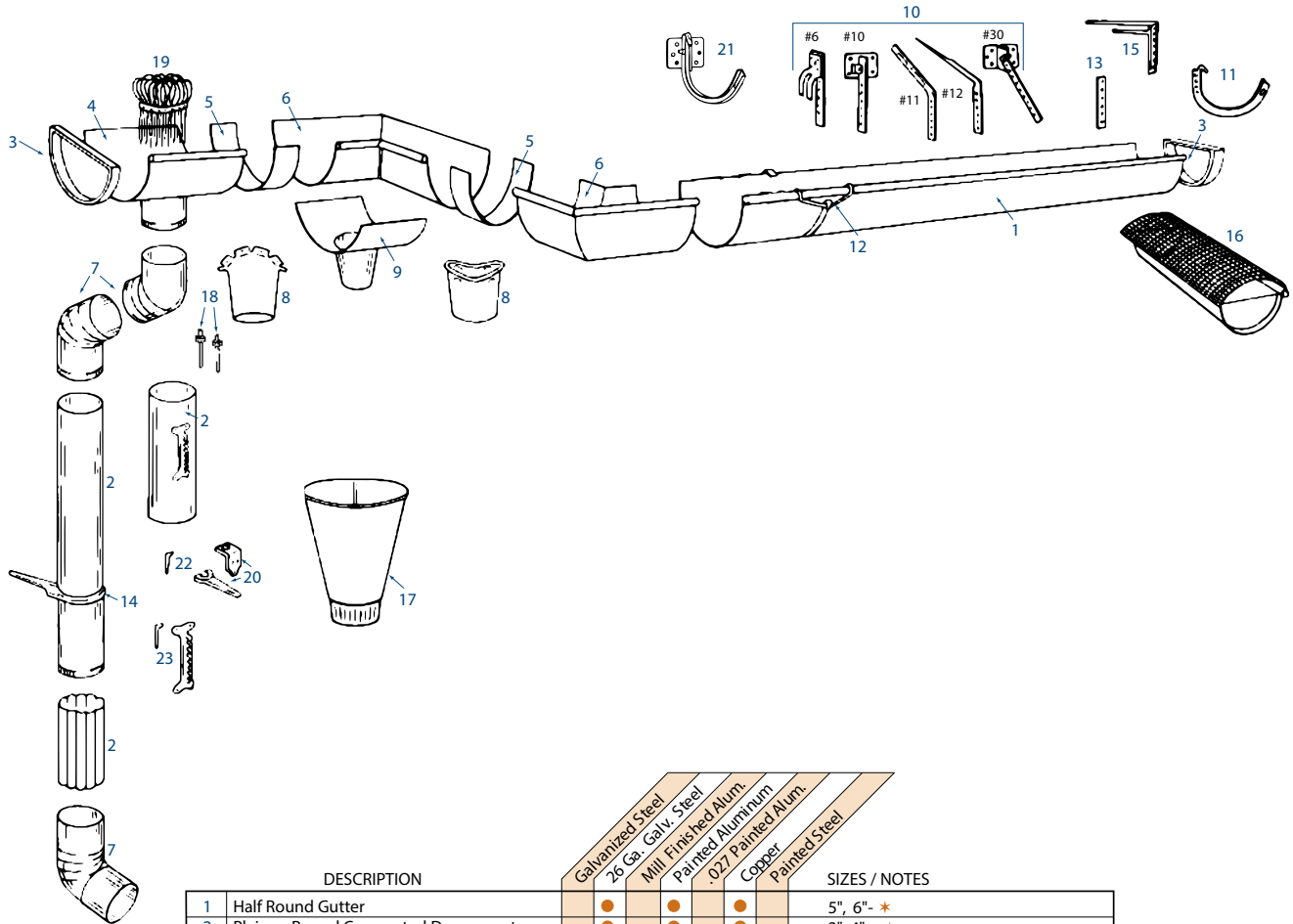

DESCRIPTION	Galvanized Steel	Mill Finished Steel	Painted Aluminum	Copper	Painted Steel	SIZES / NOTES
	26 Ga.	26 Ga.	.027			
1 Half Round Gutter	●	●	●	●	●	5", 6" - *
2 Plain or Round Corrugated Downspout	●	●	●	●	●	3", 4" - *
3 "C" End Caps	●	●	●	●	●	5", 6" - *
4 "D" End Section w/ Outlet	●	●	●	●	●	5"x3" - *
5 Slip Joint Connector	●	●	●	●	●	5", 6" - *
6 90 Degree Box Miter - Outside or Inside	●	●	●	●	●	5", 6" - *
7 Elbows - Plain Round or Round Corrugated	●	●	●	●	●	3", 4" - *
8 "B" Outlet Tube	●	●	●	●	●	3", 4" - *
9 Wide Flange Round "B" Outlet	●	●	●	●	●	3", 4"
10 Stamped Shanks	●	●	●	●	●	See Shank Notes
11 Stamped Circle	●	●	●	●	●	5", 6" - *
12 Wire Spring Clips	●	●	●	●	●	
13 Stamped Extension Shank	●	●	●	●	●	
14 Stamped Plain Round Sickle Hook	●	●	●	●	●	3", 4" Plain Round
15 #8 Malleable Shank	●	●	●	●	●	
16 Hinged Gutter Guard	●	●	●	●	●	5", 6"
17 Funnel	●	●	●	●	●	3", 4" Round Outlets
18 Pop Rivets	●	●	●	●	●	
19 Round Wire Strainer	●	●	●	●	●	3", 4"
20 Stamped Drives #0, #4, #6	●	●	●	●	●	#0 Masonry / #4, #6 Wood
21 #10 Combination Circle and Plate	●	●	●	●	●	5", 6"
22 Key Only	●	●	●	●	●	
23 Rack & Key Set	●	●	●	●	●	

Shank Notes: #1 - for fascia, #6 - for ogee or crown moulding, fits contour, #10 - for fascia, #11 - for nailing to rafter, #12 - for nailing to sheeting, #30 - adjustable pitch for angled end rafters and fascia * Note: Not all sizes are necessarily stocked in the colors and materials shown.



K-Gutter Exploded View

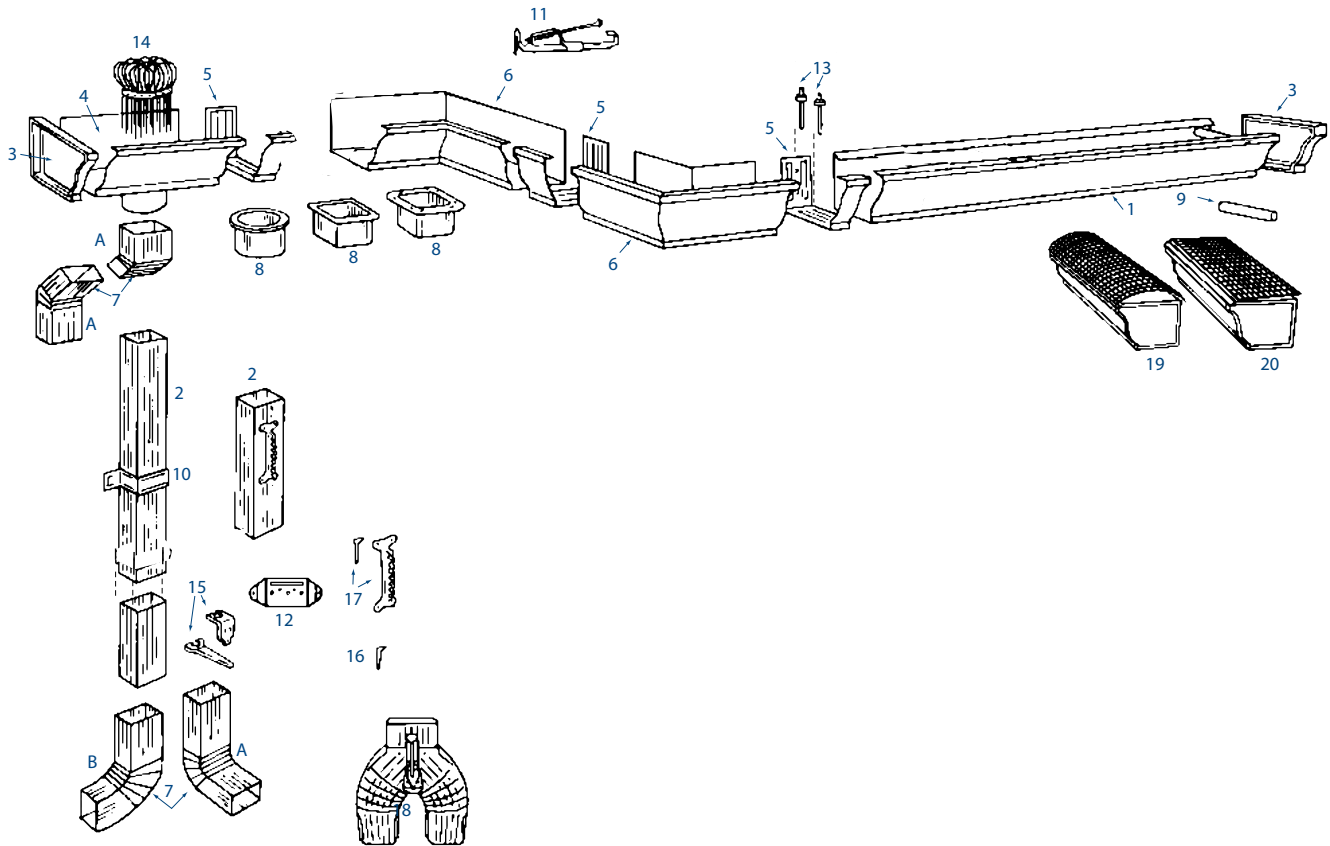

DESCRIPTION	MATERIALS				SIZES / NOTES
	Galvanized Steel	Mill Finished Alum.	Painted Aluminum	Copper	
1 K-Style Gutter					5", 6"
2 Square Corrugated Downspout					2"x3", 3"x4", 4"x5" - *
3 End Caps - Left or Right					5", 6" - *
4 End Section w/ Outlet					5"x3"
5 Slip Joint Connector					5" - *
6 90 Degree Box Miter - Outside or Inside					5", 6" - *
7 Elbows - A & B Style - Sq. Corr. & Plain Sq.					2"x3", 3"x4", 4"x5" - *
8 Outlet Tube - Oval, Square					2"x3", 3"x4" - *
9 Ferrule					5", 6" - *
10 Universal Band (may vary in appearance)					
11 Hidden Hanger w/ Screw					5", 6"
12 Conductor Bracket Downspout Hanger					2"x3", 3"x4"
13 Pop Rivets					A-42, A-44
14 Round Wire Strainer					3", 4"
15 Stamped Drives #0, #4, #6					#0 Masonry / #4, #6 Wood
16 Key Only					
17 Rack & Key Set					
18 Square Corrugated Cutoff w/ Diverter					2"x3", 3"x4"
19 Hinged Gutter Guard					5", 6"
20 Drop-In Gutter Guard					5", 6"

* Note: Not all sizes are necessarily stocked in the colors and materials shown.



Snow Retention Systems

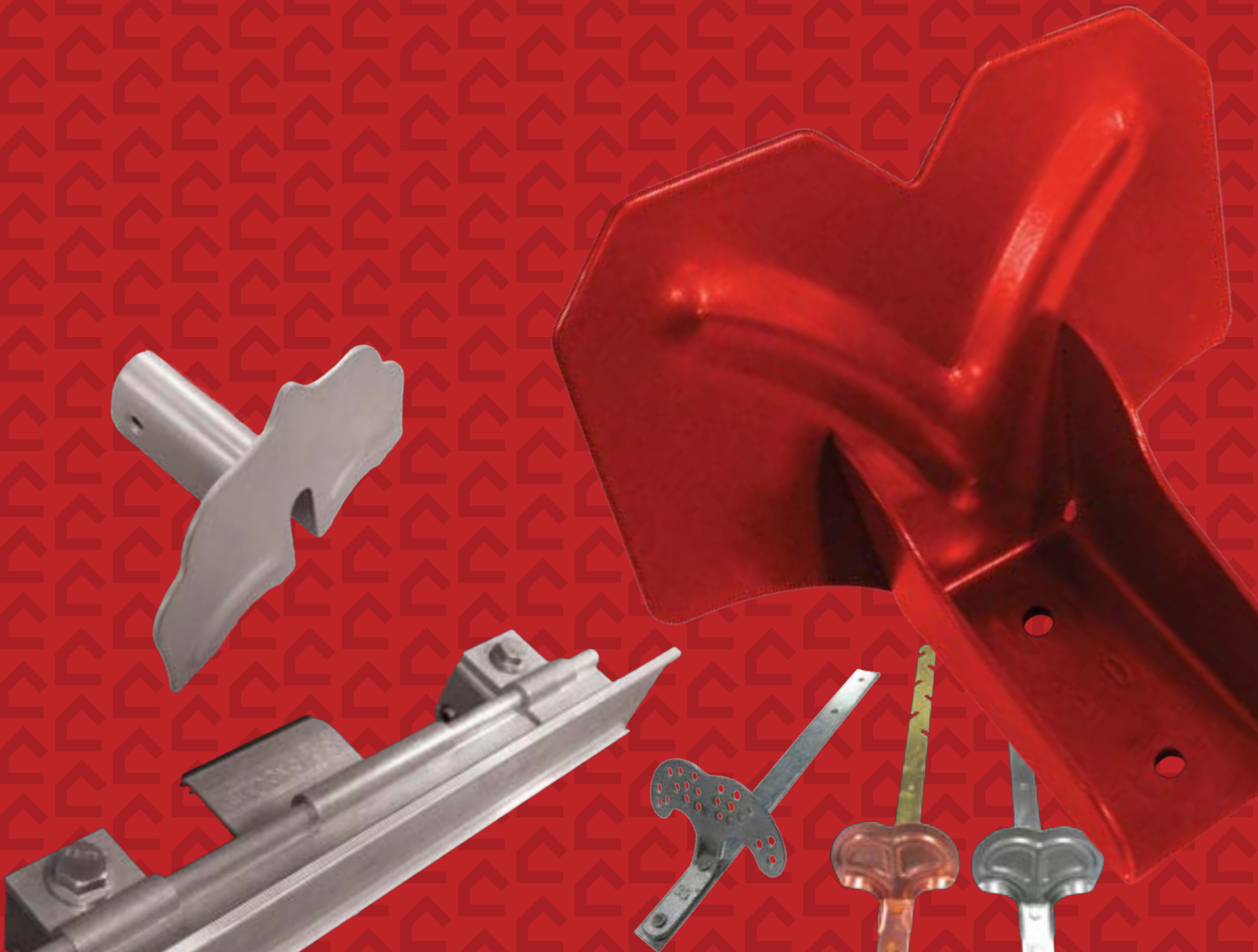



Berger #2 Snow Guard

- Made from Malleable Iron
- Comes with long shank for slate roofs

Part#	Description
SNGG	Berger #2 Snow Guard Assembly w/ Long Shank for Slate Roofs



Berger AP-400 Snow Guard

- Designed for standing seam panels with ribs up to 3/8" wide and 2" high
- Non-penetrating setscrews that do not restrict thermal movement

Part#	Description
SNGAP400	Berger AP-400 Snow Guard - Mill Finish Cast Aluminum



Berger RT-300 Snow Guard

- Designed for standing seam panels with ribs up to 1" high
- Non-penetrating setscrews that do not restrict thermal movement

Part#	Description
SNGRT300M	Berger RT300 Snow Guard - Mill Finish Cast Aluminum

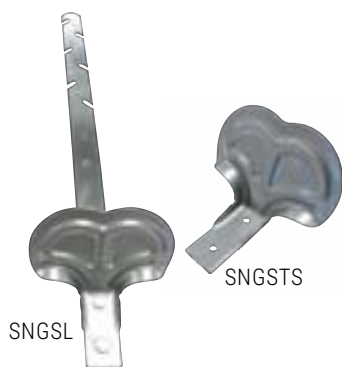

Berger #100 Snow Guard

- Comes with long shank for slate and shingled roofs or without the shank for metal roofs
- Can be installed without removing shingles

Part#	Description
SNGSL	Berger #100 Snow Guard Assembled w/ Long Shank - Stainless Steel
SNGSTS	Berger #100 Snow Guard Shoe for Metal Roof - Stainless Steel



Superbond High Strength Adhesive for Plastic Snow Guards

- 2000 psi sheer tensile strength after 25 days of 50° F or warmer temperature cure time

Part#	Description
SNGGE	Surebond Everseal High Strength Adhesive for Snow Guards





Snow Defender™ 4500 Snow Guard

- Designed for exposed fastener panels like the ABM Panel
- Must be screwed into 2x4 purlins in the flat position
- Made with 16 Gauge type 304 stainless steel that will never rust
- EPDM rubber sealer saves time because no caulk is needed
- Powder coated for a long-lasting colored finish
- Online calculator at www.snowdefendercalculator.com

Part#	Description	Size
SNGSSRcc	Snow Defender 4500 - Stainless Steel with Rubber Seal	4" x 3" x 3"



Snow Defender™ 6500 Snow Guard

- Designed for standing seam panels like the ABSeam Panel
- Fits ribs up to $\frac{3}{8}$ " wide and 1" to 1- $\frac{3}{4}$ " high
- Made with type 304 stainless steel that will never rust
- It pinches, but does not penetrate the metal panel
- Powder coated for a long-lasting colored finish
- Online calculator at www.snowdefendercalculator.com

Part#	Description	Size
SNGSDcc	Snow Defender 6500 - Stainless Steel with Setscrews	5.5" x 3" x 3.5"



Snow Defender™ 7500 DECO Snow Guard Special Order

Introducing the SnowDefender 7500 DECO. Based on the design of the popular SnowDefender 6500, this color matched, 304 Stainless Steel model has the more traditional, historic look of a cast snow guard. The decorative cutouts are embossed for increased strength and the proven attachment method using set screws mean the SnowDefender 7500 Deco will last the life of your roof.

Part#	Description	Size
SNGSDSODECO	Special Order Snow Defender 7500 DECO with Setscrews	5.5" x 3.25" x 3.5"



Snow Defender™ Plastic Snow Guards

- Polycarbonate Lexan 103-112 ($\frac{3}{16}$ " thick)
- UV stable and very strong
- Mount with screws or adhesive
- Attach with Surebond High Strength Adhesive
- Online calculator at www.snowdefendercalculator.com

Part#	Description	Size
SNGBUSTER	Snow Defender Buster - Clear Polycarbonate Snow Guard	5" x 3" x 3"
SNGPC240	Snow Defender PC240 - Clear Polycarbonate Snow Guard	3" x 2.5" x 4.125"



S-5!® ColorGard 2.0®

FEATURES AND BENEFITS

- **No in-field cutting:** with the new internal splice, the VersaClip™ can be installed directly over all splices, eliminating the need for in-field cutting; ColorGard 2.0 crossmembers now require field cutting only at the end of the assembly.
- **Customizable and Versatile:** site-specific engineering allows for optimal performance on exposed-fastened and standing seam metal roof profiles.
- **Unparalleled Performance:** designed to last the life of the roof with corrosion-resistant materials; load-tested on 500+ roof profiles, ensuring safety and reliability.
- **Aesthetically Pleasing:** visually enhance the look of the roof with perfect color and finish-matching.
- Mechanically attached with S-5!® clamps for a snow retention system that is warranted for the life of your roof (see www.s-5.com for warranty info.)
- The S-5!® clamp base can be fastened with the patented round-point setscrews for non-penetrating attachment to standing seam roofs, or can be screwed into an exposed fastener roof
- Not compatible with the S-5! Mini Clamps
- Easily retrofitted to existing roofs or incorporated into new construction
- Easy to install with common tools of the trade
- Online calculator at www.S-5.com/calculator

Splice



Unpunched

S-5!® ColorGard 2.0® Crossmember

- Includes 1 splice collar
- Online calculator at www.S-5.com/calculator

Part#	Description	Length
SNGS5CG2.0	S-5 ColorGard 2.0 Aluminum Rail - Unpunched	7' 8"
SNGS5CG2.0-PUNCHED	S-5 ColorGard 2.0 Aluminum Rail - Punched Every 4" On Center	7' 8"

S-5!® VersaClip 2.0™

- VersaClip goes in place as ColorGard crossmember is installed. It no longer has to be preassembled to the crossmember

Part#	Description
SNGS5VC	S-5 ColorGard VersaClip 2.0

S-5!® SnoClip 2.0

- SnoClip can be added to retard the migration of snow and ice beneath the crossmembers. Simply insert it onto the ColorGard crossmember during or following installation and secure the fastener to engage the SnoClip foot onto the roof.
- The SnoClip II 2.0 can be used on panels with ribs up to 1-1/2" high
- The SnoClip III 2.0 can be used on panels with ribs up to 3" high
- Must be attached by sliding from end of rails before installation. Cannot be retrofitted.
- Online calculator at www.S-5.com/calculator

Part#	Description
SNGS5SC2	S-5 ColorGard 2.0 SnoClip II
SNGS5SC3	S-5 ColorGard 2.0 SnoClip III



ColorGard® Installation Instructions

⚠ ATTENTION INSTALLERS ⚠

PLEASE READ THESE INSTRUCTIONS ALL THE WAY THROUGH BEFORE BEGINNING WORK.
IT WILL SAVE TIME, MONEY AND PREVENT MISTAKES!

Components

Crossmember and Splice

Unpunched and punched crossmembers are available. Use the included splice to join two pieces of crossmember together, ensuring structural continuity. ColorGard 2.0 now accommodates a wider allowable span, up to 42-inch seam spacings.

SnoClip™ 2.0

SnoClip can be added to slow the migration of snow and ice beneath the crossmembers. Simply hinge it onto the ColorGard crossmember during or following installation and secure the fastener to engage the SnoClip foot onto the roof.

VersaClip™ 2.0

VersaClip is placed "on the fly" as the ColorGard crossmember is installed. (No preassembly)

ColorStrip™

Not included: The ColorStrip can be obtained in **2-inch (50.8 mm) wide strips** by the roofing material manufacturer to ensure a perfect color match and durability.

Note: It is recommended to have the ColorStrip **sheared**, not slit, during manufacturing to maintain clean edges and optimal performance. Use **tin snips** to trim the ColorStrip to the required length on-site as needed.



Scan QR Code

FOR INSTALL TIPS,
VIDEOS AND WARRANTY
INFORMATION.

Crossmember



Splice

SnoClip 2.0 II

SnoClip 2.0 III



VersaClip 2.0



ColorStrip

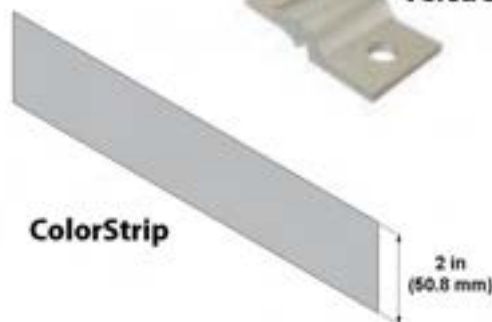

Tools Required:

- Screw Gun
- 13mm Socket for Impact or Ratchet [Box-End Hand Wrench Optional]
- Reciprocating Saw or Circular Saw with Non-Ferrous Blade [minimal use]
- String Line
- Calibrated Dial Indicating Torque Wrench
- Vice Grip Pliers

How to Install ColorGard:

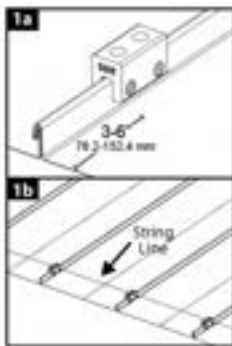

1 INSTALLING S-SI CLAMPS/BRACKETS

PRO TIP If desired, attach the VersaClip 2.0 to the VersaBracket on the ground, making sure to leave the nut and bolt loose so the crossmember can be snapped into place on the roof.

Step 1a: Preparing the Clamps/Brackets

- I. Review the **S-SI instructions** for your specific S-SI clamps or brackets. Read these instructions to the end before beginning work—it will save time and avoid mistakes.
- II. Attach a clamp/bracket within **3-6" (76.2-152.4 mm)** of the eave at both ends of the planned installation area.

Step 1b: Aligning Clamps/Brackets with a String Line

- I. Stretch a **tight string line** between the two end clamps/brackets.
 - Make sure the line is taut to avoid sagging or being affected by wind.
- II. Then install all clamps/brackets to line at their predetermined spacing.

Note for Longer Assemblies: For installations that span longer distances, additional intermittent clamps or brackets should be used at intervals to stabilize and anchor the string line securely in place.

2 INSTALLING THE COLORGARD CROSSMEMBER

Step 2a: Place the Crossmember

- I. Position the crossmember **downslope** of the installed S-SI clamps/brackets.

Step 2b: Attaching the Crossmember

For Unpunched Crossmembers:

- Place the **VersaClip** on the crossmember at each clamp/bracket location.
- Secure the crossmember using the provided **stainless steel M8 bolts** through the **upslope** clamp hole.
- Leave the bolts **loosely tightened** to allow for adjustments as the assembly progresses.

For Punched Crossmembers:

- Secure it using an **M8 bolt** through the **downslope** clamp hole (no VersaClip required).
- Leave the bolts **loosely tightened** to allow for adjustments as the assembly progresses.

Step 2c: Tightening the Bolts

Note: If installing ColorStrip, please read Step 3 before tightening the bolts.

- I. Once the entire assembly is aligned and adjustments are complete, tighten all bolts progressively to achieve or exceed the specified torque: **160 inch-pounds (18 Nm)** for unpunched/punched crossmembers

Step 2d: Connecting Crossmembers with Splices

- I. Insert a **splice piece** at each joint between crossmembers to maintain structural integrity.
 - If trimming the crossmember at the end of assembly, ensure the crossmember does not cantilever more than **8" beyond the last clamp/bracket**.
 - Secure trimmed sections with **at least two** clamps/brackets.

Note: For unpunched crossmembers at splices, the VersaClip can be placed directly at the clamp/bracket location if needed.

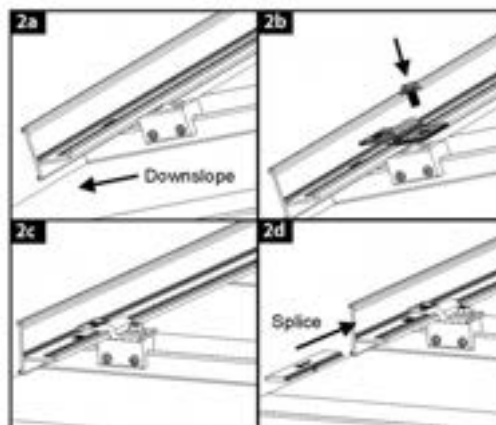

3 INSTALLING THE COLORSTRIP

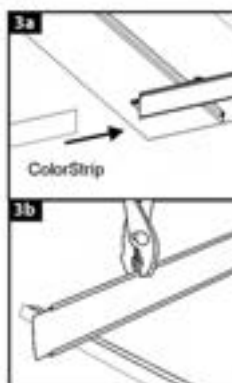

Step 3a: Insert the ColorStrip

- I. As you assemble the system, slide the **ColorStrip** into the crossmembers while the bolts remain loose to allow for smooth insertion of the strip
- II. Stagger the joints of the ColorStrip from the crossmember joints to conceal connections.
- III. Overlap adjacent ColorStrips by **.5 inch (13 mm)**

Step 3b: Secure the ColorStrip

- I. Use **vice grip pliers** to pinch the retainer lip of the crossmember at various points along its length. This prevents the ColorStrip from shifting laterally during or after installation.

4 INSTALLING THE SNOCLIP

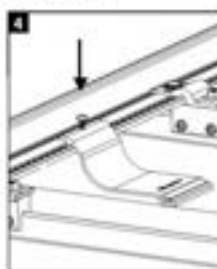

I. Position the SnoClip

- For one SnoClip per panel, center it on the crossmember between two clamps/brackets.
- For two or more SnoClips per panel, space them evenly between the clamps/brackets to ensure uniform support.

II. Attach the SnoClip

- Hinge the SnoClip directly onto the crossmember.
- Ensure the rubber foot engages the surface of the panel for proper functionality.

III. Secure the SnoClip

Drive the included fastener through the prepunched hole in the SnoClip into the crossmember channel using the T30 from clamp installation. Tighten the screw to approximately 50 inch-pounds (5-6 Nm) to secure the SnoClip firmly. (If the screw head shears during installation do not be alarmed as it will not inhibit proper function)

SnoClip 2.0 II
Designed for Seam Heights of 1" - 2"

SnoClip 2.0 III
Designed for Seam Heights of 2" - 3 1/4"

Important Notice! When installing any S-SI snow retention assembly with SnoClip, be sure that the toe of the SnoClip part bears on an area of the roof panel that is well supported and not subject to excessive deflection. Should panel deflection be excessive under load allowing the SnoClip to rotate under the ColorGard, then SnoClips should not be used.

Note: Any S-SI warranty and/or calculation may be void if hardware is used that was not furnished by S-SI directly or through one of their licensed distributors or any assembly that has not been tested by S-SI. These instructions are for use by those experienced in the trade. Always follow appropriate safety precautions and use appropriate tools.

S-SI® Warning! Please use product responsibly!

S-SI® Warning! Please use this product responsibly! Products are protected by multiple U.S. and foreign patents. For published data regarding holding strength, fastener torque, patents and trademarks, visit the S-SI website at www.s-si.com. Copyright 2025, Metal Roof Innovations, Ltd. S-SI products are patent protected. S-SI aggressively protects its patents, trademarks and copyrights. 062025



S-5!® Clamps

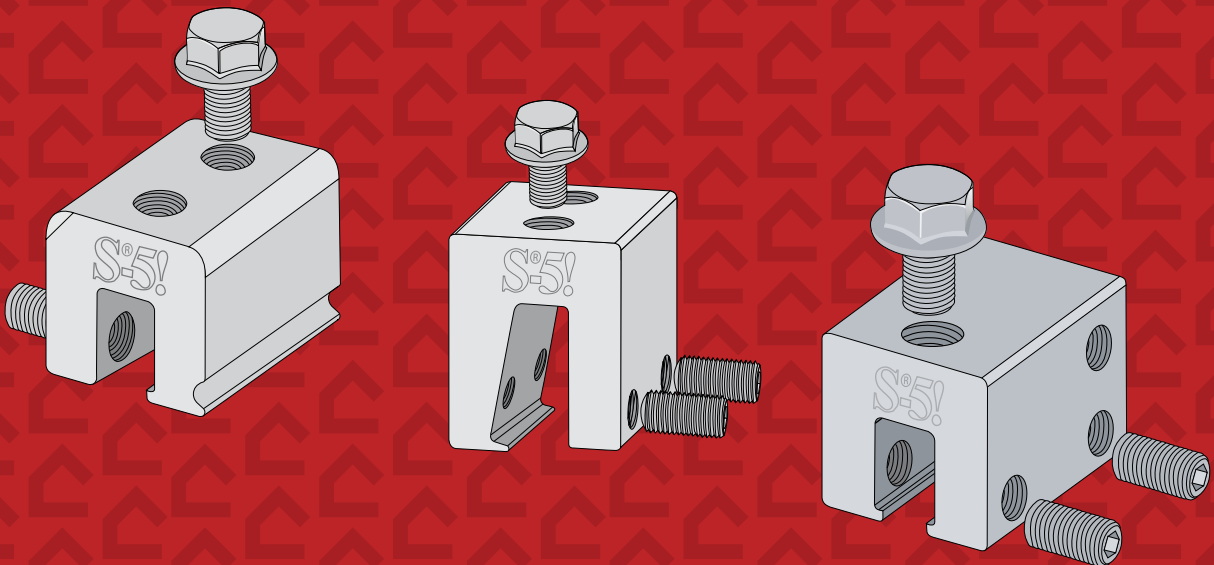



COMPONENTS SOLD SEPARATELY



S-5!® GripperFix Strut - Special Order

Long-term metal roofs deserve long-term, durable attachment methods. GRIPPERFIX is a perfect fix for installing HVAC, satellite dishes, light fixtures, conduit, service walkways, solar PV power electronics and other rooftop utilities. GRIPPERFIX offers a zero-penetration attachment solution for standing seam and other concealed-fastened roofs. GRIPPERFIX securely attaches to exposed-fastened roofs too, while still allowing free drainage beneath the system.

Part#	Description	Length
SNGS5GRIP27	S-5 27" GripperFix Strut	27"
SNGS5GRIP52	S-5 52" GripperFix Strut	52"
SNGS5CFTAB	S-5 CF Tab	
SNGS5EFTAB	S-5 EF Tab with 2 fasteners	
SNGS5DAMPER	S-5 Damper Pad	
SNGS5sB8x20	S-5 8MM X 20MM Stainless Flange Bolt	20 MM
SNGS5SB8	S-5 8MM X 16MM Stainless Flange Bolt	16 MM
Sngs5FNSS	S-5 8 MM Stainless Steel Flange Nut	

S-5-PV Kit 2.0 - Special Order

The PV Kit 2.0 is compatible with most common metal roofing materials, including copper. The Module Placement Bevel Guide makes the module placement easier. The mounting disk is multi-directional and rails are not required. The PV grab ears, holding the solar panels in place, are broader to allow for ease of installation and precise module engagement. Accommodating module thicknesses between 30 and 46mm, the PV Kit 2.0 fits the majority of solar panels on the market. Using the S-5! mini clamps, it fits most standing seam metal roofs. When paired with other S-5! products, the PV Kit 2.0 and EdgeGrab or MidGrab will also work on most exposed fastener including corrugated metal roofs. The MidGrab is designed to fit mid conditions (two adjacent panels), while the new EdgeGrab is designed specifically for end conditions.



Part#	Description
SNGS5PV2.0MID	S-5 Solar Panel Clip Kit 2.0 PV Kit
SNGS5PV2.0EDGE	S-5 Solar Panel Clip Kit 2.0 PV Edge Grab



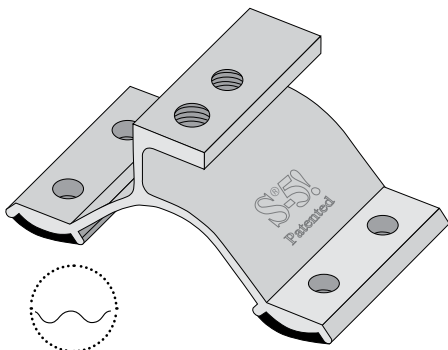

S-5!® CorruBracket™

The S-5!® CorruBracket™ can be used to mount almost anything to corrugated metal roofing. CorruBracket is compatible with 7/8" and 3/4" U.S. corrugated profiles. No messy sealants to apply! No chance for leaks! The CorruBracket comes with factory-applied butyl sealant already in the base, and the S-5!-patented reservoir conceals the sealant from UV exposure, preventing UV degradation. We do NOT recommend the use of CorruBracket for side-bolted rail with L-Foot.

Part#	Description
-------	-------------

SNGS5CB	S-5 CorruBracket
---------	------------------

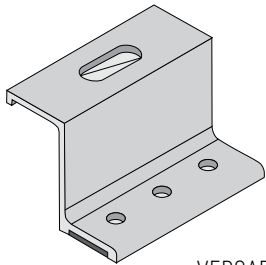

VERSABRACKET-47

S-5!® VersaBracket-47™

VersaBracket can be used to mount almost anything to an exposed-fastened roof system and is compatible with almost any trapezoidal, exposed-fastened profile. The VersaBracket comes with factory-applied butyl sealant already in the base, and the S-5!-patented reservoir conceals the sealant from UV exposure, preventing UV degradation. We do NOT recommend the use of VersaBracket for side-bolted rail with L-Foot.

Part#	Description
-------	-------------

SNGS5BRKT	VersaBracket-47 (To Mount ColorGard To 3' Panels Max 1-3/8" High)
-----------	---

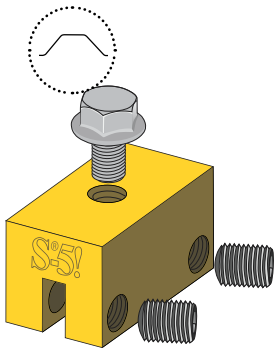

S-5-B - Special Order

The S-5-B clamp allows architects to maintain the beautiful appearance of their copper roofing. The brass clamp fits either traditional standing or batten seams. May not fit profiles with seams that exceed 1-1/2" in height.

Part#	Description
-------	-------------

SNGS5B	S-5-B for Vertical Or Horizontal Seam Profiles Max .40" Thick
--------	---

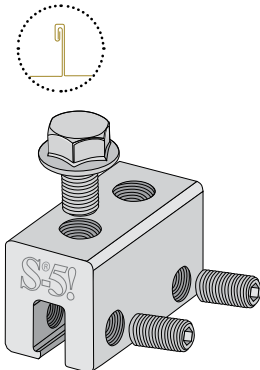

S-5-E - Special Order

The S-5-E is designed specifically for double-folded standing seam roofs that are so popular in Europe (and in the U.S.). The S-5-E is a bit smaller and less expensive than the S-5-U, but every bit as strong. It also fits Butler's MR-24®.

Part#	Description
-------	-------------

SNGS5E	S-5-E Clamp Use For Mechanically Seamed Panels
--------	--

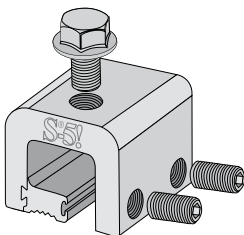

S-5-H - Special Order

The S-5-H clamp was specifically developed to accommodate metal roof panels with a horizontal seam. The clamp's unique two-piece design allows for attachment anywhere along the length of the rib, making installation fast and easy! May not fit profiles with horizontal legs that exceed 3/4".

Part#	Description
-------	-------------

SNGS5H	S-5-H Clamp
--------	-------------



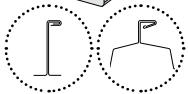
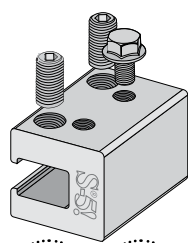

S-5-H90 - Special Order

The S-5-H90 is a one-piece clamp that was developed to securely and cost-effectively accommodate metal roof panels with a horizontal seam greater than 0.65".

Part#	Description
SNGS5H90	S-5-H90 Universal Clamp

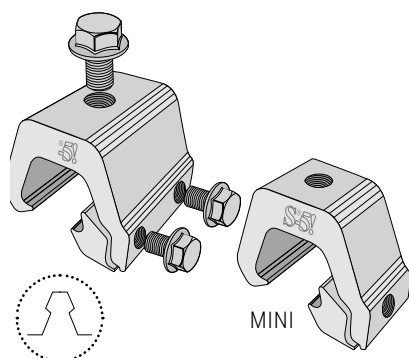

S-5-K Grip - Special Order

The S-5-K Grip™ clamp was specifically developed to fit Klip-Rib® and other bulb snap-together seams. The design utilizes multiple inserts (sold separately) in order to accommodate a variety of bulb snap-together profiles. The S-5-K Grip eliminates the large moment arm other attachment products use for these profiles.

Note: The Mini version of this component is not designed for most snow retention.

Part#	Description
SNGS5KGRIP	S-5-K Grip (3) 8 MM bolts included
SNGS5KGRIP-Mini	S-5-K Grip Mini

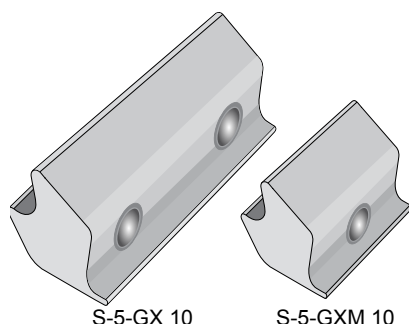

S-5-K Grip Inserts - Special Order

Each S-5-K Grip insert has a unique shape that allows for a tight fit and provides increased holding strength over other attachment options. S-5-K Grip inserts are sold separately from S-5-K Grip camps.

Part#	Description
SNGS5GX-10	GX 10 insert for K Grip clamp
SNGS5GXM-10	GXM-10 insert for K Grip mini Clamp



S-5-N

The new design features an innovative insert that ensures a superior fit whether placed on older profiles or new and wider nail strip profiles. The redesign of the clamps fits the popular 1" nail strip metal roof profiles. It features angled setscrews for easier installation with no special tools required.

Part#	Description
SNGS5N	S-5-N Clamp - Nail Strip Panel Clamp

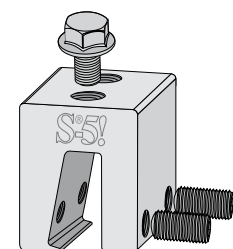

S-5-N 1.5 - Special Order

The S-5-N 1.5 clamp was designed for application on popular 1.5" nail strip metal roof profiles. An angled wall with a nose permits the S-5-N 1.5 to engage the triangle-type profiles during the installation process, and a wider throat accommodates most nail strip profiles. The combination of these two features allows the S-5-N 1.5 clamp to sit straighter on the seam.

Part#	Description
SNGS5N1.5	S-5-N 1-1/2" Clamp - For Standing Seam



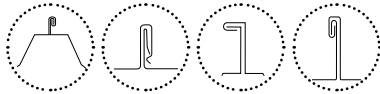
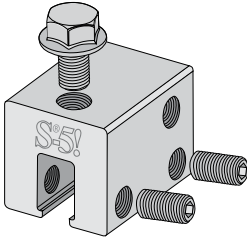
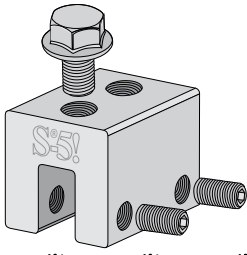

S-5-S

The S-5-S clamp is an extraordinarily versatile clamp. It was created for popular snap-together profiles – including residential profiles. The S-5-S or S-5-S Mini can be used on horizontal seams under 0.54" to avoid field crimping the seam.

Part#	Description
SNGS5S	S-5-S Universal Clamp - Without Bottom Lip

S-5-U

The S-5-U is by far our most popular and versatile clamp. It fits about 85% of the standing seam profiles manufactured in North America – including most structural and many popular architectural profiles. The S-5-U can be used on vertically-oriented seams and, by rotating the clamp 90°, it can also be used on most horizontal 2" seam profiles.

Part#	Description
SNGS5U	S-5-U Universal Clamp

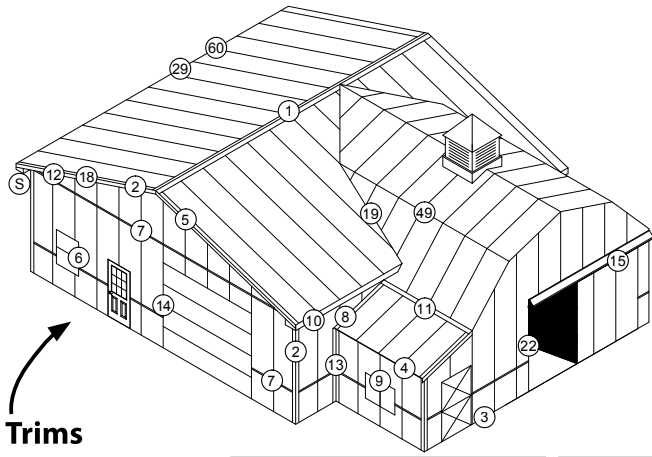

All Trims

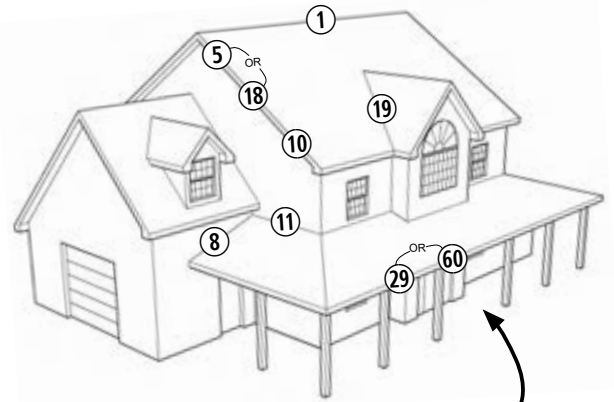

Common Residential Trims

Drawings are not to scale.
Exact dimensions may vary.
Contact us about custom trims.
Item codes are in brackets.
cc - Color Code

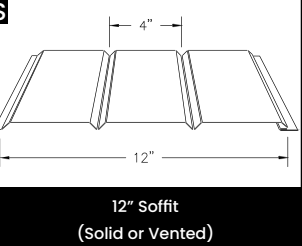
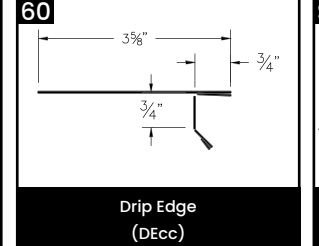
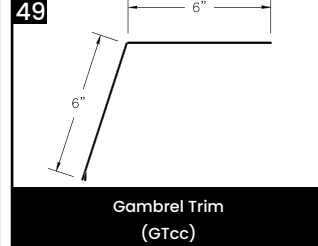
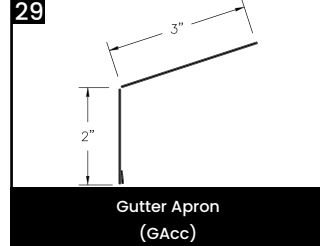
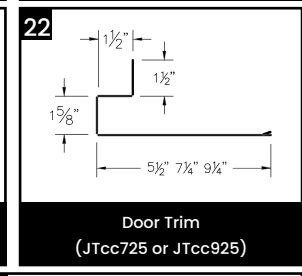
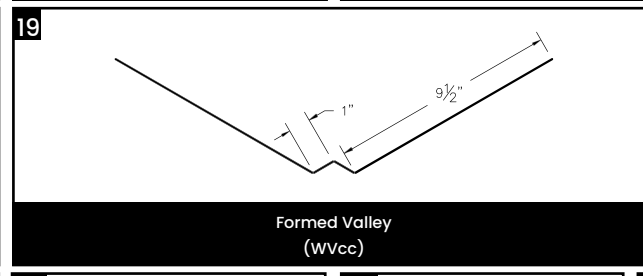
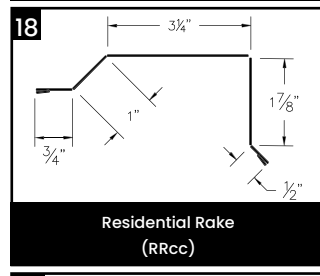
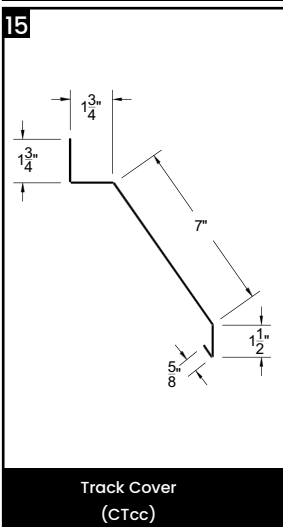
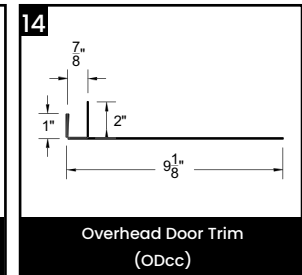
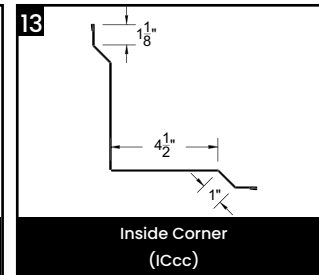
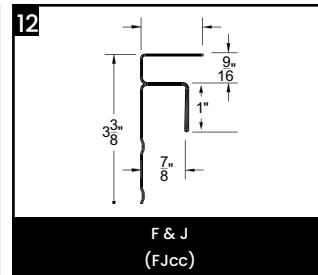
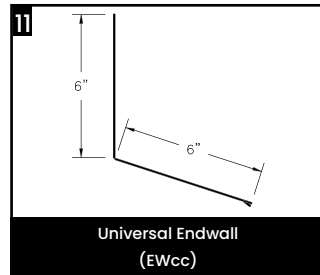
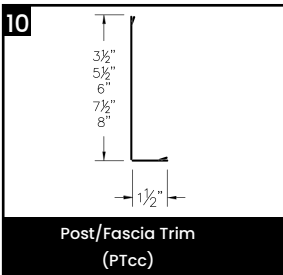
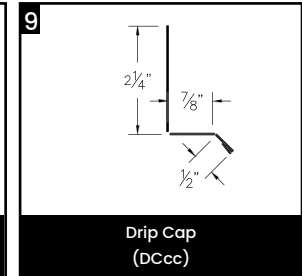
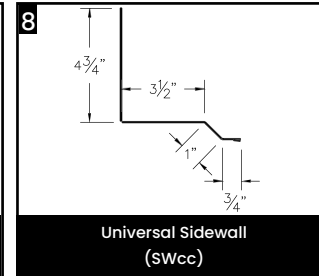
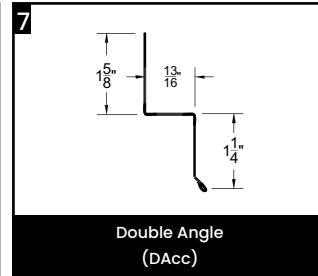
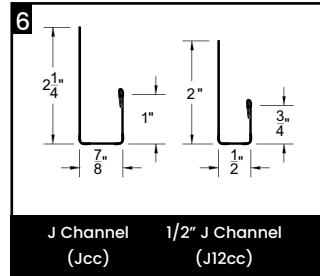
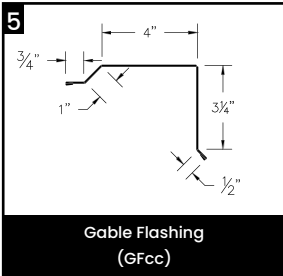
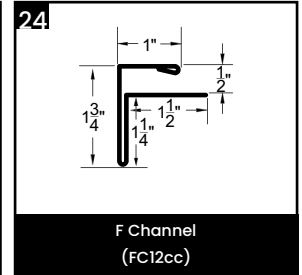
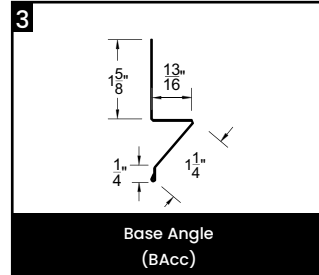
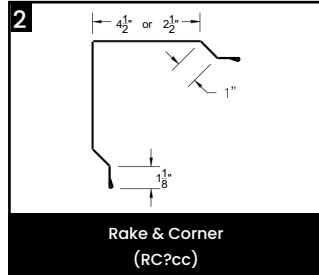
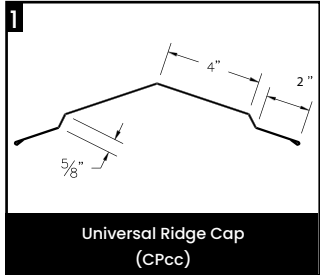

ABSeam Panel Trim Chart

Contact us about custom
Item codes are in brackets
cc = Color Code

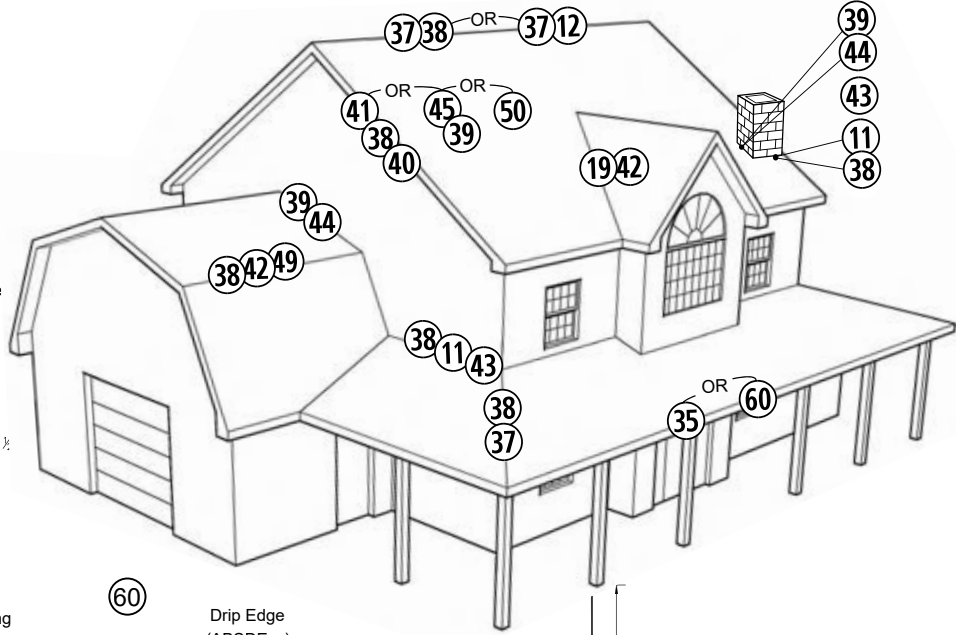

ABS Hidden Clip
(ABSSC)

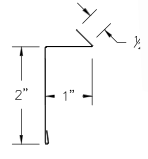

43 ABS Counter Flashing
(ABSCFcc)

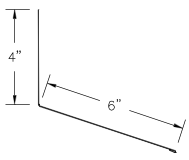

11 ABS Endwall
(ABSEWcc)

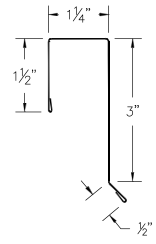

45 ABS Rake Trim
(ABSRtcc)

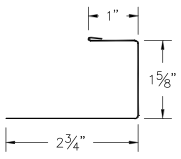

39 ABS Starter "J"
(ABSSJcc)

60 Drip Edge
(ABSDEcc)

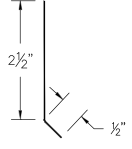

41 ABS Gable Cleat
(ABSGCcc)

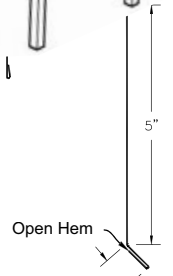

40 ABS Gable Flasing
(ABSGFcc)

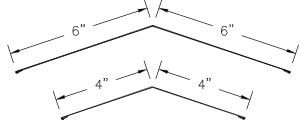

37 ABS 6" Ridge Cap
(ABSCPcc)

31 ABS 4" Ridge Cap
(ABSCP4cc)

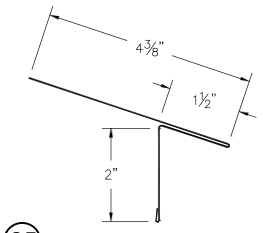

35 ABS Residential Eave
(ABSREcc)

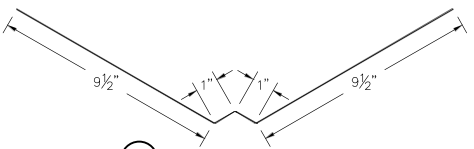

19 ABS W Valley
(ABSWVcc)

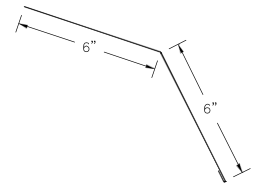

49 ABS Gambrel Trim
(ABSGTcc)

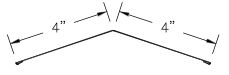

42 ABS Offset Cleat
(ABSOCcc)

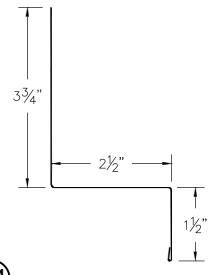

44 ABS Sidewall
(ABSSWcc)

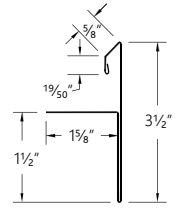

50 ABS Slim Line Rake
(ABSSLRcc)

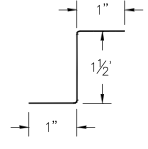

38 ABS Metal "Z" Closure
(ABSZcc)

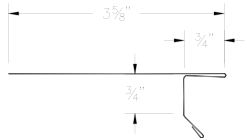

Commercial Panel Trim Chart

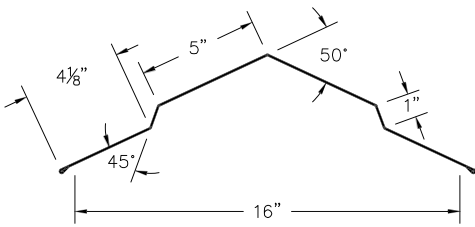

③④ 20" Ridge Cap (CP20cc)

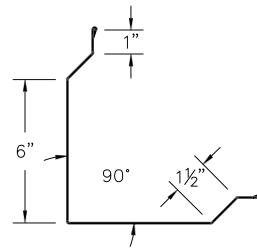

⑤⑥ PBR Outside Corner (PBRRCcc)

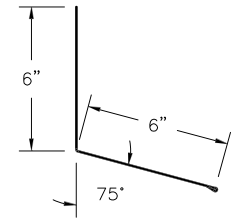

①① Universal Endwall (PBREWcc)

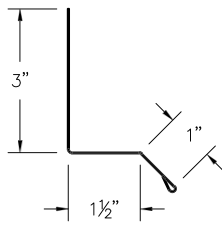

⑤① PBR Drip Cap (PBRDCcc)

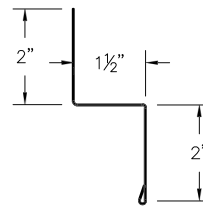

⑤③ PBR Double Angle (PBRDAcc)

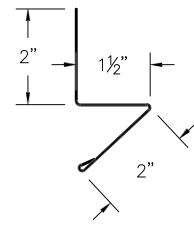

⑤④ PBR Base Angle (PBRBAcc)

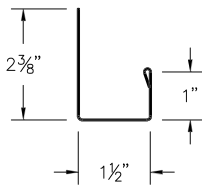

⑤⑤ PBR J Channel (PBRJcc)

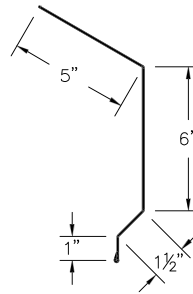

⑤⑦ PBR Fascia Trim (PBRFTcc)

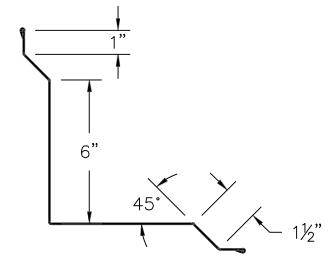

⑤⑧ PBR Inside Corner (PBRICcc)

Proper Overlap

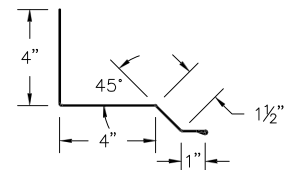
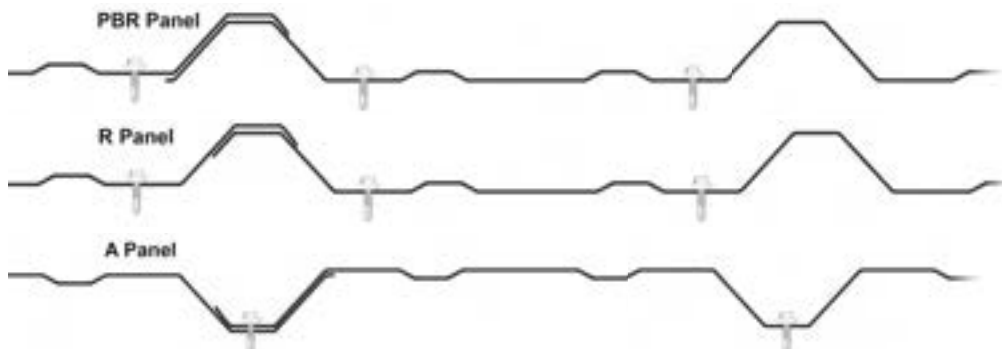

⑤② PBR Universal Sidewall (PBRSWcc)

Board & Batten Panel Trim Chart

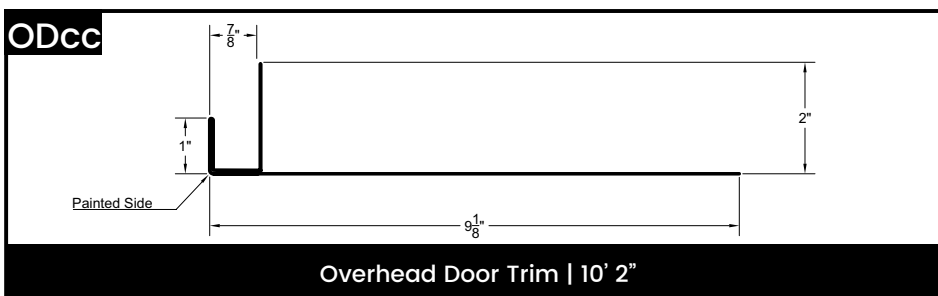
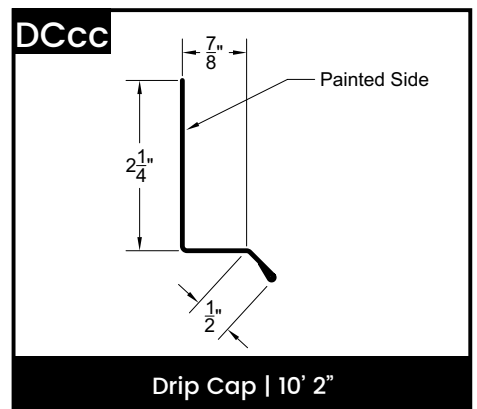
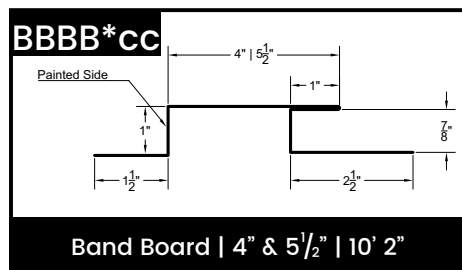
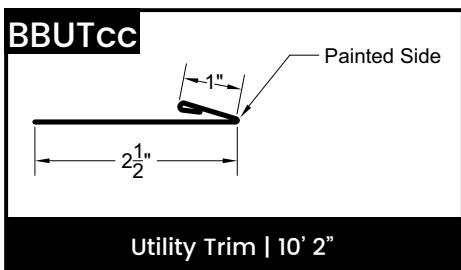
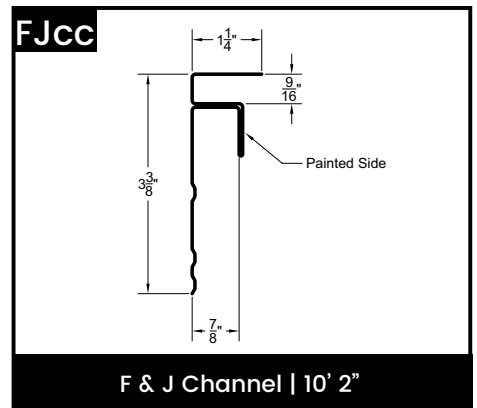
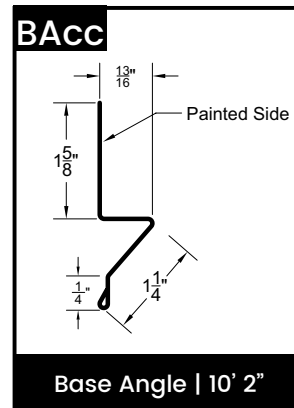
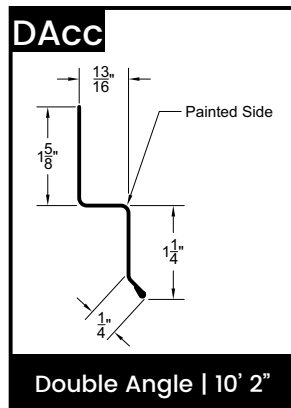
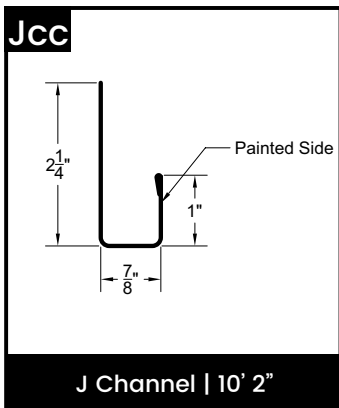
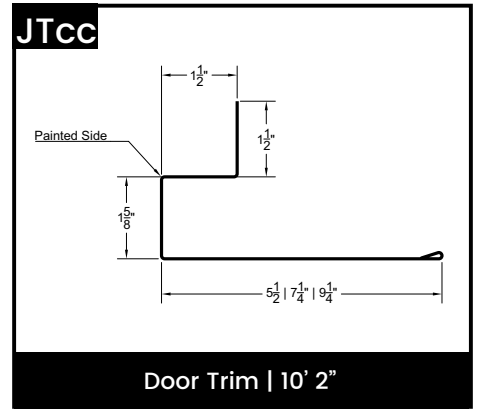
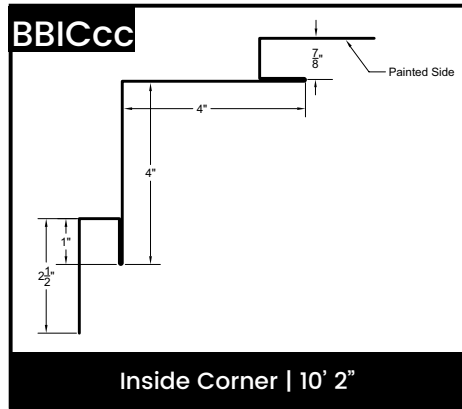
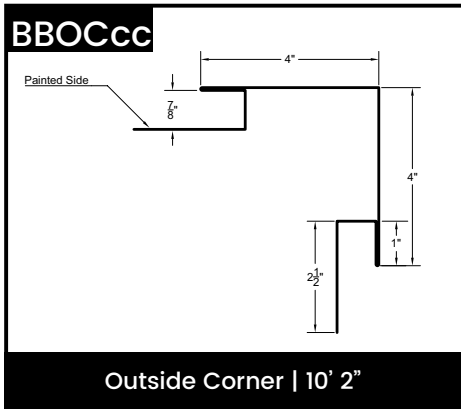

Cupola Installation Instructions

Attaching Cupola Base to Roof

The A.B. Martin Cupolas are meant to be fastened using 2 inch minimum #10 ZXL MB WoodBinder screws fastened through the cupola base - lined on the roof side with EMSeal - through every rib of the roof below and into 2 x 10 Yellow Pine.

ZXL MB WoodBinder (40-year Screw)

- Designed to fasten steel roofing to wood purlins used in post-frame construction, plywood or OSB used in residential construction.
- 5/16" cupped HWH with a molded ZAMAC 5 Zinc-Aluminum alloy provides lifetime protection against red rust on the head & washer.
- The ZAMAC 5 alloy provides more strength than more common ZAMAC 3 alloy. You may obtain a free copy of the written warranty upon request.
- ZXL is an excellent choice for GALVALUME & other long-life metal roof panels.
- Threads transition from fine to coarse to generate superior holding strength in various wood substrates.
- Micro-Bit point reduces metal shavings that can embed themselves in the rubber washer.

PULL OUT STRENGTH <i>LBS. ULT.</i>				
SUBSTRATE	PENETRATION	10-16/8 VALUE	STITCH VALUE	
3/4" PLY		636		
5/8" PLY		441	297	
1/2" PLY		368	329	
7/16" OSB		210	217	
2 X Y. PINE*	1"	713	495	
2 X Y. PINE*	FULL	1526		
2 X SPF*	1"	466	162	
2 X SPF*	FULL	1216		

PULL OVER STRENGTH <i>LBS. ULT.</i>				
SUBSTRATE	GAUGE	THICKNESS	10-16/8 VALUE	STITCH VALUE
AZ55 Galvalume	29	.015	658	378
AZ55 Galvalume	26	.019	927	629
AZ55 Galvalume	24	.024	1035	721
AZ55 Galvalume	22	.032	1386	

Pull over values are calculated with a EPDM rubber washer assembled to cupped head screw with a .500" washer face.



HEAD STYLE
5/16" CHWH
POINT DIAMETER
Micro-Bit
MAJOR DIAMETER
.210/.200
MINOR DIAMETER
.130/.126
WASHER FACE DIAMETER
0.5
HEAD ACROSS FLATS
.311/.305
ULT. TENSILE STRENGTH
1585 LBS.
MIN. TORSIONAL STRENGTH
60 IN-LBS.
NOM. SHEAR STRENGTH
1574 LBS.



What is Slope?

Roof Slope is often mistakenly referred to as, "Roof Pitch." The difference lies in that Roof Slope measures how much the roof rises vertically every 12 inches horizontally, whereas Roof Pitch is an outdated calculation that takes the total vertical roof height divided by the wall-to-wall span of the building.

The reason why Roof Pitch is outdated is because it is only helpful if the roof peak is in the direct center of the building. Since modern buildings are not always designed in this way, most builders have adopted Roof Slope in their calculations (though many call it "Roof Pitch" by mistake).

Example 1: If a roof rises 7 inches every 12" horizontally, we would say the roof has a slope of 7/12 and a pitch of 7/24.

Example 2: If a roof rises 8 feet and the wall-to-wall slope is 32 feet, the roof slope would be 6/12, but the roof pitch would be 1/4 (8/32 reduced).

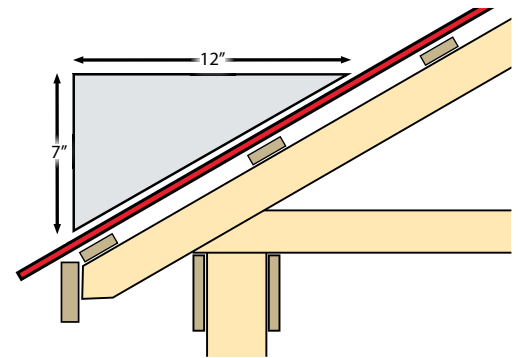

Slope Factor Chart

Roof Slope	1/12	2/12	3/12	4/12	5/12	6/12	7/12	8/12	9/12	10/12	11/12	12/12
Roof Pitch	1/24	1/12	1/8	1/6	5/24	1/4	7/24	1/3	3/8	5/12	11/24	1/2
Slope Factor	1.0035	1.0138	1.0308	1.0541	1.0833	1.1180	1.1577	1.2019	1.2500	1.3017	1.3566	1.4142
Valley & Hip Factor	1.4167	1.4240	1.4362	1.4530	1.4743	1.5000	1.5298	1.5635	1.6008	1.6415	1.6853	1.7320

Valley Calculation

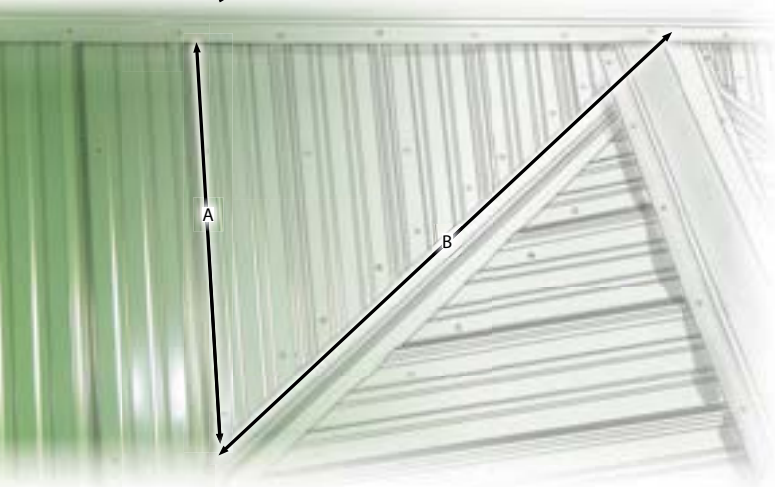

$$(A) \times (\text{Valley \& Hip Factor}) = (B)$$

Slope Calculation

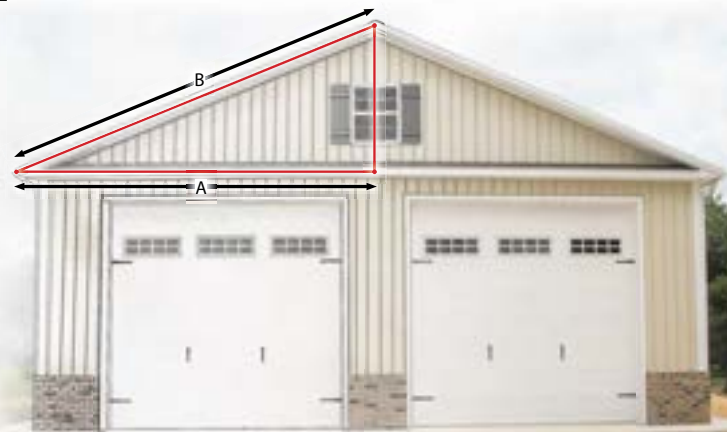

$$(A) \times (\text{Slope Factor}) = (B)$$

Cupola Installation Instructions

- ① Align the cupola to the universal base (Fig. 1)
- ② Attach using the 16 color-matched sheet metal screws included with your 16", 24", or 36" cupolas (48" cupolas come pre-assembled)
- ③ Install 4 screws - spread evenly apart - on each side of the cupola and no less than 2" from the corners (Fig. 2)

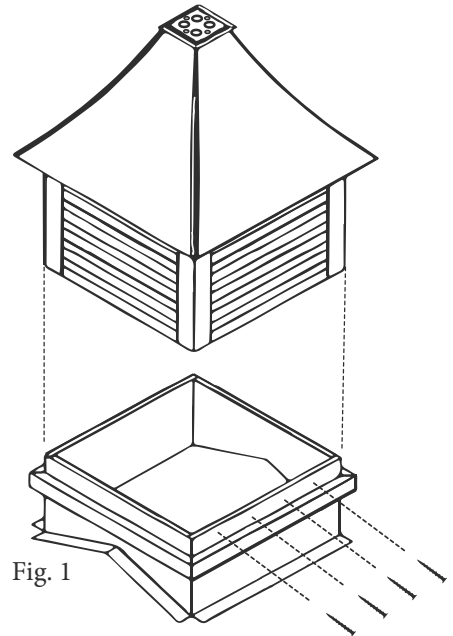

Fig. 1

Do not put screws through corner pieces

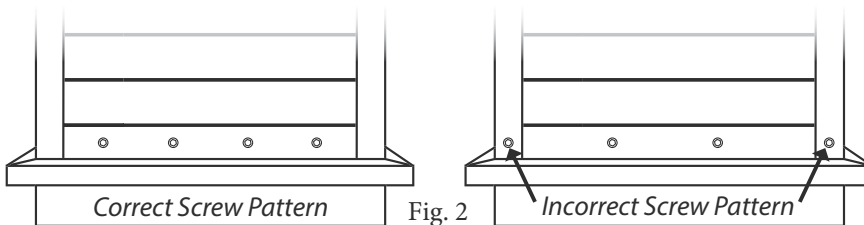

Fig. 2

Weathervane Installation Instructions

- ① Fill $\frac{3}{4}$ " in diameter fastening area of cupola roof cap with 2300 Geocel caulk before fastening weathervane flange base
- ② Mount and screw weathervane flange base to cupola roof cap using the 4 black #12 self-tapping screws included with your cupola
- ③ Discard the nut provided with the weathervane and use the $\frac{1}{4}$ -20 Nylock Locknut provided with the cupola roof cap
- ④ Assemble weathervane mast to flange base as seen in Figure 3. Holding the mast vertically (90°). Firmly tighten nut/bolt

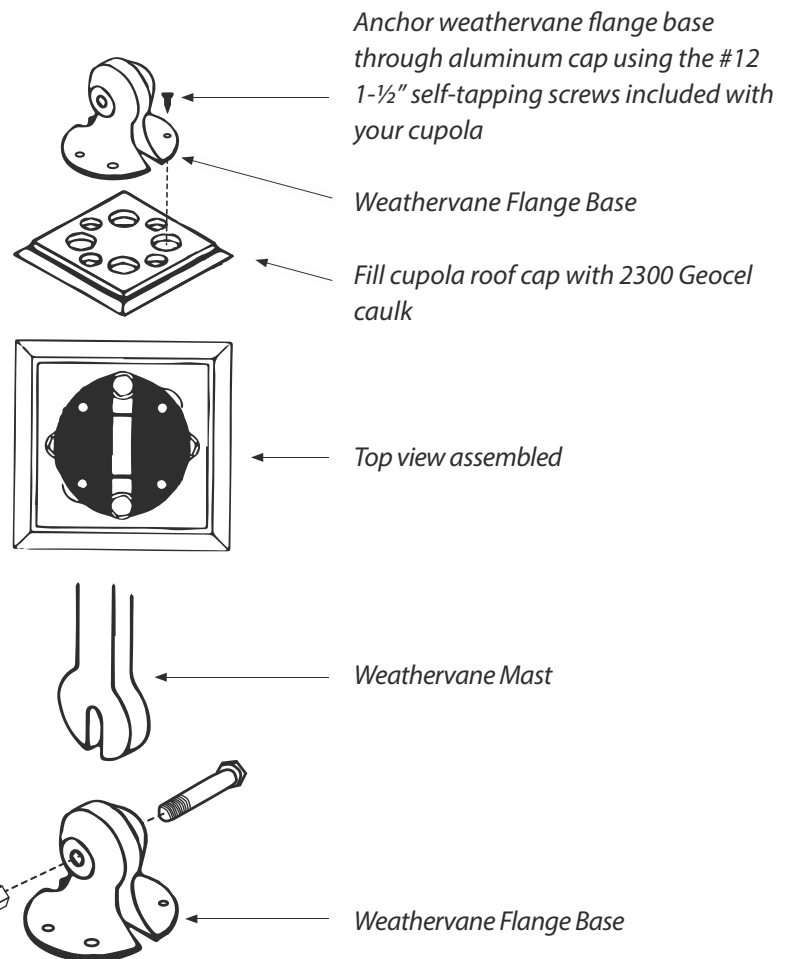

Fig. 2



How the ABM Panel is Made



1. PRE-PAINTED COILS

We purchase the 5-ton steel coils that meet our quality specifications directly from the steel plant.

We ship them, first, to the coating facility, where the precoat and Sherwin-Williams' top coat are applied, before shipping them to our warehouse.

The coils are cataloged and carefully stored out of the weather – ready for use.



2. UNCOILED

When an order is received, the coils are placed on the uncoiler that feeds the steel onto the rollformer.



5. CUT-TO-LENGTH

The ABM panel is made to custom lengths within a ¼" thanks to what we call the "flying sheer." The flying sheer cuts the steel with amazing precision as it speeds down the line.

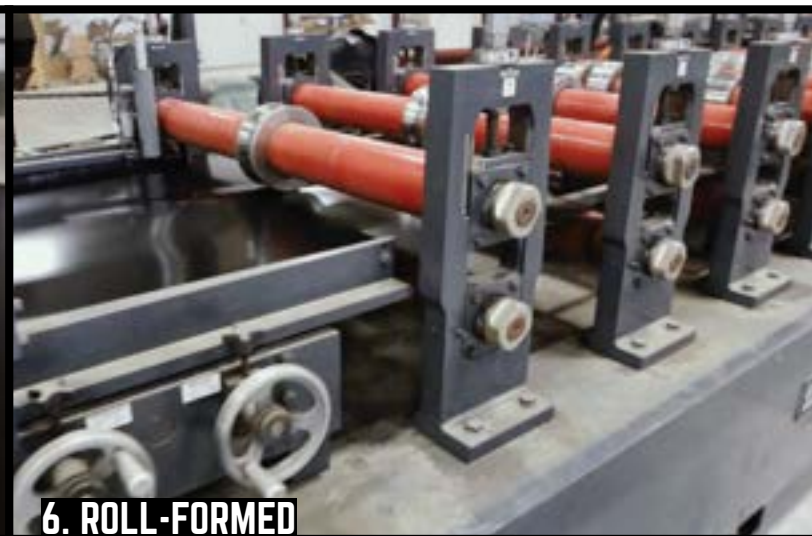

6. ROLL-FORMED

The cut sheets go through a series of rollers with dies that form the steel into the ABM Panel profile.





3. HEAT-FORMED

For better performance, the ABM panel passes through a 1,000° Fahrenheit heat-box that warms the panels and temporarily softens the paint coating. This allows the paint to flex and bend with the steel as the panel is formed.

Without heat-forming, the paint would crack and would likely rust.



4. IMPRINTED

Each ABM panel is imprinted on the underlap with the order number, customer name, panel length, the date it was made, and the product grade (example: *G-100* or *Standard*).

This is how we are able to offer our low-hassle 40-year warranties. If there is ever a problem, the customer only needs to unscrew one of the panels to find the order number and manufacture date to initiate a warranty claim.



7. BANDED

A cover sheet (which often varies in color) is placed on top of the stack to protect the panels before the stack is banded together.



8. STACKED FOR DELIVERY

A forklift transports the bundled panels to the customer's waiting truck or trailer, or places it on the holding rack ready for shipment to the job site.

Watch the ABM Panel being made:



PRODUCT INDEX

A

AB35 Ridge Vent	72
ABM Panel - 26 Gauge Textured AZ50 Galvalume.....	6
ABM Panel - 28 Gauge AZ50 Galvalume.....	6
ABM Panel - 28 Gauge G-100 Galvanized.....	5
ABM Panel - 28 Gauge Perforated.....	6
ABM Panel - 28 Gauge Seconds	6
ABSeam Panel - 16 oz Copper.....	10
ABSeam Panel - 24 Gauge AZ50 Galvalume.....	9
ABSeam Panel - 26 Gauge Textured AZ50 Galvalume.....	10
Aged Metal.....	21
Ag-Tuf.....	81
AJ 5100 Series White Commercial Steel Doors.....	207
AJ Ceiling Access Door.....	207
AJ R51 Series White Steel Doors.....	207
Aluminum Railing - American Series	174
Aluminum Slant Back Roof Louver	75, 96
Aluminum Soffit.....	138
A Panel - 26 Gauge AZ50 Galvalume.....	13
Asphalt Shingles	
Aluminum Drip Edge.....	96
Aluminum Slant Back Roof Louver.....	75, 96
Electro-Galvanized Roofing Coil Nails.....	96
Lomanco Lo-Omniroll Shingle Vent.....	96
Nevercaulk Residential Roof Flashing.....	97, 66
Oatey Roof Flashing.....	97, 66
Perma-Boot® Roof Flashing - Retrofit.....	97
Roof Saver Cobra Vent	96
Step Flashing.....	96
Tamko® Heritage Lifetime Laminated Shingles....	92, 96

B

Baffles	
Accuvent Attic Vent Baffle.....	240
Durovent Attic Vent Baffle.....	240
Black Perforated Corrugated Pipe.....	256
Black Poly Water Pipe.....	252
Black Rubber Roofing - Weatherbond.....	100
Black Solid Corrugated Pipe	256
Black Vinyl Coated Poultry Netting.....	250
Board and Batten.....	23
Boral® Versetta Stone.....	140
Brakes.....	38

C

Cable Railing	
Deckorators® Contemporary Cable Railing.....	177
Cabot Stain.....	157
Camo Deck Screws - National Nail.....	168
Camo Drive Deck Fastening Tool Attachment.....	182
Cannonball Fiberglass Door - #52.....	206
Cannonball Steel Door - #1734.....	206
Caulk	
2300 Construction Tripolymer Sealant.....	53
2320 Construction Tripolymer Seam Sealant.....	54
4500 Roof Bonding Sealant.....	55
8150 100% Silicone Neutral Cure.....	55
8150 Skylight Caulk.....	89
Lexel.....	58
NovaFlex.....	56

QUAD.....	60
Quad MAX.....	60
RP-400® Plastic Wet-Dry Surface Roof Cement ...	58
Superbond High Strength Adhesive.....	277
WeatherMaster Metal Roof Sealant.....	57
Celect Cellular Composite Siding	141
Closures	
Em-Seal Closure.....	70
Foam Closure Strips.....	71
Coil Cradle and Dispenser.....	39
Coil Stock.....	29
Collated Deck Fasteners.....	183
Composite Decking.....	171
Deckorators® Summit Composite Deck Board....	172
Concrete	
Concrete and Masonry Sealer.....	247
Concrete Block.....	246
Concrete Expansion Joint	247
Concrete Form Pins.....	246
Concrete Mix	244
Concrete Pole Pills	246
Concrete Rebar.....	245
Concrete Rebar Cap	246
Concrete Rebar Wire Chairs	245
Concrete Rebar Wire Tie.....	245
Concrete Wire.....	245
DryLok Masonry Waterproofer.....	247
Fast-setting.....	244
Mason Type S.....	244
Portland Cement	244
Quik-tube Concrete Form	247
Wire Tie Twister.....	245
Concrete Block.....	246
Concrete Form	
Quik-tube Concrete Form	247
Concrete Screw.....	166
Copper Pop Rivets.....	51
Crimper	
Single Crimper - Malco.....	32
Cupola	
16" Cupola.....	193
24" Cupola.....	193
36" Cupola.....	193
48" Cupola.....	193
Replacement Cupola Cap.....	193

D

Deck Fasteners	
Big Timber Construction Screws.....	169
Camo Deck Screws - National Nail.....	168
Camo Drive Deck Fastening Tool Attachment.....	182
Collated Deck Fasteners.....	183
Edge Clip Hidden Deck Fasteners.....	183
Phantom Universal Hidden Deck Fasteners.....	183
Tan Deck Screws - PrimeGuard Plus.....	168
Tiger Claw Hidden Deck Fastener.....	182
Tiger Claw Pneumatic Gun.....	182
Tiger Claw Pneumatic Screws.....	182
Decking	
Aluminum Railing - American Series.....	174
Deck Joist Tape.....	181

Fiberon® Good Life Composite Deck Board.....	171
Fiberon® Horizon Composite Deck Board.....	171
Fiberon® Sanctuary Composite Deck Board.....	172
Gate Hinge.....	175
Secondary Handrail - 1-1/2" White Aluminum.....	179
Timbertech® Reserve Composite Deck Board.....	173
Treated Wood Balusters.....	117, 181
Treated Yellow Pine Deck Boards.....	117, 181
Vinyl Railing - 3000 Series.....	176
Deck Joist Tape.....	181
Double Bubble Insulation.....	236
Double-Hung Vinyl Window.....	202
Drip Edge	
Aluminum Drip Edge.....	96
Drop Ceiling Panel.....	85
Drywall	
Drywall Corner Bead.....	151
Drywall Knife.....	153
Drywall Pole Sander.....	153
Drywall Rasp.....	153
Drywall Ribbon Blade.....	153
Drywall Roll Lifter	153
Fibafuse Drywall Tape.....	152
Fiberglass Drywall Seam Tape.....	152
Light-Weight Ready Mixed Joint Compound.....	154
Mid-Weight Ready Mixed Joint Compound.....	154
National Gypsum Fire Resistive Drywall.....	150
National Gypsum High Strength LITE Drywall.....	150
National Gypsum Moisture/Mold Resistive Drywall.....	150
Paper Drywall Seam Tape.....	152
Ready Mixed Joint Compound	154
Vinyl Drywall Compound.....	155
Vinyl Drywall Corner Bead.....	151
Walboard Joint Compound.....	155
DuPont® Roof Protector	108
Dutch Door	
Aluminum Dutch Door.....	191
Aluminum Split Slider Dutch Door - Special Order .	191
Steel Dutch Door.....	191
Dyna Cut Shear	
Ag Panel Shear.....	40

E

Edge Clip Hidden Deck Fasteners.....	183
Elephant Skin Synthetic Roofing Underlayment	108
Em-Seal Closure.....	70
Entry Door	
AJ 5100 Series White Commercial Steel Doors.....	207
AJ Ceiling Access Door.....	207
AJ R51 Series White Steel Doors	207
Bulb Style Weatherstrip.....	210
Cannonball Fiberglass Door - #52.....	206
Cannonball Steel Door - #1734.....	206
Door Hardware	211
Door Sweep.....	210
Header Snap Cap.....	210
Interior Sliding Door - N186-960 and N186-966....	208
Epoxy - Water Based.....	160
Everdrain Skylight	88
Exhaust Fan	
Covent Exhaust Fan.....	64



Extreme Angle Roof Boot..... 65

F

Fasteners

#14 WoodBinder Nail-Replacement 47
 Camo Deck Screws - National Nail..... 168
 Collated Deck Fasteners..... 183
 Concrete Screw 166
 Copper Pop Rivets..... 51
 Edge Clip Hidden Deck Fasteners 183
 GRK Structural Screws 163
 Hand Pop Riveter..... 51
 Headlok Flathead Screws - FastenMaster..... 165
 HWH SteelBinder..... 46
 Insulation Fasteners..... 105
 LedgerLOK Screws - FastenMaster 164
 M12 Rivet Tool..... 51
 Nail Replacement Screw 48
 OSB WoodBinder 44
 Pancake Screw 49
 Phantom Universal Hidden Deck Fasteners..... 183
 Polycarbonate Screws..... 89
 Stainless Steel Pop Rivets..... 51
 Stainless Steel Trim Nails..... 50
 Stainless Steel Zip Screws 50
 SteelBinder 45
 Tan Deck Screws - PrimeGuard Plus..... 168
 ThruLOK Screw Bolt System - FastenMaster 165
 Tiger Claw Hidden Deck Fastener 182
 TimberLOK Heavy-Duty Screws - FastenMaster 164
 Titen Heavy-Duty Concrete Anchor 166
 Wedge Anchor - Galvanized..... 166
 Wedge Anchor - Stainless..... 166
 Wedge Anchor - Zinc 167
 White Eclipse Pan Head Screw..... 49
 WoodBinder 42
 ZXL WoodBinder..... 43

Fencing

Black Vinyl Coated Poultry Netting..... 250
 Galvanized Hardware Cloth..... 249
 Galvanized Poultry Netting..... 250
 Galvanized Welded Wire Fencing 249
 Fiberon® Good Life Composite Deck Board..... 171
 Fiberon® Horizon Composite Deck Board..... 171
 Fiberon® Sanctuary Composite Deck Board..... 172
 Flashing Tape..... 109
 Foam Closure Strips 71

Folding Tool

Folding Tool - Malco 36
 Folding Tool - Midwest 36
 Folding Tool - Wiss 36
 FRP/Glassboard..... 83
 FRP/Glassboard Adhesive..... 85
 FRP/Glassboard Plastic Pop Rivets..... 85

G

Galvanized Hardware Cloth 249
 Galvanized Poultry Netting 250
 Galvanized Welded Wire Fencing..... 249
 Garage Doors
 4200 Series Garage Door (non-stock) 218
 5500 Series Garage Door - Stocked..... 216
 7200 Series Garage Door - Stocked..... 217
 Vinyl Door Stop..... 218
 Georgia Pacific® Shadow Ridge - Vinyl..... 137
 Glassboard

FRP/Glassboard - A Grade..... 83
 GRK Structural Screws..... 163
 Gutter
 5 oz. Pliogrip Seam Sealer Tube..... 267
 #6 Copper Shank..... 270
 #6 Drive 266
 #6 Shank..... 261
 #8 Shank..... 261
 #10 Combination Hanger 260
 #10 Copper Shank..... 270
 #10 Shank for Fascia..... 261
 #11 Copper Shank..... 270
 #11 Shank for Nailing to Exposed Rafter 261
 #12 Copper Shank..... 271
 #12 Shank for Nailing to Sheeting..... 261
 #30 Copper Shank..... 271
 #30 Shank..... 262
 Aluminum Pop Rivets..... 51, 267
 Brass Nuts & Bolts..... 272
 Brass Spring Clip..... 272
 Copper #6 Drive..... 271
 Copper #10 Combination Hanger..... 270
 Copper Downspout..... 269
 Copper Elbows..... 269
 Copper End Caps for Half Round Gutter 268
 Copper Funnel 269
 Copper Gem Circle..... 270
 Copper Half Round Gutter..... 268
 Copper Masonry & Wood Drives..... 271
 Copper Miters for Half Round Gutter 268
 Copper Pop Rivets..... 272
 Copper Rack & Brass Key..... 269
 Copper Round B-Style Outlet..... 269
 Copper Round Wire Strainer..... 268
 Copper Shank Extension 271
 Copper Slip Joint for Half Round Gutter..... 268
 Cut Off Diverter for K-Gutter..... 263
 End Cap for Half Round Gutter..... 262
 End Cap for K-Gutter..... 262
 End Piece for Half Round Gutter 264
 End Piece for K-Gutter 264
 Extension Shank..... 262
 Gem Circle for Half Round Gutter..... 260
 Half Round Gutter..... 258
 Hidden Hanger for K-Gutter with 1/4" Screw..... 260
 Hinged Gutter Guard..... 273
 Inside Miter for Half Round Gutter 263
 Inside Miter for K-Gutter..... 263
 K-Style Gutter..... 258
 Leaf Relief Gutter Guard..... 273
 Masonry & Wood Drives 266
 Nuts & Bolts..... 267
 Outside Miter for Half Round Gutter..... 263
 Outside Miter for K-Gutter 263
 Oval Funnel..... 264
 Pipe Clip..... 266
 PVC Splash Blocks 267
 Rack & Key..... 266
 RayTec Gutter Guard 273
 Rectangle Corrugated Downspout 258
 Rectangle Corrugated Elbow..... 259
 Round Corrugated Downspout..... 258
 Round Corrugated Elbow..... 259
 Slip Joint for Half Round Gutter 264
 Slip Joint for K-Gutter..... 264
 Spring Clip 267
 Stamped Round Sickle Hook..... 266
 Universal Conductor Band..... 267

Wide Flange B-style Outlet 265
 Wide Flange Pop Rivet Oval Outlet..... 265
 Wide Flange Round Outlet..... 265
 Wire Strainers 267

H

Half Round Gutter..... 258
 Hand Notcher - Malco..... 31
 Hand Pop Riveter 51
 Headlok Flathead Screws - FastenMaster..... 165
 Henry Eveguard Shingle Underlayment 108
 Heritage Panel 12
 Horse Stall Components
 Black Non-Adjustable Door Stop 190
 Black Track and Trolley Systems..... 190
 Blanket Bar 188
 Chew Guard/Corner Angle..... 186
 Corner Hay Rack..... 188
 Door Frame with Grill..... 189
 Door Frame with Yoke Grill..... 189
 Flat Track Accessories - Exterior or Interior 190
 Flat Track Rails - Exterior or Interior..... 190
 Flat Track Trolleys - Exterior or Interior 190
 Grill with Feeder Opening 187
 Guide Pin 190
 Portable Saddle Rack 188
 Portable Wall Mount Pail Holder 188
 Rubber Horse Stall Mat 186
 Sliding Bolt Latch..... 189
 Solid Grill 187
 Swing-out Feeder Door..... 187
 Top Mount Door Latch..... 189
 U-Channel 186
 Wall Brace/Hat Channel 186
 Wall Hay Rack..... 188
 Window Grill..... 187
 Wood Dutch Door 191
 House Wrap
 DuPont® Roof Protector..... 108
 Rexwrap Plus House Wrap 107
 Tyvek® House Wrap..... 107
 Tyvek® StuccoWrap® 107
 HWH SteelBinder 46

I

Ice & Water Protector Underlayment 107
 Insulation
 Accuvent Attic Vent Baffle..... 240
 ACfoam II Insulation 237
 Blown Cellulose Insulation - Sanctuary..... 240
 Blown Fiberglass Insulation - ProPink L77 240
 Double Bubble Insulation..... 236
 Durovent Attic Vent Baffle..... 240
 Expanded Polystyrene Insulation 239
 Felt Faced Insulation..... 237
 Fiberboard - Rubber Roofing Insulation..... 105
 Fiberglass Insulation - Owens Corning™ 237
 Green Guard Fan Fold Insulation 239
 Insulation Fasteners..... 105
 Insulation Plates..... 105
 Mineral Wool Insulation - RockWool Comfort Batt. 238
 Vinyl Backed Insulation 237
 Insulation Plates 105



J

James Way Slitter	37
James Way Valley Square.....	37
J-Channel Cutter - Malco	32
Joist Hangers and Ties	
Adjustable Post Base	127
Adjustable Stair Stringer Connector.....	125
Angles.....	125
Base/Caps.....	128
Coil Wall Bracing.....	127
Concealed Hanger.....	130
Deck Ties	126
Face Mount Hanger.....	130
Face Mount I Joist Hanger.....	129
Hanger Screws	133
H Clips for Plywood.....	131
Heavy Duty Connector Screws	134
Hurricane Ties	126
Insulation Support.....	127
Lateral Tie Plate.....	131
Light Girder Tiedown	128
Light Retro Fit U Hanger	130
Mending Plate.....	131
Outdoor Accents.....	123
Angles	123
Beam-to-Column Ties.....	124
Deck Joists	123
Decorative Washers	123
Joist Hangers	124
Post Bases	123
Wood Screws	124
Quickstick	133
Single Roof Truss Clip	132
Skewable Jack Hanger	129
Skewed Hanger.....	130
Standoff Post Base.....	128
Strap Tie (Light).....	132
Strap Tie (Medium).....	132
Tension Bridging.....	132
Tension Tie	132
Tie Plate.....	131
Top Flange I Joist Hanger	129
Top Mount Single Hanger.....	129
Tread Angle.....	126
Truss Spacer.....	131
Vertical Hold Downs.....	128

K

KDAT Porch Flooring.....	182
K-Style Gutter	258

L

LedgerLOK Screws - FastenMaster	164
Lexel.....	58
Lomanco Lo-Omniroll Shingle Vent	96
Louvers	
Aluminum Slant Back Roof Louver.....	75, 96
Steel Louvers.....	74
Vinyl Louvers	137
LP Smartside Siding	136
Lumber	
#1 Yellow Pine	113
#2 White Pine	114
#2 Yellow Pine	113

4 x 4 Treated Post.....	181
AdvanTech Tongue and Groove OSB.....	119
Attic Truss	120
Deck Joist Tape	181
Eastern White Pine Rough Sawn	114
Fir Plywood.....	118
Gambrel Truss.....	120
Glue Laminated SYP Posts.....	115
Gold Edge Tongue and Groove OSB	119
Lauan Plywood	118
LP Smartside Siding	117
LVL Headers.....	112
Mono Truss.....	120
OSB.....	119
Perma Column.....	115
Rough Cut.....	114
Scissors Truss.....	120
Shiplap Rough Sawn.....	114
Spruce/Pine/Fur Dimensional Lumber	112
Standard Truss	120
T1-11	117
The Green Post.....	115
Tongue & Groove Barn Siding.....	114
Tongue & Groove Yellow Pine.....	113
Top Notch 350 Tongue and Groove OSB	119
Treated Plywood.....	118
Treated Solid Sawn Post	115
Treated Tongue & Groove Yellow Pine.....	113
Treated Wood Balusters	117, 181
Treated Yellow Pine	113
Treated Yellow Pine Deck Boards.....	117, 181
Yellow Pine Machine Stress Rated.....	112
Yellow Pine Plywood.....	118
Yellow Pine Stair Treads	117
Zip System OSB.....	119
LVL Headers.....	112

M

M12 Rivet Tool	51
Metal Man Valley Super Square.....	37
Metal Master Brake.....	38
Metal Panels	
5-V Crimp.....	16
9" Double Rib	17
ABM Panel	5
AZ50 Galvalume.....	6
G-100 Galvanized	5
Perforated	6
Seconds	6
Textured AZ50 Galvalume.....	6
Trims	7
ABM Weatherstrong	17
ABSeam Panel	9
16 oz Copper.....	10
AZ50 Galvalume.....	9
Textured AZ50 Galvalume.....	10
Trims	11
Aged Metal	21
Board and Batten.....	23
Camo	19
Commercial Panels	13
A Panel.....	13
PBR Panel.....	13
R Panel.....	13

Continuous Corrugated Panel	15
1-1/4" Corrugated	15
2-1/2" Corrugated	15
Everdrain.....	16
Heritage Panel.....	12
Textured AZ 50 Galvalume	24
Milwaukee Nibblers.....	33
Multi-Wall	90

N

Nail Replacement Screw	48
Nevercaulk Residential Roof Flashing	66, 97
Non-Insulated Single-Hung Aluminum Window	202

O

Oatey Roof Flashing.....	66, 97
OSB	119
OSB WoodBinder.....	44
Outdoor Accents	123
Outlast Q8 Log Oil Wood Preservative	161

P

Paint	
Defi-Rust Acrylic Enamel	160
Rust-Oleum Spray Paint.....	160
Valpar Professional	158
Valspar Medallion	158
Valspar Pristine	159
Pancake Screw.....	49
PBR Panel - 26 Gauge AZ50 Galvalume.....	13
Perform Vent.....	69
Perma-Boot® Roof Flashing - Retrofit	97
Perma Column	115
Phantom Universal Hidden Deck Fasteners	183
Pipe and Fittings	
Black Corrugated Pipe Fittings.....	256
Black Perforated Corrugated Pipe.....	256
Black Poly Water Pipe.....	252
Black Solid Corrugated Pipe.....	256
Hoseclamps.....	252
PVC Pipe Primer and Cement.....	254
Schedule 40 PVC DWV Pipe	253
Schedule 40 PVC DWV Pipe Fittings	253
Sewer & Drain PVC Pipe	255
Sewer & Drain PVC Pipe Fittings	255
Stainless Steel Water Pipe Fittings	252
Tuff-Tite Channel Floor Drain	256
Play Sand	244
Plywood	118
Polycarbonate Flat Sheet.....	82
Polycarbonate Screws	89
Pop Rivets	
Copper Pop Rivets	51
Stainless Steel Pop Rivets.....	51
Porch Flooring.....	182
Posts	115
Perma Column.....	115
Sturdi-Wall Drill Set Bracket.....	116
Sturdi-Wall Wet Set Bracket.....	116
Primers.....	159
PVC Panels	
Ag-Tuf	81
Ag-Tuf UV.....	81
EZ-Grip Screws	86
FRP/Glassboard	83



Klar® PVC Panel	86
PVC Pipe Primer and Cement	254
PVC Trim Board	
PVC Bendable Brick Mould.....	147
PVC Trim Boards.....	148
Python Vent.....	69

Q

Quickstick	133
Quikrete.....	244

R

Raised Panel Shutters.....	139
Replacement Blades - Malco.....	32
Rexwrap Plus House Wrap.....	107
Rib Runner Metal Roofing And Siding Tool.....	37
Ridge Vents	
GAF® Cobra® Roof Ridge Exhaust Vent.....	98
Owens Corning® Heat & Moisture Ridge Vent.....	98
Roof Boot	
Covent Exhaust Fan.....	64
Extreme Angle Roof Boot	65
Lifetime Ultimate Pipe Flashing	66
Nevercaulk Residential Roof Flashing.....	66, 97
Oatey Roof Flashing	66, 97
Perma-Boot® Roof Flashing - Retrofit	97
Pipe Boot for Rubber Roofing.....	103
Retrofit Round Roof Boot	64
Retrofit Square Roof Boot.....	65
Round Roof Boot	62
Square Roof Boot	63
Roof Saver Cobra Vent.....	96
Round Keyhole Track	222
R Panel - 26 Gauge Textured AZ50 Galvalume	13
Rubber Horse Stall Mat.....	186
Rubber Roofing	
Adhesive.....	102
Black Neoprene Roof Cement	102
Black Rubber Roofing - Weatherbond.....	100
Chip Brush.....	103
Cleaners.....	102
Corner Flashing	101
Cover Tape.....	101
Drain Insert.....	103
Drain Insert - Enpoco-Pak.....	103
Fiberboard - Rubber Roofing Insulation.....	105
Flashing Tape	101
Insulation Fasteners.....	105
Insulation Plates.....	105
Pipe Boot.....	103
Plastic Strainer	103
Primer.....	102
Reinforced Strip.....	101
Roller Covers	104
Roller Handles	104
Rollers and Covers.....	104
Scouring Pad	104
Sealants.....	102
Seam Tape.....	101
Trims.....	100

S

S-5!® Clamps	
GripperFix Strut	283

S-5!® CorruBracket™	284
S-5!® VersaBracket-47™ and VersaBracket-67™	284
S-5-B	284
S-5-E	284
S-5-H.....	284
S-5-H90.....	285
S-5-K Grip.....	285
S-5-K Grip Inserts	285
S-5-N.....	285
S-5-N 1.5.....	285
S-5-PV Kit 2.0.....	283
S-5-S.....	286
S-5-U.....	286
S-5! ColorGard 2.0	
S-5!® ColorGard 2.0®	279
S-5!® ColorGard 2.0® Crossmember	279
S-5!® SnoClip 2.0.....	279
S-5!® VersaClip 2.0™	279
Schedule 40 PVC DWV Pipe.....	253
Sealant	
2300 Construction Tripolymer Sealant.....	53
2310 Tripolymer Brushable Repair Coating.....	53
2315LRF Leak Repair-Fibered Brushable Coating..	54
2320 Construction Tripolymer Seam Sealant.....	54
4500 Roof Bonding Sealant.....	55
8150 100% Silicone Neutral Cure	55
8150 Skylight Caulk	89
Concrete and Masonry Sealer	247
DryLok Masonry Waterproofer	247
Lexel	58
NovaFlex.....	56
QUAD	60
Quad MAX.....	60
RP-400® Plastic Wet-Dry Surface Roof Cement ...	58
Rubber Roofing Sealants	102
Sealant Tape	59
Superbond High Strength Adhesive.....	277
Through The Roof	59
Sealant Tape	59
Seamers	
Folding Tool - Midwest	36
Folding Tool - Wiss	36
Hand Seamers - Malco	36
Seamer and Tongs - Malco.....	36
Secondary Handrail - 1-1/2" White Aluminum	179
Sewer & Drain PVC Pipe.....	255
Shears	
Milwaukee Nibbler and Shears.....	33
Power Shears - Malco.....	31
Shears, Panel	
Ag Panel Shear	40
Ag Panel Shear with Detachable Blades	
Special Order	40
Replacement Blades.....	40
Shingles	
Lifetime Ultimate Pipe Flashing	97
Owens Corning® Duration® ProEdge®	
Hip and Ridge Cap Shingles	95
Owens Corning® Duration® Shingles	94
Owens Corning® Duration®	
Starter Strip Shingles	95
Tamko® Heritage Lifetime Laminated Shingles....	92, 96
Shutters	
Raised Panel Shutters	139
Siding	
Boral Versetta Stone.....	140
Georgia Pacific® Shadow Ridge - Vinyl	137
LP SmartSide Siding	136

Royal® Celect - Cellular Composite Siding.....	141
Skylights & Sidelights	
1-1/4" Corrugated Skylight	89
5V Crimp Skylight	89
8150 Skylight Caulk	89
ABM Profile Skylight	88
ABM Skylight Ridgecap	88
Everdrain Skylight	88
Multi-Wall	90
PBR Skylight	89
Polycarbonate Screws	89
Sunsky® Skylights	88
Sliding Door	
Aluminum Split Slider Dutch Door - Special Order .	191
Black Non-Adjustable Door Stop	190
Black Track and Trolley Systems.....	190
Flat Track Accessories - Exterior or Interior	190
Flat Track Rails - Exterior or Interior	190
Flat Track Trolleys - Exterior or Interior	190
Guide Pin	190
Sliding Door, Round	
201 Bottom Rail.....	229
235 Steel Girt (Horizontal).....	229
391 Big Side Rail.....	228
394 Big Bottom Rail.....	228
Adjustable Door Guide/Stop.....	226
Adjustable Door Stop.....	224
Big Guide Rail	228
Big Side Connector Rail	228
Bottom Guide Rail.....	227
Bottom Rail for Guide	227
Center Door Guide	226
Chain Snigger	225
Door Pull	225
Door Seals	226
Double Truck Trolleys	222
End Cap	224
Face Mount Brackets.....	223
Floor Mount Door Guide/Stop	226
Jamb Mount Door Stop	224
Latches	225
Non Adjustable Door Stop	224
Pendant Bolt Trolleys.....	222
Round Keyhole Track	222
Side Connector Rail	227
Side Rail.....	227
Splice Collar.....	224
Stay Roller.....	226
Strap Trolleys.....	222
Universal Bolt Bracket & Adapters.....	223
Universal Brackets	223
Universal Double Bracket.....	223
Sliding Door, Square	
Adjustable Square Track Trolleys	233
Square Track.....	233
Square Track Bolt Trolleys.....	233
Square Track Brackets.....	233
Square Track Double Brackets.....	233
Snap Lock Punch - Malco	32
Snap-Z.....	73
Snips	
18 Gauge Cutting Snips - Milwaukee.....	35
24 Gauge Cutting Snips - Milwaukee.....	35
Andy Snips - Malco.....	31
Aviation Snips - Malco.....	30, 33
Aviation Snips - Milwaukee.....	35
Aviation Snips - Wiss	34



Cutting Snips - Milwaukee.....	35
Mag Snips - Midwest.....	33
MAX Offset Snips - Malco.....	31
MAX Snips - Malco.....	30
Mini Aviation Snips - Malco.....	30
Offset Snips - Midwest.....	33
Offset Snips - Wiss.....	34
Tinners - Milwaukee.....	34
Snow Defender™ 4500 Snow Guard.....	278
Snow Defender™ 6500 Snow Guard.....	278
Snow Defender™ 7500 DECO Snow Guard.....	278
Snow Defender™ Plastic Snow Guards.....	278
Snow Retention	
Berger #2 Snow Guard.....	277
Berger #100 Snow Guard.....	277
Berger AP-400 Snow Guard.....	277
Berger RT-300 Snow Guard.....	277
S-5!® ColorGard 2.0®.....	279
S-5!® ColorGard 2.0® Crossmember.....	279
S-5!® SnoClip 2.0.....	279
S-5!® VersaClip 2.0™.....	279
Snow Defender™ 4500 Snow Guard.....	278
Snow Defender™ 6500 Snow Guard.....	278
Snow Defender™ 7500 DECO Snow Guard.....	278
Snow Defender™ Plastic Snow Guards.....	278
Superbond High Strength Adhesive.....	277
Soffit.....	29, 75
Aluminum Soffit.....	138
Painted Steel Soffit.....	29, 75
Stain.....	157
Outlast Q8 Log Oil Wood Preservative.....	161
Stainless Steel Pop Rivets.....	51
Stainless Steel Trim Nails.....	50
Stainless Steel Zip Screws.....	50
Stair Treads.....	117
SteelBinder.....	45
Steel Dutch Door.....	191
Steel Louvers.....	74
Step Flashing.....	96
Structural Screws	
Big Timber Construction Screws.....	169
Exterior Structural Screw.....	167
GRK Structural Screws.....	163
Headlok Flathead Screws - FastenMaster.....	165
LedgerLOK Screws - FastenMaster.....	164
Structural Truss Screw.....	168
ThruLOK Fastening System - FastenMaster.....	165
TimberLOK Heavy-Duty Screws - FastenMaster.....	164
Sturdi-Wall Drill Set Bracket.....	116
Sturdi-Wall Wet Set Bracket.....	116
Sunsky® Skylights.....	88

T

Tamko® Heritage Lifetime Laminated Shingles.....	92, 96
Tan Deck Screws - PrimeGuard Plus.....	168
T&G KDAT Porch Flooring.....	182
Through The Roof.....	59
ThruLOK Fastening System - FastenMaster.....	165
Tiger Claw Hidden Deck Fastener.....	182
Tiger Claw Pneumatic Gun.....	182
Tiger Claw Pneumatic Screws.....	182
TimberLOK Heavy-Duty Screws - FastenMaster.....	164
Timbertech® Reserve Composite Deck Board.....	173
Tinners - Milwaukee.....	34
Titen Heavy-Duty Concrete Anchor.....	166
Tools	

Camo Drive Deck Fastening Tool Attachment.....	182
Hand Pop Riveter.....	51
M12 Rivet Tool.....	51
Tiger Claw Pneumatic Gun.....	182
Touch Up Paint.....	29
Track.....	221
Treated Solid Sawed Post.....	115
Treated Wood Balusters.....	117, 181
TrimCutter.....	38
Trim Moulding	
Base Shoe - WM 127.....	146
Base Trim Moulding - LWM 163E.....	145
Base Trim Moulding - WM 623.....	145
Base Trim Moulding - WM 663.....	145
Casing - WM 376.....	145
Casing - WM 445.....	145
Chair Rail Moulding - WM 390.....	146
Cove Moulding - WM 100.....	146
Crown Moulding - LWM 49.....	146
Hand Rail - WM 240.....	147
Primed Finger-Jointed Pine Trim Boards.....	147
PVC Trim Boards.....	148
Quarter Round - WM 106.....	146
Trim Nails	
Stainless Steel Trim Nails.....	50
Trim Screws	
Big Timber Construction Screws.....	169
Trusscore	
TRUSSCORE PVC Wall&CeilingBoard.....	78
Trusscore SlatWall.....	80
Trusscore SlatWall.....	80
Trusses.....	120
Tuff-Tite Channel Floor Drain.....	256
Tyvek® Flashing Tape.....	109
Tyvek® FlexWrap Flashing Tape.....	109
Tyvek® House Wrap.....	107
Tyvek® Protec™ 120.....	108
Tyvek® Protec™ 160.....	108
Tyvek® StuccoWrap®.....	107

U

Ultra Vent.....	68
Underlayment	
Elephant Skin Synthetic Roofing Underlayment.....	108
GAF® FeltBuster® Roofing Underlayment.....	110
Henry Eveguard Shingle Underlayment.....	108
Ice & Water Protector Underlayment.....	107
Owens Corning® ProArmor®.....	
Synthetic Roofing Underlayment.....	110
Rexwrap Plus House Wrap.....	107
Tyvek® House Wrap.....	107
Tyvek® Protec™ 120.....	108
Tyvek® Protec™ 160.....	108
Tyvek® StuccoWrap®.....	107
Warrior Felt Paper.....	107

V

Valspar.....	158
Vanmark.....	38
Angle and Trim Cutter Guide.....	39
Coil Cradle and Dispenser.....	39
Industrial Metal Master Brake.....	38
Leg Kit.....	39
Metal Master Brake.....	38
Trim-A-Brake II.....	38

TrimCutter.....	38
TrimMaster Mark II.....	38
UniLeg.....	39
UniStand.....	39
Wheel Kit.....	39
Ventilation	
AB35 Ridge Vent.....	72
Lomanco Lo-Omnirroll Shingle Vent.....	96
Perform Vent.....	69
Python Vent.....	69
Roof Saver Cobra Vent.....	96
Snap-Z.....	73
Steel Louvers.....	74
Ultra Vent.....	68
Vinyl Louvers.....	137
Z-Closure.....	73
Versetta Stone.....	140
Vinyl Louvers.....	137
Vinyl Railing - 200 Series.....	179
Vinyl Railing - 3000 Series.....	176
Vinyl Railing - 3000 Series York.....	177, 179
Vinyl Siding	
Georgia Pacific® Shadow Ridge - Vinyl.....	137
Vinyl Soffit.....	138

W

Warrior Felt Paper.....	107
Weatherbond.....	100
Weathervanes.....	194
Clutch Base.....	198
Flat Base.....	198
Flat Base for Copper Weathervanes.....	198
Replacement Directionals.....	198
Wedge Anchor - Galvanized.....	166
Wedge Anchor - Stainless.....	166
Wedge Anchor - Zinc.....	167
Wheel Kit, Vanmark.....	39
White Eclipse Pan Head Screw.....	49
Windows	
3500 Single-Hung Vinyl Window.....	201
3580 Single Side-Slider Vinyl Window.....	201
Double-Hung Vinyl Window.....	202
Non-Insulated Single-Hung Aluminum Window.....	202
Window Wrap Flashing Tape.....	109
WoodBinder.....	42
#14 WoodBinder Nail-Replacement.....	47
OSB WoodBinder.....	44
WoodBinder.....	42
ZXL WoodBinder.....	43
Wood Dutch Door.....	191

Z

Z-Closures	
Snap-Z.....	73
Z-Closure.....	73
ZIP System (Huber)	
ZIP System™ Flashing Tape Roller.....	109, 119
ZIP System Stretch Tape.....	109, 119
ZXL WoodBinder.....	43







Ask About our House Takeoff Service!

POWERED BY



CONSTRUCTION TECHNOLOGIES



WE BRING THE **HARDWARE**



FAST LOCAL DELIVERY
FOR EVERY BUILD

**ORDER
TODAY!**

35 Ridge Road,
Newville, PA 17241
cumberlandsupply.com

M-F: 6:30 AM - 5:00 PM
Sat: 7:00 AM - Noon
Closed Sundays

717-776-5951
Fax: 717-776-0112