

# SS396.COM

A GROUND UP MOTORS COMPANY

**VOL 23A**

CELEBRATING  
**30+**  
YEARS



# Chevvelle

**& El Camino PARTS & ACCESSORIES  
CATALOG**

1964-1989

2023

## We Get It Cause We've Been There Before.

At SS396.com we help with the project, not just the part. Whether you shop online or over the phone you can be confident that our team is devoted to keeping your classic American muscle running and looking its best. With over 30 completed Ground Up restorations under our belt, we don't just sell our parts we use them. That's why we stand behind our products as being the best quality detailing and restoration parts.

**GROUND UP** | A proud part of the Ground Up Motors  
**MOTORS** family of brands

### Why shop with us?

#### Help with the project, not just the part.

With thousands of parts in stock and ready to ship, we'll help find the right one.

#### Everyday Super Savings!

We're here to help you save with free shipping or 10% Off available all year and exclusive kits and bundles to save you time & money.

#### Fast Shipping & Satisfaction Guarantee

Most orders are packed, shipped, and delivered within 3 days from Miami to New York and as far West as Colorado and Texas. If you are not satisfied with your purchase you can return it for an exchange or refund.

66 **Helping Restore  
Classic American  
Muscle Since 1990.** 99



# SS396.COM

A GROUND UP MOTORS COMPANY

## Table of Contents

INTERIOR PARTS & TRIM ..... 2-51	HEATING & COOLING ..... 119-129	LIGHTING..... 222-230
STEREO & SPEAKERS ..... 52-55	ENGINE PARTS ..... 130-152	LOCKS..... 231-232
CONVERTIBLE TOP ..... 56-58	ENGINE COMPARTMENT..... 153-158	EMBLEMS..... 233-236
TRUNK..... 59	HARDWARE..... 159-168	STENCILS & STRIPES ..... 237
WHEELS & TIRES..... 60-63	EXTERIOR PARTS & TRIM ..... 169-184	DECALS & PAINT ..... 238-240
BRAKES..... 64-75	SHEETMETAL & RELATED ..... 185-204	BOOKS & MANUALS..... 241
STEERING & SUSPENSION ..... 76-97	GLASS ..... 205-207	INDEX..... 242-245
TRANSMISSION ..... 98-109	WEATHERSTRIP ..... 208-211	ORDER FORMS & POLICIES... 246-248
FUEL & EXHAUST ..... 110-118	ELECTRICAL ..... 211-221	

Keep a look out for these logos below throughout the catalog



Take the hassle out of finding the parts you need. Buy & save time with pre-built kits.



These Exclusive products will only be found at ss396.com

### Follow us on Social Media



Facebook.com/grounduprestoration  
 Instagram.com/groundupss396  
 Twitter.com/groundupresto  
 Youtube.com/groundupresto

## TRUSTED BRANDS WE CARRY



**THE ALL NEW**  
**SS396.COM**  
 A GROUND UP MOTORS COMPANY

**CHECK IT OUT TODAY!**  
**SS396.COM**

Call Us: U.S. & Canada: (866) 358-2277 • International: (203)-235-1200

Call Center Hours (ET): Monday-Thursday: 9am-6pm • Friday: 9am-3pm • Saturday: 9am-1pm

Shop Online 24/7: www.ss396.com • Chat Online: During Business Hours



**ADDICTIVE FLOW**  
A GROUND UP COMPANY



PTS-A70F



PTS-A70F-CRB



**1970-72 Chevelle Pro Touring Front Spoiler Kit**

This front spoiler is just what your pro-touring or resto-mod Chevelle is missing. Brand new to the market & a Ground Up Motor Sports Exclusive, these spoilers are easy on the wallet, easier to install, and designed with enthusiasts in mind. This front spoiler kit includes the 1970-1972 Chevelle front spoiler, mounting hardware for a complete upgrade or replacement, and a detailed set of installation instructions.

**Fitment:**

This 1970-72 Chevelle front spoiler features a simple bolt-on application that only requires slight adjustment to the car's original structure.

**Durable:** Unlike some of the other spoilers on the market, Addictive Flow spoilers are made from a durable polyurethane material (similar to the material used for reproduction spoilers) that is forgiving on both the spoiler and the car. Worry no more about bottoming out and potentially damaging your beloved classic.

**Customizable:**

Designed with Pro-Touring & Resto-mod enthusiasts in mind! If you want to color key your new spoiler to your car, it's as simple as prepping the surface and spraying on the color of your choice.

**Easy Installation:** Addictive Flow spoilers have been thoroughly tested and streamlined for bolt-on application. All components and instructions are included to make installation a breeze.

**Affordable:**

Addictive Flow worked directly with the manufacturer to reduce costs where possible. Because of this, we can pass those savings on to our customers and supply a great looking and affordable front spoiler for your American classic

PTS-A70F	1970-72 Front Spoiler "Flat Black Look" .....	139.99 kit
PTS-A70F-CRB	1970-72 Front Spoiler "Carbon Fiber Look" .....	199.99 kit

### Super Interior Kits (BLACK ONLY)

If your interior is destroyed then our Super Interior Kit is a no brainer! This kit is much more complete than the junior kit and is perfect when most of your interior is wrecked or missing! We use "Out of the Box" PUI door panels and PUI seat covers in our kits!



SUKIT-64



SUKIT-68V



SUKIT-E70

### Chevelle Coupe Super Interior Kits

		Bench	Bucket
SUKIT-64	1964.....	1578.42 kit.....	1578.42 kit
SUKIT-65	1965.....	1391.43 kit.....	1391.43 kit
SUKIT-66	1966.....	1380.82 kit.....	1380.82 kit
SUKIT-67	1967.....	1366.57 kit.....	1366.57 kit
SUKIT-68	1968.....	1700.05 kit.....	1700.05 kit
SUKIT-69	1969.....	1785.55 kit.....	1785.55 kit
SUKIT-70	1970.....	1785.55 kit.....	1785.55 kit
SUKIT-71	1971-72.....	1676.80 kit.....	1676.80 kit

\*1968-72 bucket seats only. \*\*1964-67 only.  
\*\*\*Some rear panels are not available pre-assembled.

### Chevelle Convertible Super Interior Kits

		Bench	Bucket
SUKIT-64V	1964.....	1561.52 kit.....	1561.52 kit
SUKIT-65V	1965.....	1197.09 kit.....	1197.09 kit
SUKIT-66V	1966.....	1308.67 kit.....	1308.67 kit
SUKIT-67V	1967.....	1303.92 kit.....	1303.92 kit
SUKIT-68V	1968.....	1757.21 kit.....	1757.21 kit
SUKIT-69V	1969.....	1821.31 kit.....	1821.31 kit
SUKIT-70V	1970.....	1821.31 kit.....	1821.31 kit
SUKIT-71V	1971-72.....	1721.56 kit.....	1721.56 kit

\*1968-72 bucket seats only. \*\*Some rear panels are not available pre-assembled.

### El Camino Super Interior Kits

		Bench	Bucket
SUKIT-E64	1964.....	1118.18 kit.....	1118.18 kit
SUKIT-E65	1965.....	975.68 kit.....	975.68 kit
SUKIT-E66	1966.....	968.53 kit.....	968.53 kit
SUKIT-E67	1967.....	975.68 kit.....	975.68 kit
SUKIT-E68	1968.....	1230.82 kit.....	1230.82 kit
SUKIT-E69	1969.....	1287.82 kit.....	1287.82 kit
SUKIT-E70	1970.....	1287.82 kit.....	1287.82 kit
SUKIT-E71	1971-72.....	1221.32 kit.....	1221.32 kit

\*1968-72 bucket seats only. No Volume Discount. All interior kits ship in multiple Oversize 2 boxes. Not eligible for free shipping.

### Junior Interior Kits (BLACK ONLY)

These interior kits are a great way to freshen up your ride! These kits feature "out of the box" pre-assembled door panels. This means ready to install with moldings and window felts where applicable.



JIKIT-70B



JIKIT-65V



JIKIT-65LB

### Chevelle Junior Coupe Interior Kits

JIKIT-64	1964 Buckets Black.....	1224.04 kit
JIKIT-64B	1964 Bench Black.....	1224.04 kit
JIKIT-65	1965 Buckets Black.....	1024.54 kit
JIKIT-65B	1965 Bench Black.....	1024.54 kit
JIKIT-66	1966 Buckets Black.....	1026.44 kit
JIKIT-66B	1966 Bench Black.....	1026.44 kit
JIKIT-67	1967 Buckets Black.....	1012.19 kit
JIKIT-67B	1967 Bench Black.....	1012.19 kit
JIKIT-68	1968 Buckets Black.....	1209.79 kit
JIKIT-68B	1968 Bench Black.....	1209.79 kit
JIKIT-69	1969 Buckets Black.....	1295.29 kit
JIKIT-69B	1969 Bench Black.....	1295.29 kit
JIKIT-70	1970 Buckets Black.....	1295.29 kit
JIKIT-70B	1970 Bench Black.....	1295.29 kit
JIKIT-71	1971-72 Buckets Black.....	1195.54 kit
JIKIT-71B	1971-72 Bench Black.....	1195.54 kit

\*Some rear panels are not available pre-assembled.

### Chevelle Junior Convertible Interior Kits

JIKIT-64V	1964 Buckets Black.....	1192.69 kit
JIKIT-64VB	1964 Bench Black.....	1192.69 kit
JIKIT-65V	1965 Buckets Black.....	955.19 kit
JIKIT-65VB	1965 Bench Black.....	955.19 kit
JIKIT-66V	1966 Buckets Black.....	955.19 kit
JIKIT-66VB	1966 Bench Black.....	955.19 kit
JIKIT-67V	1967 Buckets Black.....	950.44 kit
JIKIT-67VB	1967 Bench Black.....	950.44 kit
JIKIT-68V	1968 Buckets Black.....	1209.34 kit
JIKIT-68VB	1968 Bench Black.....	1209.34 kit
JIKIT-69V	1969 Buckets Black.....	1273.44 kit
JIKIT-69VB	1969 Bench Black.....	1273.44 kit
JIKIT-70V	1970 Buckets Black.....	1273.44 kit
JIKIT-70VB	1970 Bench Black.....	1273.44 kit
JIKIT-71V	1971-72 Buckets Black.....	1173.69 kit
JIKIT-71VB	1971-72 Bench Black.....	1173.69 kit

\*Some rear panels are not available pre-assembled.

### El Camino Junior Interior Kits

JIKIT-64L	1964 Buckets Black.....	893.46 kit
JIKIT-64LB	1964 Bench Black.....	893.46 kit
JIKIT-65L	1965 Buckets Black.....	750.96 kit
JIKIT-65LB	1965 Bench Black.....	750.96 kit
JIKIT-66L	1966 Buckets Black.....	750.96 kit
JIKIT-66LB	1966 Bench Black.....	750.96 kit
JIKIT-67L	1967 Buckets Black.....	750.96 kit
JIKIT-67LB	1967 Bench Black.....	750.96 kit
JIKIT-68L	1968 Buckets Black.....	826.96 kit
JIKIT-68LB	1968 Bench Black.....	826.96 kit
JIKIT-69L	1969 Buckets Black.....	883.96 kit
JIKIT-69LB	1969 Bench Black.....	883.96 kit
JIKIT-70L	1970 Buckets Black.....	883.96 kit
JIKIT-70LB	1970 Bench Black.....	883.96 kit
JIKIT-71L	1971-72 Buckets Black.....	817.46 kit
JIKIT-71LB	1971-72 Bench Black.....	817.46 kit

No Volume Discount. All interior kits ship in multiple Oversize 2 boxes. Not eligible for free shipping.

**PUI Seat Covers**

PUI seat covers are constructed of the finest quality materials and feature the best craftsmanship ensuring a perfect replacement for your damaged originals. These seat covers feature the correct grains and materials as original and are perfect for all cars from daily drivers to trailer queens. All factory colors are available.



IUP-A64

**1964 Chevelle / El Camino**

Seville grain vinyl with dielectrically sealed pleats. Includes authentic medallion sealed in rear seats. Buy the complete set of front and rear and save 10%!

**Black**

IUP-A64	Front Buckets.....	429.99 set
IUP-A64B	Front Bench.....	429.99 set
IUP-A64R	Rear Coupe.....	229.99 set
IUP-A64RV	Rear Convertible.....	229.99 set
IUP-A64K	Complete Kit Coupe w/ Buckets.....	626.98 kit
IUP-A64KB	Complete Kit Coupe w/ Bench.....	626.98 kit
IUP-A64KV	Complete Kit Convertible w/ Buckets.....	626.98 kit
IUP-A64KVB	Complete Kit Convertible w/ Bench....	626.98 kit

**Colors**

Fill in color code below.

IUP-A64AS_U	Front Buckets.....	456.99 set
IUP-A64AS_B	Front Bench.....	456.99 set
IUP-A64AS_C	Rear Coupe.....	249.99 set
IUP-A64AS_V	Rear Convertible.....	249.99 set

• Aqua (50) • Light Blue (56) • Light Fawn (58)  
• Red (64) • Saddle (65) • White (69)



IUP-A65

**1965 Chevelle / El Camino**

Madrid grain vinyl with horizontal sewn lines in insert. Buy the complete set of front and rear and save 10%!

**Black**

IUP-A65	Front Buckets.....	279.99 set
IUP-A65B	Front Bench.....	279.99 set
IUP-A65R	Rear Coupe.....	169.99 set
IUP-A65RV	Rear Convertible.....	169.99 set
IUP-A65K	Complete Kit Coupe w/ Buckets.....	427.48 kit
IUP-A65KB	Complete Kit Coupe w/ Bench.....	427.48 kit
IUP-A65KV	Complete Kit Convertible w/ Buckets...	427.48 kit
IUP-A65KVB	Complete Kit Convertible w/ Bench.....	427.48 kit

**Colors**

Fill in color code below.

IUP-A65AS_U	Front Buckets.....	282.99 pr.
IUP-A65AS_B	Front Bench.....	282.99 pr.
IUP-A65AS_C	Rear Coupe.....	164.99 pr.
IUP-A65AS_V	Rear Convertible.....	164.99 pr.

• Aqua (02) • 2 Tone Aqua (05) • Light Blue (12) • 2 Tone Blue (13)  
• 2 Tone Fawn (21) • Fawn (22) • Red (30) • 2 Tone Red (33)  
• Light Saddle (35) • White (37) • Slate (44)



IUP-A66

**1966 Chevelle / El Camino**

Madrid grain vinyl with sewn vertical pleats. Buy the complete set of front and rear and save 10%!

**Black**

IUP-A66	Front Buckets.....	279.99 set
IUP-A66B	Front Bench.....	279.99 set
IUP-A66R	Rear Coupe.....	169.99 set
IUP-A66RS	Rear 2 Door Sedan.....	164.99 set
IUP-A66RV	Rear Convertible.....	169.99 set
IUP-A66K	Complete Kit Coupe w/ Buckets.....	427.48 kit
IUP-A66KB	Complete Kit Coupe w/ Bench.....	427.48 kit
IUP-A66KV	Complete Kit Convertible w/ Buckets.....	427.48 kit
IUP-A66KVB	Complete Kit Convertible w/ Bench....	427.48 kit

**Colors**

Fill in color code below.

IUP-A66AS_U	Front Buckets.....	334.99 set
IUP-A66AS_B	Front Bench.....	282.99 set
IUP-A66AS_C	Rear Coupe.....	194.99 set
IUP-A66AS_S	Rear 2 Door Sedan.....	114.95 set
IUP-A66AS_V	Rear Convertible.....	164.99 set

• Aqua (02) • 2 Tone Aqua (05) • Light Blue (12)  
• 2 Tone Blue (13) • Bright Blue (14) • Bronze (20)  
• 2 Tone Fawn (21) • Fawn (22) • Red (30) • White (37)



IUP-A67

**1967 Chevelle / El Camino**

Madrid grain vinyl with sewn horizontal pleats. Buy the complete set of front and rear and save 10%!

**Black**

IUP-A67	Front Buckets.....	279.99 set
IUP-A67B	Front Bench.....	279.99 set
IUP-A67R	Rear Coupe.....	169.99 set
IUP-A67RS	Rear 2 Door Sedan.....	164.99 set
IUP-A67RV	Rear Convertible.....	164.99 set
IUP-A67K	Complete Kit Coupe w/ Buckets.....	427.48 kit
IUP-A67KB	Complete Kit Coupe w/ Bench.....	427.48 kit
IUP-A67KV	Complete Kit Convertible w/ Buckets.....	422.73 kit
IUP-A67KVB	Complete Kit Convertible w/ Bench.....	422.73 kit

**Colors**

Fill in color code below.

IUP-A67AS_U	Front Buckets.....	334.99 set
IUP-A67AS_B	Front Bench.....	282.99 set
IUP-A67AS_C	Rear Coupe.....	194.99 set
IUP-A67AS_S	Rear 2 Door Sedan.....	114.95 set
IUP-A67AS_V	Rear Convertible.....	164.99 set

• Aqua (02) • Light Blue (12) • Bright Blue (14)  
• Red (30) • White (37) • Gold (43)



IUP-A68B

**1968 Chevelle / El Camino**

Madrid grain vinyl with sewn vertical pleats. Buttons included. Buy the complete set of front and rear and save 10%!

Includes Seat Buttons.

**Black**

IUP-A68	Front Buckets.....	279.99 set
IUP-A68B	Front Bench.....	279.99 set
IUP-A68R	Rear Coupe.....	169.99 set
IUP-A68RS	Rear 2 Door Sedan.....	206.99 set
IUP-A68RV	Rear Convertible.....	169.99 set
IUP-A68K	Complete Kit Coupe w/ Buckets.....	427.48 kit
IUP-A68KB	Complete Kit Coupe w/ Bench.....	427.48 kit
IUP-A68KV	Complete Kit Convertible w/ Buckets.....	427.48 kit
IUP-A68KVB	Complete Kit Convertible w/ Bench....	427.48 kit

**Colors**

Fill in color code below.

IUP-A68AS_U	Front Buckets.....	282.99 set
IUP-A68AS_B	Front Bench.....	282.99 set
IUP-A68AS_C	Rear Coupe.....	164.99 set
IUP-A68AS_S	Rear 2 Door Sedan.....	206.99 set
IUP-A68AS_V	Rear Convertible.....	164.99 set

Light Blue (12) • 68 Blue (17) • Pearl (28) • Red (30) • Ivy Gold (46)



IUP-A69

**1969 Chevelle / El Camino**

Madrid grain vinyl with dielectrically sealed vertical lines and Basketweave design accent in center of inserts. Buttons included. Buy the complete set of front and rear and save 10%!

**Black**

IUP-A69	Front Buckets.....	339.99 set
IUP-A69B	Front Bench.....	339.99 set
IUP-A69R	Rear Coupe.....	199.99 set
IUP-A69RS	Rear 2 Door Sedan.....	182.99 set
IUP-A69RV	Rear Convertible.....	199.99 set
IUP-A69K	Complete Kit Coupe w/ Buckets.....	512.98 kit
IUP-A69KB	Complete Kit Coupe w/ Bench.....	512.98 kit
IUP-A69KV	Complete Kit Convertible w/ Buckets.....	512.98 kit
IUP-A69KVB	Complete Kit Convertible w/ Bench.....	512.98 kit

**Colors**

Fill in color code below.

IUP-A69AS_U	Front Buckets.....	348.99 set
IUP-A69AS_B	Front Bench.....	348.99 set
IUP-A69AS_C	Rear Coupe.....	193.99 set
IUP-A69AS_S	Rear 2 Door Sedan.....	134.95 set
IUP-A69AS_V	Rear Convertible.....	193.99 set

• Light Blue (12) • 68 Blue (17) • Pearl (28) • Red (30)  
• Ivy Gold (46) • Metallic Green (24)



IUP-A70

### 1970 Chevelle / El Camino

Madrid grain vinyl with twin Laredo grain vinyl dielectric stripes in insert. Seat emblems are included. Buy the complete set of front and rear and save 10%!

*Includes Seat Emblems*

#### Black

IUP-A70	Front Buckets.....	339.99 set
IUP-A70B	Front Bench.....	339.99 set
IUP-A70R	Rear Coupe.....	199.99 set
IUP-A70RV	Rear Convertible.....	199.99 set
IUP-A70K	Complete Kit Coupe w/ Buckets..	512.98 kit
IUP-A70KB	Complete Kit Coupe w/ Bench....	512.98 kit
IUP-A70KV	Complete Kit	
	Convertible w/ Buckets.....	512.98 kit
IUP-A70KVB	Complete Kit	
	Convertible w/ Bench.....	512.98 kit

#### Colors

Fill in color code below.

IUP-A70AS__U	Front Buckets.....	411.99 set
IUP-A70AS__B	Front Bench.....	411.99 set
IUP-A70AS__C	Rear Coupe.....	228.99 set
IUP-A70AS__V	Rear Convertible.....	228.99 set

• Bright Blue (14) • Dark Metallic Green (24) • Pearl (28)  
 • 70 Red (31) • 70 Saddle (36) • Gold (43)



### 1971-72 Chevelle / El Camino

IUP-A71

Madrid grain vinyl with sewn vertical pleats. Buttons included. Buy the complete set of front and rear and save 10%!

#### Black

IUP-A71	Front Buckets.....	269.99 set
IUP-A71B	Front Bench.....	269.99 set
IUP-A71R	Rear Coupe.....	164.99 set
IUP-A71RV	Rear Convertible.....	164.99 set
IUP-A71K	Complete Kit Coupe w/ Buckets.....	413.23 kit
IUP-A71KB	Complete Kit Coupe w/ Bench.....	413.23 kit
IUP-A71KV	Complete Kit Convertible w/ Buckets.....	413.23 kit
IUP-A71KVB	Complete Kit Convertible w/ Bench.....	413.23 kit

#### Colors

Fill in color code below.

IUP-A71AS__U	Front Buckets.....	334.99 pr.
IUP-A71AS__B	Front Bench.....	334.99 pr.
IUP-A71AS__C	Rear Coupe.....	194.99 pr.
IUP-A71AS__V	Rear Convertible.....	194.99 pr.

• 71-72 Blue (09) • 71 Jade Green (19) • 72 Dark Green (25)  
 • 71 Covert (29) • 72 White (37) • 72 Sandalwood (41)  
 • 71 Dark Saddle (42) • 72 Tan (47)



IST-1560

### Bucket Seat Tracks

Beautiful reproduction seat tracks.

IST-1560	1966-72 Driver Side.....	99.99 ea.
IST-1561	1966-72 Passenger Side.....	99.99 ea.
IST-15K	1966-72 Set LH/RH.....	169.98 set
IST-12655	Track to Seat Bolts (8 pc.).....	16.99 kit
BSM-516	Track to Floor Bolt.....	1.35 ea.
IBX-RELO	All (4 pc*).....	34.99 kit
ISE-662	1966-72 Track Extender LH.....	82.99 pr.

*\*Does one seat.*



BST-12655

### Seat Track to Seat Bolt

BST-12655	All (8 pc.).....	16.99 kit
-----------	------------------	-----------



BSM-REAR

### Rear Seat Back Mounting Hardware

Seat retainer bolts which keep the upper portion of the rear seat in place. These bolts feature a built-in washer and are black phosphate plated just like original.

BSM-REAR	1968-72 All.....	9.99 pr.
----------	------------------	----------



IBX-89K



ICC-001

### Bucket Seat Brackets

Choose from either universal weld-in bucket seat brackets or OE style reproductions of the original brackets.

IBX-64K	1964-65 Exact OE.....	42.99 kit
IBX-89K	1966-72 Exact OE.....	49.99 kit
IBX-89K-FR	OE Style Front & Rear.....	57.99 kit
ICC-001	1964-72 Universal (2 pc.).....	29.99 kit
IBX-RELO	All (4pc) Relocation Brackets.....	34.99 kit
ISE-662	1966-72 Track Extender LH.....	82.99 pr.



IAS-A69



IAS-A70



IAS-A71

### Pre-Assembled Bucket Seats

If you're thinking about having your original bucket seats reupholstered, consider these pre-assembled bucket seats from PUI instead! Seat backs, side covers and seat tracks are included. Just open the box and bolt them in. It's that simple. This saves hours of time and money over buying seat covers, foam and paying an interior shop a premium price to upholster your seats. Available in all factory PUI colors.

IAS-A69	1969 All.....	2885.99 pr.
IAS-A70	1970 All.....	2910.99 pr.
IAS-A71	1971-72 All.....	2885.99 pr.

*Headrests are not included. No Volume Discount. Ships in two oversize boxes. Not eligible for free shipping.*



ISE-662

**Bucket Seat Extenders**

Mounts to drivers side floor to offset seat tracks about two inches giving more leg room.

ISE-662 1966-72 Drivers Side..... 82.99 pr.

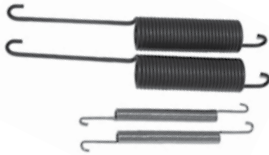

IZ-12815

**Seat Frame to Track Springs**

These springs go from the seat frames to the seat frames to provide tension to the adjustment bracket.

IZ-12814 1966-72 Bench (2 pc.).....11.99 kit  
IZ-12815 1966-72 Bucket (4 pc.) .....21.99 kit



ISA-668L

**Bucket Seat Frames**

Complete bucket seat frame assemblies with seat springs already installed!

ISA-668L 1966-68 LH.....439.99 ea.  
ISA-668R 1966-68 RH .....419.99 ea.  
ISA-669 1969-72 All .....419.99 ea.  
*No Volume Discount. Ships Oversize. Not eligible for free shipping.*

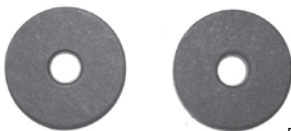

BSW-180070

**Bench Seat Washers**

These washers go between the seat and the hinge on all bench seat cars. It keeps the hinge from damaging the seat material.

BSW-180070 All.....3.99 pr.



IHG-7

**Seat Installation Kit**

Complete set of hog rings and pliers for seat cover installation.

IHG-7 All .....16.95 kit



ILA-1402B

**Seat Back Lock Assembly**

Complete seat back lock assembly including seat release button.

ILA-1402B 1969-72 .....119.99 ea.



IJ-6BKT

**Headrest Mounting Brackets**

Correct bracket set for adding the optional bucket seat headrests to your 1966-68 model.

IJ-6BKT 1966-68 Buckets.....99.99 set



IRG-1042C

**Headrest Guides**

Correct guides which headrest bars are inserted into on all Strato Bucket seats. Hardware and headrest locks included.

IRG-1042C 1966-72 .....79.14 set



ITC-4321B

**1966-72 Bucket Seat Headrest Trim**

This is the inner trim panel that mounts onto the bottom of the bucket seat headrest in the correct pebble grain.

ITC-4321B 1966-72 Buckets..... 32.99 pr.



ITW-3120

**Bucket Seat Headrests**

OE style reproduction injection molded headrests. Black only.

IJ-3780 1966-67 .....209.99 pr.  
ITW-3120 1969 .....164.99 pr.  
ITW-3775 1970-72 .....149.99 pr.



IJ-5214



IFC-521

**Seat Release Buttons**

IJ-5214 1967-68 Buckets.....39.99 ea.  
IFC-521 1969-72 Buckets.....19.99 ea.  
IFC-521K 1969-72 Buckets.....33.98 kit



ISS-5085

**Seatback Bumpers**

Correct rubber coated steel.

ISS-5085 1964-72 All .....8.95 pr.  
*Two pairs required per car.*

**KEEP A LOOK OUT FOR THESE LOGOS BELOW THROUGHOUT THE CATALOG FOR BIG SAVINGS AND DISCOUNTS ON KITS!**

**BUY'N SAVE WITH KITS**





**BUY'N SAVE**  
WITH KITS

**PUI** PARTS  
UNLIMITED  
INTERIORS



ISF-72-WIRE

**Seat Foams**

**OEM Style Foam With Listing Wire Buckets**

Correct density injection molded seat foam with molded-in listing wire. Each set contains one back and one bottom. The kits come with 2 sets of foams, enough for a pair of bucket seats.

ISF-65-WIRE	1964-65 Buckets 1 Back 1 Bottom.....	92.99 ea.
ISF-65-WIRE-KIT	1964-65 Buckets 2 Backs 2 Bottoms.....	167.38 kit
ISF-72-WIRE	1966-70 Buckets 1 Back 1 Bottom.....	119.99 ea.
ISF-72-WIRE-KIT	1966-70 Buckets 2 Backs 2 Bottoms.....	227.98 kit
ISF-737AU	1973-77 Swivel w/ Wires.....	226.99 ea.

**OEM Style Replacement Foam No Wire Buckets**

Replacement style correct density injection molded seat foam. Each set contains one back and one bottom. The kits come with 2 sets of foams, enough for a pair of bucket seats.

ISF-65	1964-65 Buckets 1 Back 1 Bottom.....	127.99 ea.
ISF-65K	1964-65 Buckets 2 Backs 2 Bottoms.....	230.38 kit
ISF-72	1966-70 Buckets 1 Back 1 Bottom.....	127.99 ea.
ISF-72K	1966-70 Buckets 2 Backs 2 Bottoms.....	243.18 kit
ISF-73	1971-72 Buckets 1 Back 1 Bottom.....	127.99 ea.
ISF-73K	1971-72 Buckets 2 Backs 2 Bottoms.....	230.38 kit

ISF-7888GU	1978-83 High Back.....	226.99 ea.
ISF-8488MU	1984-88 Low Back.....	226.99 ea.

**OEM Style Replacement Foam Bench Seat**

ISF-A64B	1964-65 Bench.....	247.99 ea.
ISF-A68B	1966-70 Bench.....	247.99 ea.
ISF-A71B	1971-72 Bench.....	247.99 ea.
ISF-68RR	1968-69 Rear Bench.....	349.99 pr.
ISF-72RR	1970-72 Rear Bench.....	299.99 pr.
ISF-BUNREAR	1964-77 Universal Bench Front or Rear.....	69.99 ea.

No Volume Discount. Ships Oversize. Not eligible for free shipping.

**TMI Sport & Sport R Series Seat Foam**

This TMI seat foam is made to work with your new TMI Sport Seat covers. This foam is bolstered providing modern car comfort and extra support. Made in the USA.

43-8284	1964-65 Bucket.....	144.99 ea.
43-8291	1964-70 Bench.....	335.99 set
43-8286	1966-72 Bucket.....	144.99 ea.
43-8296	1971-72 Bench.....	335.99 set



Note: Stock seat covers will NOT cover this TMI Sport Seat foam. No Volume Discount.



ICC-0259K

**Bucket Seat Chrome Kit**

This is a one step kit to replace all the chrome on your bucket seats. This kit includes the correct chrome piping, 12 end caps, 4 headrest locks and 2 seat back release buttons.

ICC-0259K	1970-72.....	134.95 kit
-----------	--------------	------------

**Molded OE Style Bucket Seat Trim Kit**

Correct OE style molded metal bucket seat trim. This kit features the thick clear plastic coating just like the originals. This kit comes with 2 seat back chrome moldings and 4 side moldings, enough for both seats!

ICC-0250-OE	1966-67 Buckets.....	99.99 kit
ICC-0259-OE	1968-72 Buckets.....	99.99 kit



**Bucket Seat Backs & Side Covers**

OE style reproductions with chrome edge piping.

**Complete Kits**

BACK-KITA606	1966 Black.....	199.99 kit
BACK-KITA616	1966 White.....	249.99 kit
BACK-KITA626	1966 Red.....	249.99 kit
BACK-KITA656	1966 Aqua.....	249.99 kit
BACK-KITA666	1966 Light Blue.....	249.99 kit
BACK-KITA676	1966 Bright Blue.....	249.99 kit
BACK-KITA6706	1967 Black.....	199.99 kit
BACK-KITA6716	1967 White.....	249.99 kit
BACK-KITA6726	1967 Red.....	249.99 kit
BACK-KITA6756	1967 Aqua.....	249.99 kit
BACK-KITA6766	1967 Light Blue.....	249.99 kit
BACK-KITA6776	1967 Bright Blue.....	249.99 kit
BACK-KITA6800	1968 Black.....	199.99 kit
BACK-KITA6801	1968 Red.....	249.99 kit
BACK-KITA6802	1968 Pearl.....	249.99 kit
BACK-KITA6803	1968 Light Blue.....	249.99 set
BACK-KITA6804	1968 Medium Blue.....	249.99 kit
BACK-KITA6910	1969-72 Black.....	199.99 kit
BACK-KITA6911	1969-72 Red.....	249.99 kit
BACK-KITA6912	1969-72 Dark Blue.....	249.99 kit
BACK-KITA6913	1969-72 Bright Blue.....	249.99 kit
BACK-KITA6914	1969-72 Parchment.....	249.99 kit
BACK-KITA6915	1969-72 Dark Green.....	249.99 kit
BACK-KITA6916	1969-72 Light Saddle.....	249.99 kit
BACK-KITA6917	1969-72 Dark Saddle.....	249.99 kit
BACK-KITA6918	1969-72 Sandalwood.....	249.99 kit
BACK-KITA6919	1969-72 White.....	249.99 kit
BACK-KITA6920	1969-72 Pearl.....	249.99 kit

No Volume Discount. Ships Oversize. Not eligible for free shipping.



**Headrest Locks**

Correct chrome plated headrest locks.

IJ-5426	1969.....	44.99 pr.
ICI-5263K	1970-72 (4 pc.).....	64.57 kit
ICI-5263	1970-72.....	18.99 ea.

**BUY'N SAVE**  
WITH KITS



BACK-HDP

**Bucket Seat Back and Side Mounting Hardware**

This 22 piece mounting kit provides all the correct hardware to mount the side and back plastics to the seats.

BACK-HDP	1966-72 Buckets.....	9.99 kit
----------	----------------------	----------



ICC-0259



ICC-0254

**Bucket Seat Trim**

Correct chrome piping kit for both seat backs and sides and chrome end caps.

ICC-0259	1966-72 Trim*	18.95 kit
ICC-0254	1966-72 Caps	1.99 ea.

\*For reproduction back and sides.



IT-134B

**1964-65 Bucket Seat Side Arm Covers**

This is a pair of correct bucket seat side arm covers finished in chrome. Does one bucket seat. Two sets required per car.

IT-134B	1964-65 Buckets	144.99 pr.
---------	-----------------	------------



IT-3890

**Side Hinge Covers**

New injection molded seat side covers.

IT-3890	1964-72 Bench	55.99 pr.
---------	---------------	-----------

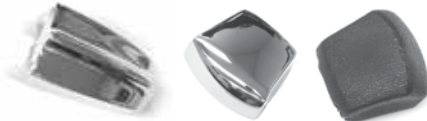

ICC-114

ICI-315

ICE-4636

**Seat Adjustment Knobs**

ICC-114	1964-65	19.99 ea.
ICC-66	1966 Chrome	18.99 ea.
ICI-315	1967-72 Chrome	8.99 ea.
ICE-4636	1967-72 Black	6.95 ea.



BRS-12659

**Seat Back Release Screws**

Correct screws to hold the folding seat back assembly in the seat back. This kit does 2 seat backs.

BRS-12659	1969-72 (8 pc.)	10.99 kit
-----------	-----------------	-----------



IJ-3553

ISE-3549

IJ-3552

**Seat Cover Emblems**

Correct seat cover emblems with backings.

IJ-3552	1966 All	29.99 set
IJ-3553	1967 All	49.99 set
ISE-3549	1970 All	22.99 set

IZ-204

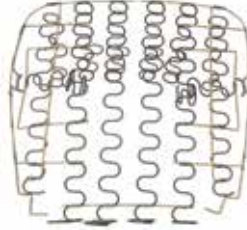

**Bucket Seat Springs**

Restore the comfort of your buckets with brand new springs!

IZ-204	1964-65 Bottom	89.99 ea.
IZ-205	1966-67 Bottom	89.99 ea.
IZ-206	1968-72 Bottom	89.99 ea.
IZ-207	1964-65 Back	89.99 ea.
IZ-208	1966-67 Back	89.99 ea.
IZ-210	1968 Back	89.99 ea.
IZ-209	1969-72 Back	89.99 ea.
IZ-101	1964-65 Side Supports	23.99 pr.
IZ-102	1966-67 Side Supports	34.99 pr.
IZ-103	1968-72 Side Supports	26.99 pr.

No Volume Discount. Ships Oversize. Not eligible for free shipping.

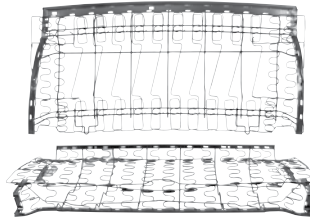

ISF-1402H

**Rear Seat Frames**

This is an OE style reproduction rear seat frame which includes the back and bottom, coupe only. This is a complete replacement for your worn out original springs.

ISF-1402H	1970-72	599.99 ea.
-----------	---------	------------

No Volume Discount. Ships Truck. Not eligible for free shipping.



ISB-260

**El Camino Storage Box**

Correct box for behind driver's seat.

ISB-260	1968-72 El Camino	129.99 ea.
CH329	1973-77 Foam Seal	16.99 ea.



IBR-732

**Shoulder Belt Retainers**

Correct roof mounted shoulder belt retainers.

IBR-732	1969-72 All	17.99 set
---------	-------------	-----------



ISB-67



ICV-4575

**Seat Belt Holders**

New seat belt holders which attach to console.

ISB-67	1968	21.99 pr.
ICV-4575	1970-72	49.99 ea.



ILG-73TGRN



ILG-73RGRN

**Seat Belt Loop Guides**

Choose from either triangle or rectangle style.

**Triangle**

ILG-73TBLK	1973-77 Black	10.99 ea.
ILG-73TBLU	1973-77 Blue	10.99 ea.
ILG-73TRED	1973-77 Red	10.99 ea.
ILG-73TTAN	1973-77 Tan	10.99 ea.
ILG-73TWTE	1973-77 White	10.99 ea.
ILG-73TGRN	1973-77 Green	10.99 ea.

**Rectangle**

ILG-73RBLK	1973-77 Black	10.99 ea.
ILG-73RBLU	1973-77 Blue	10.99 ea.
ILG-73RRED	1973-77 Red	10.99 ea.
ILG-73RTAN	1973-77 Tan	10.99 ea.
ILG-73RWTE	1973-77 White	10.99 ea.
ILG-73RGRN	1973-77 Green	10.99 ea.

**Tall Guides Buckets**

IBG-7242	1978-88 Blue	22.99 pr.
----------	--------------	-----------



ISR-1455

**Seat Belt Retractors**

Correct retractor mechanism for all early cars.

ISR-1455	1964-66 All	42.99 pr.
----------	-------------	-----------



IBR-6571

IBR-3200

**Seat Belt Retractor Covers**

Correct plastic covers available in black.

IBR-6571	1968-70	58.99 pr.
IBR-3200	1971-74 w/ Access Door	43.99 pr.
INL-15063	1967-72 Lap Belt Covers	28.99 pr.

BSB-561



BSB-56

**Seat Belt Bolts**

Correct shanked style seat belt bolts.

BSB-56	All Front Outer	6.99 ea.
BSB-56	1964-68 Front Inner	6.99 ea.
BSB-561	1969-72 Front Inner	6.99 ea.
BSB-561	All Rear	6.99 ea.
BSB-5-SBL	1964-77 All Fully Threaded	6.99 ea.



IGE-74R

**Shoulder Belt Guide Escutcheon**

Holds the shoulder belt retainer to the upper portion of the bucket seat back.

IGE-74L	1976-77 LH	9.99 ea.
IGE-74R	1976-77 RH	9.99 ea.



**Standard Style GM Logo Seat Belts**

OE style \*remanufactured seat belt set featuring correct retractor, seat belt and buckle assembly with GM emblem.

**Front Sets Lap**

SBL-CHEV68721000S	1968-72 Black.....	399.99 pr.
SBL-CHEV68722007S	1968-72 Red.....	461.99 pr.
SBL-CHEV68722006S	1968-72 Bright Red.....	461.99 pr.
SBL-CHEV68723008S	1968-72 Medium Saddle.....	461.99 pr.
SBL-CHEV68724003S	1968-72 Medium Blue....	461.99 pr.
SBL-CHEV68724004S	1968-72 Navy Blue.....	461.99 pr.
SBL-CHEV68725002S	1968-72 Dark Green.....	461.99 pr.

**Front & Rear Sets Lap**

SBL-CHEV6872FR1000S	1968-72 Black.....	599.99 kit
SBL-CHEV6872FR2007S	1968-72 Red.....	638.99 kit
SBL-CHEV6872FR2006S	1968-72 Bright Red.....	638.99 kit
SBL-CHEV6872FR3008S	1968-72 Medium Saddle.....	638.99 kit
SBL-CHEV6872FR4003S	1968-72 Medium Blue....	638.99 kit
SBL-CHEV6872FR4004S	1968-72 Navy Blue.....	638.99 kit
SBL-CHEV6872FR5002S	1968-72 Dark Green.....	638.99 kit

**Front & Rear Sets Lap & Shoulder**

SBL-CHEV6872KIT1000S	1968-72 Black.....	931.99 kit
SBL-CHEV6872KIT2007S	1968-72 Red.....	931.99 kit
SBL-CHEV6872KIT2006S	1968-72 Bright Red.....	931.99 kit
SBL-CHEV6872KIT3008S	1968-72 Medium Saddle.....	931.99 kit
SBL-CHEV6872KIT4003S	1968-72 Medium Blue....	931.99 kit
SBL-CHEV6872KIT4004S	1968-72 Navy Blue.....	931.99 kit
SBL-CHEV6872KIT5002S	1968-72 Dark Green.....	931.99 kit

**Front Shoulder Sets**

SBL-CHEV6872SH1000S	1968-72 Black.....	319.99 kit
SBL-CHEV6872SH2007S	1968-72 Red.....	319.99 pr.
SBL-CHEV6872SH2006S	1968-72 Bright Red.....	319.99 pr.
SBL-CHEV6872SH3008S	1968-72 Medium Saddle.....	319.99 pr.
SBL-CHEV6872SH4003S	1968-72 Medium Blue....	319.99 pr.
SBL-CHEV6872SH4004S	1968-72 Navy Blue.....	319.99 pr.
SBL-CHEV6872SH5002S	1968-72 Dark Green.....	319.99 pr.

No Volume Discount.

**Deluxe Style GM Logo Seat Belts w/ Large Buckle**

OE style \*remanufactured seat belt set featuring correct retractor, seat belt and large buckle assembly with GM emblem.

**Front Sets Lap**

SBL-CHEV68721000P	1968-72 Black.....	488.99 pr.
SBL-CHEV68722007P	1968-72 Red.....	488.99 pr.
SBL-CHEV68722006P	1968-72 Bright Red.....	488.99 pr.
SBL-CHEV68723008P	1968-72 Medium Saddle.....	488.99 pr.
SBL-CHEV68724003P	1968-72 Medium Blue.....	488.99 pr.
SBL-CHEV68724004P	1968-72 Navy Blue.....	488.99 pr.
SBL-CHEV68725002P	1968-72 Dark Green.....	488.99 pr.

**Front & Rear Sets Lap**

SBL-CHEV6872FR1000P	1968-72 Black.....	665.99 kit
SBL-CHEV6872FR2007P	1968-72 Red.....	665.99 kit
SBL-CHEV6872FR2006P	1968-72 Bright Red.....	665.99 kit
SBL-CHEV6872FR3008P	1968-72 Medium Saddle.....	665.99 kit
SBL-CHEV6872FR4003P	1968-72 Medium Blue.....	665.99 kit
SBL-CHEV6872FR4004P	1968-72 Navy Blue.....	665.99 kit
SBL-CHEV6872FR5002P	1968-72 Dark Green.....	665.99 kit

**Front & Rear Sets Lap & Shoulder**

SBL-CHEV6872KIT1000P	1968-72 Black.....	957.99 kit
SBL-CHEV6872KIT2007P	1968-72 Red.....	957.99 kit
SBL-CHEV6872KIT2006P	1968-72 Bright Red.....	957.99 kit
SBL-CHEV6872KIT3008P	1968-72 Medium Saddle.....	957.99 kit
SBL-CHEV6872KIT4003P	1968-72 Medium Blue.....	957.99 kit
SBL-CHEV6872KIT4004P	1968-72 Navy Blue.....	957.99 kit
SBL-CHEV6872KIT5002P	1968-72 Dark Green.....	957.99 kit

**Front Shoulder Sets**

SBL-CHEV6872SH1000P	1968-72 Black.....	346.99 kit
SBL-CHEV6872SH2007P	1968-72 Red.....	346.99 pr.
SBL-CHEV6872SH2006P	1968-72 Bright Red.....	346.99 pr.
SBL-CHEV6872SH3008P	1968-72 Medium Saddle.....	346.99 pr.
SBL-CHEV6872SH4003P	1968-72 Medium Blue.....	346.99 pr.
SBL-CHEV6872SH4004P	1968-72 Navy Blue.....	346.99 pr.
SBL-CHEV6872SH5002P	1968-72 Dark Green.....	346.99 pr.

No Volume Discount.

**Deluxe Style GM Logo Seat Belts w/ Small Buckle**

OE style \*remanufactured seat belt set featuring correct retractor, seat belt and small buckle assembly with GM emblem.

**Front Sets Lap**

SBL-1600GM1000	1968-72 Black.....	346.99 pr.
SBL-1600GM2007	1968-72 Red.....	346.99 pr.
SBL-1600GM4002	1968-72 Navy Blue.....	346.99 pr.
SBL-1600GM5002	1968-72 Dark Green.....	346.99 pr.

**Front & Rear Sets Lap**

SBL-1600GMFR1000	1968-72 Black.....	491.99 kit
SBL-1600GMFR2007	1968-72 Red.....	491.99 kit
SBL-1600GMFR4002	1968-72 Navy Blue.....	491.99 kit
SBL-1600GMFR5002	1968-72 Dark Green.....	491.99 kit

**Front & Rear Sets Lap & Shoulder**

SBL-1600GMKIT1000	1968-72 Black.....	714.99 kit
SBL-1600GMKIT2007	1968-72 Red.....	714.99 kit
SBL-1600GMKIT4002	1968-72 Navy Blue.....	714.99 kit
SBL-1600GMKIT5002	1968-72 Dark Green.....	714.99 kit

**Front Shoulder Sets**

SBL-1600GMSH1000	1968-72 Black.....	229.99 pr.
SBL-1600GMSH2007	1968-72 Red.....	229.99 pr.
SBL-1600GMSH4002	1968-72 Navy Blue.....	229.99 pr.
SBL-1600GMSH5002	1968-72 Dark Green.....	229.99 pr.

No Volume Discount.

\* Remanufactured. This means the product has been dismantled and reconstructed as necessary. All of its internal and external parts have been cleaned and made rust and corrosion-free. All impaired, defective, or substantially worn parts are restored to sound condition or replaced with new, "rebuilt" or "unimpaired" used parts. All missing parts are replaced with new, rebuilt, or unimpaired used parts.



SBL-1550SC1000S



SBL-1550SCKIT1000S

**Standard Style Stagecoach Logo Seat Belts**

OE style \*remanufactured seat belt set featuring correct retractor, seat belt and buckle assembly with Fisher stagecoach emblem.

**Front Sets Lap**

SBL-1550SC1000S	1964-67 Black.....	354.99 pr.
SBL-1550SC2007S	1964-67 Red.....	354.99 pr.
SBL-1550SC4002S	1964-67 Navy Blue.....	354.99 pr.
SBL-1550SC5002S	1964-67 Dark Green.....	354.99 pr.

**Front & Rear Sets Lap**

SBL-1550SCFR1000S	1964-67 Black.....	491.99 kit
SBL-1550SCFR2007S	1964-67 Red.....	491.99 kit
SBL-1550SCFR4002S	1964-67 Navy Blue.....	491.99 kit
SBL-1550SCFR5002S	1964-67 Dark Green.....	491.99 kit

**Front & Rear Sets Lap & Shoulder**

SBL-1550SCKIT1000S	1964-67 Black.....	716.99 kit
SBL-1550SCKIT2007S	1964-67 Red.....	716.99 kit
SBL-1550SCKIT4002S	1964-67 Navy Blue.....	716.99 kit
SBL-1550SCKIT5002S	1964-67 Dark Green.....	716.99 kit

**Front Shoulder Sets**

SBL-1550SCSH1000S	1964-67 Black.....	254.99 pr.
SBL-1550SCSH2007S	1964-67 Red.....	254.99 pr.
SBL-1550SCSH4002S	1964-67 Navy Blue.....	254.99 pr.
SBL-1550SCSH5002S	1964-67 Dark Green.....	254.99 pr.

No Volume Discount.



SBL-1650SC1000P



SBL-1650SCKIT1000P

**Deluxe Style Stagecoach Logo Seat Belts**

OE style \*remanufactured seat belt set featuring correct retractor, seat belt and buckle assembly with Fisher stagecoach emblem.

**Front Sets Lap**

SBL-1650SC1000P	1964-67 Black.....	487.99 pr.
SBL-1650SC2007P	1964-67 Red.....	375.99 pr.
SBL-1650SC4002P	1964-67 Navy Blue.....	375.99 pr.
SBL-1650SC5002P	1964-67 Dark Green.....	375.99 pr.

**Front & Rear Sets Lap**

SBL-1650SCFR1000P	1964-67 Black.....	649.99 kit
SBL-1650SCFR2007P	1964-67 Red.....	511.99 kit
SBL-1650SCFR4002P	1964-67 Navy Blue.....	511.99 kit
SBL-1650SCFR5002P	1964-67 Dark Green.....	511.99 kit

**Front & Rear Sets Lap & Shoulder**

SBL-1650SCKIT1000P	1964-67 Black.....	736.99 kit
SBL-1650SCKIT2007P	1964-67 Red.....	736.99 kit
SBL-1650SCKIT4002P	1964-67 Navy Blue.....	736.99 kit
SBL-1650SCKIT5002P	1964-67 Dark Green.....	736.99 kit

**Front Shoulder Sets**

SBL-1650SCSH1000P	1964-67 Black.....	266.99 pr.
SBL-1650SCSH2007P	1964-67 Red.....	266.99 pr.
SBL-1650SCSH4002P	1964-67 Navy Blue.....	266.99 pr.
SBL-1650SCSH5002P	1964-67 Dark Green.....	266.99 pr.

No Volume Discount.



SBL-305SC1000S



SBL-305SCKIT1000E

**Original Style Stagecoach Logo Seat Belts**

OE style \*remanufactured seat belt set featuring correct retractor, seat belt and buckle assembly with Fisher stagecoach emblem.

**Front Sets Lap**

SBL-305SC1000E	1964-67 Black.....	334.99 pr.
SBL-305SC2007E	1964-67 Red.....	334.99 pr.
SBL-305SC4002E	1964-67 Navy Blue.....	334.99 pr.
SBL-305SC5002E	1964-67 Dark Green.....	334.99 pr.

**Front & Rear Sets Lap**

SBL-305SCFR1000E	1964-67 Black.....	470.99 kit
SBL-305SCFR2007E	1964-67 Red.....	470.99 kit
SBL-305SCFR4002E	1964-67 Navy Blue.....	470.99 kit
SBL-305SCFR5002E	1964-67 Dark Green.....	470.99 kit

**Front & Rear Sets Lap & Shoulder**

SBL-305SCKIT1000E	1964-67 Black.....	695.99 kit
SBL-305SCKIT2007E	1964-67 Red.....	695.99 kit
SBL-305SCKIT4002E	1964-67 Navy Blue.....	695.99 kit
SBL-305SCKIT5002E	1964-67 Dark Green.....	695.99 kit

**Front Shoulder Sets**

SBL-305SCSH1000E	1964-67 Black.....	229.99 pr.
SBL-305SCSH2007E	1964-67 Red.....	229.99 pr.
SBL-305SCSH4002E	1964-67 Navy Blue.....	229.99 pr.
SBL-305SCSH5002E	1964-67 Dark Green.....	229.99 pr.

No Volume Discount.

\* Remanufactured. This means the product has been dismantled and reconstructed as necessary. All of its internal and external parts have been cleaned and made rust and corrosion-free. All impaired, defective, or substantially worn parts are restored to sound condition or replaced with new, "rebuilt" or "unimpaired" used parts. All missing parts are replaced with new, rebuilt, or unimpaired used parts.



GM Push Button Style



Bowtie Lift Latch Style



GM Plastic Push Button Style



Chrome Lift Latch Style



Starburst Push Button Style

**Vintage Style Seat Belts**

Now you can have the styling of muscle-era GM seat belts without the high price! Choose from plain chrome lift latch style belts, Starburst push button style belts, Bowtie logo lift latch belts or GM push button \*remanufactured style belts. Any of these belts will look right at home in your muscle car. Perfect for daily drivers, weekend warriors, pro touring, pro street or any other muscle car! Available individually or as a complete 4 piece kit! Hardware is included with all vintage style seat belts. Fill blank with your color choice.\*

SBL-1800-____-74	Chrome Lift Latch Style 74" All F/R.....	29.99 ea.
SBL-1800-____-K	Chrome Lift Latch Style 4 Piece (2) 74" & (2) 60" .....	107.96 kit
SBL-1256-____-74	Starburst Push Button Style 74" All F/R.....	29.99 ea.
SBL-1256-1000-K	Starburst Push Button Style 4 Piece (2) 74" & (2) 60" .....	107.96 kit
SBL-1205-____-74	GM Push Button Style 74" All F/R.....	52.99 ea.
SBL-1205-1000-K	GM Push Button Style 4 Piece (2) 74" & (2) 60" .....	190.96 kit
SBL-305-____-74	GM Plastic Push Button Style 74" All F/R.....	69.99 ea.
SBL-305-1000-K	GM Plastic Push Button 4 Piece (2) 74" & (2) 60" .....	233.96 kit
SBL-1803-____-74	Bowtie Lift Latch Style 74" All F/R.....	57.99 ea.
SBL-1803-1000-K	Bowtie Lift Latch Style 4 Piece (2) 74" & (2) 60" .....	208.76 kit

Black = 1000	Flame Red = 2006	Red = 2007
Maroon = 2008	Red Wine = 2009	Purple = 2010
Tan = 3000	Brown = 3004	Dark Brown = 3005
Med. Beige = 3008	Desert Tan = 3009	Electric Blue = 4000
Blue = 4002	Dark Blue = 4004	Powder Blue = 4005
Cobalt Blue = 4006	Turquoise = 4009	Military Grn = 5002
Lime Green = 5004	Dark Green = 5006	Gray = 6005
Silver = 6007	Charcoal = 6009	Orange = 7001
Yellow = 7500	Ivory = 8000	White = 9000

\*Kits available in black only. Colors are special order and are non-returnable. See ss396.com for color swatches. Not all colors available for all styles. Ask your sales rep for color availability.

**Recommended Hardware**

BSB-5-SBL	1964-77 All Fully Threaded.....	6.99 ea.
-----------	---------------------------------	----------



Shown with GM logo buckles.

**BUY'N SAVE**  
WITH KITS

**1966-73 3 Point Front Seat Belts**

Add comfort and safety to your muscle car while still keeping a stock look with Ground Up Motor Sports's 3 point retractable seat belts! These three point belts feature a vintage style lap belt and chest belt so you can get new car safety with old car looks. Each kit includes two seat belts, grade 8 mounting hardware and powder coated mounting brackets all assembled and ready to Bolt-in to your Chevelle. Instructions are also included. These seat belts mount in the factory locations meaning there is no drilling required. Seat belts meet FMVSS standards. Fill blank with your color choice.

SBL-66CH3-_____	1966-67 Buckets with Starburst.....	389.99 kit
SBL-66CH3B-_____	1966-67 Bench with Starburst.....	389.99 kit
SBL-66CH3GM-_____	1966-67 Buckets with GM Logo.....	542.99 kit
SBL-66CH3BGM-_____	1966-67 Bench with GM Logo.....	542.99 kit
SBL-68CH3-_____	1968-73 Buckets with Starburst.....	389.99 kit
SBL-68CH3B-_____	1968-73 Bench with Starburst.....	389.99 kit
SBL-68CH3GM-_____	1968-73 Buckets with GM Logo.....	542.99 kit
SBL-68CH3BGM-_____	1968-73 Bench with GM Logo.....	542.99 kit

Black = 1000	Dark Brown = 3005	Turquoise = 4009	White = 9000
Flame Red = 2006	Med. Beige = 3008	Military Grn = 5002	Silver = 6007
Red = 2007	Desert Tan = 3009	Lime Green = 5004	Ivory = 8000
Red Wine = 2009	Electric Blue = 4000	Dark Green = 5006	Gray = 6005
Purple = 2010	Blue = 4002	Charcoal = 6009	Maroon = 2008
Tan = 3000	Powder Blue = 4005	Orange = 7001	Dark Blue = 4004
Brown = 3004	Cobalt Blue = 4006	Yellow = 7500	

Colors are special order and are non-returnable. See ss396.com for color swatches. Not all colors available for all styles. Ask your sales rep for color availability.

\* Remanufactured. This means the product has been dismantled and reconstructed as necessary. All of its internal and external parts have been cleaned and made rust and corrosion-free. All impaired, defective, or substantially worn parts are restored to sound condition or replaced with new, "rebuilt" or "unimpaired" used parts. All missing parts are replaced with new, rebuilt, or unimpaired used parts.



Shown with GM logo buckles.

**Original Style Seat Belts**

OE style \*remanufactured belts feature a correct fit and function like your factory originals. These belts feature the correct front retractors and GM logo like originals. Also available for the first time correct factory shoulder harness belts. Made in the USA

SBL-CHEV6772-1000	1966-72 Front w/ Retractor.....	332.99 set
SBL-CHEV6772SH-1000	1966-72 All Shoulder Harness.....	229.99 set

**Buy the complete Kits and Save**

SBL-CHEV6772FR-1000	1966-72 2-Fronts, 3-Rears (5 pc.).....	470.99 set
SBL-CHEV6772KIT-1000	1966-72 2-Fronts, 3-Rears, 2-Shoulder (7 pc.).....	695.99 set

**Available in factory colors**

**Recommended Hardware**

BSB-5-SBL	1964-77 All Fully Threaded.....	6.99 ea.
-----------	---------------------------------	----------

*\* Remanufactured. This means the product has been dismantled and reconstructed as necessary. All of its internal and external parts have been cleaned and made rust and corrosion-free. All impaired, defective, or substantially worn parts are restored to sound condition or replaced with new, "rebuilt" or "unimpaired" used parts. All missing parts are replaced with new, rebuilt, or unimpaired used parts.*

**GM Restoration Parts**



8700758



**Standard Seat Belt Covers**

Factory replacement plastic seat belt cover.

IBC-672B	1967-72 Black.....	17.99 ea.
IBC-672R	1967-72 Red.....	17.99 ea.
IBC-672G	1967-72 Green.....	17.99 ea.
IBC-672B	1967-72 Blue.....	17.99 ea.



SBL-BLADE

**Factory Style Seat Belts**

Excellent reproduction seat belts complete with buckle and emblem for the purist.

8700758	1968-72 Front RH.....	169.99 ea.
8700759	1968-72 Front LH.....	169.99 ea.
IK-320	1968-72 Rear.....	169.99 ea.

No Volume Discount.

**Standard Seat Belt Blade**

This male blade piece is used on the end of the seat belt lap belt to snap into the female receiver for both front and rear belts.

SBL-BLADE	1965-72.....	14.99 ea.
-----------	--------------	-----------

**OER ORIGINAL EQUIPMENT REPRODUCTION**

**OER Interior Paint**

OER's revolutionary formula provides 40% more coverage than standard dyes and lacquers and actually penetrates and molecularly bonds to the surface to permanently seal in the color. Dries to the touch in 45 seconds, forms a complete bond in just 10 minutes. UV stable and color fast, it will not crack, flake or peel. For use on vinyl, leather, ABS plastic, polycarbonate, polypropylene, polyurethane, acrylic, lexan, fiberglass and recycled plastics. These paints are designed to match our colored PUI interior products. 12oz aerosol can.



HPP-802RED	M30 Red .....	32.99 ea.
HPP-804BBLU	M14 Bright Blue.....	32.99 ea.
HPP-808MBLU	M17 Medium Blue.....	32.99 ea.
HPP-809IGLD	M46 Ivy Gold.....	32.99 ea.
HPP-810WHITE	M37 White .....	32.99 ea.
HPP-807PEARL	M28 Pearl.....	32.99 ea.
HPP-811ORNG	M126 Hugger Orange .....	32.99 ea.
HPP-813DGRN	M24 Dark Green.....	32.99 ea.
HPP-820CAMEL	Z48 Camel Tan.....	32.99 ea.
HPP-829FTHRN	Z45 Firethorn Red .....	32.99 ea.
HPP-830CARME	Z38 Carmine.....	32.99 ea.
HPP-1009	Surface Prep.....	19.99 ea.

*Paint can not be shipped via air. Ground shipping only.*



IPA-65



**1965 Pre-Assembled Door Panels**

Madrid grain vinyl with dielectrically sealed horizontal lines. Includes chrome-like moldings. **Ready To Install!**

**Black**

IPA-65	Front Black .....	209.99 pr.
IPA-65C	Rear Coupe Black .....	114.99 pr.
IPA-65S	Rear Sedan Black.....	89.95 pr.
IPA-65V	Rear Convertible Black* .....	64.99 pr.

**Colors**

Fill in color code below.

IPA-65PD__	Front Colors.....	210.99 pr.
IPA-65PD__C	Rear Coupe/Sedan Colors .....	114.99 pr.
IPA-65D__V	Rear Convertible Colors*.....	59.99 pr.

*\*Not pre-assembled.*

- White/Aqua (263-3) • Aqua (264) • 2 Tone Aqua (267)
- Light Blue (262) • 2 Tone Blue (269) • Fawn (266)
- 2 Tone Fawn (266-2) • Red (261) • White (263)
- 2 Tone Red (268) • Light Saddle (265)
- White/Black (263-2) • Slate (269-1) • 2 Tone Saddle (265-2)

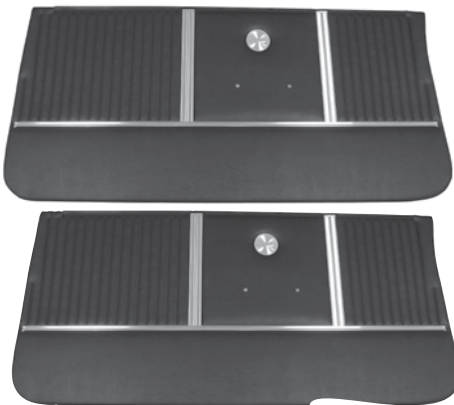

IPA-64



**1964 Pre-Assembled Door Panels**

Seville grain vinyl with vertically sealed dielectric panel with two chrome mylar strips and chrome medallion. Also includes chrome-like molding piece on lower portion of panel.

**Ready To Install!**

**Black**

IPA-64	Front Black .....	209.99 pr.
IPA-64C	Rear Coupe/Sedan Black.....	114.99 pr.
IPA-64V	Rear Convertible Black*.....	104.99 pr.

**Colors**

Fill in color code below.

IPA-64PD__	Front Colors.....	210.99 pr.
IPA-64PD__C	Rear Coupe/Sedan Colors .....	114.99 pr.
IPA-64D__V	Rear Convertible Colors*.....	98.99 pr.

*\*Not pre-assembled.*

- Aqua (303) • Light Blue (302) • Light Fawn (305)
- Red (301) • Saddle (306) • White (304)



IPA-67



**1967 Pre-Assembled Door Panels**

Madrid grain vinyl with dielectrically sealed horizontal pleats finished with original style metal buttons. **Ready To Install!**

**Black**

IPA-67	Front Black .....	209.99 pr.
IPA-67C	Rear Coupe Black* .....	99.99 pr.
IPA-67T	Rear 2 Door Sedan Black* .....	99.99 pr.
IPA-67V	Rear Convertible Black* .....	64.99 pr.

**Colors**

Fill in color code below.

IPA-67PD__	Front Colors.....	248.99 pr.
IPA-67D__C	Rear Coupe Colors* .....	95.99 pr.
IPA-67D__T	Rear 2 Door Sedan* .....	95.99 pr.
IPA-67D__V	Rear Convertible Colors*.....	59.99 pr.

*\*Not pre-assembled.*

- Aqua (235) • Light Blue (232) • Bright Blue (233)
- Red (231) • White (234) • Gold (236)



IPA-68



**1968 Pre-Assembled Door Panels**

Madrid grain vinyl with two vertical strips of chrome mylar finished off with metal top rail on the fronts, high quality flets and metal top rails on the rears, chrome-like molding trim pieces and door lock ferrules. **Ready To Install!**

**Black**

IPA-68	Chevelle Front Black.....	299.99 pr.
IPA-68T	Chevelle Front 2 Door Sedan Black* .....	188.99 pr.
IPA-E68	El Camino Front Black .....	289.99 pr.
IPA-68C	Rear Coupe Black .....	219.99 pr.
IPA-68CT	Rear 2 Door Sedan Black* .....	110.99 pr.
IPA-68V	Rear Convertible Black .....	255.99 pr.

**Colors**

Fill in color code below.

IPA-68PD__	Chevelle Front Colors.....	353.99 pr.
IPA-68D__T	Chevelle Front 2 Door Sedan Colors* .....	154.95 pr.
IPA-E68PDE__	El Camino Front Colors.....	299.99 pr.
IPA-68PD__C	Rear Coupe Colors.....	216.99 pr.
IPA-68D__CT	Rear 2 Door Sedan Colors* .....	110.99 pr.
IPA-68PD__V	Rear Convertible Colors.....	216.99 pr.

*\*Not pre-assembled.*

- Light Blue (315) • 68 Blue (313)
- Pearl (312) • Red (311) • Ivy Gold (314)

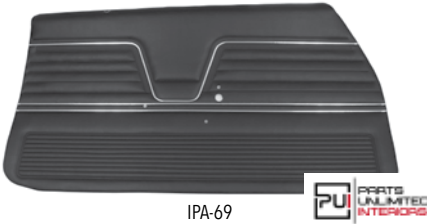

IPA-69



**1969 Pre-Assembled Door Panels**

Madrid grain vinyl dielectrically sealed with chrome mylar strips finished off with metal top rail on the fronts, high quality felts and metal top rails on the rears, chrome-like molding trim pieces and door lock ferrules. **Ready To Install!**

**Black**

IPA-69	Chevelle Front Black.....	299.99 pr.
IPA-69T	Chevelle Front 2 Door Sedan Black*.....	188.99 pr.
IPA-E69	El Camino Front Black.....	289.99 pr.
IPA-69C	Rear Coupe Black.....	219.99 pr.
IPA-69TC	Rear 2 Door Sedan Black*.....	110.99 pr.
IPA-69V	Rear Convertible Black.....	219.99 pr.

**Colors**

Fill in color code below.

IPA-69PD__	Chevelle Front Colors.....	353.99 pr.
IPA-69D__T	Chevelle Front 2 Door Sedan Colors*.....	159.95 pr.
IPA-E69PDE__	El Camino Front Colors.....	299.99 pr.
IPA-69PD__C	Rear Coupe Colors.....	253.99 pr.
IPA-69D__CT	Rear 2 Door Sedan*.....	89.95 pr.
IPA-69PD__V	Rear Convertible Colors.....	170.95 pr.

\*Not pre-assembled.

- Light Blue (256) • Dark Blue (254) • Light Green (255)
- Dark Metallic Green (253) • Parchment (252) • Red (251)



IPA-70



**1970-72 Pre-Assembled Door Panels**

Madrid grain vinyl with parallel chrome mylar strips across the top of the vertical dielectric pleats and wide chrome mylar strips at the bottom of the panels finished off with metal top rail on the fronts, high quality felts and metal top rails on the rears, chrome-like molding trim pieces and door lock ferrules.

**Ready To Install!**

**Black**

IPA-70	Chevelle Front Black.....	299.99 pr.
IPA-E70	El Camino Front Black.....	289.99 pr.
IPA-70C	Rear Coupe/Sedan Black.....	219.99 pr.
IPA-70V	Rear Convertible Black.....	219.99 pr.

**Colors**

Fill in color code below.

IPA-70PD__	Chevelle Front Colors.....	296.99 pr.
IPA-E70PDE__	El Camino Front Colors.....	353.99 pr.
IPA-70PD__C	Rear Coupe/Sedan Colors.....	216.99 pr.
IPA-70PD__V	Rear Convertible Colors.....	216.99 pr.

- 70 Bright Blue (249) • 70 Dark Metallic Green (246)
- 70 Pearl (242) • 70 Red (241) • 70 Saddle (244)
- 70 Gold (249-1) • 71-72 Blue (249-6)
- 71-72 Dark Blue (249-4) • 71 Jade Green (249-3)
- 72 Dark Green (247) • 71 Covert (249-9) • 72 White (243)
- 72 Sandalwood (248) • 71 Dark Saddle (245) • 72 Tan (249-2)

**BUY'N SAVE WITH KITS**



**PUI Door Panel Kits**

Save when you buy the kit! Each kit includes (2) PUI front door panels and (2) PUI rear door panels. Black only.

IDA-64AK	1964 Chevelle Coupe.....	308.73 kit
IDA-64AVK	1964 Chevelle Convertible.....	299.23 kit
IDA-65AK	1965 Chevelle Coupe.....	308.73 kit
IDA-65AVK	1965 Chevelle Convertible.....	261.23 kit
IDA-66AK	1966 Chevelle Coupe.....	308.73 kit
IDA-66AVK	1966 Chevelle Convertible.....	261.23 kit
IDA-67AK	1967 Chevelle Coupe.....	294.48 kit
IDA-67AVK	1967 Chevelle Convertible.....	261.23 kit
IDA-68AK	1968 Chevelle Coupe.....	493.98 kit
IDA-68AVK	1968 Chevelle Convertible.....	515.38 kit
IDA-69AK	1969 Chevelle Coupe.....	493.98 kit
IDA-69AVK	1969 Chevelle Convertible.....	493.98 kit
IDA-70AK	1970-72 Chevelle Coupe.....	493.98 kit
IDA-70AVK	1970-72 Chevelle Convertible.....	493.98 kit

*Ships Oversize. Not eligible for free shipping.*



1970-72

Door Panels



**PUI Platinum Edition Door Panels**

These Platinum Edition door panels from PUI feature crisper, more beveled pleats just like the original. They have the original contours and dimensions because every dimension and measurement is taken from GM originals. These pre-assembled panels also include improved moldings with correctly turned edges for a cleaner, more original look.

**1969 Chevelle**

Fill in \_\_ with color choice.

IPP-CHV69__	1969 Front.....	437.99 pr.
IPP-CHV69__C	1969 Rear Coupe.....	291.99 pr.
IPP-CHV69__V	1969 Convertible.....	291.99 pr.

- 10 Black • 12 Light Blue • 16 Dark Metallic Blue
- 23 Light Green • 24 Dark Metallic Green
- 27 Parchment • 30 Red

**1970 Chevelle**

Fill in \_\_ with color choice.

IPP-CHV70__	1970 Front.....	437.99 pr.
IPP-CHV70__C	1970 Rear Coupe.....	291.99 pr.
IPP-CHV70__V	1970 Convertible.....	291.99 pr.

- 10 Black • 14 Bright Blue • 24 Dark Green Metallic
- 28 Pearl • 31 Red • 36 Saddle • 43 Gold

**1971-72 Chevelle**

Fill in \_\_ with color choice.

IPP-CHV7172__	1971-72 Front.....	337.99 pr.
IPP-CHV7172__C	1971-72 Rear Coupe.....	239.99 pr.
IPP-CHV7172__V	1971-72 Convertible.....	239.99 pr.

- 10 Black • 19 Jade Green • 42 Dark Saddle
- 09 Blue • 41 Sandalwood • 25 Dark Green
- 37 White • 47 Tan • 29 Covert

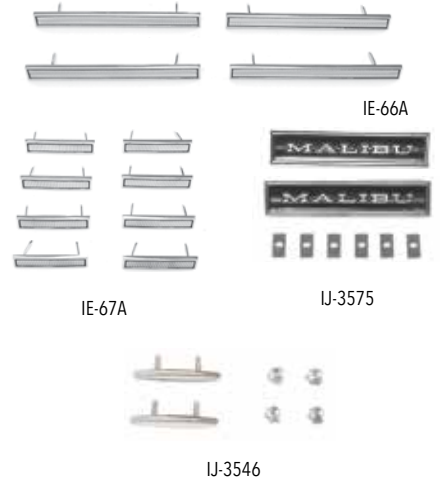

IE-66A

IE-67A

IJ-3575

IJ-3546

**Door Panel Medallions**

OE style reproduction emblems.

IE-66A	1966 Medallion (4 pc.).....	54.99 set
IE-67A	1967 Medallion (8 pc.).....	54.99 set
IJ-3546	1970-72 Medallion.....	24.99 pr.
IJ-3575	1970-72 Malibu.....	29.99 pr.

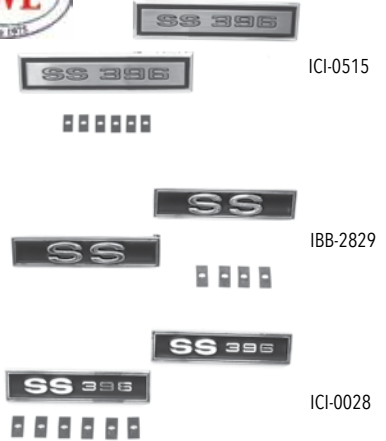

ICI-0515

IBB-2829

ICI-0028

**SS Door Panel Emblems**

Reproduction emblems for your SS.

ICI-0515	1968 SS396.....	42.99 pr.
ICI-0028	1969 SS396.....	36.99 pr.
IBB-2829	1970-72 SS.....	27.99 pr.



IRM-8V

**Door Panel Top Retainer Moldings**

Correct stainless steel upper moldings which retain the tops of the door panels. Fits Camino.

IRM-9F	1964-67 Front All.....	39.95 pr.
IRM-8R	1964-67 Rear Coupe.....	39.95 pr.
IRM-8V	1964-67 Rear Convertible.....	39.95 pr.



### Master Interior Fastener Kits include fasteners to attach:

Air outlet bezels, air vents in door jam, armrest base & pad, ash tray retainer, coat hook, console & door & hinge & lamp, courtesy lamps, dash pad, dimmer switch, dome lamp, door panels, door handles, door pull straps, firewall insulation, glove box door & latch & liner, grab bar, heater control, instrument cluster, kick panels, mirror, nameplates, pillar moldings, quarter glass weatherstrip, quarter trim panels, radio trim panel, radio control shafts, rocker panel cover plates, scuff plates, seat back stop bumpers & strikers, seat back cables, seat back panels, rear seat, body, seat pivot clips & covers, seat tracks, floor, shifter plate, shoulder harness retainers, steering column dash, steering column cover at dash & firewall, steering wheel shroud, sun visor brackets & clamps, turn signal lever, window cranks, vent window.



**Basic**



**OEM**

#### Basic Kits

ISK-64A	1964-67 Chevelle.....	22.95 kit
ISK-68A	1968-69 Chevelle.....	23.95 kit
ISK-70A	1970-72 Chevelle.....	24.95 kit
ISK-64E	1964-72 El Camino .....	21.95 kit

#### OEM Complete

64AN-CP	1964-65 Chevelle Coupe (241 pc.).....	159.99 set
64AN-CV	1964-65 Chevelle Convertible (255 pc.).....	139.99 set
66AN-CP	1966 Chevelle Coupe (302 pc.).....	164.99 set
66AN-CV	1966 Chevelle Convertible (318 pc.).....	159.99 set
67AN-CP	1967 Chevelle Coupe (333 pc.).....	189.99 set
67AN-CV	1967 Chevelle Convertible (351 pc.).....	179.99 set
68AN-CP	1968 Chevelle Coupe (372 pc.).....	199.99 set
68AN-CV	1968 Chevelle Convertible (360 pc.).....	189.99 set
69AN-CP	1969 Chevelle Coupe (401 pc.).....	199.99 set
69AN-CV	1969 Chevelle Convertible (389 pc.).....	194.99 set
70AN-CP	1970-72 Chevelle Coupe (433 pc.).....	224.99 set
70AN-CV	1970-72 Chevelle Convertible (413 pc.).....	219.99 set

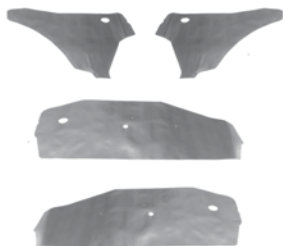

#### Door Panel Water Shield

Correct pre-cut water resistant paper material for prevention of door panel damage. 1 car.

ICK-0122	1964-67 Chevelle (4 pc.).....	23.99 kit
ICK-124	1968-72 Chevelle (4 pc.).....	21.99 kit
ICK-3	1964-67 El Camino (2 pc.).....	16.99 kit
ICK-7	1968-72 El Camino (2 pc.).....	17.99 kit
ICK-117	1973-77 (2 pc.).....	21.99 pr.



#### Door Panel Clips

IXP-33	All Clips (12 pc.).....	7.99 kit
--------	-------------------------	----------



#### EMS Stainless Strikers

Replace your plain steel strikers with these attractive Eddie Motorsports Chevelle stainless steel door striker bolts. These billet striker bolts are cut with a Torx head and fit most GM muscle cars.

MS277-20M	Machined.....	55.99 pr.
MS277-20P	Polished.....	62.99 pr.

IXP-18



#### Door Panel Plugs

Correct plugs for attaching door panel clips. Buy the kit and save!

IXP-18K	Plug Kit (12 pc.).....	19.10 kit
IXP-18	All Plug.....	1.99 ea.

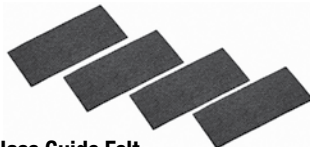

#### Door Glass Guide Felt

Front door window glass guides fabric covering. Stick over existing brackets.

GGF-557	1968-72 (4 pc.).....	8.99 set
---------	----------------------	----------



#### Door Panel Screws

Correct size attaching screw for door panels.

IDP-109	All.....	0.50 ea.
---------	----------	----------



IDP-14465



IDP-14464

#### Door Panel Adjustment Clips

Correct upper door panel adjustment clips that are used to hold the door panel to the upper door frame.

IDP-14464	1968-72 Front.....	11.99 ea.
IDP-14465	1968-72 Rear.....	11.99 ea.



ICF-4410



ICE-6400



IV-113



IFF-600

#### Door Lock Knobs & Ferrules

OE style reproduction door lock knobs & ferrules.

ICF-4410	1964-67 Chrome Knob.....	3.95 ea.
ICF-4411	1967 Chrome Knob.....	5.99 ea.
ICE-6400	1968-70 Chrome Knob.....	2.95 ea.
IV-113	1971-72 Chrome Knob.....	2.95 ea.
ICF-401	1964-67 Ferrules.....	7.95 pr.
IFF-600	1968-72 Ferrule.....	1.95 ea.

JTE-8235



#### Door Jamb Vents

OE style reproduction with correct rubber vent seal.

JTE-5043	1969 All.....	18.99 ea.
JTE-8235	1970-72 All.....	16.99 ea.
BJV-11366	Screws.....	1.99 pr.



MS275-27



MS275-28

#### Eddie Motorsports Billet Door Jamb Vents

Eddie Motorsports offers trick replacement parts for even the most inconspicuous items on your car. Such is the case with these billet aluminum door jamb vents. Made in USA.



R, B, W,  
PR, BK,  
BKA,  
MB,  
MBA,  
CL, CA

MS275-28	1969 All.....	139.99 pr.	179.99 pr.	179.99 pr.
MS275-27	1970-72 All..	139.99 pr.	179.99 pr.	179.99 pr.

M = Machined, P = Polished, R = Red Fusioncoat,  
B = Blue Fusioncoat, W = White Fusioncoat,  
PR = Purple Fusioncoat, BK = Gloss Black Fusioncoat,  
BKA = Gloss Black Anodized, MB = Matte Black Fusioncoat,  
MBA = Matte Black Anodized, CL = Clear Coat,  
CA = Clear Anodized

ICE-4814K



ICE-3520X



IDH-1605



**Door Handles**

Excellent quality reproduction door handles.

IDH-1605	1964 Ribbed Arm .....	13.95 ea.
ICE-4814K	1964-67 .....	23.78 pr.
ICE-4814	1964-67 .....	13.99 ea.
ICE-3520X	1968-72 .....	33.98 pr.
ICE-3520L	1968-72 LH .....	19.99 ea.
ICE-3520R	1968-72 RH .....	19.99 ea.
IDH-78GL	1978-88 LH .....	14.99 ea.
IDH-78GR	1978-88 RH .....	14.99 ea.



**Vent Window Handles**

OE style reproduction die cast chrome handles.

IVH-52	1964-65 Chevelle .....	36.99 pr.
IVH-67	1966-67 Chevelle .....	39.95 pr.
IVH-52	1964-67 El Camino .....	36.99 pr.



**Clayton Machine Works Handles**

Easily add a nice custom touch to your interior with these custom handles from Clayton Machine Works! These handles are CNC machined and powder coated a satin silver. The perimeters and inside truss edges are then re-machined for subtle yet dynamic highlight. A great match for Clayton pedals!

PT-202	Door Handles .....	175.99 pr.
PT-203	Window Cranks .....	183.99 pr.
PT-204	Vent Window Cranks .....	161.99 pr.

No Volume Discount.



**Door Panel Washers**

Foam washers used under the door panels to seal door handles and window cranks.

IFW-2	Most GM 1-1/16" .....	6.99 pr.
-------	-----------------------	----------



**Standard Door Handle Mechanisms**

Reproduction plated mechanisms.

IDH-479	1965-67 All .....	35.99 pr.
IDH-901	1968-72 w/o Backing plates .....	35.99 pr.
IDH-68BP-L	1968-72 LH w/ Chrome Backing Plates .....	49.99 ea.
IDH-68BP-R	1968-72 RH w/ Chrome Backing Plates .....	49.99 ea.



**Door Jamb Windlace**

Correct style windlace in black.

IJW-40	1964-67 Coupe .....	15.99 pr.
IJW-E40	1964-67 El Camino .....	22.99 pr.
IJW-968	1968-69 Coupe .....	33.99 pr.
IJW-968CVT	1968-69 Convertible .....	33.99 pr.
IJW-702	1970-72 All .....	57.99 pr.
IJW-7W	1970-72 All* .....	52.99 pr.
IJW-PERFOOT	Universal .....	1.89 ea.

\*White paint to match.



**Windlace End Caps**

Correct plastic caps for top edge of rear door panel.

IWE-416	1964-65 Coupe .....	22.99 pr.
IWE-417	1964-65 Convertible .....	23.99 pr.
IWE-434	1966-67 All .....	22.99 pr.



**Vent Window Pivot Stud Assembly**

Includes polished stainless cap, fiber and rubber gaskets, internal plastic bushing spacer and two special wave washers (one extra).

IVH-741	1966-67 (6 pc.) .....	22.99 kit
---------	-----------------------	-----------

Note: 2 required per car.



**Vent Window Pivot Stud Nut, Chrome**

Chrome plated spacer nut retains stud to vent window glass.

IVH-742	1966-67 .....	8.99 ea.
---------	---------------	----------

Note: 2 required per car.



**Vent Window Rivet**

Correct rivet for vent window.

KVF-RVT	1964-67 .....	1.95 ea.
---------	---------------	----------



4432791



GWS-711

**Power Window Switch**

Correct OEM style power window switch.

4432790	1964-70 1 Window .....	42.99 ea.
4432793	1964-70 2 Window .....	54.99 ea.
4432791	1964-70 4 Window .....	69.99 ea.
GWS-711	1971-77 1 Window .....	44.99 ea.
GWS-712	1971-77 2 Window .....	52.99 ea.
GWS-714	1971-72 4 Window .....	69.99 ea.
GWS-016	1978-88 1 Window .....	11.95 ea.
GWS-017	1978-88 2 Window .....	26.99 ea.
36048	1964-70 Pigtail Single Switch .....	24.99 ea.



GWS-634



GWS-635

**Power Window Switch Retainers**

GWS-634	1964-77 1 Button .....	9.95 ea.
GWS-635	1964-77 4 Button .....	25.00 ea.



GLS-71

**Power Lock Switch**

Die cast and chrome plated. It reads LOCK and has the correct square corners and profile. Replaces GM number 1725099.

GLS-71	1971-77 .....	59.99 ea.
--------	---------------	-----------



GWM-22

**Power Window Motors**

This is a high quality brand new power window motor. These fit front or rear windows.

GWM-22	1964-68 RH .....	99.99 ea.
GWM-23	1964-68 LH .....	99.99 ea.
GWM-22	1969-72 RH .....	99.99 ea.
GWM-23	1969-72 LH .....	99.99 ea.
GWM-79G	1979-88 LH/RH .....	39.95 ea.

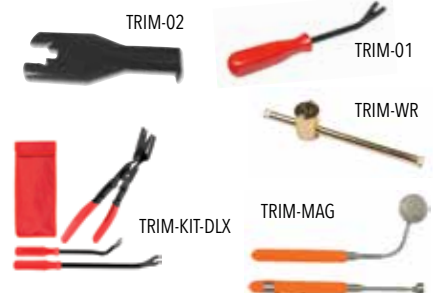

**Trim Removal Tools**

TRIM-01	Door Panel Removal Tool .....	9.97 ea.
TRIM-02	Window Crank/Door Handle Removal .....	6.99 ea.
TRIM-WR	Window Roller Removal Tool .....	18.99 ea.
TRIM-MAG	Mirror & Magnet Kit 2pc .....	14.95 set
TRIM-KIT-DLX	Trim Removal Tools 3pc .....	29.99 ea.



**BUY'N SAVE WITH KITS**



IN-656K



IPQ-4078C

**Window Cranks & Hardware**

OE style reproduction window cranks in kits or individually!  
Include 4 cranks, 4 clips and 4 gaskets.

IWC-X23	1964-67 Double Arm Black Knob .....	13.95 ea.
IWC-X31	1964-67 Double Arm Chrome Knob .....	13.95 ea.
IA-64	1965 Black Knob .....	21.95 ea.
IN-656K	1965-66 Chrome Knob Kit .....	57.46 kit
IN-656	1965-66 Chrome Knob .....	14.95 ea.
IN-657	1964-66 Black Knob .....	6.95 ea.
IN-657K	1964-66 Black Knob Kit .....	32.95 kit
IPX-4078C	1967-77 Clear Knob Kit .....	33.80 kit
IPX-4078B	1967-77 Black Knob Kit .....	33.83 kit
IPQ-4080C	1967-88 Clear Knob .....	7.99 ea.
IPQ-4080B	1967-88 Black Knob .....	8.00 ea.
IPX-3850	All Gasket .....	1.95 ea.
IPX-39	All Spring .....	1.95 ea.
IPX-38	All Clip .....	0.75 ea.

No Volume Discount on Kits.



IPQ-67GMB



**1965-72 Factory Correct Window Cranks**

Quality die cast. Correct spline depth and clip engagement.  
Shorter and with a flatter curvature than later years with correct thin knob. 1968-72 features cast number 9715291.

IPQ-67GMB	1965-67 Black Knob .....	13.99 ea.
IPQ-67GMC	1965-67 Clear Knob .....	15.99 ea.
IPQ-68GMB	1968-72 Black Knob .....	17.99 ea.
IPQ-68GMC	1968-72 Clear Knob .....	17.99 ea.

**BUY'N SAVE WITH KITS**



IVH-5

**Vent Window Cranks**

Reproduction die cast vent window cranks.

**1968 Chevelle**

IVH-E6C	Clear .....	9.99 ea.
IVH-E6CK	Clear Kit (2 Cranks) .....	20.30 kit
IVH-E6B	Black .....	9.99 ea.
IVH-E6BK	Black Kit (2 Cranks) .....	20.30 kit

**1968-72 El Camino**

IVH-E6C	Clear .....	9.99 ea.
IVH-E6CK	Clear Kit (2 Cranks) .....	20.30 kit
IVH-E6B	Black .....	9.99 ea.
IVH-E6BK	Black Kit (2 Cranks) .....	20.30 kit



IHK-68C



IHK-64B

**Window Crank & Door Handle Kits**

Save when you buy the kit! This is a set of reproduction window cranks and inside door handles. Including (4) cranks, (4) clips and (4) gaskets, (2) handles with clips.

IHK-64B	1967 Black Knob Kit .....	54.22 kit
IHK-64C	1967 Clear Knob Kit .....	54.19 kit
IHK-68B	1968-72 Black Knob Kit .....	63.82 kit
IHK-68C	1968-72 Clear Knob Kit .....	63.79 kit



IAT-68C



IAT-64V

**Arm Rest Ash Trays**

Correct chrome ash tray for rear arm rests.

IAT-64R	1964-67 Coupe .....	49.99 pr.
IAT-64V	1964-67 Convertible .....	49.99 pr.
IAT-69R	1968-72 Convertible (Ribbed) .....	45.99 ea.
IAT-69S	1967-72 Convertible (Smooth) .....	36.99 ea.
IAT-68C	1968-69 Ribbed .....	32.99 ea.
IAT-70C	1970-72 Smooth .....	34.99 ea.

**ARM-KIT3**

**1964-67 Front Arm Rest Pad & Base Kit**  
Complete kits with 2 arm rest bases and 2 front arm rest pads.

ARM-KIT3	1964-67 Black .....	62.02 kit
----------	---------------------	-----------



IBP-68

**Arm Rest Backing Plate**

OE style reproduction arm rest backing plates which were installed on some 1968 Chevelles.

IBP-68	1968 All 12-1/2" .....	59.95 pr.
IBP-68R	1968 All 15-13/16" .....	84.99 pr.



ARM-KIT8



ARM-KIT6

**Rear Arm Rest Pad & Base Kits**

Complete kits with pads, ash trays and chrome trim!

ARM-KIT6	1964-67 Black Pad.....	115.16 kit
ARM-KIT8	1968-69 Black Pad w/ Chrome....	126.99 kit
ARM-KIT9	1968-69 Black Pad w/o Chrome..	126.99 kit
IXP-12527	1968-69 Screw Kit 4pc.....	3.99 kit



ICC-001



ICC-0024



ICI-5101R



IXP-03

**Arm Rest Pads**

OE style reproduction arm rest pads.

ICC-0001	1964-67 Front Black.....	18.99 ea.
ICC-0024	1964-67 Rear Black.....	18.99 ea.
ICI-5101L	1968-72 LH All.....	21.99 ea.
ICI-5101R	1968-72 RH All.....	21.99 ea.
ICC-73B	1973-77 Black.....	109.99 pr.
ICC-73R	1973-77 Red.....	119.95 pr.
ICC-73BL	1973-77 Blue.....	119.95 pr.
ICC-73G	1973-77 Gray.....	119.95 pr.
ICC-73T	1973-77 Buckskin.....	119.95 pr.
IXP-03	Attaching Screw.....	0.50 ea.



ICC-029



ICC-4900



ICI-1960R



**Arm Rest Bases**

OE style reproduction chrome plated and plastic arm rest bases.

ICC-029	1964-67 Front.....	34.99 pr.
ICC-4900	1964-67 Rear.....	39.99 pr.
ICI-1960L	1968-72 LH Black.....	21.99 ea.
ICI-1960R	1968-72 RH Black.....	21.99 ea.
IXP-997	Attaching Screw.....	0.75 ea.



ICI-R4820

**1969-1973 Chevelle Wagon Arm Rest Base And Pad Set OE Style**

Manufactured to exact OE specifications, each arm rest pad is produced using modern urethane material with a sharp Madrid grain around a steel insert.

ICI-R4820	Black.....	89.99 set
-----------	------------	-----------



IAM-6872

**Arm Rest Base Moldings**

Correct chrome arm rest base found on some Chevelles.

IAM-6872	1968-72 All 9.25 In. Long.....	33.99 pr.
----------	--------------------------------	-----------



IPO-53

**Rear Side Panels**

Complete set of rear side panels. Black only.

IPO-53	1970-72 Coupe (4 pc.).....	105.99 set
IQP-12526	Screw Kit (12 pc.).....	7.99 kit



IPC-64PL

**Rear Arm Rest Panels**

Correct die-stamped steel upper and lower arm rest panels for your convertible.

**Lower Panels**

IPC-64PL	1964-67 LH.....	99.99 ea.
IPC-64PR	1964-67 RH.....	99.99 ea.
IPC-68PL	1968-70 LH.....	99.99 ea.
IPC-68PR	1968-70 RH.....	99.99 ea.

**Upper Panels**

IAP-647L	1964-67 Convertible All LH.....	69.95 ea.
IAP-647R	1964-67 Convertible All RH.....	69.95 ea.
IAP-687L	1968-72 Convertible All LH.....	79.99 ea.
IAP-687R	1968-72 Convertible All RH.....	79.99 ea.



ARMBASE-DBLUE



ARMBASE-DGREEN



ARMBASE-RED



ARMBASE-PARCH

**1968-72 Arm Rest Bases - Colors**

Replacement arm rest bases now available in colors!

ARMBASE-PARCH	Parchment.....	26.95 pr.
ARMBASE-RED	Red.....	26.95 pr.
ARMBASE-BBLUE	Bright Blue.....	26.95 pr.
ARMBASE-DGREEN	Dark Green.....	26.95 pr.
ARMBASE-WHITE	White.....	26.95 pr.
ARMBASE-DBLUE	Dark Blue.....	26.95 pr.



ARM-KIT4

**1968-72 Front Arm Rest Pad & Base Kits**

Complete kits with 2 arm rest bases and 2 front arm rest pads.

ARM-KIT4	1968-72 Black.....	74.77 kit
ARM-KITA10	1968-72 White.....	129.99 kit
ARM-KITA20	1968-72 Pearl.....	129.99 kit
ARM-KITA30	1968-72 Red.....	129.99 kit
ARM-KITA40	1968-72 Parchment.....	129.99 kit
ARM-KITA50	1968-72 Light Saddle.....	129.99 kit
ARM-KITA60	1968-72 Dark Saddle.....	129.99 kit
ARM-KITA65	1968-72 Light Blue.....	129.99 kit
ARM-KITA70	1968-72 Dark Blue.....	129.99 kit
ARM-KITA75	1968-72 Bright Blue.....	129.99 kit
ARM-KITA80	1968-72 Dark Green.....	129.99 kit
ARM-KITA85	1968-72 Sandalwood.....	129.99 kit

Please specify color at time of order.



**Rear Arm Rest Piston Covers**

Correct die-stamped vinyl material for covering convertible rear arm rest and piston covers.

**1964 Chevelle**

Fill in \_\_\_ with color choice.

- IAC-64AR\_\_ 1964 Convertible.....102.99 set
- 50 Light Blue, 55 Black, 56 Light Blue, 58 Light Fawn, 64 Red, 65 Saddle, 69 White



**1965-67 Chevelle**

Fill in \_\_\_ with color choice.

- IAC-1 1965-67 Convertible Black .....109.99 set
- IAC-65AR\_\_ 1965-67 Convertible Color .....102.99 set
- 12 Light Blue, 05 Aqua Two Tone, 13 Blue Two Tone, 14 Bright Blue, 20 Bronze, 22 Fawn, 30 Red, 35 Light Saddle, 37 White, 38 White/Black Two Tone, 38-1 White/Light Blue Two Tone, 43 Gold

**1968-72 Chevelle**

Fill in \_\_\_ with color choice.

- IAC-3 1968-72 Convertible Black .....109.99 set
- IAC-68AR\_\_ 1968-72 Convertible Color .....102.99 set
- 12 Light Blue, 14 Bright Blue, 09 Blue, 17 68' Blue, 19 Jade Green, 23 Light Green, 24 Dark Metallic Green, 25 Dark Green, 27 Parchment, 28 Pearl, 30 Red, 31 70' Red, 36 Saddle, 37 White, 41 Sandalwood, 42 Dark Saddle, 43 Gold, 46 Ivy Gold, 47 Tan
- IQP-12525 Screw Kit (30 pc.) .....24.99 kit

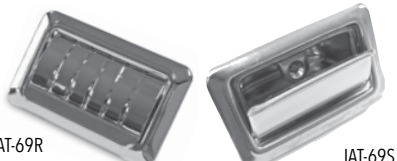

**Rear Arm Rest Ash Trays**

Correct chrome ash tray for rear arm rests.

- IAT-64V 1964-67 Convertible..... 49.99 pr.
- IAT-64R 1964-67 Coupe..... 49.99 pr.
- IAT-69R 1968-72 Convertible (Ribbed)..... 45.99 ea.
- IAT-69S 1967-72 Convertible (Smooth).....36.99 ea.
- IAT-70C 1970-72 Coupe.....34.99 ea.



**1965-67 Chevelle Convertible Rear Arm Rest Light Lens**

Used only on 65-67 Chevelle convertibles equipped with the convertible light package, these rear arm rest light lenses are reproductions, down to the off white coloring.

- RAL-15212 1965-67 Convertible..... 11.99 pr.



**Dash Pads**

Unlike cheap aftermarket urethane dashes, our OEM style dashes feature solid fiberglass cores surrounded by vinyl wrapped foam to assure you the best look and fit on the market! All of the factory colors are available and will match your new PUI colored interior exactly.

- ICC-6510 1964-65 All Black.....206.99 ea.
- ICC-6610 1966 All Black .....199.99 ea.
- ICC-6710 1967 All Black .....194.99 ea.
- ICC-6810 1968-69 All Black.....169.99 ea.
- ICC-7072M 1970-72 Mono Black .....344.99 ea.
- ICC-7072S 1970-72 Stereo Black.....299.99 ea.

Available in factory PUI colors. Ask your sales rep for color selection. Ships Oversize. Not eligible for free shipping. No Volume Discount.



**Dashtop Replacement Dash Covers**

This molded plastic dash cover simply fits right over the existing dash to cover unsightly cracks! An easier and more economical alternative to complete dash replacement.

- DT-238 1964-65 All Black.....175.99 ea.
- DT-239 1966 All Black .....175.99 ea.
- DT-217 1967 All Black .....175.99 ea.
- DT-219 1968-69 All Black.....175.99 ea.
- DT-225 1970-72 All w/ Mono Black.....175.99 ea.
- DT-226 1970-72 All w/ Stereo Black.....175.99 ea.
- DT-204 1973-77 w/ AC Black.....175.99 ea.
- DT-220 1973-77 w/o AC Black.....175.99 ea.

Call for colors. Note: Add \$33.00 for colors other than black.

Colors are not returnable. Ships Oversize.



**Dash Insulation**

Correct die-stamped factory installed jute material for under dash.

- IDJ-80 1964-67 All .....17.99 ea.
- IDJ-83 1968-72 All .....22.99 ea.

**Dash Pad Clips**

Correct replacement clips.

- 3965462 1970-72 Large .....4.99 ea.
- 3965463 1970-72 Small .....4.99 ea.

Note: 2 large and 4 small required per car.



**Dash Vent Balls & Bezels**

OE style reproduction chrome vent balls with correct accenting.

- IDV-645K 1964-65 Bezels LH&RH..... 59.99 pr.
- IK-850 1966-69 Vent Ball ..... 18.95 ea.
- IK-850K 1966-69 Vent Ball Set .....34.11 kit
- IM-23 1966-67, 1969 Seals .....4.99 pr.
- IK-851L 1966-67 Bezel LH .....21.99 ea.
- IK-851R 1966-67 Bezel RH.....21.99 ea.

Featured on 1966-67 AC cars & 1969 cars w/ Astro Vents.



**1966-67 Dash Vent Kit**

Includes (2) dash vent bezels, (2) chrome dash vent balls, (2) felts and hardware.

- IDV-69K-CHROME 1966-67.....99.95 ea.
- IK-189 1966-67 Vent Retainer .....16.99 ea.



**1968-69 Dash Vent Ball Bezels**

High quality reproduction dash vent bezel which houses the vent ball. Features a correct rubber covered housing. Comes complete with seals and hardware. You must re-use your original vent ball.

- IDV-68L 1968 LH w/ AC..... 95.99 ea.
- IDV-69L 1969 LH All .....95.99 ea.
- IDV-689R 1968 RH w/ AC..... 95.99 ea.
- IDV-689R 1969 RH All .....95.99 ea.

No Volume Discount.



**Center Air Vents AC**

Correct center air conditioning vents.

- IT-701 1969-72 w/ AC ..... 48.99 pr.
- ICV-702 1970-72 Vents/ Housing w/ AC...104.99 ea.
- ICV-667 1966-67 w/ AC .....115.95 ea.



IJ-3272

**Side Air Vents And Assemblies**

OE style reproduction side air vents with correct accenting. Complete assemblies ready to install.

- IJ-800 1970 Smooth Vent Only ..... 44.99 ea.
- IJ-872 1971-72 Pebble Vent Only..... 44.99 ea.
- IJ-3272 1970 All Assembly ..... 109.99 pr.
- IJ-3274 1971-72 All Assembly ..... 109.99 pr.

Note: Differs slightly from original AC cars.



AAP-1452B

**Air Conditioning Plenum Passenger Side**

This is a reproduction lower passenger side AC plenum with air diverter.

- AAP-1452B 1970-72 ..... 94.99 ea.



IJ-3277

IJ-3279

**AC Vacuum Pod & Door**

Correct vacuum pods for activating under dash and cowl doors.

- IJ-3277 1968-72 Under Dash Door..... 54.99 ea.
- IJ-3279 1968-72 Cowl Air Pod ..... 44.95 ea.
- IJ-3278 1968-72 Dash Door Pod ..... 59.99 ea.



IDL-64TS

**1964-65 Turn Signal Lenses**

Correct turn signal indicator lenses.

- IDL-64TS 1964-65 ..... 9.99 pr.



DLH-6667

**1966-67 Dash Lens Housings**

This is a set of 4 dash lens filter housings for your brake, temperature, and turn signal indicators. These plastic housings go inside of your factory style dash gauge housing and direct the light to your dash indicators.

- DLH-6667 1966-67 ..... 44.99 set



IDL-66GL

**1966-67 Dash Indicator Lenses**

These reproduction indicator lenses will freshen up your dash. Features generator, high beam, oil and temperature.

- IDL-66GL 1966-67 ..... 14.95 pr.



IDP-66

**1964-67 Dash Plate**

Surrounds the gauges on floor shift cars. Installs as original.

- IDP-64 1964-65 ..... 68.99 ea.
- IDP-66 1966-67 ..... 69.99 ea.



IGH-66A-G

**1966-67 Dash Gauge Housing Plate**

Stamped steel dash gauge housing backing plate which attaches to the rear of your dash face plate. For cars with stock or replacement gauges.

- IGH-66A-G 1966-67 w/ Gauges..... 109.99 ea.



S145

**1964-72 Dash Indicator**

These new indicators stick over the originals for a factory look.

- S138 1964-65 TH350, TH400 ..... 22.99 ea.
- S139 1964-65 Overdrive 4 Speed ..... 22.99 ea.
- S158 1966-67 Overdrive 4 Speed ..... 22.99 ea.
- S145 1968 TH350, TH400 ..... 22.99 ea.
- S146 1968 Overdrive 4 Speed ..... 22.99 ea.
- S147 1969 TH350, TH400 ..... 22.99 ea.
- S148 1969 Overdrive 4 Speed ..... 22.99 ea.
- S157 1970-72 Overdrive 4 Speed ..... 22.99 ea.



ISI-70SS

**1970-72 Dash Column Shift Indicator**

Reproduction dash column shift indicators. These come complete with the cable to attach to the column.

- ISI-70SS 1970 SS Green Letters 3 Speed ..... 42.99 ea.
- ISI-712SS 1971-72 SS White Letters 3 Speed ..... 42.99 ea.
- ISI-702M 1970-72 Malibu Green Letters 2 Speed ... 42.99 ea.



ISI-3731

**1979-85 Shift Indicators and Parts**

This is a complete shift indicator assembly made with original GM tooling. Fits all 1979-1985 Monte, Malibu and El Camino with gauges and automatic transmission.

- ISI-3731 Complete..... 39.99 ea.
- ISI-3732 Red Pointer Only ..... 8.99 ea.
- ISI-3733 Orange Pointer Only..... 7.95 ea.



IK-712DF

**Dash Defroster Vent Plenum**

This is a brand new improved OE style replacement defroster duct. Fits AC and heat only cars. SS or Malibu.

- IK-712DF 1970-72 ..... 119.99 ea.



IGH-70SS

**Dash Gauge Housing**

OE style reproduction injection molded housing which supports the dash gauges. This piece is detailed to perfection with correct colors.

- IGH-70SS 1970-72 SS ..... 99.95 ea.



IGH-7072

**Dash Housing Backing Plate**

Correct stamped steel plate which attaches to the rear of your housing where the printed circuit goes.

- IGH-7072 1970-72 SS ..... 72.99 ea.



IDL-64Z

NM-166



IJ-902

**Dash Lenses**

Replace that worn or scratched lens with a new clear lens. Most feature correct screened indicators where applicable.

- IDL-64X 1964-65 w/ Gauges ..... 59.95 ea.
- IDL-64Z 1964-65 w/o Gauges ..... 59.95 ea.
- NM-166 1966-67 Speedo ..... 36.99 ea.
- NM-166-PG 1966-67 Speedo Auto PG ..... 29.95 ea.
- NM-166-TH 1966-67 Speedo Auto TH..... 31.99 ea.
- IJ-8DL 1968 Speedo ..... 38.99 ea.
- IJ-8CL 1968 Clock/Gauges..... 38.99 ea.
- IJ-9DL 1969 All ..... 82.99 ea.
- IJ-902 1970-72 Super Sport ..... 59.95 ea.
- IDL-7377A 1973-77 All ..... 99.99 ea.
- IDL-7888M 1978-87 El Camino ..... 62.99 ea.



IDB-65-KEY

**1964-65 Dash Bezel Key Guard**

This premium stainless steel guard fits below the ignition switch on your dash bezel and features the correctly formed radius edge as well as the lower retaining tabs for an excellent fit.

- IDB-64-KEY 1964 All ..... 19.95 ea.
- IDB-65-KEY 1965 All ..... 19.95 ea.



**1964-65 Dash Bezels** IDB-64

OE style reproduction of the original chrome plated instrument bezels.

IDB-64	1964 w/o AC.....	129.99 ea.
IDB-64A	1964 w/ AC.....	129.99 ea.
IDB-65	1965 w/o AC.....	129.99 ea.
IDB-65A	1965 w/ AC.....	129.99 ea.



**1968 Chevelle Dash Carrier** IJ-68V

This is an excellent reproduction Chevelle dash carrier. This hard to find item is crafted using injection molding and features the correct pebble grain with chrome accenting.

IJ-68V	1968 All w/ Astro Ventilation.....	299.99 ea.
IJ-68VAC	1968 All w/ Air Conditioning.....	299.99 ea.



**1969 Dash Carrier**

GM licensed reproduction 1969 Chevelle dash carrier. This hard to find item is crafted using injection molding and features correct pebble grain with chrome accenting.

IJ-69V	1969 All w/ Astro Ventilation.....	174.99 ea.
IJ-69VAC	1969 All w/ AC.....	177.99 ea.
IJ-69W	1969 All w/o Astro Vents.....	159.99 ea.



DASHKIT-66SS

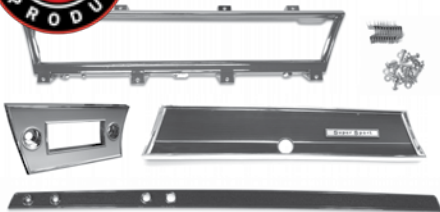

**1966-67 SS Dash Trim Kit**

This is a complete set of dash trim panels to restore your pitted or damaged originals. Each kit includes a speedometer bezel, a dash ignition panel, a glove box faceplate, a radio bezel and hardware.

DASHKIT-66SS	1966 Super Sport.....	265.46 kit
DASHKIT-66M	1966 Malibu / El Camino.....	265.46 kit
DASHKIT-67SS	1967 Super Sport.....	276.45 kit
DASHKIT-67M	1967 Malibu / El Camino.....	276.45 kit

*Note: Malibu originally came with a woodgrain dash ignition bezel which is unavailable. The black SS style has been substituted into this kit and will fit as original and look great! No Volume Discount.*



**Speedometer Bezel** NC-701

Beautiful reproduction of this often dulled or cracked speedometer bezel.

NC-701	1966-67 All.....	52.99 ea.
--------	------------------	-----------



IDB-7888

**1978-1988 El Camino, Malibu, Monte Carlo**

**Polished Aluminum Ring Set for Gauge Bezels**

This set of six polished aluminum rings/bezels highlight the six factory gauge holes found in 1978-88 Chevrolet Monte Carlo, El Camino and Malibu models; these rings will fit original and reproduction gauge housings. A clever appearance upgrade that enhances the factory dash cluster while still retaining the original basic appearance.

IDB-7888	1978-88 Monte.....	49.95 set
----------	--------------------	-----------



IDS-66

Detail

**Dash Ignition Panels**

Beautiful reproduction of this often damaged upper panel. Crafted in correct rough grain and features cut out templates for ignition and wipers.

IDS-66	1966 Super Sport.....	124.99 ea.
IDS-67	1967 Super Sport.....	124.99 ea.



IGD-66S



ICC-0967

**Glove Box Faceplates**

Re-tooled high quality reproduction plates.

IGD-66S	1966 SS.....	59.99 ea.
IGD-66M	1966 Malibu.....	59.99 ea.
ICC-0967	1967 SS.....	64.99 ea.
ICC-0967M	1967 Malibu.....	64.99 ea.



ICC-1440

**Glove Box Chrome**

Beautiful new reproduction chrome strips for your glove box.

ICC-1440	1964 Malibu.....	21.95 ea.
ICC-1441	1964 Malibu SS.....	21.95 ea.
ICC-1443	1965 Malibu.....	21.95 ea.
ICC-1444	1965 Malibu SS.....	21.95 ea.
ICC-E64	1964 El Camino.....	21.95 ea.
ICC-E65	1965 El Camino.....	19.95 ea.

*Includes correct hardware.*



IC-2760



IC-2780

**Dash Emblems**

If your bezel is in good shape, we offer the emblems separately.

IC-2760	1966 Super Sport.....	11.99 ea.
IC-2780	1967 Super Sport.....	11.99 ea.
IK-0046	1969 Astro Ventilation.....	13.99 ea.
IK-7377	1973-77 SS.....	54.99 ea.



IGB-75K

Detail



**Dash Plaque Inserts**

OE style reproduction of the insert which attaches to your original dash plaque. Now available as a complete assembly with housing.

IGB-75	1968 SS396 Insert Only.....	44.99 ea.
IGB-75K	1968 SS396 w/ Housing.....	109.99 ea.
IGB-76	1969 SS396 Insert Only.....	42.99 ea.
IGB-76K	1969 SS396 w/ Housing.....	109.99 ea.



CH-EL67

**1966-67 Dash Trim Hardware Set**

Correct hardware for mounting dash ignition panel, glove box face plate and speedometer bezel.

CH-EL67	1966-67 All.....	26.99 set
---------	------------------	-----------



IQ-507



IDK-44



IQ-607

**Ignition Bezel & Nut**

OE style reproduction of this special nut.

IQ-507	1966-67 Bezel.....	10.99 ea.
IQ-2493-OE	1966 Bezel Nut OE Style.....	35.99 ea.
IDK-44	1968 Bezel.....	29.99 ea.
IQ-607	1968 Nut.....	13.99 ea.



GHR-88

**Headlamp Switch Nut**

Correct special nut used for retaining switch to the dash.

GHR-66	1966-67.....	11.99 ea.
GHR-88	1969-72 All.....	12.99 ea.



IRB-66

**1966-67 Radio Bezels**

Awesome new high quality reproduction radio bezels featuring fine detailing and correct grain with accenting.

IRB-66	1966 All .....	29.99 ea.
IRB-67	1967 All .....	29.99 ea.



**Radio Lenses**

IRL-2121

Authentic reproduction radio lenses with correct lettering and colors.

IRL-2120	1969-70 Mono, 1970 AM/FM.....	33.99 ea.
IRL-2121	1969 AM/FM.....	33.99 ea.
IRL-4615	1971-76 AM/FM Mono .....	34.99 ea.
IRL-4616	1971-76 AM/FM Stereo .....	34.99 ea.



IQ-66 IBN-66 IK-214  
IDK-42 IDK-41 IQ-05

**Wiper Knobs**

OE style chrome reproduction wiper knobs with correct textures and designs.

IQ-66	1966 All .....	19.99 ea.
IBN-66	1964-67 Retainer Nut.....	6.99 ea.
IK-214	1967 All .....	10.99 ea.
IDK-42	1968 All .....	29.99 ea.
IDK-41	1968 Bezel.....	29.99 ea.
IQ-05	1969-71 All .....	6.99 ea.



**1968 Dash Knob Kit**

Complete set of dash knobs for your 1968 Chevelle including headlight knob, wiper knob, wiper knob bezel, dash lighter bezel and dash ignition bezel.

IDK-KIT	Complete Knob Set .....	142.45 kit
---------	-------------------------	------------



**Hazard Lamp Knob**

Brand new chrome flasher knob.

IFK-3	1967-72 All .....	11.95 ea.
IFK-1	1967-70 Long Style.....	13.99 ea.
IFK-7888	1978-88 4pc Set .....	22.99 set

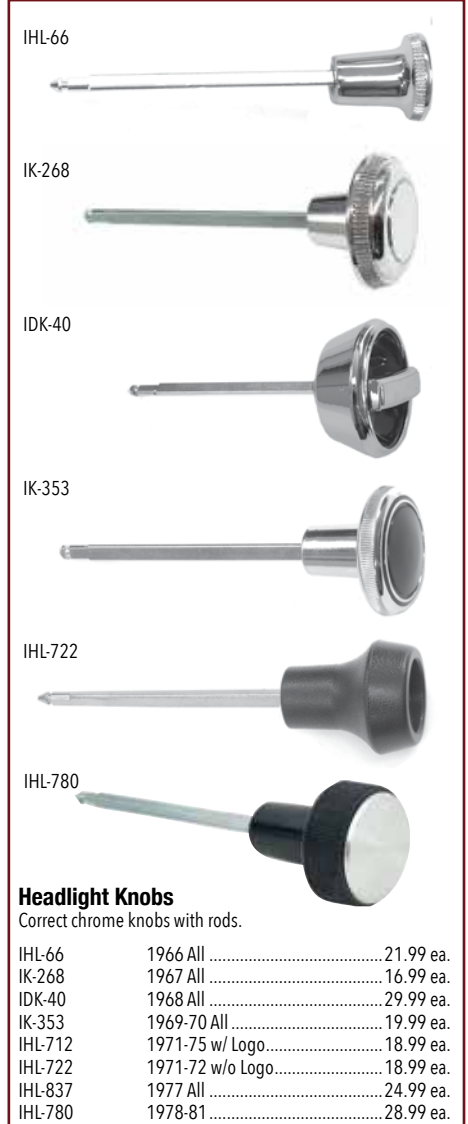

IHL-66  
IK-268  
IDK-40  
IK-353  
IHL-722  
IHL-780  
IHL-66  
IK-268  
IDK-40  
IK-353  
IHL-722  
IHL-780

**Headlight Knobs**

Correct chrome knobs with rods.

IHL-66	1966 All .....	21.99 ea.
IK-268	1967 All .....	16.99 ea.
IDK-40	1968 All .....	29.99 ea.
IK-353	1969-70 All .....	19.99 ea.
IHL-712	1971-75 w/ Logo.....	18.99 ea.
IHL-722	1971-72 w/o Logo.....	18.99 ea.
IHL-837	1977 All .....	24.99 ea.
IHL-780	1978-81 .....	28.99 ea.



DSE121605

**DSE Billet Headlight Knob**

A great complement to your DSE Selecta-Speed wiper kit!

DSE121605	1964-67 .....	22.99 ea.
-----------	---------------	-----------



IK-66  
IK-661  
IK-213  
IK-231  
IK-671  
IK-245  
IRT-75  
IRK-712

**Radio Knobs**

Correct inner and outer radio knobs.

IK-66	1964-67 Outer .....	24.99 pr.
IK-661	1966 Inner .....	24.99 pr.
IK-213	1967 Outer .....	22.99 pr.
IK-671	1967 Inner .....	21.99 pr.
IK-520S	1967 Inner Stereo Black .....	8.99 pr.
IK-231	1969-70 Inner Mono .....	13.99 pr.
IK-231S	1969-70 Inner Stereo .....	15.99 pr.
IK-245	1969-70 Outer .....	20.99 pr.
IRT-712	1971-73 Inner Mono .....	27.99 pr.
IRT-75	1971-72 Inner Stereo .....	27.99 pr.
IRK-712	1971-72 Outer w/ Logo.....	27.99 pr.



IDK-69SC

IDK-69C

**1969-70 Dash Knob Kits**

This complete dash knob set will replace the old or worn out original knobs and help bring your dash back to a factory fresh appearance. Includes the lighter knob with element, light switch knob, radio knobs, and windshield washer knob.

IDK-69SC	Stereo.....	29.99 set
IDK-69C	Mono.....	29.99 set





**Interior Dash Tools**

Handy tools for easily removing and installing dash nuts.

TRIM-HL	1964-72 Headlamp Nut.....	12.95 ea.
TRIM-HL	1964-68 Wiper Nut.....	12.95 ea.
TRIM-IGN	1964-68 Ignition Nut 3 Prong.....	11.95 ea.
TRIM-IGNX66	1964-68 Ignition Nut 4 Prong.....	14.99 ea.
TRIM-GB	1969-77 Glove Box Nut.....	13.99 ea.



**Dash Ash Tray**

Complete ash tray assembly for Super Sport dash.

IAT-69DASH	1969 All.....	99.99 ea.
ICA-70	1970-72 Super Sport.....	59.99 ea.



**Cigarette Lighter Assemblies**

Brand new cigarette lighter assemblies.

ILA-64	1964 All.....	26.99 ea.
ILA-656	1965-66 All.....	25.99 ea.
IK-298	1967 All.....	24.99 ea.
ICG-68	1968 All.....	23.95 ea.
ICG-70	1969-70 All.....	23.95 ea.
ICG-71	1971-72 All.....	23.95 ea.
ICG-78	1978-88 All.....	42.95 ea.



**Cigarette Lighter Housings**

Correct 2 piece dash housings for lighter assemblies.

ICH-64K	1964-70 All.....	30.00 ea.
ICH-72K	1971-72 All.....	26.95 ea.



**Glove Box Latch Striker**

A new latch striker will ease the opening and closing of your glove box door.

ILS-A70	1970-72 All.....	11.99 ea.
---------	------------------	-----------



**Glove Boxes**

Brand new correctly die-stamped glove boxes.

IGB-164	1964-65 w/o AC.....	26.99 ea.
IGB-164A	1964-65 w AC.....	26.99 ea.
IGB-166	1966-67 w/o AC.....	26.99 ea.
IGB-166A	1966-67 w/ AC.....	26.99 ea.
IGB-169	1968-69 w/o AC.....	26.99 ea.

**Glove Box Screws**

IQ-402	1964-69 (7).....	3.95 kit
--------	------------------	----------



**Glove Box Door Arm Bumper**

Installs on the glove box door arm to prevent rattling.

IGB-645	1964-65.....	4.99 ea.
IGB-023	1966-72.....	6.99 ea.



**Glove Box Door**

OE style reproduction with swing arm.

IGD-1454	1970-72 All*.....	49.99 ea.
----------	-------------------	-----------

\*Includes inner panel.



**Glove Box Lock Casing**

This is the assembly that holds your lock cylinder in place and is commonly broken or damaged.

IJ-3350	1966-67.....	52.99 ea.
LGC-6881	1968-77.....	11.99 kit



**Glove Box Lamp Kit**

Correct lamp with harness, switch, & bulb.

18000	1964-69 All.....	20.99 kit
33830	1970-71 Harness.....	23.99 ea.
GCL-702	1970-71 Housing and Switch.....	34.99 ea.
GCL-702K	1970-71 Housing, Switch, Harness Kit.....	53.08 kit



**Courtesy Lamp Harness**

Correct harness for under dash light.

28450	1964-65 All.....	43.99 ea.
28490	1966-67 All.....	38.99 ea.
28530	1968 All.....	40.99 ea.
28950	1969-70 All.....	41.99 ea.
15295	1971-72 All.....	42.99 ea.



**Courtesy Lamp Bracket**

Correct under dash bracket for lamp.

ICB-9	1964-72 All.....	10.99 ea.
-------	------------------	-----------

2 required per car.



6430420

**1966-67 Fuel Gauge**

OE style fuel gauge for cars with warning lights.

6430420 1966-67 .....104.99 ea.



6480638

**1968 Fuel Gauge**

OE style fuel gauge for cars with warning lights.

6480638 1968 .....193.99 ea.



6431251

**1969 Fuel Gauge**

Fuel gauge is calibrated at the factory and is manufactured to original specs for a perfect fit, function and appearance.

6431251 1969 .....189.99 ea.  
*Note: For cars with warning lights. No Volume Discount.*



ITT-609

**1970-72 Temp & Fuel Gauges**

OE style reproduction Super Sport temp & fuel gauges complete with housing.

ITT-609 1970 SS.....169.95 ea.  
ITT-610 1971-72 SS.....169.95 ea.



S535-G

**1970-72 Volt Gauge Conversion**

This is a Shiftworks voltmeter that replaces the ammeter.

S535-G 1970 .....99.99 ea.

S535-W 1971-72 .....99.99 ea.

*No Volume Discount.*



ITT-603

**1970-72 Amp Gauge**

OE style reproduction amp gauge complete with housing.

ITT-603 1970 SS.....96.95 ea.

ITT-612 1971-72 SS.....96.95 ea.



3863459

**1965 Dash Clock**

New GM licensed reproduction with quartz movement.

3863459 1965 All .....189.99 ea.

*No Volume Discount.*



ICLK-65

**1965 Top Of Dash Clock**

New reproduction of the rare optional Chevelle top of dash clock with correct face and modern quartz movement.

ICLK-65 1965-66 All .....259.99 ea.

*No Volume Discount.*



3919015

**1968 Dash Clock**

New GM licensed reproduction with quartz movement. For cars equipped with warning lights.

3919015 1968 All With Warning Lights ....234.99 ea.



6481543

**1968 Clock/Gauge Cluster**

OE style reproduction clock and gauge cluster including battery, fuel, oil and temperature. Correct lettering and colors for an authentic restoration.

6481543 1968 .....349.99 ea.

*No Volume Discount.*



3948956

**1969 Clock**

Manufactured to factory specs for an original fit, function and appearance, this clock has quartz movement for accuracy. Features the correct number font, coloring and markings as original.

3948956 1969 .....179.99 ea.

*Note: For cars with or without warning lights. No Volume Discount.*



IN-60

**Clock Knob Set**

Two replacement knobs for early or late models complete with retaining nuts.

IN-60 1964-72 All (2 pc.) .....14.99 ea.



7196465

**1965 Gauge Cluster**

OE style reproduction gauge cluster featuring fuel, oil, temperature and battery.

7196465 1965 .....269.99 ea.  
*No Volume Discount.*



6456882

**Speedometers**

GM licensed, correctly calibrated and detailed to perfection.

6456882 1966-67 All .....199.99 ea.  
*No Volume Discount.*



6407726

**1964-65 Speedometer**

GM licensed, correctly calibrated, & detailed to perfection.

6407726 1964-65 All .....219.99 ea.  
*No Volume Discount.*



6492545

**1968 Speedometer**

This 120 MPH speedometer is manufactured to factory specs for a trouble free installation.

This gauge does not feature the speed warning indicator.  
6492545 1968 All .....269.99 ea.



6492542

**1969 Speedometer**

This 120 mph speedometer gauge is manufactured to exact factory specs for a perfect fit, function and appearance.

6492542 1969 .....259.99 ea.  
*No Volume Discount.*



IDT-510

**1964-1965 Chevelle Dash Tachometer**

This is a correct reproduction of the optional dash tachometer manufactured to factory specs with 6k redline.

IDT-510 1964-65 All .....259.95 ea.  
*No Volume Discount.*



IDT-6955

**1969 Tach & Gauges**

This is an exact replacement for your original cluster or can be used as an upgrade to a non-gauge car with our conversion harness.

IDT-6950 1969 5000 Redline.....239.95 ea.  
IDT-6955 1969 5700 Redline.....259.99 ea.  
IDT-6960 1969 6000 Redline.....259.99 ea.  
IDT-69HRN Conversion Harness .....124.99 ea.  
*No Volume Discount.*



IKK-6602

**1966 Knee Knocker Tach**

IKK-6602 1966 5500 Redline.....194.99 ea.  
IKK-6603 1966 6000 Redline.....194.99 ea.  
*No Volume Discount.*



IT-6755

**1967 Blinker Tach**

IT-6755 1967 5500 Redline.....179.99 ea.  
IT-6760 1967 6000 Redline.....179.99 ea.  
*No Volume Discount.*



RT80SLF

**Classic Rocket Tach**

Retro style, with color changing rocket.

RT80SLF 1964-77 6500 Redline .....200.99 ea.



EHT-335

**Dixco Style Hood Tach**

These were used on several aftermarket applications for super cars including Yenko and Motion. White, paint to match.

EHT-335 1964-77 User Sets Redline .....209.99 ea.



IGC-67

**1966-67 Gauge Conversion Kit**

This is a complete set of fuel/battery and temperature/oil gauges complete with sending installation kit that lets you convert to a Super Sport style dash. A kit is also available with high pressure oil pumps in mind. It will show the same reading of the low pressure gauge at 60 psi.

IGC-67 1966-67 w/ Ammeter..... 199.99 kit  
IGC-67V 1966-67 w/ Voltmeter..... 199.99 kit  
S505-HOP 1966-67 w/ Ammeter, High Oil Pres ..... 209.99 kit  
S505-VHOP 1966-67 w/ Voltmeter, High Oil Pres ..... 209.99 kit

*No Volume Discount.*



6468821

**1968 Tach**

OE style reproduction for your original gauge cluster.

6468821	1968 5000 Redline.....	209.99 ea.
6468822	1968 5500 Redline.....	209.99 ea.
6468823	1968 6000 Redline.....	209.99 ea.

No Volume Discount.



IJ-68TB-LENS



IJ-68TB

**1968 Chevelle Tachometer Bezel and Lens**

Reproduction tachometer lens & bezel for cars with factory roller tach.

IJ-68TB	1968 Bezel Black.....	42.99 ea.
IJ-68TB-LENS	1968 Lens .....	41.99 ea.



**River City Muscle Cars 1966-67 Dash Inserts**

This 1966-1967 Chevelle dash panel insert is designed for easy installation to replace the original gauge cluster. Each panel is made from 16 gauge steel for a solid fit and quality look. This panel is designed for six of your own gauges: Two 3-1/8 gauges (Speedometer and Tach) and four 2-1/16 inch gauges (Volt, Oil Pressure, Water Temp and Fuel Level). This dash panel also comes with three .434 diameter holes for turn signals and high beam indicator.

RCMC-6667CDIR	Paintable Bare Steel .....	134.99 ea.
RCMC-6667CDIPCB	Black.....	169.99 ea.
RCMC-6667CDI	Chrome.....	199.99 ea.



**1970-72 Super Sport Dashes**

Whether you are replacing a cracked original dash or converting from a sweep style dash to an SS dash, Ground Up Motor Sports has you covered! Choose from our SS Dash Conversion Kit or simple Dash Carrier Kit. These dashes are NICE!

Our Deluxe SS Dash Conversion Kit includes the dash carrier with side vent assemblies, dash lens, ash tray, glove box door, steering column cover, dash housing, steel backing panel, speedometer, tachometer, clock, temp/fuel gauge, amp gauge, instrument sockets, printed circuit board, OEM or modern ATO type dash harness with fuse box and OEM forward lamp harness or engine harness and correct hardware.

Add "ATO" at end of part number for ATO style dash harness.

SSDASH-7055	1970 SS Deluxe 5500 RPM Tach.....	2274.69 kit
SSDASH-7065	1970 SS Deluxe 6500 RPM Tach.....	2274.69 kit
SSDASH-7155	1971 SS Deluxe 5500 RPM Tach.....	2299.89 kit
SSDASH-72400	1972 SS Deluxe 307, 350, TH400.....	2282.79 kit
SSDASH-7255	1972 SS Deluxe 307, 350 PG TH350.....	2282.79 kit
SSDASH-72BBA	1972 SS Deluxe BB Automatic.....	2256.69 kit
SSDASH-72BBM	1972 SS Deluxe BB 4 Speed .....	2282.79 kit



IBL-702

**SS Brake Light Lens**

OE style reproduction of this hard to find lens.

IBL-702	1970-72 All Super Sport.....	13.95 ea.
---------	------------------------------	-----------



GG5-70A

**1970-72 Light Switch/Gauge Ground Strap**

Used on all cars with factory round gauges to assure proper gauge operation. Includes plastic head lamp switch retaining nut.

GG5-70A	1970-72 w/ Gauges .....	29.95 ea.
---------	-------------------------	-----------



SSDASH-HRDW-KIT

**1970-72 Super Sport Dash Hardware Kit**

The kit includes the hardware required to install your SS dash conversion.

SSDASH-HRDW-KIT	1970-72 SS.....	13.95 kit
-----------------	-----------------	-----------

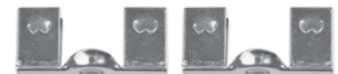

IDC-67F

**1970-72 Dash Carrier Clips**

These are the correct clips used to fasten the heater controls to the plastic dash carrier.

IDC-67F	1970-72 SS.....	6.99 pr.
---------	-----------------	----------



IJ-70VC

Our SS Dash Carrier is also available separately and features correct grain with bright chrome trim.

IJ-70VC	1970-72 SS Carrier Only .....	419.99 ea.
---------	-------------------------------	------------

All dashes & kits ship Oversize. Not eligible for free shipping. No Additional Discounting. Hardware not included.



IHP-702

**1970-72 Center Dash AC Delete Plate**

AC delete plate with the Chevrolet logo which fills the hole above the heater controls.

IHP-702	1970-72 Chevrolet.....	39.95 ea.
---------	------------------------	-----------



GAC-70SS

**Instrument Socket**

GAC-70SS	1970-72 SS .....	3.95 ea.
GAC-70SS-KIT	1970-72 SS (14 pc.).....	49.95 kit



IBK-70SS

Our Junior Dash Carrier Kit includes dash carrier, ash tray, glove box door, steering cover and dash lens.

IBK-70SS	1970-72 SS Junior Kit.....	572.27 kit
----------	----------------------------	------------



6493057W

### 1970-72 Speedometers

OE style reproductions with correct letters.

6493057A	1970 SS.....	199.95 ea.
6493057W	1971-72 SS.....	199.95 ea.
6493057A-AC	1970 SS*.....	218.95 ea.
6493057W-AC	1971-72 SS*.....	218.95 ea.

\*For cars with automatic on the column.  
No Volume Discount.



6469985

### 1970-72 Tachometers

OE style reproduction tachometer for Super Sport manufactured to exact factory specs.

6469985	1970 5500 Redline.....	174.95 ea.
6469983	1970 6500 Redline.....	174.95 ea.
5657405	1971-72 5000 Redline.....	169.95 ea.
5657406	1971-72 5500 Redline.....	169.95 ea.
5657407	1971 6500 Redline.....	159.99 ea.



3973633W

### 1970-72 Dash Clocks

OE style reproductions with correct letters.

3973633A	1970 SS.....	166.99 ea.
3973633W	1971-72 SS.....	166.99 ea.

No Volume Discount.



SSDASH-GAUGE-5500

### 1970-72 Complete Super Sport Gauge Cluster

These Super Sport dash cluster kits come complete with new gauges, tachometer, printed circuit board, lens and housing. This cluster is for cars with floor shift and no dash mounted gear indicator. All 1970 gauges have green letters, 1971-72 have white letters.

SSDASH-GAUGE-5500	1970 SS 5500 RPM Tach.....	799.99 kit
SSDASH-GAUGE-6500	1970 SS 6500 RPM Tach.....	799.99 kit
SSDASH-GAUGE-5500-W	1971-72 SS 5500 RPM Tach.....	939.99 kit
SSDASH-GAUGE-6500-W	1971-72 SS 6500 RPM Tach.....	859.99 kit



### 1970-72 Super Sport Gauge Kits

This Chevelle Super Sport dash gauge upgrade kits comes with new gauges, tachometer, oil pressure, fuel and amp gauges. These gauges are as close to OE original as you can get. They feature the correct fonts, colors, the tach has the correct three screws and not two rivets like other incorrect reproduction. The tach also does not have a needle stop just like the original GM gauge. The fuel, oil and amp gauge come complete with their metal mounting plates. This kit is for cars with floor shift and no dash mounted gear indicator. 1970 gauges have green letters, 1971-72 have white letters.

SSDASH-5500-UP-G	1970 SS 5500 RPM Tach.....	379.99 kit
SSDASH-6500-UP-G	1970 SS 6500 RPM Tach.....	379.99 kit
SSDASH-5000-UP-W	1971-72 SS 5000 RPM Tach.....	379.99 kit
SSDASH-5500-UP-W	1971-72 SS 5500 RPM Tach.....	379.99 kit
SSDASH-6500-UP-W	1971-72 SS 6500 RPM Tach.....	379.99 kit

This kit does not come with a clock or speedometer.

### Dakota Digital RTX Gauge Kits

The RTX series is the latest from Dakota Digital, focused on retaining that stock look without sacrificing the late-model features you love. Every effort has been put forth to incorporate OEM design elements regarding the layout, face styling and indicators. A casual glance may dismiss these as original equipment, but once you hit the switch and the LED back lighting comes on in your favorite color scheme, all doubts will be removed.

RTX-66C-CVL-X	1966-67.....	1515.95 kit
RTX-70C-CVL-X	1970-72 Super Sport.....	1515.95 kit
RTX-78C-MC-X	1978-85 Monte Carlo.....	1515.95 kit
RTX-86C-MC-X	1986-88 Monte Carlo.....	1515.95 kit
RTX-84B-REG-X	1984-87 Regal GNX.....	1515.95 kit

No Volume Discount.



RTX-70C-CVL-X

RTX-66C-CVL-X

### LED Dash Bulbs

A simple direct replacement for your original 194 style dash light bulbs. Excellent to increase brightness and reduce heat and power consumption.

DT-200008	194 Red LED Bulbs.....	15.95 pr.
DT-200009	194 Amber LED Bulbs.....	15.95 pr.
DT-200016	194 White LED Bulbs.....	16.95 pr.



DT-200016



DT-200008

**1970-1972 Chevelle Super Sport Dash Conversion Kits w/ Dakota Digital Gauges**

Whether you are replacing an original dash or converting from a sweep style dash to a Super Sport dash, but want more modern functionality from your instrumentation than stock gauges can provide, Ground Up Motor Sports has you covered! This deluxe 1970-1972 Chevelle SS dash conversion kit includes a Dakota Digital VFD3, VHX, RTX or HDX Series Instrument System, as well as the standard components featured in our factory SS dash conversion kits!

**VFD3 KITS**

SSDASH-VFD-B Blue Illumination.....1312.31 kit

**HDX KITS**

Each HDX user selectable illumination kit allows the user to select independent illumination colors for the gauge readings and needles, as well as the message centers.

SSDASH-HDX-K Black Face..... 1934.26 kit

SSDASH-HDX-S Silver Face..... 1934.26 kit

**RTX KIT**

30 Color User Selectable illumination.

SSDASH-RTX Black Face.....2029.26 kit

**VHX KITS**

SSDASH-VHX-KB Blue Illumination Black Face .....1506.26 kit

SSDASH-VHX-KR Red Illumination Black Face..... 1506.26 kit

SSDASH-VHX-KW White Illumination Black Face ..... 1506.26 kit

SSDASH-VHX-SB Blue Illumination Silver Face..... 1506.26 kit

SSDASH-VHX-SR Red Illumination Silver Face..... 1506.26 kit

SSDASH-VHX-SW White Illumination Silver Face..... 1506.26 kit

SSDASH-VHX-CB Blue Illumination Carbon Fiber Face ..... 1506.26 kit

SSDASH-VHX-CR Red Illumination Carbon Fiber Face.....1506.26 kit

*This kits ship oversize. No Volume Discount.*



Blue Illumination



White Illumination w/ Blue Needles



Teal Illumination



Green Illumination



Red Illumination



White Illumination w/ Red Needles



SSDASH-VFD-B



SSDASH-VHX-SR



CV66GS



CV66B



CV66G



CV66VSB

### Classic Instruments Direct Fit Gauge Kit

Add a totally custom yet vintage look to your interior with these gauges from Classic Instruments. Includes everything to install Classic Instruments into a factory dashboard. The gauges will be mounted into a factory gauge panel and come complete with a wiring harness. These kits feature all-electric cluster, bright LEDs for even illumination, seamless fit into existing dash, snap-in wire harness for easy installation, all necessary sending units included, turn signal and high beam indicators are in the stock locations, includes built-in shift light and warning light.

CV66B	1966-67 All Back Face .....	929.99 kit
CV66G	1966-67 All Gray Face .....	929.99 kit
CV66GS	1966-67 All G-stock Face .....	929.99 kit
CV66VSB	1966-67 All Velocity Black Face .....	929.99 kit



HDX-64C-CVL-K



HDX-69C-CVL-K



HDX-68C-CVL-K



HDX-70C-CVL-S

### Dakota Digital HDX Gauge Kits

Ushering in a new era of muscle machines, Chevelles have long been turned into hot rods. Keep the tradition alive and bring yours up to spec with this direct-fit instrument system! It attaches directly to a stock or reproduction bezel (available separately) and supplies you with six analog gauge sweeps and a pair of high visibility TFT message centers. Available with your choice of black or silver alloy gauge-face styling, each HDX system allows the user to select independent illumination colors for the gauge readings and needles, as well as the message centers.

HDX-64C-CVL-S	1965-65 Silver Alloy Face .....	1420.95 ea.
HDX-64C-CVL-K	1965-65 Black Alloy Face .....	1295.95 ea.
HDX-66C-CVL-S	1966-67 Silver Alloy Face .....	1420.95 ea.
HDX-66C-CVL-K	1966-67 Black Alloy Face .....	1420.95 ea.
HDX-68C-CVL-S	1968 Silver Alloy Face .....	1295.95 ea.
HDX-68C-CVL-K	1968 Black Alloy Face .....	1420.95 ea.
HDX-69C-CVL-S	1969 Silver Alloy Face .....	1420.95 ea.
HDX-69C-CVL-K	1969 Black Alloy Face .....	1420.95 ea.
HDX-70C-CVL-S	1970-72 Silver Alloy Face .....	1420.95 ea.
HDX-70C-CVL-K	1970-72 Black Alloy Face .....	1420.95 ea.

No Volume Discount.



VHX-64C-CVL-S-R



VHX-66C-CVL-C-B

**Dakota Digital VHX Instruments**

Fully lit needles, backlit faces and highly visible LCD message centers are a few of the things that you can see which set the VHX Series apart from yesterday's traditional approach to instrumentation. A few of the features which you don't normally see are the micro-controlled precision stepper motors, solid state sensors for unparalleled accuracy and user-customizable display feedback, all supported by an unrivaled limited lifetime warranty which has become the standard for Dakota Digital instrumentation systems. Completely engineered and manufactured in the USA, the VHX Series has completely revolutionized the instrumentation industry!

**1964-65 VHX Instrument System**

VHX-64C-CVL-S-R	Silver Alloy Faces, Red Numbers .....	850.95 kit
VHX-64C-CVL-S-B	Silver Alloy Faces, Blue Numbers .....	850.95 kit
VHX-64C-CVL-C-R	Carbon Fiber Faces, Red Numbers.....	850.95 kit
VHX-64C-CVL-C-B	Carbon Fiber Faces, Blue Numbers .....	850.95 kit
VHX-64C-CVL-K-R	Black Alloy Faces, Red Numbers.....	850.95 kit
VHX-64C-CVL-K-B	Black Alloy Faces, Blue Numbers.....	850.95 kit

*Fits directly into stock bezel (not included).*

**1966-67 VHX Instrument System**

VHX-66C-CVL-S-R	Silver Alloy Faces, Red Numbers .....	850.95 kit
VHX-66C-CVL-S-B	Silver Alloy Faces, Blue Numbers .....	850.95 kit
VHX-66C-CVL-C-R	Carbon Fiber Faces, Red Numbers.....	850.95 kit
VHX-66C-CVL-C-B	Carbon Fiber Faces, Blue Numbers .....	850.95 kit
VHX-66C-CVL-K-R	Black Alloy Faces, Red Numbers.....	850.95 kit
VHX-66C-CVL-K-B	Black Alloy Faces, Blue Numbers.....	850.95 kit

*Fits directly into stock bezel (not included).*

**1968 VHX Instrument System**

VHX-68C-CVL-S-R	Silver Alloy Faces, Red Numbers .....	850.95 kit
VHX-68C-CVL-S-B	Silver Alloy Faces, Blue Numbers .....	850.95 kit
VHX-68C-CVL-C-R	Carbon Fiber Faces, Red Numbers.....	850.95 kit
VHX-68C-CVL-C-B	Carbon Fiber Faces, Blue Numbers .....	850.95 kit
VHX-68C-CVL-K-R	Black Alloy Faces, Red Numbers.....	850.95 kit
VHX-68C-CVL-K-B	Black Alloy Faces, Blue Numbers.....	850.95 kit

*Fits directly into stock bezel (not included).*

**1969 VHX Instrument System**

VHX-69C-CVL-S-R	Silver Alloy Faces, Red Numbers .....	850.95 kit
VHX-69C-CVL-S-B	Silver Alloy Faces, Blue Numbers .....	850.95 kit
VHX-69C-CVL-C-R	Carbon Fiber Faces, Red Numbers.....	850.95 kit
VHX-69C-CVL-C-B	Carbon Fiber Faces, Blue Numbers .....	850.95 kit
VHX-69C-CVL-K-R	Black Alloy Faces, Red Numbers.....	850.95 kit
VHX-69C-CVL-K-B	Black Alloy Faces, Blue Numbers.....	850.95 kit

*Fits directly into stock bezel (not included).*

**1970-72 Super Sport VHX Instrument System**

VHX-70C-CVL-S-R	Silver Alloy Faces, Red Numbers .....	945.95 kit
VHX-70C-CVL-S-B	Silver Alloy Faces, Blue Numbers .....	945.95 kit
VHX-70C-CVL-C-R	Carbon Fiber Faces, Red Numbers.....	945.95 kit
VHX-70C-CVL-C-B	Carbon Fiber Faces, Blue Numbers .....	945.95 kit
VHX-70C-CVL-K-R	Black Alloy Faces, Red Numbers.....	945.95 kit
VHX-70C-CVL-K-B	Black Alloy Faces, Blue Numbers.....	945.95 kit

*Fits directly into stock bezel (not included).*

**1970-72 Sweep Style VHX Instrument System**

VHX-70C-MAL-S-R	Silver Alloy Faces, Red Numbers .....	850.95 kit
VHX-70C-MAL-S-B	Silver Alloy Faces, Blue Numbers .....	850.95 kit
VHX-70C-MAL-C-R	Carbon Fiber Faces, Red Numbers.....	850.95 kit
VHX-70C-MAL-C-B	Carbon Fiber Faces, Blue Numbers .....	850.95 kit
VHX-70C-MAL-K-R	Black Alloy Faces, Red Numbers.....	850.95 kit
VHX-70C-MAL-K-B	Black Alloy Faces, Blue Numbers.....	850.95 kit

*Fits directly into stock bezel (not included).*

**1973-77 Chevelle, Monte, El Camino Instrument System OE Round Gauges**

VHX-73C-CVL-S-R	Silver Alloy Faces, Red Numbers .....	898.95 kit
VHX-73C-CVL-S-B	Silver Alloy Faces, Blue Numbers .....	898.95 kit
VHX-73C-CVL-S-W	Silver Alloy Faces, White Numbers.....	898.95 kit
VHX-73C-CVL-K-R	Black Alloy Faces, Red Numbers.....	898.95 kit
VHX-73C-CVL-K-B	Black Alloy Faces, Blue Numbers.....	898.95 kit
VHX-73C-CVL-K-W	Black Alloy Faces, White Numbers .....	898.95 kit

**1973-77 Malibu, El Camino Instrument System OE Sweep Gauges**

VHX-73C-MAL-S-R	Silver Alloy Faces, Red Numbers .....	898.95 kit
VHX-73C-MAL-S-B	Silver Alloy Faces, Blue Numbers .....	898.95 kit
VHX-73C-MAL-S-W	Silver Alloy Faces, White Numbers.....	898.95 kit
VHX-73C-MAL-K-R	Black Alloy Faces, Red Numbers.....	898.95 kit
VHX-73C-MAL-K-B	Black Alloy Faces, Blue Numbers.....	898.95 kit
VHX-73C-MAL-K-W	Black Alloy Faces, White Numbers .....	898.95 kit

**1978-88 Malibu, Monte, El Camino Instrument System OE Round Gauges**

VHX-78C-MC-S-R	Silver Alloy Faces, Red Numbers .....	850.95 kit
VHX-78C-MC-S-B	Silver Alloy Faces, Blue Numbers .....	850.95 kit
VHX-78C-MC-S-W	Silver Alloy Faces, White Numbers.....	850.95 kit
VHX-78C-MC-C-R	Carbon Fiber Faces, Red Numbers.....	850.95 kit
VHX-78C-MC-C-B	Carbon Fiber Faces, Blue Numbers .....	850.95 kit
VHX-78C-MC-K-R	Black Alloy Faces, Red Numbers.....	850.95 kit
VHX-78C-MC-K-B	Black Alloy Faces, Blue Numbers.....	850.95 kit
VHX-78C-MC-K-W	Black Alloy Faces, White Numbers .....	850.95 kit

**1978-88 Malibu, Monte, El Camino Instrument System OE Sweep Gauges**

VHX-78C-MAL-S-R	Silver Alloy Faces, Red Numbers .....	850.95 kit
VHX-78C-MAL-S-B	Silver Alloy Faces, Blue Numbers .....	850.95 kit
VHX-78C-MAL-S-W	Silver Alloy Faces, White Numbers.....	850.95 kit
VHX-78C-MAL-K-R	Black Alloy Faces, Red Numbers.....	850.95 kit
VHX-78C-MAL-K-B	Black Alloy Faces, Blue Numbers.....	850.95 kit
VHX-78C-MAL-K-W	Black Alloy Faces, White Numbers .....	850.95 kit







IAC-667



IAC-1456

**Heater Control Assembly**

Excellent quality reproduction heater control assemblies with lenses, knobs and levers.

IAC-667	1966-67 w/o AC	179.99 ea.
IAC-1456	1970 w/ AC	169.95 ea.
IAC-1457	1971-72 w/ AC	159.99 ea.



IM-196

**Heater Control Lenses**

Correct letters and backgrounds.

IM-196	1966-67 w/o AC	26.99 ea.
IM-197	1966-67 w/ AC	26.99 ea.
IM-68	1968 w/o AC	24.99 ea.
IM-68A	1968 w/ AC	24.99 ea.
IM-69	1969 w/o AC	24.99 ea.
IM-69A	1969 w/ AC	24.99 ea.
IM-296	1970 w/o AC	26.99 ea.
IM-297	1970 w/ AC	26.99 ea.
IM-301	1971-72 w/o AC	22.99 ea.
IM-303	1971-72 w/ AC	22.99 ea.
IM-0377	1978-82 w/ AC	45.99 kit



I-64

I-66AC

**Heater Control Levers**

Complete sets of sliding levers and include all hardware with instructions.

I-64	1964-65 Air Blower Only	13.95 kit
I-645	1964-65 w/o AC	39.99 kit
I-66AC	1966 w/ AC	34.95 kit
I-67AC	1967 w/ AC	32.95 kit
I-667	1966-67 w/o AC	34.95 kit
I-689	1968-69 Heater	44.99 kit
I-702	1970-72 Heater	18.55 kit

IJ-660



**Heater Control Knobs**

Chrome heater control knobs.

IJ-660	1967-72 All	4.99 ea.
IJ-426	1967-72 All Set of 4	12.99 kit

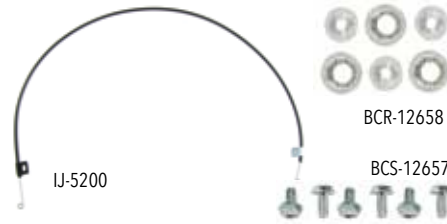

IJ-5200

BCR-12658

BCS-12657

**Dash Blower Cables**

New dash blower cables w/ correct ends and retaining brackets.

**1966 With Factory Air Conditioning**

IJ-5200	"AIR"	33.95 ea.
IJ-5210	"OUTLETS"	33.95 ea.
IJ-5220	"TEMP"	33.95 ea.
IJ-5230	"DEFROST"	33.95 ea.

**1967 With Factory Air Conditioning**

IJ-5250	"AIR"	36.99 ea.
IJ-5260	"OUTLETS"	33.95 ea.
IJ-5270	"TEMP"	33.95 ea.
IJ-5230	"DEFROST"	33.95 ea.

**1968-69 With Factory Air Conditioning**

IJ-5380	"FAN"	39.99 ea.
IJ-5375	"TEMP"	39.99 ea.
IJ-5385	"DEFROST"	39.99 ea.

**1966-67 Without Factory Air Conditioning**

IJ-5290	"AIR/FAN"	39.95 ea.
IJ-5300	"TEMP"	33.95 ea.
IJ-5310	"DEFROST"	34.95 ea.

**1968-72 Without Factory Air Conditioning**

IJ-5350	"AIR"	39.99 ea.
IJ-5360	"TEMP"	39.99 ea.
IJ-5370	"DEFROST"	39.99 ea.
IJ-5200	1968-72 Heater Cable Box	
	Brackets w/o AC	33.95 ea.
BCS-12657	1964-72 Screws (6 pc.)	6.99 kit
BCR-12658	1964-72 Clips (6 pc.)	3.99 kit

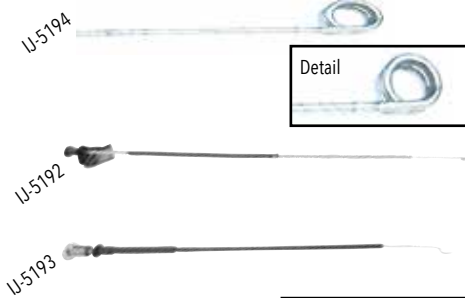

IJ-5194

IJ-5192

IJ-5193



**Air Vent Cables**

OE style reproduction air vent cables to open and close air vents. Complete with knobs.

IJ-5189	1965-66 All	46.99 ea.
IJ-5194	1967-68 All	46.99 ea.
IJ-5192	1969-72 Kick Panel Loop End	46.99 ea.
IJ-5193	1969-72 Dash Vent Z End	46.99 ea.



IV-5197

**Vent Pull Knobs**

OE style reproduction chrome vent pull knobs.

IV-5197	1967-68 All	13.99 ea.
IV-4550	1969-72 All	6.99 ea.
IV-4560	1969-72 All (4 pc.)	23.77 kit

KPS-647-80



**Ground Up Motor Sports's Premium Quality Kick Panel Speakers**

These Ground Up Motor Sports kick panel speakers offer great sound quality for your Chevelle or El Camino. These kick panels are as true to the originals as possible while offering a modern speaker in a convenient location. No cutting of the body required! Made of ABS textured plastic, they can be painted to match any interior for a clean look. All speakers are 6.5" with either a 80 watt three way, or a 300 watt two way speaker driver.

KPS-647-80	1964-67 w/o AC 80 Watt 3 Way	159.99 pr.
KPS-647-300	1964-67 w/o AC 300 Watt 2 Way	199.99 pr.
KPS-647-80AC	1964-67 w/ AC 80 Watt 3 Way	169.99 pr.
KPS-647-300AC	1964-67 w/ AC 300 Watt 2 Way	199.99 pr.
KPS-6872-80	1968-72 w/o AC 80 Watt 3 Way	159.99 pr.
KPS-6872-300	1968-72 w/o AC 300 Watt 2 Way	199.99 pr.
KPS-6872-80AC	1968-72 w/ AC 80 Watt 3 Way	169.99 pr.
KPS-6872-300AC	1968-72 w/ AC 300 Watt 2 Way	199.99 pr.



IKP-1440

**Kick Panels**

Complete OE style reproduction kick panel assemblies.

IKP-64	1964 w/o AC	119.99 pr.
IKP-64-AC	1964 w/ AC	94.95 pr.
IKP-656	1965-66 w/o AC	119.99 pr.
IKP-656-AC	1965-66 w/ AC	94.95 pr.
IKP-67	1967 w/o AC	179.95 pr.
IKP-67-AC	1967 w/ AC	94.95 pr.
IKP-68-AC	1968 w/ AC	94.95 pr.
IKP-1440	1968-72 w/o AC	169.99 pr.
IKP-1750DB	1978-87 LH Black Paint to Match	35.99 ea.
IKP-1740DB	1978-87 RH Black Paint to Match	35.99 ea.
IKP-12522	Black Screws (10 pc.)	4.99 kit
IKP-12523	Silver Screws (10 pc.)	4.99 kit

INL-15145



**1968-72 Cowl Vent Flaps**

These are the flaps that direct air inside the cowl to the kick panels.

INL-15145	1968-72	49.99 pr.
-----------	---------	-----------



IKJ-2

**Kick Panel Insulation**

Correct die-stamped jute material.

IKJ-2	1964-72 All	11.99 pr.
-------	-------------	-----------

ICC-546



**Kick Panel Cable Clip**

Used to keep the kick panel cable in place.

ICC-546	1968-77	3.99 ea.
---------	---------	----------



IBA-1495



IBA-1495B



IBA-1495A

**E-Brake Assemblies**

OE style reproduction parking brake assemblies complete with correct pad and trim.

IBA-1495B	1964-67 All .....	109.95 ea.
IBA-1495	1968-69 All .....	99.99 ea.
IBA-1495A	1970-72 All .....	99.99 ea.



IHQ-0229



IHQ-0108



IHQ-0191



IHQ-0120



IHQ-0486



IHQ-0192



ICE-0487

**Pedal Pads**

OE style reproduction pedal pads.

IHQ-0191	Brake/Clutch Pad .....	5.99 ea.
IHQ-0120	Disc Brake Pad .....	12.99 ea.
IHQ-0192	Trim .....	6.99 ea.
IHQ-0486	1978-88 Manual .....	6.95 ea.
ICE-0487	1978-88 All Auto .....	8.95 ea.



IEB-109



IEB-110



IEB-110-CH



IBH-1403

**E-Brake Knobs**

OE style reproduction pull handles & knobs.

IEB-109	1964-67 Knob Only .....	8.99 ea.
IEB-110	1968-72 Knob Only .....	5.95 ea.
IEB-110-CH	1966-72 Knob Only Chrome .....	6.99 ea.
IBH-1403	1970-72 Handle w/ Knob .....	13.95 ea.

**E-Brake Pedal**

OE style reproduction emergency brake pedal and stainless trim.

IHQ-0229	1964-72 Pad .....	4.99 ea.
IHQ-0108	1964-72 Trim .....	5.99 ea.
IHQ-0486	1978-88 .....	6.95 ea.



IC-578



IC-525



IC-525-TRIM



IHQ-0191



IHQ-0192

**Brake Pads & Trim**

OE style reproduction pads with correct ribs and medallions where applicable.

IC-578	All Auto Drum 5.5" .....	6.95 ea.
IC-525	All Auto Disc 5.5" .....	13.95 ea.
IC-525-TRIM	All Auto Trim 5.5" .....	11.99 ea.
IHQ-0191	4 Speed Drum Brake .....	5.99 ea.
IHQ-0120	4 Speed Disc Brake .....	12.99 ea.
IHQ-0192	4 Speed Trim .....	6.99 ea.



ICE-4740



ICE-0296

**Accelerator Pad & Trim**

OE style reproduction pads with correct ribbing and stainless trim to finish them off.

ICE-4740	1964-67 Pad .....	21.99 ea.
ICE-0296	1968-72 Pad .....	6.95 ea.
IYC-2525	1964-67 Trim .....	14.95 ea.
ICE-3611	1968-72 Trim .....	7.99 ea.
ICE-0483	1978-88 Pad .....	14.95 ea.



**Accelerator Hardware**

Correct hardware for pad and cable.

IST-3	1964-67 Stud .....	3.99 ea.
ICE-8078	1968-72 Spring/Pin .....	9.95 ea.
AZC-88	Cable Clip .....	6.95 ea.



APA-1499A

**Accelerator Pedal Assembly**

New OE style reproduction of the original accelerator assembly including pedal, Z bar and mounting plate.

APA-1499	1968-69 .....	69.99 ea.
APA-1499A	1970-72 .....	69.99 ea.



FC-646



FC-78K



FPS-6810



FC-682



FPS-6816

### Clutch & Brake Pedal Assemblies

Complete reproduction brake/clutch pedals.

FC-646	1964-66 All .....	99.99 ea.
FC-67	1967 All .....	99.99 ea.
FC-682	1968-72 All .....	110.99 ea.
FC-78K	1978-88 Manual Brake & Clutch .....	269.99 ea.
FC-78C	1978-88 Clutch Pedal Only .....	137.99 ea.
FC-78B	1978-88 Brake Pedal Only .....	137.99 ea.
FPS-6816	1978-88 Pivot Sleeve* .....	10.99 ea.
FPS-6810	1978-88 Pedal Bump Stop .....	17.99 ea.

\* One required for automatic transmissions and two for manual.



FCI-88A

### Automatic Brake Pedal

Correct 5.5" pedal.

FCI-88A	1967-72 Auto All .....	50.99 ea.
IBP-628	1964-77 Auto Pedal Pivot Pin .....	17.99 ea.
IC-525	Pad w/ Disc .....	13.95 ea.
IC-578	Pad w/ Drum .....	6.95 ea.



FPB-97



FPB-103

### Clutch Pedal Bushing & Bumper

Correct nylon bushing used for ease of pedal.

FPB-97	All Bushing .....	2.99 ea.
FPB-103	All Bumper .....	3.99 ea.



GBL-852

GBL-852-CC

### Brake Light Switches

OE style brake light switches located above the brake pedal.

GBL-852	1964-72 All w/o Cruise Control .....	7.95 ea.
GBL-852-CC	1964-77 All w/ Cruise Control .....	24.99 ea.
GSR-12999	Retainer .....	7.99 ea.



### Billet Throttle Assemblies & Pedal Pads

Billet throttle assemblies CNC machined and anodized in black with machined highlights and rubber pads. Matching pedal covers are CNC machined and require no drilling for installation.

#### Automatic

TA-206-BKA1	1964-67 Black .....	435.99 kit
TA-206-BKA3	1968-72 Black .....	435.99 kit

#### Manual

TA-206-BKM1	1964-67 Black .....	514.99 kit
TA-206-BKM3	1968-72 Black .....	514.99 kit

No Volume Discount.



IPA-682AM

IPA-67AA

### Muscle Car Billet Pedal Assemblies

This pedal assembly by Clayton Machine Works is machined from forged aluminum and comes complete with pedal arms, pedals with dimpled rubber pads and all necessary hardware for installation. This means that you'll have that one-off custom look without the one-off price all in a complete easy to install bolt-in package. Graphite powder coat finish. DBW= drive by wire throttle.

IPA-64AA	1964-66 Automatic .....	770.99 kit
IPA-64AAD	1964-66 Automatic DBW .....	700.99 kit
IPA-64AM	1964-66 Manual .....	1021.99 kit
IPA-64AMD	1964-66 Manual DBW .....	928.99 kit
IPA-67AA	1967 Automatic .....	770.99 kit
IPA-67AAD	1967 Automatic DBW .....	700.99 kit
IPA-67AM	1967 Manual .....	1021.99 kit
IPA-67AMD	1967 Manual DBW .....	928.99 kit
IPA-682AA	1968-72 Automatic .....	770.99 kit
IPA-682AAD	1968-72 Automatic DBW .....	700.99 kit
IPA-682AM	1968-72 Manual .....	1021.99 kit
IPA-682AMD	1968-72 Manual DBW .....	928.99 kit

Does not include pedal hanger. Bolts into stock location.

No Volume Discount.



IPA-EB

### Muscle Car E-Brake Cover

This Muscle Car e-brake cover is meant to match your new Chevrolet Muscle Car series forged aluminum pedal assembly by Clayton Machine Works. Installation hardware is included.

IPA-EB	1962-74 .....	75.99 ea.
--------	---------------	-----------



IBT-GM-BLK

**OEM Style Rubber Floor Mats**

Correct factory style rubber floor mats with ribbing and GM logo.

IBT-GM-BLK	2nd Design Black.....	99.99 set
IBT-GM-CAR	2nd Design Carmine.....	109.99 set
IBT-GM-TAN	2nd Design Tan.....	109.99 set
IBT-GM-GRY	2nd Design Gray.....	109.99 set
IBT-GM-BLU	2nd Design Dark Blue.....	109.99 set
IBT-GM-LTBLU	2nd Design Light Blue.....	109.99 set
IBT-GM-RED	2nd Design Red.....	109.99 set

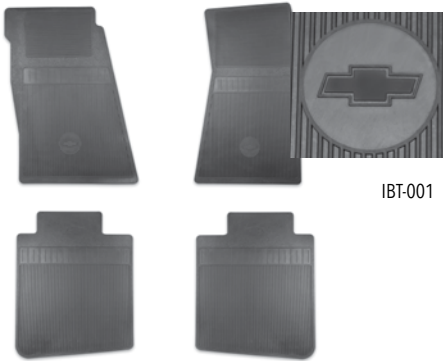

IBT-001



**Vinyl Floor Mats**

GM Restoration vinyl floor mats complete with raised "bowtie" and correct grain.

IBT-001	1st Design (4 pc.).....	189.99 set
---------	-------------------------	------------



ISP-64RR



**Carpet Sill Plates**

Authentic "Body by Fisher" sill plates available with or without factory rivets.

ISP-64RR	1964-67 w/ Rivets LH/RH.....	32.99 ea.
ISP-64-SSK	1964-67 Stainless Steel, No Logo.....	89.99 kit
ISP-68-4DR-SS	1968-72 Stainless Steel, No Logo 4 Door.....	129.99 kit
ISP-737K	1973-77 2 Door.....	94.99 pr.
ISP-0200	1978-88 2 Door.....	64.99 ea.
ISP-0200K	1978-88 2 Door Pair.....	116.98 kit
ISP-KIT	Screw Kit (8 pc.).....	3.95 kit



**Carpeted Floor Mats**

This set of ACC carpeted floor mats is the perfect finishing touch for your interior! These floor mats are constructed of 80/20 looped carpet (1964-1973) or cutpile carpet (1974-1977) and feature nibbed backing so that they won't slide around under your feet.

Use the all new ACC Carpet Configurator on **SS396.com**. See page 36 for more details.



USE YOUR PHONES CAMERA OR ANY QR APP & SCAN NOW TO SHOP FOR THE MATS YOU NEED!



HURST-6370001



HURST-6370002



**Hurst Logo Floor Mats**

Show off your Hurst pride with a set of these high quality embroidered Hurst logo floor mats. The embroidered Hurst logo on the front set of mats features the iconic accented Hurst logo. These mats are cut to an exact OEM cut fit with OEM-style attachment points (when applicable) and non-slip backing.

HURST-6370001	1964-67 Front/Rear Red Logo.....	228.99 kit
HURST-6370002	1968-72 Front/Rear Red Logo.....	228.99 kit

No Volume Discount.



ISP-68K



**Ground Up Exclusive Chevelle Sill Plate Kit**

Complete Kit with two sill plates.

ISP-64RRK	1964-67 Sill Plate Kit.....	59.44 kit
ISP-68K	1968-72 Sill Plate Kit.....	64.99 kit

No Volume Discount. Not eligible for free shipping.



**QuietRide AcoustiShield**

The QuietRide AcoustiShield kit is a multi-stage automotive and sound dampening system to give your muscle car the quiet riding comfort found in today's new cars. AcoustiSHIELD kits are designed on current state of the art auto acoustic technology to insulate and control the noise, vibration and heat in the passenger cabin. Kits are pre-cut and come with easy to follow installation instructions: Everything you need to do the job right! The first stage consists of pre-trimmed, self-adhesive sound damper pads which are bonded to strategically located trouble spots to control body panel vibration and noise. These spots are mapped and labeled in the detailed instructions.



Complete Kits include Body, Cowl, Floor, Roof (except convertible) and Trunk Floor Kits.

**1964-65 Chevelle Coupe**

GMA-6465-CAK	Complete Kit.....	781.99 kit
GMA-6465-CBPK	Body Kit.....	138.99 kit
GMA-6465-CCK	Cowl Kit.....	103.99 kit
GMA-6465-CFK	Floor Kit.....	253.99 kit
GMA-6465-CRK	Roof Kit.....	147.99 kit
GMA-6465-CTK	Trunk Floor Kit.....	147.99 kit

**1964-65 Chevelle Convertible**

GMA-6465-CVAK	Complete Kit.....	651.99 kit
GMA-6465-CVBPK	Body Kit.....	147.99 kit
GMA-6465-CVCK	Cowl Kit.....	103.99 kit
GMA-6465-CVFK	Floor Kit.....	253.99 kit
GMA-6465-CVTK	Trunk Floor Kit.....	138.99 kit

**1966-67 Chevelle Coupe**

GMA-6667-CAK	Complete Kit.....	828.99 kit
GMA-6667-CBPK	Body Kit.....	138.99 kit
GMA-6667-CCK	Cowl Kit.....	103.99 kit
GMA-6667-CFK	Floor Kit.....	253.99 kit
GMA-6667-CRK	Roof Kit.....	147.99 kit
GMA-6667-CTK	Trunk Floor Kit.....	147.99 kit

**1966-67 Chevelle Convertible**

GMA-6667-CVAK	Complete Kit.....	651.99 kit
GMA-6667-CVBPK	Body Kit.....	147.99 kit
GMA-6667-CVCK	Cowl Kit.....	103.99 kit
GMA-6667-CVFK	Floor Kit.....	253.99 kit
GMA-6667-CVTK	Trunk Floor Kit.....	147.99 kit

**1968-72 Chevelle Coupe**

GMA-6872-CAK	Complete Kit.....	828.99 kit
GMA-6872-CBPK	Body Kit.....	138.99 kit
GMA-6872-CCK	Cowl Kit.....	103.99 kit
GMA-6872-CFK	Floor Kit.....	253.99 kit
GMA-6872-CRK	Roof Kit.....	147.99 kit
GMA-6872-CTK	Trunk Floor Kit.....	147.99 kit

**1968-72 Chevelle Convertible**

GMA-6872-CVAK	Complete Kit.....	651.99 kit
GMA-6872-CVBPK	Body Kit.....	147.99 kit
GMA-6872-CVCK	Cowl Kit.....	103.99 kit
GMA-6872-CVFK	Floor Kit.....	263.99 kit
GMA-6872-CVTK	Trunk Floor Kit.....	147.99 kit

**1973-77 Chevelle Coupe**

GMA-7377-CAK	Complete Kit.....	824.99 kit
GMA-7377-CBPK	Body Kit.....	147.99 kit
GMA-7377-CCK	Cowl Kit.....	102.99 kit
GMA-7377-CFK	Floor Kit.....	263.99 kit
GMA-7377-CRK	Roof Kit.....	147.99 kit
GMA-7377-CTK	Trunk Floor Kit.....	147.99 kit



**Firewall Insulators**

GMA-6872-AC

A Firewall Insulator panel by QuietRide Solutions is your first line of defense to stop engine noise and heat from entering the passenger cabin. This firewall panel is an exact OEM replacement and is year, make and model specific. It is molded to fit the engine setback and firewall contours and fits like a glove.

GMA-6467-HC	1964-67 Heater Only Cars.....	218.99 kit
GMA-6467-AC	1964-67 Factory AC Cars.....	215.99 kit
GMA-6872-HC	1968-72 Heater Only Cars.....	223.99 kit
GMA-6872-AC	1968-72 Factory AC Cars.....	235.99 kit
GMA-7377-AC	1973-77 Factory AC Cars.....	218.99 kit

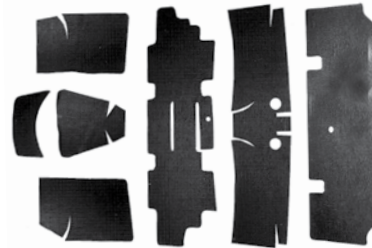

**OEM Style Carpet Sound Deadener**

ICK-0120

ICK-0120	1964-67 Sound Deadener.....	69.99 set
ICK-1027	1968-72 Sound Deadener.....	69.99 set
ICK-170	1973-77 Sound Deadener.....	79.99 set



**Flatline Carpet & Sound Deadener Kits**

Are you looking to replace your worn original Chevelle carpet with something that meets your high standards for quality and originality? Look no further than our Chevelle carpet and Flatline sound deadener kit! This is not a cheap reproduction carpet that will fade out in a year or two! These carpets feature a true 80/20 rayon and nylon looped blend and it is molded for a perfect fit. Flatline Barriers is the new leader in automotive thermal acoustic insulation products. Utilizing cutting edge technology and materials, Flatline is able to offer a solution that significantly reduces unwanted sound and heat. Did we mention that the product is ultra-lightweight as well? Extremely lighter than other insulation products, packing the same punch in sound and heat control properties. Flatline Barriers designs are created by in house automotive enthusiasts and DIYers, making our kits easy to install, logical in layout and highly effective. All of this provided to you at an extreme value. Remember the name is Flatline, it's that quiet.

IXC-647A-FL	1964-67 Chevelle 2 Door.....	302.38 kit
IXC-682A-FL	1968-72 Chevelle 2 Door.....	302.38 kit

*Not eligible for free shipping. No Volume Discount.*



**Firewall Insulation Pad**

IRE-7281

Correct die-stamped original material complete with clips.

IRE-7281	1964-67 All.....	54.99 ea.
IRE-7282	1968-72 w/o AC.....	54.99 ea.
IRE-7282A	1968-72 w/ AC.....	54.99 ea.
IRE-316	1973-77 All.....	62.99 ea.
IRE-PLUG	1964-67 All Plug.....	3.99 ea.
IN-197	1968-72 All Screws.....	6.99 pr.



**Carpet Firewall Guard**

IXK-19

Correct plastic injection molded piece which installs below steering column.

IO-509	1964-66 All.....	42.99 ea.
IO-119	1967 All.....	25.95 ea.
IXK-19	1968-72 All.....	34.95 ea.
IRE-PLUG	1964-67 All Plug.....	3.99 ea.
IN-197	1968-72 All Screws.....	6.99 pr.



**Flatline Barriers**

Flatline Barriers is the new leader in automotive thermal acoustic insulation products. Utilizing cutting edge technology and materials, Flatline is able to offer a solution that significantly reduces unwanted sound and heat. Did we mention that the product is ultra-lightweight as well? Extremely lighter than other insulation products, packing the same punch in sound and heat control properties. The material is offered in pre-cut kits and universal options. Our designs were created by in house automotive enthusiasts and DIYers. Making our kits easy to install, logical in layout and highly effective. Provided to you at an extreme value.

**1964-67 Chevelle**

IFL-TABA1011	Complete Kit Coupe.....	307.99 kit
IFL-TABA1013	Complete Kit Convertible.....	272.99 kit
IFL-TABA1003	Doors/Quarter Panel.....	132.99 kit
IFL-TABA1001	Roof.....	58.99 kit
IFL-TABA1005	Floor.....	155.99 kit
IFL-TABA1007	Trunk.....	101.99 kit

**1968-72 Chevelle**

IFL-TABA1012	Complete Kit Coupe.....	307.99 kit
IFL-TABA1014	Complete Kit Convertible.....	272.99 kit
IFL-TABA1004	Doors/Quarter Panel.....	132.99 kit
IFL-TABA1001	Roof.....	58.99 kit
IFL-TABA1006	Floor.....	155.99 kit
IFL-TABA1008	Trunk.....	101.99 kit

Looking to replace your Chevelle or El Camino carpet with something that meets your quality and originality standards? Look no further than our ACC brand OEM carpet sets. We are proud to offer these carpets in several styles, from factory original 80/20 rayon and nylon looped blend (cut pile for 1974-77 models) to our new ESSEX Style for those who are looking for a "modern" auto style carpet seen in high end Mercedes or Porsche cars, to our "Mass Backing" carpet sets which offer factory installed sound deadening material built-in for an overall quieter, cooler and more comfortable interior. ALL of our ACC brand carpets are factory molded with correct heel pad & dimmer switch grommet for a model specific fit.

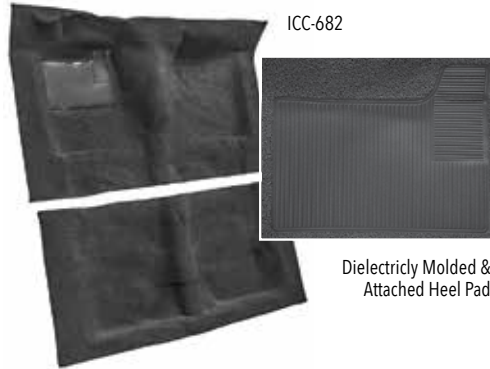
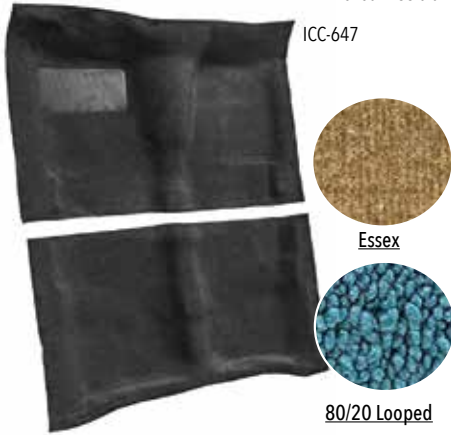

Mass-Backed Carpet shown which offer factory installed sound deadening material built in.

**1964-67 Chevelle & El Camino**  
ICC-647 1964-67 Black 80/20..... 179.99 ea.

**1968-72 Chevelle & El Camino**  
ICC-682 1968-72 Black 80/20.....179.99 ea.  
ICC-7301 1973 Black 80/20.....208.99 ea.  
ICC-747801 1974-77 Black Cut-Pile.....184.99 ea.

**1964-77 Chevelle & El Camino**  
ICC-647MB 1964-67 Black Mass-Backed ..... 319.99 ea.  
ICC-682MB 1968-72 Black Mass-Backed ..... 359.99 ea.  
ICC-73MB01 1973 Black Mass-Backed..... 347.99 ea.  
ICC-747MB801 1974-77 Black Mass-Backed ..... 333.99 ea.

**1964-77 80/20 Looped Carpet Colors**



**1974-77 Cutpiled Carpet Colors**



Please state color at time of order. No Volume Discount. All carpets ship oversize. Colors other than black are non-returnable. We will be happy to mail you a color swatch before you order.

**USE YOUR PHONES CAMERA OR ANY QR APP & SCAN NOW TO SHOP FOR THE CARPET YOU NEED!**



Use the all new ACC Carpet Configurator on SS396.com

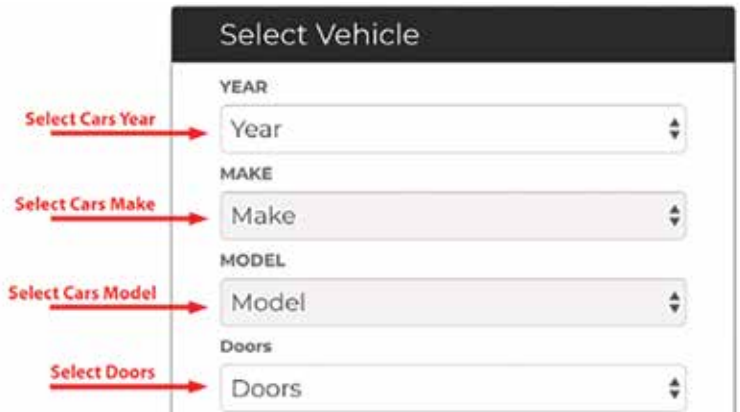

**Molded Carpet Kits**

Save money on two of our most popular Chevelle and El Camino carpet kits. Both feature ACC brand carpet pre-formed in 80/20 black loop.

**Molded Carpet w/ Sound Deadener**

IXC-647A 1964-67 Black .....224.98 kit  
IXC-682A 1968-72 Black .....224.98 kit  
IXC-73A 1973 Black.....260.08 kit  
IXC-747A 1974-77\* Black .....238.48 kit

\* Original Cut-Pile

**Molded Carpet w/ Sill Plates**

ACC-53130K 1964-67 All Black .....221.37 kit  
ACC-53131K 1968-72 All.....220.48 kit  
Black only on kits. Ships Oversize. No Volume Discount.

Note: Due to variations in printing, it is impossible to perfectly represent carpet colors in this catalog. Use our color swatch chart as a guide only. We will gladly mail you a color sample before you place your order upon request. Please note that colors other than black are non-returnable.



IX-68M-HQ-LOCK



IX-71A-HQ



IX-68A-HQ-LOCK



IX-68A-HQ-LOCK

**Premium Quality Console Kits**

Ground Up Motor Sports's Exclusive Premium Console Kits offer a superior design! Our console bases start with a heavy and more distinct "Pebble Grain" finish like original GM. Both automatic and 4spd top plates are detailed and finished in a high quality chrome plating w/ correct flat black insert accenting. Rear lamp assembly has an even contoured fit and finish.

**1968-72 Automatic**

- Premium quality console shell w/ correct grain and trim • Pre-assembled lid and hinge
- Hardware for final assembly • Top plate w/ correct brushed accent and black paint
- Pre-assembled shift indicator plate w/ correct lettering

IX-68A-HQ	1968-70 w/o Push Button Lock (Green Lettering).....	462.99 kit
IX-68A-HQ-LOCK	1968-70 w/ Push Button Lock (Green Lettering).....	462.99 kit
IX-71A-HQ	1971-72 w/o Push Button Lock (White Lettering).....	462.99 kit
IX-71A-HQ-LOCK	1971-72 w/ Push Button Lock (White Lettering).....	464.77 kit

**1968-72 4-Speed**

- Premium quality console shell w/ correct grain and trim • Pre-assembled lid and hinge
- Top plate w/ correct brushed accent and black paint • Die cast 4 speed emblem
- Hardware for final assembly

IX-68M-HQ	1968-72 w/o Push Button Lock.....	362.78 kit
IX-68M-HQ-LOCK	1968-72 w/ Push Button Lock.....	362.78 kit

Note: These kits are meant to replace your existing console. If your car did not come with a console additional parts may be needed. Such as: mounting brackets, harness, shifter assembly, etc.

**BUY'N SAVE WITH KITS**

IX-66A



**1966-67 Automatic Console Kit**

This long awaited console kit is finally available for the first time! Stop searching the swap meets for junk and receive all of the parts you need to fully repair your original console or add a new one!  
Includes: Console Base Shell, Top Plate, 2PC Insert, Rear Chrome, Console Door, Door Hinge.

IX-66A 1966-67 Automatic..... 489.23 kit  
Ships Oversize. Not eligible for free shipping. No Volume Discount.

**BUY'N SAVE WITH KITS**

IX-66M



**1966-67 4 Speed Console Kit**

This long awaited console kit is finally available for the first time! Stop searching the swap meets for junk and receive all of the parts you need to fully repair your original console or add a new one!  
Includes: Console Base Shell, Top Plate, Rear Chrome, Console Door, Door Hinge.

IX-66M 1966-67 4 Speed..... 478.59 kit  
Ships Oversize Not eligible for free shipping. No Volume Discount.



IX-68AKIT-BM

**1968-72 Console Kit With B&M Quicksilver Shifter**

If you want the stock look with a little extra performance this console kit is the choice for you! This kit includes everything you need to get the job done. Comes with a console door with or without a lock. Works with GM 3 or 4 speed automatics.  
TH350, TH400, TH200R4, TH700R4.

IX-68AKIT-BM	w/o Lock .....	753.27 kit
IX-68AKIT-BM-PB	Push Button .....	796.59 kit
IX-68AKIT-BM-LOCK	w/ Lock.....	797.44 kit

No Volume Discount.



BM-81125

**B&M Quicksilver Shifter For Factory Console**

This ratcheting shifter is designed to fit the factory console. This kit works with most 3-4 speed automatic transmissions. Kit includes: Shifter with bezel, cable with cable mounting brackets, reverse/neutral switches and mounting hardware.

BM-81125 1968-72 w/ Console ..... 382.99 ea.  
No Volume Discount.



SHIFTKIT-350

**Console Shifter Kit**

Complete kit to convert to an automatic console shifter. Kit includes factory style staple shifter, cable, brackets & all correct hardware.

SHIFTKIT-350	1968-72 TH350.....	242.03 kit
SHIFTKIT-400	1968-72 TH400.....	246.53 kit



ISSFT-1

**Staple Shifter**

Complete staple shifter assembly with chrome plated handle, spring loaded lock out trigger and mounting base. Ready to install.

ISSFT-1	1968-72 Shifter .....	165.99 ea.
ISH-3X	1968-72 Handle Only.....	70.99 ea.
GDR-411	1968-72 Auto Neutral Switch .....	34.99 ea.
ISSFT-HRDW	1968-72 Repair Kit.....	32.99 kit

No Volume Discount.



ISC-667

IE-667

**Automatic Shifter**

Brand new shifter assembly including base, shift handle, shift arm and lever, rubber grommets and clips! Ready to install.

ISC-667	1966-67 Automatic .....	199.99 ea.
IE-667	1966-67 Boot On Shifter .....	19.99 ea.
ISH-667A	1966-67 Handle PG Trans Only .....	59.95 ea.
ISC-667-200R-700	Overdrive .....	199.99 ea.

No Volume Discount.



SC2041

**4 Speed Overdrive Kits**

This kit makes it easy to install a modern overdrive automatic in place of your old Powerglide, TH350 or TH400 for improved performance and gas mileage. Each kit includes a new laser cut detent, indicator, hardware and brackets. This kit works with a TH700, TH200 or 4L60 transmission.

SC2041	1964-65 All .....	119.99 kit
SC2042	1966-67 All .....	119.99 kit
SC2242	1968-70 All .....	107.99 kit
SC2243	1971-72 All .....	107.99 kit



**Billet Shifter Handles**

These billet aluminum shifter handles from Clayton Machine work with any Hurst or Tremec, TK500 TKO600 2 bolt shifter mount and are a great finishing touch for your custom ride! Available in three styles. Basic black anodized, truss style with gray powder coat, truss style adjustable gray powder coat. Shift knob not included. Requires knob with 3/8-16" thread. Same as most Hurst knobs.

SH-203-8	8" Black Anno 30 Degree Kick Back .....	234.99 ea.
SH-203-10	10" Black Anno 30 Degree Kick Back.....	241.99 ea.
SH-202-8	8" Gray PC Truss Style 30 Degree Kick Back .....	184.99 ea.
SH-202-10	10" Gray PC Truss Style 30 Degree Kick Back.....	191.99 ea.
SH-204-10	10" Gray PC Truss Style Adjustable Kick Back.....	316.99 ea.

No Volume Discount.



3917308

**Hurst Shifters**

New Hurst Competition Plus shifter complete with Hurst handle and shifter ball.

3917308	1964-67 w/ Muncie .....	493.99 ea.
3917307	1966-67 w/ Saginaw .....	493.99 ea.
3918014	1968-72 w/ Muncie .....	493.99 ea.
3916848	1973-74 w/ Muncie .....	493.99 ea.
3918794	1978-79 w/ Saginaw .....	493.99 kit

No Volume Discount.



**Hurst Shifter & Installation Kit**

This complete Hurst Competition Plus shifter and linkage kit includes a famous Hurst Competition Plus shifter, chrome Hurst shifter handle and white shifter ball with 4 speed pattern as well as a complete Hurst installation kit with all rods, levers, swivels and hardware. This kit will provide you with that vintage muscle car look as well as provide reliable shifts every time!

HURST-KITA64M	1964-67 Muncie .....	715.41 kit
HURST-KITA68M	1968 Muncie .....	715.41 kit
HURST-KITA69M	1969-72 Muncie .....	715.41 kit

*Part Notes: Please verify that the year of your transmission matches the year of your car before ordering. 1964 to 1968 Muncie 4-speed transmissions can be identified from later models by the way the transmission arms attach. Early Muncie side covers had a stud and the shift arm attached with a nut on the stud while the 1969 and later model side covers had a hole and the shift arms attached with a bolt.*

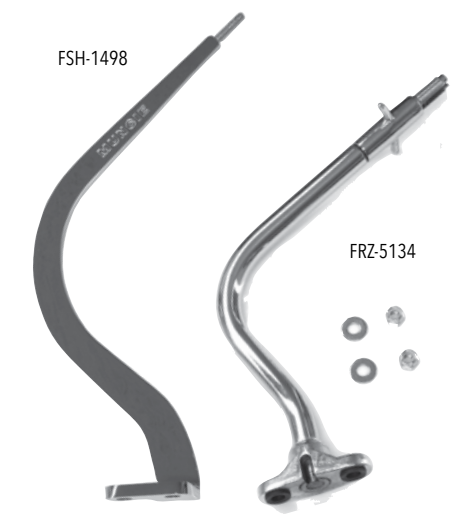

FSH-1498

FRZ-5134



Detail

**1964-72 Muncie Shifter Handles**

OE style reproduction chrome shifter handles.

FRZ-5134	1964-67 Bench .....	99.95 ea.
FRZ-5133	1964-66 Buckets.....	109.99 ea.
FRZ-5131	1967 Buckets .....	109.99 ea.
FSH-1498	1968-72 w/o Console .....	89.99 ea.
FSH-1499	1968-72 w/ Console .....	89.99 ea.



## SHIFTWORKS®



SW6604

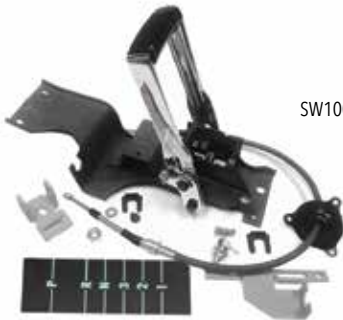

SW1003

### Shiftworks Console Shifter Kits

These reproduction shifters are offered complete with the neutral safety/back-up light switch, console indicator, slider, shifter cable and all required installation hardware. Multiple linkage styles are available to best suit your chosen transmission.

SW6403	1964-65 TH350-400	379.99 kit
SW6404	1964-65 TH200-700R4, 4L60	379.99 kit
SW6404-E	1964-65 4L60-65-70E	419.99 kit
SW6405	1964-65 4L80E	379.99 kit
SW6406	1964-65 6L90	316.99 kit
SW6603	1966-67 TH350-400	356.99 kit
SW6604	1966-67 TH200-700R4, 4L60	379.99 kit
SW6604-E	1966-67 4L60-65-70E	419.99 kit
SW6605	1966-67 4L80E	395.99 kit
SW6606	1966-67 6L90	395.99 kit
SW1003	1968-70 TH350-400	375.99 kit
SW1013	1968-70 TH200-700R4, 4L60	375.99 kit
SW1017	1968-70 4L60-65-70E	374.99 kit
SW1023	1968-70 4L80E	375.99 kit
SW1027	1968-70 6L80, 6L90	375.99 kit
SW1004	1971-72 TH350-400	375.99 kit
SW1014	1971-72 TH200-700R4, 4L60	375.99 kit
SW1018	1971-72 4L60-65-70E	374.99 kit
SW1024	1971-72 4L80E	375.99 kit
SW1028	1971-72 6L80, 6L90	375.99 kit

The shifters below include a Thompson Performance slap shift detent gate. This detent will enable positive shifts from low to drive/overdrive without the risk of missing a gear.

SW1003-R	1970 TH350-400	413.99 kit
SW1013-R	1968-70 TH200-700R4, 4L60	413.99 kit
SW1017-R	1968-70 4L60-65-70E	449.99 kit
SW1023-R	1968-70 4L80E	413.99 kit
SW1004-R	1971-72 TH350-400	413.99 kit
SW1014-R	1971 TH200-700R4, 4L60	413.99 kit
SW1018-R	1971-72 4L60-65-70E	449.99 kit
SW1024-R	1971-72 4L80E	413.99 kit

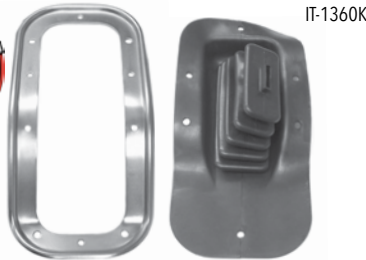

IT-1360K

### Boot & Retainer Kit

Buy a correct shift boot and retainer for your 1968-72 Chevelle with console and save!!

IT-1360K	1968-72 w/ Console	34.83 kit
----------	--------------------	-----------



ICE-5356

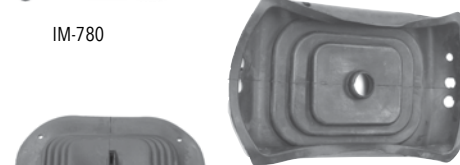

IM-780



ICE-5405



IE-390



IE-384

### Shifter Boots

Brand new injection molded boots.

IM-780	1964-65 Console Upper	11.99 ea.
IE-667	1966-67 Boot On Shifter	19.99 ea.
IE-384	1964-67 Lower Console	19.99 ea.
IE-384	1964-66 w/o Console	19.99 ea.
IE-390	1966-67 Upper Console	20.99 ea.
ICE-5356	1968-72 w/ Console	19.99 ea.
ICE-5405	1968-72 w/o Console	19.99 ea.
IE-4010	1978-88 w/o Console	52.99 ea.



ICE-HURST



ICE-INDY

### Hurst Shifter Boots

Brand new injection molded boots.

ICE-HURST	Universal	74.99 ea.
ICE-INDY	Universal Indy Shift Boot	34.99 ea.



ICE-6674

ISP-A686T

ICE-6824



### Console Shift Emblems

Correct 4 speed console emblems and 6 speed emblems that look like factory!

#### 4 Speed

ICE-6674	1966-67 4 Speed	21.99 ea.
ICE-6824	1968-72 4 Speed	21.99 ea.

#### 5 Speed

ISP-A665T	1966-67 Tremec	54.99 ea.
ISP-A665R	1966-67 Richmond	54.99 ea.
ISP-A685T	1968-72 Tremec	54.99 ea.
ISP-A685R	1968-72 Richmond	54.99 ea.

#### 6 Speed

ISP-A666T	1966-67 Tremec	54.99 ea.
ISP-A666R	1966-67 Richmond	54.99 ea.
ISP-A686T	1968-72 Tremec	54.99 ea.
ISP-A686R	1968-72 Richmond	54.99 ea.

IT-1405



IT-1311



NT-196



IT-1360



### Shift Boot Retainers

Correct die stamped steel boot retainers.

IT-1311	1964-66 All	19.99 ea.
IT-1405	1966-67 Console	39.99 ea.
IT-1360	1968-72 Console	20.99 ea.
NT-196	1968-72 w/o Console (2 pc.)	89.99 ea.
IT-3954	1978-88 w/o Console	34.99 ea.

FZ-1400

FZ-1420

FW-157

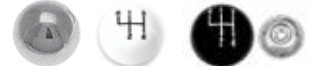

### Shifter Balls

OE style reproduction shifter balls.

FZ-1300	1964-67 White Bench	42.99 ea.
FZ-1400	1964-67 Chrome	22.99 ea.
FZ-1420	1968-72 White 5/16"	23.99 ea.
FZ-1424	1968-72 White 3/8"	23.99 ea.
FW-38HURST	White 3/8" 4 Speed Hurst Logo	38.99 ea.
FW-115	Chrome 5/16"	27.99 ea.
FW-117	Chrome 3/8"	23.99 ea.
FW-157	Black/Chrome 5/16"	22.99 ea.
FW-159	Black/Chrome 3/8"	23.99 ea.



FW-HURST

### Hurst T Handle Shifter Boot

This brushed aluminum t-handle provides a positive feel for accurate gear selection. A favorite in the performance world for years! Includes adapters for most popular shift handles.

FW-HURST	T-Handle	45.99 ea.
----------	----------	-----------



BM-46112



BM-80534



**B&M Automatic Shifter Knobs**

Adapters included with these knobs fit 1/2-20, 3/8-24, 3/8-16 and 5/16-18 SAE threads.

BM-80534 Quicksilver Billet Aluminum Silver ..... 81.99 ea.  
BM-46112 Round White w/ 12v Switch\* ..... 97.99 ea.

\*Works with 12 volt and 16 volt systems and may be used to activate transbrake, launch control, nitrous or two step.

No Volume Discount.



HURST-1531000

HURST-1536210

**Hurst Replacement Shifter Handles**

These handles all feature a universal installation kit with SAE 1/2-20, 7/16-20, 3/8-16 and also Metric M10x1.25, M10x1.50, M12x1.25, M12x1.75 and M16x1.50 thread size.

HURST-1531000 Pistol Grip Silver ..... 73.99 ea.  
HURST-1536200 Pistol Grip Silver w/ 12v Switch ..... 93.99 ea.  
HURST-1536210 Pistol Grip Black w/ 12v Switch ..... 93.99 ea.  
HURST-1539000 Pistol Grip Rosewood ..... 73.99 ea.  
HURST-1630050 Round Black\* w/ 12v Switch ..... 99.99 ea.

\*7/16 - 20 threads only. No Volume Discount.



BM-80658

**B&M Universal Shift Handle w/ Button**

This B&M Universal Button T-handle fits most B&M and aftermarket shifters.

Includes: Thread inserts to fit 1/2-20, 3/8-24, 3/8-16 & 5/16-18 SAE. A 12v momentary switch to activate Line-Lock, transbrake or nitrous.

BM-80658 Aluminum Polished ..... 69.99 ea.  
BM-80659 Aluminum Chrome ..... 77.99 ea.

No Volume Discount.



NJ-1105

**Shifter Tunnel**

Correct molded plastic which installs on inside of console.

NJ-1105 1968-72 ..... 36.99 ea.  
RST-73D 1973-77 ..... 79.99 ea.



RST-76D

**Shifter Tunnel Pans**

Stamped steel shifter tunnel pans.

RST-76D 1964-67 All ..... 54.99 ea.  
RST-76A 1964-67 Universal ..... 59.99 ea.  
RST-66W-O 1966-67 4-Speed Chrome ..... 119.99 ea.  
RST-72D 1968-72 w/ Console ..... 69.99 ea.  
RST-72A 1968-72 w/o Console ..... 69.99 ea.  
IO-4015 1978-88 w/o Console Plastic ..... 29.95 ea.



9507993



IO-8001

**Console Shells**

OE style reproduction injection molded console shells featuring the correct grain and mounting points just like factory. 1968-72 bases include the correct chrome trim.

IX-645M 1964-65 4 Speed ..... 349.99 ea.  
9507992 1966-67 Automatic ..... 189.95 ea.  
9507993 1966-67 4 Speed ..... 189.95 ea.  
IO-8001 1968-72 All ..... 189.95 ea.

Ships Oversize. Not eligible for free shipping. No Volume Discount. Black only. Paint to match.



IOP-80



IAP-0530-HQ

**Console Top Plates**

OE style reproduction die-cast top plates with correct brushed aluminum inserts and semi black paint.

IOP-80 1968-72 Automatic ..... 99.95 ea.  
IAP-0530-HQ 1968-72 4 Speed ..... 99.95 ea.



ICC-1412

**Console Inserts**

Correct die-stamped brushed aluminum inserts for your console.

ICC-1412 1968-72 Automatic ..... 17.99 set  
ICC-1410 1968-72 4 Speed ..... 16.95 set



IM-2011

**Console Brackets**

Correct stamped steel brackets for attaching console to floor.

IM-2011 1964-65 Auto ..... 29.95 set  
IM-2012 1964-65 4 Speed ..... 29.95 set  
IM-2013 1966-67 Auto ..... 29.95 set  
IM-2014 1966-67 4 Speed ..... 29.95 set  
IM-2915 1968-72 All ..... 19.95 ea.  
CH6672 1966-72 All Hardware ..... 16.95 kit



9507998



IC-4572

**Console Lids**

Correct injection molded door complete with flocked lined inner backing plate and chrome trim.

9507998 1966-67 ..... 74.95 ea.  
IC-4570 1968-72 w/o Lock Hole ..... 49.99 ea.  
IC-4572 1968-72 w/ Lock Hole ..... 49.99 ea.



9507995

**Console Hinges**

Brand new steel door hinges.

ICH-457

9507995 1966-67 ..... 29.99 ea.  
ICH-457 1968-72 ..... 26.95 ea.



ICLK-66

**Console Clock**

OE style reproduction console clock with correct face and modern quartz movement.

ICLK-66 1966-67 ..... 134.99 ea.



### Console Locks

Correct console locks with keys.

ICK-70	1970-72 Lock Catch .....	12.99 ea.
ICL-13	1970-72 Lock .....	24.99 ea.
ITW-8115	1970-72 Lock Retainer.....	13.99 ea.
LC-66	1966-67 Lock .....	28.99 ea.
ICL-13K	1970-72 Lock & Retainer Set.....	36.95 kit
ICL-13-PB	1970-72 Push Button.....	23.99 ea.



### Seat Belt Holders

New seat belt holders which attach to console.

ISB-67	1968 .....	21.99 pr.
ICV-4575	1970-72 .....	49.99 ea.



### 1964-65 Automatic Shifter Insert

OE style reproduction pot metal console insert chromed with correct black accents.

IAP-222	1964 (2 pc.).....	79.95 ea.
IAP-224	1965 (2 pc.).....	82.99 ea.



### 1966-67 Automatic Shifter Insert

Injection molded chromed plastic insert.

IAP-448	1966-67 Automatic.....	37.95 ea.
---------	------------------------	-----------



### 1966-67 Auto Top Plate

OE style reproduction crafted from ABS plastic with correct factory grain and chrome accents.

ITP-7997	1966-67 Automatic.....	79.99 ea.
----------	------------------------	-----------



### 1966-67 4 Speed Top Plate

OE style reproduction crafted from ABS plastic with correct factory grain and chrome accents.

9507994	1966-67 4 Speed .....	112.95 ea.
---------	-----------------------	------------



### Rear Lens Assembly

Correct injection molded assembly featuring the correct grain with molded in lens.

IC-4574	1968-72 .....	32.95 ea.
---------	---------------	-----------



### Console Rear Lens

OE style reproduction injection molded lenses.

ICL-64	1964-65 .....	6.99 ea.
ICL-66	1966-67 .....	9.95 ea.



### Automatic Shift Plate

Die-cast console dial plate complete with aluminum insert.

IOA-57	1968-72 Automatic.....	85.95 ea.
--------	------------------------	-----------



### Automatic Shifter Plate Assemblies

Kit is complete with the die-cast aluminum shifter plate, shifter lens, and shifter plate sealing strips, which is perfect to freshen up your pitted console.

IOA-57-KHQ-G	1968-70 Green Letters.....	110.95 ea.
IOA-57-KHQ-W	1971-72 White Letters.....	84.31 ea.

*Note: Fits three speed automatic TH350 & TH400 transmissions.*



### Indicator Lens Backing Plate

Backing plate which goes under shift lens.

IBP-146	1966-67 .....	22.99 ea.
---------	---------------	-----------

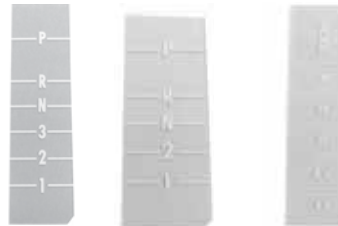

### Console Shift Lenses

New clear plastic lenses with silk screened letters.

ICC-4507	1966-67 Powerglide .....	7.99 ea.
ICC-4506	1966-67 TH350/TH400.....	6.99 ea.
ICC-4508	1968-70 Powerglide .....	6.95 ea.
ICC-4519	1968-70 TH350/TH400.....	6.95 ea.
S118	1968-70 Overdrive Auto .....	18.99 ea.
ICC-5409	1971-72 TH350/TH400.....	6.95 ea.
S119	1971-72 Overdrive Auto .....	18.99 ea.



### Shift Light Shield

Located below the indicator lens and allows light to shine through and light up lens.

ILS-985	1966-67 .....	24.99 ea.
---------	---------------	-----------



### Console Center Bulb Plate

Shift plate bulb retainer which installs directly below the shift plate area and houses the bulbs.

IK-377	1966-67 .....	55.95 ea.
--------	---------------	-----------



### Console Sealing Strips

Correct die cut molded strips to seal dial.

IHT-5059	1968-72 .....	14.99 ea.
----------	---------------	-----------



### Shifter Sliders

Machined plastic slider plates.

ICS-420	1964-67 .....	9.95 ea.
ICS-689	1968-69 w/ Insert .....	23.99 ea.
ICS-421	1970-72 .....	26.99 ea.
ICE-3522	1969-70 Boot Seal .....	14.99 ea.



### Shifter Slider Retainer

Retains slider to console base.

ISR-667	1966-67 .....	9.99 ea.
---------	---------------	----------

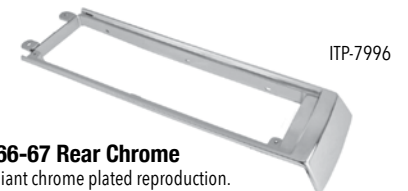

### 1966-67 Rear Chrome

Brilliant chrome plated reproduction.

ITP-7996	1966-67 .....	84.99 ea.
----------	---------------	-----------

**Classic Consoles**

Do you enjoy cruising in your classic muscle car but get frustrated by the lack of drink holders and storage space? These consoles are easy to install with no tools or drilling (easy removal for car shows) and look like they could have been factory.



*Classic  
Consoles*

**Arm-Ster Console 1964-65 Chevelle**

- Slides over factory console with no tools or drilling
- 1 large drink holder • Storage compartment
- Comfortable arm rest

CC-CVLARM64-(COLOR) 1964-65.....225.99 ea.

**Humphugger Console for Buckets**

- 1 large & 1 can-sized drink holder • Storage compartment
- Comfortable arm rest

CC-CVLHH6487CP-(COLOR) All Buckets .....225.99 ea.



**Plug & Chug Drink Holder**

- Designed to fit the factory ash tray slot
- Simply slide out ash tray and insert drink holder

CC-CVL6465PC-245 1964-65.....82.99 ea.  
 CC-CVL6667PC-245 1966-67.....82.99 ea.  
 CC-CVL6869PC-245 1968-69.....82.99 ea.  
 CC-CVL7072PC-245 1970-72 non-SS.....82.99 ea.  
 CC-CVL7072SSPC-245 1970-72 SS.....82.99 ea.



**BC Shorty Bench Seat Console**

- Same as BC Cruiser but shorter for 4 speed cars
- Prevents shifter from hitting in 2nd & 4th gear

CC-BCSHORTY-(COLOR) All Bench.....190.99 ea.



**BC Cruiser Bench Seat Console**

- 2 large drink holders • Storage compartment
- Comfortable arm rest

CC-BCCRUISER-(COLOR) All Bench.....204.99 ea.



**Low-Rider Cruiser Console**

- Sits on floor in front of bench seat • 2 large drink holders
- Storage compartment

CC-LRCRUISER-(COLOR) All Bench.....225.99 ea.

**Classic Console Colors**



226 Sandalwood 227 Buckskin 228 Saddle 229 Camel 230 Silver 231 Metallic Blue 236 White 237 Fawn 238 Ivory 241 Ivory Gold 247 Black Carbon 233 Graphite

*Note: It is impossible to perfectly represent console colors. We will gladly mail you a color sample before you place your order upon request. Please note that colors other than black are non-returnable.*



**Headliner Insulation**

Correct factory style insulation to help keep noise and heat from entering car. Cut to fit.

IHI-68 1964-72 All.....22.99 ea.

**TMI Premium Headliner Kits with Sunvisors**

If your headliner is ripped, missing or has seen better days replace it with this brand new premium headliner from TMI! This TMI headliner is made in the USA and features the factory correct grain and color for your exact application. Also included are matching side sails and sunvisors for a complete factory replacement.



**1964-65 Chevelle 2 Door Coupe, Basketweave**

TMI-HLCH645-001 Black.....224.99 kit

**1966 Chevelle 2 Door Coupe, Basketweave**

TMI-HLCH66-008 Black.....224.99 kit

**1967 Chevelle 2 Door Coupe, Impala/Surrey**

TMI-HLCH67-016 Black.....224.99 kit

**1968 Chevelle 2 Door Coupe, Bedford/Ribbed**

TMI-HLCH68-021 Black.....224.99 kit

**1969 Chevelle 2 Door Coupe, Bedford/Ribbed**

TMI-HLCH69-029 Black.....224.99 kit

**1969 Chevelle 2 Door Coupe, Perforated**

TMI-HLCH69-036 Black.....224.99 kit

**1970 Chevelle 2 Door Coupe, Perforated**

TMI-HLCH70-040 Black.....224.99 kit

**1971-72 Chevelle 2 Door Coupe, Perforated**

TMI-HLCH712-051 Black.....224.99 kit

*All TMI Headliners and Sunvisors are available in black suede to match Sport R seats. Please ask your sales rep for details.*

*Note: Due to variations in printing, it is impossible to perfectly represent headliner colors in this catalog. Use our color swatch chart as a guide only. We will gladly mail you a color sample before you place your order upon request. Please note that colors other than black are non-returnable. Call For Colors.*



IHB-411

**Headliner Wire Bows**

OE style reproduction of these often damaged or missing steel bows.

IHB-411 1964-65 Coupe.....69.99 set  
 IHB-412 1966-67 Coupe.....69.99 set  
 IHB-413 1968 Coupe 6 Bow .....79.99 set  
 IHB-414 1968-72 Coupe 5 Bow .....69.99 set  
 IHB-409 1964-67 El Camino .....55.99 set  
 IHB-410 1968-72 El Camino .....49.99 set



IBC-20

IBC-73

**Headliner Bow Clips**

Correct style plastic bow retaining clips.

IBC-20 1968-72 Small.....6.99 ea.  
 IBC-73 1968-72 Large.....6.95 ea.  
 IBC-10 1968-72 Sedan 6pc .....26.99 kit  
 IBC-12 1968-72 Outer Small 4pc .....14.99 set  
 IBC-7892 1985-88 Rear Trim Clip.....4.99 ea.

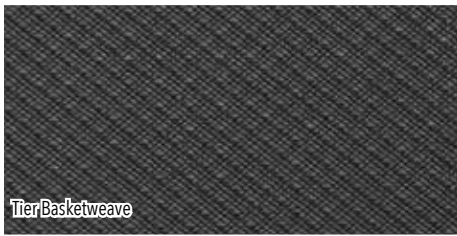

Tier Basketweave



Ribbed

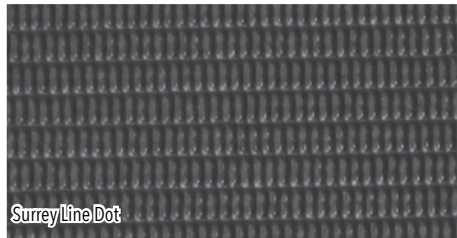

Surrey Line Dot

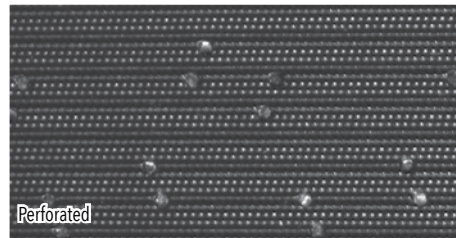

Perforated



**PUI Headliners**

These high quality PUI headliners duplicate the original colors and grains exactly and come ready to install with correct cardboard covered side sails. Please include color choice in \_\_.

**1964-65 Chevelle**

Crafted in correct basketweave material.

- 101 = White
- 103 = Dark Red
- 104 = Light Blue
- 107 = Aqua

IRC-423	Coupe Black	132.99 kit
IRC-64AH_AS	Coupe Color	134.99 kit
IRC-423S	Sedan Black	132.99 kit
IRC-64AH_AS	Sedan Color	134.99 kit

**1966 Chevelle - Early Design Small Sails**

Crafted in correct basketweave material.

- 101 = White
- 103 = Dark Red
- 104 = Light Blue
- 105 = Dark Blue
- 106 = Bright Blue
- 107 = Aqua

IRC-419	Coupe Black	132.99 kit
IRC-66AH_A-1	Coupe Color	134.99 kit
IRC-66AH_AS-1	Sedan Color	104.95 kit

**1966-67 Chevelle**

Crafted in correct Surrey Line Dot material.

- 101 = White
- 103 = Dark Red
- 104 = Light Blue
- 106 = Bright Blue
- 118 = Gold

IRC-426	Coupe Black	134.99 kit
IRC-66AH_S	Coupe Color	158.99 kit
IRC-426S	Sedan Black	129.99 kit
IRC-66AH_SS	Sedan Color	134.99 kit

**1968 Chevelle**

Crafted in correct ribbed material.

- 101 = White
- 103 = Dark Red
- 105 = Dark Blue
- 117 = Ivy Gold
- 116 = Medium Blue

IRC-420	5 Bow Black	132.99 kit
IRC-68AH_R	5 Bow Color	134.99 kit
IRC-46B	6 Bow Black	132.99 kit
IRC-68AH_R6	6 Bow Color	134.99 kit



**1969 Chevelle**

Crafted in correct ribbed material.

- 101 = White
- 103 = Dark Red
- 105 = Dark Blue
- 109 = Dark Green

IRC-421	All Black	132.99 kit
IRC-69AH_R	All Color	158.99 kit

**1970-72 Chevelle**

Crafted in correct perforated material.

- 101 = White
- 102 = Bright Red
- 103 = Dark Red
- 105 = Dark Blue
- 106 = Bright Blue
- 108 = Saddle
- 109 = Dark Green
- 111 = Sandalwood
- 112 = Buckskin

IRC-450	All Black	132.99 kit
IRC-70AH_B	All Color	158.99 kit

**1964-67 El Camino**

Crafted in correct basketweave material.

- 101 = White
- 103 = Dark Red
- 104 = Light Blue
- 106 = Bright Blue
- 107 = Aqua

IRC-E423	All Black	129.99 kit
IRC-E64CH_A	All Color	134.99 kit

**1968-69 El Camino**

Crafted in correct ribbed material.

- 101 = White
- 103 = Dark Red
- 105 = Dark Blue
- 109 = Dark Green
- 116 = Light Blue
- 117 = Ivy Gold

IRC-E431	All Black	129.99 kit
IRC-E68CH_R	All Color	134.99 kit

**1970-72 El Camino**

Crafted in correct perforated material.

- 101 = White
- 102 = Bright Red
- 103 = Dark Red
- 105 = Dark Blue
- 108 = Dark Saddle
- 109 = Dark Green
- 111 = Sandalwood
- 112 = Buckskin
- 114 = Medium Blue

IRC-E450	All Black	129.99 kit
IRC-E68CH_B	All Color	134.99 kit



IRS-424

**1964-65 Sunvisors Coupe**

Superior quality sunvisors complete with metal shaft and double stitched piping in correct Basketweave material.

Include color choice in \_\_.

- 101 = White
- 104 = Light Blue
- 103 = Dark Red
- 107 = Aqua

IRS-420	Black	114.99 pr.
IRS-420SV1_AC	Color	125.99 pr.

**Early 1966 Sunvisors Coupe**

Superior quality sunvisors complete with metal shaft and double stitched piping in correct Basketweave material.

Include color choice in \_\_.

- 101 = White
- 103 = Dark Red
- 104 = Light Blue
- 105 = Dark Blue
- 106 = Bright Blue
- 107 = Aqua

IRS-429	Black	124.99 pr.
IRS-429SV3_AC	Color	125.99 pr.

**1966-67 Sunvisors Coupe**

Superior quality sunvisors complete with metal shaft and double stitched piping in correct Surrey material.

Include color choice in \_\_.

- 101 = White
- 103 = Dark Red
- 104 = Light Blue
- 106 = Bright Blue
- 118 = Gold

IRS-424	Black	124.99 pr.
IRS-424SV3_SC	Color	125.99 pr.

**1968-69 Sunvisors Coupe**

Superior quality sunvisors complete with metal shaft and double stitched piping in correct Ribbed material.

Include color choice in \_\_.

- 101 = White
- 102 = Bright Red
- 103 = Dark Red
- 105 = Dark Blue
- 106 = Bright Blue
- 108 = Saddle
- 109 = Dark Green
- 111 = Sandalwood
- 112 = Buckskin

IRS-431	Black	124.99 pr.
IRS-431SV5_RC	Color	125.99 pr.

**1970 Sunvisors Coupe**

Superior quality sunvisors complete with metal shaft and double stitched piping in correct Perforated material.

Include color choice in \_\_.

- 101 = White
- 102 = Bright Red
- 103 = Dark Red
- 105 = Dark Blue
- 106 = Bright Blue
- 108 = Dark Saddle
- 109 = Dark Green
- 112 = Buckskin

IRS-450	Black	124.99 pr.
IRS-450SV5_BC	Color	125.99 pr.

**1971-72 Sunvisors Coupe**

Superior quality sunvisors complete with metal shaft and double stitched piping in correct Perforated material.

Include color choice in \_\_.

- 101 = White
- 105 = Dark Blue
- 108 = Dark Saddle
- 109 = Dark Green
- 111 = Sandalwood

IRS-451	Black	124.99 pr.
IRS-451SV6_BC	Color	148.99 pr.



IRS-2V

**1964 Sunvisors Convertible**

Superior quality sunvisors complete with metal shaft and double stitched piping in correct Seville grain vinyl.

Include color choice in \_

- |                 |             |
|-----------------|-------------|
| 50 = Aqua       | 64 = Red    |
| 56 = Light Blue | 65 = Saddle |
| 58 = Light Fawn | 69 = White  |

- |             |            |            |
|-------------|------------|------------|
| IRS-1V      | Black..... | 124.99 pr. |
| IRS-64SV2_V | Color..... | 125.99 pr. |

**1965-67 Sunvisors Convertible**

Superior quality sunvisors complete with metal shaft and double stitched piping in correct Madrid grain vinyl.

Include color choice in \_

- |                  |                   |
|------------------|-------------------|
| 02 = Aqua        | 30 = Red          |
| 12 = Light Blue  | 35 = Light Saddle |
| 22 = Light Fawn  | 37 = White        |
| 14 = Bright Blue | 43 = Gold         |
| 20 = Bronze      | 44 = Slate        |

- |             |            |            |
|-------------|------------|------------|
| IRS-2V      | Black..... | 124.99 pr. |
| IRS-65SV2_V | Color..... | 148.99 pr. |

**1968-72 Convertible**

Superior quality sunvisors complete with metal shaft and double stitched piping in correct Madrid grain vinyl.

Include color choice in \_

- |                          |                  |
|--------------------------|------------------|
| 09 = Blue                | 29 = Covert      |
| 12 = Light Blue          | 30 = Red         |
| 14 = Bright Blue         | 31 = 70' Red     |
| 16 = Dark Blue           | 36 = Saddle      |
| 17 = 68' Blue            | 37 = White       |
| 19 = Jade Green          | 41 = Sandalwood  |
| 23 = Light Green         | 42 = Dark Saddle |
| 24 = Dark Metallic Green | 43 = Gold        |
| 25 = Dark Green          | 46 = Ivy Gold    |
| 27 = Parchment           | 47 = Tan         |
| 28 = Pearl               |                  |

- |             |            |            |
|-------------|------------|------------|
| IRS-3V      | Black..... | 124.99 pr. |
| IRS-3VSV4_V | Color..... | 148.99 pr. |



IBB-0753

ISS-4104

**Sunvisor Supports**

Reproduction chrome plated supports.

- |           |                          |            |
|-----------|--------------------------|------------|
| IBB-0753  | 1964-72 Coupe.....       | 24.99 ea.  |
| KEC-645K  | 1964-65 Convertible..... | 129.99 pr. |
| KEC-66K   | 1966-67 Convertible..... | 124.99 pr. |
| ISS-4104  | 1968-72 Convertible..... | 77.99 pr.  |
| ISS-12545 | Screws (6 pc.).....      | 3.99 kit   |



IC-21

**Sunvisor Bushings/Tips**

Correct bushing and tip kit for two visors.

- |       |                   |          |
|-------|-------------------|----------|
| IC-21 | 1964-72 All ..... | 8.99 pr. |
|-------|-------------------|----------|



ICC-0089K

**Dome Lamp Lens Assembly**

Includes base, lens, bulb, clips and wire leads.

- |           |                         |           |
|-----------|-------------------------|-----------|
| IHQ-0117K | 1964-67 Chevelle .....  | 39.95 kit |
| ICC-0089K | 1968-70 Chevelle .....  | 35.99 kit |
| ICE-0351K | 1971-77 Chevelle .....  | 39.95 kit |
| IDB-21K   | 1964-67 El Camino ..... | 39.95 kit |
| IDB-23K   | 1968-87 El Camino ..... | 39.95 kit |



IHQ-0117



ICC-0089



ICE-0351

**Dome Lens Bezels**

New plastic molded chrome plated as original.

- |          |                             |           |
|----------|-----------------------------|-----------|
| IHQ-0117 | 1964-67 Coupe.....          | 10.99 ea. |
| ICC-0089 | 1968-70 Coupe.....          | 21.99 ea. |
| ICE-0351 | 1971-77 Coupe.....          | 11.95 ea. |
| IDB-21   | 1964-67 El Camino.....      | 14.95 ea. |
| IDB-23   | 1968-77 El Camino.....      | 13.95 ea. |
| IDL-CLIP | 1970-77 Harness Clips ..... | 11.99 ea. |



INQ-0203

ICE-2777



IBB-0138

**Dome Light Lenses**

Correct white plastic lenses.

- |            |                                  |           |
|------------|----------------------------------|-----------|
| INQ-0203   | 1964-67 Coupe.....               | 4.99 ea.  |
| IBB-0138   | 1968-70 Coupe.....               | 6.95 ea.  |
| ICE-2777   | 1971-77 Coupe.....               | 5.95 ea.  |
| IDL-17     | 1964-67 El Camino.....           | 9.95 ea.  |
| IDL-19     | 1968-77 El Camino.....           | 5.95 ea.  |
| ICE-69-MAP | 1970-88 Roof Map Light Lens..... | 21.99 ea. |



DT-200007

**LED Dome Light Bulb**

A simple direct replacement for your dome light bulb. This LED bulb features 9 dual super bright LEDs in a 211 bulb package. Excellent to increase brightness and reduce heat and power.

- |           |                    |           |
|-----------|--------------------|-----------|
| DT-200007 | 211 LED Bulb ..... | 13.95 ea. |
|-----------|--------------------|-----------|



17600

**Dome Light Harnesses**

Correct dome light harness.

- |               |                         |           |
|---------------|-------------------------|-----------|
| 06885         | 1964 All .....          | 24.99 ea. |
| 07580         | 1965 All .....          | 29.99 ea. |
| 17600         | 1966-67 All .....       | 26.99 ea. |
| 30205         | 1968-72 All .....       | 34.99 ea. |
| 30205-PIGTAIL | All Repair Harness..... | 13.99 pr. |
| IBU-11A       | All Bulb .....          | 2.95 ea.  |



**Interior Bulb Kits**

Vehicle specific kits include all interior bulbs for a complete replacement.

- |           |                   |           |
|-----------|-------------------|-----------|
| BULB-65AI | 1965 All .....    | 24.99 kit |
| BULB-66AI | 1966-67 All ..... | 26.99 kit |
| BULB-68AI | 1968-69 All ..... | 25.99 kit |
| BULB-70AI | 1970 All .....    | 26.99 kit |
| BULB-71AI | 1971-72 All ..... | 27.99 kit |



RAL-15212

**1965-67 Chevelle Convertible Rear Arm Rest Light Lens**

Used only on 65-67 Chevelle convertibles equipped with the convertible light package, these rear arm rest light lenses are reproductions, down to the off-white coloring.

- |           |                          |           |
|-----------|--------------------------|-----------|
| RAL-15212 | 1965-67 Convertible..... | 11.99 pr. |
|-----------|--------------------------|-----------|

IO-4920

### Front Upper Windshield Moldings

Correct upper windshield moldings to finish off your interior.

IO-4920	1964-67	.....26.99 ea.
IT-3333	1968-72	.....44.99 ea.

### Inner Rear Window Trim

Correct molded plastic rear inner window trim.

IV-4171	1964-65 Coupe (7 pc.)	.....79.99 set
IV-4177	1964-65 Sedan (3 pc.)	.....79.95 set
IV-4819	1964-67 El Camino (6 pc.)	.....69.95 set
IV-4341	1966-67 Coupe (3 pc.)	.....84.99 set
IJ-3212	1968-72 Coupe (1 pc.)	.....59.99 ea.

**BUY 'N SAVE**  
WITH KITS

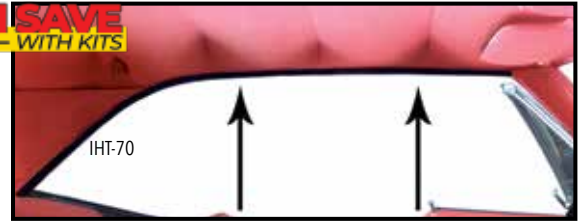

### 1968-72 Molded Headliner Side Trim

Correct molded urethane headliner side trim.

IHT-70	1968-72 All	.....73.99 set
--------	-------------	----------------

### 1968-72 Trim Kit

This is a complete inner trim kit including headliner side trim, upper windshield molding and rear window trim.

IHT-KIT	1968-72 Coupe	.....143.18 kit
---------	---------------	-----------------

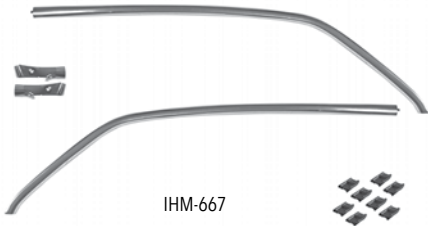

### 1964-67 Chrome Headliner Side Trim

Reproduction of this hard to find side trim. Includes mounting clips.

IHM-645	1964-65 Stainless Steel	.....259.99 set
IHM-667	1966-67 All Polished Aluminum	.....169.99 set

*Ships Oversize. Not eligible for free shipping.*



### Windshield Pillar Moldings

New injection molded moldings in correct factory styles and grains.

IXM-501	1968-69 Coupe	.....99.99 pr.
IXM-500	1968-69 El Camino	.....99.99 pr.
IXM-505	1968-72 Convertible	.....99.99 pr.
IXM-68L	1968-72 Coupe Steel LH	.....134.99 ea.
IXM-68R	1968-72 Coupe Steel RH	.....134.99 ea.
IXM-68K	1968-72 Coupe Steel Pair	.....242.98 kit
IXM-12524	Coupe Screws (8 pc.)	.....5.99 kit
IXM-12537	Convrt Screws (8 pc.)	.....4.99 kit



### Rear Window Corners

Reproduction lower rear window corners.

IV-4585	1968-72 All	.....30.99 pr.
---------	-------------	----------------



### Coat Hooks

ICH-556	1964-66 1st Design	.....10.99 pr.
ICH-753	1964-72 Chrome	.....6.95 ea.
ICH-753K	1964-72 Chrome Pair*	.....12.95 kit

\* No Volume Discount.



### Billet Rear View Mirror

Show quality polished billet aluminum rear view mirror features ball milled grooves and a day/night lever.

GCS-S6065	All	.....52.99 ea.
-----------	-----	----------------

Note: Glues to the windshield glass.



### Rear View Mirror w/ Map Light

Custom factory style mirror featuring a built-in map light day/night lever. Mounts easily in place of your factory mirror and features correct terminal to plug into your factory fuse block.

IM-6808-ML	1964-67 8" All	.....105.95 ea.
IM-6810-ML	1968-69 10" All	.....105.95 ea.
IM-6812-ML	1968-72 12" All	.....109.95 ea.

Years listed correctly by size but all of these will fit any year 1964-72.



### Rear View Mirrors

Reproduction polished stainless steel mirrors with day/night levers.

IM-621	1964-67 8" Early Design	.....39.95 ea.
IK-483	1964-67 8" Late Design	.....49.95 ea.
IM-6810	1968-69 10"	.....53.99 ea.
IM-6812	1968-72 12"	.....52.99 ea.
IMB-6812-OE	1964-72 Bushing Insert	.....3.99 ea.
IM-419B	1978-88 8" Black	.....54.99 ea.
IE-842	Adjusting Screw	.....2.99 ea.

Early design does not have day/night lever. Late design has day/night lever.



### Rear View Mirror Bracket & Boot

Correct bracket for supporting rear view mirror.

#### Bracket

IT-1730	1964-65 Coupe	.....29.99 ea.
IT-645V	1964-65 Convertible	.....44.99 ea.
IT-1733	1966 Coupe	.....34.99 ea.
IT-66V	1966 Convertible	.....44.99 ea.
IT-1736	1967 Coupe*	.....44.99 ea.
IT-1736V	1967 Convertible	.....39.95 ea.
IK-18	1968-72 Coupe	.....46.99 ea.
IT-68V	1968-72 Convertible	.....36.99 ea.
IMP-1Z	1973-88 Mount All	.....6.99 ea.

#### Boot

IBC-67C	1967 Coupe	.....22.99 ea.
IBC-67V	1967 Convertible	.....28.95 ea.
IBC-68C	1968-70 Coupe	.....32.99 ea.
IBC-712C	1971-72 Coupe	.....32.99 ea.
IBC-68V	1968-72 Convertible	.....34.99 ea.

\*1967 bracket includes boot.



IK-574



IJ-44

**Standard Steering Wheels**

GM licensed reproduction standard wheels.

IK-574	1967 Deluxe 17" .....	329.99 ea.
IJ-44	1969-70 All 16" .....	249.99 ea.
IK-536	1968 Deluxe .....	299.99 ea.



IK-7Z

**1969+ 4 Spoke Steering Wheel-Simulated Rope Wrap**

IK-7Z	1969+ 4 Spoke Wheel.....	239.99 ea.
-------	--------------------------	------------



IK-704

**1971-77 4 Spoke Sport Steering Wheel**

Superb reproduction of the original GM 4-spoke Sport steering wheel designed for many various 1971-1981 GM models with the NK4 steering wheel option. This quality reproduction features a soft black padding, original grain material and a 4-spoke design as original.

IK-704	1971-77 4 Spoke Smooth .....	249.99 ea.
--------	------------------------------	------------



IWW-6



IK-622



IK-623



IM-370



IM-370-BLKSPK

**Sport Steering Wheels**

OE style reproduction sport steering wheels to replace your originals or upgrade from standard.

IWW-6	1964-66 Wood 16.5" .....	219.99 ea.
IK-622	1967-68 Walnut 16" .....	289.99 ea.
IK-623	1969 Rosewood 16" .....	289.99 ea.
IM-370	1969-81 Black 15" .....	159.95 ea.
IM-370-RED	1969-77 Red 15" .....	179.95 ea.
IM-370-BLUE	1969-77 Blue 15" .....	179.95 ea.
IM-370-SADDLE	1969-77 Saddle Tan 15" .....	179.95 ea.
IM-370-BLKSPK	1969-77 Black w/ Black Spokes 15" .....	169.99 ea.
IM-379	1969-70 Black w/ Silver Spokes w/ Slots 15" .....	164.95 ea.
IM-377	1969-70 Black w/ Silver Spokes w/ Holes 15" .....	169.99 ea.



IWK-6K

**BUY'N SAVE WITH KITS**

**Sport Steering Wheel Kits**

Add serious style and save some bucks when you buy one of these awesome sport wheel kits. Each kit includes steering wheel, hub, contacts, horn cap, cam and hardware.

IWK-4K	1964 Wood .....	362.63 kit
IWK-5K	1965 Wood .....	371.63 kit
IWK-6K	1966 Wood .....	359.93 kit

No Volume Discount.



IWN-KIT

Optional SS Cap      Optional Yenko Cap

**BUY'N SAVE WITH KITS**

**Wood Steering Wheel Kits**

Add one of these beautiful wood grain steering wheels to your car with one of our kits. Each kit includes steering wheel, hub, contacts, horn cap, cam and hardware.

IWN-KIT	1967-68 Walnut w/o Tilt .....	388.83 kit
IWN-7T	1967-68 Walnut w/ Tilt .....	374.33 kit
IWN-SSKIT	1967-68 Walnut w/o Tilt w/ SS Cap .....	423.83 kit
IWN-SS7T	1967-68 Walnut w/ Tilt w/ SS Cap .....	423.83 kit
IWN-KIT-YENKO	1967-68 Walnut w/o Tilt .....	433.83 kit
IWN-7T-YENKO	1967-68 Walnut w/ Tilt .....	433.83 kit
IRW-KIT	1969-72 Rosewood w/o Tilt .....	378.86 kit
IRW-9T	1969-72 Rosewood w/ Tilt .....	383.36 kit
IRW-SSKIT	1969-72 Rosewood w/o Tilt w/ SS Cap .....	413.87 kit
IRW-SS9T	1969-72 Rosewood w/ Tilt w/ SS Cap .....	418.37 kit
IRW-KIT-YENKO	1969-72 Rosewood w/o Tilt .....	423.86 kit
IRW-9T-YENKO	1969-72 Rosewood w/ Tilt .....	428.36 kit

Can be used on all 1967-77. No Volume Discount.





IXS-678



IXS-SS678-BLK



IXS-SS69T-H



Optional SS Cap



Optional Yenko Cap



**Comfortgrip Steering Wheel Kits**

Add some muscle to your interior with our black Comfortgrip steering wheel kit. Each kit includes steering wheel, hub, contacts, horn cap, cam and hardware. This kit will work on all 1967+ but is correct for 1969-70 models.

IXS-678-S	1967-68 Black w/ Silver Spokes w/ Slots.....	247.25 kit
IXS-678-H	1967-68 Black w/ Silver Spokes w/ Holes.....	251.53 kit
IXS-6970-S	1969-70 Black w/ Silver Spokes w/ Slots w/o Tilt.....	251.53 kit
IXS-6970-H	1969-70 Black w/ Silver Spokes w/ Holes w/o Tilt.....	255.82 kit
IXS-69T-S	1969-70 Black w/ Silver Spokes w/ Slots w/ Tilt.....	255.78 kit
IXS-69T-H	1969-70 Black w/ Silver Spokes w/ Holes w/ Tilt.....	260.07 kit
IXS-678	1967-68 Black w/ Silver Spokes.....	243.00 kit
IXS-678-BLK	1967-68 Black w/ Black Spokes.....	251.53 kit
IXS-6970-BLK	1969-70 Black w/ Black Spokes w/o Tilt.....	255.82 kit
IXS-69T-BLK	1969-70 Black w/ Black Spokes w/ Tilt.....	260.07 kit
IXS-6970	1969-70 Black w/o Tilt.....	247.28 kit
IXS-69T	1969-70 Black w/ Tilt.....	251.53 kit
IXS-SS678-BLK	1967-68 Black w/ Silver Spokes w/ SS Cap.....	289.03 kit
IXS-SS678-S	1967-68 Black w/ Silver Spokes w/ Slots & SS Cap.....	284.75 kit
IXS-SS678-H	1967-68 Black w/ Silver Spokes w/ Holes & SS Cap.....	289.03 kit
IXS-SS6970-S	1969-70 Black w/ Silver Spokes w/ Slots w/o Tilt & SS Cap.....	289.03 kit
IXS-SS6970-H	1969-70 Black w/ Silver Spokes w/ Holes w/o Tilt & SS Cap.....	293.32 kit
IXS-SS69T-S	1969-70 Black w/ Silver Spokes w/ Slots w/ Tilt & SS Cap.....	293.28 kit
IXS-SS69T-H	1969-70 Black w/ Silver Spokes w/ Holes w/ Tilt & SS Cap.....	297.57 kit
IXS-SS6970-BLK	1969-70 Black w/ Black Spokes w/o Tilt w/ SS Cap.....	293.32 kit
IXS-SS69T-BLK	1969-70 Black w/ Black Spokes w/ Tilt w/ SS Cap.....	297.57 kit
IXS-SS6970	1969-70 Black w/o Tilt w/ SS Cap.....	284.78 kit
IXS-SS69T	1969-70 Black w/ Tilt w/ SS Cap.....	289.03 kit
IXS-6970-YENKO	1969-70 Black w/o Tilt Yenko Cap.....	294.78 kit
IXS-69T-YENKO	1969-70 Black w/ Tilt Yenko Cap.....	299.03 kit
IXS-6970-BLUE	1969-70 Bright Blue w/o Tilt.....	264.28 kit
IXS-69T-BLUE	1969-70 Bright Blue w/ Tilt.....	268.53 kit
IXS-6970-RED	1969-70 Red w/o Tilt.....	264.28 kit
IXS-69T-RED	1969-70 Red w/ Tilt.....	268.53 kit
IXS-SS6970-BLUE	1969-70 Bright Blue w/o Tilt w/ SS Cap.....	301.78 kit
IXS-SS69T-BLUE	1969-70 Bright Blue w/ Tilt w/ SS Cap.....	319.33 kit
IXS-SS6970-RED	1969-70 Red w/o Tilt w/ SS Cap.....	301.78 kit
IXS-SS69T-RED	1969-70 Red w/ Tilt w/ SS Cap.....	319.33 kit

Correct for 1969-70 but can be used on all 1967-77. No Volume Discount.

**BUY'N SAVE WITH KITS**



GT14-4331-2K



GT36-5459-1K



**GT Performance Steering Wheel Kits**

Our exclusive GT Performance steering wheel kits take away all guess work! Upgrade your worn out original steering wheel with these exclusive GT Performance steering wheel kits! They include everything you'll need to make the swap: steering wheel, hub and horn button.

GT14-4331-1K	1964-68 Classic Black Foam Wheel.....	196.99 kit
GT14-4331-2K	1969-77 Classic Black Foam Wheel.....	196.99 kit
GT14-5437-1K	1964-68 Classic Wood Wheel.....	306.99 kit
GT14-5437-2K	1969-77 Classic Wood Wheel.....	306.99 kit
GT36-5431-1K	1964-68 Retro Black Foam Wheel w/ Chrome Spokes.....	202.99 kit
GT36-5431-2K	1969-77 Retro Black Foam Wheel w/ Chrome Spokes.....	202.99 kit
GT36-5451-1K	1964-68 Retro Black Foam Wheel w/ Stainless Spokes.....	302.99 kit
GT36-5451-2K	1969-77 Retro Black Foam Wheel w/ Stainless Spokes.....	302.99 kit
GT36-5457-1K	1964-68 Retro Light Wood Wheel.....	390.99 kit
GT36-5457-2K	1969-77 Retro Light Wood Wheel.....	390.99 kit
GT36-5459-1K	1964-68 Retro Dark Wood Wheel.....	390.99 kit
GT36-5459-2K	1969-77 Retro Dark Wood Wheel.....	390.99 kit

No Volume Discount. Not eligible for shipping discount.



**1966 Deluxe SS Wheel**

This is an excellent reproduction of the 1966 Chevelle Super Sport steering wheel assembly, which is a nice replacement for an original and is also perfect for upgrading from a standard wheel. This assembly includes the steering wheel, horn ring and cap. Cap and horn ring also available separately.

- IK-573 Wheel.....374.99 ea.
- IK-573-RING Horn Ring.....99.99 ea.
- IK-573-CAP Horn Cap.....99.99 ea.



**1967 Deluxe SS Wheel**

Excellent reproduction injection molded steering wheel equipped on Chevelle SS models. Mounting components available separately.

- IK-574 Wheel.....329.99 ea.
- IHB-67SS Buttons.....35.99 pr.
- IBC-67SS Contacts .....29.99 pr.
- IK-67SS Mounting Kit.....36.99 kit
- IHC-67SS Horn Cap.....77.99 ea.

No Volume Discount.



NR-492



NR-493

**1969-70 Standard Wheel Kits**

Everything you need to replace your original wheel! High quality reproduction steering wheel, center shroud, horn buttons, & contacts.

- NR-492 1969-70 Black\* 15.5".....289.99 kit
- NR-493 1969-70 Wood\* 15.5".....323.96 kit
- NR-70 1970 Black 15.5".....289.99 ea.

\*Correct for 1969 but can be used on all 1967-72.

No Volume Discount.



IK-712SS

**1971-72 SS Steering Wheel**

OE style reproduction of this hard to find wheel.

- IK-712SS 1971-72 SS Wheel.....324.99 ea.



NK-126



NK-127



NK-213

NK-292



IY-31

IC-588

**Standard Shroud**

Excellent high quality reproduction.

- NK-126 1969-70 Shroud Black.....64.99 ea.
- NJ-127 1969-70 Shroud Wood.....69.99 ea.
- NK-213 1969-70 Horn Buttons.....19.99 pr.
- NK-292 1969-70 Horn Contacts.....19.99 pr.
- ICC-7172 1971-72 Horn Contact Wire.....26.99 ea.
- IC-588 1969 SS Emblem.....19.99 ea.
- IY-31 1970 SS Emblem.....17.99 ea.

Note: Grain is correct for 1969, but differs slightly from 1970.



IH-4000

IH-4200

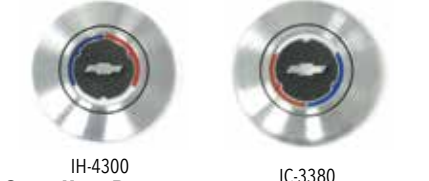

IH-4300

IC-3380

**Sport Horn Buttons**

- IH-4000 1964 Sport Wheel.....69.99 ea.
- IH-4200 1965 Sport Wheel.....79.99 ea.
- IH-4300 1966 Sport Wheel.....66.99 ea.
- IC-3380 1967-70 Sport Wheel.....49.99 ea.
- ICS-48 1966-70 Cap Mount Sport Wheel.....19.99 ea.



IHC-SS

IHC-YENKO

**SS Horn Button**

Awesome brushed aluminum cap with SS logo for all sport wheels.

- IHC-SS 1967-70 w/ Sport.....99.99 ea.

**Yenko Horn Button**

Custom brushed aluminum cap with Yenko logo for all sport wheels.

- IHC-YENKO 1967-70 w/ Sport.....99.99 ea.



IH-4001

IH-4301



IH-4460

IH-4450

**Standard Horn Buttons**

IH-4001	1964 Standard.....	68.99 ea.
IH-4201	1965 Standard.....	86.99 ea.
IH-4301	1966 Standard.....	61.99 ea.
IH-4460	1967 Chevelle.....	45.99 ea.
IH-4450	1967 Super Sport.....	41.99 ea.
IH-4465	1967 Bowtie.....	37.99 ea.



IHC-71

ICR-71



ICE-742

ICE-886

**1971-79 NK4 Horn Caps**

Reproduction caps and accessories for your optional NK4 sport wheel.

IHC-71	1971-77 Horn Cap.....	18.99 ea.
ICR-71	1971-77 Cap Retainer.....	9.99 ea.
ICE-742	1971-77 Bowtie Emblem.....	31.99 ea.
ICE-737	1971-77 Bowtie Circle.....	34.99 ea.
ICE-886	1971-77 SS.....	32.99 ea.



IWE-6775



IWE-4475

**1968 N30 Emblems**

Reproduction emblems for the 1968 optional N30 deluxe steering wheel.

IWE-6775	1968 SS.....	21.99 ea.
IWE-4475	1968 SS396.....	34.99 ea.



IZ-65

**Steering Wheel Hubs**

Correct cast steering wheel mounting hub for all cars with sport wheels.

IZ-65	1964-66 All.....	69.95 ea.
IK-062	1967-68 All.....	42.95 ea.
IJ-3520	1969-70 All.....	44.99 ea.
IJ-3520-CHRM	1969-70 All Chrome.....	45.01 ea.



IK-8

**Horn Contact Kits**

Complete kit for repairing horn contacts.

IHC-646	1964-66 All Standard.....	24.99 kit
IHC-KIT	1967-68 All Standard.....	29.99 ea.
IK-675	1964-66 Sport w/o Tilt.....	42.99 ea.
IK-7	1967-68 Sport All.....	32.99 ea.
IHC-KIT	1967 Deluxe Wheel.....	29.99 ea.
IK-579	1969-70 Sport w/o Tilt.....	35.99 ea.
IK-8	1969-70 Sport w/ Tilt.....	40.99 ea.
ICS-3	1967-70 Sport Spring/Pin.....	7.99 ea.
IHC-KIT	1971-77 w/ 4 Spoke Wheel.....	29.99 ea.



ICC-675

**Turn Signal Cancel Cam**

Correct cam which turns off signal light.

ICC-675	1964-66 w/o Tilt.....	32.99 ea.
ICC-4185	1964-66 w/ Tilt.....	23.99 ea.
ICC-7	1967-68 w/o Tilt.....	17.99 ea.
ICC-9	1969-77 w/o Tilt.....	17.99 ea.
ICC-5149	1967-68 w/ Tilt.....	32.99 ea.
ICC-93	1969-70 w/ Tilt.....	17.99 ea.
ICC-7172	1971-72 Contact Wire Standard SS Wheel.....	26.99 ea.
ICS-48	1966-70 Horn Cap Mount Sport Wheel.....	19.99 ea.



ISC-6981

**Tilt Steering Column Housing Sleeve**

Reproduction tilt steering column housing sleeve. Used to replace a column shift sleeve to convert your column to floor shift manual or automatic.

ISC-6981	1969-81 w/ Tilt Floor Shift.....	99.99 ea.
----------	----------------------------------	-----------

No Volume Discount.



TILT-69AA



TILT-69AM



TILT-78GCS

**Original GM Steering Columns**

These steering columns are the real deal! Each original GM unit is professionally rebuilt using OEM parts. We even include the turn signal switch! Limited supply!

Tilt Columns

TILT-69AA	1969-72 Auto Floor.....	767.99 ea.
TILT-69AM	1969-72 Manual Floor.....	767.99 ea.
TILT-69AOC	1969-72 Auto on Column.....	676.99 ea.
TILT-78GCS	1978 Monte Column Shift w/o Warning Lights.....	607.99 ea.
TILT-78GCS	1978 Monte Column Shift w/ Warning Lights.....	607.99 ea.
TILT-78GFS	1978 Monte Floor Shift w/o Warning Lights.....	607.99 ea.
TILT-78GFS	1978 Monte Floor Shift w/ Warning Lights.....	631.99 ea.
TILT-79GCS	1979-81 Monte Column Shift w/o Warning Lights.....	634.99 ea.
TILT-79GCS	1979-81 Monte Column Shift w/ Warning Lights.....	628.99 ea.
TILT-79GFS	1979-81 Monte Floor Shift w/o Warning Lights.....	634.99 ea.
TILT-79GFS	1979-81 Monte Floor Shift w/ Warning Lights.....	623.99 ea.
TILT-79GCS	1979-81 Monte Column Shift w/o Warning Lights.....	634.99 ea.
TILT-79GCS	1979-81 Monte Column Shift w/ Warning Lights.....	628.99 ea.
TILT-79GFS	1979-81 Monte Floor Shift w/o Warning Lights.....	634.99 ea.
TILT-79GFS	1979-81 Monte Floor Shift w/ Warning Lights.....	623.99 ea.

Non-Tilt Columns

INT-645FS	1964-65 All Floor Shift.....	596.99 ea.
INT-66FS	1966 All Floor Shift.....	665.99 ea.
INT-69AAC	1969-72 Auto On Column.....	598.99 ea.
INT-69AA	1969-72 Auto On Floor.....	598.99 ea.

No Volume Discount. Ships Overseas.  
Includes shift lever where applicable.



FBK-678



FBK-7572

**1967-77 Steering Column Lower Bearing Kit**

This easy to install upgraded lower bearing will ensure years of trouble free operation.

FBK-678	1967-68 All w/o Tilt.....	79.99 ea.
FBK-7572	1969-77 All w/ Tilt.....	49.99 kit

No Volume Discount.



FBK-TILT



FBK-6977U

**Steering Column Upper Bearing**

Brand new upper steering column bearings. This part commonly fails and is an easy way to make your worn out column like new again.

FBK-TILT	1969-75 w/ Tilt.....	74.99 ea.
FBK-6977-U	1969-77 w/o Tilt.....	49.99 ea.



GCS-S6062

**Steering Column Dress Up Kit**

A great way to personalize your interior! Includes turn signal lever, tilt wheel lever and emergency flasher knob.

GCS-S6062	1967-72.....	19.99 kit
-----------	--------------	-----------



GCS-S6063

**Billet Column Shifter Lever**

A great upgrade to any column shifted car!

GCS-S6063	1967-72.....	39.99 ea.
-----------	--------------	-----------



IT-4470



IT-2299



IT-5168

**Tilt Wheel Levers**

Reproduction tilt wheel release levers.

IT-2299	1964-66.....	17.99 ea.
IT-4470	1967.....	17.99 ea.
IT-5168	1968-70.....	15.99 ea.
IT-2951	1971-74.....	16.99 ea.



IT-5174



IT-3208



IT-5162

**Turn Signal Levers**

Reproduction turn signal levers.

IT-3208	1964-66 w/o Tilt.....	23.99 ea.
IT-5162	1964-66 w/ Tilt.....	23.99 ea.
IT-5165	1967 w/ Tilt.....	19.99 ea.
IT-5174	1968-70 All.....	17.99 ea.
IT-5176	1971-74 All.....	17.99 ea.
IT-2503G	1982-83 w/ Wiper & Cruise.....	32.99 ea.



ICC-12005

**Steering Column Cap**

Used to hold the end of the column together.

ICC-12005	1969-77 All.....	22.99 ea.
-----------	------------------	-----------



RSC-1400L

**Steering Column Clamp Plates**

RSC-646A	1964-66 Auto 1pc.....	36.99 ea.
RSC-646M	1964-66 Manual 1pc.....	36.99 ea.
RSC-647A	1964-67 Auto.....	42.99 set
RSC-647M	1964-67 Manual.....	42.99 set
RSC-1400L	1968-72 Auto.....	44.99 pr.
RSC-68AM	1968-72 4spd.....	54.99 set
RSC-68ACC	1968-72 Auto, Cruise.....	69.99 set
BCS-64A	1964-67 Auto Hardware.....	15.99 kit
BCS-64M	1964-67 Manual Hardware.....	11.99 kit
BCS-68A	1968-72 All Hardware.....	12.99 kit

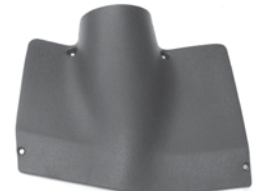

ISC-68

**Steering Column Covers**

Correct injection molded lower covers.

ISC-67	1967 All.....	29.99 ea.
ISC-68	1968 All.....	39.99 ea.
ISC-69	1969 All.....	27.99 ea.
ISC-4576	1970-72 SS.....	31.99 ea.
ISC-70M	1970-72 Malibu.....	39.99 ea.



RCB-645A



ISB-1498D

**Steering Column Bracket**

Bolts to the bottom of the dash to hold up steering column.

RCB-645A	1964-65 All.....	21.99 ea.
RCB-66A	1966 All.....	21.99 ea.
ISB-1498D	1969-72.....	69.99 ea.



IRE-64



IRD-64M



IRE-66



IRD-66M



IRE-100



IRD-68M

### Rear Deck Package Trays

Correct vinyl covered, die-stamped cardboard package trays. Available in standard or deluxe mesh with speaker cutouts on the underside.

#### Standard

IRE-64	1964-65 All .....	21.99 ea.
IRE-66	1966-67 w/ Large Sails .....	21.99 ea.
IRE-66AP09-1	1966-67 w/ Small Sails .....	21.99 ea.
IRE-100	1968-72 All .....	21.99 ea.

#### Deluxe

IRD-64M	1964-65 All (Single Center Speaker Hole) .....	64.99 ea.
IRD-66M	1966-67 All (Single Center Speaker Hole) .....	64.99 ea.
IRD-68M	1968-72 All (Stereo Speaker Holes) .....	69.99 ea.

Note: These package trays are for coupes only. Please notify your sales rep if you have a sedan. All package trays ship double Oversize. Not eligible for free shipping. Call for colored package trays. See page 4 for color codes. Add a "P" in front of code for "package tray".



### Trunk Divider Insulation

ITJ-89

Correct die-stamped jute insulation.

ITJ-76	1964-65 All .....	17.99 ea.
ITJ-66	1966-67 All .....	17.99 ea.
ITJ-89	1968-72 All .....	18.99 ea.
ITJ-73A	1973-77 All .....	19.99 ea.



ITD-9

### Trunk Divider Boards

Correct die-stamped cardboard piece which installs between the rear seat and trunk area.

ITD-5	1964-65 All .....	25.99 ea.
ITD-6	1966-67 All .....	25.99 ea.
ITD-9	1968-72 All .....	28.99 ea.
ITD-73A	1973-77 All .....	36.99 ea.

All trunk divider boards ship double Oversize. Not eligible for free shipping.



SPG-6480



SPG-70AN

### Speaker Grilles

Factory OE style speaker grilles. Black paint to match

SPG-6480	1964-77 All Square Sides .....	44.99 ea.
SPG-70AN	1970 All Square Metal .....	92.99 ea.



JSS-5162

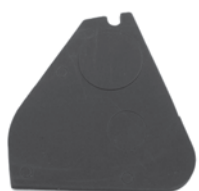

JSS-5151

### Steering Column Seal

Correct neoprene firewall seal.

JSS-5162	1964-67 All .....	5.99 ea.
JSS-5151	1968-72 All .....	6.99 ea.
JSS-115	1978-81 All .....	7.99 ea.



FSG-22

### Speedo / Cruise Cable Grommet

Correct cable grommet.

FSG-22	1964-72 All .....	7.95 ea.
--------	-------------------	----------



IJU-405



IJU-6



IJU-88

### Package Tray Insulation

Correct die-stamped jute insulation.

IJU-405	1964-65 All .....	16.99 ea.
IJU-6	1966-67 All .....	16.99 ea.
IJU-88	1968-72 All .....	16.99 ea.



INL-15429

### 1964-1972 Chevelle Package Tray Blow Out Clip

This clip is correct for all Chevilles to hold the package tray to the metal under-body. When the trunk was slammed, the package tray would blow up and this clip prevented that from happening.

INL-15429	1964-72 Chevelle .....	19.99 ea.
-----------	------------------------	-----------



IPT-2078

### Package Tray End Trims

Molded plastic caps which fit on the edges of the package tray.

IPT-2078	1964-65 All .....	26.99 pr.
IPT-2079	1966-67 All .....	28.99 pr.



IKP-68E

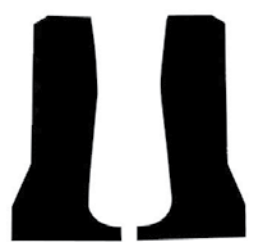

IKP-64E

### 1964-72 El Camino Storage Compartment Trim Panels

Correct trim panels located in the corners of the storage compartments on either side of the cab.

IKP-64E	1964-67 .....	24.99 pr.
IKP-68E	1968-72 .....	89.99 pr.



USA-74CH67



USA-74CH68

**USA 740AM/FM 300 Watts**

The USA-740 offers the same classic look that Custom AutoSound has always been known for with today's latest features. Now, with built-in Bluetooth (microphone included), answer calls and get Bluetooth streaming music from your Bluetooth capable phone or Bluetooth compatible device. A solid 300-watt peak power should be all the juice you need, yet the USA-740 has Hi 4 volt, 4 channel RCA pre-outs and a subwoofer RCA pre-out for additional amplifiers. The USB input allows you to plug in a USB flash drive for playback of MP3/WMA/FLAC/WAV song files. A front 3.5mm mini jack auxiliary audio input and a rear RCA auxiliary audio input provide versatility for options like satellite radio, iPod or any portable player you wish to use. Match the dominant color of your instrument cluster with user selectable multiple LCD color choices with LCD dimmer control. The AM/FM RDS tuner shows station, song and artist on the LCD display. For those of us committed to music collections on compact disc, the USA-740 fully controls the optional Custom AutoSound CD player. Classic style with today's sound and performance taking every road and curve with you in your Chevelle.

USA-74CH64	1964 All	.....	350.99 ea.
USA-74CH65	1965 All	.....	350.99 ea.
USA-74CH67	1966-67 All	.....	350.99 ea.
USA-74CH68	1968 All	.....	350.99 ea.
USA-74CH69	1969-72 All	.....	350.99 ea.
USA-74CH73	1973-77 All	.....	350.99 ea.



**USA-230 AM/FM 200 Watts**

A great look and sound at an awesome price. This Concours series USA-230 radio has no cassette but comes with Auxiliary Input for iPod, MP3, Satellite radio, etc. Classic features with a classic look. These exciting features include:

- AM/FM Stereo • 200 Watts (4 x 50) • Auxiliary Input
- Digital Clock • Electronic Tuner • 30 Pre-sets (12AM-18FM)
- 4 Channel RCA Pre-Outs • 4 Way Fader • Power Antenna Lead

USA-230CH64	1964 All	.....	200.99 ea.
USA-230CH65	1965 All	.....	200.99 ea.
USA-230CH67	1966-67 All	.....	200.99 ea.
USA-230CH68	1968 All	.....	200.99 ea.
USA-230CH69	1969-72 All	.....	200.99 ea.



USA-63CH64



USA-63CH68

**Custom AutoSound USA-630 AM/FM 240 Watts**

The USA-630 is the pinnacle of 30 years of evolution in Custom AutoSound's quest for the perfect classic car radio. This radio has large OEM style push-buttons that give a perfect look in a classic dash. Although it looks classic it has the latest modern features. USB input on the back of the radio. This jack is on an 18" extension which allows you to place it in the glove box or ash tray for easy access (no unsightly wires or plugs hanging out of the front of the radio). The new alpha numeric display (30% larger than previous models) shows the song/artist/album (id3) titles during playback of MP3/WMA files. With the built-in CD controller you have complete control (no FM modulation) of CAS's 10 disc CD changer. This same CD controller also facilitates the optional iCAMKIT iPod® interface that turns your iPod on/off and charges it while giving you control to advance songs or playlist from the buttons on the radio. A great feature so you can keep the iPod hidden away in your glove box or console.

With 240 watts the radio should have all the power you may need, if you want more there are four pre-out jacks on the back of the radio for optional amplifiers. The back of the radio also has auxiliary audio input for satellite radio or any portable player you may wish to use.

- AM-FM Stereo • USA/Euro Tuner • Power Antenna Lead
- Alpha Numeric id3 Display for MP3/WMA files
- Electronic Tuning and Volume Control
- 4 way Fader • Left/ Right Balance • Digital Clock
- 16 Pre-sets (12FM-4AM) • 4 Channel RCA Pre-outs
- Separate Bass and Treble
- 2 Channel RCA Auxiliary Input for Satellite / iPod etc.

USA-63CH64	1964 All	.....	265.99 ea.
USA-63CH65	1965 All	.....	265.99 ea.
USA-63CH67	1966-67 All	.....	265.99 ea.
USA-63CH68	1968 All	.....	265.99 ea.
USA-63CH69	1969-72 All	.....	265.99 ea.



**Custom AutoSound Sound System Kits**

Crank up the tunes with Ground Up Motor Sports's exclusive Sound System Kits! Each kit comes with an in-dash radio, rear speakers, and dash speakers, making it easy to bundle and save while still looking and sounding great!

**Basic Kits**

These kits feature a USA-230 radio, front dash speakers, and rear 6x9 speakers.

SSK-64A	1964 All	.....	313.17 kit
SSK-65A	1965 All	.....	313.17 kit
SSK-667A	1966-67 w/o AC	.....	313.17 kit
SSK-667A-A	1966-67 w/ AC	.....	313.17 kit
SSK-68A	1968 All	.....	313.17 kit
SSK-68A-A	1968 w/ AC	.....	313.17 kit
SSK-69A	1969 All	.....	313.17 kit
SSK-69A-A	1969 w/ AC	.....	313.17 kit
SSK-702A	1970-72 All	.....	313.17 kit

**Upgraded Kits**

These kits feature a USA-630 radio, front dash speakers, and rear 6x9 speakers.

SSK-64A-U	1964 All	.....	397.77 kit
SSK-65A-U	1965 All	.....	397.77 kit
SSK-667A-U	1966-67 w/o AC	.....	397.77 kit
SSK-667A-A-U	1966-67 w/ AC	.....	397.77 kit
SSK-68A-U	1968 All	.....	397.77 kit
SSK-68A-A-U	1968 w/ AC	.....	397.77 kit
SSK-69A-U	1969 All	.....	397.77 kit
SSK-69A-A-U	1969 w/ AC	.....	397.77 kit
SSK-702A-U	1970-72 All	.....	396.87 kit

**Premium Kits**

These kits feature a USA-740 radio, front dash speakers, and rear 6x9 speakers.

SSK-64A-P	1964 All	.....	474.27 kit
SSK-65A-P	1965 All	.....	474.27 kit
SSK-667A-P	1966-67 w/o AC	.....	474.27 kit
SSK-667A-A-P	1966-67 w/ AC	.....	474.27 kit
SSK-68A-P	1968 All	.....	474.27 kit
SSK-68A-A-P	1968 w/ AC	.....	474.27 kit
SSK-69A-P	1969 All	.....	474.27 kit
SSK-69A-A-P	1969 w/ AC	.....	474.27 kit
SSK-702A-P	1970-72 All	.....	473.37 kit

No Volume Discount.



SSK-65A-P



SSK-667A





CAM-CH92-SBR2

**Custom AutoSound Slidebar Radio**

The Slidebar Radio provides the best of both worlds, a true working slidebar display and a full-featured digital display in the same stereo. Simply slide the bar in the center of the radio to the right and hide the analog slidebar revealing a full-featured digital display underneath. The slidebar is designed with large OEM style push-buttons to compliment the look of your classic car. Its digital display provides seven backlight color options designed to match the color of your dash instrumentation.

CAM-CH92-SBR2 1969-72 All ..... 349.99 kit



SECRET-SST

**Secret Audio SST**

Secretaudio SST is a hidden audio system that offers great flexibility for mounting in any type of vehicle. The main receiver/amplifier unit is usually hidden under the seat or behind the dash. A 10ft cord from the Tuner/Amp plugs into a LCD display. The system can be operated from up to 40 feet away with the included RF (radio frequency remote.)

Included with the system is a flush mount bezel for console or dash mounting. The small dimensions of the flush mount system allow you to install the LCD display almost anywhere. The LCD also comes with a bracket mount for easy installation in the glove box, under the dash, in the ashtray, sunvisor, console or wherever you choose. Since its only 1" deep its especially handy for custom or streetrod applications where there may be wiring or ducting routed behind the panels you wish to utilize for mounting. When your installation is finished you'll be rewarded with a quality professionally installed look.

**Features:**

- AM/FM Stereo 200 watts 4x50 • RF Remote Control (radio frequency no line of sight required, up to 40' range)
- USB MP3/WMA Flash Drive Player • iPod® Direct Control Interface (built into tuner/amp unit) iPod Docking Cable Included
- Alpha Numeric LCD Display Shows Artist / Song Titles for USB, iPod® and Satellite Radio
- Satellite Radio Input (for optional Sirius® satellite radio tuner) • Direct CD Changer Control (CD changer optional)
- Auxiliary Audio Input • 4 Channel 3 Volt RCA Pre-Outs (for optional Amplifiers) • Subwoofer Pre-Out (for optional Subwoofer Amplifier)
- Electronic Volume, Bass, Treble, Balance, Fader • 5 Selectable iEQ Curves - pop/jazz/classic/beat/rock
- Zero Memory Current Draw (will not drain car battery when unit not in use) • 24 Station pre-sets (18FM / 6AM)
- 10 Foot Cable from LCD Control Panel to Black Box (tuner/amp unit) • Power Antenna 12V Trigger Lead
- Blue LED Illumination on Buttons and LCD Display with Contrast Control
- LCD Flush Mount Trim Bezel Included • LCD Swivel Mount Bracket Included

SECRET-SST 1964-72 .....350.99 ea.



AAR-69-GM



AAR-70-SS



AAR-712CHVL



AAR-67CHVL



AAR-66CHVL

**Antique Auto Radios**

If you are looking for a radio that sounds great and looks just like your original. This Antique Auto Radio is perfect for you! Max power 180 watts, RMS 45W x 4 MOSFET on board power amplifier. Analog controls look and feel just like your original. AM dial scale in foreground looks original with a FM dial scale in background. All controls easily accessible. Volume, bass, treble, balance, fader and tuning from original looking controls. Digitally tuned AM/FM/Stereo front end provides stable, high quality reception. Shafts are the original size, for quick and accurate mounting just like your original. Also included are additional line outs and output options: 3 RCA jacks for left channel, right channel and sub-woofer, a 6 foot 3.5mm male-to-male auxiliary cable, 3.5 mm phone jack for input from iPod, satellite radio or MP3 player, switch selectable for 1,2,3 or 4 speakers, switch selectable for North America or Europe mode. Doesn't include a remote or a USB for a flashdrive or SD card port. All Antique Automobile Radios now feature built-in Bluetooth 3.0 EDR compliance; Place and answer calls or stream your favorite programs while maintaining the original appearance! Includes a built-in microphone for HFP (hands free profile calling). HSP, A2DP, AVRCP profiles are also supported.

AAR-66CHVL	1966 All .....	850.99 ea.
AAR-67CHVL	1967 All .....	850.99 ea.
AAR-69-GM	1969 All .....	850.99 ea.
AAR-70-SS	1970 SS All.....	850.99 ea.
AAR-70-GM	1970 Non-SS All.....	850.99 ea.
AAR-71-SS	1971-72 SS All .....	850.99 ea.
AAR-712CHVL	1971-72 Non-SS All .....	850.99 ea.



2008



1006



2002

**Dash Speakers**

Since at least 2 speakers are required for true stereo sound, these speakers are a perfect upgrade to OEM and do not require any modification to your dash. The 1000 series are held in place by the original screws and the 2000 series are held in place by the original bracket.

2007	1964-65 All .....	45.99 ea.
2008	1966-67 w/o AC .....	45.99 ea.
2009	1966-67 w/ AC .....	45.99 ea.
2001	1968-69 w/o AC .....	45.99 ea.
2002	1968-69 w/ AC .....	45.99 ea.
2011	1968-68 w/ AC .....	45.99 ea.
1006	1970-77 Mono .....	45.99 ea.



1013

**Factory Stereo Replacement Speakers**

These 3.5" 30 watt speakers are made specifically to replace the stock stereo dash speakers in your 1970-77 Chevelle.

1013	1970-77 All .....	45.99 pr.
------	-------------------	-----------



KPS-6872-300AC



KPS-647-80



KPS-647-300AC



**Ground Up Motor Sports's Premium Quality Kick Panel Speakers**

These Ground Up Motor Sports kick panel speakers offer great sound quality for your Chevelle or El Camino. These kick panels are as true to the originals as possible while offering a modern speaker in a convenient location. No cutting of the body required! Made of ABS textured plastic they can be painted to match any interior for a clean look. All speakers are 6.5" with either a 100 watt three way, or a 300 watt two way speaker driver.

KPS-647-80	1964-67 w/o AC 100 Watt 3 Way .....	159.99 pr.
KPS-647-300	1964-67 w/o AC 300 Watt 2 Way .....	199.99 pr.
KPS-647-80AC	1964-67 w/ AC 100 Watt 3 Way .....	169.99 pr.
KPS-647-300AC	1964-67 w/ AC 300 Watt 2 Way .....	199.99 pr.
KPS-6872-80	1968-72 w/o AC 100 Watt 3 Way .....	159.99 pr.
KPS-6872-300	1968-72 w/o AC 300 Watt 2 Way .....	199.99 pr.
KPS-6872-80AC	1968-72 w/ AC 100 Watt 3 Way .....	169.99 pr.
KPS-6872-300AC	1968-72 w/ AC 300 Watt 2 Way .....	199.99 pr.



KCHV-68-2

**Kick Panel Speakers**

Enhance your sound quality with these custom molded kick panel speakers from Custom Autosound. They are a direct bolt in!

KCHV-64-6	64-66 no AC 100 W.....	145.99 pr.
PKCHV-64	64-66 no AC 250 W.....	199.99 pr.
KCHV-64-6A	64-66 w/ AC 100 W.....	145.99 pr.
PKCHV-64A	64-66 w/ AC 250 W.....	199.99 pr.
KCHV-67	67 no AC 100 W.....	145.99 pr.
KCHV-67A	67 w/ AC 100 W.....	145.99 pr.
KCHV-68-2	68-72 no AC 100 W.....	145.99 pr.
PKCHV-68-2	68-72 no AC 250 W.....	199.99 pr.
KCHV-68-2A	68-72 w/ AC 100 W.....	145.99 pr.
PKCHV-68-2A	68-72 w/ AC 250 W.....	199.99 pr.



KNW-2001



KNW-2002



**Kenwood Upgraded Dash Speakers**

These Custom Autosound speakers feature Kenwood quality upgrade replacement speakers for your original front in-dash speakers. These great quality speakers can handle up to 60 watts and are built and designed to fit directly under the dash including all correct mounting brackets and wiring. Each assembly includes two speakers.

KNW-2007	1964-65 All .....	74.99 ea.
KNW-2008	1966-67 w/o AC .....	74.99 ea.
KNW-2009	1966-67 w/ AC .....	74.99 ea.
KNW-2001	1968-69 w/o AC .....	74.99 ea.
KNW-2002	1968-69 w/ AC .....	74.99 ea.
KNW-1006	1970-72 Mono .....	73.99 ea.



4007



4001



**Dual Voice Coil Speakers**

These DVC speakers will give you the best possible sound and power handling from your stock speaker locations. They give up to 70% more cone area than a conventional dual speaker setup with 140 watt max power capacity, left and right channel hook up and tweeters.

4007	1964-65 All .....	60.99 ea.
4008	1966-67 w/o AC .....	60.99 ea.
4009	1966-67 w/ AC .....	60.99 ea.
4001	1968-69 w/o AC .....	60.99 ea.
3006	1970-77 Mono .....	55.99 ea.





**The System by Custom Autosound**

The System solves the age old problem of where to put speakers in classics, customs and streetrods. The System allows you to keep the integrity of your vehicle intact yet enjoy quality sound like many of us have in our new cars. Satellite speakers look like AC vents and can be mounted under the dash, on the kickpanels or even the back package tray. The woofer is optionally mounted under the seat but can be mounted in the trunk if space requires it.



CAS-SYSTEM1

**System 1**

Flat active aluminum subwoofer enclosure with 3 channel amplifier. Two 3" mid-tweeter satellite speakers in die cast metal housings and 8" woofer. Wire remote for bass level. Amplifier installation kit included.

Amplifier power: 150 watt subwoofer / 2x50 watt mid/tweeter  
Dimensions: Amp / Sub: 2.8" x 13.5" x 9.8"  
Satellite: 3.2" x 3.75"

CAS-SYSTEM1 System 1 ..... 310.99 kit



BSD-CHL-682

**Backseat Driver**

Add some bottom end power to your system with our custom bass speaker panel. This panel comes equipped with two Custom Autosound 8" subwoofers and the Boss 500 watt amp. Panel mounts to the back of the rear seat from the trunk. All cables & wires needed are included for a quick and easy install!

BSD-CHL-682 1968-72 ..... 245.99 ea.



SPUV-693C



**Rear Speakers**

These rear speakers are a high performance replacement for your originals and includes grilles, wires and hardware.

SPUV-693C 6x9 3 way 200W ..... 100.99 pr.



UNDERCOVER1

**Undercover Speakers**

These compact speakers are specifically made for under seat installation and they pack a 120 watt punch! Each unit features a 5 1/2" woofer and piezo tweeter. 3" H X 8-1/4" W X 11-1/4" L.

UNDERCOVER1 1964-72 All ..... 135.99 pr.



UNDERCOVER2

**Undercover II Speakers**

Want a little more from your hidden speaker system? This is it! Each unit features an 8" woofer and 2 Piezo tweeters. With the 8" woofer in UNDERCOVERII you get a much fuller deeper sound with a 200 Watt capability! 11"W x 12.5"D x 3"H

UNDERCOVER2 1964-72 All ..... 175.99 pr.

BLUKIT



**Bluetooth Interface for USA-630, Secretaudio**

This adapter plugs into the CD changer port of your radio and gives you the ability to do hands free calling from your Bluetooth capable phone. You can listen to music stored on your A2DP enabled Bluetooth device. You can still use your CD changer with the adapter plugged in.

BLUKIT Bluetooth Interface ..... 105.99 ea.

Note: Works with Custom Autosound USA-630 and Secretaudio systems.

ANT-7088



**Antenna Lead Wire**

Correct lead that mounts to the top of the dash. The windshield antenna plugs into this and the lead goes to the radio.

ANT-7088 1970-77 All ..... 34.99 ea.

ANT-HIDE



**Hidden Antenna**

For the best AM/FM reception, nothing works better than this hidden amplified antenna! You can mount this anywhere and plug it into your new Custom Autosound stereo for the best reception quality!

ANT-HIDE 1964-72 All ..... 30.99 ea.



SPG-6480

SPG-70AN

SPG-7081

**Package Tray Speaker Grilles**

Often dealer installed and often broken or missing these OE correct speaker grilles are the perfect finishing touch to your restoration. The grille are designed to fit 6x9 speakers.

SPG-6480 1964-80 Square Sides ..... 44.99 ea.

SPG-70AN 1970 Fully Square ..... 92.99 ea.

SPG-7081 1971-77 Round Sides ..... 39.99 ea.

No volume discount.



**Convertible Top Boot**

This superior quality boot features the correct HEAVY weight vinyl and original style stitching construction. Just look how good it looks on our 1970 Chevelle convertible!

MTB-64	1964 w/o Clips.....	239.99 ea.
MTB-65	1965 w/o Clips.....	239.99 ea.
MTB-67	1966-67 w/ Clips.....	259.99 ea.
MTB-72	1968-72.....	229.99 ea.

MBC-67F



**Convertible Boot Clips**

Correct clips for attaching boot to molding.

MBC-64A	1964-65 Chevelle.....	29.95 set
MBC-67F	1966-67 Chevelle.....	44.99 kit

MTB-12538



**Top Boot Snap Screws**

Correct fine thread convertible top boot snap screws which are located on the rear interior quarter panels.

MTB-12538	1968-72 (4 pc.).....	8.99 kit
-----------	----------------------	----------

MTG-X3

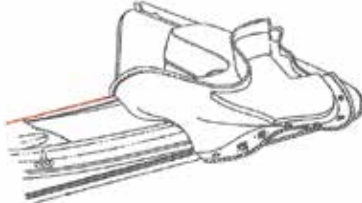

**Convertible Top Boot Slide Rail**

This often broken or missing metal guide or "slide rail" strip is used for retaining the front of your top boot to the backside of your rear seat.

MTG-X3	1964-72 Chevelle.....	82.99 ea.
--------	-----------------------	-----------

MTP-44



**Convertible Top Pads**

High quality reinforcement pads which fit between the frame rails and top.

MTP-44	1964-72 Chevelle.....	60.99 pr.
--------	-----------------------	-----------

RAL-15212



**1965-67 Chevelle**

**Convertible Rear Arm Rest Light Lens**

Used only on 65-67 Chevelle convertibles equipped with the convertible light package, these rear arm rest light lenses are reproductions, down to the off white coloring.

RAL-15212	1965-67 CVT.....	11.99 pr.
-----------	------------------	-----------



**Convertible Tops**

OE style reproduction convertible tops with correct grain and weight as well as seam treatment just like factory. Available with plastic window or glass window for 1968-72 Chevelle.

MP-V1B	1964-65 Plastic Black.....	417.99 ea.
MP-V1W	1964-65 Plastic White.....	417.99 ea.
MP-V2B	1966-67 Plastic Black.....	417.99 ea.
MP-V2W	1966-67 Plastic White.....	417.99 ea.
MP-V3B	1968-72 Plastic Black.....	378.99 ea.
MP-V3W	1968-72 Plastic White.....	378.99 ea.
MP-786B	1968-72 Glass Black.....	474.99 ea.
MP-789W	1968-72 Glass White.....	474.99 ea.

No Volume Discount. Ships Oversize. Not eligible for free shipping.

MHB-645



**Header Bow**

OE style reproduction of the often damaged or rusted header bow which attaches to the top of the frame rails.

MHB-645	1964-65.....	369.99 ea.
MHB-667	1966-67.....	369.99 ea.
MHB-682	1968-72.....	399.99 ea.

Ships Oversize. Not eligible for free shipping.

MHM-682



**Vinyl Header Cover**

Correct vinyl material to cover the header on your 1968-72 Chevelle convertible.



MHM-682	1968-72.....	16.99 ea.
---------	--------------	-----------

Please state color.



MCT-1

**Header Bow End Clip**

Correct header bow for outside of convertible top.

MCT-1	1964-72.....	5.99 pr.
-------	--------------	----------



KEC-667

**Convertible End Caps**

Polished stainless steel end caps.

KEC-667	1966-67.....	94.99 pr.
---------	--------------	-----------



MCT-1417Y

**Convertible Top Frame Assembly**

Fully assembled. The perfect replacement for your rusted out or bent original!

MCT-1417Y	1968-72 All Abody.....	1199.99 ea.
-----------	------------------------	-------------

For power top only.

This item ships Truck Freight to a Commercial Address.



BRR-1VA



BRR-1VA-B

**Convertible Top Weatherstrip Hold Down Screw Kits**

These are the correct screws used to hold the weatherstrip seals to the top frame on convertibles. Please compare to your originals to make sure the colors match before ordering.

BRR-1VA-B	1968-72 Black Set.....	11.99 kit
BRR-1VA	1968-72 Silver Set.....	12.99 kit



JS-5500



JS-5505

**Top Frame to Body Seal**

These hard to find seals mount to the body where the top frame enters.

JS-5500	1964-67.....	39.99 pr.
JS-5505	1968-72.....	69.99 pr.



JSS-5092

### Convertible Top Weatherstrip Kit

New state of the art Metro convertible top weatherstrip kit featuring steel frames with molded rubber, correct seams and extension flaps. Header seal has correct pins and molded corners. Made in USA.

JSS-5090-US	1964-65	309.99 kit
JSS-5092	1966-67	299.99 kit
JSS-5093	1968-72	314.99 kit



### Convertible Tack Strip

This is a reproduction of the tack strip used to secure the convertible top to the rear trunk well.

MTSB-64A	1964-65	159.99 ea.
----------	---------	------------



MTL-66AR

### Convertible Top Latches

MTL-64AL	1964-65 LH	111.99 ea.
MTL-64AR	1964-65 RH	111.99 ea.
MTL-66AL	1966-67 LH	111.99 ea.
MTL-66AR	1966-67 RH	111.99 ea.
MTL-68AL	1968-72 LH	111.99 ea.
MTL-68AR	1968-72 RH	111.99 ea.



MHL-701K

### Convertible Top Hook Kit

Correct convertible top hooks and correct style latches.

MHL-701K	1964-72	39.99 kit
----------	---------	-----------



### Convertible Well Liner

Correct black vinyl material for "top down" well area.

MWL-64	1964-65 Chevelle	89.99 ea.
MWL-66	1966-67 Chevelle	89.99 ea.
MWL-70	1968-72 Chevelle	89.99 ea.



KEC-645K



ISS-4104

### Sunvisor Brackets

OE style reproduction sunvisor brackets for your convertible.

KEC-645K	1964-65 Convertible	129.99 pr.
KEC-66K	1966-67 Convertible	124.99 pr.
ISS-4104	1968-72 Convertible	77.99 pr.



LWM-840

### Convertible Well Molding

OE style reproduction rear body pinch weld moldings in polished stainless steel as original.

LWM-838	1964-65	199.99 set
LWM-839	1966-67	189.99 set
LWM-840	1968-72	189.99 set

No Volume Discount. Ships Oversize. Not eligible for free shipping.



LMC-3645

### Convertible Well Molding Clips

Complete set of correct well molding clips

LMC-3645	1966-67	39.99 set
LMC-3640	1968-72	39.99 set



KEC-70K

### End Knuckles

Correct die cast convertible top end knuckles which attach to the ends of the windshield header and secure the top hooks in place.

KEC-70K	1968-72 All	74.99 pr.
---------	-------------	-----------



MRG-117

### Well Rain Gutter

Correct plastic gutter that prevents water from entering car.

MRG-117	1968-72	239.99 ea.
MRG-12519	Chrome Screws	6.99 kit
MRG-12520	Black Screws	4.99 kit



MAP-64A



MAP-GUIDE-66

### Convertible Top Alignment Pin

Correct chrome alignment pin that mounts to the header bow to guide it in place to the windshield frame.

MAP-64A	1968-72 Conv. Alignment Pin	14.99 ea.
MAP-GUIDE-66	1966-67 Alignment Pin Guide	21.99 pr.



GW-458



GT-159

**1964-68 Top Switch**

Correct switch and housing for operation of power top.

GT-159	1964-68 Switch.....	34.99 ea.
GW-458	1964-68 Bracket w/ Clips.....	18.99 ea.



GT-69



MTB-17

**1969 Switch & Bezel**

Correct switch and die cast bezel.

GT-69	1969 Switch.....	59.95 ea.
MTB-17	1969 Bezel.....	49.99 ea.
GW-082	1969 Bracket w/ Clips.....	18.99 ea.



GT-159



MTB-702

**1970-72 Switch & Bezel**

Correct switch and die cast bezel.

GT-159	1970-72 Switch.....	34.99 ea.
MTB-702	1970-72 Bezel.....	36.99 ea.
GW-458	1970-72 Bracket w/ Clips.....	18.99 ea.

GRW-016

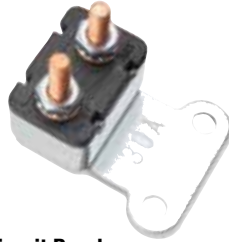

**Power Top Circuit Breaker**

Original Style GM breaker.

GRW-016	1964-72.....	18.99 ea.
---------	--------------	-----------



MTC-7

**Convertible Top Cables**

Correct top torsion cables in matched pairs.

MTC-4	1964-65 Chevelle.....	49.95 pr.
MTC-7	1966-67 Chevelle.....	44.99 pr.
MTC-68	1968-72 Chevelle.....	44.99 pr.



KDW-4578



KDW-68A

**Convertible Wedge Kit**

This kit includes shims for doors, brass and teflon wedges and all mounting hardware.

KDW-4578	1964-67.....	59.99 set
KDW-68A	1968-72.....	35.99 set



MTC-12A

**Convertible Top Cylinder**

This is a correct replacement convertible top cylinder made in the USA featuring all metal construction with hard chrome finished rods. This top cylinder comes with a 5 year warranty when used with automatic transmission fluid or a 3 year warranty when used with standard DOT 3 brake fluid.

MTC-12A	1964-67.....	139.99 ea.
MTC-12KA	1964-67 LH/RH.....	251.98 kit
MTC-12B	1968-72.....	129.99 ea.
MTC-12KB	1968-72 LH/RH.....	233.98 kit

No Volume Discount.

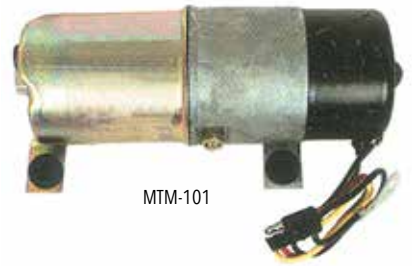

MTM-101



MMB-3

**Convertible Top Motors**

New OEM motors.

MTM-101	1964-72 3 Hole.....	325.99 ea.
MTM-104	1964-72 4 Hole.....	325.99 ea.
MMB-3	Bushing.....	5.95 ea.

No Volume Discount.



INL-15190

**Top Cylinder to Frame Hardware**

This is a set of the correct bolts, washers and nuts to connect the convertible top cylinder to the top frame.

INL-15190	1968-72.....	25.99 ea.
-----------	--------------	-----------



MTH-15K

**Convertible Top Hose**

Correct white hose with original brass fittings. Sold in matched pairs.

MTH-15K	1964-67.....	89.95 pr.
MTH-25K	1968-72.....	89.95 pr.
MTH-CLIP	1964-72 Hose Clip.....	8.99 ea.

No Volume Discount.



### Trunk Mats

These new die stamped heavy duty final trunk mats are the perfect finishing touch to your trunk! Constructed of heavy duty vinyl, this mat will last for years to come!

PEM-2221	1964-65 Gray Crowsfoot.....	52.99 ea.
PEM-2222	1966 Gray Crowsfoot .....	52.99 ea.
PEM-333	1966-67 Gray Houndstooth.....	56.99 ea.
PEM-322	1966-67 Aqua Houndstooth.....	52.99 ea.
PEM-422	1968-69 Aqua Herringbone .....	52.99 ea.
PEM-522	1970 Aqua Herringbone.....	52.99 ea.
PEM-622	1971-72 Aqua Herringbone .....	52.99 ea.



Aqua Herringbone



Gray Houndstooth



PEM-161A

### Spare Tire Cover

These spare tire covers are constructed of the same durable material as our trunk mats, so they make an excellent finishing touch!

PEM-164A	1964-66 Gray Crowsfoot 14" .....	69.99 ea.
PEM-167	1966-67 Gray Houndstooth 14" .....	69.99 ea.
PEM-168	1966-67 Gray Houndstooth 15" .....	69.99 ea.
PEM-161A	1967 Aqua Houndstooth 14" .....	64.99 ea.
PEM-162	1967 Aqua Houndstooth 15" .....	69.99 ea.
PEM-163A	1968-72 Herringbone 14" .....	69.99 ea.
PEM-163B	1968-72 Herringbone 15" .....	69.99 ea.



Gray Crowsfoot



Gray Houndstooth

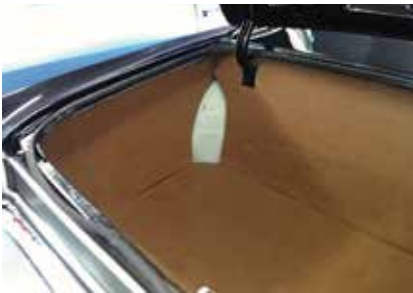

CTPM-517-5

### Custom Trunk Panel Kit

This pre-cut custom trunk panel set makes it easy to clean up your trunk. Each kit includes pre-cut hardboard panels to cover the floor, trunk divider area and the sides of the trunk, saving you or your upholstery shop hours over hand trimming your own custom panels. Add your choice of finishing material such as carpet (not included) and you will have a clean and modern looking trunk to set your muscle car apart from the crowd!

CTPM-515-5	1964-65 .....	213.99 kit
CTPM-516-5	1966-67 .....	213.99 kit
CTPM-517-5	1968-69 .....	213.99 kit
CTPM-518-5	1970-72 .....	213.99 kit

Note: Based on your particular car, you may find it necessary to custom trim here and there depending upon the type of material you choose to cover the panels with. Finishing material is not included. This kit includes the hardboard panels only. Ships Oversize. Not eligible for free shipping.

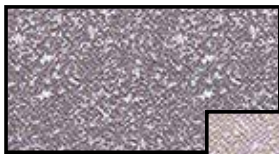

### Trunk Spatter Paint

Correct OEM aerosol spray to detail your trunk floor.

DUP-DM109	Aqua/Black .....	11.99 ea.
DUP-DM100	Gray/White .....	11.99 ea.
DUP-DM102	Black/Gray .....	11.99 ea.
DUP-DAL1695	Clear Coat.....	9.99 ea.
HDP-64-GW	AC Delco Gray/White .....	19.99 ea.
HDP-68-BA	AC Delco Black/Aqua .....	19.99 ea.

Clear coat must be used to seal paint!

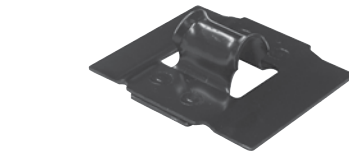

P-2000



P-2100

P-2200

### Spare Tire Anchor Plates

Correct spare tire hold down and jack floor brackets.

P-2000	1964-72 Anchor Plate .....	11.99 ea.
P-2100	1964-67 Jack Bracket.....	9.95 ea.
P-2200	1968-72 Jack Bracket.....	11.99 ea.



RDP-100

### Trunk Floor Drain Plug

Correct stamped plug for trunk floor.

RDP-100	1964-72 All .....	3.95 ea.
---------	-------------------	----------



PLW-KIT

### Lug Nut Wrench & Sleeve

Correct GM Style lug wrench and rubber sleeve for retaining it to the jack.

PLW-3	1964-72 Wrench.....	19.99 ea.
PLS	1964-72 Sleeve.....	11.99 ea.
BHE-1970	1964-72 Spare Tire Hold Down.....	14.99 set
PLW-KIT	1964-72 Sleeve, Wrench, Hold Down.....	42.27 kit



MBJ-68A

**BUY'N SAVE**  
WITH KITS

### Bumper Jacks

OE style reproduction of this often damaged or missing jack. This kit comes complete with jack, base and load base for bumper.

MBJ-67A	1967 Chevelle.....	213.98 kit
MBJ-68A	1968 Chevelle.....	213.98 kit
MBJ-69A	1969 Chevelle.....	213.98 kit
MBJ-70A	1970 Chevelle.....	213.98 kit
MBJ-71A	1971-72 Chevelle .....	213.98 kit

\*These jacks are for display purposes only and are not intended for use.



PLB-68A



PLB-70A

### Chevelle Jack Load Base

Correct cradle for lifting car which inserts into bumper jack.

PLB-67A	1967.....	33.99 ea.
PLB-68A	1968.....	39.99 ea.
PLB-69A	1969.....	26.95 ea.
PLB-70A	1970.....	39.99 ea.
PLB-71A	1971-72 .....	39.99 ea.



NRK-146



**BUY'N SAVE WITH KITS**



NJ-150K Detail



NJ-152K Detail

**Complete Rally Wheel Kits**

Why sift through the junkyard for a used set of wheels or try to repair your originals? Ground Up Motor Sports offers complete wheel kits including a complete set of rims, caps, trim rings and a set of lug nuts! These kits include everything you need to get your muscle car rolling in style.

**With Chevrolet Motor Division Flat Caps**

NRK-146	14 x 6.....	584.62 kit
NRK-146DB	14 x 6 w/ Factory Disc.....	584.62 kit
NRK-147	14 x 7.....	602.59 kit
NRK-157	15 x 7.....	606.37 kit
NRK-158	15 x 8.....	674.77 kit

NRK-247	14 x 7.....	602.59 kit
NRK-257	15 x 7.....	606.37 kit
NRK-258	15 x 8.....	674.77 kit

**With Turbine Style Raised Caps (1968+ Style)**

NRK-346	14 x 6.....	885.20 kit
NRK-346DB	14 x 6 w/ Factory Disc.....	885.20 kit
NRK-347	14 x 7.....	903.16 kit
NRK-357	15 x 7.....	906.94 kit
NRK-358	15 x 8.....	975.34 kit

**With Chevrolet Disc Brakes Flat Caps**

NRK-246	14 x 6.....	584.62 kit
NRK-246DB	14 x 6 w/ Factory Disc.....	584.62 kit



**BUY'N SAVE WITH KITS**

NVV-70K

**Complete Super Sport Wheels Kits**

This kit includes a complete set of SS rims, center caps with retainers, trim rings and a set of lug nuts to get your Super Sport rolling!

NVV-70K	14 x 7.....	1297.17 kit
NVV-71K15	15 x 7.....	925.17 kit

No Volume Discount. All wheel kits ship in multiple Oversize Boxes. Not eligible for free shipping.



**BUY'N SAVE WITH KITS**

NVW-4837-MAG-KIT4

**Retro Magnum Alloy SS Wheels**

Constructed of aluminum these brand new retro 15 x 7 Super Sport wheels will give your muscle car a more modern look while keeping the old school styling! These awesome new wheels are black powder coated on the inside and feature machined lips. Accepts original style lug nuts.

NVW-4837-MAG-KIT4	15 x 7 Kit.....	715.84 kit
NVW-4837-MAG	15 x 7, Spare.....	169.99 ea.

Ships Oversize. Not eligible for free shipping. No Volume Discount. 17 inch rims come with a blank center cap.

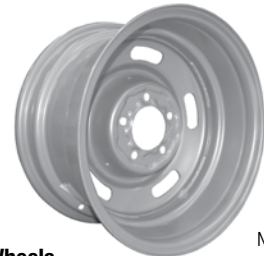

NCE-8984

**Rally Wheels**

Our rally wheels come correctly powder coated in Argent Silver assuring you not only a great appearance but quality as well.

NCE-8984	14 x 6, 4" Backspace.....	99.95 ea.
NCE-8985	14 x 6 Disc, 4" Backspace*.....	99.95 ea.
NCE-0530	14 x 7, 4-1/4" Backspace.....	99.95 ea.
NCE-0535	15 x 7, 4-1/4" Backspace.....	105.99 ea.
NCE-0540	15 x 8, 4-1/2" Backspace.....	109.99 ea.

\*Fits factory disc brakes only. Ships Oversize.



NCE-0530C

**Chrome Rally Wheels**

This reproduction Rally Wheel comes in high quality chrome plated steel for a custom look. This wheel is ready to install right out of the box.

NCE-8984C	14x6, 4" Backspace.....	149.95 ea.
NCE-0530C	14x7, 4-1/8" Backspace.....	149.95 ea.
NCE-0535C	15x7, 4-1/4" Backspace.....	139.95 ea.
NCE-0540C	15x8, 4-1/2" Backspace.....	129.95 ea.

Fits cars with 5 lug axles. These wheels do not include center caps or lug nuts. Ships Oversize.



NVW-4832

**Super Sport Wheels**

Reproduction SS wheel which comes correctly painted and ready to install.

- NVW-4832 14 x 7, 4-1/2" Backspace.....257.99 ea.
  - NVW-4837 15 x 7, 4-1/2" Backspace.....159.99 ea.
  - NVW-4838 15 x 8, 4-1/2" Backspace.....169.99 ea.
- Ships Oversize.*



NVW-4831C

**Chrome Super Sport Wheels**

This reproduction Chevelle Super Sport Wheel is made in the USA and comes in high quality chrome plated steel for a custom look. This Chevelle wheel is ready to install right out of the box.

- NVW-4831C 14 x 6, 4" Backspace .....184.95 ea.
- NVW-4832C 14 x 7, 4-1/2" Backspace .....149.99 ea.
- NVW-4837C 15 x 7, 4-1/4" Backspace.....179.99 ea.
- NVW-4838C 15 x 8, 4-1/2" Backspace.....189.99 ea.

*These wheels do not include center caps or lug nuts. Ships Oversize.*



NSW-146

**MIX & MATCH SPECIAL!**  
**BUY ANY 4 RIMS SAVE 15%**

**Steel COPO Wheels**

This is a brand new factory style steel Chevelle wheel which was usually standard equipment on six cylinder cars, Special High Performance Cars and COPO cars. These steel wheels were usually discarded over the years in favor of rally wheels or super sport wheels and are tough to find. This rim is perfect for your bone stock restoration, COPO recreation or sleeper.

- NSW-146 14 x 6, 4-1/2" Backspace.....124.99 ea.
  - NSW-147 14 x 7, 4-3/4" Backspace.....124.99 ea.
  - NSW-157 15 x 7, 4-3/4" Backspace.....124.99 ea.
- Only fits 1964-72 Chevelle. *Ships Oversize.*



NW1785SLV

**17 Inch N90 Wheels**

Add a modern stance to your muscle car while keeping with its classic styling! This is a 17 inch version of the N90 wheel that originally came on 1980-1981 Z/28 and 1986-1988 Monte Carlo models. Accepts original style center caps and lug nuts.

- NW1784SLV 17 x 8, 4-1/4" B/S.....257.99 ea.
- NW1785SLV 17 x 8, 5" B/S.....254.99 ea.



CMW178BLK

**17 Inch SS Mag Wheels**

Add a modern stance to your muscle car while keeping with its classic styling! This is a 17 inch version of the Super Sport Wheel that originally came on various GM models. Accepts original style center caps and lug nuts.

- CMW178BLK 17 x 8, 4-1/2" B/S.....257.99 ea.
- CMW179BLK 17 x 9, 5-1/2" B/S.....257.99 ea.
- MWR2 Center Cap Retainers.....29.99 set
- C5782 Screws (10pc.).....4.99 kit

*Note: If using your existing center caps you will need to use MWR2 center cap retainers and C5782 screws to fit these retainers.*



ZW1784GUN

**17 Inch 5 Spoke Rally Wheels**

Add a modern stance to your muscle car while keeping with its classic styling! This is a 17 inch version of the 5 spoke Z/28 wheel that originally came on 1970-1981 Camaro and 1971-1972 Chevelle models. Accepts original style center caps and lug nuts.

- ZW1784GUN 17 x 8, Gunmetal, 4-1/4" B/S .....257.99 ea.
- ZW179GUN 17 x 9, Gunmetal, 5" B/S.....257.99 ea.



NZW-157

**1971-74 5 Spoke SS Wheel**

Reproduction 5 spoke steel wheel which was originally installed on 1970-1981 GM performance models.

- NZW-157 15 x 7 .....299.99 ea.
- Ships Oversize.*



HMK-6970

**SS Wheel Restoration Supplies**

Ground Up Motor Sports offers everything you need to restore your original Super Sport Wheels. Order our 4 piece paint mask kit along with Argent Silver and SS Insert gray paint for a complete job.

- HMK-6970 Paint Mask.....27.95 kit
- DUP-HWP101 Argent Silver Paint (11oz. can).....10.99 ea.
- HDP-1214 Insert Gray Paint (11oz. can).....13.99 ea.



NWB-781

**1978-81 Rally Wheel Bezel**

This is the correct chrome bezel that inserts into the slots on your ZJ7 6 slot rally wheels.

- NWB-781 1978-81 w/ Rally Wheel.....12.99 ea.
- 6 required per wheel.*



NJT-665

NJT-716

NJT-135

**Lug Nuts**

Correct style lug nuts for your wheels.

- NJT-716 Acorn 7/16 .....0.99 ea.
- NJT-665 Stainless SS.....2.49 ea.
- NJT-665KIT SS 20pc.....44.82 kit
- NJT-135 All\* w/ Aluminum Rims .....3.99 ea.

*\*Factory GM Rims 1976-85*



# HK WHEELS

### HK Magnum Wheels

HK Magnum wheels offer classic good looks in a larger, more modern 17 inch diameter. HK Magnum wheels are manufactured in cast aluminum with black powder coated inserts and deep diamond machined lip clear powder coated for durability and low maintenance. HK Magnum wheels include a chromed lightweight polymer cone style center with HK Wheels decal with a style that complements the classic looks of the wheel.

BS = Back Spacing.

HK-MW1775475	17x7 4.25" BS	215.99 ea.
HK-MW1785475	17x9 4.25" BS	226.99 ea.
HK-MW1795475	17x9 5" BS	238.99 ea.

No Volume Discount.



### Factory Style Tires

If authenticity is your goal, then look no further. All of our tires feature the same tread patterns and raised white lettering as the originals.

#### Goodyear Polyglas

GE-7014	E70 x 14	347.99 ea.
GF-7014	F70 x 14	371.99 ea.
GF-7114	F70 x 14*	388.99 ea.
GF-6015	F60 x 15	435.99 ea.
GG-7014	G70 x 15	412.99 ea.
GG-6015	G60 x 15	488.99 ea.

\*1969 - early 1970 w/o tire size in RWL

No Volume Discount. Ships Oversize. Not eligible for free shipping.

#### Firestone Wide Oval

FE-7014	E70 x 14	327.99 ea.
FF-7014	F70 x 14	338.99 ea.
FG-7014	G70 x 14	366.99 ea.
FF-7015	F70 x 15	368.99 ea.
FG-7015	G70 x 15	383.99 ea.
FF-6015	F60 x 15	422.99 ea.

#### Firestone Redline

RF-7014	F70 x 14	337.99 ea.
RG-7014	G70 x 14	366.99 ea.
RF-7015	F70 x 15	381.99 ea.
RG-7015	G70 x 15	532.99 ea.



ER-7014RL

ER-7014RW

### Factory Style Radial Tires

If you're going for an authentic Chevrolet restoration, be sure that you don't overlook the tires! Previously, this meant sacrificing modern ride quality and handling characteristics for an authentic appearance, but now you can have the best of both worlds with these modern radial tires that have a period correct appearance. This factory style Firestone Wide Oval tire is an almost exact replica of the original, engineered from the ground up to provide excellent ride quality, tread life and safety, while retaining the correct tread pattern and raised white lettering.

#### Firestone Wide Oval

ER-7014RW	ER70-14	236.95 ea.
FR-7014RW	FR70-14	350.99 ea.
GR-7014RW	GR70-14	374.99 ea.
FR-7015RW	FR70-15	393.99 ea.
FR-6015RW	FR60-15	472.99 ea.
GR-7015RW	GR70-15	416.99 ea.

#### Firestone Redline

ER-7014RL	ER70-14	236.95 ea.
FR-7014RL	FR70-14	350.99 ea.
GR-7014RL	GR70-14	374.99 ea.
FR-7015RL	FR70-15	393.99 ea.
GR-7015RL	GR70-15	416.99 ea.

### American Racing Wheel Kits

American Racing is the brand that started it all with their revolutionary Torq Thrust wheels. For the first time Ground Up Motor Sports\* is offering these wheels. BS = BACKSPACE



ARKIT-TT2G-147



ARKIT-TTMMG-177

## American Racing

CUSTOM WHEELS

#### Classic Torq Thrust II One Piece Mag Gray Machined Lip

ARKIT-TT2G-146	14x6 3.42"BS	499.96 kit
ARKIT-TT2G-147	14x7 4.0"BS	511.96 kit
ARKIT-TT2G-157	15x7 3.76"BS	555.96 kit
ARKIT-TT2G-158	15x8 4.5"BS	627.96 kit
ARKIT-TT2G-1578	15x7 Front 15x8 Rear	591.96 kit

#### Torq Thrust II One Piece Chrome

ARKIT-TT2C-147	14x7 4.0"BS	987.96 kit
ARKIT-TT2C-157	15x7 3.76"BS	1055.96 kit
ARKIT-TT2C-158	15x8 4.5"BS	1083.96 kit
ARKIT-TT2C-1578	15x7 Front 15x8 Rear	1069.96 kit
ARKIT-TT2C-177	17x7 4.0"BS	1279.96 kit
ARKIT-TT2C-178	17x8 4.81"BS	1299.96 kit
ARKIT-TT2C-1778	17x7 Front 17x8 Rear	1289.96 kit

#### Torq Thrust II One Piece PVD Chrome

ARKIT-TT2CPVD-157	15x7 3.76"BS	791.96 kit
ARKIT-TT2CPVD-158	15x8 4.5"BS	727.96 kit
ARKIT-TT2CPVD-1578	15x7 Front 15x8 Rear	759.96 kit
ARKIT-TT2CPVD-177	17x7 4.0"BS	883.96 kit
ARKIT-TT2CPVD-178	17x8 4.81"BS	983.96 kit
ARKIT-TT2CPVD-1778	17x7 Front 17x8 Rear	933.96 kit

#### Torq Thrust II One Piece Polished

ARKIT-TT2POL-157	15x7 3.76"BS	695.96 kit
ARKIT-TT2POL-158	15x8 4.5"BS	703.96 kit
ARKIT-TT2POL-1578	15x7 Front 15x8 Rear	699.96 kit
ARKIT-TT2POL-177	17x7 4.0"BS	1307.96 kit

#### Torq Thrust D Chrome

ARKIT-TTDC-157	15x7 3.76"BS	1011.96 kit
ARKIT-TTDC-158	15x8 4.5"BS	1051.96 kit
ARKIT-TTDC-1578	15x7 Front 15x8 Rear	1031.96 kit

#### Torq Thrust D Black w/ Machined Lip

ARKIT-TTDB-157	15x7 3.76"BS	731.96 kit
ARKIT-TTDB-158	15x8 4.5"BS	787.96 kit
ARKIT-TTDB-1578	15x7 Front 15x8 Rear	759.96 kit

#### Torq Thrust M Anthracite w/ Machined Lip

ARKIT-TTMMG-177	17x7 4.0"BS	811.96 kit
ARKIT-TTMMG-178	17x8 4.5"BS	903.96 kit
ARKIT-TTMMG-1778	17x7 Front 17x8 Rear	857.96 kit





### Trim Ring Sets

OE style reproduction trim ring kits at an affordable price.

NTR-146	14 x 6 Rally .....	99.99 kit
NTR-147	14 x 7 Rally .....	119.95 kit
NTR-157	15 x 7 Rally .....	99.99 kit
NTR-157-B	15 x 7 Rally w/ Bowtie.....	119.99 kit
NTR-158	15 x 8 Rally .....	99.99 kit
NTR-158-B	15 x 8 Rally w/ Bowtie.....	115.99 kit

### SS Trim Ring Sets

OE style reproduction trim rings packaged in convenient sets for your Super Sport.

NTW-1090	1969 14 x 7.....	99.99 kit
NTW-1095	1969 15 x 7.....	119.99 kit
NTR-70Z	1971-72 15 x 7* .....	159.99 kit

\*Gray 5 Spoke Style.



NJT-671K

### Center Cap Kit

This complete set includes (4) nice reproduction center caps with retainers (where applicable) for your SS wheels.

NJT-671K	1969-70 (8 pc.).....	103.88 kit
NJT-63K	1971-72 (4 pc.).....	82.76 kit



NJT-YENKO

### Yenko Center Cap Kit SS Wheels

This is a complete Yenko tribute wheel center cap kit which includes (4) reproduction SS center caps with Yenko decals and (4) retainers. These caps fit 1969-1972 Super Sport and Olds SS1 wheels.

NJT-YENKO	1969-72 Complete.....	139.95 kit
-----------	-----------------------	------------



NSS-70K

### OEM Style SS Center Cap Kit

These center caps are reserved for the true purist because they feature a deep indented SS center cap like factory OEM. These metal caps are made of high-quality cast aluminum just like they came from the factory! These caps are a little pricier but are clearly the obvious choice when going for a totally stock restoration.

NSS-70K	1969-70 Complete.....	99.95 kit
---------	-----------------------	-----------

### Super Sport Center Caps

OE style reproduction retainers and caps to freshen up your Super Sport wheels.



NCX-396 NCE-6770 NCX-454

NCX-396	SS396 Cap.....	19.99 ea.
NCX-454	SS454 Cap .....	19.99 ea.
NCE-6770	SS Cap .....	19.99 ea.



NCD-396 NCE-700 NCD-454

NCD-396	SS396 Decal Only .....	7.99 ea.
NCD-454	SS454 Decal Only .....	7.99 ea.
NCE-700	SS Decal Only.....	5.99 ea.



NCE-671

NCE-671	SS Cap Retainer.....	7.99 ea.
---------	----------------------	----------



NDD-210 NDD-220 NDD-230

### Dog Dish Hubcaps

These are reproduction hub cap sets that were commonly found on many high performance cars. They feature excellent stamping, paint and chrome which ensures not only aggressive looks, but excellent quality. (We have installed these on our own 1969 L89 Camaro.)

NDD-210	1966 Chevrolet .....	389.99 kit
NDD-220	1967 Chevrolet .....	389.99 kit
NDD-230	1968-70 Chevrolet.....	398.99 kit

\*These will only fit stock steel wheels. They will not fit Rally Wheels or SS Wheels.

### Super Sport Center Caps

OE style reproduction retainers and caps to freshen up your Super Sport Wheels.



NCE-9479

NCE-9479	1971-72 SS .....	22.99 ea.
----------	------------------	-----------



NYC-105

### 1967-68 Yenko Rally II Wheel Cap

OE style reproduction chrome wheel center cap for use with Yenko models equipped with Pontiac Rally II wheels.

NYC-105	1967-68 .....	39.99 ea.
---------	---------------	-----------



NCD-106

### 1969 Yenko Wheel Ornament Decal

Correct pressure sensitive decal for use on 1969 Yenko models equipped with Torque Thrust wheels.

NCD-106	1969 Yenko .....	12.99 ea.
---------	------------------	-----------



NJ-151K

### Rally Wheel Cap Kits

Ground Up Motor Sports offers complete rally wheel center cap kits which include the center caps, bases, and hardware for all 4 wheels. Chrome plated metal center cap with a polished stainless steel base.

NJ-150K	Chevrolet Motor Division .....	129.99 kit
NJ-151K	Chevrolet Disc Brakes.....	129.99 kit
NJ-152K	Motor Division Raised .....	417.56 kit



NJ-1530

### Rally Wheel Center Cap

Correct turbine style raised style center cap with "Chevrolet Motor Division".

NJ-1530	Motor Division Cap 1968+ .....	115.99 ea.
---------	--------------------------------	------------

# BEST SELLER! \$SAVE BIG!

## Front Power Disc Brake Conversion Kits

Upgrade your GM-A body today with the most complete front disc brake kit on the market. Includes all OEM parts and is available with multiple upgrades. Increase stopping power and give your car that factory stock disc brake appearance. Works with 15" wheels or larger. Includes;

- 11" Rotors
- Forged Spindles
- Bearings & Seals
- Loaded Calipers
- Caliper Brackets
- Backing Plates
- Flex Hoses & Clips
- Master Cylinder
- Power Booster (9" or 11" Gold)
- Combination Valve & Bracket
- All Hardware

FM-1790AS	1964-72 GM-A body with 11" Booster .....	752.14 kit
FM-1790AS9	1964-72 GM-A body with 9" Booster.....	752.14 kit
FM-1790DSA	1964-72 GM-A body	
	2" Drop Spindle-11" Booster .....	872.80 kit
FM-1790DSA9	1964-72 GM-A body	
	2" Drop Spindle-9" Booster .....	866.81 kit



# SHOW N'GO UPGRADE

This package adds drilled and slotted rotors and red or black powder coated calipers.

FM-1790AS-UP-S	D/B Kit with Show N Go Black.....	733.20 kit
FM-1790AS-UP-Z	D/B Kit with Show N Go Red .....	733.20 kit
FM-1790DSS	2" Drop Kit-11" w/ Show N Go Black.....	941.99 kit
FM-1790DSZ	2" Drop Kit-11" w/ Show N Go Red.....	941.99 kit

1973-77 Front disc upgrade to drilled and slotted rotors with powder coated calipers.

This kit contains the rotors and calipers only.		
AFXWK70DS	1973-77 Black Calipers .....	839.99 kit
AFXWK70DZ	1973-77 Red Calipers.....	839.99 kit



# BEST OF SHOW UPGRADE

Adds drilled & slotted rotors, 8" chrome master, booster, pro-valve assembly and powder coated calipers.

FM-1790AS-UP-SX	D/B Kit with Best of Show Black.....	855.21 kit
FM-1790AS-UP-ZX	D/B Kit with Best of Show Red .....	855.21 kit
FM-1790DSX	2" Drop Kit- w/ Best of Show Black .....	987.99 kit
FM-1790DZX	2" Drop Kit- w/ Best of Show Red.....	987.99 kit

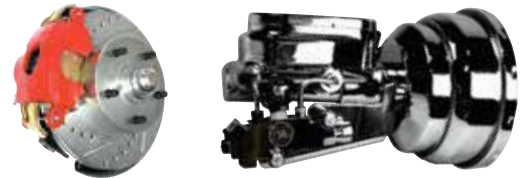

# SHOW STOPPER UPGRADE

Adds drilled & slotted rotors and a chrome master, booster, pro-valve assembly

FM-1790AS-UP-X	D/B Kit with Show Stopper Chrome.....	847.15 kit
----------------	---------------------------------------	------------



## KEEP YOUR FACTORY 14" WHEELS – POWER FRONT DISC BRAKE KITS

Half the install time & no alignment needed- Bolts directly to stock drum spindles, fits any 14" wheel, uses a proprietary rotor. Includes booster, master, combo valve, rotors, calipers, brackets and hardware.

AFXDC14-11	1964-72 Chevelle 11" Power Booster .....	706.99 kit
AFXDC14-9	1964-72 Chevelle 9" Power Booster .....	706.99 kit
AFXDC14-A	1964-72 Chevelle 9" Booster D/S Rotors .....	769.99 kit
AFXDC14-C	1964-72 Chevelle 8" Chrome Booster .....	645.99 kit



## DISC BRAKE CONVERSION LINE KITS – NO BRAINER

Simplify your installation with all the brake lines and clips you will need. Includes: • Front line kit • Front to Rear line • Rear axle line set • Rear flex hose • Clip set

		Original	Stainless
C64DCKIT_ *_*_	1964-67 Chevelle Hardtop .....	117.99 kit.....	177.99 kit
C64VDCKIT_ *_*_	1964-67 Chevelle Convertible/El Camino .....	117.99 kit.....	177.99 kit
C68DCKIT_ *_*_	1968-72 Chevelle Hardtop .....	117.99 kit.....	177.99 kit
C68VDCKIT_ *_*_	1968-72 Chevelle Convertible/El Camino .....	117.99 kit.....	177.99 kit

Add these to the part #'s\* above for the following:

\*M - Manual brakes-No Power booster used \*4 - For 4 wheel disc brakes \*SS - For stainless steel lines.

**TRSD Performance Series Disc Brake Conversions**

These all new disc brake conversions from The Right Stuff feature Wilwood 2 piston calipers, street performance brake pads, stainless braided flex hoses, spindles, caliper brackets, dust shields, proportioning valve, brake booster with master cylinder and factory size drilled and slotted rotors making for a super easy installation. These kits fit with most 15" or larger wheels.



**Street Performance Series Upgrade Featuring Wilwood Calipers**

The Right Stuff Detailing's new Street Performance Series front disc brake upgrade kit is an easy way to add a nice finishing touch to your car. This kit features Wilwood dual piston black powder coated calipers, fully loaded with pads and hardware, drilled & slotted rotors and spindles. No booster, master cylinder or pro-valve included. Installation hardware and instructions are included.

**4 Wheel Kits**

**4 Wheel Kits Stock Height**

AFXSD21CS	1964-72 Black Calipers Manual.....	1934.99 kit
AFXSD21CZ	1964-72 Red Calipers Manual.....	1934.99 kit
AFXDC21CS	1964-72 Black Calipers 9" Gold Booster.....	2020.99 kit
AFXDC21CZ	1964-72 Red Calipers 9" Gold Booster.....	2020.99 kit
AFXDC26CS	1964-72 Black Calipers 11" Gold Booster.....	2020.99 kit
AFXDC26CZ	1964-72 Red Calipers 11" Gold Booster.....	2020.99 kit
AFXSD21CSX	1964-72 Black Calipers Manual Chrome Master.....	1997.99 kit
AFXSD21CZX	1964-72 Red Calipers Manual Chrome Master.....	1997.99 kit
AFXDC21CSX	1964-72 Black Calipers 8" Chrome Booster.....	2077.99 kit
AFXDC21CZX	1964-72 Red Calipers 8" Chrome Booster.....	2077.99 kit

**2" Drop Spindle**

AFXSD21DS	1964-72 Black Calipers Manual.....	1985.99 kit
AFXSD21DZ	1964-72 Red Calipers Manual.....	1985.99 kit
AFXDC21DS	1964-72 Black Calipers 9" Gold Booster.....	2065.99 kit
AFXDC26DZ	1964-72 Red Calipers 9" Gold Booster.....	2065.99 kit
AFXDC26DS	1964-72 Black Calipers 11" Gold Booster.....	2065.99 kit
AFXDC26DZ	1964-72 Red Calipers 11" Gold Booster.....	2065.99 kit
AFXSD21DSX	1964-72 Black Calipers Manual Chrome Master.....	2043.99 kit
AFXSD21DZX	1964-72 Red Calipers Manual Chrome Master.....	2043.99 kit
AFXDC21DSX	1964-72 Black Calipers 8" Chrome Booster.....	2129.99 kit
AFXDC21DZX	1964-72 Red Calipers 8" Chrome Booster.....	2129.99 kit

**Front End Kits Stock Height**

AFXDC32S	1964-72 Black Calipers 11" Gold Booster.....	1187.99 kit
AFXDC32Z	1964-72 Red Calipers 11" Gold Booster.....	1187.99 kit
AFXDC32SX	1964-72 Black Calipers 8" Chrome Booster.....	1312.99 kit
AFXDC32ZX	1964-72 Red Calipers 8" Chrome Booster.....	1312.99 kit

**Front End Kits 2" Drop Spindle**

AFXDC32DS	1964-72 Black Calipers 11" Gold Booster.....	1273.99 kit
AFXDC32DZ	1964-72 Red Calipers 11" Gold Booster.....	1273.99 kit
AFXDC32DSX	1964-72 Black Calipers 8" Chrome Booster.....	1358.99 kit
AFXDC32DZX	1964-72 Red Calipers 8" Chrome Booster.....	1358.99 kit

**Front End Upgrade Kits**

These kits come with drilled and slotted rotors, calipers, spindles and hardware.

AFXWK32S	1964-72 Black Calipers Stock Height.....	1021.99 kit
AFXWK32Z	1964-72 Red Calipers Stock Height.....	1021.99 kit
AFXWK32DS	1964-72 Black Calipers 2" Drop Spindle.....	1072.99 kit
AFXWK32DZ	1964-72 Red Calipers 2" Drop Spindle.....	1072.99 kit

These kits come with drilled and slotted rotors, loaded calipers and hardware.

RCP69S	1964-72 Black Calipers.....	816.99 kit
RCP69Z	1964-72 Red Calipers.....	816.99 kit

**Rear End Kits**

AFXRDM21S	1964-72 Black Calipers.....	889.99 kit
AFXRDM21Z	1964-72 Red Calipers.....	889.99 kit
AFXRDM278S	1978-88 Black Calipers.....	960.99 kit
AFXRDM278Z	1978-88 Red Calipers.....	960.99 kit

**Rear Kits With Front Upgrade Kits**

These kits come with a complete rear kit and a front kit with drilled and slotted rotors, loaded calipers and hardware.

A69RDM21S	1969-72 Black Calipers.....	1609.99 kit
A69RDM21Z	1969-72 Red Calipers.....	1609.99 kit
A73RDM21S	1973-77 Black Calipers.....	1609.99 kit
A73RDM21Z	1973-77 Red Calipers.....	1609.99 kit
A78RDM278S	1978 Black Calipers.....	1695.99 kit
A78RDM278Z	1978 Red Calipers.....	1695.99 kit
A79RDM278S	1979 Black Calipers.....	1695.99 kit
A79RDM278Z	1979 Red Calipers.....	1695.99 kit
A82RDM278S	1982-88 Black Calipers.....	1695.99 kit
A82RDM278Z	1982-88 Red Calipers.....	1695.99 kit

These kits ship oversize. No Volume Discount.



AFXDC32S



AFXDC32SX



RCP69Z

AFXRDM21S



A69RDM21S

AFXWK32DZ



AFXDC41CZX

**BUY'N SAVE WITH KITS**



**Four Wheel Power Disc Brake Conversion Kits**

Upgrade your classic to the ultimate in stopping power. Our 4 wheel kits are the most complete kits in the industry at rock bottom prices. Upgrade packages available- see ledger below. Add our No Brainer-Disc Brake line kit for a care-free installation.

<b>Stock Height</b>		
AFXDC41C	1964-72 Chevelle 9" PB .....	1187.99 kit
AFXDC46C	1964-72 Chevelle 11" PB .....	1187.99 kit
AFXDC41CS	1964-72 Chevelle 9" PB, DS, BPC.....	1460.99 kit
AFXDC46CS	1964-72 Chevelle 11" PB, DS, BPC.....	1460.99 kit
AFXDC41CZ	1964-72 Chevelle 9" PB, DS, RPC.....	1460.99 kit
AFXDC46CZ	1964-72 Chevelle 11" PB, DS, RPC.....	1460.99 kit
AFXDC41CSX	1964-72 Chevelle 8" CH, DS, BPC .....	1551.99 kit
AFXDC41CZX	1964-72 Chevelle 8" CH, DS, RPC .....	1551.99 kit

**2" Dropped Spindle Height**

AFXDC41D	1964-72 Chevelle 2" Drop w/ 9" PB .....	1250.99 kit
AFXDC41DS	1964-72 Chevelle 2" Drop, 9"PB, DS, BPC.....	1523.99 kit
AFXDC41DSX	1964-72 Chevelle 2" Drop, 8"CH, DS, BPC .....	1614.99 kit
AFXDC46D	1964-72 Chevelle 2" Drop w/ 11" PB .....	1250.99 kit
AFXDC46DS	1964-72 Chevelle 2" Drop, 11"PB, DS, BPC .....	1523.99 kit
AFXDC46DSX	1964-72 Chevelle 2" Drop, 8"CH, DS, BPC .....	1614.99 kit

\*PB- Gold Power Booster, DS- Drilled & Slotted Rotors, BPC-black powder coated calipers, RPC-red powder coated calipers CH-Chrome power assembly (booster, master, pro-valve).



AFXDC46C-GUPX



AFXDC4WDS11-GUPX

**1964-1972 Chevelle Ground Up Motor Sports Exclusive 4 Wheel Disc Brake Conversions**

Upgrading your Chevelle to four-wheel disc brakes is one of the easiest and most cost-effective things you can do for more driving enjoyment and increased safety. Classic Chevelles had great performance and styling from the factory but left a lot to be desired in the braking department. Upgrade your outdated braking system today with this convenient Ground Up Motor Sports Exclusive four-wheel disc brake kit and cruise with peace of mind. This kit is complete with a front brake kit and a rear brake kit.

AFXDC46C-GUPX	1964-72 All 11" PB.....	899.99 kit
AFXDC41C-GUPX	1964-72 All 9" PB.....	899.99 kit
AFXDC4WDS09-GUPX	1964-72 All 9" PB DS Rotors SS Flex Hoses.....	899.99 kit
AFXDC4WDS11-GUPX	1964-72 All 11" PB DS Rotors SS Flex Hose.....	899.99 kit

Note: This kit requires 15 inch diameter wheels or larger. Rear kit will not fit 14.5 inch inner diameter wheels such as reproduction Super Sport / Olds SSI wheels. Will fit 15 inch or larger rally wheels or aftermarket aluminum Super Sport wheels.

### SIGNATURE\* BY TRSD 4-WHEEL DISC BRAKE CONVERSION KITS

\*FOR 17" OR LARGER WHEELS • LIFETIME WARRANTY!!!

Bold looks define the Signature line of Brake Kits. Large diameter (13") zinc plated rotors, powder coated calipers and USA made Timken bearings: Only premium quality components make the grade. These are amazing brakes at a great price. Add the No Brainer Brake Line Kit for true bolt-in installation. Requires minimum 17" wheel. Bolts to stock drum or disc spindles. Complete kit includes:

- 13" Front drilled/slotted zinc plated rotors • 12" rear drilled/slotted zinc plated rotors • Fully machined caliper brackets
- 2024-Tk Forged aluminum hubs w/ 7/16" and 1/2" studs for multiple apps • Twin piston aluminum powder coated calipers- red or black
- Ceramic brake pads • Braided stainless steel hoses • Integrated parking brake
- Premium quality hardware • OEM style master cylinder w/combination valve • Chrome master/booster/ valve upgrade available.

\*PB- Gold Power Booster, DS- Drilled & Slotted Rotors, BPC-black powder coated calipers, RPC-red powder coated calipers CH-Chrome power assembly (booster, master, pro-valve).

#### STOCK HEIGHT SIGNATURE KITS (Reuse Original Spindles)

AFXDC51CS	1964-72 Chevelle w/ PB, DS, BPC.....	1934.99 kit
AFXDC51CZ	1964-72 Chevelle w/ PB, DS, RPC.....	1934.99 kit
AFXDC51CSX	1964-72 Chevelle w/ PB, DS, BPC, CH*.....	2060.99 kit
AFXDC51CZX	1964-72 Chevelle w/ PB, DS, RPC, CH*.....	2060.99 kit

#### 2" DROPPED SIGNATURE KITS

AFXDC51DS	1964-72 Chevelle w/ PB, DS, BPC.....	2145.99 kit
AFXDC51DZ	1964-72 Chevelle w/ PB, DS, RPC.....	2145.99 kit
AFXDC51DSX	1964-72 Chevelle w/ PB, DS, BPC, CH*.....	2271.99 kit
AFXDC51DZX	1964-72 Chevelle w/ PB, DS, RPC, CH*.....	2271.99 kit

#### 4 WHEEL DISC BRAKE CONVERSION LINE KITS - "NO BRAINER" (Reuse Original Spindles)

Simplify your installation when doing a 4- wheel disc brake conversion with all the brake lines and clips you will need. Includes: Front line kit, Front to Rear line, Rear axle line set, Rear flex hoses, Clip set.

	Original	Stainless
C64DCKIT4_*	1964-67 Chevelle Hardtop 4W D/B Lines.....	109.99 kit / 159.99 kit
C64VDCKIT4_*	1964-67 Chevelle Convertible/EI Camino 4W D/B Lines.....	109.99 kit / 159.99 kit
C68DCKIT4_*	1968-72 Chevelle Hardtop 4W D/B Lines.....	109.99 kit / 159.99 kit
C68VDCKIT4_*	1968-72 Chevelle Convertible/EI Camino.....	109.99 kit / 159.99 kit

\*Add \*SS to Part # for Stainless lines.



AFXDC51CSX

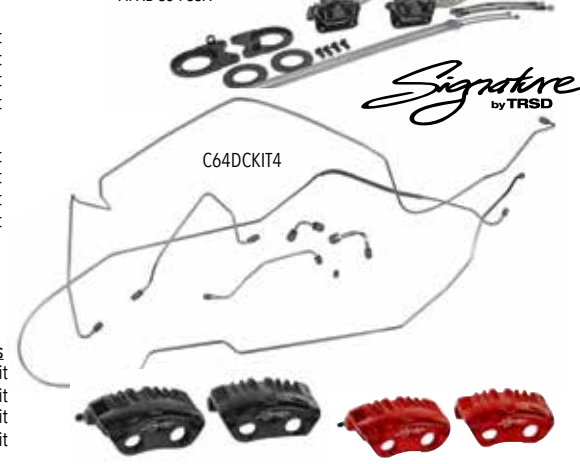

C64DCKIT4



AFXRD01

#### Rear Disc Brake Conversion Kit

Complete rear disc brake conversion kit for the ultimate stopping power. This kit includes rotors, loaded calipers, caliper brackets, bracket hardware, flex hoses and rear brake cables.

To add drilled and slotted rotors and painted calipers, add the following letters.

S for Black Calipers, Z for Red Calipers.

Ex. AFXRD01S is 1964-72 w/ Black Calipers.

AFXRD01_	1964-72 Standard Calipers .....	668.99 kit
----------	---------------------------------	------------

No Volume Discount. Ships in multiple Oversize boxes.

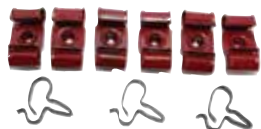

INL-CAB201

#### Brake Line Clip Kits - O.E.M.

These complete brake line clip kits include all of the factory correct clips in the original colors.

INL-CAB201	1964-66 Brake Line Clip Kit (9 pc.) .....	28.99 kit
INL-CAB202	1967 Brake Line Clip Kit (10 pc.) .....	28.99 kit
INL-CAB203	1968 Brake Line Clip Kit (15 pc.) .....	32.99 kit
INL-CAB204	1969 Brake Line Clip Kit (19 pc.) .....	32.99 kit
INL-CAB205	1970 Brake Line Clip Kit (19 pc.) .....	32.99 kit
INL-CAB206	1971-72 Brake Line Clip (23 pc.) .....	41.99 kit
INL-ACB202	1973-77 Brake Line Clip (23 pc.) .....	44.99 kit



FSK-69KIT

#### Deluxe Disc Brake Mini Kit

This deluxe disc brake mini kit contains essential parts to convert to your own disc brake setup or refurbish your factory setup. Includes spindles, caliper brackets, caliper backing plates, flex hoses, pro valve kit, bearing and seal kit and hardware.

FSK-69KIT	1969-72	
	w/ Single Piston Calipers.....	378.99 kit

Can be used on 1964-1968 when using 69-72 single piston calipers. No Volume Discount.



FSK-69

#### Basic Disc Brake Mini Kit

Basic kit for converting to disc brakes or restoring factory disc brake setup. Complete with 2 spindles, 2 caliper brackets, 2 caliper backing plates and 2 bolts.

FSK-69	1969-72 .....	263.12 kit
--------	---------------	------------

Can be used on 1964-1968 when using 69-72 single piston calipers. No Volume Discount.



#### Powdercoated Calipers

Add a nice finishing touch with these loaded calipers complete with pads and hardware.

FRC-69AR	1969-72 Red.....	159.98 kit
FRC-69AB	1969-72 Black.....	159.98 kit
FRC-73AR	1973-77 Red.....	179.99 kit
FRC-73AB	1973-77 Black.....	179.99 kit



FMP-0200

#### Disc Brake Pads

New brake pad set.

FMP-0400	1967-68 4 Piston .....	49.99 set
FMP-0200	1964-72 1 Piston .....	36.95 set



**Electric Vacuum Kit**

If you have a big cam and low vacuum is making it tough for your power disc brakes to work properly, then this electric vacuum pump kit will solve your problems! This kit includes an efficient electric pump, relay switch, distributor with vacuum switch, wiring, hoses and brackets. This system requires a 12V negative ground system for operation.

EVP01 Vacuum Pump Kit ..... 309.99 kit



**Bearing & Seal Kit**

New GM bearing & seal kit (2) inners, (2) outers, and (2) grease seals.

FBK-67D 1964-72 All w/ Disc.....46.53 kit



**Bearing Cap**

Original GM style bearing & dust shield cap.

FBC-605 1964-72 All ..... 11.99 ea.



**Bearing Nut - Washer Kit**

Correct castle nut, thrust washer and cotter pin. 2 kits are required per car.

FNW-103 1964-72 All ..... 8.99 kit



**Single Piston Brake Calipers**

New single piston loaded calipers complete with pads and all new hardware. Ready to install!

FMM-1021 1964-72 LH ..... 79.95 ea.  
FMM-1022 1964-72 RH ..... 79.95 ea.  
FRC-12N 1978-88 LH ..... 74.99 ea.  
FRC-13N 1978-88 RH ..... 74.99 ea.

No Volume Discount.

**O.E.M.**



**Caliper Backing Plates**

Reproduction zinc backing plates.

FKW-4160 1967-68 4 Piston ..... 87.99 pr.  
FPP-11J 1964-72 Single Piston ..... 39.95 pr.  
FPP-11GSK 1969-72 Gasket ..... 8.99 pr.

No Volume Discount.



**Caliper Inlet Lines**

Correct lines for 4 piston calipers. Choose original material or stainless steel.

**1/2" RH Port & 7/16" LH Port**

CFC6701 1967-68 OM ..... 21.99 pr.  
CFC6701SS 1967-68 SS ..... 29.99 pr.

**3/8" LH Port & 3/8" RH Port**

CFC6702 1967-68 OM ..... 21.99 pr.  
CFC6702SS 1967-68 SS ..... 29.99 pr.



**Inlet Line Brackets**

Correct 4 piston caliper inlet line brackets which mount to the calipers where the hard inlet lines meet the rubber flex hoses.

FHB-01 1967 ..... 34.99 pr.  
FHB-02 1968 ..... 21.99 pr.



**Caliper Mounting Brackets**

Reproduction caliper mounting brackets.

FM-155X 1967-68 4 Piston ..... 150.99 pr.  
FM-2501 1964-72 Single Piston\* ..... 86.99 pr.  
\*Fits 15" or larger wheels.



**Backing Plate Bolt**

Correct bolt for attaching plate to spindle.

BCP-373 1964-72 Single Piston ..... 20.99 ea.



**Brake Caliper Bolts**

Correct bolts/pins for mounting caliper to bracket. Two per caliper.

BMP-1000 1964-72 Single Piston ..... 2.99 ea.



**Disc Brake Retaining Pin**

Correct pin for retaining 4 piston caliper brake pads to caliper. 2 required.

FBP-035 1967-68 4 Piston ..... 6.99 ea.



**Steering Arms**

Reproduction steering arms for your worn or missing originals.

FSA-01 1964-72 ..... 79.99 pr.

**Spindles**

FM-373B

FM-3712



**Spindles**

New OEM spindles.

FM-3712 1964-72 Disc ..... 79.99 ea.  
FM-1712 1964-72 Drum ..... 99.99 ea.  
FM-37DROP 1964-72 Disc Brake Drop Spindles.... 199.99 pr.  
FM-373B Attaching Bolts..... 6.95 pr.



**Drum Brake Front Hub Kit**

OE quality drum brake hub kit. Replace your worn out drum brake hubs with this complete kit.

FRH-6474HK-OE 1964-72 All ..... 99.99 set  
No volume discount.



**Drilled & Slotted Rotors** FCDR-66  
 Drilled and slotted for maximum cooling and reduced fade; the ultimate in high performance braking and looks.

FCDR-66	1969-72*	163.99 pr.
FCDR-7377	1973-77	188.99 pr.
FCDR-78G	1978	188.99 pr.
FCDR-79G	1979-81	163.99 pr.
FCDR-82G	1982-88	188.99 pr.

\*Works on 1964-72 with single piston calipers.



FBR-2PK

**2 Piece Rotors**

Available for the first time! All cars from 1967-72 originally came with 2 piece rotors from the factory. These 2 piece rotors duplicate the originals and are a must for a concours restoration.

FBR-2PK	1967-72 All Pair	324.99 kit
---------	------------------	------------



FBR-880

**Rotors**

New OEM style one piece rotors.

FBR-780	1967-68 4 Piston	74.99 ea.
FBR-880	1968-72 All	99.99 ea.
FBR-880KIT	1968-72 Pair	199.99 pr.
FBR-03C	1973-77 All	61.99 ea.



**Rear Drum Brake Kit**

DBK64R2

This is the complete kit and all parts are plated and color coated factory correct. The best part is that it comes completely assembled ready to bolt on to the axle housing. Take the frustration out of your project with this kit. This kit includes: Backing plates, Wheel Cylinder, Drums, Shoes, All of the hardware: Springs, Adjuster, Space bar, Special washer, Cylinder pins and parking brake lever.

DBK64R2	1964-67	589.99 kit
DBK68R2	1968-72	589.99 kit



**Rear Drum Brake Rebuild Kit**

This is a complete drum rebuild kit. Includes: shoes, spring kits, pins, wheel cylinder screws, parking brake levers, space bar and washers. Fits all cars with a 9 and a half inch rear drum. Does both sides.

FPK-REAR-KIT	1964-77	154.99 kit
--------------	---------	------------



FD-95F

**Brake Drums**

Brand new finned brake drums.

FBD-95R	1964-72 Rear Finned	64.99 ea.
FD-95F	1964-72 Front Finned	69.99 ea.



FBP-41L

**Backing Plates**

New replacement rear drum backing plates.

FBP-41L	All LH	64.99 ea.
FBP-41R	All RH	64.99 ea.
FBP-41K	All Kit	116.98 kit
FPB-BOLT	Retaining Bolt/Nut	0.95 ea.

FPK-1671



**Brake Hardware Kit**

Correct springs, rods, retainer, adjuster and clamp for mounting shoes to car. Does 2 wheels.

FPK-1671	All Front	45.84 kit
FPK-2642	All Rear	43.32 kit
FPK-REAR-KIT	All 9.5 Drums	154.99 kit

F5-64R



**Brake Shoes**

Complete shoes for 2 drums.

F5-64R	All Rear	29.95 pr.
F5-64F	All Front	32.95 pr.

FBG-17



FAP-2R

**Drum Brake Guide/Pin**

FBG-17	Upper Guide Plate	5.95 ea.
FAP-2R	Attaching Pin Rear	19.99 ea.



FMC-6700



FG-67B

**Master Cylinder Caps & Gaskets**

New correct gold cadmium plated caps.

**Caps**

FMC-6450	1964-66 Single	24.99 ea.
FMC-6700	1967-69 Disc	16.95 ea.
FMC-6800	1970-72 Disc	16.95 ea.

**Gaskets**

FG-67D	1967-72 Drum	7.99 ea.
FG-67B	1967-69 Disc	9.99 ea.
FG-695	1970-72 Disc	7.99 ea.



FMR-12441



FLN-12968

FMP-12046

**Master Cylinder Hardware**

**Master Cylinder Firewall Reinforcement Plate**

Used only on manual brakes to provide support at the firewall for the master cylinder.

FMP-12046	1964-72	9.99 ea.
-----------	---------	----------

**Master Cylinder Clevis Lock Nut**

Equipped on all factory manual or power disc cars to prevent the rod from spinning so that the clevis does not fall off.

FLN-12968	1964-72	2.99 ea.
-----------	---------	----------

**Master Cylinder Rod Assembly**

Correct master cylinder push rod assembly used when converting to manual disc or if the car is manual drum.

FMR-12441	1964-72	56.99 ea.
FBF-606	Booster Rod Fork	14.95 ea.



FMP-1967C



FMP-51C

**Chrome Master Cylinders**

A chrome master cylinder will add a beautiful finishing detail to your engine compartment so you will be proud to pop your hood.

**Chrome**

FMP-1967C	1967-72 Round Disc/Drum 1-1/8" Bore	107.99 ea.
FMP-04C	1967-72 Round Disc/Disc 1" Bore	107.99 ea.
FMP-51C	1967-72 Slimline Disc/Drum 1-1/8" Bore	126.99 ea.
FMP-56C	1967-72 Slimline Disc/Disc 1" Bore	126.99 ea.

**OEM Style Master Cylinders**  
Choose from a wide variety of master cylinders to suit your needs. OEM style master cylinders feature cast bodies with caps as original. Choose a master with bleeders for the ultimate in authenticity.

FMP-1362	1964-66 Single Drum.....	69.99 ea.
FMP-1966	1967-72 Dual Drum Power.....	99.99 ea.
FMP-1967	1967-69 Power Disc.....	63.99 ea.
FMP-069	1967-69 Power Disc w/ Bleeders.....	113.99 ea.
FMP-1970	1970-72 Power Disc.....	69.95 ea.
FMP-070	1970-72 Power Disc w/ Bleeders.....	107.99 ea.



**Power Brake Hose Kit**  
OEM style hose with correct double circle Delco check valve, grommet and black phosphate clamps.

AXP-0656	1964-88.....	21.95 kit
----------	--------------	-----------



**Brake Booster Check Valves**  
New replacement check valves complete with grommet.

AXP-1CV	All, White.....	16.99 ea.
GCS-S7800	All, Chrome.....	7.99 ea.



**Power Booster Boot**  
Reproduction of this often missing boot.

FBB-3715	1968-72 All.....	14.99 ea.
----------	------------------	-----------



**Power Brake Tube**  
Correct "pre-bent" tube with bracket for cars with power brakes (high quality zinc plated as original.)

APN-7938	1964-69 All BB.....	28.99 ea.
APN-0270	1970 All BB.....	21.99 ea.
APN-71	1971-72 All BB.....	21.99 ea.
APN-7301	1973 350.....	21.99 ea.
APJ-1217	Bracket SB w/ PB.....	15.95 ea.

**THE RIGHT Stuff**

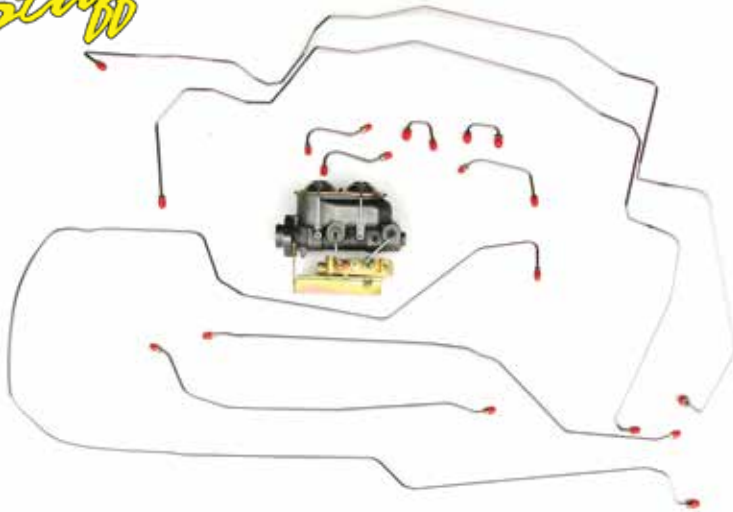

DMKT-813

**Dual Master Conversion Kits**

Give your pre-1967 Chevelle a dual master cylinder system. This kit separates the front brakes from the rear brakes for a much safer system. Each kit includes a distribution block, mounting bracket with hardware and a full set of pre-bent brake lines to finish the installation.

With Master Cylinder	OM	SS
DMKT-811	1964-66 Power Drum Hardtop.....	283.47 kit..... 337.47 kit
DMKT-812	1964-66 Power Drum Convertible.....	283.47 kit..... 337.47 kit
DMKT-813	1964-66 Standard Drum Hardtop.....	283.47 kit..... 337.47 kit
DMKT-814	1964-66 Standard Drum Convertible.....	283.47 kit..... 337.47 kit



BMK-9SB

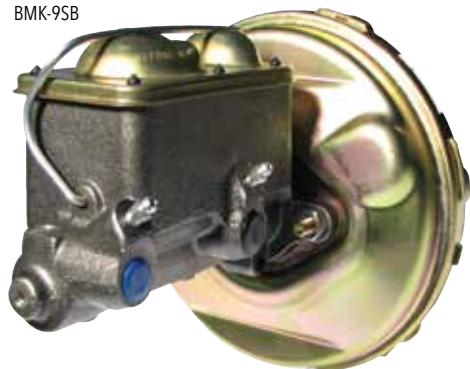

BMK-11RBD



**BUY'N SAVE**  
WITH KITS



**Booster/Master Kits**

Replace your old booster and master in one shot and save! These kits are available in many configurations to suit your restoration needs. If you are restoring a car to original specs, the factory style bleeder screws featured in this master cylinder are a must. The booster is available in 9" or 11" configurations and with or without the Delco Moraine stamp. 1964-69 includes round master and 1970-72 includes square master.

BMK-9R	1964-69 w/ 9" Booster .....	227.68 kit
BMK-11R	1964-69 w/ 11" Booster.....	227.68 kit
BMK-9RD	1964-69 w/ 9" Booster Delco Stamp.....	227.68 kit
BMK-11RD	1964-69 w/ 11" Booster Delco Stamp.....	227.68 kit
BMK-9RB	1964-69 w/ Bleeder Screws w/ 9" Booster.....	272.68 kit
BMK-11RB	1964-69 w/ Bleeder Screws w/ 11" Booster.....	272.68 kit
BMK-9RBD	1964-69 w/ Bleeder Screws w/ 9" Booster Delco Stamp.....	272.68 kit
BMK-11RBD	1964-69 w/ Bleeder Screws w/ 11" Booster Delco Stamp.....	272.68 kit
BMK-9S	1970-72 w/ 9" Booster .....	237.58 kit
BMK-11S	1970-72 w/ 11" Booster.....	237.58 kit
BMK-9SD	1970-72 w/ 9" Booster Delco Stamp.....	237.58 kit
BMK-11SD	1970-72 w/ 11" Booster Delco Stamp.....	237.58 kit
BMK-9SB	1970-72 w/ Bleeder Screws w/ 9" Booster .....	267.28 kit
BMK-11SB	1970-72 w/ Bleeder Screws w/ 11" Booster.....	267.28 kit
BMK-9SBD	1970-72 w/ Bleeder Screws w/ 9" Booster Delco Stamp.....	267.28 kit
BMK-11SBD	1970-72 w/ Bleeder Screws w/ 11" Booster Delco Stamp.....	267.28 kit

No Volume Discount.

**Single Master**

This booster/master kit features a single master for early Chevilles with power drum brakes. The booster comes in a 9" diameter with or without the Delco Moraine stamp.

BMK-966	9" .....	233.08 kit
BMK-966D	9" w/ Delco .....	233.08 kit

No Volume Discount.



BMK-966

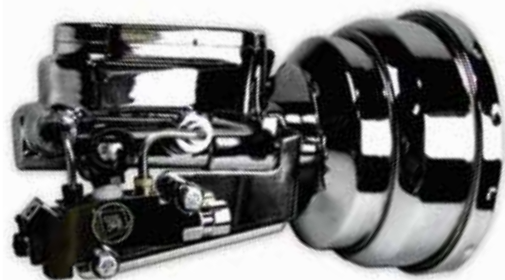

SLIM-8C-4

**Slimline Booster / Master / Pro-Valve Kits**

These Slimline kits allow you to replace your booster, master cylinder and proportioning valve in one simple step! All kits feature an 8" booster.

SLIM-8G-2	1964-72 Disc/Drum 8" Booster Gold.....	279.99 kit
SLIM-8G-4	1964-72 Disc/Disc 8" Booster Gold.....	203.99 kit
SLIM-8C-2	1964-72 Disc/Drum 8" Booster Chrome.....	399.99 kit
SLIM-8C-4	1964-72 Disc/Disc 8" Booster Chrome.....	349.99 kit

BMK-SHOW11R



**Chrome Booster / Master / Pro Valve Kit**

This show quality chrome plated power brake master cylinder and brake booster kit also includes a polished and chromed proportioning valve with stainless steel valve to master cylinder lines. This kit will be a great finishing touch for your classic Chevy.

BMK-SHOW9R	1964-72 Disc/Drum, 9" Booster.....	439.99 kit
BMK-SHOW11R	1964-72 Disc/Drum, 11" Booster.....	439.99 kit
BMK-SHOW9R4W	1964-72 Disc/Disc, 9" Booster.....	439.99 kit
BMK-SHOW11R4W	1964-72 Disc/Disc, 11" Booster.....	439.99 kit

No Volume Discount.



FBB-6



**11" Delco Moraine Booster**

Crafted with the same gold cadmium plating as original as well as the Delco Moraine logo stamping for the ultimate in authenticity.

FBB-6 1964-72 ..... 188.99 ea.



FBB-3



**9" Delco Moraine Booster**

Crafted with the same gold cadmium plating and Delco Moraine logo as our 11" booster, this 9" booster allows more clearance when running tall valve covers.

FBB-3 1964-72 ..... 188.99 ea.



FBB-6-UP



**Power Booster w/ Upside Down Logo**

Correct 11" power brake booster featuring the "upside down" Delco Moraine logo for the ultimate in authenticity. Gold cadmium plated. Include factory correct check valve.

FBB-6-UP 1964-72 11" ..... 188.99 ea.



FPB-1102

**11" Delco Style Booster**

This is a brand new power brake booster crafted with the same gold cadmium plating as original.

FPB-1102 1964-72 ..... 136.99 ea.



FPB-9022

**9" Delco Style Booster**

This is a brand new power brake booster crafted with the same gold cadmium plating as original. This 9" booster allows more clearance when running tall valve covers.

FPB-9022 1964-72 ..... 136.99 ea.



FPB-1003C

**Chrome Booster**

This is a brand new power brake booster crafted with chrome plating to set your car apart from others.

FPB-9021C 1964-72 9" ..... 248.99 ea.  
FPB-1003C 1964-72 11" ..... 188.99 ea.



FPB-7137C

**7" Dual Slimline Booster**

A good booster when room is tight. Great for big block cars with tall valve covers. Roughly the same assist as a 9" single booster.

FPB-7537 1964-72 Gold ..... 109.95 ea.  
FPB-7537C 1964-72 Chrome ..... 119.95 ea.



FPB-8131

**8" Dual Slimline Booster**

Our most powerful Slimline booster. 10-15% more assist than a 9" single. Compact enough to fit most applications.

FPB-8531 1964-72 Gold ..... 115.99 ea.



FPB-9002S

**9" Single Slimline Booster**

Nice clean looks and performance that won't disappoint. A good choice if you're undecided on which booster to get.

FPB-9102 1964-72 Gold ..... 136.99 ea.



FBLK-100

**1964-66 Distribution Blocks**

Correct factory drum brake distribution block. It is the correct size, shape and thickness. Made of brass with a phosphate bracket.

FBLK-100 1964-65 Single Master ..... 20.99 ea.  
FBLK-102 1964-65 Dual Master\* ..... 36.99 ea.  
FBLK-101 1966 Single Master ..... 19.99 ea.  
FBLK-103 1966 Dual Master\* ..... 36.99 ea.

\*Use for dual master conversion.



FPR-108

**1967 Distribution Block**

Correct block located on the driver side frame rail for all drum and disc cars.

FPR-108 1967 All ..... 82.99 ea.



FPR-106

**1968-69 Distribution Block**

Correct block located on the driver side frame rail for all drum and disc cars.

FPR-106 1968-69 All ..... 99.99 ea.



FPR-107

**1970-72 Distribution Block**

Correct block located on the driver side frame rail for 1970-72 drum and 1970 disc cars.

FPR-107 1970-72 All ..... 99.99 ea.



FPR-104D

### Hold Off Valve

Originally used to hold pressure to the rear brakes so the front brakes could engage a split second earlier to prevent fishtailing.

FPR-104D 1970 Disc..... 54.99 ea.



FPVB-3



FPV-BOOT

### Proportioning Valve Bracket & Boot

Correct gold plated pro-valve bracket.

FPVB-3 1967-70 Bracket ..... 39.99 ea.  
 FPV-BOOT All Boot..... 6.95 ea.



FPR-114

### 1967-68 Pro Valve

Correct brake proportioning valve for factory original disc brakes. This valve is located under the master cylinder and includes the bracket.

FPR-114 1967-68 w/ PDB..... 99.99 ea.



FPV-89

### 1969 Pro Valve

Correct brake proportioning valve for factory original disc brakes. This valve is located under the master cylinder. Bracket & boot not included.

FPV-89 1969 w/ PDB..... 96.99 ea.



FPV-7

### 1970 Pro Valve

Correct brake proportioning valve for factory original disc brakes. This valve is located under the master cylinder and includes the bracket.

FPV-7 1970 w/ PDB..... 89.99 ea.



FPR-102

### 1971-77 Pro Valve

Exact to original concourse level proportioning valve with correct wire lead for direct replacement.

FPR-102 1971-77 w/ PDB..... 79.99 ea.



### GM Style Replacement Pro Valve Kit

These are the same pro-valve kits that are used in our disc brake conversion kits to provide correct front to rear balancing. Complete with valve, bracket, hardware and brake warning light harness.

PVK-71COMBOKIT Front Disc..... 96.99 kit  
 PVK-72COMBO-KIT 4 Wheel Disc..... 96.99 kit  
*No Volume Discount.*



PVK-71CK

### Chrome Pro Valve Kit

Includes a new valve, bracket, hardware and a brake warning light harness. This kit is meant for someone putting together their own non-original disc brake setup and is required for proper front to rear balancing.

PVK-71CK Front Disc..... 138.99 kit  
 PVK-72CK 4 Wheel Disc ..... 138.99 kit  
*Will NOT work with original lines!*



FBRK-04

### 1971-72 Valve Bracket

Correct reproduction of this proportioning valve bracket unique to 1971-72 Chevilles.

FBRK-04 1971-72..... 19.99 ea.



HURST-1745000

### Hurst Roll Control Line Lock

Used primarily in drag racing to provide positive locking action to the front wheels of race cars, reducing the chance of "Rolling the Lights" and producing more effective "Burn Outs" for heating up the tires. Rigorous testing has proved a 1/100,000 of a second release time and vibration tests have seen up to 30 G's applied without mechanical failure. Adaptable to most domestic and import hydraulic brake systems.

HURST-1745000 All Universal ..... 164.99 kit  
 HURST-5671510 Installation Kit..... 62.99 kit  
*No Volume Discount.*



### Brake Line Clips

Correct clips for attaching hard brake lines to frame. (Tabbed clips push into frame holes.)

ELC-316 3/16" Front ..... 1.99 ea.  
 ELC-1316 3/16" w/ Tab ..... 4.99 ea.  
 ELC-1516 5/16" Main ..... 1.99 ea.  
 ELC-516 5/16" w/ Tab ..... 4.99 ea.  
 ELC-10P Double Push-In ..... 3.95 ea.  
 BLC-056 Clip Bolt ..... 0.50 ea.

*\*Use on main line with armor shielding.*



INL-CAB201

### Brake Line Clip Kits - OEM

These complete brake line clip kits include all of the factory correct clips in the original colors.

INL-CAB201 1964-66 Clip Kit (9 pc.)..... 28.99 kit  
 INL-CAB202 1967 Clip Kit (10 pc.)..... 28.99 kit  
 INL-CAB203 1968 Clip Kit (15 pc.)..... 32.99 kit  
 INL-CAB204 1969 Clip Kit (19 pc.)..... 32.99 kit  
 INL-CAB205 1970 Clip Kit (19 pc.)..... 32.99 kit  
 INL-CAB206 1971-72 Clip Kit (23 pc.)..... 41.99 kit  
 INL-ACB202 1973-77 Clip Kit (32 pc.)..... 44.99 kit  
 INL-ACB204 1978-88 Clip Kit (22 pc.)..... 35.99 kit



Buy a complete set of front lines, front to rear lines and rear axle lines and take 10% off. Just mention this offer to your sales rep at the time of order!

**Pre-Bent Brake Lines**

Our reproduction brake lines are crafted from original GM blueprints as well as from low mileage original cars. All lines feature correct double flared fittings, correct color coded nuts and correct coiled armor shields Available in original material (OM) or stainless steel (SS). These lines are for original setups only and will not fit aftermarket conversions!

Front Line Kits	OM	SS
CKT6401	1964-65 non-SS Standard Drum (3 pc.).....48.99 kit	73.99 kit
CKT6402	1964-65 non-SS Power Drum (3 pc.).....48.99 kit	73.99 kit
CKT6501	1965 SS & Z16 Standard Drum (3 pc.).....54.99 kit	79.99 kit
CKT6604	1965-66 SS & Z16 Power Drum (3 pc.).....54.99 kit	79.99 kit
CKT6601	1966 non-SS Standard Drum (3 pc.).....48.99 kit	73.99 kit
CKT6602	1966 SS & Z16 Standard Drum (3 pc.).....54.99 kit	79.99 kit
CKT6701	1967 non-SS Standard Drum (4 pc.).....79.99 kit	114.99 kit
CKT6702	1967 non-SS Power Drum (4 pc.).....79.99 kit	114.99 kit
CKT6703	1967 SS Standard Drum (4 pc.).....79.99 kit	114.99 kit
CKT6704	1967 SS Power Drum (4 pc.).....79.99 kit	114.99 kit
CKT6705	1967 SS Standard Disc (5 pc.).....79.99 kit	114.99 kit
CKT6706	1967 SS Power Disc (5 pc.).....79.99 kit	114.99 kit
CKT6801	1968 non-SS Standard Drum (6 pc.).....79.99 kit	114.99 kit
CKT6803	1968 All Power Disc (5 pc.).....79.99 kit	114.99 kit
CKT6804	1968 SS Standard Drum (6 pc.).....79.99 kit	114.99 kit
CKT6805	1968 SS Power Drum (6 pc.).....79.99 kit	114.99 kit
CKT6802	1968-72 Malibu Power Drum (6 pc.).....79.99 kit	114.99 kit
CKT6903	1969 All Power Disc (5 pc.).....79.99 kit	114.99 kit
CKT6901	1969-72 All Standard Drum (6 pc.).....79.99 kit	114.99 kit
CKT7003	1970 All Power Disc (5 pc.).....79.99 kit	114.99 kit
CKT7103	1971-72 All Power Disc (4 pc.).....79.99 kit	114.99 kit
CKT7303	1973-74 All Power Disc (4 pc.).....79.99 kit	114.99 kit
CKT7503	1975-76 All Power Disc (4 pc.).....79.99 kit	114.99 kit
CKT7703	1977 All Power Disc (4 pc.).....79.99 kit	114.99 kit

Ships Oversize.

**Front to Rear Line Kits**

	OM	SS
CIN6401	1964 Hardtop.....60.99 kit	84.99 kit
CIN6402	1964-65 Convertible.....60.99 kit	84.99 kit
CIN6402	1965 Z16, El Camino.....60.99 kit	84.99 kit
CIN6503	1965 Hardtop.....60.99 kit	84.99 kit
CIN6605	1966 Hardtop.....60.99 kit	84.99 kit
CIN6606	1966 Convertible, El Camino.....60.99 kit	84.99 kit
CIN6709	1967 Hardtop.....60.99 kit	84.99 kit
CIN6710	1967 Convertible, El Camino.....60.99 kit	84.99 kit
CIN6801	1968 Hardtop.....60.99 kit	84.99 kit
CIN6802	1968 Convertible.....60.99 kit	84.99 kit
CIN68EC	1968-69 El Camino.....60.99 kit	84.99 kit
CIN6815	1969 Hardtop.....60.99 kit	84.99 kit
CIN6816	1969 Convertible.....60.99 kit	84.99 kit
CIN7021	1970 Coupe Disc.....60.99 kit	84.99 kit
CIN7022	1970 Convertible Disc.....60.99 kit	84.99 kit
CIN70EC	1970 El Camino.....60.99 kit	84.99 kit
CIN7131	1970 Coupe Drum.....60.99 kit	84.99 kit
CIN7132	1970 Convertible Drum.....60.99 kit	84.99 kit
CIN7131	1971-72 Coupe.....60.99 kit	60.99 kit
CIN7104	1971-72 4 Door.....60.99 kit	84.99 kit
CIN7132	1971-72 Convertible.....60.99 kit	84.99 kit
CIN71EC	1971-72 El Camino.....60.99 kit	84.99 kit
CIN7601	1975-76 Chevelle.....60.99 kit	60.99 kit
CIN74EC	1974 El Camino.....60.99 kit	84.99 kit
CIN75EC	1975 El Camino.....60.99 pr.	84.99 pr.

Ships Oversize.

**Rear Axle Kits**

	OM	SS
CRA6403	1964-67 All (2 pc.).....29.99 pr.	42.99 pr.
CRA6803	1968-72 All (2 pc.).....29.99 pr.	42.99 pr.
CRA7303	1973-77 All (2 pc.).....29.99 pr.	42.99 pr.



**Front Flex Hoses**

New OEM front flex hoses exact to original.

EBH-014	1964-67 Drum.....13.99 ea.
EBH-021	1968-72 Drum.....13.99 ea.
EBH-26	1967 Factory Disc.....13.99 ea.
EBH-021	1968 Factory Disc.....13.99 ea.
EBH-020	1969-72 Disc.....22.99 ea.
EBH-162	1973-75 All.....22.99 ea.
EBH-163	1976 All.....25.99 ea.
EBH-008	1977 All.....16.99 ea.
EBH-164	1978 All.....20.99 ea.
EBH-79	1979-88 All.....18.99 ea.
EBH-003	1964-72 Front Disc Conversion Replacement.....13.99 ea.

**Rear Flex Hoses**

New OEM rear flex hoses exact to original.

EBH-017	1964-65 All.....17.99 ea.
EBH-04	1966-67 All.....13.99 ea.
EBH-019	1968 All.....25.99 ea.
EBH-06	1969-72 All.....21.99 ea.
EBH-165	1973 All.....26.99 ea.
EBH-13	1974-77 All.....25.99 ea.
EBH-166	1978-88 All.....20.99 ea.



**Front Stainless Flex Hoses**

EBH-014S	1964-67 Drum, Stainless.....31.99 ea.
EBH-021S	1968-72 Drum, Stainless.....31.99 ea.
EBH-26S	1967 Factory Disc, Stainless.....31.99 ea.
EBH-021S	1968 Factory Disc, Stainless.....31.99 ea.
EBH-020SS	1969-72 Disc, Stainless.....31.99 ea.
EBH-162S	1973-75 All, Stainless.....31.99 ea.
EBH-163S	1976 All, Stainless.....31.99 ea.
EBH-008S	1977 All, Stainless.....31.99 ea.
EBH-79BS	1979-88 All, Stainless.....31.99 ea.
EBH-003S	1964-72 Front Disc Conversion Replacement.....31.99 ea.

**Rear Stainless Flex Hoses**

EBH-017S	1964-65 All, Stainless.....43.99 ea.
EBH-04S	1966-67 All, Stainless.....38.99 ea.
EBH-019S	1968 All, Stainless.....38.99 ea.
EBH-06S	1969-72 All, Stainless.....38.99 ea.
EBH-165S	1973 All, Stainless.....42.99 ea.
EBH-13S	1974-77 All, Stainless.....38.99 ea.
EBH-166BS	1979-88 All, Stainless.....38.99 ea.



**Flex Hose Brackets**

Correct flex hose brackets mounted at frame.

FHB-647	1964-67 Drum or Disc.....24.99 pr.
FHB-01	1967 Disc 4 Piston.....34.99 pr.
FHB-02	1968 Disc 4 Piston On Spindle.....21.99 pr.
FHB-03	1968 Disc 4 Piston On Frame.....24.99 pr.
FHB-04	1964-72 Drum.....24.99 pr.
FHB-499	1969-72 Disc.....25.99 pr.
BLC-056	Attaching Bolt.....0.50 ea.

EBB-691



**Flex Hose Bolts**

Correct OEM brake fluid bolt with hollow center and (2) special washers for attaching flex hose to caliper.

EBB-691	All w/ Disc Brakes 7/16".....3.99 ea.
---------	---------------------------------------

FHB-699



**Flex Hose Bracket**

Correct stamped steel bracket for retaining flex hose to rear end.

FHB-6412	1964-68 12 Bolt Rear.....19.99 pr.
FHB-6410	1964-68 10 Bolt Rear.....16.99 pr.
FHB-699	1969-72 All.....21.99 ea.



**Flex Hose Clip**

Correct clip for retaining flex hose.

EBC-22 All ..... 3.99 ea.

FBLK-1



**Flex Hose Block**

Correct brass block for rear axle hose.

FBLK-1 1966-68 All ..... 13.99 ea.



**Wheel Cylinders**

New wheel cylinders exact to original.

FWC-09

FWC-09 1964-67 Front LH ..... 21.99 ea.  
 FWC-10 1964-67 Front RH ..... 21.99 ea.  
 FWC-05 1968-72 Front LH ..... 35.99 ea.  
 FWC-06 1968-72 Front RH ..... 34.99 ea.  
 FWC-07R 1964-69 All Rear ..... 19.95 ea.  
 FWC-08R 1970-72 All Rear ..... 19.95 ea.  
 BWC-100 Attaching Bolts (2) ..... 1.95 pr.

FCR-176



**Wheel Cylinder Rods**

Correct brake shoe thrust rods for engaging shoes.  
(2) required per cylinder.

FCR-176 1964-72 All ..... 5.99 ea.

BRH-11400



**Rear Flex Hose Mounting Bolt**

Correct rear brake flex hose mounting bolt which is used to secure the hose to the rear end bracket. 3/8 inch shank.

BRH-11400 1964-72 ..... 5.99 ea.



IBA-1495

**Park Brake Assemblies**

Reproduction parking brake assemblies complete with correct pad and trim.

IBA-1495B 1964-67 All ..... 109.95 ea.  
 IBA-1495 1968-69 All ..... 99.99 ea.  
 IBA-1495A 1970-72 All ..... 99.99 ea.



FPB-12-KIT-R

**Parking Brake Shoe Bar**

Correct horizontal bar for activating parking brakes.

FPB-11R 1964-72 All Bar Only ..... 14.99 ea.  
 FPB-12-KIT-R Lever/Spring Kit RH ..... 43.99 kit  
 FPB-12-KIT-L Lever/Spring Kit LH ..... 43.99 kit



**BUY 'N SAVE**  
WITH KITS

**Parking Brake Cable Super Kits**

These kits include everything you need to totally replace your old parking brake cables! These kits come with (1) front cable, (1) intermediate cable, (2) rear cables, (1) cable equalizer, (2) cable connectors, (2) frame hooks, (1) crossmember hook and (3) cable retainer clips. Available in original material (OM) or stainless steel (SS).

	OM	SS
PBSUKIT-1A 1964-67 Chevelle PG, TH350, TH200-R4, 4 Speed	116.99 kit	199.99 kit
PBSUKIT-1E 1964-67 El Camino PG, TH350, TH200-R4, 4 Speed	150.99 kit	238.99 kit
PBSUKIT-2A 1964-67 Chevelle, TH400, TH700-R4, 6 Speed	116.99 kit	199.99 kit
PBSUKIT-2E 1964-67 El Camino, TH400, TH700-R4, 6 Speed	150.99 kit	238.99 kit
PBSUKIT-3A 1968-72 Chevelle PG, TH350, TH200-R4, 4 Speed	116.99 kit	199.99 kit
PBSUKIT-3E 1968-72 El Camino PG, TH350, TH200-R4, 4 Speed	150.99 kit	238.99 kit
PBSUKIT-4A 1968-72 Chevelle, TH400, TH700-R4, 6 Speed	116.99 kit	199.99 kit
PBSUKIT-4E 1968-72 El Camino, TH400, TH700-R4, 6 Speed	150.99 kit	150.99 kit



IPB-513

**Parking Brake Guide Bar Springs**

Correct green springs for 9.5 inch rear brakes.

IPB-513 1964-77 ..... 9.99 pr.

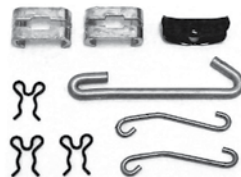

PBCK-1A

**Brake Cable Support Kit**

Complete kit with all hooks and clips for retaining parking brake cables.

PBCK-1A 1964-72 w/ TH400 ..... 26.99 kit  
 PBCK-2A 1964-72 w/o TH400 ..... 26.99 kit



ECRE-ADJ-KIT

**Universal Emergency Brake Cable Kit**

This universal kit is the perfect fit for your modified ride. With a 108" total length, you can cut to fit any application with ease. This hassle-free kit is designed for use with either pull handle or foot brake and includes all necessary hardware for a simple installation.

ECRE-ADJ-KIT All ..... 99.99 kit

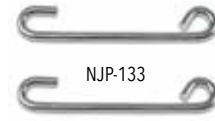

NJP-133



FJ-472

**Brake Cable Guides**

Correct hooks for supporting cables to crossmember.

FJ-472 1964-72 w/o TH400 ..... 7.99 ea.  
 FJ-400 1964-72 w/ TH400 ..... 7.95 ea.  
 NJP-133 1964-72 Side Body Brace ..... 15.99 pr.



NJ-4675

**Brake Cable Connector**

Correct U shaped zinc connector for connecting intermediate cable to rear cables.

NJ-4675 1964-72 All ..... 6.99 ea.



NJ-525

**Brake Cable Equalizer**

Correct support for connecting front cable to intermediate cable and provides equalizing tension for rear cables.

NJ-525 1964-72 All ..... 4.99 ea.



NX-281

**Brake Cable Retainer**

Correct clip for all cars (3 required).

NX-281 1964-72 All ..... 3.99 ea.

**VELOCITY SERIES SUSPENSION**

Why own a muscle car you hate to drive? A great suspension is the key to a great driving car. That is why Ground Up Motor Sports created our Velocity Series Suspension Kits. Our Velocity line of suspensions offer you the chance to update and upgrade your suspension while maintaining your budget. Whether you are looking for an upgraded system, a stock replacement system or just a basic budget friendly system, Ground Up Motor Sports has you covered.



DIX-70V

**BUY'N SAVE**  
WITH KITS



**Deluxe OEM Front Suspension Kit**  
This is the ultimate suspension kit! Each kit includes the finest quality OEM components. Be sure to check which type of lower control arm bushings you have.

- 2 Upper Ball Joints
- 4 Lower Control Arm Bushings
- 2 Lower Ball Joints
- 4 Upper Control Arm Bushings
- 2 Outer Tie Rods
- 2 Stabilizer Ends Links
- 2 Inner Tie Rods
- 2 Adjuster Sleeves
- 1 Idler Arm

DIX-64	1964-67 Regular Bushings 13/16" Idler Arm.....	324.34 kit
DIX-64B	1964-67 Large 1.90" Bushings 13/16" Idler Arm.....	344.14 kit
DIX-6478	1964-67 Regular Bushings 7/8" Idler Arm .....	333.31 kit
DIX-64B78	1964-67 Large 1.90" Bushings 7/8" Idler Arm .....	353.11 kit
DIX-70	1968-70 w/ Round Bushings.....	324.34 kit
DIX-70V	1968-70 w/ Oval Bushings.....	324.36 kit
DIX-72	1971-72 w/ Round Bushings.....	324.41 kit
DIX-72V	1971-72 w/ Oval Bushings.....	324.43 kit

*No Volume Discount.*



E-DIX64



**Value Front Suspension Kit**  
This kit is perfect for your daily driver or restoration on a budget. It includes all high quality imported suspension parts.

- 2 Upper Ball Joints
- 2 Outer Tie Rods
- 2 Lower Ball Joints
- 2 Inner Tie Rods
- 4 Lower Control Arm Bushings
- 2 Stabilizer Ends Links
- 4 Upper Control Arm Bushings
- 2 Adjuster Sleeves
- 2 Sway Bar Bushings

E-DIX64	1966-72 Regular Bushings.....	254.25 kit
E-DIX64B	1964-66 Large 1.90" Bushings.....	274.05 kit
E-DIX70V	1968-72 Oval Bushings.....	254.27 kit
E-DIX-70	1968-72 Round Bushings.....	254.25 kit

*No Volume Discount.*





**Polygraphite Basic Front End Rebuild Kit**  
Polygraphite bushings used in this kit are the ultimate combination of polyurethane and graphite. You get performance and durability with superior lubricating qualities which provides smooth operation. Kits include upper and lower ball joints, outer tie rods, control arm bushing kit and lower bump stops.

6465FK-P	1964-65 .....	250.26 kit
66FK-P	1966 .....	250.26 kit
6770FK-PM	1967-70 .....	249.36 kit
7172FK-P	1971-72 .....	249.36 kit

*No Volume Discount.*





**Polygraphite Deluxe Front End Rebuild Kit**  
For the ultimate in performance, install our polygraphite front end kit featuring Energy Suspension parts! This kit offers increased longevity and better performance than the stock rubber front end components. Kits include upper and lower ball joints, inner and outer tie rods, tie rod adjusting sleeves, idler arm bushings and control arm bushing kit and bump stops.

64SFK-P7	1964 w/ 7/8" Idler Arm .....	357.26 kit
64SFK-P13	1964 w/ 13/16" Idler Arm .....	349.29 kit
65SFK-P	1965 w/ 7/8" Idler Arm .....	314.08 kit
66SFK-P	1966 w/ 7/8" Idler Arm .....	357.26 kit
67SFK-PM	1967 w/ 7/8" Idler Arm .....	313.18 kit
6870SFK-P	1968-70 .....	348.39 kit
7172SFK-PM	1971-72 .....	348.46 kit

*End link kit sold separately. No Volume Discount.*



DSE031309



DSE031317

**DSE Pro Touring Front Speed Kit 1**

This exclusive DSE Speed Kit is a complete bolt-on suspension upgrade system designed for ease of installation with no modification to frame. This kit includes:

- Tubular Upper & Lower Control Arms
- Forged 2" Drop Spindles
- Koni Classic Shocks
- Coil Springs
- Tubular Sway Bar Kit

DSE031309	1964-66 SB or LS .....	2922.99 kit
DSE031312	1964-66 BB .....	2922.99 kit
DSE031310	1967 SB or LS .....	2922.99 kit
DSE031313	1967 BB .....	2922.99 kit
DSE031311	1968-72 SB or LS .....	2922.99 kit
DSE031314	1968-72 BB .....	2922.99 kit
DSE031333	1978-88 SB or LS .....	2535.99 kit

*When using stock disc brakes, the stock caliper brackets will have to be notched out slightly to fit the DSE spindles. On 1964-67 models, the existing sway bar mounting holes will need to be drilled and tapped to 3/8". Ships Oversized. Not eligible for free shipping. No Volume Discount.*

**DSE Pro Touring Front Speed Kit 2**

Speed Kit 2 improves the handling and performance to the next level and offers ride height adjustment. This kit includes:

- Tubular Upper & Lower Control Arms
- Forged 2" Drop Spindles
- DSE Aluminum Body Shocks
- Coilover Springs
- Tubular Sway Bar Kit

DSE031317	1964-66 SB or LS .....	3280.99 kit
DSE031319	1964-66 BB .....	3280.99 kit
DSE031318	1967-72 SB or LS .....	3280.99 kit
DSE031320	1967-72 BB .....	3280.99 kit
DSE031335	1978-88 BB .....	3005.99 kit

*When using stock disc brakes, the stock caliper brackets will have to be notched out slightly to fit the DSE spindles. On 1964-67 models, the existing sway bar mounting holes will need to be drilled and tapped to 3/8". Ships Oversized. Not eligible for free shipping. No Volume Discount.*



ES-681

**Inner Tie Rods**

Correct OE style cast steel inner tie rods with correct grease fit locations. The highest quality original style suspension products on the market!

ES-681	1964-70 LH/RH .....	29.95 ea.
ES-406L	1971-72 LH/RH .....	26.99 ea.
ES-2034	1978-88 LH/RH .....	23.95 ea.



ES-333

**Outer Tie Rods**

Correct OE style cast steel outer tie rods with correct grease fit locations. The highest quality original style suspension products on the market! Fits LH or RH.

ES-333	1964-70 .....	26.99 ea.
ES-406R	1971-72 .....	26.99 ea.
ES-2033	1978-88 .....	23.95 ea.



DS-749

**Center Drag Links**

DS-740R	1964-66 13/16" .....	119.99 ea.
DS-740	1964-67 7/8" .....	119.99 ea.
DS-749	1968-72 All .....	49.95 ea.

No Volume Discount.



BPX-9873

**Idle Arms**

D-18633	1964-67 7/8" .....	49.95 ea.
D-18634	1964-67 13/16" .....	39.99 ea.
D-18634	1968-72 13/16" .....	39.99 ea.
D-6187	1978-88 All .....	36.95 ea.
BPX-9873	Bolts .....	3.95 pr.



D-18634



FA-487

**Ball Joints**

FA-487	1964-72 All Upper .....	29.99 ea.
FA-993	1964-72 All Lower .....	22.95 ea.
FA-688	1978-88 Upper .....	26.95 ea.
FA-921	1978-88 Lower .....	26.95 ea.
DRVT-33	Ball Joint Rivets (8 pc.) .....	32.99 kit



DRVT-33



FA-993



ES-2032

**Adjustment Sleeves**

OEM style adjustment sleeve for proper adjustment of tie rods.

ES-2032	1964-70 LH/RH .....	11.95 ea.
ES-2004	1971-72 LH/RH .....	14.95 ea.
ES-2032S	1978-88 LH/RH .....	10.95 ea.



**DSE Tubular Adjustment Sleeves**

Tubular tie rod adjusters improve the strength and integrity of your steering system over stock. The tubular design is stiffer than the OEM split clamp adjuster and weighs less.

DSE090103B	1964-70 Black .....	89.99 kit
DSE090102B	1971-77 Black .....	89.99 kit

No Volume Discount.



**UMI Tie Rod Adjusters**

These heavy duty tie rod adjusters from UMI Performance are designed to eliminate the factory clamp style design making adjustments easy and hassle free while adding enhanced steering. Works with the factory tie rod ends.

UMI-2103HD	1964-70 Billet .....	64.99 kit
UMI-2103	1964-70 Mild Steel .....	72.99 kit
UMI-2104HD	1971-72 Billet .....	69.99 kit
UMI-2104	1971-72 Mild Steel .....	72.99 kit
UMI-2103HD	1978-88 Billet .....	64.99 kit
UMI-2103	1978-88 Mild Steel .....	72.99 kit



**UMI Performance** UMI-ABF401-1-B

**UMI Performance Stage 1 Handling Kit**

This inexpensive kit offers great ride quality and improved handling while giving your muscle car the stance you want. Available in a durable red or black powder coat finish. Springs are black and shocks are red.

Insert color choice in \_\_\_ R = Red ..... B = Black

**Stage 1 Handling Kits**

UMI-ABF401-0-__	1964-66 Stock Height .....	1089.99 kit
UMI-ABF401-1-__	1964-66 1" Drop .....	1059.99 kit
UMI-ABF401-2-__	1964-66 2" Drop .....	1059.99 ea.
UMI-ABF401-67-0-__	1967 Stock Height .....	1089.99 kit
UMI-ABF401-67-1-__	1967 1" Drop .....	1059.99 kit
UMI-ABF401-67-2-__	1967 2" Drop .....	1059.99 kit
UMI-ABF801-0-__	1968-72 Stock Height .....	1064.99 kit
UMI-ABF801-1-__	1968-72 1" Drop .....	1034.99 kit
UMI-ABF801-2-__	1968-72 2" Drop .....	1034.99 kit

**Stage 1.5 Handling Kits**

w/ upgraded adjustable shocks.

UMI-ABF415-1-__	1964-66 1" Drop .....	1699.95 kit
UMI-ABF415-2-__	1964-66 2" Drop .....	1699.95 kit
UMI-ABF415-67-1-__	1967 1" Drop .....	1309.99 kit
UMI-ABF415-67-2-__	1967 2" Drop .....	1699.95 kit
UMI-ABF815-1-__	1968-72 1" Drop .....	1699.95 kit
UMI-ABF815-2-__	1968-72 2" Drop .....	1699.95 kit

*Ships Oversize. No Volume Discount.*



**UMI Performance** UMI-ABF403-64-1-R

**UMI Performance Stage 2 Handling Kit**

Includes everything needed to rebuild the suspension on your classic 1964-1972 GM A-Body. This kit will make any classic cruiser feel like a modern day muscle car!

**Stage 2 Kit Includes:**

- Tubular upper and lower front A-arms
- Heavy Duty Sway bars with bushings and end links
- Set of (4) UMI S series performance monotube shocks
- 1" or 2" premium UMI lowering springs
- Tubular upper and lower rear control arms
- Tubular frame braces
- Replacement rear end housing bushings
- All new Grade 8 hardware and lock nuts

Insert color choice in \_\_\_ R = Red ..... B = Black

UMI-ABF403-64-1-__	1964, 1" Lowering .....	3069.99 kit
UMI-ABF403-1-__	1965-66, 1" Lowering .....	3069.99 kit
UMI-ABF403-67-1-__	1967, 1" Lowering .....	3069.99 kit
UMI-ABF403-67-2-__	1967, 2" Lowering .....	3069.99 kit
UMI-ABF803-1-__	1968-72, 1" Lowering .....	2949.99 kit
UMI-ABF803-2-__	1968-72, 2" Lowering .....	2949.99 kit

*Ships Oversize. No Volume Discount.*



UMI-ABF405-67-1-R

**UMI Performance Stage 3 Handling Kit**

UMI's Stage 3 kit has been made with great street manners combined with Pro-Touring handling capability. In this newest revision we've refined our parts list to provide the most common options in one convenient package.

Insert color choice in \_\_\_ R = Red ..... B = Black

**Stage 3 Handling Kits**

w/ Standard 1" bolt-in rear sway bar & non-adjustable Ridetech shocks.

UMI-ABF405-64-1-__	1964, 1" Lowering .....	3269.99 kit
UMI-ABF405-1-__	1965-66, 1" Lowering .....	3269.99 kit
UMI-ABF405-67-1-__	1967, 1" Lowering .....	3269.99 kit
UMI-ABF405-67-2-__	1967, 2" Lowering .....	3269.99 kit
UMI-ABF805-1-__	1968-72, 1" Lowering .....	3249.99 kit
UMI-ABF805-2-__	1968-72, 2" Lowering .....	3249.99 kit

**Stage 3.5 Handling Kits**

w/ Pro-touring 1" chassis mount rear sway bar & Ridetech 8-way rebound adjustable shocks.

UMI-ABF406-64-1-__	1964, 1" Lowering .....	3779.99 kit
UMI-ABF406-1-__	1965-66, 1" Lowering .....	3779.99 kit
UMI-ABF406-67-1-__	1967, 1" Lowering .....	3779.99 kit
UMI-ABF406-67-2-__	1967, 2" Lowering .....	3779.99 kit
UMI-ABF806-1-__	1968-72, 1" Lowering .....	3759.99 kit
UMI-ABF806-2-__	1968-72, 2" Lowering .....	3759.99 kit

*Ships Oversize. No Volume Discount.*



UMI-ABF407-64-1-R

**UMI Performance Stage 4 Handling Kit**

Who says you can't have it all? UMI's Stage 4 kit transforms your A-Body into a handling machine with the adjustability to perform well at the strip or haul your family comfortably - to the autocross.

**Front Spring Rate Options:**

- 450lb- Small block cruise
- 550lb- Small block handling, all big blocks

Insert color choice in \_\_\_ R = Red ..... B = Black

**450 lb. Front Spring Rate, 1" Rear Drop**

UMI-ABF407-64-1-__	1964 .....	4219.99 kit
UMI-ABF407-1-__	1965-66 .....	4219.99 kit
UMI-ABF407-67-1-__	1967 .....	4219.99 kit
UMI-ABF807-1-__	1968-72 .....	4219.99 kit

**550 lb. Front Spring Rate, 1" Rear Drop**

UMI-ABF408-64-1-__	1964 .....	4219.99 kit
UMI-ABF408-1-__	1965-66 .....	4219.99 kit
UMI-ABF408-67-1-__	1967 .....	4219.99 kit
UMI-ABF808-1-__	1968-72 .....	4219.99 kit

**450 lb. Front Spring Rate, 2" Rear Drop**

UMI-ABF407-64-2-__	1964 .....	4219.99 kit
UMI-ABF407-2-__	1965-66 .....	4219.99 kit
UMI-ABF407-67-2-__	1967 .....	4219.99 kit
UMI-ABF807-2-__	1968-72 .....	4219.99 kit

**550 lb. Front Spring Rate, 2" Rear Drop**

UMI-ABF408-64-2-__	1964 .....	4219.99 kit
UMI-ABF408-2-__	1965-66 .....	4219.99 kit
UMI-ABF408-67-2-__	1967 .....	4219.99 kit
UMI-ABF808-2-__	1968-72 .....	4219.99 kit

*Ships Oversize. No Volume Discount.*



**UMI Performance** UMI-ABF409-6-1-R

**UMI Performance Stage 5 Handling Kit**

UMI's new Stage 5 kit includes all of our high-end Pro-Touring products and will turn your A-Body into a corner carving machine.

Insert color choice in \_\_\_ R = Red ..... B = Black

**450 lb. Front Spring Rate, 1" Rear Drop**

UMI-ABF409-1-__	1965-66 .....	4469.99 kit
UMI-ABF409-1-67-__	1967 .....	3979.95 kit
UMI-ABF809-1-__	1968-72 .....	4469.99 kit

**550 lb. Front Spring Rate, 1" Rear Drop**

UMI-ABF410-1-__	1965-66 .....	4469.99 kit
UMI-ABF410-1-67-__	1967 .....	3979.95 kit
UMI-ABF810-1-__	1968-72 .....	4469.99 kit

**450 lb. Front Spring Rate, 2" Rear Drop**

UMI-ABF409-2-__	1965-66 .....	4469.99 kit
UMI-ABF409-2-67-__	1967 .....	3979.95 kit
UMI-ABF809-2-__	1968-72 .....	4469.99 kit

**550 lb. Front Spring Rate, 2" Rear Drop**

UMI-ABF410-2-__	1965-66 .....	4469.99 kit
UMI-ABF410-2-67-__	1967 .....	3979.95 kit
UMI-ABF810-2-__	1968-72 .....	4469.99 kit

*Ships Oversize. No Volume Discount.*



**UMI Performance** UMI-406503-B

**UMI Corner Max Handling Kit**

UMI's Corner Max front end kits are a comprehensive system with our best corner carving parts under one easy to find part number. The Corner Max system combines geometry corrected a-arms with tall ball joints, higher rate springs, UMI rebound adjustable monotube shocks, heavy duty sway bar and a bump steer kit. The foundation of the kit includes our coilover-only lower a-arms featuring caster improvement, tall ball joints and the ability to remove the spring and shock without taking the spindle apart. The upper a-arm features rod ends for smooth operation and the ability to adjust without shims. The 1-5/16th inch sway bar upgrade complete with UMI's fabricated end links reduces body roll and helps speed transitions. Racing coilover springs are paired with UMI's rebound adjustable coilover monotube shocks. Fine tuning is accomplished with a UMI bump steer kit.

Insert color choice in \_\_\_ R = Red ..... B = Black

**Kits That Reuse Factory Spindles**

UMI-406401-__	1964-67 .....	2699.99 kit
UMI-406402-__	1968-70 .....	2699.99 kit
UMI-406403-__	1971-72 .....	2699.99 kit

**Kits That Come With Taller 2" Drop Spindles**

UMI-406501-__	1964-67 .....	3069.99 kit
UMI-406502-__	1968-70 .....	3069.99 kit
UMI-406503-__	1971-72 .....	3069.99 kit

*No Volume Discount.*





**Tubular Control Arm and Forged Spindle Kit**

The DSE spindle is 1-1/2 inches taller than the stock Chevelle spindle and provides 2 inches of drop from stock height. The taller spindle height improves handling by modifying the camber curve resulting in a negative camber gain during suspension compression. The stock steering arms mount in the optimal location to minimize bump steer. Detroit Speed's tubular upper control arms provide increased strength and additional positive caster. DSE's lower tubular control arms feature a robust tubular design with gussets and a cross brace. Uppers and lowers feature five axis laser cut tube ends and ball joint pockets for a precise fit.

- DSE030104 1964-66 All ..... 2295.99 kit
- DSE030105 1967-72 All ..... 2296.99 kit

*Installation should be followed by a professional alignment.*

*When using stock disc brakes, the stock caliper brackets will have to be notched out slightly to fit the DSE spindles. Ships Oversized. Not eligible for free shipping. No Volume Discount.*



**DSE Camber/Caster Kit**

This kit allows you to adjust camber easily with our one-piece slotted camber shims. Each shim is machined from 6061 aluminum and is then anodized black for durability. Includes four 1/16" shims, four 1/8" shims and two 1/4" shims.

- DSE031715 1973-77 ..... 129.99 kit
- DSE031721 1978-88 ..... 129.99 kit



**Economy Tubular Control Arms.**

**Upper/Lower, Black Set**

Economy upper and lower control arms come complete with ball joints and cross shafts and sway bar endlinks. Improve your front suspension with increased caster built into the arm. Arms are made from large diameter DOM tubing. These specially made arms are designed to fix camber angle problems caused from using drop spindles or drop coils. This set is for the budget minded guy looking to install a set of upper and lower tubular arms with out breaking the bank.

- UCA6472-KIT 1964-72 ..... 299.98 kit

**UMI Upper & Lower Tubular A-Arms**

Improve the street and track performance of your A-Body and achieve that precise Pro-Touring feel by adding a set of fabricated tubular A-Arms. The stock geometry lower a-arms, which work with most popular springs and coil-overs, feature tough tubular construction with greasable polyurethane bushings for precise handling and smooth suspension motion. Optional Delrin® bushings offer additional precision and decreased friction. The ball joint mount is angled slightly from stock to permit usage with lowered vehicles and the design offers additional wheel clearance. The tubular upper a-arms feature Delrin® bushings as well as billet chromoly cross shafts. The relocated ball joint mounting pad increases caster, steering feel and stability without excessive shims and can be loaded with 1/2" taller upper ball joints to improve camber performance. The ultra tough red or black powder coat finish guarantees your performance parts stay looking new. Included with each kit are recommended alignment specs along with detailed installation instructions. Insert color choice in \_\_, R = Red B = Black

**Lower A-Arms w/ Polyurethane Bushings Upper Lower Kits**

- UMI-403133-\_\_ 1964-72 Standard Ball Joints ..... 1238.99 kit
- UMI-403133-1-\_\_ 1964-72 0.5" Taller Upper Ball Joints ..... 1358.99 kit
- UMI-303133-\_\_ 1978-88 Standard Ball Joints ..... 1238.99 kit
- UMI-303133-1-\_\_ 1978-88 0.5" Taller Ball Joints ..... 1318.99 kit

**Lower A-Arms w/ Delrin® Bushings Upper Kits**

- UMI-403233-\_\_ 1964-72 Standard Ball Joints ..... 1308.99 kit
- UMI-403233-1-\_\_ 1964-72 0.5" Taller Upper Ball Joints ..... 1438.99 kit
- UMI-303233-\_\_ 1978-88 Standard Ball Joints ..... 1308.99 kit
- UMI-303233-1-\_\_ 1978-88 0.5" Taller Ball Joints ..... 1388.99 kit

**Upper Arms Only**

- UMI-4033-\_\_ 1964-72 Tubular Upper Non/Adjustable Standard Ball Joint ..... 569.99 pr.
- UMI-4033-1-\_\_ 1964-72 Tubular Upper Non/Adjustable .5" Taller Ball Joint ..... 699.99 pr.
- UMI-4056-1-\_\_ 1964-72 Tubular Upper Adjustable Standard Ball Joint ..... 579.99 pr.
- UMI-4056-2-\_\_ 1964-72 Tubular Upper Adjustable .5" Taller Ball Joint ..... 669.99 pr.
- UMI-4056-3-\_\_ 1964-72 Tubular Upper Adjustable .5" Taller Ball Joint ..... 679.99 pr.
- UMI-3033-\_\_ 1978-88 Tubular Upper Non/Adjustable Standard Ball Joint ..... 569.99 pr.
- UMI-3033-1-\_\_ 1978-88 Tubular Upper Non/Adjustable .5" Taller Ball Joint ..... 649.99 pr.
- UMI-3056-1-\_\_ 1978-88 Tubular Upper Adjustable Standard Ball Joint ..... 579.99 pr.
- UMI-3056-2-\_\_ 1978-88 Tubular Upper Adjustable 0.5" Taller Ball Joint ..... 669.99 pr.
- UMI-3056-1-\_\_ 1978-88 Tubular Upper Adjustable 1" Taller Ball Joint ..... 579.99 pr.

**Lower Arms Only**

- UMI-4031-\_\_ 1964-72 Tubular Lower Poly Bushings Standard Ball Joint ..... 669.99 pr.
- UMI-4032-\_\_ 1964-72 Tubular Lower Delrin Bushings Standard Ball Joint ..... 739.99 pr.
- UMI-4032-1-\_\_ 1964-72 Tubular Lower Delrin Bushings .5" Taller Ball Joint ..... 819.99 pr.
- UMI-3031-\_\_ 1978-88 Tubular Lower Poly Bushings Standard Ball Joint ..... 669.99 pr.
- UMI-3031-1-\_\_ 1978-88 Tubular Lower Poly Bushings .5" Taller Ball Joint ..... 669.99 pr.
- UMI-3032-\_\_ 1978-88 Tubular Lower Delrin Bushings Standard Ball Joint ..... 739.99 pr.
- UMI-3032-1-\_\_ 1978-88 Tubular Lower Delrin Bushings .5" Taller Ball Joint ..... 819.99 pr.

*Tall Ball Joint Option: UMI is proud to offer a number of tall ball joint options. In addition to standard height ball joints, we offer 0.5" tall lower and both 0.5" and 0.9" tall upper. Additional ball joint height functions the same as adding a taller spindle at a fraction of the cost. Drag and cruising oriented cars work fine with standard height while tall ball joints optimize cornering ability. No Volume Discount. Not eligible for free shipping.*



**Coilover Conversion Brackets**

- UMI-4054 1964-72 Front Coilover Conversion Brackets, Weld-in ..... 199.99 ea.



DAA-324

### OEM Front Sway Bar Kit

Eliminate poor handling by installing one of these sway bars! It includes sway bar, brackets, bushings and end links to replace your old, small bar.

DAA-324	1964-77 1-1/4" Kit.....	182.60 kit
DAA-525	1964-77 1-1/8" Kit.....	158.28 kit
DAA-9SS	1 1/8" Sway Bar only.....	132.99 ea.
DAA-8A	1.25" Sway Bar only.....	164.99 ea.
DAA-898	1978-88 1-1/8" Kit.....	207.99 kit

No Volume Discount. Ships Oversize 2. Not eligible for free shipping.



ENG-6472-118-KITB

### 1964-77 Energy Suspension Sway Bar Kits

Do you want to find an easy way to improve poor handling? This complete Chevelle sway bar kit allows you to lose that small diameter front sway bar and replace it with a large diameter sway bar and all of the necessary components in one shot!

ENG-6472-118-KITB	1-1/8" Black Bushings.....	163.77 kit
ENG-6472-118-KITR	1-1/8" Red Bushings.....	163.77 kit
ENG-6472-114-KITB	1-1/4" Black Bushings.....	191.67 kit
ENG-6472-114-KITR	1-1/4" Red Bushings.....	191.67 kit

No Volume Discount. Ships Oversize 2. Not eligible for free shipping.



UMI-403534-R

### UMI Front & Rear Sway Bars

UMI Performance Chevelle solid sway bars are designed to reduce body roll, understeer and increase cornering capabilities resulting in a more balanced suspension. UMI Performance sway bars are manufactured from 4140 chromoly steel and formed as one piece to ensure maximum strength and performance. The rear sway bar is heat treated to maintain longer memory than a cold bent sway bar. The front sway bar is CNC bent for a precision fit. Comes with poly end links and bushings. Available powder coated bright red or gloss black for a durable long lasting finish. Insert your color choice at the end of the part number in \_\_. R = Red B = Black

#### Front & Rear Kit

UMI-403534_	1964-72 Front 1-1/4" Rear 1".....	399.99 kit
UMI-303534_	1978-88 Front 1-1/4" Rear 1".....	399.99 kit

#### Front OE Style Mounts

UMI-4035_	1964-72 1-1/4" Bar.....	229.99 kit
UMI-4067_	1964-77 Front 1-5/16" Bar.....	269.99 kit
UMI-3035_	1978-88 1-1/4" Bar.....	229.99 ea.

#### Front Billet Style Mounts

UMI-4066_	1964-77 Front 1-5/16" Bar.....	349.99 kit
-----------	--------------------------------	------------

#### Rear OE Style Mounts

UMI-4034_	1964-72 1" Bar.....	159.99 kit
UMI-3034_	1978-88 1" Bar.....	159.99 ea.

#### Rear Chassis Style Mounts

UMI-4047-300_	1964-72 1" Bar 3" Axle.....	489.99 kit
UMI-4047-300_	1964-72 1" Bar 3" Axle.....	489.99 kit
UMI-3044-275_	1978-88 1" Bar 2 3/4" Axle.....	489.99 ea.
UMI-3044-300_	1978-88 1" Bar 3" Axle.....	489.99 ea.
UMI-3045-275_	1978-88 1-3/8" Bar 2 3/4" Axle.....	499.99 ea.
UMI-3045-300_	1978-88 1-3/8" Bar 3" Axle.....	499.99 ea.

#### Front Billet Mounts Only (no bar)

UMI-90047	1964-77 1-1/4" Red.....	129.99 pr.
UMI-90066	1964-77 1-5/16" Red.....	129.99 set

No Volume Discount. Ships Oversize.

### Stabilizer End Links

Complete kit for one car.

DSL-72	1964-77 All OEM.....	14.95 kit
9-8118G	1964-77 Polyplus Black Kit.....	23.99 kit
9-8118R	1964-77 Polyplus Red Kit.....	23.99 ea.
DSL-88	1978-88 All OEM.....	14.95 pr.
9-8119G	1978-88 Polyplus Black Kit.....	24.99 kit

DSL-72



### Sway Bar Bushings

OEM rubber bushings.

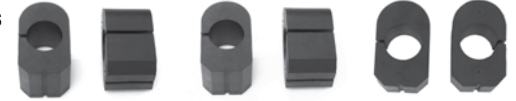

DMG-647

DMG-657

DMG-683

DMG-647	1964-67 SB.....	12.95 pr.
DMG-657	1965-68 BB.....	12.95 pr.
DMG-681	1968-72 SB.....	11.95 pr.
DMG-683	1969-77 1 or 1/16" Bar.....	11.95 pr.
DMG-1516	1978-88 1-5/16" w/ Tabs On Bracket.....	15.95 pr.
DMG-1116	1978-88 1-1/16" w/ Tabs On Bracket.....	15.95 pr.
DMG-118	1978-88 1-1/8" w/o Tabs On Bracket.....	17.95 pr.
DMG-1316	1978-88 1-1/8" w/o Tabs On Bracket.....	12.95 pr.
9-5158G	1964-77 Black Poly 7/8" Bar.....	23.99 pr.
9-5164G	1964-77 Black Poly 1 1/8" Bar.....	24.99 pr.
9-5164R	1964-77 Red Poly 1 1/8" Bar.....	24.99 pr.
9-5165G	1964-77 Black Poly 1 1/4" Bar.....	23.99 pr.
9-5165R	1964-77 Red Poly 1 1/4" Bar.....	23.99 pr.

### Sway Bar Brackets

Correct mounting bracket for stock front sway bar.



DBB-157

MK52-KIT

BAR-1295

DBB-157	1964-77 1-1/16".....	7.99 ea.
BAR-1295	Correct Bolt.....	0.75 ea.
MK52-KIT	1964-72 Brackets/Bushings 1-1/4" (For use with 1 1/4" bar only).....	22.95 kit



DSE031402

### DSE Tubular Front Sway Bar Kit

DSE's tubular 1-3/8 inch front sway bar kit is designed to address the shortcomings of the small factory A Body sway bar. Includes greasable polyurethane bushings, mounts and end links giving you dramatic improvement over your stock suspension and even better results when you combine this sway bar kit with other DSE suspension components.

DSE031402	1964-72 1-3/8" Tubular.....	329.99 kit
DSE031406	1973-77 1-3/8" Tubular.....	299.99 kit
DSE031408	1978-88 1-3/8" Tubular Includes Braces.....	529.99 kit

On 1964-67 models, the existing sway bar mounting bracket holes will need to be drilled and tapped to 3/8". No Volume Discount. Ships Oversize 2. Not eligible for free shipping.



DSE031404

### DSE Spined Front Sway Bar Kit

DSE's tubular 1-3/8 inch front sway bar kit is designed to address the shortcomings of the small factory A Body sway bar. Includes greasable polyurethane bushings, mounts and end links giving you dramatic improvement over your stock suspension and even better results when you combine this sway bar kit with other DSE suspension components.

DSE031404	1964-72 1-1/2" Spined.....	1036.99 kit
-----------	----------------------------	-------------

On 1964-67 models, the existing sway bar mounting bracket holes will need to be drilled and tapped to 3/8". No Volume Discount. Ships Oversize 2. Not eligible for free shipping.



DCC-1516

**Body Mounting Kits**

Complete with everything you need to mount your body to the frame including correct rubber bushings with steel inserts and factory style OEM flanged head frame bolts with washers! Remember, your entire body rides on this hardware, so replacing your worn out body bushings and hardware is extremely important not only for looks but for safety!

DCC-1514	1964-67 Coupe/El Camino w/o Rad Support Bushings.....	67.45 kit
DCC-1514RS	1965-67 Coupe/El Camino w/ Rad Support Bushings.....	91.74 kit
DCC-1515	1964-67 Convertible w/o Rad Support Bushings.....	67.45 kit
DCC-1515RS	1965-67 Convertible w/ Rad Support Bushings.....	91.74 kit
DCC-1516	1968-72 Coupe/El Camino w/ Rad Support Bushings.....	110.69 kit
DCC-1517	1968-72 Convertible w/ Rad Support Bushings.....	110.69 kit

\* 1964 Chevelles did not originally require radiator support bushings.  
\* Convertibles do not require body spacers.



DCC-7377A

**1973-77 Body Bushings**

Complete 28 piece body bushing kit constructed out of rubber with steel inserts. Two of them are solid rubber plugs and the top cap bushings have steel washers molded into them just like factory. Featuring GM numbers (4) 330942, (12) 330955, (2) 377801, (2) 627662 and (4) 330951.

DCC-7377A	1973-77 (28 pc.) *	259.99 kit
BHP-7377	Bolt Kit .....	29.95 kit

\*Note: Hardware not included.



DCC-1519

**Body Bushing Supplement Kit**

Various big blocks required an additional 2 body bushings, so we put together this supplement kit complete with mounting hardware for these applications.

DCC-1518	1964-67 All.....	19.95 kit
DCC-1519	1968-72 All.....	21.99 kit



DCC-1500

**Body Bushing Spacer**

New correct style frame to body spacers for all cars except convertibles.

DCC-1500	1968-72.....	8.95 ea.
----------	--------------	----------



**Polygraphite Body Mount Kit**

These polyurethane body mounts offer increased performance and longevity over stock rubber bushings. Used for mounting body and radiator support to frame.

Add G to the part number for black  
Add R to part number for red.  
Example. 3-4111G is for 65-67 in black.

3-4128_	1964 Coupe .....	140.99 kit
3-4111_	1965-67 Coupe.....	138.99 kit
3-4112_	1965-67 Convertible.....	145.99 kit
3-4115_	1968-72 Coupe.....	105.99 kit
3-4114_	1968-72 Convertible.....	113.99 kit
3-4113_	1968-72 El Camino .....	105.99 kit
3-4170_	1968-72 Coupe w/ Hardware.....	214.99 kit
3-4141_	1978-88 G-Body.....	207.99 kit

No bolts or sleeves included unless noted. No Volume Discount.



DCC-0521

DCC-0522

**Radiator Support Bushing**

Complete kit with all bushings and hardware for mounting radiator support to car.

DCC-0521	1965-67 All .....	26.99 kit
DCC-0522	1968-72 All .....	26.95 kit
DCC-0523	1973-77 All .....	39.99 kit



BHP-0516

**Body Bolt Kits**

Correct black flanged head bolts and washers.

BHP-1643	1964-67 Coupe/El Camino .....	19.95 kit
BHP-1645	1964-67 Convertible.....	21.95 kit
BHP-0516	1968-72 Coupe/El Camino .....	22.95 kit
BHP-0517	1968-72 Convertible.....	23.95 kit
BHP-7377	1973-77 All .....	29.95 kit



RRF-21159

**Body to Frame Repair**

Complete kit of 14 large washers with the correct size hole for body bushings. Once welded in, these repair washers will provide your rusty old frame with the correct size hole.

RRF-21159	1964-72 All .....	36.95 kit
-----------	-------------------	-----------



AERO-60100101



Detail



Installed

**66 Aero Rear Shock Tower Brace**

Designed, Engineered, and Manufactured in the USA. Using a precision laser cut 3/16 inch thick piece of strong steel, this heavy-duty brace bolts together the factory shock tower braces which are a typical weak spot on these cars.

AERO-60100101	1964-67 All Black.....	99.99 ea.
AERO-60100201	1968-72 All Black.....	99.99 ea.

*Ships oversize. No volume discount.*



UMI-401519-B



UMI-3016-B



UMI-3027-B



UMI-402118-R



UMI-30255-R



UMI-4014-R



**UMI Performance Rear Control Arms**

UMI's direct replacement lower control arms are designed to improve traction by replacing worn out factory bushings and weak stamped material. UMI offers a large variety of rear control arms designed for virtually any application. All control arms feature reinforced sway bar holes and are supplied with polyurethane bushings or Teflon® lined rod ends. Roto-Joints, which offer a good compromise between firm polyurethane bushings, soft rubber bushings and spherical rod ends are also available. The upper control arms are direct replacements to minimize wheel hop, improve cornering and help track consistency. They feature TIG and MIG welded construction and are assembled with polyurethane bushings, spherical rod ends or Roto-Joints.

Insert color choice in \_\_\_ R = Red B = Black

**1964-67**

UMI-401518-__	Tubular Rear .....	319.99 kit
UMI-401526-__	Tubular Rear, Adjustable Uppers .....	399.99 kit
UMI-402126-__	Boxed Rear, Adjustable Uppers .....	549.99 kit
UMI-401519-__	Tubular Rear, On-Car Adjustable Uppers .....	399.99 kit
UMI-402118-__	Tubular Upper, Box Lower .....	459.99 kit
UMI-402119-__	Boxed Rear, On-Car Adjustable Uppers .....	549.99 kit
UMI-402418-__	Non Adjustable Upper Poly F/R .....	419.99 kit
UMI-401419-__	Adjustable Upper & Lower .....	469.99 kit
UMI-402719-__	Double Adjustable Upper & Lower .....	549.99 kit

**1968-72**

UMI-401516-__	Tubular Rear .....	319.99 kit
UMI-401525-__	Tubular Rear, Adjustable Uppers .....	399.99 kit
UMI-402125-__	Boxed Rear, Adjustable Uppers .....	549.99 kit
UMI-402416-__	Non Adjustable Upper Poly F/R .....	419.99 kit
UMI-401517-__	Tubular Rear, On-Car Adjustable Uppers .....	459.99 kit
UMI-402116-__	Tubular Upper, Box Lower .....	459.99 kit
UMI-402117-__	Boxed Rear, On-Car Adjustable Uppers .....	549.99 kit
UMI-401417-__	Adjustable Upper & Lower .....	469.99 kit
UMI-402717-__	Double Adjustable Upper & Lower .....	549.99 kit

**1978-88**

UMI-301516-__	Tubular .....	319.99 kit
UMI-301517-__	Tubular Adjustable Uppers .....	399.99 kit
UMI-301417-__	Tubular Adjustable Uppers & Lower .....	469.99 kit
UMI-302717-__	Tubular Double Adjustable Uppers & Lower .....	549.99 kit
UMI-302117-__	Boxed Adjustable Uppers .....	549.99 kit

**Uppers and Lower Sold Separately**

**Uppers**

UMI-4018-__	1964-67 Non Adjustable Poly Front Bushing Only .....	149.99 pr.
UMI-4044-__	1964-67 Non Adjustable Roto Front Bushing Only .....	219.99 pr.
UMI-4019-__	1964-67 Adjustable Rod End Front Bushing Only .....	249.99 pr.
UMI-4039-__	1964-67 Adjustable Roto Front Bushing Only .....	279.99 pr.
UMI-4026-__	1964-67 Adjustable Poly Front Bushing Only .....	249.99 pr.
UMI-402600-__	1964-67 Adjustable Poly F/R Bushings .....	299.99 kit
UMI-4016-__	1968-72 Non Adjustable Poly Front Bushing Only .....	149.99 pr.
UMI-4036-__	1968-72 Non Adjustable Roto Front Bushing Only .....	219.99 pr.
UMI-4017-__	1968-72 Adjustable Rod End Front Bushing Only .....	249.99 pr.
UMI-4037-__	1968-72 Adjustable Roto Front Bushing Only .....	279.99 pr.
UMI-4025-__	1968-72 Adjustable Poly Front Bushing Only .....	249.99 pr.
UMI-402500-__	1968-72 Adjustable Poly F/R Bushings .....	299.99 kit
UMI-4019-__	1964-67 Adjustable Rod End Front Bushing Only .....	249.99 pr.
UMI-3025-__	1973-77 Adjustable Poly Front Bushing Only .....	249.99 pr.
UMI-3016-__	1978-88 Non Adjustable Poly Front Bushing Only .....	149.99 pr.
UMI-3036-__	1978-88 Non Adjustable Roto Front Bushing Only .....	219.99 pr.
UMI-3025-__	1978-88 Adjustable Poly Front Bushing Only .....	249.99 pr.
UMI-3017-__	1978-88 Adjustable Rod End Front Bushing Only .....	249.99 pr.
UMI-3037-__	1978-88 Adjustable Roto Front Bushing Only .....	269.99 pr.
UMI-302500-__	1978-88 Adjustable Poly F&R Bushing .....	299.99 pr.

**Lower Standards**

UMI-4015-__	1964-72 Standard Tubular Poly F/R..	189.99 pr.
UMI-4014-__	1964-72 Standard Tubular Poly F Rod End R .....	249.99 pr.
UMI-4043-__	1964-72 Standard Tubular Rod Ends F/R .....	399.99 pr.
UMI-4038-__	1964-72 Standard Tubular Poly F Roto R .....	289.99 pr.
UMI-4040-__	1964-72 Standard Tubular Roto F/R.	329.99 pr.
UMI-4024-__	1964-72 Standard Boxed Poly F/R....	279.99 pr.
UMI-4021-__	1964-72 Premium Boxed Poly F/R...	329.99 pr.
UMI-4027-__	1964-72 Double Adjustable Rod Ends F/R .....	329.99 kit
UMI-4041-__	1964-72 Standard Boxed Poly F Roto R .....	319.99 pr.
UMI-4042-__	1964-72 Standard Boxed Roto F/R...	379.99 pr.
UMI-3015-__	1978-88 Tubular Non Adjustable Poly F/R .....	189.99 pr.
UMI-3014-__	1978-88 Tubular Adjustable Poly F Rod End R .....	249.99 pr.
UMI-3027-__	1978-88 Tubular Double Adjustable Rod End F/R .....	329.99 pr.
UMI-3038-__	1978-88 Tubular Non Adjustable Rod End F Roto .....	289.99 pr.
UMI-3040-__	1978-88 Tubular Non Adjustable Roto F/R.....	329.99 pr.
UMI-3024-__	1978-88 Boxed Non Adjustable Poly F/R .....	279.99 pr.
UMI-3041-__	1978-88 Boxed Non Adjustable Poly F Roto R ..	319.99 pr.
UMI-3042-__	1978-88 Boxed Non Adjustable Roto F/R .....	379.99 pr.

**Lower Heavy Duty Cromoly**

These race style control arms are designed for aftermarket sway bars that do not attach to the control arms; control arms are supplied with no sway bar holes.

UMI-4023CM-__	1964-72 Double Adjustable Rod Ends F/R.....	299.99 pr.
UMI-4023OFM-__	1964-72 Double Adjustable Rod Ends F/R Offset Ends* .....	319.99 pr.

\*These feature offset aluminum bushings and smaller diameter tubing that place the control arm inward for additional clearance when running large tires. No Volume Discount.



UMI-4022-B

**UMI Lower Control Lift Bars**

The UMI rear lift bars replace the factory rear control arms adding traction while not changing vehicle ride height. Lift bars work with axle torque to load the chassis of the car, forcing the rear wheels downward pushing the tires into the ground, resulting in harder launches and improved 60-foot times. Lift bars are designed to improve traction and reduce unwanted wheel hop. Lift bars feature greaseable polyurethane bushings which are designed to reduce bushing deflection while being street able. Lift bar kit features the correct provisions for adding a stock or aftermarket sway bar, the sway bar holes are placed in the correct pattern to maintain the sway bar level with the rear end while the lift bar is in the lowest hole. The rear mounting brackets feature three settings that allow the lift bar to be lowered 2, 2-3/4 or 3-1/4".

UMI-4022-R	1964-72 Bolt-in Red .....	459.99 kit
UMI-4022-B	1964-72 Bolt-in Black .....	459.99 kit
UMI-4020-R	1964-72 Weld-in Red .....	399.99 kit
UMI-4020-B	1964-72 Weld-in Black .....	399.99 kit
UMI-3022-R	1978-88 Bolt-in Red .....	449.99 pr.
UMI-3022-B	1978-88 Bolt-in Black .....	449.99 pr.
UMI-3020-R	1978-88 Weld-in Red .....	399.99 pr.
UMI-3020-B	1978-88 Weld-in Black .....	399.99 pr.

No Volume Discount.



UMI-4012-R

UMI-4010

**UMI Lower Control Arm Relocation Kits**

Optimize your Chevelle's instant center and improve forward traction by lowering the rear of the lower control arm 2, 2-3/4 or 3-1/4. These brackets are CAD designed to accommodate factory lower control arms as well as all popular aftermarket styles. Robust flanges inside the brackets add reinforcement and ensure factory bushings bolt right in. Brackets installed can provide an average 0.10 second (or better) 60-foot reduction and an overall improvement in launch consistency. Brackets are constructed of 3/16 mild steel and CNC laser cut for precision tolerances. Relocation brackets are designed to work on both lowered and non-lowered vehicles and feature multiple settings to optimize vehicle handling and traction.

UMI-4012-R	1964-72 Bolt-in Red .....	149.99 kit
UMI-4012-B	1964-72 Bolt-in Black .....	149.99 kit
UMI-4010	1964-72 Weld-in Bare .....	89.99 kit
UMI-3018-R	1978-88 Bolt-in Red .....	139.99 kit
UMI-3018-B	1978-88 Bolt-in Black .....	139.99 kit
UMI-3010	1978-88 Weld-in Bare .....	89.99 kit

No Volume Discount.



UMI-4059-R



UMI-4059-B

**UMI Performance Rear Chassis Brace**

This brace ties the two sides of the frame together between the shock towers over the rear axle.

UMI-4059-R	1964-67 Red .....	149.99 ea.
UMI-4059-B	1964-67 Black .....	149.99 ea.
UMI-4058-R	1968-72 Red .....	149.99 ea.
UMI-4058-B	1968-72 Black .....	149.99 ea.
UMI-3055-R	1978-88 Red .....	149.99 ea.
UMI-3055-B	1978-88 Black .....	149.99 ea.

Ships Oversize. No Volume Discount.



UMI-ABR824B



UMI-ABR824-R



**UMI Pro-Touring Rear Suspension Kit**

UMI's new pro-touring kit features all of our top of the line Pro-Tour style components in one convenient package. The GM A-Body lower control arms are loaded with Roto-Joints on each end and feature TIG welded sway bar sleeves along with the awesome articulation of the double Roto-UMI's. The upper arms have Roto-Joints on one end and are fully adjustable to set pinion angle and lateral location. Our new 2999 Roto-Joint axle housing bushing completes the package and ensures bind-free articulation. This 8 Roto-Joint package is the ultimate combination of street comfort and race winning capability. For Pro-Tour cars that see highway use, this kit is like having rod end suspension that just happens to be comfortable. 100% manufactured with pride in Philipsburg, PA - USA.

Insert color choice in \_\_\_\_.

R = Red B = Black

UMI-ABR724_	1964-67 All .....	819.99 kit
UMI-ABR824_	1968-72 All .....	819.99 kit
UMI-GBR024_	1978-88 All .....	819.99 kit



UMI-3000-B

UMI-4004



UMI-2999

**UMI Control Arm Hardware**

Replacement hardware and bushings for your UMI control arms.

UMI-4002	1964-72 Rear Control Arm Bolts Factory Upgrade Set of 8 .....	24.99 kit
UMI-4004	1964-72 Front Control Arm Bolts w/ Aftermarket Arms Set of 8 .....	24.99 kit
UMI-4001	1964-72 Rear Control Arm Bolts Factory Upgrade Set of 4 .....	15.99 kit
UMI-4003	1964-72 Rear Control Arm Bolts Upper Set of 4 .....	14.99 kit
UMI-3002	1978-88 Rear Control Arm Bolts Factory Upgrade Set Of 8 .....	24.99 kit
UMI-3001	1978-88 Rear Control Arm Bolts Factory Upgrade Set Of 4 .....	15.99 kit
UMI-3013	1978-88 Front Control Arm Bolts Factory Upgrade Set Of 8 .....	24.99 kit
UMI-3011	1978-88 Front Control Arm Bolts Factory Upgrade Set Of 4 .....	14.99 kit
UMI-3012	1978-88 Front Upper Control Arm Bolts Factory Upgrade Set Of 4 .....	14.99 kit
UMI-3005-R	1964 Rear End Housing Bushing Red Poly w/o Shell .....	49.99 pr.
UMI-3005-B	1964 Rear End Housing Bushing Black Poly w/o Shell .....	49.99 pr.
UMI-3000-R	1965-72 Rear End Housing Bushing Red Poly w/ Shell .....	49.99 pr.
UMI-3000-B	1965-72 Rear End Housing Bushing Black Poly w/ Shell .....	49.99 pr.
UMI-2999	1965-88 Rear End Housing Bushing Roto Joint .....	169.99 pr.

No Volume Discount.



UMI-4029-R

**UMI Trailing Arm Reinforcements/Frame Braces**

Trailing arm mount braces are designed to reinforce the upper and lower front control arm mounts on your classic Chevelle. The more power your ride makes the better chance of bending or breaking the rear control arm mounts. These tubular reinforcements tie the upper and lower control arm mounts together for added strength and driving performance. Control arm braces are manufactured from DOM steel; TIG welded and feature adjustment for a perfect fit on all Chevelles. Kit includes new longer Grade 8 hardware, nuts and washers.

UMI-4029-R	1964-67 Red .....	159.99 kit
UMI-4029-B	1964-67 Black .....	159.99 kit
UMI-4028-R	1968-72 Red .....	159.99 kit
UMI-4028-B	1968-72 Black .....	159.99 kit



DZ-2500

**Rear Frame Crossmember Brackets**

Dealer installed on most cars with manual transmissions to provide extra frame strength.

DZ-2500	1964-67 All .....	84.99 pr.
DZ-4500	1968-72 All .....	69.99 pr.



NMX-1600

**Rear Control Arm Bushings**

New GM rubber rear control arm bushings.

NMX-1600	1964-77 All .....	15.95 ea.
NMX-1600K	1964-77 All (8pc) .....	114.95 kit

*Does not fit 1964 axle housing.*



BPB-1430

**Control Arm Bolt Rear**

BPB-1430	All .....	7.99 ea.
----------	-----------	----------



NT-1810

NT-073

**Rear End Bumpers**

Correct OEM rubber stop bumpers.

NT-1810K	1964-72 All 3" .....	28.87 kit
NT-1810	1964-72 Upper .....	9.99 ea.
NT-073K	1964-72 Axle Tube .....	20.38 kit
NT-073	1964-72 Axle Tube .....	11.99 ea.
NT-987	1973-77 Axle Tube .....	22.99 ea.



NTK-6472

**Rear Axle Weld-On Bump Stop Brackets & Bumpers**

If you plan on installing an aftermarket rear axle you'll want to pick up a set of these weld-on bump stop brackets & bumpers. Aftermarket axles do not have these bump stops.

NTK-6472	1964-72 Chevelle .....	59.99 kit
----------	------------------------	-----------



DCA-640K



DCA-680K

**Rear Upper Control Arms**

New OEM rear upper control arms complete with original GM rubber bushings. Buy the pair and save!

DCA-640K	1964-67 Upper Pair .....	179.91 pr.
DCA-680K	1968-72 Upper Pair .....	179.91 pr.
DCA-640	1964-67 Upper .....	99.95 ea.
DCA-680	1968-72 Upper .....	99.95 ea.
BPB-1430	Mounting Bolts .....	7.99 ea.

*No Volume Discount.*



NXJ-571

**Rear Lower Control Arms**

These boxed lower arms were originally installed on most SS models and cars with F-41 suspension. All arms feature correct GM rubber bushings and are finished in semi gloss black.

NXJ-571	1964-72 Lower .....	169.99 pr.
BPB-1430	Mounting Bolts .....	7.99 ea.

*No Volume Discount.*



NXJ-6472

**Billet Rear Lower Control Arms With Polyurethane Bushings**

These new billet lower control arms with polyurethane bushings will help dial in your Chevelle or El Camino's rear suspension for firmer, more controlled handling over stock components.

NXJ-6472	1964-72 All .....	369.99 pr.
NXJ-7888	1978-88 All .....	369.99 pr.

*No Volume Discount. Not eligible for free shipping.*

NJ-394

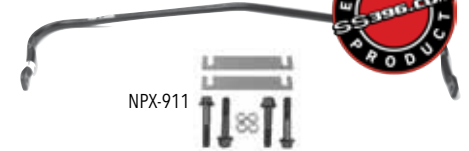

NPX-911



**Rear Sway Bar**

Correct size original rear sway bar for F41. Add our mounting kit with OEM bolts, nuts and GM style shims.

NJ-394	1964-72 All Sway Bar .....	134.95 ea.
NJ-394K	1964-72 All w/ Hardware .....	127.60 kit
NPX-911	1964-72 All Hardware Kit .....	16.95 kit
DSB-696	1978-88 1" Kit .....	149.95 kit
BSB-78G	1978-88 Shim .....	12.99 ea.

*No Volume Discount. Not eligible for free shipping.*

*Ships Oversized.*



DCK-1515



**Rear Sway Bar & Boxed Control Arms**

Complete kit to convert your stock rear end to the F-41 Heavy Duty option. Kit includes rear sway bar, boxed lower control arms and correct attaching kit.

DCK-1515	1964-72 All .....	289.70 kit
----------	-------------------	------------

*Ships Oversized. Not eligible for free shipping.*

*No Volume Discount.*



**Rear Suspension Kit Complete**

DRSK-1A

This F41 upgrade kit complete with rear sway bar with hardware, upper/lower boxed control arms and correct mounting bolts.

DRSK-2A	1964-67 All .....	527.14 kit
DRSK-1A	1968-72 All .....	527.14 kit

*Ships Oversized. Not eligible for free shipping.*

*No Volume Discount.*



DSB-12959

**Sway Bar Washers**

Correct washers used on the nut side so that the nuts do not dig into the arms.

DSB-12959	1964-72 (4 pc.) .....	11.99 kit
-----------	-----------------------	-----------



DSE042201



**DSE Tubular Rear Sway Bar Kit**

Unlike the factory A Body sway bar, DSE's rear sway bar attaches to the rear end housing and to the chassis crossmember as opposed to the stock lower control arm mounted bar. By using the chassis to stabilize the rear axle as opposed to the stock lower control arm, deflection is minimized as the car is placed under a heavy cornering load.

DSE042201	1964-72 All .....	403.99 kit
DSE042202	1973-77 All .....	403.99 kit
DSE042206	1978-88 All 1" Bar .....	369.99 kit
DSE042206	1978-88 All 1-1/8" Bar .....	369.99 kit

*Ships Oversized. Not eligible for free shipping. No Volume Discount.*



DSE041603



**DSE Rear Speed Kit 1**

Detroit Speed and Engineering's rear Speed Kits are designed to make your Chevelle maintain optimum geometry and tire contact through the full range of rear suspension travel. Through the use of DSE's patented Swivel Links, the rear end housing becomes fully articulated, without the use of noisy spherical heim joints. Speed Kit 1 contains:

- Swivel Link Rear Control Arms
- DSE Chassis Brace Kit

DSE041603	1964-67 All .....	1207.99 kit
DSE041604	1968-72 All .....	1168.99 kit

*\*Does not include chassis brace. Ships in Multiple Oversize Boxes. Not eligible for free shipping. No Volume Discount.*



DSE041609

**DSE Rear Speed Kit 2**

DSE's Speed Kit 2 includes everything in Speed Kit 1, but also gives you a DSE tubular rear sway bar which attaches to the chassis for a substantial improvement in cornering ability. Speed Kit 2 contains:

- Swivel Link Rear Control Arms
- DSE Chassis Brace Kit
- DSE Rear Coil Springs
- Koni Classic Shock Absorbers
- DSE Tubular Rear Sway Bar Kit

DSE041607	1964-66 All .....	2199.99 kit
DSE041609	1967 All .....	2199.99 kit
DSE041608	1968-72 All .....	2199.99 kit
DSE041610	1973-77 All .....	2028.99 kit
DSE043110	1978-88 All 2-3/7" Axle Tube .....	2049.99 kit
DSE043111	1978-88 All 3" Axle Tube .....	2049.99 kit

*Ships in Multiple Oversize Boxes. Not eligible for free shipping. No Volume Discount.*



DSE041611

**DSE Rear Speed Kit 3**

DSE's Speed Kit 3 is simply the best rear suspension available for a stock frame. This kit includes everything in Speed Kit 1 and Speed Kit 2.

Speed Kit 3 contains:

- Swivel Link Rear Control Arms
- DSE Specific Rear Coilover Shocks and Springs
- DSE Tubular Rear Sway Bar Kit
- DSE Chassis Brace Kit



DSE041611	1964-66 w/ Stock Axle .....	2932.99 kit
DSE041621	1964-66 w/ Moser Axle .....	2811.99 kit
DSE041613	1967 w/ Stock Axle .....	2932.99 kit
DSE041623	1967 w/ Moser Axle .....	2811.99 kit
DSE041612	1968-72 w/ Stock Axle .....	2811.99 kit
DSE041622	1968-72 w/ Moser Axle .....	2811.99 kit
DSE043120	1978-88 All 2-3/7" Axle Tube .....	2701.99 kit
DSE043121	1978-88 All 3" Axle Tube .....	2701.99 kit

*Ships in Multiple Oversize Boxes. Not eligible for free shipping.*

*No Volume Discount.*



DSE042106

**DSE Swivel Link Kit**

DSE's unique A/G Body rear trailing links incorporate our patented Swivel-Link™ system. These Swivel-Links™ eliminate bind and allow the suspension to fully articulate without the use of noisy spherical rod ends. Swivel-Link™ Rear Links allow for easy pinion angle adjustment for improved traction and lower driveline vibrations.

DSE042106	1973-77 All .....	986.99 kit
-----------	-------------------	------------

*Not eligible for free shipping. No Volume Discount.*



DSE042301

**DSE Chassis Brace Kit**

DSE's chassis brace kit offers substantial improvements over the original rear chassis braces. By triangulating the rear crossmember, frame rail and upper control arm mount, rear chassis deflection is reduced.

DSE042301	1964-72 All .....	299.99 pr.
-----------	-------------------	------------

*Designed as a bolt-in for cars originally equipped with chassis braces, but can be installed on cars without original chassis braces with minimal effort.*





**DSE Drop Coil Springs**

Give your Chevelle a modern pro touring stance while improving ride and handling with Detroit Speed and Engineering's new A-Body coil springs! These 2 inch dropped springs offer improvement in both ride and handling over soft factory coils.

<b>Front</b>	
DSE031115	1964-67 SB or LS ..... 235.99 pr.
DSE031118	1964-67 BB ..... 285.99 pr.
DSE031117	1968-72 SB or LS ..... 285.99 pr.
DSE031120	1968-72 BB ..... 285.99 pr.
DSE031123	1973-77 SB or LS ..... 285.99 pr.
DSE031124	1973-77 BB ..... 285.99 pr.
DSE031132	1978-88 SB ..... 215.99 pr.
<b>Rear</b>	
DSE041802	1964-66 All 1.5" Drop ..... 276.99 pr.
DSE041804	1967-72 All 1" Drop ..... 276.99 pr.
DSE041807	1973-77 All 1.5" Drop ..... 276.99 pr.
DSE041813	1978-88 All ..... 225.99 pr.

No Volume Discount.



**UMI Performance Springs**

UMI's springs are designed to add modern handling and a crisp ride while maintaining the factory muscle car appearance. They have a tough, black powder coat finish and UMI proudly manufactures these premium quality springs in the USA.

**Factory Height**

UMI-4048	1964-66 Front/Rear Kit ..... 329.99 kit
UMI-4049	1967-72 Front/Rear Kit ..... 329.99 kit
UMI-4049F	1964-72 Front Set ..... 149.99 pr.
UMI-4048R	1964-66 Rear Set ..... 189.99 pr.
UMI-4049R	1967-72 Rear Set ..... 189.99 pr.

**Lowering Springs**

UMI-4052	1964-66 Front/Rear Kit 1" Drop .... 299.99 kit
UMI-4053	1964-66 Front/Rear Kit 2" Drop .... 299.99 kit
UMI-4050	1967-72 Front/Rear Kit 1" Drop .... 299.99 kit
UMI-4051	1967-72 Front/Rear Kit 2" Drop .... 299.99 kit
UMI-3050	1978-88 Front/Rear 1" Drop ..... 299.99 kit
UMI-3051	1978-88 Front/Rear 2" Drop ..... 299.99 kit
UMI-4050F	1964-72 Front Set 1" Drop ..... 139.99 pr.
UMI-4051F	1964-72 Front Set 2" Drop ..... 139.99 pr.
UMI-3050F	1978-88 Front 1" Drop ..... 149.99 pr.
UMI-3051F	1978-88 Front 2" Drop ..... 149.99 pr.
UMI-4052R	1964-66 Rear Set 1" Drop ..... 189.99 pr.
UMI-4053R	1964-66 Rear Set 2" Drop ..... 189.99 pr.
UMI-4050R	1967-72 Rear Set 1" Drop ..... 189.99 pr.
UMI-4051R	1964-72 Rear Set 2" Drop ..... 189.99 pr.

No Volume Discount.



**Coil Springs**

Brand new OEM replacement coil springs sold in matched pairs. These are not cheap aftermarket springs. These springs will restore your car to the original ride height.

<b>Front</b>	
DCS-0060	1964-67 Chevelle SB w/o AC ..... 114.99 pr.
DCS-0160	1964-67 Chevelle SB w/ AC ..... 119.99 pr.
DCS-0160	1964-67 Chevelle BB w/o AC ..... 119.99 pr.
DCS-0160	1964-65 Chevelle BB w/ AC ..... 119.99 pr.
DCS-1160	1966-67 Chevelle BB w/ AC ..... 124.99 pr.
DCS-1168	1968-72 Chevelle SB w/o AC ..... 119.99 pr.
DCS-1169	1968-72 Chevelle SB w/ AC ..... 104.99 pr.
DCS-1169BB	1968-69 Chevelle BB w/o AC ..... 124.99 pr.
DCS-0360	1968-69 Chevelle BB w/ AC ..... 119.99 pr.
DCS-0360	1970-72 Chevelle BB w/o AC ..... 119.99 pr.
DCS-0360AC	1970-72 Chevelle BB w/ AC ..... 159.99 pr.
DCS-0160	1964-67 El Camino All SB/BB ..... 119.99 pr.
DCS-1168	1968-72 El Camino SB w/o AC ..... 119.99 pr.
DCS-1169	1968-72 El Camino SB w/ AC ..... 104.99 pr.
DCS-1169BB	1968-69 El Camino BB w/o AC ..... 124.99 pr.
DCS-5400	1968-72 El Camino BB w/ AC ..... 149.99 pr.
DCS-5600	1978-88 375lb Rate V6 Some V8 ..... 84.99 pr.
DCS-5606	1978-88 421lb Rate HD V8 ..... 99.99 pr.



**Rear**

DCS-6466	1964-66 Chevelle SB w/o AC ..... 84.99 pr.
DCS-6467	1964-66 Chevelle SB w/ AC ..... 99.99 pr.
DCS-6467	1964-66 Chevelle All BB ..... 99.99 pr.
DCS-0362	1967-72 Chevelle All SB ..... 99.99 pr.
DCS-67BB	1967 Chevelle All BB ..... 99.99 pr.
DCS-0362	1968-72 Chevelle All BB ..... 99.99 pr.
DCS-0362-HD	1967-72 Chevelle All Heavy Duty ... 119.99 pr.
DCS-6467	1964-66 El Camino All ..... 99.99 pr.
DCS-E539	1967-69 El Camino All BB Heavy Duty ..... 149.99 pr.
DCS-E413	1970-72 El Camino All Heavy Duty ..... 99.99 pr.
DCS-6321	1978-88 Monte Carlo ..... 79.99 pr.



DSI-205

DSI-370

**Coil Spring Insulators**

Correct rubber insulators for rear coil springs with embedded fiber material as original.

DSI-205	1964-66 All Rear ..... 36.99 pr.
DSI-370	1967-77 All Rear ..... 9.95 pr.
DSI-170	1964-88 All Front ..... 9.99 pr.



DSC-64A

BSB-64A

**Rear Coil Spring Clamp And Bolts**

DSC-64A	1964-66 Rear Coil Spring Clamps ..... 29.99 pr.
BSB-64A	1964-66 Rear Coil Spring Clamp Bolts ..... 10.99 pr.



DSE030306

**DSE Front Coilover Kit**

Detroit Speed and Engineering's Coilover Conversion Kit allows the latest in coilover spring and shock technology to be bolted to any A-Body, bringing handling and ride into the 21st century! Perfect for your stocker or protouring Chevelle!

DSE030306	1964-72 SB or LS ..... 1003.99 kit
DSE030307	1964-72 BB ..... 986.99 kit
DSE030310	1978-88 All ..... 1003.99 kit

No Volume Discount.

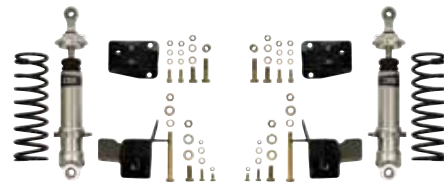

DSE042404

**DSE Rear Coilover Kit**

Detroit Speed and Engineering's A Body coilover conversion kit allows the latest in coilover spring and shock technology to be bolted on to any A Body, bringing your Chevelle's handling and ride into the 21st century! This package offers extensive ride height adjustability and DSE valving.

DSE042404	1964-66 All ..... 1351.99 kit
DSE042406	1967 All ..... 1351.99 kit
DSE042405	1968-72 All ..... 1351.99 kit
DSE042420	1978-88 All ..... 1268.99 kit

*Ships Oversized. Not eligible for free shipping.*

No Volume Discount.



AAS-300102

**Aldan American Coilover Kits**

Aldan Road Comp kits are designed to convert your suspension to coilovers. Aldan Phantom Series, single adjustable coilovers deliver superior handling and ride quality for a drastic improvement over stock suspension. Aldan high tensile, high travel coil-springs provide greater consistency over stock springs. Aldan's rear bolt-on shock absorber kit includes 2 TrueLine Series shocks, 2 brackets, 2 T-Bars and hardware. Uses OEM shock mounting locations. TrueLine adjustable shock absorbers are designed to work with factory and aftermarket springs to add a more consistent, smoother ride.

**Complete Front & Rear Kit with Rear Shock**

AAS-300168	1964-67 SB	1135.99 kit
AAS-300169	1964-67 BB	1135.99 kit
AAS-300170	1968-72 SB	1135.99 kit
AAS-300171	1968-72 BB	1135.99 kit
AAS-300110	1973-77 SB	1149.99 kit
AAS-300111	1973-77 BB	1149.99 kit

**Complete Front & Rear Kit with Rear Coilover**

AAS-300102	1964-67 SB	1549.99 kit
AAS-300103	1964-67 BB	1549.99 kit
AAS-300104	1968-72 SB	1549.99 kit
AAS-300105	1968-72 BB	1549.99 kit
AAS-300106	1978-88 SB	1559.99 kit
AAS-300107	1978-88 BB	1559.99 kit

**Front Coilover Kits**

AAS-ABFMS	1964-67 450lb Springs	640.99 kit
AAS-ABFHS	1964-67 550lb Springs	640.99 kit
AAS-AB2FMS	1968-72 450lb Springs	640.99 kit
AAS-AB2FHS	1968-72 550lb Springs	640.99 kit
AAS-AGFMS	1973-88 450lb Springs	640.99 kit
AAS-AGFHS	1973-88 550lb Springs	640.99 kit

**Rear Coilover Conversion Kits**

AAS-ABRLS	1964-72 120lb Springs Single Adjustable	909.99 kit
AAS-ABRMS	1964-72 140lb Springs Single Adjustable	909.99 kit
AAS-ABRHS	1964-72 160lb Springs Single Adjustable	909.99 kit
AAS-ABRNS	1964-72 No Springs Single Adjustable	774.99 kit
AAS-ABRLD	1964-72 120lb Springs Double Adjustable	1022.99 kit
AAS-ABRMD	1964-72 140lb Springs Double Adjustable	1022.99 kit
AAS-ABRHD	1964-72 160lb Springs Double Adjustable	1022.99 kit
AAS-ABRND	1964-72 No Springs Double Adjustable	888.99 kit
AAS-AGRLS	1978-88 120lb Springs Single Adjustable	919.99 kit
AAS-AGRMS	1978-88 140lb Springs Single Adjustable	919.99 kit
AAS-AGRHS	1978-88 160lb Springs Single Adjustable	919.99 kit
AAS-AGRNS	1978-88 No Springs Single Adjustable	770.99 kit
AAS-AGRDL	1978-88 120lb Springs Double Adjustable	1019.99 kit
AAS-AGRMD	1978-88 140lb Springs Double Adjustable	1019.99 kit
AAS-AGRHD	1978-88 160lb Springs Double Adjustable	1019.99 kit
AAS-AGRND	1978-88 No Springs Double Adjustable	806.99 kit

**Rear Shock Kits**

AAS-100110	1968-88 All	495.99 kit
------------	-------------	------------

No Volume Discount.



AAS-GSK-6872S



**Ground Up Motor Sports Exclusive Aldan Front Suspension Kits**

Ground Up Motor Sports's exclusive front suspension kit has the parts you need to upgrade your car's handling. We bundle together Ground Up Motor Sports's Tubular Front Control Arms and a set of Aldan American Coilovers in a specially discounted package. With Ground Up Motor Sports's exclusive front suspension kit, you'll be carving the corners in no time!

AAS-GSK-6872S	1968-72 Small Block	892.97 kit
AAS-GSK-6872B	1968-72 Big Block	892.97 kit

AAS-ALD-27



**Aldan American Tools**

Thrust bearings aka Torrington bearings make it easier to adjust spring tension and ride height when installed at the base of a coil spring and coilover spring seat. Includes 2 thrust bearings and 4 steel washers. 2.5 in. inner diameter, 3.225 in. outer diameter.

AAS-ALD-27	Bearings & Spanner Wrench	89.99 kit
AAS-ALD-26	Bearings Only	50.99 kit
AAS-ALD-1	Spanner Only	39.99 ea.

No Volume Discount.



KONI6477A

**Koni Front And Rear Shock Kits**

Are you looking for more performance from your shocks, and a smooth ride with improved ride and handling qualities? This Koni shock kit is the answer! Koni Classic shocks provide modern shock absorber technology for early muscle cars. Our kit includes: (2) front shocks, (2) rear shocks.

KONI6477A 1964-77 All ..... 543.96 kit  
*No Volume Discount.*



UMI-SS203052

**UMI Performance Shock And Spring Kits**

The UMI Performance Chevelle spring and shock kit is designed to provide a huge improvement in handling and control. These kits feature our race quality springs which provide a high performance foundation for your ride. Every component in this kit, as with all UMI products, is Made In USA.

UMI-SS203048 1964-66 Stock Height ..... 689.99 kit  
 UMI-SS203049 1967 Stock Height ..... 659.99 kit  
 UMI-SS103049 1968-72 Stock Height ..... 665.99 kit  
 UMI-SS203052 1964-66 1" Drop ..... 659.99 kit  
 UMI-SS203053 1964-66 2" Drop ..... 659.99 kit  
 UMI-SS203050 1967 1" Drop ..... 659.99 kit  
 UMI-SS203051 1967 2" Drop ..... 659.99 kit  
 UMI-SS103050 1968-72 1" Drop ..... 665.99 kit  
 UMI-SS103051 1968-72 2" Drop ..... 665.99 kit  
 UMI-SS103050G 1978-88 1" Drop ..... 665.99 kit  
 UMI-SS103051G 1978-88 2" Drop ..... 665.99 kit  
*Ships Oversize. No Volume Discount.*



**KYB Excel-G Shock Kit**

Are you looking for more performance from your shocks and a smooth ride? This KYB shock kit is the answer! They feature velocity sensing valving, hard chrome piston rods, twin tube design, low pressure nitrogen gas to prevent foaming of the oil, iron pistons & guide tubes. These shocks are great for normal to moderate driving! Our kit includes: (2) front shocks, (2) rear shocks and hardware.

KYB-64A-KIT 1964-67 All Front & Rear ..... 125.99 kit  
 KYB-68A-KIT 1968-77 All Front & Rear ..... 125.99 kit  
 KYB-64F 1964-67 Front Only ..... 40.99 ea.  
 KYB-68F 1968-77 Front Only ..... 42.99 ea.  
 KYB-64R 1964-67 Rear Only ..... 29.95 ea.  
 KYB-68R 1968-77 Rear Only ..... 34.99 ea.

*No Volume Discount.*



**GM Shock Kit**

Complete kit featuring 4 gas charged shocks, correct front & rear hardware, shock gray paint, & 4 shock ID decals.

DPX-440 1964-77 All ..... 145.58 kit  
 NT-2005 1964-77 Front Only ..... 29.99 ea.  
 NT-2201 1964-77 Rear Only ..... 29.99 ea.

*No Volume Discount.*



DSR-384

**Shock Mounting Hardware**

Correct GM rubber bushings, cup washer and nut for one shock.

DSR-384 1964-88 All Front ..... 7.95 kit



DR-041

**Shock Mounting Stud**

Correct rear shock mounting stud.

DR-041 1964-77 Rear ..... 11.99 ea.



BPX-9715-REAR



BPX-9715

**Shock Mounting Kit**

BPX-9715 1964-88 All Front ..... 8.99 kit  
 BPX-9715-REAR 1968-88 Rear Upper Shock Mounting Hardware ..... 8.95 kit



9-8101G

9-8101R

**Poly Upper Front Shock Bushings**

If you want to upgrade to a more durable upper shock bushing these are the way to go.

9-8101G 1964-88 All Black ..... 5.99 kit  
 9-8101R 1964-88 All Red ..... 5.99 kit

One pair does one shock. Two required per car.

# QA1

QA1-52722



QA1-52537



## QA1 Upper & Lower Tubular Control Arms

QA1's GM 2.0 Control Arms provide increased positive caster compared to OE arms, are among the lightest arms available featuring lower unsprung weight and improved performance without sacrificing durability. They include QA1's integrated ball joint design: stronger than OEM and rebuildable for tunability, providing long-term reliable service. These arms feature billet cross shafts for reduced weight and durability for the long haul. Double-shear lower mounts are coil-over ready for a clean installation. QA1 GM 2.0 Control Arms look incredible and use no unsightly additional adapters! Form meets function - these newly designed arms look and perform great and don't require painstaking restoring like factory stamped steel control arms. High strength, low alloy steel enables optimized thinner wall construction and results in overall lighter weight. QA1's integrated low-maintenance ball joints feature integrated ball joint dust boots, are stronger than competing ball joints, give long-term service and are rebuildable. QA1 GM 2.0 Control Arms will work with either OE or drop spindles. Increased positive caster design improves straight line stability. Mounts in OE location with no cutting, fabricating, or welding required. Accommodates either factory or aftermarket disc brakes. All of these arms are designed to add 3-4 degrees of caster and 0.5 to 1 degree of negative camber when used together (i.e. upper & lower). When used independently they will add approximately half of the preceding numbers. All parts sold in pairs and including mounting hardware. Made in the USA.

### Street Arms

QA1-52722	1964-72 All Upper .....	569.99 pr.
QA1-52737	1964-72 All Lower .....	786.99 pr.
QA1-52718	1973-77 All Upper .....	569.99 pr.
QA1-52720	1973-77 All Lower .....	786.99 pr.
QA1-52765	1978-88 All Upper .....	569.99 pr.
QA1-52764	1978-88 All Lower .....	786.99 pr.

### Pro-Touring Arms

QA1-52522	1964-72 All Upper .....	665.99 pr.
QA1-52537	1964-72 All Lower .....	848.99 pr.
QA1-52518	1973-77 All Upper .....	665.99 pr.
QA1-52520	1977-77 All Lower .....	848.99 pr.
QA1-52565	1978-88 All Upper .....	665.99 pr.
QA1-52564	1978-88 All Lower .....	848.99 pr.

No Volume Discount.

# QA1

QA1-5249



QA1-5204

## QA1 Rear Trailing Arms

All QA1 upper tubular and lower boxed trailing arms use polyurethane bushings on both ends, while upper adjustable and lower tubular trailing arms use a spherical ball or rod end assembly on the chassis end to eliminate bushing bind, allowing the suspension to move smoother for better control. This keeps the tires planted firmly on the ground for improved traction and a more predictable, better handling car. For a long-lasting finish, tubular and boxed trailing arms are powder coated gloss black, while the adjustable arms are zinc plated and anodized. Made in the USA.

QA1-5249	1964-67 All Upper Adjustable .....	336.99 pr.
QA1-5269	1964-67 All Upper Non-Adjustable .....	224.99 pr.
QA1-5248	1968-72 All Upper Adjustable .....	336.99 pr.
QA1-5268	1968-72 All Upper Non-Adjustable .....	224.99 pr.
QA1-5247	1973-88 All Upper Adjustable .....	336.99 pr.
QA1-5267	1973-88 All Upper Non-Adjustable .....	224.99 pr.
QA1-5205	1964-72 All Lower .....	336.99 pr.
QA1-5208	1973-77 All Lower .....	336.99 pr.
QA1-5204	1978-88 All Lower .....	336.99 pr.

No Volume Discount.



QA1-5284

## QA1 Frame Braces

QA1 Tubular Braces work with GM A-Body and G-Body trailing arms to reinforce the rear trailing arm mounts for major improvements in traction with less wheel hop and more power to the ground. Designed to clear stock and aftermarket mufflers. Made in the USA

QA1-5283	1964-67 All Adjustable .....	224.99 pr.
QA1-5212	1964-67 All Non-Adjustable .....	167.99 pr.
QA1-5284	1968-72 All Adjustable .....	224.99 pr.
QA1-5211	1968-72 All Non-Adjustable .....	167.99 pr.
QA1-5285	1978-88 All Adjustable .....	224.99 pr.
QA1-5210	1978-88 All Non-Adjustable .....	167.99 pr.

No Volume Discount.



QA1-5213

## QA1 Rear Anti-hop Bars

QA1 Rear Anti-Hop Bars relocate the upper trailing arms to change the instant center of the rear suspension. This will improve the chassis reaction and increases forward bite and traction. The QA1 Anti-Hop Bars are one of the most effective and easily installed traction improvements. Includes graphite/polyurethane bushings. Made in the USA.

QA1-5213	1965-72 All .....	273.99 pr.
QA1-5214	1978-88 All .....	273.99 pr.

No Volume Discount.



QA1-5252

## QA1 Tie Rod Sleeves

These QA1 Heavy Duty Tie Rod Sleeves are manufactured from solid steel hex stock then zinc plated for durable good looks and corrosion resistance. These are stronger than stock OE split sleeves and easier to adjust. Made in the USA.

QA1-5250	1964-72 1978-88 All .....	80.99 pr.
QA1-5252	1971-77 All .....	80.99 pr.

No Volume Discount.

# QA1



QA1-TN507

QA1-TN801

## QA1 Stocker Star Shocks

These stock mount adjustable front & rear shocks are available for your Chevelle. Available in double, single, Drag R Series and non-adjustable options, these shocks provide exactly the ride you want, high performance handling and great looks. These QA1 aluminum shocks are 100% dyno tested and serialized before leaving our factory. Made in the USA. Easy, bolt-in installation.

QA1-TN507	1964-67 Front Non-Adjustable .....	142.99 ea.
QA1-TS507	1964-67 Front Single Adjustable .....	190.99 ea.
QA1-TD507	1964-67 Front Double Adjustable .....	284.99 ea.
QA1-TR507	1964-67 Front Drag Series Adj .....	192.99 ea.
QA1-TN505	1968-88 Front Non-Adjustable .....	142.99 ea.
QA1-TS505	1968-88 Front Single Adjustable .....	190.99 ea.
QA1-TD505	1968-88 Front Double Adjustable .....	284.99 ea.
QA1-TR505	1968-88 Front Drag Series Adj .....	192.99 ea.
QA1-TN801	1968-88 Rear Non-Adjustable .....	142.99 ea.
QA1-TS801	1968-88 Rear Single Adjustable .....	190.99 ea.
QA1-TD801	1968-88 Rear Double Adjustable .....	284.99 ea.

No Volume Discount.

**QA1**

QA1-GR401-10500C



**QA1 Front Coilover Shock Kits**

The QA1 Pro Coil System is a great option for anyone looking for fully adjustable ride height and valving control. Choose a spring rate and adjust ability that fits your driving style, adjust the valving to match and you are on your way. These shocks also utilize a fully threaded body that allows you to adjust your ride height for the perfect stance or to finely tune the weight balance for superior handling. Specially designed for QA1's Pro Coil Systems, the American-made lightweight high travel springs have fewer coils and a smaller wire diameter, resulting in increased travel due to the larger distance between the coils. They reduce unsprung weight and react faster, optimizing suspension performance. Adjustable Pro Coil System Features: Available in MOD Series, independent compression and rebound double adjustable, simultaneous compression and rebound adjustable, or Drag R Series adjustable. Lightweight Billet Aluminum Coilover Shocks High Travel Springs Easy, Bolt-In Installation Ride Height Adjustable. Made in the USA

**Small Block Included spring rate: 400 Lbs, ideal for front axle weight between 1801-1900 Lbs.**

QA1-GS501-10400A	1964-67 Single Adjustable .....	665.99 kit
QA1-GD501-10400A	1964-67 Double Adjustable .....	866.99 kit
QA1-GR501-10400A	1964-67 Drag Series Adjustable .....	736.99 kit
QA1-MG501-10400A	1964-67 Mod Series .....	1800.99 kit
QA1-GS401-10400B	1968-72 Single Adjustable .....	665.99 kit
QA1-GD401-10400B	1968-72 Double Adjustable .....	866.99 kit
QA1-GR401-10400B	1968-72 Drag Series Adjustable .....	605.99 kit
QA1-MG401-10400B	1968-72 Mod Series .....	1800.99 kit
QA1-GS401-10550C	1973-77 Single Adjustable .....	665.99 kit
QA1-GD401-10550C	1973-77 Double Adjustable .....	866.99 kit
QA1-GR401-10550C	1973-77 Drag Series Adjustable .....	605.99 kit
QA1-MG401-10550C	1973-77 Mod Series .....	1800.99 kit
QA1-GS401-10400C	1978-88 Single Adjustable .....	665.99 kit
QA1-GD401-10400C	1978-88 Double Adjustable .....	866.99 kit
QA1-GR401-10400C	1978-88 Drag Series Adjustable .....	605.99 kit
QA1-MG401-10400C	1978-88 Mod Series .....	1800.99 kit

**Big Block Included spring rate: 500 Lbs, ideal for front axle weight between 2001-2100 Lbs.**

QA1-GS501-10500A	1964-67 Single Adjustable .....	665.99 kit
QA1-GD501-10500A	1964-67 Double Adjustable .....	866.99 kit
QA1-GR501-10500A	1964-67 Drag Series Adjustable .....	736.99 kit
QA1-MG501-10500A	1964-67 Mod Series .....	1800.99 kit
QA1-GS401-10500B	1968-72 Single Adjustable .....	665.99 kit
QA1-GD401-10500B	1968-72 Double Adjustable .....	866.99 kit
QA1-GR401-10500B	1968-72 Drag Series Adjustable .....	605.99 kit
QA1-MG401-10500B	1968-72 Mod Series .....	1800.99 kit
QA1-GS401-10650C	1973-77 Single Adjustable .....	665.99 kit
QA1-GD401-10650C	1973-77 Double Adjustable .....	866.99 kit
QA1-GR401-10650C	1973-77 Drag Series Adjustable .....	605.99 kit
QA1-MG401-10650C	1973-77 Mod Series .....	1800.99 kit
QA1-GS401-10500C	1978-88 Single Adjustable .....	665.99 kit
QA1-GD401-10500C	1978-88 Double Adjustable .....	866.99 kit
QA1-GR401-10500C	1978-88 Drag Series Adjustable .....	605.99 kit
QA1-MG401-10500C	1978-88 Mod Series .....	1800.99 kit

No Volume Discount.

**QA1 Sway Bars**

Give your chassis the stability it needs to keep your tires planted on the road. These sway bars are an easy bolt-on upgrade to help reduce body roll and handle corners better. For maximum strength and durability, QA1 sway bars are manufactured from either lightweight hollow-core (4130) chromoly steel or heavy duty solid-core (1045) cold formed steel. The bars are formed using precision CNC equipment for a true bolt-on installation, then gloss black powder coated for durability and corrosion resistance. Sway bars include new mounting components to replace old and worn out sway bar bushings and end links. Made in the USA.

QA1-52870	1964-72 All Front 1-1/4" .....	311.99 ea.	QA1-52894	1973-77 All Rear 1" .....	261.99 ea.
QA1-52893	1973-77 All Front 1-3/8" .....	324.99 ea.	QA1-52878	1978-88 All Rear 1" .....	261.99 ea.
QA1-52877	1978-88 All Front 1-3/8" .....	324.99 ea.	QA1-52873	1964-72 All Front & Rear 1-1/4"/1" .....	573.99 kit
QA1-52871	1964-72 All Rear 1" .....	261.99 ea.	QA1-52895	1973-77 All Front & Rear 1-3/8"/1" .....	585.99 kit
			QA1-52879	1978-88 All Front & Rear 1-3/8"/1" .....	585.99 kit

No Volume Discount.

**QA1**



**QA1 Rear Coilover Shock Kits**

QA1 bolt-in rear coilover conversion kits. These kits include specially designed USA made mounting brackets, single, double or MOD Series adjustable aluminum shocks, springs and all necessary hardware. Single adjustable shocks provide 18 positions of simultaneous rebound and compression adjustment while QA1's double adjustable shocks provide 18 positions of compression adjustment and 18 positions of rebound adjustment, for a total of 324 possible valving combinations. MOD Series shocks also feature a double adjustable design but include adjustable low-speed bleed as well for fully independent control over compression and rebound characteristics. These shocks also utilize a fully threaded body allowing for ride height adjust ability. Multiple spring rate options are also available, and have been successfully tested in various applications, from casual street driving to hardcore race applications. With our highly popular adjustable struts and the addition of the rear coilover conversion kit, you can now get a complete suspension makeover for both ends of the vehicle. Bolt-In installation. Made in the USA.

**Included spring rate: 130 Lbs, ideal for soft ride feel.**

QA1-RCK52339	1964-72 Single Adjustable .....	794.99 kit
QA1-RCK52335	1964-72 Double Adjustable .....	995.99 kit

**Included spring rate: 150 Lbs, ideal for medium ride feel.**

QA1-RCK52340	1964-72 Single Adjustable .....	794.99 kit
QA1-RCK52336	1964-72 Double Adjustable .....	995.99 kit

**Included spring rate: 170 Lbs, ideal for medium ride feel.**

QA1-RCK52341	1964-72 Single Adjustable .....	794.99 kit
QA1-RCK52337	1964-72 Double Adjustable .....	995.99 kit
QA1-RCK52375	1973-77 Single Adjustable .....	794.99 kit
QA1-RCK52371	1973-77 Double Adjustable .....	995.99 kit
QA1-RCK52351	1978-88 Single Adjustable .....	794.99 kit
QA1-RCK52355	1978-88 Double Adjustable .....	995.99 kit

**Included spring rate: 200 Lbs, ideal for firm ride feel.**

QA1-RCK52376	1973-77 Single Adjustable .....	794.99 kit
QA1-RCK52372	1973-77 Double Adjustable .....	995.99 kit
QA1-RCK52352	1973-77 Single Adjustable .....	794.99 kit
QA1-RCK52356	1973-77 Double Adjustable .....	995.99 kit

**Included spring rate: 220 Lbs, ideal for firm ride feel.**

QA1-RCK52377	1973-77 Single Adjustable .....	794.99 kit
QA1-RCK52373	1973-77 Double Adjustable .....	995.99 kit
QA1-RCK52353	1973-77 Single Adjustable .....	794.99 kit
QA1-RCK52357	1973-77 Double Adjustable .....	995.99 kit

No Volume Discount.

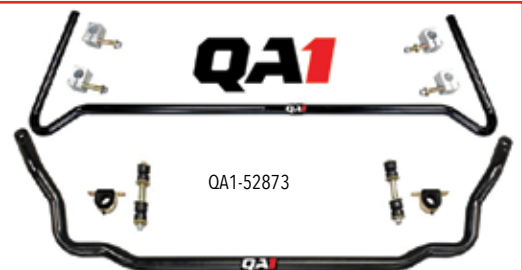



QA1-HK33-GMA3



QA1-HK23-GMA1



QA1-DK21-GMA1



QA1-HK32-GMA3



QA1-HK21-GMA1



QA1-DK22-GMA3

**QA1 Performance Handling Kits**

Want better handling for your classic? Turn to QA1's handling suspension kits for the best ride that fits your needs. Available in three different levels of performance, these handling kits offer easy, bolt-in installation and seamlessly works with whatever OE component each piece attaches to. You can build your car in stages using our parts list as a road map to get to the level of performance you want and have the peace of mind knowing you won't have compatibility issues.

**Level 1 Includes:** Front single adjustable Pro coil shock system, front & rear sway bars, tie rod adjuster sleeves, and rear lower boxed control arms.

**Level 2 Includes:** Front & rear single adjustable Pro coil shock system, front & rear sway bars, thrust bearing/spanner wrench kit, upper street control arms, lower street control arms, rear upper & lower tubular control arms, tubular rear control arm braces, tie rod adjuster sleeves.

**Level 3 Includes:** Front & rear double adjustable Pro coil shock system, front & rear sway bars, thrust bearing/spanner wrench kit, upper race control arms, lower race control arms, rear upper & lower boxed control arms, tubular rear control arm braces, tie rod adjuster sleeves. Level 2 & 3 kits available with and without shocks.



**Level 1 Kits**

QA1-HK21-GMA1	1964-67 w/ shocks.....	1949.99 kit
QA1-HK21-GMA2	1968-72 w/ shocks.....	1868.99 kit
QA1-HK21-GMA3	1973-77 w/ shocks.....	1962.99 kit
QA1-HK21-GMG1	1978-88 w/ shocks.....	1962.99 kit

**Level 2 Kits**

QA1-HK22-GMA1	1964-67 w/ shocks.....	4870.99 kit
QA1-HK32-GMA1	1964-67 w/o shocks.....	3007.99 kit
QA1-HK22-GMA2	1968-72 w/ shocks.....	4789.99 kit
QA1-HK32-GMA2	1968-72 w/o shocks.....	2925.99 kit
QA1-HK22-GMA3	1973-77 w/ shocks.....	4658.99 kit
QA1-HK32-GMA3	1973-77 w/o shocks.....	2795.99 kit
QA1-HK22-GMG1	1978-88 w/ shocks.....	4883.99 kit
QA1-HK32-GMG1	1978-88 w/o shocks.....	3020.99 kit

**Level 3 Kits**

QA1-HK23-GMA1	1964-67 w/ shocks.....	6995.99 kit
QA1-HK33-GMA1	1964-67 w/o shocks.....	3208.99 kit
QA1-HK23-GMA2	1968-72 w/ shocks.....	6914.99 kit
QA1-HK33-GMA2	1968-72 w/o shocks.....	2986.99 kit
QA1-HK23-GMA3	1973-77 w/ shocks.....	6783.99 kit
QA1-HK33-GMA3	1973-77 w/o shocks.....	3104.99 kit
QA1-HK23-GMG1	1978-88 w/ shocks.....	7008.99 kit
QA1-HK33-GMG1	1978-88 w/o shocks.....	3113.99 kit

*Kits that do not include shocks may not have thrust bearings or spanner wrenches included.*

*No volume discount.*

**QA1 Drag Race Suspension Kits**

Looking for a better launch, straight line stability and consistent performance? Turn to QA1's drag racing suspension kits for a full-vehicle upgrade that fits your needs. Available in two different levels of performance, these drag racing kits offer easy, bolt-in installation and seamlessly works with whatever OE component each piece attaches to.

**Level 1 Includes:** Front R series Stocker Star shocks, upper street control arms, lower street control arms, stock spring seat adapter, tie rod adjuster sleeves.

**Level 2 Includes:** Front Double Adjustable Pro Coil shock system, thrust bearing/spanner wrench kit, Upper race/pro-touring control arms, Lower race control arms, tie rod adjuster sleeves, ball joint tool kit. Available with and without shocks.

**Level 1 Kits**

QA1-DK21-GMA1	1964-67 w/ shocks.....	2411.99 kit
QA1-DK31-GMA1	1964-67 w/o shocks.....	1458.99 kit
QA1-DK21-GMA2	1968-72 w/ shocks.....	2330.99 kit
QA1-DK31-GMA2	1968-72 w/o shocks.....	1271.99 kit
QA1-DK21-GMA3	1973-77 w/ shocks.....	1968.99 kit
QA1-DK31-GMA3	1973-77 w/o shocks.....	1016.99 kit
QA1-DK21-GMG1	1978-88 w/ shocks.....	2411.99 kit
QA1-DK31-GMG1	1978-88 w/o shocks.....	1555.99 kit

**Level 2 Kits**

QA1-DK22-GMA1	1964-67 w/ shocks.....	5021.99 kit
QA1-DK32-GMA1	1964-67 w/o shocks.....	3157.99 kit
QA1-DK22-GMA2	1968-72 w/ shocks.....	4939.99 kit
QA1-DK32-GMA2	1968-72 w/o shocks.....	3076.99 kit
QA1-DK22-GMA3	1973-77 w/ shocks.....	4522.99 kit
QA1-DK32-GMA3	1973-77 w/o shocks.....	2658.99 kit
QA1-DK22-GMG1	1978-88 w/ shocks.....	5021.99 kit
QA1-DK32-GMG1	1978-88 w/o shocks.....	3157.99 kit

*No Volume Discount.*

**BUY'N SAVE  
WITH KITS**

**Power Steering Conversion Kit**

Finally, a complete kit to convert from manual to power steering is available! This kit contains all of the needed parts to convert to the external reservoir power steering system used exclusively on all 1965-68 Chevelle SS 396's! All components available separately. See following pages!

Pump Adjuster Bracket (AAP-5810).....	24.99 ea.
Pressure Hose (1965-67 3880584, 1968 3928204).....	39.95 ea.
Pump (APS-6094).....	199.99 ea.
Cradle Bracket (ASB-872).....	75.99 ea.
Pump Pulley (ASP-509).....	38.99 ea.
Driver Pulley (ADP-61).....	49.99 ea.
Return Hose Kit (NPX-16).....	21.99 kit
Reservoir Hose (CPX-1580).....	9.95 ea.
Reservoir Canister (1965-67 CPZ-1512, 1968 CPZ-1935).....	69.99 ea.
Reservoir Cap (CPZ-1510).....	49.99 ea.
Reservoir Bracket (1965-66 CPZ-1511, 1967-68 CPZ-678).....	29.99 ea.
All Hardware (CPZ-1513).....	22.95 kit
<i>Total Price of Ordering All Parts Individually.....</i>	<i>553.40</i>

PSKIT-S65	1965-66 Power Steering Kit.....	533.54 kit
PSKIT-S67	1967 Power Steering Kit.....	528.14 kit
PSKIT-S68	1968 Power Steering Kit.....	598.28 kit

*\*This kit does not include steering box, pitman arm or pulley nut.*



PSKIT-S68



PSKIT-70L

**Big Block Power Steering Conversion Kit 1969-72**

Are you tired of getting a workout every time you want to turn? Ground Up Motor Sports makes it easy to convert to power steering with this Chevelle power steering conversion kit! We have taken all of the guesswork out of selecting the parts to convert with this all in one solution! Includes: OEM Banjo Style Power Steering Pump, Pump Cap, Brackets, Hardware, Pulley, Pulley Nut, Pressure Hose, Return Hose.

PSKIT-69L	1969 BB w/o AC.....	368.82 kit
PSKIT-69LAC	1969 BB w/ AC.....	346.33 kit
PSKIT-70L	1970-72 BB w/o AC.....	377.78 kit
PSKIT-70LAC	1970-72 BB w/ AC.....	375.98 kit

*Note: For use with long water pump only. \*This kit is technically correct for 1970-1972 but can be used on any 1964-1972 Chevrolet with a big block and a long water pump.*



TUF-6193A

TUF-6193B

**Tuff Stuff Power Steering Pumps**

GM Saginaw style pumps feature all new components: reservoir, pump assembly, cap, dipstick and hardware when it applies. Rated at 1200 psi, rated to work with most gearbox systems.

TUF-6195A	1969 BB Chrome Banjo Style.....	253.99 ea.
TUF-6195B	1969 BB Black Banjo Style.....	219.99 ea.
TUF-6193A	1970 All Chrome Banjo Style.....	253.99 ea.
TUF-6193B	1970 All Black Banjo Style.....	201.99 ea.
TUF-6183A	1970-74 All Chrome.....	238.99 ea.
TUF-6183B	1970-74 All Black.....	188.99 ea.
TUF-5559	Universal Inline Filter.....	35.99 ea.

*No Volume Discount.*

**Power Steering Pumps Replacement**

Completely rebuilt second design power steering pumps. These pumps will differ in appearance from our originals, but will fit and function the same. No core charge!

**NO CORE CHARGE**

APS-6088R	1964-68 All SB.....	119.95 ea.
APS-6000R	1969 All BB.....	115.99 ea.
APS-6001R	1970-72 All.....	109.99 ea.

*No Volume Discount.*



**NO CORE CHARGE**



APS-6153

**Concourse Series "Banjo" Style Power Steering Pumps**

Brand New GM pumps with correct original style reservoirs. No core charge! Made in the USA!

APS-6088	1964-68 All SB.....	199.99 ea.
APS-6094	1965-68 All BB.....	199.99 ea.
APS-6153	1969 All SB.....	199.99 ea.
APS-6151	1969 All BB.....	219.99 ea.
APS-6165	1970-72 All*.....	199.99 ea.

*\*Use with 1970 hose & brackets. No Volume Discount.*



APS-6000R



ADR-077

**Power Steering Pump Cap**

Quality replacement power steering pump cap.

ADR-077	1964-77 All.....	8.95 ea.
---------	------------------	----------



APC-42

**OE Power Steering Pump Cap**

Reproduction metal cap.

APC-42	1964-77 All.....	19.95 ea.
--------	------------------	-----------



ASC-128

**Power Steering Hose Retaining Clip**

Correct clip for retaining hose to steering box.

ASC-128	All V8.....	12.95 ea.
---------	-------------	-----------



ADP-61

**1965-68 396 Driver Pulley**

Reproduction of the 1965-68 SS396 only power steering driver pulley. Fits inside crank pulley.

ADP-61 1965-68 BB Driver .....49.99 ea.



ASP-509

23-28

**Power Steering Pump Pulleys**

Reproduction power steering pulleys.

ASP-3847 1965-68 1 Groove SHP .....189.99 ea.  
 ASP-509 1962-72 1 Groove.....38.99 ea.  
 ASP-107 1969-72 2 Groove w/ AC .....36.99 ea.  
 ASP-1395 1969-72 1 Groove SHP .....59.99 ea.  
 23-28 Pulley Nut .....3.95 ea.



GCS-S8848

**Billet Power Steering Pulleys**

These show quality billet power steering pulleys will set your show car apart from the crowd. Made of high quality aircraft aluminum.

GCS-S8848 1 Groove, Satin .....42.99 ea.  
 GCS-S8848POL 1 Groove, Polished .....49.99 ea.  
 GCS-S8948 1 Groove, Chrome .....30.99 ea.  
 GCS-S8847 2 Groove, Satin .....54.99 ea.  
 GCS-S8847POL 2 Groove, Polished .....61.99 ea.  
 GCS-S8947 2 Groove, Chrome .....40.99 ea.



BSB-1970

**Power Steering Hardware Kits**

Our kits feature all correct hardware to attach power steering brackets to engine. A MUST!

CPZ-1513 1965-68 SS 396 .....22.95 kit  
 BSB-695B 1969-72 All SB .....22.99 kit  
 BSB-1969 1969 All BB .....22.99 kit  
 BSB-1970 1970-72 All BB .....12.95 kit



ASB-7KIT

**1970-72 Big Block Power Steering Bracket Kit**

Complete kit with cradle, adjustment brackets and hardware.

ASB-7KIT 1970-72 All BB ..... 107.04 kit

*Will work on most BB engines with long pump.*

*May need some modification.*



ASB-9KIT

**1969-72 Small Block Power Steering Bracket Kit**

Complete kit with all three brackets.

ASB-9KIT 1969-72 SB .....92.67 kit

**Power Steering Brackets**

Original style reproduction and original GM brackets.



ASB-383

ASB-383 1966-67 L-79 (2 pc.) .....44.99 kit



AQW-1418

AQW-1418 1969 All 396 (3 pc.)\* .....65.99 kit

\*Long water pump.



ASB-3941

ASB-3941 1969-72 All SB Cradle.....29.99 ea.



ASB-874

ASB-874 1969-72 SB Rear Support.....36.99 ea.



AAB-2610

AAB-2610 1969-72 SB Adjuster.....39.99 ea.



ASB-8072

ASB-8072 1964-68 all SB (Cradle) .....44.99 ea.a.



AAP-5910

AAP-5910 1964-68 SB Upper Adj. (to exhaust manifold).....29.95 ea.

\*will not work with headers



ASB-872

ASB-872 1965-68 All BB (Cradle).....75.99 ea.



AAP-5810

AAP-5810 1965-68 All BB (adj.).....24.99 ea.





ASB-422

ASB-422 1969-74 All BB Cradle .....77.99 ea.



ASB-931

ASB-931 1969-72 All BB (adjuster) .....27.99 ea.

### Power Steering OEM High Pressure Hose

New correctly bent OEM high pressure hoses with correct fittings.



CPX-6605

CPX-6605 1964-68 All SB .....24.95 ea.  
3880584 1964-67 All SS 396 BB.....39.95 ea.



3928204

3928204 1968 SS 396 .....39.95 ea.



CPX-6900

CPX-6900 1969 All SB .....24.95 ea.



CPX-6616

CPX-6616 1969 SS 396 .....26.95 ea.



CPX-6618

CPX-6618 1970-72 All .....26.95 ea.



ARK-68B

## BUY'N SAVE WITH KITS

### Power Steering Hose Kits

This kit comes with OEM high pressure hose, low pressure return tube, hose and correct clamps. Made in USA!

ARK-64A	1964-68 All SB	.....39.90 kit
ARK-65B	1965-67 SS 396	.....52.65 kit
ARK-68B	1968 SS 396	.....55.75 kit
ARK-69A	1969 All SB	.....42.25 kit
ARK-69B	1969 All BB	.....44.05 kit
ARK-70A	1970-72 All SB	.....44.05 kit
ARK-70B	1970-72 All BB	.....44.05 kit



NPX-16

### Power Steering Return Hose

Complete with correct pre bent flared tube, OEM hose and correct clamps.

NPX-16	1964-72 All V8	.....21.99 kit
CPS-038	OEM Return Hose	.....2.95 pr ft
CPN-512	OEM Clamps Screw Type	.....1.95 ea.



DSE091202

### DSE Power Steering Hose Kit

Includes fittings to convert your steering gear to -6 AN fittings. High quality stainless steel hoses are Teflon lined to handle the high pressure demands of the steering system. The hoses come with pre-cripped stainless steel fittings to attach to the -6 AN fittings at the steering gear. Each kit includes 30 inches of hose length that can be routed and cut to length at the pump end.

DSE091202	1964-72	.....215.99 kit
-----------	---------	-----------------

No Volume Discount.

CPZ-1512



### External Reservoir Canister

New correct large mouth external canister for your 1965-68 SS 396 with factory power steering!

CPZ-1512	1965-67 Can	.....99.99 ea.
CPZ-1935	1968 Can	.....69.99 ea.

CPZ-1510



### External Reservoir Canister Cap

Correct metal cap for reservoir canister.

CPZ-1510	1965-68 Cap	.....49.99 ea.
----------	-------------	----------------



CPZ-1511

CPZ-678

### External Reservoir Brackets

Correct brackets for holding the external reservoir to the inner fender.

CPZ-1511	1965-66	.....22.99 ea.
CPZ-678	1967-68	.....29.99 ea.

CPX-1580



### External Reservoir Hose

Correct hose that connects pump to canister.

CPX-1580	1965-68	.....9.95 ea.
----------	---------	---------------



BSB-759

### Steering Box Bolt

Complete with correct thick washer and bolt.

BSB-759	1964-72 All	.....6.99 ea.
---------	-------------	---------------

**BUY 'N SAVE**  
WITH KITS



GBK-1A



GBK-1SFA

**Power Steering Gear Box Kits**

Add on one of these awesome "close ratio" gear boxes to your conversion or on its own. These boxes are re-manufactured GM units and will add the ultimate handling to your ride. Our kit comes with steering box, steering coupler (rag joint) and correct attaching bolts. Choose from fast ratio or super fast ratio! Fits all 1964-76 Chevelle & El Camino! No core charge!

GBK-1A	3 - 3.5 Fast.....	399.81 kit
GBK-1XX	1964-76 All 3.25 Fast*.....	399.99 ea.
GBK-1SFA	2.5 Super Fast .....	370.96 kit

No Volume Discount. Ships UPS Oversized.

Not eligible for free shipping. \*Brand new not remanufactured. Box only, no bolts or rag joint.



ARC-12BK

**Manual Steering Gear Box Kits**

Add one of these newly rebuilt correct style standard ratio manual steering gearboxes, including the correct steering coupler/rag joint and steering box mounting bolts. These boxes are re-manufactured GM units. Our kits come complete with the box, rag joint and mounting bolts to the chassis. No core charge!

ARC-12AK	1964-69 Standard Ratio.....	333.82 kit
ARC-12BK	1970-72 Standard Ratio.....	333.82 kit
ARC-12SFK	1964-72 Super Fast Ratio .....	360.82 kit

No Volume Discount. Not eligible for free shipping.

**NO CORE CHARGE**

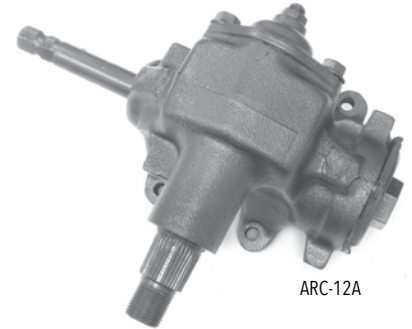

ARC-12A

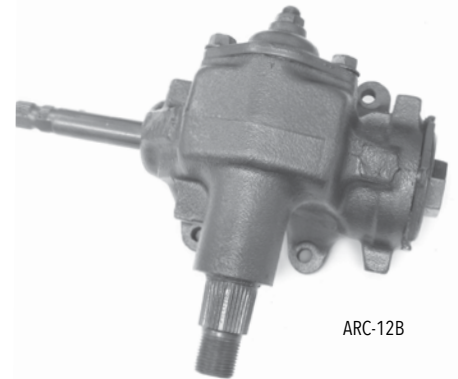

ARC-12B

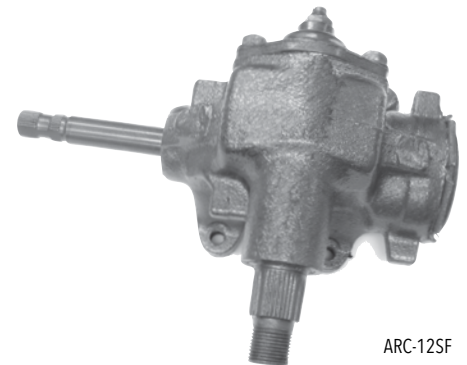

ARC-12SF

**Manual Gear Boxes**

Complete re-manufactured original Saginaw assemblies. No core charge .

ARC-12A	1964-69 24:1 Standard .....	299.99 ea.
ARC-12B	1970-72 24:1 Standard .....	299.99 ea.
ARC-12SF	1964-72 16:1 Quick .....	329.99 ea.

Use ATE-8869B coupler with ARC-12SF.

No Volume Discount.

DS-740-KIT



DS-740R-KIT



### 1964-1967 Chevelle Steering Linkage Kits

Sort out your steering and eliminate the guesswork with this convenient Ground Up Motor Sports kit. Each kit includes a matched power steering pitman arm, center drag link, idler arm, and pitman arm nut.

DS-740-KIT	1964-67 7/8" .....	204.19 kit
DS-740R-KIT	1964-67 13/16" .....	195.23 kit

No Volume Discount.

F-6859



BX-64K

### Pitman Arms

F-6467M	1964-67 7/8" M/S .....	49.99 ea.
F-6467	1964-67 7/8" P/S .....	49.99 ea.
F-6859M	1964, 1968-72 13/16" M/S .....	49.99 ea.
F-6859	1964, 1968-72 13/16" P/S .....	49.99 ea.
BX-64K	Nut w/ Washer Fits All .....	6.95 ea.



### Intermediate Steering Shaft

Restore proper steering stability and safety with this newly re-manufactured intermediate steering shaft. This shaft goes from the steering column down the steering box and wears out over time causing sloppy steering feel. This unit will fix that problem. This is a re-manufactured original GM unit that has been tested and painted.

IIS-68ASB	1968 SB .....	205.99 ea.
IIS-68ABB	1968 BB .....	308.99 ea.
IIS-69ASB	1969-72 SB .....	205.99 ea.
IIS-69ABB	1969-72 BB .....	308.99 ea.
DSB-83	1968-72 Upper Boot Only .....	34.99 ea.
ATE-6872T	1968-72 BB Lower Flange Only .....	49.99 ea.
IIS-78S	1978-88 All w/ Shroud .....	189.99 ea.
IIS-78	1978-88 All w/o Shroud .....	189.99 ea.

Note: BB features correct removable lower flange.  
No Volume Discount.



ATE-8869A



ATE-8871

### Steering Coupler

Complete joint for connecting column to box. 1964-68 with manual steering features fine spline and 1969-72 with manual steering features coarse spline.

ATE-8869A	1964-68 Manual .....	49.95 ea.
ATE-8869B	1969-72 Manual .....	49.95 ea.
ATE-8871	1964-72 Power .....	49.99 ea.



ATJ-411

### Steering Coupler Bolt

Correct OEM bolt for coupler.

ATJ-411	1964-72 All .....	5.99 ea.
---------	-------------------	----------



DSE090205

### Detroit Speed Rag Joint For 600 Steering Gear

Detroit Speed replacement rag joint with 3/4 in. -30 spline coupling to be used with the DSE 600 series steering gear and your stock 1964-1972 Chevelle column. It comes complete with a clinch bolt.

DSE090205	1964-72 .....	49.99 ea.
-----------	---------------	-----------



DSE091202

### Detroit Speed Power Steering Hose Kit For 600 Steering Gear

This Detroit Speed and Engineering power steering hose kit includes fittings to convert your steering gear to -6 AN fittings. High quality stainless steel hoses are Teflon lined to handle the high pressure demands of the steering system. The hoses come with pre-primed stainless steel fittings to attach to the -6 AN fittings at the steering gear. Each kit includes 30 inches of hose length that can be routed and cut to length at the pump end.

DSE091202	1964-72 .....	215.99 kit
-----------	---------------	------------

*Ships Oversize. No Volume Discount.*

SHIFTKIT-350



**BUY'N SAVE**  
WITH KITS

**Console Shifter Kit**

Complete kit to convert to an automatic console shifter. Kit includes factory style staple shifter, cable, brackets, & all correct hardware.

SHIFTKIT-350	1968-72 TH350.....	242.03 kit
SHIFTKIT-400	1968-72 TH400.....	246.53 kit



**Staple Shifter**

Complete staple shifter assembly with chrome plated handle, spring loaded lock out trigger and mounting base. Ready to install.

ISSFT-1	1968-72 Console Shifter.....	165.99 ea.
ISH-3X	1968-72 Handle Only.....	70.99 ea.

No Volume Discount.



ISSFT-1

ISSFT-HRDW



**Staple Shifter Repair Kit**

All the hardware needed to bring a worn out staple shifter back to life.

ISSFT-HRDW	1968-72 ALL .....	32.99 kit
------------	-------------------	-----------

No Volume Discount.

SW-DT3



**Ratchet Shifter Detent**

Converts your factory shifter to a ratchet type shifter. Simple installation.

SW-DT3	1968-72 Powerglide, TH350, TH400.....	110.99 ea.
SW-DT4	1968-72 700-R4, 200-4R, 4L60, 4L65, 4L80 .....	117.99 ea.



IE-667



ISC-667

**Automatic Shifter**

Brand new shifter assembly including base, shift handle, shift arm and lever, rubber grommets and clips! Ready to install.

ISC-667	1966-67 Automatic .....	199.99 ea.
IE-667	1966-67 Boot On Shifter .....	19.99 ea.
ISH-667A	1966-67 Handle PG Trans Only .....	59.95 ea.
ISC-667-200R-700	Overdrive .....	199.99 ea.

No Volume Discount.



SC2041

**4 Speed Overdrive Kits**

This kit makes it easy to install a modern overdrive automatic in place of your old Powerglide, TH350 or TH400 for improved performance and gas mileage. Each kit includes a new laser cut and hardened detent, indicator plate, hardware and brackets to allow the use of your factory shifter. This kit works with a TH700, TH200 or 4L60 transmission.

SC2041	1964-65 All .....	119.99 kit
SC2042	1966-67 All .....	119.99 kit
SC2242	1968-70 All .....	107.99 kit
SC2243	1971-72 All .....	107.99 kit



FTH-973R

**Shifter Cables**

Original GM or high quality reproduction shifter cables for floor mounted TH shifter.

FTH-973R	1968-72 Repro.....	32.99 ea.
FTH-88G	1982-88 G-Body Shifter Cable .....	44.99 ea.
SCG-7883	1978-88 Cable Grommet.....	24.99 ea.

EBC-22

**Shifter Cable Clip**

Correct clip for mounting cable.

EBC-22	Mounting Clip.....	3.99 ea.
--------	--------------------	----------

FTH-049

**Shifter Cable Mounting Clip**

Correct push-on clip which mounts to shifter.

FTH-049	Push-on Clip (to shifter) .....	7.99 ea.
---------	---------------------------------	----------

## G/FORCE PERFORMANCE PRODUCTS



### GForce Transmission Crossmembers

When you need extra exhaust clearance or just want to make your car handle better, these crossmembers are for you!

FCM-RCAE	1964-67 Coupe TH350, Muncie, PowerGlide, T10, Saginaw.....	339.99 ea.
FCM-RCAE-4	1964-67 Coupe TH200R4, TH700R4, Muncie, TH400 Short Tail.....	339.99 ea.
FCM-RCAEC1	1964-67 Convertible TH350, Muncie, PowerGlide, T10, Saginaw.....	359.99 ea.
FCM-RCAEC1-400	1964-67 Convertible TH200R4, Muncie, TH400 Short Tail.....	359.99 ea.
FCM-RCAE	1968-72 Coupe TH200R4, Muncie, TH350, TH400 Short Tail.....	339.99 ea.
FCM-RCAE-4	1968-72 Coupe 4L80E, 4L85E.....	339.99 ea.
FCM-RCAEC2	1968-72 Convertible TH200R4, Muncie, TH350, TH400 Short Tail.....	359.99 ea.
FCM-RCAEC2-4L80	1968-72 Convertible 4L80E, 4L85E.....	359.99 ea.
FCM-RCG-350	1978-88 TH350.....	285.99 ea.
FCM-RCG-400K	1978-83 TH200R4 TH400 Short Tail.....	344.99 ea.
FCM-RCG-400	1984-88 TH200R4 TH400 Short Tail.....	285.99 ea.
FCM-RCG-700	1978-88 TH700R4 4L60E.....	285.99 ea.
FCM-RCG-4L80K	1978-83 4L60E 6L80E.....	397.99 ea.
FCM-RCG-4L80	1984-88 4L60E 6L80E.....	339.99 ea.
FCM-RCG-T56K	1978-83 T56 6 Speed.....	397.99 ea.
FCM-RCG-T56	1984-88 T56 6 Speed.....	339.99 ea.

No Volume Discount.

**DIRECT FIT**



FTB-13433

### Column Shift Transmission Bracket

Correct column shift transmission bracket which mounts on all column shift GM cars from 1969-1977.

FTB-13433	1969-77.....	16.99 ea.
-----------	--------------	-----------

FCB-222



FCB-322

### Shifter Cable Lever Brackets

Correct cable lever brackets which mount to transmission.

FCB-322	1964-71 1st Design.....	19.99 ea.
FCB-222	1972-77 2nd Design.....	24.99 ea.



FCM-88N



BPC-7000

### Transmission Crossmember

Reproduction crossmembers for mounting your transmission.

FCM-88N	1968-72 TH350/4 Speed.....	149.99 ea.
BPC-7000	1968-72 Mounting Bolts (16 pc.).....	6.95 kit



FTH-050

### Shifter Cable Stud

Correct cable stud which mounts to bracket.

FTH-050	Mounting Stud (to bracket).....	11.99 ea.
---------	---------------------------------	-----------

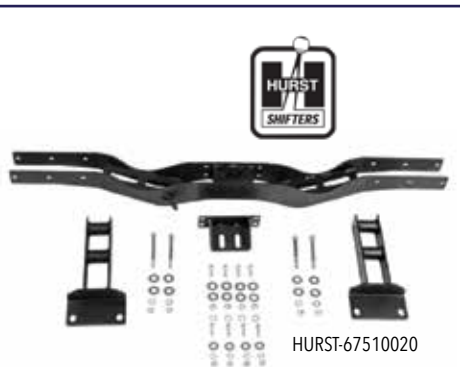

HURST-67510020

### Hurst Transmission Swap Crossmembers

These ultra-trick Hurst transmission crossmembers have painstakingly been designed and fabricated from thick steel plate and heavy gauge steel tubing for a perfect fit and finish that has no equal. These bolt-in units are much stronger than the factory stock crossmembers and help maintain the correct transmission and driveshaft angle. Precision cut and fully MIG-welded, then given a durable black powder coating finish to last a lifetime and give you peace of mind knowing you're buying the best parts available for your Tremec TKO 5-Speed or Magnum 6-Speed conversions. You can surely trust the company that originally started out making conversion mounts back in 1958, Hurst Performance.

HURST-67510020	68-72 Magnum 6, TKO 5-6, TH350,400,700R4.....	516.99 ea.
HURST-67510018	78-88 Magnum 6, TKO 5-6, Speed.....	470.99 ea.
HURST-67510019	78-83 Magnum 6 Speed Adapter Kit*.....	164.99 ea.

No Volume Discount. \*Adapter only. Crossmember not included.

NTR-235



### Transmission Mounts

NPG-100	1964-72 Powerglide.....	11.95 ea.
NTR-235	1964-72 TH350/Manual.....	13.95 ea.
NTR-225	1964-72 TH400.....	13.95 ea.
BTE-7939	Mounting Bolt.....	0.95 ea.



FCB-220



FCB-1210

### Cable Mounting Bracket

Correct bracket for mounting cable to transmission.

FCB-1210	1968-72 TH350.....	16.99 ea.
FCB-220	1968-72 TH400.....	21.99 ea.
FCB-193	1974-75 TH400.....	35.99 ea.



3-1108G

### Poly Graphite Transmission Mount

Poly graphite mounts outlast OEM mounts and are also able to absorb most driveline vibrations.

3-1108G	1964-88 All Black.....	39.99 ea.
3-1108R	1964-88 All Red.....	39.99 ea.



ACC-8555



ATE-2101

### Kickdown

Correct kickdown switch for TH400.

ATE-2101	1970-72 TH400 Switch.....	39.99 ea.
ACC-8555	1970-72 Switch Bracket.....	19.95 ea.
ATE-2101K	1970-72 TH400 Switch Bracket Kit.....	54.99 kit
06145	1966-67 TH400 Harness.....	38.99 ea.
11980	1968-69 TH400 Harness.....	39.99 ea.
17565	1971-72 TH400 Harness.....	28.99 ea.



S530



S531

### Kickdown Cable & Bracket

Correct kickdown cable and bracket for cars with a TH350 transmission.

S530KIT	All Cable & Bracket Kit.....	36.85 kit
S530	All Cable.....	20.95 ea.
S531	All Bracket.....	20.99 ea.



FCH-64A



**Clutch Linkage Kit**

If you're looking to freshen up your original linkage but don't need the pedals, this is perfect!

FCH-64A	1964-66 SB.....	175.16 kit
FCH-64B	1964-66 BB.....	175.16 kit
FCH-67A	1967 All SB.....	161.67 kit
FCH-67B	1967 All BB.....	161.67 kit
FCH-68	1968-72 All.....	184.27 kit

No Volume Discount.



FMCK-68

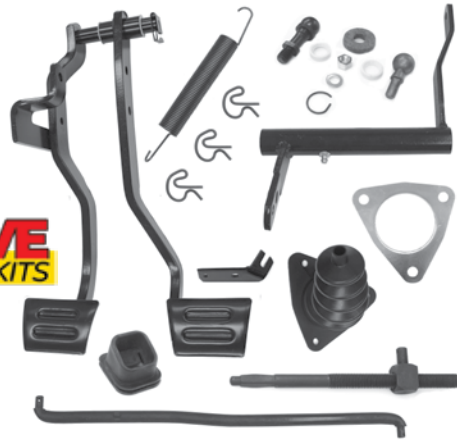

**Manual Transmission Conversion Kit**

Planning on swapping from automatic to a 4 speed manual? This kit will take the headache out of the switch by providing you with all the parts needed to make your conversion simple! This complete kit includes the brake/clutch pedals, Z bar, rods, boots, cross shaft kit, springs, bracket and all hardware!

FMCK-64SB	1964-66 All SB.....	250.42 kit
FMCK-64BB	1964-66 All BB.....	250.42 kit
FMCK-67ASB	1967 All SB.....	250.42 kit
FMCK-67ABB	1967 All BB.....	250.42 kit
FMCK-68	1968-72 All V8.....	268.37 kit
FMCK-78G	1978-88 All.....	612.99 kit

No Volume Discount.

**BUY 'N SAVE**  
WITH KITS

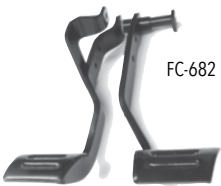

FC-682



FCI-88A

**Clutch & Brake Pedal Assemblies**

Complete reproduction brake/clutch pedals.

FC-646	1964-66 All.....	99.99 ea.
FC-67	1967 All.....	99.99 ea.
FC-682	1968-72 All.....	110.99 ea.
FCI-88A	1967-72 Auto Brake Pedal.....	50.99 ea.
IBP-628	1964-77 Auto Pedal Pivot Pin.....	17.99 ea.
FC-78K	1978-88 Manual Brake & Clutch.....	269.99 ea.
FC-78C	1978-88 Clutch Pedal Only.....	137.99 ea.
FC-78B	1978-88 Brake Pedal Only.....	137.99 ea.
FPS-6816	1978-88 Pivot Sleeve*.....	10.99 ea.
FBC-799	Booster Rod Clip.....	9.99 ea.

\* One required for automatic transmissions and two for manual.



NT-391A

**Back Drive Components**

Correct bracket, spring, nylon bushing and mounting bolts that mount to the driver's side frame rail. Provides a pivot point for the automatic on the column shift linkage.

NT-391A	1969-72 Complete Kit.....	29.99 kit
NT-2833	1969-72 Bracket Only.....	16.99 ea.
NT-69BU	1969-72 Bushing Only.....	5.99 ea.
FB-69SP	1969-72 Back Drive Spring.....	5.95 ea.
RBS-6781	1967-77 All Column Arm Grommet.....	9.99 ea.

FPB-97



FPB-103

**Clutch Pedal Bushing & Bumper**

Correct nylon bushing used for ease of pedal.

FPB-97	All Bushing.....	2.99 ea.
FPB-103	All Bumper.....	3.99 ea.
FPS-6810	1978-88 Pedal Bump Stop.....	17.99 ea.



GCS-S5047

**Transmission Cooler Hose Kit**

These flexible braided stainless steel transmission cooler hoses fit either single or dual pass cooler set ups. Includes fittings.

GCS-S5047	All.....	123.99 kit
-----------	----------	------------

48" hose length.



FDT-350

**Dipstick & Tubes**

GM replacement dipstick and tubes.

FDT-350	TH350 Tube.....	24.99 ea.
FDT-350K	TH350 Tube & Stick Set.....	22.99 kit
FDT-400	TH400 Tube.....	33.99 ea.
FDT-400K	TH400 Tube & Stick Set.....	22.99 kit
FDS-3	TH350 Stick.....	9.95 ea.
FDS-4	TH400 Stick.....	9.95 ea.

FDS-3



**Transmission Cooler Lines**

New reproduction transmission cooling lines with flared ends and correct nuts.

		OM	SS
CTC6401	1964-65 Powerglide.....	54.99 ea.	90.99 ea.
CTC6601	1966-67 TH350/TH400.....	54.99 ea.	90.99 ea.
CTC6801	1968-72 Powerglide.....	54.99 ea.	90.99 ea.
CTC6703	1968-72 TH350.....	54.99 ea.	90.99 ea.
CTC6705	1968-72 TH400.....	54.99 ea.	90.99 ea.

*Ships Oversize. Not eligible for free shipping.*



CTV6701

**Transmission Vacuum Lines**

New reproduction transmission vacuum lines with flared ends and correct nuts.

		OM	SS
CTV6401	1964 Powerglide V8.....	35.99 ea.	47.99 ea.
CTV6402	1964 Powerglide 6 cyl.....	35.99 ea.	47.99 ea.
CTV6501	1965 Powerglide.....	35.99 ea.	47.99 ea.
CTV6605	1966 396/360 hp TH400.....	35.99 ea.	47.99 ea.
CTV6703	1967-68 TH350 LH Mod.....	35.99 ea.	47.99 ea.
CTV6701	1967-69 Powerglide.....	35.99 ea.	47.99 ea.
CTV6705	1967-69 TH400.....	35.99 ea.	47.99 ea.
CTV6903	1969-72 TH350 RH Mod.....	35.99 ea.	47.99 ea.
CTV7101	1970-72 TH400.....	35.99 ea.	47.99 ea.

*Ships Oversize. Not eligible for free shipping.*



### 621 Bellhousing Kit

Complete kit with reproduction "621" bellhousing, clutch fork, fork boot, throwout bearing, bolts and inspection cover. Fits cars with 11" clutch.

FBH-621SUPERKIT	Complete Kit .....	340.88 kit
FBH-621K	Bellhousing and Cover .....	212.26 kit
FBH-621	Bellhousing Only .....	179.99 ea.

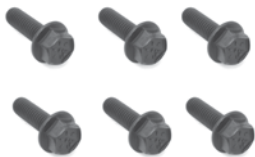

BPB-9021

### Bellhousing Hardware

BPB-9021	Bellhousing to Block (6 pc.) .....	8.95 kit
BTE-307	Bellhousing to Trans 4 Speed (4 pc.)...	8.95 kit

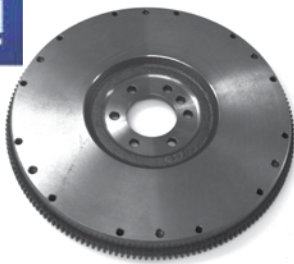

FFW-11

### Flywheels

Original GM flywheels.

FFW-105	10.5" w/o 454 .....	279.99 ea.
HAYS-10-010	168t 57-85 SBC 65-70 BBC* .....	121.99 ea.
HAYS-10-020	168t SBC 70-90 BBC** .....	114.99 ea.

\*Internally balanced. \*\*Externally balanced.

### 12 Piece Bolts

BPB-5116	1964-72 Flywheel to Crank 4 Speed .....	19.99 kit
BPB-5118	1964-72 Flex Plate to Crank Auto .....	18.99 kit
BPP-8386	1964-72 Flywheel to Pressure Plate .....	9.99 kit

No Volume Discount.

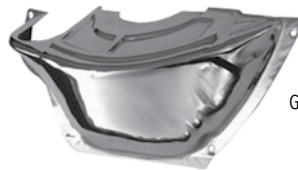

GCS-S9417

### Custom Flywheel Inspection Covers

Looks great on any show car!

GCS-S9417	PG Chrome .....	29.99 ea.
GCS-S8607	TH350/TH400 Polished .....	57.99 ea.
GCS-S9588	TH350/TH400 Chrome .....	31.99 ea.
GCS-S9587	TH700-R4 Chrome .....	31.99 ea.



FCK-258

### Heavy Duty Clutch Kits

All HD clutch kits include clutch disc, pressure plate, throwout bearing, pilot bushing, alignment tool and grease pack.

FCK-258	11" 10 Spline BB .....	189.99 kit
FCK-260	11" 26 Spline BB .....	189.99 kit
FCK-105	10.5" 10 Spline SB .....	199.95 kit
FCK-108	10.5" 26 Spline SB .....	199.95 kit

No Volume Discount.



NE-810



FTE-3943

### Flywheel Inspection Covers

OE style reproduction flywheel covers.

FTE-3943	1964-72 Manual 11" .....	24.95 ea.
NK-4497	1964-72 Manual 10.5" .....	26.99 ea.
NJ-088	All Powerglide .....	31.99 ea.
NE-810	All TH350 .....	34.95 ea.
NJ-089	All TH400 .....	137.99 ea.
BFW-506K	Attaching Bolts (4 pc.) .....	1.95 kit



FPB-ROLLER



FPB-667

### Pilot Bushing

New input shaft bushing that goes into the crankshaft.

FPB-667	1964-77 All Brass .....	14.99 ea.
FPB-ROLLER	1964-77 All Roller .....	26.99 ea.

FTO-641



### Throwout Bearing

Original OEM style throwout bearing.

FTO-641	1964-77 All .....	44.95 ea.
---------	-------------------	-----------



FTE-9000-ADJ



FTE-9000

### Clutch Fork Ball

Original GM clutch fork mounting/pivot ball for inside the bellhousing. We also now offer adjustable pivot ball for after market pressure plates where alignment can be an issue.

FTE-9000	1964-77 All .....	16.99 ea.
FTE-9000-ADJ	1964-77 Adjustable .....	29.99 ea.

FV-1511



FV-1521



### Firewall Boot Retainer

FV-1511	1964-67 All .....	14.99 ea.
FV-1521	1968-72 All .....	14.99 ea.



FW-54



FW-35



FW-68



FRC-100

### Clutch Firewall Rods

FW-54	1964-66 All .....	29.95 ea.
FW-35	1967 All .....	29.95 ea.
FW-68	1968-72 All .....	30.99 ea.
FW-78G	1978-88 All .....	66.99 ea.
FRC-100	Attaching Clip .....	1.99 ea.



FSS-5021



FSS-5053

### Firewall Rod Boots

OE style reproduction rubber boots for firewall.

FSS-5021	1964-67 All .....	11.95 ea.
FSS-5053	1968-72 All .....	14.95 ea.
FSS-78G	1978-88 All .....	29.99 ea.



**Hays Manual Clutches**

**Hays Street 450** single disc kits are an excellent upgrade offering up to 30% more holding power over your stock clutch, designed to handle stock and mildly modified engines up to 450 horsepower. This is a great clutch where drivability is the most important factor along with a stock pedal feel.



HAYS-92-1003

HAYS-91-1003	10.5" 26 Spline .....	363.99 kit
HAYS-91-1002	10.5" 10 Spline .....	358.99 kit
HAYS-91-1004	11" 10 Spline .....	371.99 kit
HAYS-91-1005	11" 26 Spline .....	371.99 kit

**Hays Street 650** single disc kits are designed to handle highly modified naturally aspirated engines up to 650 horsepower. Designed as a true street/strip clutch for spirited high performance driving or frequent track use.

HAYS-92-1003	10.5" 26 Spline .....	717.99 kit
HAYS-92-1002	10.5" 10 Spline .....	690.99 kit
HAYS-92-1004	11" 10 Spline .....	735.99 kit
HAYS-92-1005	11" 26 Spline .....	728.99 kit

No Volume Discount.



HAYS-10-010

**Hays Automatic Flexplate**

Hays heavy duty Flexplate for high performance competition Chevy engines are constructed of a thicker than stock steel plate. This enables them to withstand the stress of high-stall torque converters and high-RPM engines. These flexplates are supplied with a ring gear that is securely welded in place and feature a dual bolt pattern for use with a Powerglide or Turbo style torque converter.

HAYS-10-010	168t 57-85 SBC 65-70 BBC* .....	121.99 ea.
HAYS-10-020	168t SBC 70-90 BBC** .....	114.99 ea.

\*Internally balanced. \*\*Externally balanced.  
No Volume Discount.



BM-20230

**B&M Automatic Flexplate**

Heavy duty flexplate for extreme racing or street applications. SFI certified for NHRA & IHRA.

BM-20230	55-85 168t SBC up to 1991 BBC....	140.99 ea.
BM-20232	55-85 168t SBC 400 .....	150.99 ea.
BM-20233	55-85 168t SBC 454 .....	137.99 ea.
BM-20232	55-85 153t SBC .....	150.99 ea.

\*Except SBC 400 and BBC 454. No Volume Discount.



LW-15000LKW



FKW-11LW



FKW-4999

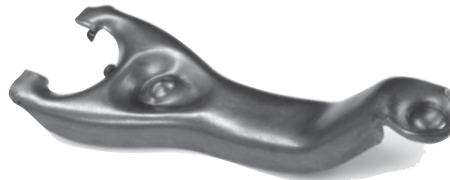

FEH-397

**Lakewood Bellhousing**

The Lakewood 15000LKW bellhousing connects Chevy small and big block engines to transmissions utilizing the standard GM pattern such as the Muncie, Saginaw, Borg Warner T10 and Tremec TKO transmissions. This bellhousing is hydro formed to fit '58-'87 GM full and midsize cars, 67-81 F-body vehicles and 68-79 Novas. This bellhousing is S.F.I. 6.1 certified which is required by many sanctioning bodies for cars running 11.49 or faster in the quarter mile. The Lakewood 15000 comes complete with engine block plate and Grade 8 mounting hardware.

LW-15000LKW	1964-1977 SBC, BBC .....	656.99 ea.
FEH-397	1964-72 All Resto Clutch Fork .....	70.99 ea.
FKW-4999	1964-75 All Clutch Fork Boot .....	9.99 ea.
FKW-11LW	1964-1977 All Clutch Fork Boot .....	38.99 ea.
FTE-9000-ADJ	1964-1972 All Adjustable Clutch Fork Ball .....	29.99 ea.

No Volume Discount.



HOL-319-575

**LS Clutch And Flywheel Kit**

This Kit includes all the hardware and components needed for a complete clutch install on a 6-bolt crank LS engine using a T-56 transmission. A 12-inch organic disc with 6 spring helix sprung hub provides superior grip needed for the strip, while the matched diaphragm style pressure plate provides a pedal feel comfortable enough for the street. This provides 30 percent more clamping pressure and transmits that through a billet steel flywheel.

HOL-319-575 All w/ 6 Bolt Crank LS & T56 ..... 899.99 kit  
No volume discount.





**GM Restoration Parts**

FEH-397

**Clutch Fork**

New GM style clutch fork.

FEH-397	1964-72 All Resto .....	70.99 ea.
---------	-------------------------	-----------



FB-564

FB-566

**Clutch Frame Brackets**

Correct bracket for mounting Z bar to frame.

FB-564	1964-67 All .....	13.95 ea.
FB-566	1968-72 All .....	18.95 ea.
FB-78G	1978-88 All .....	36.99 ea.
BFB-605	Attaching Bolt.....	0.75 ea.



FKW-209

FCE-0681

**Clutch Adjustment Rod Kits**

FKW-209	1964-67 All V8 .....	25.99 kit
FCE-0681	1968-72 All V8 .....	20.99 kit
FCE-738	All V8 Extra Long 7 3/8" .....	19.99 ea.
FRC-100	Attaching Clip.....	1.99 ea.



FKW-4999

**Clutch Fork Boot**

Original clutch fork dust boot.

FKW-4999	1964-75 All .....	9.99 ea.
----------	-------------------	----------



FRB-172

**Clutch Pedal Push Rod Bushing**

This injection molded plastic bushing installs on the clutch pedal and retains the clutch push rod.

FRB-172	1973-75 .....	1.99 ea.
---------	---------------	----------



FZ-3525



FZ-3520



FRZ-19

**Clutch Z Bar**

Reproduction "zerk" bar.

FZ-3525	1964-67 SB .....	32.95 ea.
FZ-3520	1964-67 BB .....	32.95 ea.
FRZ-19	1968-72 All .....	49.99 ea.
FZ-78G	1978-88 All .....	147.99 ea.

FPX-828



**Clutch Cross Shaft Kit**

Original GM stud balls, nylon seats, protective felts, retaining clips, nuts and washers.

FPX-828	1964-72 .....	29.95 kit
FPX-6568	Block Ball Only .....	13.95 ea.
FPX-5289	Frame Ball Only .....	23.99 ea.
FPX-3349	Plastic Seat Only.....	3.99 ea.
FPX-3360	Ball Felt .....	14.99 ea.
FPX-0696	Retaining Clip .....	2.99 ea.
FPX-33K	Cross Shaft Seat & Seal Kit.....	38.20 kit

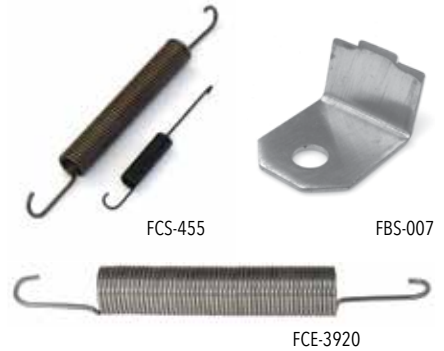

FCS-455

FBS-007

FCE-3920

**Clutch Return Springs**

Original return springs for clutch fork, etc.

FCS-455	1966-67 All .....	17.95 pr.
FBS-007	1966-67 Firewall Bracket .....	14.95 ea.
FCE-3920	1968-72 All .....	6.99 ea.
FCS-78G	1978-88 All .....	15.99 ea.



FHB-64

**Muncie - Hurst Adapter**

This handy bracket allows you to bolt up your original Muncie shifter handle to a Hurst shifter. The original Muncie handle featured a top mount design while the Hurst handle features a side mount design. The Hurst design is much stronger. Once your shifter boot is on, no one will know it isn't stock!

FHB-64	1964-67 .....	69.99 ea.
--------	---------------	-----------

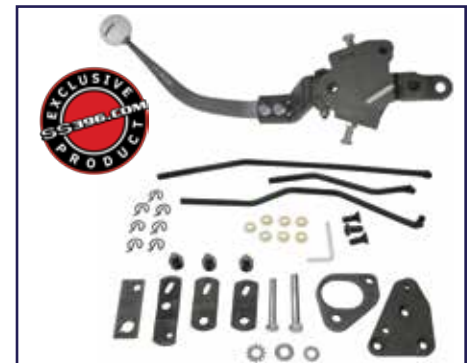

**Hurst Shifter & Installation Kit**

This complete Hurst Competition Plus shifter and linkage kit includes a famous Hurst Competition Plus shifter, chrome Hurst shifter handle and white shifter ball with 4 speed pattern as well as a complete Hurst installation kit with all rods, levers, swivels and hardware. This kit will provide you with that vintage muscle car look as well as provide reliable shifts every time!

HURST-KITA64M	1964-67 Muncie .....	715.41 kit
HURST-KITA68M	1968 Muncie .....	715.41 kit
HURST-KITA69M	1969-72 Muncie .....	715.41 kit

*Part Notes: Please verify that the year of your transmission matches the year of your car before ordering. 1964 to 1968 Muncie 4-speed transmissions can be identified from later models by the way the transmission arms attach. Early Muncie side covers had a stud and the shift arm attached with a nut on the stud while the 1969 and later model side covers had a hole and the shift arms attached with a bolt.*

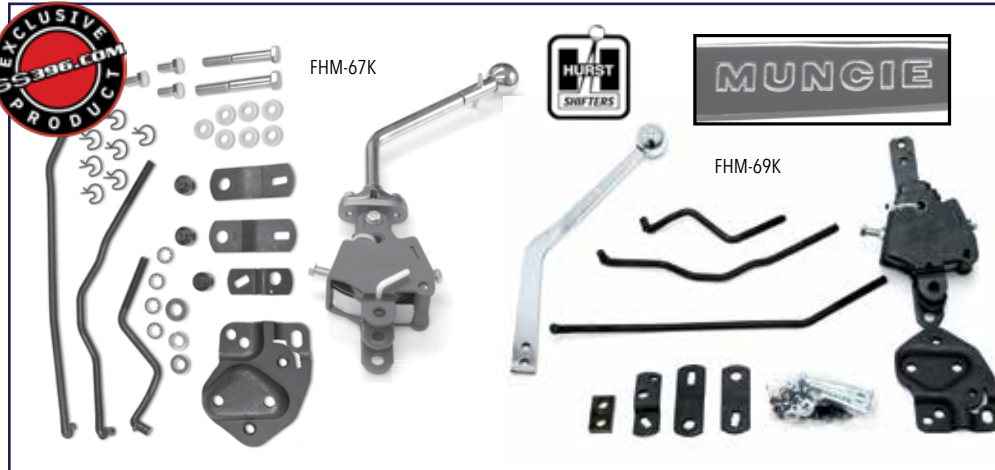

**Hurst/Muncie Shifter Kit**

This Ground Up Motor Sports exclusive Hurst/Muncie shifter kit allows you to keep an original style Muncie shifter handle and mate it to a Hurst shifter and linkage. Original Muncie shifters performed very poorly, so we created this exclusive kit to keep your car looking original while utilizing the strength and reliability of a bullet proof Hurst Competition Plus shifter. Everything under the shifter handle is covered by your shifter boot so no one will be able to tell it isn't stock.

FHM-64	All 1964-67 w/ Bench.....	787.43 kit
FHM-64K	All 1964-66 w/ Buckets .....	817.16 kit
FHM-67K	All 1967 w/ Buckets.....	817.16 kit
FHM-68K	All 1968 w/ Console and/or Buckets .....	808.13 kit
FHM-68	All 1968 w/ Bench .....	803.63 kit
FHM-69K	All 1969-72 w/ Console and/or Buckets .....	808.13 kit
FHM-69	All 1969-72 w/ Bench.....	803.63 kit

*No Volume Discount.*



NT-390



**Reverse Lockout Kit**

Complete with 2 rods and swivel mechanism.

NT-390	1969-72 w/ Muncie .....	119.99 kit
--------	-------------------------	------------



3737834



**Hurst Installation Kits**

Complete kit with rods, levers, swivels and hardware.

3733163	1964-67 w/ Muncie .....	261.99 kit
3734297	1966-67 w/ Saginaw.....	272.99 kit
3733163	1968 w/ Muncie.....	261.99 kit
3737919	1968-72 w/ Saginaw.....	274.99 kit
3737834	1969-72 w/ Muncie .....	261.99 kit
3737897	1973-74 w/ Muncie .....	306.99 kit

*No Volume Discount.*



**Shifter Balls**

Reproduction shifter balls.

FZ-1300	1964-67 White Bench.....	42.99 ea.
FZ-1400	1964-67 Chrome .....	22.99 ea.
FZ-1420	1968-72 White 5/16".....	23.99 ea.
FZ-1424	1968-72 White 3/8".....	23.99 ea.
FW-38HURST	White 3/8" 4 Speed Hurst Logo ....	38.99 ea.
FW-115	Chrome 5/16".....	27.99 ea.
FW-117	Chrome 3/8" .....	23.99 ea.
FW-157	Black/Chrome 5/16".....	22.99 ea.
FW-159	Black/Chrome 3/8".....	23.99 ea.



3917308



**Hurst Shifters**

New Hurst Competition Plus shifter complete with Hurst handle and shifter ball.

3917308	1964-67 w/ Muncie .....	493.99 ea.
3917307	1966-67 w/ Saginaw.....	493.99 ea.
3918014	1968-72 w/ Muncie .....	493.99 ea.
3916848	1973-74 w/ Muncie .....	493.99 ea.
3918794	1978-79 w/ Saginaw.....	493.99 kit

*No Volume Discount.*



**Billet Shifter Handles**

These billet aluminum shifter handles from Clayton Machine work with any Hurst or Tremec, TK500 TKO600 2 bolt shifter mount and are a great finishing touch for your custom ride! Available in three styles: Basic black anodized, truss style with gray powder coat, truss style adjustable gray powder coat. Shift knob not included. Requires knob with 3/8-16" thread. Same as most Hurst knobs.

SH-203-8	8" Black Anno 30 Degree Kick Back .....	234.99 ea.
SH-203-10	10" Black Anno 30 Degree Kick Back .....	241.99 ea.
SH-202-8	8" Gray PC Truss Style 30 Degree Kick Back .....	184.99 ea.
SH-202-10	10" Gray PC Truss Style 30 Degree Kick Back.....	191.99 ea.
SH-204-10	10" Gray PC Truss Style Adjustable Kick Back.....	316.99 ea.

*No Volume Discount.*

FRZ-1498



FRZ-5134



Detail

**1964-72 Muncie Shifter Handles**

OE style reproduction chrome shifter handles.

FRZ-5134	1964-67 Bench.....	99.95 ea.
FRZ-5133	1964-66 Buckets.....	109.99 ea.
FRZ-5131	1967 Buckets.....	109.99 ea.
FSH-1498	1968-72 w/o Console .....	89.99 ea.
FSH-1499	1968-72 w/ Console .....	89.99 ea.



BM-80675



BM-80706



BM-80690



BM-80840

**B&M Automatic Floor Shifters**

From the originator of high performance manual shifters our line of performance, street and racing shifters for automatic transmissions won't let you down. With classic good looks and proven mechanical designs giving choices of either positive ratcheting actions or gated racing shifters, provide positive shifts guaranteeing you won't miss a shift when it counts.

**Starshifter**

Features include NHRA/ IHRA reverse lockout, backup light switch, neutral safety switch, polished T-handle. Cable operated for quick installation and accurate shifting.

BM-80675 All 2&3 Speed ..... 284.99 ea.

**Megashifter**

The B&M Megashifter has it all, form, function and classic style. This all adds up to bring you a quality shifter that's been one of the most popular automatic shifters of all time. First off let's talk function. The Megashifter's positive ratcheting function won't allow you to over shift and miss a gear at that critical moment, along with the reverse lockout feature meets NHRA/IHRA safety rules for those weekend grudge races at the track. The look and feel of the T-handle and accordion style shift boot really shows off the racing heritage of the Megashifter.

BM-80690 All 2,3,4 Speed ..... 456.99 ea.

**Quicksilver**

The B&M Quicksilver features a ratcheting action for positive shifts, chrome knob, neutral safety switch, NHRA/IHRA approved reverse lockout.

BM-80683 All 2,3,4 Speed ..... 413.99 ea.

**Hammer**

The Hammer shifter may just be the most comfortable and versatile shifter available. The unique design of the shift handle easily fits all sizes of hands providing the best wrist angle and feel when shifting.

BM-80885 All 2,3,4 Speed ..... 314.99 ea.

**Pro Stick**

The Original Pro Stick shifter delivers rock-solid performance, mixed with clean design cues and compact size. This is why you see so many Pro Stick shifters at the race track.

BM-80706 All 2,3,4 Speed ..... 403.99 ea.

**Stealth Magnum Pro Stick**

The Stealth Magnum Grip Pro Stick shifter delivers rock-solid performance, mixed with clean design cues and compact size.

BM-81052 All 2,3,4 Speed ..... 384.99 ea.

**Pro Ratchet**

The Pro Ratchet shifter is one of our most popular and easiest to operate race shifters. Features include a positive ratcheting design that self-centers the handle after each shift giving you maximum clearance behind the shifter and won't allow you to miss a shift by over-shifting a gear. This versatile shifter will operate both forward and reverse shift patterns.

BM-80840 All Silver 2 Speed Powerglide ..... 406.99 ea.

BM-80842 All Silver 3,4 Speed\* ..... 406.99 ea.

BM-80843 All Carbon 3,4 Speed\* ..... 409.99 ea.

BM-81120 All Stealth 3,4 Speed\* ..... 507.99 ea.

\*May require PRNDL switch for some applications. No Volume Discount.



HURST-3838530



HURST-3160001



**Hurst Automatic Shifters**

From the originator of high performance manual shifters, is our line of performance street and racing shifters for automatic transmissions that won't let you down. With classic good looks and proven mechanical designs giving choices of either positive ratcheting actions, or gated racing shifters providing positive shifts guaranteeing you won't miss a shift when it counts.

**Pro-Matic 2**

Ratchet-action shifter with its chrome-plated stick and black knob is quality engineered for years of precise, trouble-free operation. Once the shifter is installed, the textured console and brilliant top cover that can be trimmed to fit any floor contour integrates the shifter with the interior.

HURST-3838500 All 3 Speed ..... 389.99 ea.

**V-Matic 3 Shifter**

Designed with a park and reverse lock trigger actuating system that allows smooth and flawless ratcheting through the forward gears.

HURST-3838530 All 3 & 4 Speed ..... 453.99 ea.

**Quarter Stick**

The Quarter Stick shifter provides positive gear change control for both street and race applications. Its compact size fits easily in racecars with limited space and is very lightweight at only 2.5 pounds. Features include black oxide coated steel construction, 1018 hardened steel gate plate, forged aluminum shift stick with 7/16-20 tpi and a classic white Hurst shift knob.

HURST-3160001 All 2 Speed\* ..... 391.99 ea.

HURST-3160006 All 3 Speed\*\* ..... 391.99 ea.

HURST-3160020 All 3 Speed\* ..... 394.99 ea.

\*Reverse valve body. \*\*Forward valve body.



FW-HURST

**Hurst T Handle Shifter Knob**

This brushed aluminum t-handle provides a positive feel for accurate gear selection. A favorite in the performance world for years! Includes adapters for most popular shift handles.

FW-HURST T-Handle ..... 45.99 ea.



HURST-5389020



HURST-5389023

**Hurst Billet Shifter Handles**

This is a great way to add a contemporary performance look to your muscle car. Billet Aluminum construction is precision CNC machined for a modern look and feel. Fits classic Hurst shifters with a 2 bolt pattern.

- HURST-5389020 6" Straight ..... 101.99 ea.
- HURST-5389021 8" Straight ..... 116.99 ea.
- HURST-5389022 10" Straight ..... 132.99 ea.
- HURST-5389023 6" Lay Back ..... 116.99 ea.
- HURST-5389024 8" Lay Back ..... 132.99 ea.
- HURST-5389025 10" Lay Back ..... 159.99 ea.

No Volume Discount.



ICE-HURST



ICE-INDY

**Hurst Shifter Boots**

Brand new injection molded boots.

- ICE-HURST Universal ..... 74.99 ea.
- ICE-INDY Universal Indy Shift Boot ..... 34.99 ea.



IT-1360K



**BUY'N SAVE WITH KITS**

**Boot & Retainer Kit**

Buy a correct shift boot and retainer for your 1968-72 Chevelle with console and save!!!

IT-1360K 1968-72 w/ Console ..... 34.83 kit



IT-1311



IT-1405



IT-1360



NT-196

**Shift Boot Retainers**

Correct die stamped steel boot retainers.

- IT-1311 1964-66 All ..... 19.99 ea.
- IT-1405 1966-67 Console ..... 39.99 ea.
- IT-1360 1968-72 Console ..... 20.99 ea.
- NT-196 1968-72 w/o Console (2 pc.) ..... 89.99 ea.
- IT-3954 1978-88 w/o Console ..... 34.99 ea.



IM-780



IE-384



ICE-5405



ICE-5356



IE-390

**Shifter Boots**

Brand new injection molded boots.

- IM-780 1964-65 Console Upper ..... 11.99 ea.
- IE-384 1964-67 Lower Console ..... 19.99 ea.
- IE-384 1964-66 w/o Console ..... 19.99 ea.
- IE-390 1966-67 Upper Console ..... 20.99 ea.
- ICE-5356 1968-72 w/ Console ..... 19.99 ea.
- ICE-5405 1968-72 w/o Console ..... 19.99 ea.
- IE-4010 1978-88 w/o Console ..... 52.99 ea.



HURST-5000023



HURST-5008555



HURST-5000029



**Hurst Shifter Cables**

These premium quality cables feature a solid 303 stainless steel inner wire core encased within a nylon liner wrapped with helical lay wires and swaged ends for superior strength. The core is lubricated with Teflon prior to assembly and then sealed in a heavy plastic outer casing for a lifetime of durability and smooth operation.

Single eyelet on one end and threaded on the other end.

- HURST-5000023 3 Feet ..... 88.99 ea.
- HURST-5000025 5 Feet ..... 83.99 ea.
- HURST-5000028 8 Feet ..... 109.99 ea.

Single eyelet on one end and threaded on the other end. For Pro-Matic & V-Matic shifters

- HURST-5008555 5 Feet ..... 80.99 ea.

Eyelets on both ends for quarter stick.

- HURST-5000029 5 Feet ..... 94.99 ea.

No Volume Discount.



FCC-201

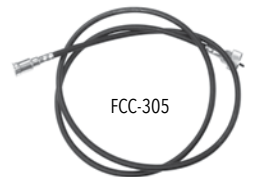

FCC-305

**Speedometer Cables**

New complete cables with casings and correct ends ready to install.

1964-68 Cables came with screw on fittings on both ends. 1969 and up cables had a screw end on the transmission and a clip on end on the speedometer. Check your speedometer fitting and length before ordering.

- FCC-201 1964-68 64" LH (Screw on both) ..... 19.99 ea.
- FCC-203 1964-68 83" RH (Screw on both) ..... 19.99 ea.
- FCC-202 1969-77 100" (Clip on speedo end) ..... 18.95 ea.
- FCC-205 1969-77 80" (Clip on speedo end) ..... 19.99 ea.
- FCC-305 1969-77 61" (Clip on speedo end) ..... 19.99 ea.
- FCC-309 1969-77 41" (Clip on speedo end) ..... 18.95 ea.
- FSG-22 1964-72 Grommet ..... 7.95 ea.
- FSG-78G 1978-88 All Grommet ..... 15.99 ea.

Note: Longer cables are for cars with passenger side screw ins on transmission.



GNS-13



GNS-35

GDR-411

**Neutral Safety Switch**

Correct steering column switch for proper engine and reverse light activation.

GNS-13	1964-66 PG Column .....	22.99 ea.
GNS-23	1965-66 TH Column .....	21.99 ea.
GNS-696	1967 Auto Console .....	69.99 ea.
GNS-33	1969-72 Manual.....	52.99 ea.
GDR-411	1968-72 Auto Console.....	34.99 ea.
GNS-35	1969-73 Auto Column .....	21.99 ea.



GNS-2248



GNS-1588

**Neutral Start Switch**

Correct safety switch located at pedal which prevents your car from being started in gear.

GNS-2248	1969 4 Speed .....	74.99 ea.
GNS-1588	1970 4 Speed .....	59.99 ea.
GNS-1589	1971-72 4 Speed .....	79.99 ea.



1993661



1993307

**Reverse Lamp Switch**

Correct switch assembly for activating reverse lamps.

1993661	1964 All Manual .....	69.99 ea.
1993307	1965-68 All Manual.....	69.99 ea.



19240



10665

**Reverse Switch Extension Harness**

Correct harness which plugs into firewall.

05100	1964 All Manual .....	28.99 ea.
19240	1965 All Manual .....	28.99 ea.
10665	1966-68 All Manual.....	31.99 ea.



FHB-13653

**Speedometer Cable Clip**

Bolts to the bottom of the transmission tail shaft bolt to keep the speedometer cable from hanging down.

FHB-13653	1970-79 4 Speed.....	14.99 ea.
-----------	----------------------	-----------



BM-70264



**B&M Transmission Coolers & Kits**

B&M Super Coolers are 100% aluminum stacked plate style core which is ideal for additional transmission cooling. With oven brazed construction this sturdy cooler design is practically impervious to flying rocks or other debris.

**Small**

BM-70265	All 7,500 BTU Polished .....	124.99 ea.
BM-70273	All 15,000 BTU Black.....	112.99 ea.

**Medium**

BM-70268	All 13,000 BTU Black.....	114.99 kit
BM-70266	All 20,500 BTU Black.....	154.99 ea.
BM-70272	All 20,500 BTU Polished .....	210.99 ea.

**Large**

BM-70264	All 14,400 BTU Black.....	136.99 kit
BM-70274	All 29,200 BTU Black.....	186.99 ea.

No Volume Discount.



BM-70298

**B&M Hi-Tek Cooling Systems**

Hi-Tek Super Coolers are fitted with a high quality 12 Volt electric fans and built-in mounting brackets which makes it ideal for maximum cooling. Suitable for many fluids including ATF, Engine Oil, Differential Oil and power steering fluid.

BM-70298	All 350 CFM Black .....	413.99 ea.
BM-70297	All 590 CFM Black .....	456.99 ea.

No Volume Discount.



BM-20248



**B&M Governor Recalibration Kit**

This kit allows you to adjust the shift points of your transmission after it is installed in your vehicle. The Governor Recalibration Kit is very useful if you have a vehicle that is very light; has a low rear-end gear ratio.

BM-20248	55-85 TH350, TH400, TH700R4..	101.99 kit
----------	-------------------------------	------------

No Volume Discount.



Muncie M20, M21, M22 TH350, TH400

**Transmission Speedometer Gears**

These are the correct speedometer driven gears which go inside the transmission case. Please compare the gear you have to what you are ordering as the color or tooth count may vary from original. We do not have an application chart for these so if changing axle ratios or tire size please consult various online resources.

**Muncie M20, M21, M22, Saginaw 3 & 4 Speed and Powerglide**

FR-158RB	17 Tooth Purple	16.95 ea.
FR-158RD	18 Tooth Brown	16.95 ea.
FR-158RF	19 Tooth Natural	16.95 ea.
FR-158RH	20 Tooth Blue	16.95 ea.
FR-158RK	21 Tooth Red	16.95 ea.
FR-158RM	22 Tooth Gray	16.95 ea.
FR-158RS	23 Tooth Black	16.95 ea.
FR-158RV	24 Tooth Orange	16.95 ea.

**TH350, TH375, TH400, TH475**

FR-158SD	36 Tooth White	16.95 ea.
FR-158SF	37 Tooth Red	19.95 ea.
FR-158SH	38 Tooth Blue	16.95 ea.
FR-158SM	40 Tooth Black	16.95 ea.
FR-158SP	41 Tooth Yellow	16.95 ea.
FR-158SS	42 Tooth Green	16.95 ea.
FR-158SV	43 Tooth Purple	16.95 ea.
FR-158SX	44 Tooth Dark Gray	16.95 ea.
FR-158SZ	45 Tooth Light Green	16.95 ea.
FR-RETAINER	1964-88 All w/ Large Gear	6.99 ea.



BM-30229

**B&M Transpak, Transkit & Master Overhaul Kits**

**B&M Transpak** has all the features in the Shift Improver Kit, plus it provides additional driver manual control. Retain full automatic features and standard shift points with selector in Drive.

BM-30228	1968-81 TH350	121.99 ea.
----------	---------------	------------

**B&M Transkits** give you the same high-quality components that are used in all B&M Street and Strip transmissions. They also include special directions on how to modify your case, pump, and components.

BM-30229	1968-81 TH350	349.99 ea.
----------	---------------	------------

**B&M Master Racing** overhaul kits are supplied with all of the gaskets, seals, bushings, and friction material required for a complete high performance or racing trans overhaul.

BM-21042	1968-81 TH350	297.99 kit
BM-21041	1968-81 TH400	322.99 kit

No Volume Discount.

**REVSKIT-64**

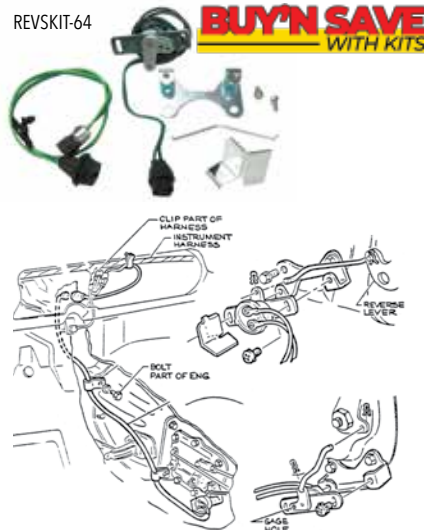

**BUY 'N SAVE WITH KITS**

**Reverse Switch Kit**

This kit includes all components needed for a complete installation: switch, extension harness, bracket, shield and rod.

REVSKIT-64	1965-66 All Manual	136.77 kit
REVSKIT-65	1965 All Manual	136.77 kit
REVSKIT-668	1967-68 All Manual	139.47 kit

No Volume Discount.



39504

**Reverse Switch Mounting Kit**

Complete with bracket, shield, rod, clips and hardware for mounting the reverse switch.

39504	1964-68 Manual	52.99 kit
GRB-342	1964-68 All Bracket Only	14.95 ea.
GWT-17	Shield	9.95 ea.
GRR-58	Rod w/ Clips	17.95 ea.



REVSKIT-UNI

**Universal Reverse Lamp Switch Manual**

This kit allows you to add a reverse light switch to non-stock applications. If you have a Hurst shifter this kit is a must.

REVSKIT-UNI	All	48.99 ea.
-------------	-----	-----------

**BPU-337**



**BPU-334**

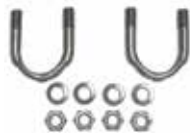

**U Joint Attaching Kits**

Correct straps and bolts for attaching the drive shaft to rear yoke.

BPU-337	All Straps w/ Bolts	15.99 kit
BPU-334	All U Bolts w/ Nuts	16.99 kit



FTS-350

**Tail Seals**

Correct tail shaft yoke seals.

FTS-PG	Powerglide	5.99 ea.
FTS-350	TH350	5.95 ea.
FTS-400	TH400	10.95 ea.



BSB-12925

**Tail Shaft Bolts**

Correct TR head markings & black phosphate plating.

BSB-12925	PG, TH350, TH400 (6 pc.)	9.99 kit
-----------	--------------------------	----------



FY-935

**Yokes**

New front drive shaft & rear differential yokes.

FY-123	Front Yoke TH400	99.95 ea.
FY-935	Front Yoke TH350/4 Speed	99.95 ea.



ATS-21MP

ATS-21MS

**TCS Transmission Switches**

Correct TCS switch located on transmission.

ATS-21MP	1970-75 Pin Style	36.99 ea.
ATS-21MS	1970-75 Spade Style	36.99 ea.



UMI-4500-B

**UMI Driveshaft Safety Loops**

This one-piece NHRA legal driveshaft safety loop is a bolt-in or weld-in application for your Chevelle. This driveshaft loop is contoured for the A-Body floor pan and bolts or welds into the reinforcement rib located behind the transmission. This is a must for tracks that require a safety loop for cars running faster than 13.99 in the quarter mile. The entire loop is constructed of 0.250 thick mild steel, CNC machined mounting points for a superb fit and fully MIG welded for outstanding strength.

UMI-4500-B	1964-72 All Black	79.99 kit
UMI-4500-R	1964-72 All Red	79.99 kit
UMI-3500-B	1978-88 All Black	79.99 kit
UMI-3500-R	1978-88 All Red	79.99 kit



GCS-S7120

**Universal Driveshaft Loop**

GCS-S7120	Universal	35.99 ea.
-----------	-----------	-----------



**Turbo HydraMatic Transmission ID Tags**

Turbo HydraMatic transmission ID tag with rivet, measuring 1-1/8 inch x 1-15/16 inch. This installs on the side of the transmission case with the rivet. You must punch your own info onto the tag.

TTP-68	1968 Dark Olive .....	29.99 ea.
TTP-6972	1969 & 72 Only Yellow .....	29.99 ea.
TTP-70	1970 Black .....	29.99 ea.
TTP-71	1971 Light Blue .....	29.99 ea.

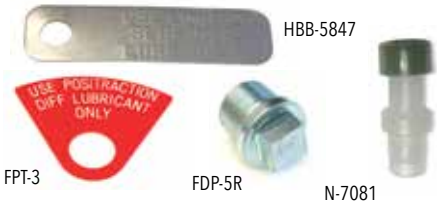

**Rear End Plugs & Posi Tag**

Reproduction plugs and posi tag.

HBB-5847	All Metal Tag .....	6.95 ea.
FDP-5R	1964-68 Plug 1" .....	16.99 ea.
FPT-3	1964-68 Posi Tag 1" .....	13.99 ea.
FDP-3R	1969-72 Plug 3/4" .....	16.99 ea.
FPT-1	1969-72 Posi Tag 3/4" .....	13.99 ea.
N-7081	1964-72 Vent Plug .....	9.95 ea.



**TCS Wire Retainer**

Correct reproduction for Muncie.

ATS-653	1970-74 w/ Muncie .....	21.99 ea.
---------	-------------------------	-----------



**B&M Differential Covers**

B&M Cast Aluminum Differential Covers are designed to strengthen the differential by preventing case distortion and ring gear & bearing cap deflection. Constructed of A356.0-T6 aluminum, these rugged covers significantly increase the fluid capacity and dissipate heat much faster than the stock factory unit to prolong the life of your ring and pinion gears.

BM-70500	12 Bolt 8.875" Ring Gear Silver .....	244.99 ea.
BM-70502	10 Bolt 8.2, 5, 6" Ring Gear Silver .....	250.99 ea.
BM-71502	10 Bolt 8.2, 5, 6" Ring Gear Black .....	272.99 ea.
BM-70503	10 Bolt 8.2" BOP Ring Gear Silver .....	224.99 ea.

No Volume Discount.



**Mr. Gasket Differential Cover Gaskets**

Mr. Gasket Differential Cover Gaskets offer simple, no silicone installation. They use an aluminum carrier, silicone elastomer beading and a rubber coated binder to create a strong, long lasting seal perfect for the demands of factory or high performance front and rear ends.

MRG-41G01MRG	Chevy 8.875"12 bolt .....	26.99 ea.
MRG-41G03MRG	GM 8.5" 10 bolt .....	26.99 ea.

No volume discount.



**B&M Deep Transmission Pan Cast**

These B&M automatic transmission deep pans provide additional fluid capacity and cooling ability. No modifications to the dipstick are needed. They include a drain plug for clean and easy fluid changes. Adds 2-3 quarts to the transmission.

BM-30280	All TH350, TH250 3Qts .....	234.99 ea.
BM-20280	All TH400 2Qts .....	215.99 ea.
BM-70280	All Powerglide 2Qts .....	227.99 ea.
BM-70260	All TH700RH, 4L60/65E 3Qts .....	325.99 ea.

No Volume Discount.



**Transmission Pans**

Show quality stock depth pan.

GCS-S8491	TH350 Polished Finned* .....	62.99 ea.
GCS-S8492	TH400 Polished Finned* .....	74.99 ea.
GCS-S8493	TH700-R4 Polished Finned* .....	74.99 ea.
GCS-S9074	TH350 Chrome .....	23.99 ea.
GCS-S7599	TH700-R4 Chrome .....	32.99 ea.
GCS-S9124	Powerglide w/ Fins Chrome .....	23.99 ea.
GCS-S9122	TH350 w/ Fins Chrome .....	20.99 ea.
GCS-S9121	TH400 w/ Fins Chrome .....	20.99 ea.
GCS-S9712	TH700-R4 w/ Fins Chrome .....	31.99 ea.

\*Includes gasket, drain plug and bolts.

**Extra Capacity Fined Transmission Pans**

Same quality show finish as our stock pans but with extra fluid capacity for better cooling.

GCS-S9197	TH400 Turbo 1.5 Extra Qts .....	23.99 ea.
GCS-S9196	TH400 Turbo 2.5 Extra Qts .....	32.99 ea.
GCS-S9197BK	TH400 Turbo 1.5 Extra Qts. Black .....	23.99 ea.
GCS-S9198BK	TH350 Turbo 1.5 Extra Qts. Black .....	24.99 ea.
GCS-S9712BK	TH700-R4 Turbo 1.5 Extra Qts. Black .....	32.99 ea.

**Custom Rear End Covers**

**Custom Rear End Covers**

Choose from high quality chrome or bright polished aluminum. A great finishing touch!

GCS-S4786	10 Bolt Chrome .....	18.99 ea.
GCS-S4787	12 Bolt Chrome .....	19.99 ea.
GCS-S5082	12 Bolt Polished .....	110.99 ea.
GCS-R0002X	Bolt Kit .....	13.99 kit

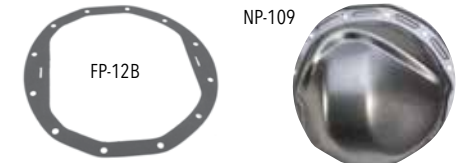

**Rear End Cover**

Reproduction 12 bolt cover.

NP-109	All 12 Bolt Cover .....	52.99 ea.
FP-10B	10 Bolt Gasket .....	7.99 ea.
FP-12B	12 Bolt Gasket .....	7.99 ea.
BRE-2008	Cover Bolt .....	0.95 ea.



**Rear End Fluid**

AC Delco special fluid and posi additive.

FPF-668	Rear End Fluid .....	26.99 ea.
FPF-49	Posi Additive .....	14.99 ea.



**B&M Throttle Valve Cable TH700R4**

Universal fit adjustable cables are less expensive than OE models. They can be used as straight replacement cable, or for ease the installation of transmission swap. Adjustable fit from 26 to 49 inches.

BM-70242	All w/ TH700R4 .....	53.99 set
----------	----------------------	-----------

No volume discount.



**Fuel Tank Super Kits**

If your original tank & hardware has seen better days, you can replace everything in one shot with this complete kit! We give you the choice of a beautiful OEM quality tank for the ultimate in show quality or an IMPROVED QUALITY import tank. Both tanks are galvanized and include filler necks as original. Each kit includes (1) tank, (2) straps, (1) hardware kit, and (1) insulation kit.

<b>OEM</b>		
XT-64AK	1964-67 All Chevelle OEM.....	344.03 kit
XT-68AK	1968-69 All Chevelle OEM.....	297.63 kit
XT-70AK	1970-72 All Chevelle OEM.....	297.63 kit
XT-70EK	1970-72 All Chevelle w/ EEC OEM.....	342.63 kit
XT-E64K	1964-67 All El Camino OEM.....	324.03 kit
XT-E68K	1968-72 All El Camino OEM.....	328.49 kit
XT-E70K	1968-72 All El Camino w/ EEC OEM.....	328.49 kit

<b>Import</b>		
XTR-64AK	1964-67 All Chevelle Import.....	244.03 kit
XTR-68AK	1968-69 All Chevelle Import.....	247.63 kit
XTR-70AK	1970-72 All Chevelle Import.....	247.63 kit
XTR-70EK	1970-72 All Chevelle w/ EEC Import.....	247.63 kit
XTR-E64K	1964-67 All El Camino & Wagon Import.....	247.63 kit
XTR-E68K	1968-72 All El Camino Import.....	248.49 kit
XTR-E70K	1968-72 All El Camino w/ EEC Import.....	248.49 kit

No Volume Discount. Ships Oversize 2. Not eligible for free shipping.



XR-70A

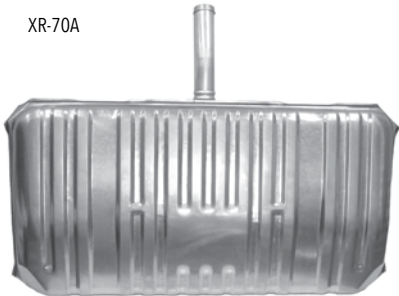

**Fuel Tanks**

The same fuel tanks in our kits above available separately.

<b>OEM Tanks</b>		
XT-64A	1964-67 Chevelle.....	299.99 ea.
XT-68A	1968-69 Chevelle.....	249.99 ea.
XT-70A	1970-72 Chevelle.....	249.99 ea.
XT-70E	1970-72 Chevelle w/ EEC.....	294.99 ea.
XT-E64	1964-67 El Camino.....	279.99 ea.
XT-E68	1968-72 El Camino.....	279.99 ea.
XT-E70	1968-72 El Camino w/ EEC.....	279.99 ea.
XTR-306A	1978-88 Carbureted.....	239.99 ea.
XTR-306C	1978-88 Fuel Injected.....	239.99 ea.

**Import Tanks**

High quality shiny zinc plate Imports, great quality at a great price.

XTR-64A	1964-67 Chevelle.....	199.99 ea.
XTR-68A	1968-69 Chevelle.....	199.99 ea.
XTR-70A	1970-72 Chevelle.....	149.99 ea.
XTR-70E	1970-72 Chevelle w/ EEC.....	199.99 ea.
XTR-E64	1964-67 El Camino & Wagon.....	199.99 ea.
XTR-E68	1968-72 El Camino.....	199.99 ea.
XTR-E70	1968-72 El Camino w/ EEC.....	199.99 ea.

*Ships Oversize 2. Not eligible for free shipping.*

XTR-70A



**Stainless Steel Fuel Tanks**

These stainless steel fuel tanks are shiny enough for any show car and rust proof enough for any daily driver! Installation is easy because this tank is a direct bolt-in replacement for your OEM tank.

XTS-64A	1964-67 Chevelle.....	279.99 ea.
XTS-68A	1968-69 Chevelle.....	279.99 ea.
XTS-70A	1970-72 Chevelle.....	412.99 ea.
XTS-70E	1970-72 Chevelle w/ EEC.....	289.99 ea.
XTS-E64	1964-67 El Camino.....	427.99 ea.
XTS-E68	1968-72 El Camino.....	480.99 ea.
XTS-E70	1968-72 El Camino w/ EEC.....	480.99 ea.

*Ships Oversize 2. Not eligible for free shipping.*

XTC-149



XTC-33

**Fuel Tank Caps**

OEM caps designed to work with original tanks only. Repro caps designed to work with import tanks only.

XTC-149	1964-72 OEM Vented.....	12.99 ea.
XTC-33	1964-72 OEM Non-Vented.....	9.95 ea.
XTC-33	1964-69 Import.....	9.95 ea.
XTC-06	1970-72 Import.....	9.95 ea.



HOL-19-105

**1964-72 Sniper Fuel Injection Fuel Tanks**

Converting the carbureted fuel system on your car or truck over to EFI can be a daunting task. We have made this conversion easy with our complete tank and fuel system kits! The heart of a fuel system begins with the fuel tank. When converting to EFI, it is crucial that you do not contaminate your new parts with dirt, rust, and sludge from an old fuel tank. Sniper fuel tanks are designed to meet or exceed the quality of your factory fuel tank. Sniper tanks are made from steel with a galvanized finish that are manufactured to the OEM specifications for your Chevelle or El Camino.

**Chevelle Tank with Pump & Sender**

HOL-19-105	1964-67* 550HP.....	684.99 ea.
HOL-19-405	1964-67* 750HP.....	747.99 ea.
HOL-19-106	1968-69* 550HP.....	684.99 ea.
HOL-19-406	1968-69* 750HP.....	808.99 ea.
HOL-19-107	1970-72* 550HP.....	747.99 ea.
HOL-19-407	1970-72* 750HP.....	808.99 ea.

**El Camino with Pump & Sender**

HOL-19-127	1964-67** 550HP.....	684.99 ea.
HOL-19-124	1968-72** 550HP.....	684.99 ea.

*Hose clamps are not included with kits with 2 piece filler necks.*

*\*Tank design is 1" deeper than stock tank due to designing clearance for the fuel pump assembly.*

*\*\* Must re-use OE filler neck.*

*No Volume Discount. Ships Oversize. Not eligible for free shipping.*



TANK-1



### Fuel Tank Mounting Kit

If your tank is good but you need to replace your hardware, this complete kit has it all! Includes straps, insulation and all hardware.

TANK-1	1964-67 Chevelle .....	44.04 kit
TANK-2	1968-72 Chevelle .....	44.99 kit

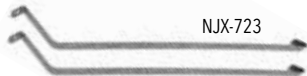

### Fuel Tank Straps

Reproduction fuel tank straps.

NJX-722	1964-67 Chevelle .....	22.99 pr.
NJX-E722	1964-67 El Camino .....	26.99 pr.
NJX-723	1968-72 Chevelle .....	22.99 pr.
NJX-E723	1968-72 El Camino .....	23.95 pr.
NJX-06	1978-88 Sedan .....	18.95 ea.

### Stainless Steel Fuel Tank Straps

Perfect for your new stainless steel tank!

NJX-A64S	1964-67 Chevelle .....	59.99 pr.
NJX-A68S	1968-72 Chevelle .....	59.99 pr.



### Fuel Tank Insulation

Correct foam insulation which is glued to the top of the fuel tank to prevent squeaks and rattles, and tar paper which goes between the tank and the straps.

NH-4381	1964-77 All .....	16.99 kit
NH-UNI	All Universal 36x21" Pad .....	19.99 ea.



### Fuel Tank Hardware

Correct OEM bolts and clips.

BCI-4753	1964-67 All .....	8.95 kit
BPX-4755	1968-72 All .....	12.95 kit



XTD-1630



BTB-56



XTD-10B

### Fuel Tank Door

Correct spring loaded fuel tank door.

XTD-64D	1964-65 Door .....	39.99 ea.
XTD-1600	1966-67 Door .....	54.99 ea.
XTD-1630	1968-72 Door .....	26.99 ea.
XTD-10B	Door Bumper .....	1.95 ea.
BTB-56K	Door Bolt .....	2.59 pr.



RFD-1475L

### El Camino Fuel Tank Door

Reproduction fuel door which mounts on the quarter panel.

RFD-1475L	1968-72 .....	57.99 ea.
-----------	---------------	-----------



XTS-12956

### Vent Tube Seal

Correct seal used to seal the vent tube to the trunk floor.

XTS-12956	1964-72 1/4" .....	11.99 ea.
-----------	--------------------	-----------



AXP-3800

AXP-1438

### Fuel Tank Hose Kits

Correct GM hose and pinch clamps.

AXP-3800	All 3/8" .....	4.95 kit
AXP-1438	All 3/8" - 1/4" .....	7.99 kit



XLR-937

XSU-T72

### Fuel Tank Sending Units

Reproduction sending units and locking ring.

XSU-T71	1964-67 3/8" .....	42.99 ea.
XSU-T72	1968-72 3/8" .....	42.99 ea.
XSU-T73	1968-72 3/8" - 1/4"* .....	42.99 ea.
XSU-G2	1978-88 3/8" 2 Line w/o Return .....	59.99 ea.
XSU-G3	1978-88 3/8" 3 Line w/ Return* .....	59.99 ea.
XLR-937	1964-72 Lock Ring w/ Gasket .....	5.95 ea.

\*For cars with fuel return line.

28540



### Sending Unit Harness

New reproduction with correct boot.

28495	1967 Chevelle .....	28.99 ea.
28480	1967 El Camino .....	24.99 ea.
28540	1968-69 Chevelle .....	27.99 ea.
28535	1968-72 El Camino .....	24.99 ea.
28940	1970-72 Chevelle .....	22.99 ea.

XFF-092



### Sender Filter & Vent

Correct mesh filter to keep debris out.

XFF-092	1964-77 All .....	17.95 ea.
---------	-------------------	-----------

XTV-689



### Fuel Tank Vent

Correct fuel tank vent.

XTV-689	1968-69 .....	39.99 ea.
---------	---------------	-----------

CGL6406



### Fuel Lines Front to Rear

Reproduction pre-bent fuel lines featuring correct armor shielding and cloth insulation as original. Available in original material (OM) and stainless steel (SS).

Main Lines		OM	SS
CGL6406	1964-66 5/16" HT, Half Moon over Rear Axle .....	79.99 ea.	120.99 ea.
CGL6407	1964-66 5/16" Convertible, Half Moon over Rear Axle .....	79.99 ea.	120.99 ea.
CGL6402	1964-67 5/16" HT, Square at Rear .....	79.99 ea.	120.99 ea.
CGL6403	1964-67 3/8" HT .....	79.99 ea.	120.99 ea.
CGL6404	1964-67 5/16" Convertible/El Camino, Square at Rear .....	79.99 ea.	120.99 ea.
CGL6405	1964-67 3/8" Convertible/El Camino .....	79.99 ea.	120.99 ea.
CGL68E3	1968-69 3/8" El Camino .....	79.99 ea.	120.99 ea.
CGL6920	1968-69 5/16" HT .....	79.99 ea.	120.99 ea.
CGL6921	1968-69 5/16" Convertible .....	79.99 ea.	120.99 ea.
CGL6923	1968-69 3/8" HT .....	79.99 ea.	120.99 ea.
CGL6925	1968-69 3/8" Convertible .....	79.99 ea.	120.99 ea.
CGL7028	1970-72 5/16" HT .....	79.99 ea.	120.99 ea.
CGL7030	1970-72 3/8" HT .....	79.99 ea.	120.99 ea.
CGL7031	1970-72 5/16" Convertible .....	79.99 ea.	120.99 ea.
CGL7033	1970-72 3/8" Convertible .....	79.99 ea.	120.99 ea.
CGL71E3	1970-72 3/8" El Camino .....	79.99 ea.	120.99 ea.
CGL7104	1971-72 5/16" 4 Door .....	79.99 ea.	120.99 ea.
CGL7601	1973-76 Chevelle 3/8" .....	79.99 ea.	120.99 ea.
CGL75E3	1975 El Camino 3/8" .....	79.99 ea.	120.99 ea.

*Ships Oversize 2. Not eligible for free shipping.*

### Fuel Return Lines

CGL68E4	1968-69 1/4" El Camino .....	79.99 ea.	120.99 ea.
CGL6922	1968-69 1/4" HT .....	79.99 ea.	120.99 ea.
CGL6924	1968-69 1/4" Convertible .....	79.99 ea.	120.99 ea.
CGL7029	1970-72 1/4" HT .....	79.99 ea.	79.99 ea.
CGL7032	1970-72 1/4" Convertible .....	79.99 ea.	120.99 ea.
CGL71E4	1970-72 1/4" El Camino .....	79.99 ea.	120.99 ea.

*Ships Oversize 2. Not eligible for free shipping.*

### Vapor Return Lines

CEM7001	1970 HT (4 pc.) .....	119.99 kit	167.99 kit
CEM7002	1970 Convertible (4 pc.) .....	119.99 kit	167.99 kit
CEM7101	1971-72 HT (ex. 4 door) .....	119.99 kit	167.99 kit
CEM7102	1971-72 Convertible .....	119.99 kit	167.99 kit
CEM71EC	1971-72 El Camino .....	119.99 kit	167.99 kit
CGL7603	1973-76 .....	79.99 kit	120.99 kit



CFV6401

**Fuel Tank Vent Lines**

Reproduction pre-bent vent lines featuring correct flared ends, armor shields and cloth insulator.



		OM	SS
CFV6401	1964-67	35.99 ea.	47.99 ea.



INL11452

INL11454

**Fuel Tank Vapor Line Kits**

This is a complete set of fuel tank vapor lines and hoses which were used on California cars only. These lines run from the corner of the gas tank to the stand pipe in the back seat.

INL11452	1970	59.99 kit
INL11454	1971-72	59.99 kit



BLC-056

INL-CAF301

**Fuel Line Clips**

Correct clips for attaching fuel lines to frame.

ELC-516	5/16" Line	1.99 ea.
ELC-516	5/16" w/ Tab	4.99 ea.
ELC-038	3/8" Line	1.99 ea.
ELC-1438	1/4" - 3/8" Line	3.99 ea.
ELC-1438T	1/4" - 3/8" w/ Tab	4.99 ea.
BLC-056	Correct Bolt	0.50 ea.

**Fuel Line Clip Kits OEM**

Correct OEM clips to attach fuel lines to the frame.

INL-CAF301	1964-67 No Return	21.99 kit
INL-CAF302	1964-67 w/ Return	21.99 kit
INL-CAF305	1968 No Return	21.99 kit
INL-CAF306	1968 w/ Return	21.99 kit
INL-CAF303	1969-72 No Return	19.99 kit
INL-CAF304	1969-72 w/ Return	23.99 kit
INL-ACF303	1973-77 No Return	20.99 kit
INL-ACF304	1973-77 w/ Return	29.99 kit
INL-ACF307	1978-88 No Return	26.99 kit
INL-ACF308	1978-88 w/ Return	29.99 kit



BPC6609

**Fuel Pump to Carburetor Lines**

Correct reproductions of the original fuel lines that run from the fuel pump to the carburetor. Each is CNC bent using original factory blueprints. All lines are available in original steel material (OM) or state of the art, show quality stainless steel (SS). All lines are made right here in the USA. These lines will only work on stock engines.

		OM	SS
CPC6401	1964 327/300 HP 4 bbl	21.99 ea.	21.99 ea.
CPC6404	1964 23 OCI	21.99 ea.	29.99 ea.
BPC6202	1964-65 327/300 HP L-74 2 Piece	24.99 ea.	36.99 ea.
CPC6402	1964-65 327/250 HP 4 bbl	21.99 ea.	29.99 ea.
CPC6501	1964-65 195, 6 Cyl.	21.99 ea.	29.99 ea.
BPC6602	1965-67 283 2 bbl	21.99 ea.	29.99 ea.
BPC6604	1966 327/275 HP, Carter	21.99 ea.	29.99 ea.
BPC6609	1966 396 Q-Jet Line & 90 Elbow	21.99 ea.	29.99 ea.
CPC6602	1966 283 4 bbl 5/16"	21.99 ea.	29.99 ea.
CPC6603	1966 327 2 bbl	21.99 ea.	29.99 ea.
CPC6607	1966 w/ 4 bbl Holley	21.99 ea.	29.99 ea.
VPC6619	1966 396/360 Single Feed Holley	21.99 ea.	26.99 ea.
CPC6702	1966-67 396/350 Single Feed Holley	21.99 ea.	29.99 ea.
FPC6702	1966-67 327/210 HP before 4/16/67	21.99 ea.	29.99 ea.
FPC6703	1967-68 327/210 HP after 4/17/67	21.99 ea.	29.99 ea.
FPC6709	1967-68 396/325 or 350 HP Q-Jet	21.99 ea.	29.99 ea.
FPC6701	1967-69 230 6 Cyl.	21.99 ea.	29.99 ea.
FPC6705	1967-69 327/275, 350/295, 5/16"	21.99 ea.	29.99 ea.
FPC6707	1967-69 327/275, 350/295, 3/8"	21.99 ea.	29.99 ea.
FPC6901	1969 350 2 bbl	21.99 ea.	29.99 ea.
FPC6902	1969 307 or 327 2 bbl	21.99 ea.	29.99 ea.
BPC6903	1969-70 396 Q-Jet (3 pc.)	35.99 ea.	47.99 ea.
FPC6905	1969-70 350 4 bbl (3 pc.)	35.99 ea.	47.99 ea.
FPC7005	1970 LS-5, L-34	21.99 ea.	29.99 ea.
CPC7101	1971-72 402 4 bbl	21.99 ea.	29.99 ea.
CPC7102	1971-72 350/270 HP 4 bbl	21.99 ea.	29.99 ea.
CPC7202	1972 350 2 bbl	21.99 ea.	21.99 ea.
CPC7206	1972 307 2 bbl	21.99 ea.	29.99 ea.
CPC7301	1972 350 2 bbl	21.99 ea.	29.99 ea.

Add "SS" to end of part number when ordering stainless.

All hard lines are manufactured and custom bent per order by The Right Stuff Detailing, the leader in quality reproduction lines. All lines are made from original blueprints to ensure a perfect fit every time!

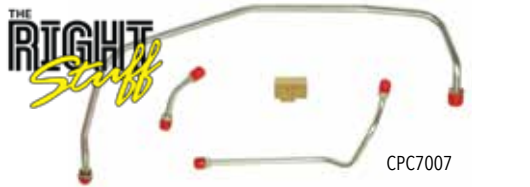

CPC7007

**Holley Pump To Carb Lines - Original**

Correct reproductions of the original Holley fuel pump to carb lines complete with lines and fuel blocks. These lines are for factory Holleys with 5/16" inlet nuts. These lines will only work on stock engines.

		OM	SS
FPC6775	1967-68 396/375 HP	57.99 ea.	69.99 ea.
FPC6975	1969 396/375 HP	57.99 ea.	69.99 ea.
CPC7007	1970 LS-6 Long Pump w/ Return	71.99 ea.	83.99 ea.
CPC7006	1970 LS-6 Short Pump w/o Return	71.99 ea.	83.99 ea.
PCY03	5/16" inlets, 9-3/8" Center to Center	36.99 ea.	42.99 ea.

Add "SS" to end of part number when ordering stainless.

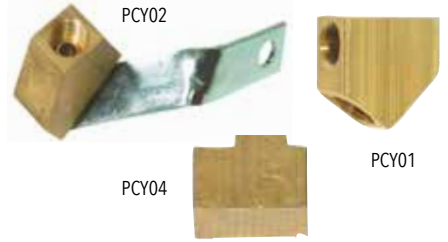

PCY02

PCY01

PCY04

**Fuel Pump to Carburetor Parts**

Correct Y blocks and T blocks for your dual feed Holley carburetor.

PCY01	Y Block w/o Bracket, Brass	21.99 ea.
PCY02	Y Block w/ Bracket, Brass	33.99 ea.
RSBB06	Y Block w/ 3/8" Ports, Used for PCY05	28.99 ea.
PCY04	T Block for 1970 LS-6	47.99 ea.
BPS-7432	Mounting Stud 5/16" x 3/8" (black)	5.99 ea.



AHL-516

AHL-38

**Carburetor Inlet Fittings**

Correct inlet nuts with washers.

AHL-516	5/16"	15.99 ea.
AHL-38	3/8"	15.99 ea.

**FUEL FILTER**



AAC-427

AAC-455

**Fuel Filters**

Original GM AC Delco

AAC-427	Q-Jet Short Style	4.95 ea.
AAC-455	All Holley Brass	5.99 ea.



**GF-432 Fuel Filter & Bracket**

This is a reproduction of the original GF-432 fuel filter and bracket for use with 3 piece fuel line.

GF-432K	1969 GF-432 Complete	63.88 kit
AAC-432	1969 GF-432 Filter	52.99 ea.
AFB-234	1969 GF-432 Bracket	17.99 ea.



FPC6903

**1969-70 3 Piece Line Sets**

These unique lines are for use with cars equipped with the GF-432 canister filter and bracket.

		OM	SS
FPC6905	1969-70 350	35.99 ea.	47.99 ea.
BPC6903	1969-70 396/325	35.99 ea.	47.99 ea.
FPC6903	1969-70 396/350	35.99 ea.	47.99 ea.



**ACDelco**

AFP-1021

**Fuel Pump**

Original replacement fuel pumps. Brand new AC-Delco units "gold zinc plated" as original.

AFP-1116	1964-68 327, 350 5/16" .....	69.95 ea.
AFP-1021	1968-72 All SB 3/8" .....	49.99 ea.
AFP-1121	1967-72 All BB 3/8" .....	49.99 ea.
AFP-1124	1968-72 All BB w/ Return .....	59.99 ea.



HOL-12834

**Holley Chrome Fuel Pumps**

Mechanical pumps designed to work with stock or mildly modified engines.

Free-flow output of 80 GPH (SB) or 80-130 GPH (BB). Body castings can be rotated 360-degrees to ease mounting in difficult places. Heavy duty construction can withstand long periods at high RPM. 1/4" (SB) 3/8" (BB) pipe thread inlet and outlet ports.

HOL-12834	Small Block .....	116.99 ea.
HOL-12835	Big Block .....	116.99 ea.

Note: Not compatible with methanol or alcohol. Cannot be used with fuel injection systems.



QF-30-350QFT

**Quick Fuel Technology Fuel Pumps**

For the street cruiser, it's tough to beat the simplicity and reliability of a mechanical fuel pump. Quick Fuel Technology's mechanical pumps flow 110 gallons per hour and utilize lightweight aluminum housings. They feature integrated shut-off valves that are preset at 6.5- to 8 psi, eliminating the need for a separate pressure regulator. For added installation flexibility, the pump casting can be rotated to accommodate various plumbing configurations. 3/8" NPT threads. Gasoline only.

QF-30-350QFT	Small Block .....	127.99 ea.
QF-30-454QFT	Big Block .....	138.99 ea.

No Volume Discount.



QF-30-125-1QFT



**Quick Fuel Technology Electric Fuel Pumps**

QFT's electric fuel pumps are perfect for combinations that are neither stock nor all out race cars. These pumps flow more than enough fuel to support between 400-750 hp. Mounting hardware and brackets are included.

- 125 GPH Flow Rate
- 14 PSI Maximum Pressure
- Features 3/8" NPT Inlets and Outlets
- Draws 4 Amps or Less at Full Load
- For Carbureted Gasoline Applications Only

QF-30-125-1QFT	Pump Only .....	146.99 ea.
QF-30-125-1RQFT	Pump/Regulator .....	166.99 ea.

No Volume Discount.

**Holley**

HOL-12-426



**Holley Electric Fuel Pumps**

Holley is proud to introduce the all new Holley Mighty Mite™ electric fuel pumps! They're big on performance, but small in size!

They're quiet, easy to install and work with gas, diesel, blended alcohol and E85!

12 volt operation, 25 gal/hr flow. Good for up to 300HP naturally aspirated. Simple 2 wire hookup. Self-priming and regulating. Quiet operation - 65db. Hose barbs fit 5/16" Fuel Hose. Made in the USA

HOL-12-426	All 25 GPH 1.5-4 PSI .....	62.99 ea.
HOL-12-427	All 32 GPH 4-7 PSI .....	62.99 ea.

No Volume Discount.

**Holley**

HOL-12-803BP



**Holley Fuel Pressure Regulator**

Holley fuel pressure regulators are designed to precisely control the fuel pressure from the fuel pump to the carburetor. Too much fuel pressure for a given needle and seat assembly will overload and may cause flooding or drivability problems. Each Holley fuel pressure regulator is fully adjustable so regulating the fuel pressure to your engines needs is simple.

12 volt operation. Preset to 7psi. 3/8" NPT ports (1 in, 1 out, 1 bypass or return). Used in systems with a return line back to the fuel tank

HOL-12-803BP	All Carbureted .....	109.99 ea.
--------------	----------------------	------------

No Volume Discount.



GCS-S4297    GCS-S9245    GCS-S9407    GCS-S9177

**Chrome Inline Fuel Filters**

Choose from a variety of show quality chrome fuel filters to dress up your engine.

**Carburetor**

GCS-S9407	Bronze Element, 3/8", Chrome .....	14.99 ea.
GCS-S9177	Paper Element, 3/8", Chrome .....	9.99 ea.
GCS-S9177BK	Paper Element, 3/8", Black .....	10.99 kit
GCS-S9245	Glass Element, 3/8", Chrome .....	13.99 ea.

**Red Top High Capacity Chrome Fuel Filters**

Show quality chrome plated fuel filter with paper element and pipe fittings.

GCS-S4297	Small .....	39.99 ea.
GCS-S4295	Large .....	42.99 ea.



AJE-395

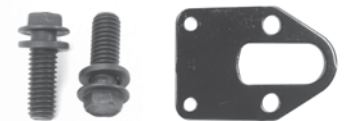

ACE-4867

ACE-9599

**Fuel Pump Hardware**

AJE-395	All Activating Rod .....	15.99 ea.
ACE-9599	All SB Plate .....	10.99 ea.
ACE-4867	Fuel Pump Bolts .....	6.99 kit



AXP-3800



AXP-6400

**Fuel Pump Hose Kit**

Correct GM hose for connecting fuel pump to main fuel line. Complete with correct "colored" pinch clamps.

AXP-3800	All 3/8" (3 pc.) .....	4.95 kit
AXP-1438	All 3/8"-1/4" (6 pc.) .....	7.99 kit
AXP-6400	All 3/8" 90 degree bend .....	11.95 kit



AFT-238

**Fuel Line Brace**

Correct factory installed brace for carb line.

AFT-238	1970 L-78, LS-6 .....	15.95 ea.
---------	-----------------------	-----------

AXD-69



**Exhaust Manifolds SB**

New GM restoration manifolds. These brand new manifolds are sold in matched pairs and come with GM cast numbers. AXD-67 features alternator bracket provision as original for some cars.

- AXD-67 1965-68 SB non-SMOG 3840912 / 3892679 .....419.99 pr.
- AXD-69 1969-72 SB non-SMOG 3932376 / 3942529 .....399.99 pr.
- AXD-69S 1969-72 SB with SMOG 3946826 / 3942527 .....419.99 pr.

*No Volume Discount. Ships Oversize. Not eligible for free shipping.*

AXD-396



**Exhaust Manifolds BB**

New GM restoration manifolds. Sold in matched pairs with GM cast numbers (3909879-3916178). Correct for most Chevelles.

- AXD-396 BB non-SMOG 3916178 / 3909879 .....429.99 pr.
- AXD-396S BB with SMOG 3916178 / 3909879 .....419.99 pr.

*No Volume Discount. Ships Oversize. Not eligible for free shipping.*



EHS-128



EHS-471



EHS-473

**Upper Heat Stove**

Works in conjunction with the air heat tube to preheat the air cleaner thermo-sensor. This item mounts on the right hand (passenger side) exhaust manifold. Manufactured to original specifications featuring the correct zinc plating.

- EHS-471 1969-76 Small Block .....9.99 ea.
- EHS-473 1969-77 V8 .....19.99 ea.
- EHS-128 1968-79 Heat Stove Tube.....21.99 ea.

XD-500



XG-225



XE-153



**Exhaust Gaskets & Donuts**

- XG-20 Riser Gasket 2" SB.....1.95 ea.
- XG-225 Riser Gasket 2.5" BB .....2.99 ea.
- XD-400 Donut 2" SB.....3.99 ea.
- XD-500 Donut 2.5" BB .....4.95 ea.
- XE-152 Extension 2" SB.....12.99 ea.
- XE-153 Extension 2.5" BB .....15.99 ea.
- GCS-S7501 Collector Gaskets, 2.5" .....23.99 kit
- GCS-S7502 Collector Gaskets, 3" .....24.99 kit
- GCS-S7503 Collector Gaskets, 3.5" .....23.99 kit
- GCS-S7504 SB Manifold Gaskets .....37.99 kit
- GCS-S7507 BB Manifold Gaskets, Round Port .....45.99 kit
- GCS-S7508 BB Manifold Gaskets, Rectangle Port .....45.99 kit

ALI-2228



**Exhaust Stud Kit**

Correct studs for mounting exhaust pipe to manifold. Our kit comes complete with 3 long & 3 short studs and 6 correct locking nuts.

- ALI-2228 All SB - BB.....22.99 kit

AHR-1190



AHR-1180



**Heat Riser Valves**

Correct valve for pre-heating engine on cold start.

- AHR-1190 Valve SB 2" .....69.99 ea.
- AHR-1180 Valve BB 2.5".....84.99 ea.



N-660

**Heat Riser Spacers**

Takes the place of the heat riser for increased flow.

- N-660 Spacer SB .....54.99 ea.
- N-733 Spacer BB.....54.99 ea.

APB-1382



**OEM Exhaust Manifold Bolts**

Correct head marked and colored bolts for mounting exhaust manifolds to block.

- APB-1382 SB w/ Washers (24 pc.).....39.99 kit
- APB-1821 BB Flanged Head (16 pc.).....23.99 kit
- APB-3506 BB Loose Washer (32 pc.).....26.99 kit

EXL-200



**Exhaust French Locks**

This kit is a correct set of four stainless steel stamped french locks for corners of exhaust manifold as installed by factory.

- EXL-100 1967-77 SB.....14.95 kit
- EXL-200 1967-73 BB\*.....14.95 kit

\*Not for flanged bolts.

XET-321



Detail

**Exhaust Tips Stock**

Reproduction exhaust tips featuring correct GM part numbers for your 1969-72 Chevelle SS. Beautiful triple chrome finish.

- XET-321 1969-72 2.5" w/ Numbers.....79.99 pr.
- NX-766 1968-72 2.5" w/o Numbers.....69.99 pr.
- XET-3213 1969-72 3" w/ Numbers .....89.99 pr.
- NX-7663 1969-72 3" w/o Numbers.....69.99 pr.

*No Volume Discount.*



EVT56



EVT49

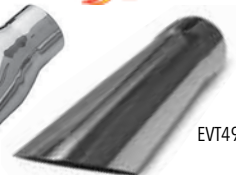

**Pypes Exhaust Tips**

Add the finishing touch to your exhaust system with a set of triple chrome plated tips from Pypes! All tips are slip fit.

- EVT54 2.5" OE Style .....113.99 pr.
- EVT56 3" OE Style .....129.99 pr.
- EVT49 2.5" Angle Cut.....42.99 pr.
- EVT50 3" Angle Cut.....49.99 pr.



### Pypes Performance Header Back Exhaust Systems

Pypes Exhaust Systems are designed to deliver enhanced performance, provide extra punch in the passing lane and improve gas mileage. The smooth, 16 gauge, mandrel-bent, stainless steel pipe ensures maximum exhaust gas flow, which can significantly boost horsepower. The stainless steel construction of the pipes and mufflers enables them to resist corrosion, extending the life of the system. Pypes systems come complete with a pair of precision matched Pypes mufflers, correct tailpipes, clamps and hangers. Can be installed at home without any special tools.

#### Pypes 2.5" Crossmember Back w/ X-Crossover

SGA10R	1964-77 w/ Race Pros 409 SS.....	553.99 kit
SGA10R30	1964-77 w/ 18" Race Pros 409 SS.....	586.99 kit
SGA10S	1964-77 w/ Street Pros 409 SS.....	553.99 kit
SGA10SSR	1964-77 w/ Race Pros 304 Pol SS.....	884.99 kit
SGA10SSV	1964-77 w/ Violators 304 Pol SS.....	880.99 kit
SGA10V	1964-77 w/ Violators 409 SS.....	553.99 kit

#### Pypes 3" Crossmember Back w/ X-Crossover

SGA13R	1964-77 w/ Race Pros 409 SS.....	678.99 kit
SGA13R36	1964-77 w/ 18" Race Pros 409 SS.....	629.99 kit
SGA13S	1964-77 w/ Street Pros 409 SS.....	678.99 kit
SGA13SSR	1964-77 w/ Race Pros 304 Pol SS.....	1124.99 kit
SGA13V	1964-77 w/ Violators 409 SS.....	678.99 kit

#### Pypes 2.5" Crossmember Back w/ X-Change

SGA11R	1964-77 w/ Race Pros 409 SS.....	746.99 kit
SGA11R30	1964-77 w/ 18" Race Pros 409 SS.....	765.99 kit
SGA11S	1964-77 w/ Street Pros 409 SS.....	746.99 kit
SGA11V	1964-77 w/ Violators 409 SS.....	746.99 kit

#### Pypes 3" Crossmember Back w/ X-Change

SGA14R	1964-77 w/ Race Pros 409 SS.....	813.99 kit
SGA14S	1964-77 w/ Street Pros 409 SS.....	777.99 kit
SGA14SSR	1964-77 w/ Race Pros 304 Pol SS.....	1161.99 kit
SGA14V	1964-77 w/ Violators 409 SS.....	806.99 kit

Note: All exhaust systems ship Oversize 2.

#### Pypes 2.5" Crossmember Back High Tuck w/ X-pipe

SGA20	1964-72 No Mufflers.....	525.99 pr.
SGA20R	1964-72 Race Pros 409 SS.....	657.99 pr.
SGA20R30	1964-72 Race Pros 409 SS 18".....	690.99 pr.
SGA20S	1964-72 Street Pros 409 SS.....	657.99 pr.
SGA20V	1964-72 Violator 409 SS.....	657.99 pr.
SGA20T30	1964-72 Turbo Pros 409 SS 18".....	730.99 ea.



PVR10S

### Collector Reducers

These act as connectors from your header collectors to intermediate pipes for a clean look.

PVR10S	3" Header to 3" Pipe.....	88.99 pr.
PVR13S	3.5" Header to 3" Pipe.....	90.99 pr.
PVR16S	3" Header to 2.5" Pipe.....	88.99 pr.
PVR19S	3.5" Header to 2.5" Pipe.....	90.99 pr.



PVD13

### Turn Downs

These universal downturns are perfect for off road applications when tail pipes are not desired.

PVD10	2.5" 409 Stainless.....	51.99 pr.
PVD13	3" Aluminized.....	83.99 pr.

XHP-642



### Exhaust Hanger Kits

Complete with all necessary hardware to install your new OEM style exhaust system.

XHP-642	1964-72 OM.....	93.99 kit
---------	-----------------	-----------



DGU14S

### Downpipes

If you are using stock manifolds, you will need a pair of these downpipes to connect to the system. 409 Stainless steel.

DGU14S	1964-77 SB.....	178.99 pr.
DGU20S	1964-77 BB.....	162.99 pr.

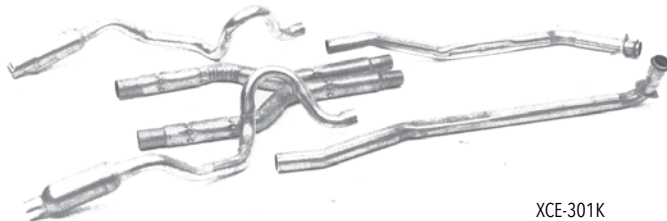

XCE-301K



### Chambered Exhaust System

Reproduction of this radical factory installed high performance exhaust system constructed of correct 14 gauge aluminized steel. It features the correct flat spots for your crossmember.

XCE-301K	1968-72 All BB.....	659.99 kit
----------	---------------------	------------

\*Tips exit rear of car. Ships Oversized. Not eligible for free shipping.

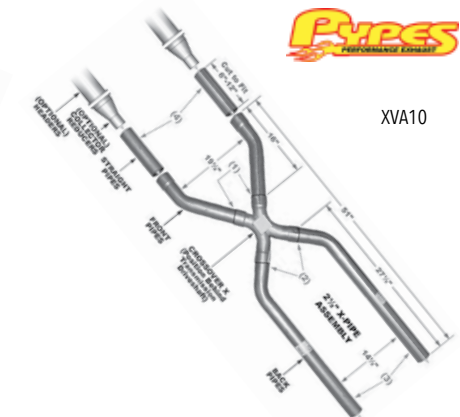

XVA10

### Pypes X-Pipes

If you are really looking to give your Chevelle an easy 15-30 horsepower boost, toss out your old balance tube and go with one of these new X-Crossovers from Pypes. This new siamese design is dyno proven to increase horsepower and torque.

		<b>409</b>	<b>Polished</b>
XVA10	2.5" Crossover.....	199.99 ea.	199.99 ea.
XVA13	3" Crossover.....	262.99 ea.	262.99 ea.
XVA14	3.5" Crossover.....	352.99 ea.	352.99 ea.

CALL FOR 1978-1988  
G-BODY PARTS & PRICING



FLOW-17119



**Flowmaster American Thunder Dual Exhaust Systems**

With easy fit in mind, these systems are mandrel bent for maximum performance and include specially selected mufflers. American Thunder systems deliver a moderate to aggressive interior and exterior tone.

- Mandrel bent 16 gauge aluminized tubing
- Includes hangers and hardware for easy installation
- Made in the USA

Below includes Super 40 Series Mufflers; Moderate to Aggressive Sound

FLOW-17119 1964-72, 2.5", Aluminized, Dual Rear Exit..... 685.99 kit

Below includes Super 40 Series Mufflers; Aggressive & Powerful Sound

FLOW-817412 1964-67, 2.5", Stainless, Dual Side Exit ..... 777.99 kit  
 FLOW-17202 1964-67, 3", Aluminized, Dual Side Exit ..... 848.99 kit  
 FLOW-817202 1964-67, 3", Stainless, Dual Side Exit ..... 994.99 kit  
 FLOW-817409 1968-72, 2.5", Stainless, Dual Rear Exit..... 777.99 kit  
 FLOW-17200 1968-72, 3", Aluminized, Dual Rear Exit..... 858.99 kit  
 FLOW-817200 1968-72, 3", Stainless, Dual Rear Exit ..... 1044.99 kit



FLOW-817412



**Flowmaster American Thunder Exhaust Systems**

American Thunder systems deliver a moderate to aggressive interior and exterior tone and are suited to the enthusiast who wants their performance to be heard. Like all Flowmaster systems, the benefits include improved throttle response, power and mileage. Designed for an easy fit, these systems include all necessary parts and hardware for easy installation.

- Dyno tuned for maximum performance
- Includes hangers and hardware for easy installation
- Moderate to aggressive sound exterior exhaust tone
- Mandrel bent 16 gauge tubing

409 Stainless Chevelle Systems

FLOW-817412 1964-67 2.5" 40 Series Mufflers\*\* Side Exit..... 777.99 kit  
 FLOW-817202 1964-67 3" 40 Series Mufflers\*\* Side Exit..... 994.99 kit  
 FLOW-817409 1968-72 2.5" 40 Series Mufflers\*\* Rear Exit..... 777.99 kit  
 FLOW-817200 1968-72 3" 40 Series Mufflers\*\* Rear Exit..... 1044.99 kit

Aluminized Chevelle Systems

FLOW-17202 1964-67 3" 40 Series Mufflers\*\* Side Exit..... 848.99 kit  
 FLOW-17119 1968-72 2.5" 40 Series Mufflers\*\* Rear Exit..... 685.99 kit  
 FLOW-17200 1968-72 3" 40 Series Mufflers\*\* Rear Exit..... 858.99 kit

Aluminized El Camino Systems

FLOW-17119 1964-72 2.5" 50 Series Mufflers\* Side Exit..... 685.99 kit

\*Moderate sound. \*\*Aggressive sound. *No Volume Discount.*

XMH-64A

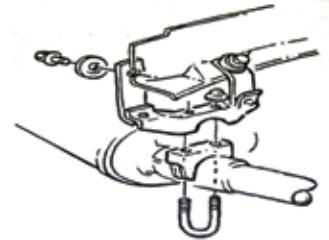

XPH-69CH

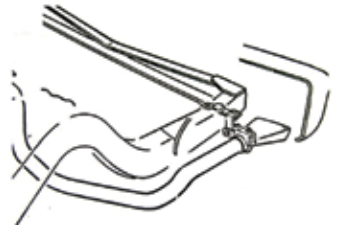

XPH-70CH

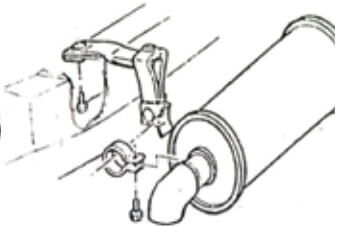

XPH-68CH

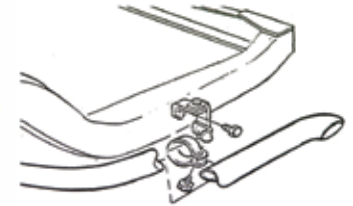

XPH-69CB

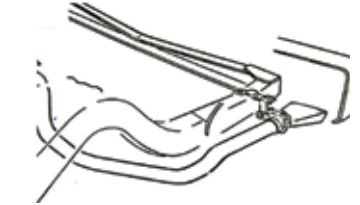

XPH-70SS

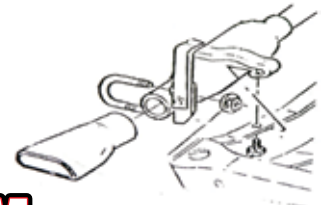

**Exhaust Hangers**

Factory reproduction exhaust hangers are a great way to finish off your restoration. Can be used with exhaust size 2 inch, 2<sup>1/4</sup> inch, 2<sup>1/2</sup> inch or larger.

XMH-64A 1964-72 Muffler Hanger..... 52.99 pr.  
 XPH-69CH 1969-72 Tail Pipe Hanger..... 54.99 pr.  
 XPH-70CH 1970-72 Tail Pipe Hanger..... 54.99 pr.  
 XPH-68CH 1968-72 Tail Pipe Hanger..... 54.99 pr.  
 XPH-69CB 1969 Tail Pipe Hanger..... 74.99 pr.  
 XPH-70SS 1970-72 Tail Pipe Hanger\*..... 99.99 pr.

\* Correct for LS3, LS5 and LS6 Super Sport



HKR-11051HKR

**Hooker Dual Exhaust Cut-Out Kits**

The choice is yours – Tease the Street or Please the Track with Hooker's new "Street-Tease" exhaust cut-outs! Good and "old" ideas improved with new materials, that's what we have here! These cut-outs will provide years of worry free use with a mixture of stainless steel and aluminum. The materials will keep the elements out, and the sound, well that's up to you, with a flip of the toggle or a push of the remote button.

- Tig-welded T-304 stainless steel tubing for a clean and weather resistant finish
- 6061 aircraft aluminum motor and valve bracket
- Instant performance gains when opened
- Stainless tip can be positioned for any direction of exhaust
- Simple 12v cigarette lighter plug in for main power supply
- Welding Required

HKR-11051HKR	Dual 2.5" Kit.....	530.99 kit
HKR-11052HKR	Dual 3" Kit.....	530.99 kit

No Volume Discount.



HKR-8501-4HKR



HKR-8501HKR

**Hooker Cast Iron LS Exhaust Manifolds**

Hooker cast iron exhaust manifolds have been designed to hug close to the engine block so they fit into a wide variety of replacement and engine-swap applications. Their contoured design aims the exhaust directly at the exit port for improved flow. Being cast iron means they will provide years of leak-free performance with less under hood noise than traditional headers. Plus, their shorty design means you can route exhaust tubing close to your frame/floor pan for maximum ground clearance. "Hook" up your GM LS engine with Hooker cast iron manifolds today!

- Intended for all GM LS (except LS7 and LS9) engine swap applications where durability, quiet operation, emissions compliance and leak-free sealing is desired
- Cast from Hi-Silicon-Moly Ductile Iron to provide durability and corrosion resistance
- 2.25-inch outlet diameter
- Free-flowing for good performance and catalytic converter efficiency
- Recommended for strong performance on engines making up to 500 horsepower

HKR-8501-1HKR	Silver Ceramic Coated .....	540.99 kit
HKR-8501-3HKR	Black Ceramic Coated.....	540.99 kit
HKR-8501-4HKR	Titanium Ceramic Coated.....	540.99 kit
HKR-8501HKR	Natural Cast Finish .....	405.99 kit
HKR-8510HKR	Natural Cast Finish Turbo*.....	596.99 kit

\*For use with a turbo charger. No Volume Discount.



FLOW-15819



**Flowmaster Pre-bent Tail Pipes**

These 16 gauge mandrel bent pipe kits are designed to fit perfectly onto your vehicle with all the quality and performance that you would expect from Flowmaster.

- Mandrel bent 16 Gauge Tubing • Rear Exit

**Aluminized Steel**

FLOW-15802	1964-72 2.5" Rear Exit .....	197.99 pr.
FLOW-15819	1964-67 3" Rear Exit .....	215.99 pr.
FLOW-15818	1968-72 3" Rear Exit .....	226.99 pr.
FLOW-15817	1978-88 3" Rear Exit .....	190.99 pr.

**409 Stainless Steel**

FLOW-815802	1964-72 2.5" Rear Exit .....	252.99 pr.
-------------	------------------------------	------------

No Volume Discount.

**Flowmaster Downpipes**

Flowmaster's manifold downpipe kits are designed for the person who wants to use a header-back exhaust system while using the factory exhaust manifolds. Utilizing mandrel bent 409S stainless steel tubing and high quality flange gaskets, Flowmaster's manifold downpipe kits are designed for the perfect leak free fit.



FLOW-81068

- Pipes designed to be used without heat riser
- 2.50 in. manifold downpipe
- Mandrel bent 16 gauge 409 stainless steel tubing

FLOW-81068	1964-74 Small Block.....	195.99 kit
FLOW-81071	1964-74 Big Block .....	195.99 kit

No Volume Discount.



FLOW-814116

**Flowmaster LS Swap Headers**

Flowmaster's Scavenger Series Elite headers feature heavy duty 3/8 in laser cut flanges, 16 gauge stainless steel primary pipes and gasket free ball flange exhaust connectors. These full length headers provide an exact fit and increased performance. Please note these headers are not emissions legal and are designed for off-road use only.

- Gasket free ball style collectors
- Ceramic coating
- Stainless steel construction
- Collector included
- Dyno tuned for maximum performance

FLOW-814116	1964-72 All 1-3/4" Primaries, 3" Exit .894.99 pr.
-------------	---

No Volume Discount.



FLOW-814111

**Flowmaster Scavenger Series Elite Long Headers**

Flowmaster's Scavenger Series Elite shorty headers are designed to replace the restrictive factory manifolds. These high quality headers are manufactured from stainless steel and are ceramic coated for maximum durability. They feature 1-3/4 in. primary tubes, 3/8 in. thick laser cut flanges and factory collector connections, ensuring a direct-fit, leak free installation. Like all Flowmaster products, the benefits include improved throttle response, power and engine efficiency.

- 3/8" laser cut flanges
- Dyno tuned for maximum performance
- High temperature ceramic coating
- 409 stainless steel construction

FLOW-814111	1964-77 Big Block 1-3/4" Primary.....	894.99 kit
-------------	---------------------------------------	------------

No Volume Discount.

**Flowmaster Scavenger Series Elite Long Tube Headers**

Scavenger Series Elite long tube headers deliver maximum performance and are suited to the enthusiast who wants the best. Like all Flowmaster products the benefits include improved throttle response, power and engine efficiency. Designed for an easy fit these headers include gaskets and necessary hardware for easy installation.

- Ball & socket collector
- Ceramic coated
- 0.375 thick laser cut flanges
- 3 inch collector outlet

FLOW-814110	1964-88 SB 1-5/8" .....	894.99 kit
FLOW-814114	1964-74 BB 2" .....	894.99 kit

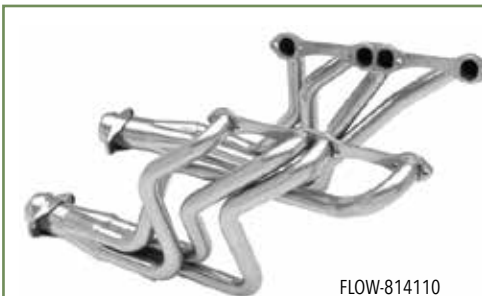

FLOW-814110



FT-49100FLT

**Flowtech Afterburner Headers**

Flowtech's Afterburner Turbo Chamber Headers represent the first new major design change in exhaust technology in decades. This design combines the race-proven 4 into 1 design with the torque managing capabilities of a Tri-Y header. The turbo chamber helps smooth out exhaust turbulence for increased performance and a broad power curve.

- Horsepower and torque increased over conventional header design
- Big 3" secondary collector for reduced back pressure
- Tuned-length primary tubes combine with velocity tube to smooth out exhaust pulses
- All hardware and premium gaskets included for a complete installation
- Patented velocity tube increases cylinder scavenging

FT-49100FLT	1968-88 Black Paint SB 1-5/8" 3" Collector .....	328.99 pr.
FT-49100-1FLT	1968-88 Silver Ceramic SB 1-5/8" 3" Collector .....	510.99 pr.

No Volume Discount.



FT-11108FLT

**Flowtech Mid-Length Headers**

Flowtech headers are the perfect combination of performance and value. Flowtech Mid-Length headers are precision engineered using mandrel bent tubing, formed collectors and 5/16" flanges with sealing rings for a leak-free seal.

- Tuned-length primary tubes for street performance
- Mandrel-bent tubing for smooth exhaust flow
- Light weight & sturdy 16 gauge tubing
- Mandrel-formed Power Plenum collector for low back pressure
- Sturdy, leak-tested O-Ring port seals
- Engineered for an easy, trouble-free precision fit
- Includes all mounting hardware and premium gaskets

<b>Small Block</b>		
FT-11108FLT	1968-88 Black Paint 1-1/2" Tubes 2.5" Collector .....	209.99 pr.
FT-11102FLT	1978-88* Black Paint 1-1/2" Tubes 2.5" Collector .....	195.99 pr.

\*Features O2 oxygen sensor bung. No Volume Discount.



HKR-2451HKR

HKR-2455-2HKR

**Hooker Competition Headers**

Hooker Competition headers offer the best value in the high performance header market. Designed for the value-conscious buyer who is running either a "stock" or "mildly-modified" engine, these headers offer premium features at a very competitive price. Made of durable 16 gauge mild steel tubing, header design utilizes a long transition collector to reduce back pressure and increase exhaust flow. A perfect sealing surface is assured with the 5/16" machined flanges, with welded O-ring seals. Experience has proven that this flange size is ideal to maintain header integrity and be pliable enough to seal each exhaust port. Tubing is mandrel-bent to maintain metal strength and provide consistent tube diameter at radii to maximize performance.

- All necessary hardware included for a complete installation
- Designed for easy, trouble-free fit
- Industry's best welds for durability
- Long transition collector for decreased back pressure
- Tuned-length primary tubes for street performance

**Hooker Long Tubes**

**Small Block**

HKR-2451HKR	1964-77 Black Paint 1-5/8" Tubes 3" Collector .....	265.99 pr.
HKR-2451-1HKR	1964-77 Silver Ceramic 1-5/8" Tubes 3" Collector .....	579.99 pr.
HKR-2451-3HKR	1964-77 Black Ceramic 1-5/8" Tubes 3" Collector .....	689.99 pr.
HKR-2451-2HKR	1964-77 Stainless 1-5/8" Tubes 3" Collector .....	837.99 pr.

**Big Block**

HKR-2455-1HKR	1964-74 Silver Ceramic 2" Tubes 3.5" Collector .....	517.99 pr.
HKR-2455-3HKR	1964-74 Black Ceramic 2" Tubes 3.5" Collector .....	581.99 pr.
HKR-2455-2HKR	1964-74 Stainless 2" Tubes 3.5" Collector .....	924.99 pr.

No Volume Discount.



FT-11100FLT

**Flowtech Long Tube Headers**

Flowtech headers are the perfect combination of performance and value. Flowtech long tube headers are precision engineered using mandrel bent tubing, formed collectors and 5/16" flanges with sealing rings for a leak-free seal. All mounting hardware and gaskets are included for a simple installation. This header is coated in a high heat resistant black paint for a stealthy appearance. Instant performance gains when opened.

- Tuned-length primary tubes for street performance
- Mandrel-bent tubing for smooth exhaust flow
- Light weight & sturdy 16 gauge tubing
- Mandrel-formed Power Plenum collector for low back pressure
- Sturdy, leak-tested O-Ring port seals
- Engineered for an easy, trouble-free precision fit
- Includes all mounting hardware and premium gaskets

**Small Block**

FT-11100FLT	1964-88 Black Paint 1-5/8" Tubes 3" Collector .....	213.99 pr.
FT-31100FLT	1964-88 Silver Ceramic 1-5/8" Tubes 3" Collector .....	446.99 pr.
FT-11104FLT	1964-88 Black Paint 1-5/8" Tubes 3" Collector .....	189.99 pr.

**Big Block**

FT-11130FLT	1964-74 Black Paint 1-3/4" Tubes 3" Collector .....	240.99 pr.
-------------	---	------------

No Volume Discount.



FT-11000FLT

**Flowtech Block Hugger Headers**

Flowtech Block Hugger headers are ideal for street rods where fit and finish is really

important. Block Huggers make performance and style easy for engine swaps, and with our new Hugger Toobs you can hook up to an existing system with ease.

- Computer-controlled mandrel-bent tubing for a smooth flow
- Sturdy 16 gauge tubing
- Easy installation - can be used with stock motor mounts
- Precision die-cut exhaust port flanges
- Engineered and tested for a leak-proof seal

**Small Block**

FT-11000FLT	1964-88 Black Paint 1-5/8" Tubes 2.5" Collector .....	236.99 pr.
FT-31000FLT	1964-78 Silver Ceramic 1-5/8" Tubes 2.5" Collector .....	457.99 pr.

**Big Block**

FT-11030FLT	1964-88 Black Paint 1-3/4" Tubes 2.5" Collector .....	244.99 pr.
FT-31030FLT	1964-78 Silver Ceramic 1-3/4" Tubes 2.5" Collector .....	529.95 pr.

**Big Block Tight Fit**

FT-11701FLT	1964-88 Black Paint 1-3/4" Tubes 2.5" Collector .....	286.99 pr.
FT-11701-1FLT	1964-88 Silver Ceramic 1-3/4" Tubes 2.5" Collector .....	124.99 pr.
FT-11701-7FLT	1964-88 Stainless 1-3/4" Tubes 2.5" Collector .....	366.95 pr.
FT-11701-2FLT	1964-78 Chrome 1-3/4" Tubes 2.5" Collector .....	140.99 pr.

No Volume Discount.



### Fan Shrouds

These are brand new, injection molded reproduction fan shrouds with the same "raw" finish as original GM. These shrouds are constructed using ABS "plastic injection" just as original GM. (1964-65 is metal like original.)

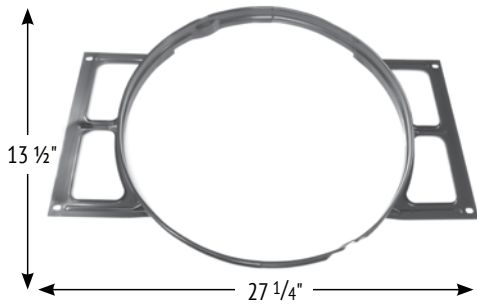

AFS-1487W 1964-65 All V8 Metal..... 89.99 ea.

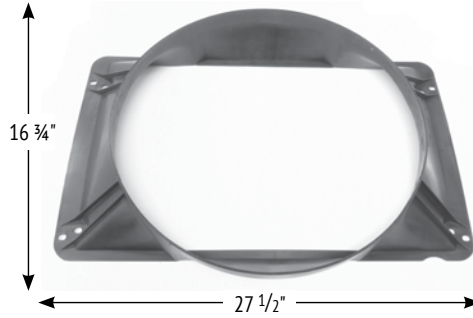

AFS-67S 1966-67 All SB 27" W x 17" H.... 74.99 ea.

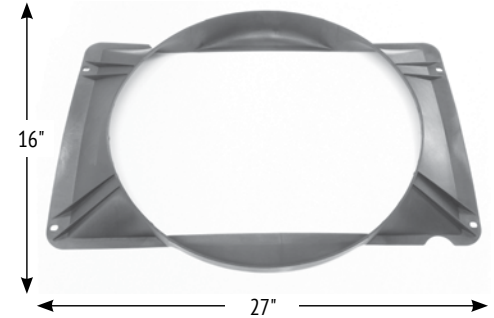

AFS-67B 1966-67 All BB 27" W x 16" H..... 89.99 ea.

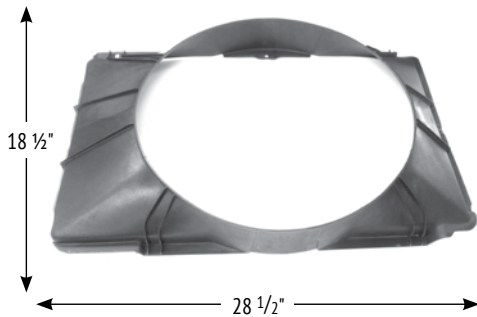

AFS-68S 1968 All SB ..... 119.99 ea.

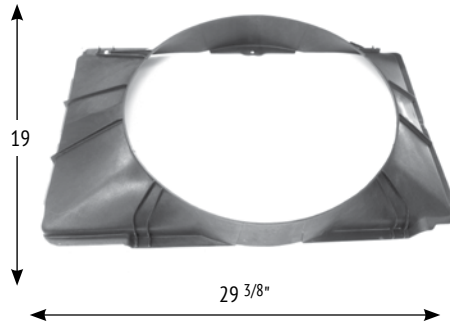

AFS-68B 1968 All BB 29 3/8" W x 19" H.. 99.99 ea.



AFS-697031 1969-70 Small Block 23.5 W X 19.25 H..... 109.99 ea.

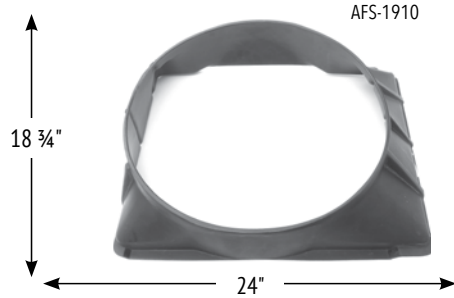

AFS-1910 1969-70 SB Small 24" Wide.... 118.99 ea.  
AFS-1912 1971-75 SB 29.5" Wide..... 169.99 ea.

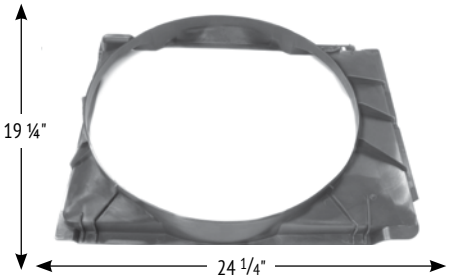

ABC-1914 1969-70 All BB\* 24.5" W x 19 1/4" H ..... 79.99 ea.

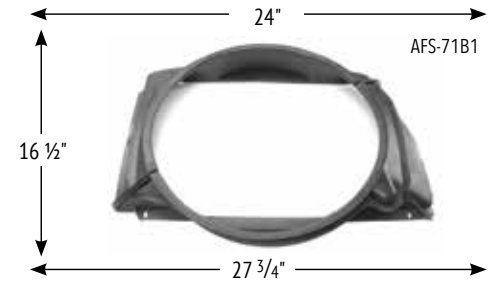

AFS-71B1 1971-75 BB 26" Core..... 139.99 ea.  
AFS-71B2 1971-75 BB 28" Core 29.5" W x 19" H ..... 119.99 ea.

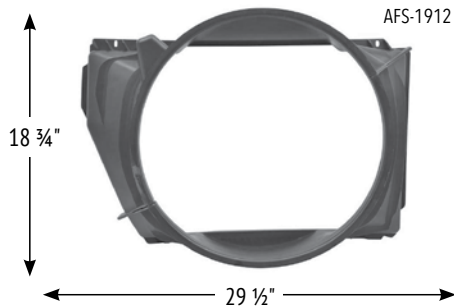

*\*This fan shroud duplicates the original GM fan shroud part number 6261914 used on all 1969-70 SS396 or SS454 models. This shroud was used on both standard 26" core radiators as well as heavy duty 28" core radiators. This shroud did not fully cover the entire 28" radiator but this is correct. Use our AFS-71B2 if you wish to cover your entire 28" radiator.*



*\*1971-72 uses a 2 piece design. 26" core is standard, 28" core is HD.*



FANKIT-7BL



**Fan Clutch Kits**

Complete kit to convert your car to this heavy duty GM fan clutch option. This kit includes fan, fan clutch and all necessary hardware.

FANKIT-5BR	1964-68 5 Blade (Short WP)....	172.74 kit
FANKIT-7BS	1964-68 7 Blade (Short WP)....	172.74 kit
FANKIT-7BL	1969-72 All (Long WP).....	154.74 kit



ABR-3996



APR-705

**Fan Blades**

Reproduction fan blades to be used with fan clutches only.

APR-705	1964-68 5 Blade 17.5" .....	109.99 ea.
ABR-3996	1969-72 7 Blade 18" .....	89.99 ea.
ABR-6BLD	1967-68 6 Blade 17.5" .....	79.95 ea.
ABR-7BLD	1962-68 7 Blade 17.5" Curved Tips..	109.99 ea.
ABR-5NOV	1964-72 5 Blade w/o Clutch .....	269.99 ea.



AWT-7719



ABR-2710



BKP-516

**Fan Clutches**

Heavy duty fan clutch with gold cadmium coloring.

AWT-7719	1964-68 Short Pump .....	74.99 ea.
ABR-2710	1969-72 Long Pump .....	74.99 ea.
BKP-516	Correct Attaching Nuts (4) .....	1.50 kit



AX-3970

**Fan Shroud Attaching Kits**

Correct OEM clips and screws for attaching the fan shroud.

AX-667	1966-67 All .....	6.95 kit
AX-3970	1968-72 All .....	6.95 kit



APC-0100

BPX-2792

**Fan and Shroud Attaching Kits**

Correct style bolts/studs for attaching fan to water pump.

BPX-2792	Attaching Stud Kit 12 Piece .....	6.95 kit
BPX-2791	Attaching Bolt Kit 8 Piece .....	5.95 kit
APC-0100	1968-72 All .....	2.95 pr.



INL-15090

**Fan Spacers**

Correct cooling fan spacers for cars that did not come equipped with a fan clutch.

INL-15090	2" 1969-77 All .....	22.99 ea.
INL-15091	1.5" 1969-77 All .....	24.99 ea.
INL-15092	1" 1969-77 All .....	24.99 ea.



AEF-14

**Electric Cooling Fans**

This electric radiator cooling fan is perfect for older muscle cars where an electric water pump is being used or as supplemental cooling.

AEF-12	12" Universal .....	53.99 ea.
AEF-14	14" Universal .....	57.99 ea.
AEF-16	16" Universal .....	64.99 ea.



PAC-2800BT



**Dakota Digital Electronic Fan Controller**

This controller was designed for the ultimate in flexibility and to be a simple add-on in any application using an electric fan. Included is a 70amp relay, enough for even the most power hungry of cooling fans. Fully programmable, the PAC-2800BT will work with your existing water temp gauge, operating from the temperature sending unit already installed.

PAC-2800BT	All w/ Electric Cooling Fans .....	148.95 kit
------------	------------------------------------	------------

*No Volume Discount.*

**KEEP A LOOK OUT FOR THESE LOGOS BELOW THROUGHOUT THE CATALOG FOR BIG SAVINGS AND DISCOUNTS ON KITS!**

**BUY'N SAVE WITH KITS**





**Champion**  
Cooling Systems

CCS-EC289



CCS-CCFK10



CCS-CCFKRL

**Aluminum Radiators by Champion Cooling Systems**

These aluminum radiators are made to the highest of standards paired with unequaled quality, precision and workmanship. The highest of aluminum grades available are used in all manufacturing processes. All Champion aluminum radiators are constructed using 100% welded seams brazed core technology and absolutely no epoxy. All Champion radiators come with a lifetime limited warranty and are made to install with little or no modifications using your original mounts giving you the confidence you deserve. Choose from the following series:

- EC Economy Core Series - 2Row - Two Rows of 3/4 inch Tubes = Approx. 400-600+ Horsepower Cooling Capacity.
- CC Champion Core Series - 3Row - Three Rows of 5/8 inch Tubes = Approx. 600-800+ Horsepower Cooling Capacity.
- MC Monster Core Series - 4Row - Four Rows of 5/8 inch Tubes = Approx. 800-1200+ Horsepower Cooling Capacity.

**Requires 2 - 12" fans +1 relay**

CCS-EC281	1964-65 Economy Core Series 21-3/4 x 28 OD .....	229.99 ea.
CCS-CC281	1964-65 Champion Core Series 21-3/4 x 28 OD .....	292.99 ea.
CCS-MC281	1964-65 Monster Core Series 21-3/4 x 28 OD .....	376.99 ea.

**Requires 2 - 12" fans +1 relay**

CCS-EC289	1964-67 Economy Core Series 22-1/4 x 27-3/4 OD .....	239.99 ea.
CCS-CC289	1964-67 Champion Core Series 22-1/4 x 27-3/4 OD .....	299.99 ea.
CCS-MC289	1964-67 Monster Core Series 22-1/4 x 27-3/4 OD .....	379.99 ea.

**Requires 2 - 14" fans +2 relays**

CCS-EC161	1968-77 Economy Core Series 33 x 18-5/8 OD .....	239.99 ea.
CCS-CC161	1968-77 Champion Core Series 33 x 18-5/8 OD .....	292.99 ea.
CCS-MC161	1968-77 Monster Core Series 33 x 18-5/8 OD .....	392.99 ea.

**Requires 2 - 10" fans +1 relay**

CCS-EC571	1968-77 Economy Core Series 27 x 19 OD .....	242.99 ea.
CCS-MC571	1968-77 Monster Core Series 27 x 19 OD .....	389.99 ea.

**Requires 2 - 10" fans +1 relay**

CCS-EC162	1978-88 Economy Core Series 18-1/4 x 31 5/8 OD .....	229.99 ea.
CCS-CC162	1978-88 Champion Core Series 18-1/4 x 31 5/8 OD .....	299.99 ea.
CCS-MC162	1978-88 Monster Core Series 18-1/4 x 31 5/8 OD .....	377.99 ea.

**Requires 2 - 12" fans +1 relay**

CCS-EC571	1978-88 Economy Core Series 19 x 27 OD .....	242.99 ea.
CCS-MC571	1978-88 Monster Core Series 19 x 27 OD .....	389.99 ea.
CCS-CC571DP	1978-88 Champion Core Series 18-1/2 x 27 OD LS Swap* .....	399.99 ea.

\*Dual pass core for LS swaps. All radiators include petcock and 16 or 19 lb cap depending on application.

**Electric Cooling Fans**

Features a reversible swept blade design meaning it can be configured as a puller or pusher. The blades are computer balanced.

CCS-CCFK10	10", 7.5 Amp Draw, 650 CFM .....	80.99 ea.
CCS-CCFK12	12", 10 Amp Draw, 870 CFM .....	82.99 ea.
CCS-CCFK14	14", 12 Amp Draw, 1200 CFM .....	94.99 ea.
CCS-CCFK16	16", 14 Amp Draw, 1600 CFM .....	105.99 ea.

**Electric Fan Relay**

Recommended for all electric fan applications. Only one relay is needed for single or dual fans.

CCS-CCFKRL	Fan Relay .....	96.99 ea.
------------	-----------------	-----------

Note: 10 and 12 inch fans require one relay. 14 and 16 inch fans require two relays.

**US Radiators**

These direct factory replacement Desert Cooler radiators from US Radiator come complete with new high density cores, correct screw-in fittings for automatics, correct mounting brackets where applicable and are ready to install.

AKY-824A	1964-65 4 Row HD Automatic .....	688.99 ea.
AKY-824M	1964-65 4 Row HD Manual .....	652.99 ea.
AKY-834A	1966-67 4 Row HD Automatic .....	589.99 ea.
AKY-834M	1966-67 4 Row HD Manual .....	677.99 ea.
AKY-844A	1968-72 4 Row HD Automatic .....	789.99 ea.
AKY-844M	1968-72 4 Row HD Manual .....	752.99 ea.
AKY-843M	1968-72 3 Row HD Manual .....	626.99 ea.

Radiators are shipped Oversized. Not eligible for free shipping. No Volume Discount.

**O.E.M.**

AKY-824A



**U.S. Radiator**  
"The Difference is in The Tooling"

AKY-844M



**1966-72 Aluminum Radiator**

This new high quality aluminum radiator is a great light weight alternative to a traditional brass and copper radiator. This 2 core aluminum radiator provides excellent cooling for all engines from mild to high performance. It is made for automatic transmissions and also includes plugs so it can be used with manual transmissions.

AKY-667A	1966-67 All .....	326.99 ea.
AKY-6872A	1968-72 All .....	326.99 ea.
VHT-SP139	Radiator Paint .....	10.99 ea.

Radiators are shipped Oversized. Not eligible for free shipping.



AKY-667A-KIT

**1966-72 Aluminum Radiator Kits**

If you are planning to upgrade your Chevelle's cooling performance, look no further than this Ground Up Motor Sports exclusive kit! All the essentials are included, such as a 2 core aluminum radiator, chrome fan, fan shroud and thermal kit. Aluminum radiators are a great lightweight alternative to traditional brass and copper radiators, with increased cooling efficiency via dual high flow aluminum tubes, suitable for mild to high performance applications. This radiator can be used for either automatic or manual transmissions with the included stoppers. Inlet is 1-1/2 inch, while outlet is 1-3/4 inch.

AKY-667A-KIT	1966-67 All .....	439.96 kit
AKY-6872A-KIT	1968-72 All .....	439.96 kit
VHT-SP139	Radiator Paint .....	10.99 ea.

No Volume Discount.



COLD-542M



COLD-541MFK

**Cold Case Radiators**

These COLD-CASE radiators are TIG welded 100% aluminum. These radiators have dual oversize 1" cooling rows making them more efficient than four 1/2" rows seen on 4 row models. Cold Case aluminum radiators cool 20% better than OEM copper radiators and are more than 50% lighter. They are original in appearance with OEM style stamped tanks for strength and that OEM original look. Once painted, they look like originals to all but the concourse fanatic. Each radiator is pressure tested, direct fit and carries a Lifetime Warranty!

COLD-541M	1964-65 Manual.....	388.99 ea.
COLD-541A	1964-65 Automatic.....	398.99 ea.
COLD-542M	1966-67 Manual.....	388.99 ea.
COLD-542A	1966-67 Automatic.....	398.99 ea.
COLD-42M	1968-72 Manual.....	383.99 ea.
COLD-44A	1968-72 Automatic.....	390.99 ea.
COLD-546A	1968-72 All Manual LS Swap.....	399.99 ea.
COLD-544A	1978-88 All G-Body .....	397.99 ea.
VHT-SP139	Radiator Paint .....	10.99 ea.

Kits With Electric Fan And Shroud

Cold Case made it easy with kits that include the radiator, fan and shroud. All kits come with the transmission cooler fittings in the radiator.

COLD-541MFK	1964-65 All Dual 12" Fans.....	624.99 kit
COLD-541AFK	1964-65 All Dual 12" Fans.....	633.99 kit
COLD-542MFK	1966-67 All Dual 12" Fans.....	622.99 kit
COLD-542AFK	1966-67 All Dual 12" Fans.....	631.99 kit
COLD-42MFK	1968-72 All Dual 12" Fans.....	625.99 kit
COLD-42AFK	1968-72 All Dual 12" Fans.....	633.99 kit
COLD-RC100	Radiator Cap All.....	23.99 ea.
COLD-FAN12	12 Inch Cooling Fan 1400 CFM .....	65.99 ea.
COLD-FAN16	16 Inch Cooling Fan 2500 CFM .....	89.99 ea.
COLD-EF1	Fan Wiring Kit All .....	96.99 kit

All radiators are shipped Oversize. Not eligible for free shipping. No Volume Discount.

**Frostbite Performance Cooling**

High-Horsepower street cars and race cars can be a challenge to keep cool. A proper cooling system starts with Frostbite.

When it comes to keeping your ride cool, Make it Frostbite!



**Aluminum Radiators**

Our line of Performance Aluminum Radiators are available in 2, 3, and 4-row sizes as well as specific LS-Swap applications.

- 100% TIG welded (brazed) seams
- Aircraft quality aluminum core, fittings, and tanks (up to 30% weight savings)
- Billet Aluminum Filler Neck and OEM Style Brass Petcock
- Custom Frostbite High Performance 16lb. radiator cap
- Polished top and tanks for custom show appearance
- 2-Row Radiators supporting applications with 300-500 horsepower
- Transmission cooler provisions

Direct Fit

FROST-FB123	64-67 V8 All 2 Row 21.25" Wide .....	315.99 ea.
FROST-FB124	64-67 V8 All 3 Row 21.25" Wide .....	393.99 ea.
FROST-FB125	64-67 V8 All 4 Row 21.25" Wide .....	522.99 ea.
FROST-FB132	68-77 V8 All 2 Row 28.25" Wide .....	315.99 ea.
FROST-FB133	68-77 V8 All 3 Row 28.25" Wide .....	393.99 ea.
FROST-FB134	68-77 V8 All 4 Row 28.25" Wide .....	522.99 ea.
FROST-FB162	78-88 V8 All 2 Row 26" Wide .....	315.99 ea.
FROST-FB163	78-88 V8 All 3 Row 26" Wide .....	393.99 ea.
FROST-FB164	78-88 V8 All 4 Row 26" Wide .....	522.99 ea.

LS Swap

Hose fittings sold separately.		
FROST-FB304	68-72 LS All 2 Row 17" Tall .....	625.99 ea.
FROST-FB302	78-88 LS All 2 Row 17" Tall .....	625.99 ea.

**Electric Fan & Shroud Kits**

Fans and Shroud Kits E= Economy H= High Performance

FROST-FB508E	Dual 12" Fits FB123, 124, 125 Radiators .....	390.99 kit
FROST-FB501E	Dual 14" Fits FB132, 133, 134, 304 Radiators.....	414.99 kit
FROST-FB501H	Dual 14" Fits FB132, 133, 134, 304 Radiators.....	504.99 kit
FROST-FB502E	Dual 12" Fits FB162, 163, 164, 302 Radiators .....	390.99 kit
FROST-FB502H	Dual 12" Fits FB162, 163, 164, 302 Radiators.....	493.99 kit

Shroud Only Dual Opening

FROST-FB508	Fits FB123, 124, 125 Radiators* .....	216.99 ea.
FROST-FB501	Fits FB132, 133, 134, 304 Radiators**.....	220.99 ea.
FROST-FB502	Fits FB162, 163, 164, 302 Radiators*.....	220.99 ea.

\*Dual 12" fan openings.\*\*Dual 14" fan openings.  
Note: Width and height measurements are for the core not overall.  
No Volume Discount.

**Fan Relay & Wiring Kit**

This relay kit will allow you to custom configure your fans as pusher or puller resulting in increased cooling performance and a reduction in noise/vibration in your engine bay. Does 1 or 2 fans.

FROST-FB403	All With Electric Fans.....	117.99 kit
-------------	-----------------------------	------------

No Volume Discount.

**Hose Fittings**

FROST-FB400	LS Swap 1.25" .....	55.99 ea.
FROST-FB401	LS Swap 1.5" .....	55.99 ea.
FROST-FB402	LS Swap 1.75" .....	55.99 ea.

No Volume Discount.



FROST-FB123



FROST-FB508E



FROST-FB508



FROST-FB400



FROST-FB401



FROST-FB402



### Cowl Vent Grille Covers

Dress up the cowl area of your Chevelle with this trick new cover from Undercover Innovations! Made out of 14 gauge aluminum, it's one piece design covers all three cowl vent holes making them look much more symmetrical. Stainless steel fasteners included.

AVG-68AC	1968-69 Clear Anodized .....	89.99 ea.
AVG-68AB	1968-69 Black Anodized.....	99.99 ea.
AVG-68AP	1968-69 Polished .....	109.99 ea.
AVG-70AC	1970-72 Clear Anodized .....	79.99 ea.
AVG-70AB	1970-72 Black Anodized.....	99.99 ea.
AVG-70AP	1970-72 Polished .....	109.99 ea.

No Volume Discount.

### Custom Radiator Covers

This custom radiator top panel offers a totally unique look and will keep your engine compartment neat and clean looking!

ARP-68A3B	1968-75 3 Bolt Black Anodized .....	94.99 kit
ARP-68A3C	1968-75 3 Bolt Clear Anodized.....	94.99 kit
ARP-68A3P	1968-75 3 Bolt Polished .....	109.99 kit
ARP-68A4B	1968-75 4 Bolt Black Anodized .....	94.99 kit
ARP-68A4C	1968-75 4 Bolt Clear Anodized.....	94.99 kit
ARP-68A4P	1968-75 4 Bolt Polished .....	109.99 kit

No Volume Discount.



AVG-68AC

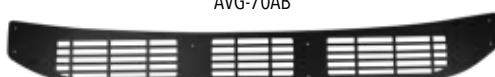

AVG-70AB



ARP-68A4B



AAC-6072



AAC-6415

### Radiator Caps

Your choice of reproduction GM RC15 cap with correct large ears and correct wording or new GM replacement.

AAC-6072	1964-72 Reproduction .....	29.99 ea.
AAC-6415	1964-72 Replacement.....	20.99 ea.

GCS-S5010

GCS-S5012



### Custom Radiator Caps

Show quality radiator caps with 16 lb. of opening pressure.

GCS-S5010	Polished Aluminum .....	20.99 ea.
GCS-S5011	Chrome .....	24.99 ea.
GCS-S5009	Chrome w/ Flames .....	26.99 ea.
GCS-S5012	Polished Aluminum .....	18.99 ea.



AJC-194



ACR-001

### Universal Coolant Reservoir

Perfect for muscle cars that did not come with a factory reservoir. Compact size. Easy to mount anywhere. 6" wide, 4" deep, 5" tall.

ACR-001	All .....	15.99 ea.
---------	-----------	-----------

### Radiator Overflow Jar Cap

Correct reproduction featuring "ENGINE COOLANT ONLY".

AJC-194	1974 All 2-1/16" Id .....	7.95 ea.
---------	---------------------------	----------

### 1978-88 Radiator Overflow Jars

Excellent reproductions of the two radiator overflow jars used on various 78-88 GM G-bodies.

AQJ-692	1978-88 1st Design.....	44.99 ea.
AQJ-470	1978-88 2nd Design.....	46.99 ea.



AOF-172

### Stainless Overflow Tank

This polished stainless steel universal fluid reservoir is perfect for older muscle cars that did not come from the factory with a coolant recovery tank.

AOF-103	10" x 3" .....	52.99 ea.
AOF-132	13" x 2" .....	52.99 pr.
AOF-152	15" x 2" .....	52.99 ea.
AOF-172	17" x 2" .....	52.99 ea.

Note: 1/4 in. Hose Barb Inlet/Outlet.



GCS-S9427

### Chrome Radiator Top Panel

This chrome plated steel radiator top panel will add a nice custom touch to your show car! Complete with hardware.

GCS-S9427	1968-73 3 Bolt 24" .....	26.99 ea.
GCS-S9428	1968-73 4 Bolt 31-1/8".....	34.99 ea.



AP-789K

### Radiator Install Kit

This kit will make it easy to install the radiator on your Chevelle. Includes a brand new radiator top mounting panel, bolts and mounting pads.

AP-789K	1968-72 w/ 4 Row .....	50.01 kit
---------	------------------------	-----------



### Radiator Top Panel

AP-789

Correct 4 bolt hole reproduction radiator top panel.

AP-789	1968-72 All .....	35.99 ea.
AP-789-OE	1968-72 All OEM Style.....	69.99 ea.
AP-689	1968-72 All 3 Bolt w/o AC.....	34.99 ea.
AB-6872	Retaining Bolts (4) .....	2.95 kit



ATE-4100



ATE-6041

### Radiator Mounting Pads

Correct upper and lower rubber pads for mounting your radiator into the support. Lower pads feature steel cores.

ATE-6041	1968-72 Upper .....	9.95 pr.
ATE-4100	1968-72 Lower.....	9.95 pr.
ATE-6SB	1968-76 3 Row & Small Block.....	6.99 ea.

CPN-0638



### Radiator Overflow Hose OEM

Correct thin walled ribbed hose as original.

CPN-0638	1964-77 .....	2.95 pr ft
----------	---------------	------------

AXP-1106



### Radiator Petcock

Correct gold colored fluted end drain valve for radiator.

AXP-1106	1964-77 All .....	6.99 ea.
----------	-------------------	----------

CPX-8739



### Radiator Hose Retaining Clip

Correct clip for retaining overflow hose.

CPX-8739	1964-72 .....	13.99 ea.
----------	---------------	-----------



**Radiator Support Show Panels**

This radiator support show panel seals up the unsightly area between the front of the radiator support and the header panel. It can be installed in about 15 minutes with no modification and will really make your engine compartment look clean and neat. Available with a number of popular logos. Add the appropriate letter for your choice of finish.

B = Black Anodized C = Clear Anodized Satin Silver P = Polished

**1964 Chevelle / El Camino**

		B or C	P
ASP-64ASS_	1964 SS	174.99 ea.	192.99 ea.
ASP-64ACV_	1964 "Chevelle" w/ Year	174.99 ea.	192.99 ea.
ASP-64ABW_	1964 Bowtie	174.99 ea.	192.99 ea.
ASP-64ABC_	1964 Bowtie/Chevrolet	174.99 ea.	192.99 ea.
ASP-64ACH_	1964 Chevrolet	174.99 ea.	192.99 ea.
ASP-64AMA_	1964 "Malibu" w/ Year	174.99 ea.	192.99 ea.
ASP-64A_	1964 Plain	137.99 ea.	156.99 ea.

**1965 Chevelle / El Camino**

		B or C	P
ASP-65ASS_	1965 SS	174.99 ea.	192.99 ea.
ASP-65ACV_	1965 "Chevelle" w/ Year	174.99 ea.	192.99 ea.
ASP-65ABW_	1965 Bowtie	174.99 ea.	192.99 ea.
ASP-65ABC_	1965 Bowtie/Chevrolet	174.99 ea.	192.99 ea.
ASP-65ACH_	1965 Chevrolet	174.99 ea.	192.99 ea.
ASP-65AMA_	1965 "Malibu" w/ Year	174.99 ea.	192.99 ea.
ASP-65AMS_	1965 "Malibu SS" w/ Year	174.99 ea.	192.99 ea.
ASP-65A_	1965 Plain	137.99 ea.	156.99 ea.

**1966 Chevelle / El Camino**

		B or C	P
ASP-66ASS_	1966 SS	174.99 ea.	192.99 ea.
ASP-66ACV_	1966 "Chevelle" w/ Bowtie	174.99 ea.	192.99 ea.
ASP-66ABW_	1966 Bowtie	174.99 ea.	192.99 ea.
ASP-66ABC_	1966 Bowtie/Chevrolet	174.99 ea.	192.99 ea.
ASP-66ACH_	1966 Chevrolet	174.99 ea.	192.99 ea.
ASP-66AMA_	1966 "Malibu" w/ Bowtie	174.99 ea.	192.99 ea.
ASP-66A_	1966 Plain	137.99 ea.	156.99 ea.

**Plain Anodized Shown in 1971 Chevelle.**

**1967 Chevelle / El Camino**

		B or C	P
ASP-67ASS_	1967 SS	174.99 ea.	174.99 ea.
ASP-67ACV_	1967 "Chevelle" w/ Year	174.99 ea.	174.99 ea.
ASP-67ABW_	1967 Bowtie	174.99 ea.	174.99 ea.
ASP-67ABC_	1967 Bowtie/Chevrolet	174.99 ea.	174.99 ea.
ASP-67ACH_	1967 Chevrolet	174.99 ea.	174.99 ea.
ASP-67AMA_	1967 "Malibu" w/ Year	174.99 ea.	174.99 ea.
ASP-67A_	1967 Plain	137.99 ea.	137.99 ea.

**1968-69 Chevelle / El Camino**

		B or C	P
ASP-68ASS_	1968-69 SS	214.99 ea.	229.99 ea.
ASP-68ACV_	1968 "Chevelle" w/ Year	218.99 ea.	229.99 ea.
ASP-69ACV_	1969 "Chevelle" w/ Year	214.99 ea.	224.99 ea.
ASP-68ABW_	1968-69 Bowtie	218.99 ea.	229.99 ea.
ASP-68ABC_	1968-69 Bowtie/Chevrolet	218.99 ea.	229.99 ea.
ASP-68ACH_	1968-69 Chevrolet	218.99 ea.	229.99 ea.
ASP-68AHB_	1968-69 Heartbeat of America	218.99 ea.	229.99 ea.
ASP-68ABM_	1968-69 Ball Milled	227.99 ea.	247.99 ea.
ASP-68A_	1968-69 Plain	174.99 ea.	214.99 ea.

**1970-72 Chevelle / El Camino**

		B or C	P
ASP-70ASS_	1970-72 SS	184.99 ea.	194.99 ea.
ASP-70ACV_	1970 "Chevelle" w/ Year	180.99 ea.	191.99 ea.
ASP-71ACV_	1971 "Chevelle" w/ Year	185.99 ea.	195.99 ea.
ASP-72ACV_	1972 "Chevelle" w/ Year	185.99 ea.	195.99 ea.
ASP-70ABW_	1970-72 Bowtie	192.99 ea.	201.99 ea.
ASP-70ABC_	1970-72 Bowtie/Chevrolet	184.99 ea.	194.99 ea.
ASP-70ACH_	1970-72 Chevrolet	184.99 ea.	195.99 ea.
ASP-70AHB_	1970-72 Heartbeat of America	184.99 ea.	194.99 ea.
ASP-70ABM_	1970-72 Ball Milled	169.99 ea.	179.99 ea.
ASP-70A_	1970-72 Plain	144.99 ea.	164.99 ea.

HOSE-KITA64B



HOSE-KITA68B



HOSE-KITA69B



HOSE-KITA69BS



**Radiator & Heater Hose Kits**

These are complete Chevelle radiator and heater hose kit includes (1) upper radiator hose with GM numbers, (1) lower radiator hose with GM numbers and (1) heater hose with GM numbers. This convenient kit allows you to replace all three of your hoses for a discounted kit price!

HOSE-KITA64B	1964-67 BB	48.36 kit
HOSE-KITA68B	1968 BB	48.36 kit
HOSE-KITA69B	1969-72 BB	48.36 kit
HOSE-KITA69BS	1969-72 BB w/ AC SHP	48.36 kit

All hose kits come with GM logo heater hoses.



**Upper Radiator Hoses GM Licensed**

Reproduction upper radiator hoses featuring the correct GM part numbers and ID codes!



CPH-0687 1964-65 SB ..... 16.95 ea.  
CPH-0688 1964-65 SB AC ..... 16.95 ea.  
CPH-7070 1965 SB SHP ..... 16.95 ea.



CPH-8956 1966-67 SB ..... 16.95 ea.  
CPH-2883 1966-67 SB AC ..... 16.95 ea.  
CPH-9670 1966-67 SB SHP ..... 16.95 ea.



CPH-3106 1966-67 BB ..... 16.95 ea.

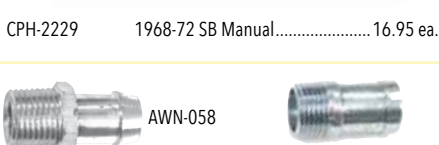

CPH-2229 1968-72 SB Manual ..... 16.95 ea.



CPH-2396 1968-72 SB Auto ..... 16.95 ea.



CPH-2453 1969-72 BB SHP or AC ..... 16.95 ea.



CPH-7227 1968-72 BB ..... 16.95 ea.  
*Can be used with most V8 with oversized radiators. Trim to fit.*

**Lower Radiator Hoses GM Licensed**

Reproduction lower radiator hoses featuring the correct GM part numbers and ID codes!



CPH-9301 1964-67 SB ..... 16.95 ea.



CPH-9303 1964-67 SB w/ SHP Special High Performance ..... 16.95 ea.



CPH-2394 1968 SB ..... 16.95 ea.  
CPH-9488 1969-72 SB ..... 16.95 ea.



CPH-1814 1966-67 BB ..... 16.95 ea.



CPH-7733 1968 BB ..... 16.95 ea.  
CPH-9188 1969-72 BB ..... 16.95 ea.



**Heater Hoses**

New officially licensed GM restoration heater hose sets. 1964-68 hoses feature correct GM with box logo and 1969-72 features correct black ribbed design.

CPH-5834 1964-68 ..... 18.99 kit  
CPR-5834 1969-72 ..... 22.99 kit

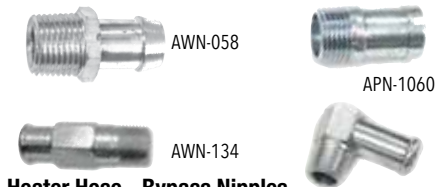

**Heater Hose - Bypass Nipples**

Reproduction zinc plated fitting. NPT Thread.

AWN-058 5/8" Short ..... 7.95 ea.  
AWN-034 3/4" Short ..... 7.95 ea.  
AWN-134 3/4" Long w/ AC ..... 8.95 ea.  
APN-1060 3/4" Bypass Slotted ..... 10.99 ea.  
AWN-1059 1964-67 SB SHP 90° ..... 22.95 ea.



**Tuff Stuff Chrome Heater Hose/Bypass Nipples**

Chrome plated heater hose/bypass hose fittings.

TUF-4450A 3/4" Long ..... 11.99 ea.  
TUF-4450B 3/4" Short ..... 11.99 ea.  
TUF-4450C 5/8" Short ..... 11.99 ea.



**Tower Clamp Kits**

Original Witek Tower style clamps. These factory installed clamps were used on most GM cars. 1962-68 used tower clamps on the radiator hoses and spring clamps on the heater hoses. Cars built 1969 or later used all tower clamps.

CPX-6368 1964-68 (8) ..... 22.95 kit  
CPX-4796 1969-72 (8) ..... 26.95 kit



**Braided Hose Sleeve Kit**

An economical way to get the look of braided hoses without the high cost! Kit includes 3' of vacuum line sleeve, 4' of fuel line sleeve, 4' of radiator hose sleeve, 12' of heater hose sleeve and matching aluminum clamp covers.

GCS-S6676 Kit w/ Red Fittings ..... 54.99 kit  
GCS-S6677 Kit w/ Blue Fittings ..... 54.99 kit  
GCS-S6678 Kit w/ Chrome Fittings ..... 54.99 kit

*Note: Sleeves can be cut with scissors. Vacuum line uses shrink tubing instead of aluminum fittings. Hose clamps are not included.*

**OEM Quality Heater Cores**

These OEM quality heater cores are made to factory specifications featuring copper brass cores soldered to the tanks as original. The seal kits are made from die cut foam as original to ensure a perfect seal.

**Heater Cores**

AHC-9040	1964-67 w/o AC.....	109.99 ea.
AHC-9040A	1964-67 w/ AC.....	109.99 ea.
AHC-9066	1968-72 w/o AC.....	79.99 ea.
AHC-9063	1968-72 w/ AC.....	89.99 ea.
AHC-CLAMP	1964-77 All*.....	19.99 pr.

\*Not all cars came with the clamps. Please check your car before ordering.

**Seals**

JHC-7364	1964-72 w/o AC.....	36.99 ea.
JHC-7264	1964-72 w/ AC.....	34.99 ea.
JHC-7468	1968-72 w/ AC.....	34.99 ea.
JHC-7887E	1978-87 w/ AC.....	59.99 kit

**Heater Core Clips**

Correct spring steel heater core retaining clips that are used to mount the heater core into the heater box.

AHC-13641	1964-72.....	29.99 kit
-----------	--------------	-----------

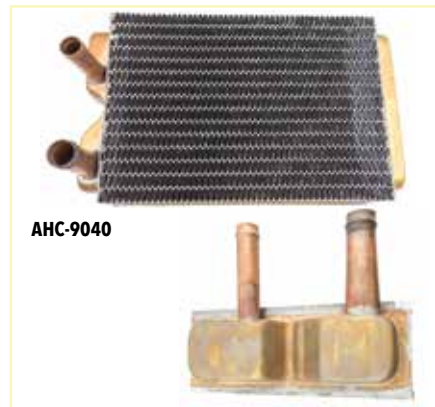
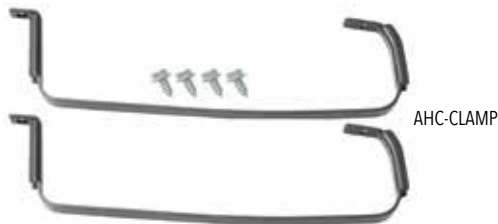

**AHC-9040**



**AHC-9040A**



**AHC-9066**

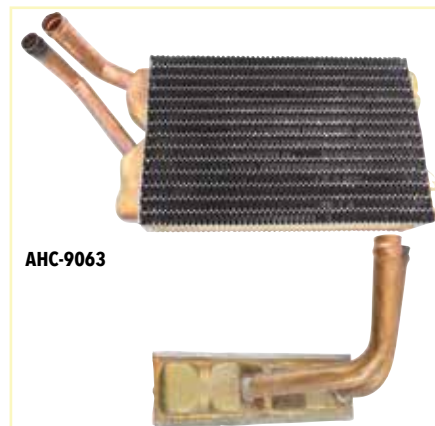

**AHC-9063**



**AHC-KIT6**

**Heater Cores & Box Seal Kits**

This kit includes an OEM heater core and neoprene seals. Components also available separately.

**Kits**

AHC-KIT5	1964-67 w/o AC.....	132.28 kit
AHC-KIT6	1964-67 w/ AC.....	130.48 kit
AHC-KIT7	1968-72 w/o AC.....	105.28 kit
AHC-KIT8	1968-72 w/ AC.....	112.48 kit



**AHC-SUPERKIT7-SC**

**BUY'N SAVE**  
WITH KITS

**Heater Core & Box Super Kits**

These new convenient heater core kits come with all the major components you need to refresh your ride.

These kits include a new OEM heater core, heater box cover, seal kit and factory caulking material.

AHC-SUPERKIT5-S	1964-67 w/o AC Black Cover.....	199.76 kit
AHC-SUPERKIT5-SC	1964-67 w/o AC Chrome Cover.....	231.26 kit
AHC-SUPERKIT7-S	1968-72 w/o AC Black Cover.....	172.76 kit
AHC-SUPERKIT7-SC	1968-72 w/o AC Chrome Cover.....	204.26 kit

No Volume Discount.



ACV-1901



**Heater Control Valve**

New GM heater control valve for all Chevs with air conditioning. Correct gold plating.

ACV-1901	1964-70 w/ AC .....	48.99 ea.
AV-560	Screws (2).....	0.95 ea.

ATE-2059



**Heater Hose Retainers**

ATE-5416

Correct heater hose retainers for inside of passenger fender and top of alternator bracket.

ATE-2059	1964-75 RH Fender .....	6.99 ea.
ATE-5416	1964-75 Alt Bracket .....	6.99 ea.

AFG-64



**Heater Blower Motor**

New OEM replacement heater blower motor for cars with or without AC.

ABM-870	1964-72 Motor .....	41.99 ea.
ABM-1041W	1964-72 Motor w/ Cage.....	73.78 ea.
ABM-CAGE	All Cage Only.....	39.99 ea.

Note: 5-1/8" diameter, and 2-3/8" deep

AFG-64	1964-69 Grommet.....	9.99 ea.
AFG-70	1970-72 Grommet.....	16.99 ea.
GWC-SPK	1964-77 Wire Clips.....	19.99 pr.

**Blower Motor Shunt**

**On AC Box**

This flange connects the blower motor fan housing to the AC box to cool the blower motor.



ACCS-7072A	1970-72 All w/ AC .....	29.99 ea.
------------	-------------------------	-----------



**Air Conditioning Plenum**

AV-1400G

Brand new air conditioning plenum.

AV-1400G	1970-72 w/ AC .....	89.95 ea.
----------	---------------------	-----------

Heater box not included.



IK-712DF

**Dash Defroster Vent Plenum**

This is a brand new improved OE style replacement defroster duct. Fits AC and heat only cars. SS or Malibu.

IK-712DF	1970-72 .....	119.99 ea.
----------	---------------	------------



AHT-2328

**Cowl Wiring Gutter**

Correct plastic gutter used to hold engine harness against firewall.

AHT-2328	1964-72 .....	8.95 ea.
ABH-102	Screws .....	0.95 pr.

**Heater Blower Motor Resistors**

Correct blower motor resistors.

ABR-71	1964-68 w/ AC .....	29.99 ea.
ABR-77	1964-72 w/o AC .....	24.99 ea.
ARS-304	Mounting Screws .....	0.95 pr.



DSE010902

**DSE Heater Delete Plate**

This bolt-in heater delete plate is an easy way to smooth your factory firewall when installing an aftermarket air conditioning. It can also give your Chevelle that rare original heater delete look. Made of 18-gauge steel. For original heater only cars.

DSE010902	1964-72 .....	97.99 ea.
-----------	---------------	-----------



AXB-15241

AXB-64-AC-DELETE

**1964-72 AC Delete Panels**

These are Bolt-in panels to block off the AC openings on the firewall.

AXB-64-AC-DELETE	Aluminum .....	69.99 ea.
AXB-15241	Steel .....	52.99 pr.



UMI-4030

UMI-4030-B

UMI-4030-R

**UMI Heater Box Delete Panels Aluminum**

This heater delete panel is designed to eliminate both the heater box and blower unit from the engine bay. Product is CNC machined from 0.125 Aluminum plate. Installation: Requires removal of heater box. No drilling required and uses factory holes, some new hardware included.

UMI-4030	1964-72 w/o AC Bare Aluminum ..	89.99 ea.
UMI-4030-R	1964-72 w/o AC Red .....	109.95 ea.
UMI-4030-B	1964-72 w/o AC Black.....	109.99 ea.

Not eligible for free shipping.

**AC Hose Grommet**

AHG-737

Located on the RH front fender well, this hose grommet insulates the AC hoses from the condenser to the engine compartment. Manufactured in rubber material including a steel spine just like original.

AHG-737	1967-68 All w/ AC .....	29.99 ea.
---------	-------------------------	-----------

**AC Evaporator Case Drain Hose**

This is the correct hose that goes into the bottom of the under hood AC evaporator case.



AEC-73D	All .....	13.99 ea.
---------	-----------	-----------

AHB-1400



**Air Conditioning Box Cover**

New injection molded condenser cover which mounts to the firewall.

AHB-1400	1968-72 w/ AC .....	209.99 ea.
----------	---------------------	------------



ACC-1400D

**Heater Boxes**

New complete inner heater box assemblies for under the dash.

ACC-1536	1966-67 w/o AC .....	279.99 ea.
ACC-1400D	1968-72 w/o AC .....	289.99 ea.
AC-1400F	1970-72 w/ AC .....	399.95 ea.

No Volume Discount.



IHD-14359

**Heater Box Deflector**

Used to deflect heat at the floor center hump.

IHD-14359	1968-72 .....	27.99 ea.
-----------	---------------	-----------



AXB-9B

**AC Delete Cover**

This covers the large hole where your AC used to be and allows you to use your factory heater core when removing your AC.

AXB-9B	1968-72 .....	139.99 ea.
--------	---------------	------------



AL-304-CHROME

JCS-10459

**Heater Box Cover**

Brand new firewall heater box cover for all cars without air conditioning.

AL-304	1964-72 .....	64.99 ea.
AL-304-CHROME	1964-72 Chrome .....	99.99 ea.
ALS-27	Retaining Nut.....	0.95 ea.
JCS-10459	Sealant .....	9.99 ea.



VA-964464

Vintage Air SureFit kits are the most complete, bolt-in climate control systems available for your Chevelle. SureFit kits install easily and utilize most of the factory sheet metal and body features and are engineered as "vehicle specific" complete systems.

Our SureFit kits are designed to place the evaporator case and air duct hoses behind the dash for a factory-clean look. In most cases, the SureFit system will be controlled by your stock dash controls using our exclusive patented "Cable Converters." In some applications, a new "factory" look control panel is included with the kit.

All SureFit systems provide full OEM-style operations including air conditioning, floor or vent exit heating and a powerful dehumidified defroster. To retain a true factory look, the AC air exits through the factory dash louvers, if originally equipped in your car's dash. SureFit kits also offer the most complete and straightforward installations available anywhere. Our award-winning instruction booklets and carefully engineered system packages should make your SureFit installation job simple, fun and very cool!

The Gen IV is Vintage Air's most powerful and intelligent climate control system available for your Chevelle. The Gen IV uses an exclusive fully electronic microprocessor control system that eliminates cables or vacuum connections. Separate high-capacity copper parallel-flow heat coil and aluminum plate-and-fin-cooling coils provide outstanding performance and instant temperature adjustments.

Complete kits include the evaporator unit and mounting brackets, louvers (where required), duct hose, wiring harness, patented Electronic Cable Converters, compressor, engine brackets, condenser with brackets, preformed refrigerant lines, drier, fittings, hardware and installation instructions.

**Features Include:**

- Fly-By-Wire fully electronic servo motor controls with no cables or capillary tube to route
- Infinite just-right-temperature air blending
- Infinite blower fan speed adjustment (3-speed on factory air models)
- High-volume dehumidified defrost mode
- Separate high-capacity aluminum plate & fin cooling coil
- Copper/brass CuproBraz™ parallel-flow heater coil
- Mounts behind the dash
- Uses your factory system controls with our patented Electronic Cable Converters
- Flat steel firewall cover panel
- Replacement molded glove box (reduced capacity)

VA-964464	1964-65 All With Factory Air.....	1824.99 kit
VA-961065	1964-65 All Without Factory Air.....	1824.99 kit
VA-964465	1966-67 All With Factory Air.....	1824.99 kit
VA-961066	1966-67 All Without Factory Air.....	1824.99 kit
VA-964471	1968-69 All With Factory Air.....	1824.99 kit
VA-961068	1968-69 All Without Factory Air.....	1824.99 kit
VA-965071	1970-72 All With Factory Air.....	1824.99 kit
VA-961071	1970-72 All Without Factory Air.....	1824.99 kit

No Volume Discount. Ships Oversize.

**CAN NOT SHIP TO CALIFORNIA ADDRESS**



ZAC-3

**Air Conditioning Receiver Dryers**

New Delco dryers.

ZAC-3	1964-67 .....	69.95 ea.
ZAC-5	1968-72 .....	49.99 ea.



ZAC-1470

**Air Conditioning Condenser Radiator**

New GM service replacement condensers. These units will require some modification.

ZAC-1470	1970-72 .....	279.95 ea.
----------	---------------	------------



ZACL6970A

**Air Conditioning Line**

New pre-bent compressor line with correct fittings and compressor muffler.

ZACL6970SB	1969-70 SB.....	188.99 ea.
ZACL6970A	1969-70 BB.....	188.99 ea.
ZACL7172A	1971-72 .....	188.99 ea.

These lines will only work with correct original AC components.



ZAC-2005

**Air Conditioning Duct Hose**

Replace your old or missing air conditioning duct hose with this correct style flex hose. Measurements are when fully stretched.

ZAC-2005	All 2" Dia, 5' Long.....	11.99 ea.
ZAC-2505	All 2.5" Dia, 5' Long .....	11.99 ea.
ZAC-2010	All 2" Dia, 10' Long .....	18.99 ea.
ZAC-2510	All 2.5" Dia, 10' Long .....	18.99 ea.

**Tuff Stuff AC Compressors**

Tuff Stuff's black chrome plated AC compressor is quality built-in Cleveland, Ohio with 100% new components. The understated black chrome look complements any engine compartment. Black chrome finish will not discolor, rust or fade over time. Provides a consistent, eye-appealing finish for under hood accessories. These compressors are designed to fit late model or custom applications. These will not work with original factory brackets on your Chevelle.













TUF-4515NADP7

TUF-4517NA6G7	"Peanut Style"6 Groove Pulley.....	467.99 ea.
TUF-4517NADP7	"Peanut Style"2 Groove Pulley.....	467.99 ea.
TUF-4515NA6G7	"Sanden 508 Style"6 Groove Pulley.....	457.99 ea.
TUF-4515NADP7	"Sanden 508 Style"2 Groove Pulley.....	457.99 ea.

No Volume Discount.

### Air Conditioning Brackets Big Block

OE style reproduction brackets for installing original Delco air conditioning compressors in all 1969-72 Chevelles with big blocks using long water pumps.

	ZAC-A1			ZAC-A4	1969-70 Rear Compressor Plate..... 24.99 ea.		ZAC-B2	1970+ Front Bracket (on head)..... 74.99 ea.
		ZAC-A4						
				ZAC-A5	1969-71 Lower Bracket (to head)..... 49.99 ea.		ZAC-B3	1970+ Front Compressor Bracket ..... 39.99 ea.
ZAC-A658-2 1965-68 Front Compressor Support..... 69.99 ea..								
ZAC-A1 1969-70 Rear Compressor Bracket..... 49.99 ea.		ZAC-A5					ZAC-B4	1970+ Rear Compressor Plate..... 49.99 ea.
				ZAC-A6	1969-70 Rear Compressor Spacer..... 26.99 ea.			
	ZAC-A2	ZAC-A6					ZAC-B5	1972+ Lower Bracket (to head)..... 49.99 ea.
ZAC-A2 1969-70 Front Bracket (on head)..... 74.99 ea.								
				ZAC-A3	1969-70 Front Compressor Bracket..... 49.99 ea.			
				ZAC-B1	1970+ Compressor to Intake Bracket ... 26.99 ea.			
ZAC-A3 1969-70 Front Compressor Bracket..... 49.99 ea.		ZAC-B1						

### BUY'N SAVE WITH KITS

Buy a complete set of big block air conditioning brackets and save! The design changed midway through 1970, so be sure to check your original brackets for early style (ZAC-AKIT) or late style (ZAC-BKIT).

ZAC-AKIT	1969-70 BB.....	249.25 kit
ZAC-BKIT	1970-71 BB.....	217.76 kit
ZAC-BKIT2	1972 BB.....	217.76 kit

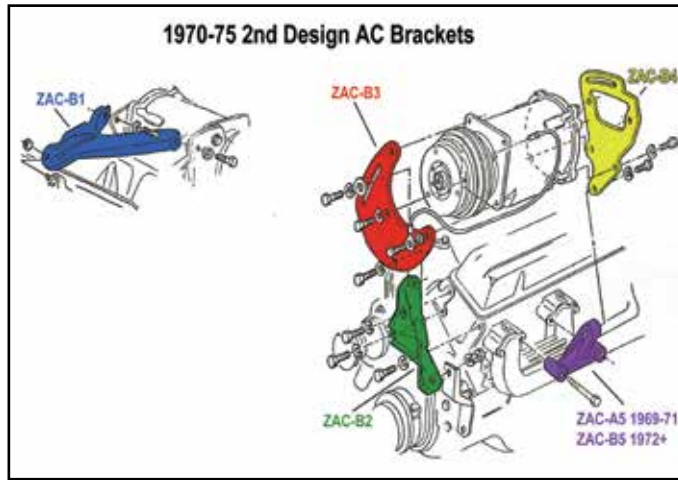
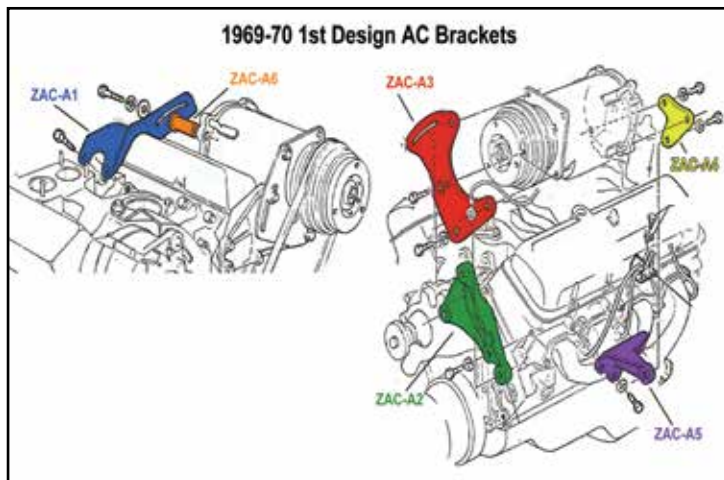



GCS-S6915

**Ball Milled Air Cleaner**

Highly polished ball milled aluminum 14" air cleaner. Includes washable 3" filter.

GCS-S6915 Flat Base Flames ..... 108.99 kit  
 GCS-S6905X Drop Base Flames ..... 115.99 kit  
 Note: 5-1/8" carb opening. Does not include stud, wing nut or gasket.



GCS-S6723

**Finned Aluminum Air Cleaner - Round**

Highly polished finned aluminum 14" air cleaner. Includes washable 3" filter.

GCS-S6723 Flat Base Round ..... 111.99 kit  
 GCS-S6725 Drop Base Round ..... 111.99 kit  
 Note: 5-1/8" carb opening. Includes mounting stud. Does not include wing nut or gasket.



ACC-3377

**Air Cleaner Dual Snorkel L-79**

Reproduction of this hard to find chrome dual snorkel, which was installed on all L79 (327 cu in 350HP) Chevilles and El Caminos. Complete with base, lid, filter and flame arrester.

ACC-3377 1965-67 L79 Complete ..... 389.99 kit  
 AL79-LIDV 1965-67 L79 Chrome Lid Only ... 269.99 ea.  
 No Volume Discount.



GCS-S2194



GCS-S2194C

**Retro Style Air Cleaner**

This retro style hot rod air cleaner assembly is constructed of steel and is a great inexpensive custom touch to any street machine or sleeper. This filter kit includes a 3" paper air filter and the mounting stud with chrome wing nut.

GCS-S2194 All Black ..... 159.99 kit  
 GCS-S2194C All Chrome ..... 215.99 kit



GCS-S6320

**Finned Aluminum Air Cleaner - Oval**

Highly polished finned aluminum 12" air cleaner. Includes washable 2" filter.

GCS-S6320 Flat Base ..... 77.99 kit  
 Note: 5-1/8" carb opening. Includes mounting stud. Does not include wing nut or gasket.



ATW-3359



ATW-3361

**Small Block Air Cleaner Assembly**

Exceptional quality reproduction of the original small block closed element air cleaner assembly for 4 bbl. carburetors with 4-3/8" throat size. Complete with base, lid with horn and filter element.

ATW-3359 1964-65 Complete Assembly ..... 189.99 kit  
 ATW-3361 1966-67 Complete Assembly ..... 189.99 kit  
 No Volume Discount.



ACQ-1220N

ATE-3907

**Open Element Air Cleaner**

Excellent reproduction of the original GM open element air cleaner assembly. Complete base with elbow assembly, chrome plated lid and AC Delco filter. Will fit most V8s with 4 bbl. carburetor.

ATE-3907 Complete Kit ..... 99.99 kit  
 ACQ-1224 Chrome Lid Only 14" ..... 44.99 ea.  
 ACQ-1220N Chrome Lid Only  
 w/ Service Instructions ..... 59.95 ea.  
 AAC-8864 Base Only w/ Elbow Assembly ..... 85.99 ea.



GCS-S8005X

**Stainless Steel Air Cleaner**

Highly polished stainless steel 14" air cleaner. Includes washable 3" filter.

GCS-S8005X Drop Base Stainless ..... 70.99 kit  
 GCS-10095 Holley Black ..... 36.99 kit  
 GCS-10099 Edelbrock Black ..... 42.99 kit  
 Note: 5-1/8" carb opening. Includes mounting stud and chrome wing nut. Does not include gasket.



AM-3360



AM-3362

### Big Block Air Cleaner Assembly

Reproduction of the original big block air cleaner assembly complete with base, lid with horn and filter element.

AM-3362	1966 396/325 HP.....	199.99 kit
AM-3360	1967 396/325 or 350 HP.....	199.99 kit
AM-3368	1966-67 Chrome Lid Only.....	79.99 ea.
ACQ-1462	Black Lid Only 17".....	58.99 ea.



ACQ-1260



ACQ-1260Z

### Cowl Induction Air Cleaner

Reproduction of original GM including base, lid and filter.

ACQ-1260	Complete Kit w/ Black Lid.....	196.99 kit
ACQ-1260Z	Complete Kit w/ Chrome Lid.....	217.99 kit
ACQ-60	Black Lid Only 14".....	35.99 ea.
ACQ-1224	Chrome Lid Only 14".....	44.99 ea.

\*Will not work with HEI



GCS-S2008

### Air Cleaner Risers

CNC machined aluminum air cleaner riser with O-ring.

GCS-S2008	1/4".....	15.99 kit
GCS-S2009	1/2".....	16.99 kit



ACL-1267

### Air Cleaner Rubber Seal

Reproduction rubber seal.

ACL-1267	1970-72 Cowl Induction.....	35.99 ea.
----------	-----------------------------	-----------



ACX-400

HOJ-409

**REAR**

### Air Cleaner Flange

Correct steel flange for top of air cleaner.

ACX-400	1970-72 Flange.....	39.99 ea.
HOJ-409	1970-72 Decal.....	8.99 ea.



AP-2B

### Air Cleaner Gasket

Correct paper gasket for sealing air cleaner base to carburetor.

AP-2B	All 2 bbl.....	3.95 ea.
AP-4B	All 4 bbl.....	4.95 ea.



HCQ-396



ACQ-396-BLK



ACQ-454-425

### Custom "Turbo Jet" Air Cleaner Lids

Our 14" air cleaner lids featuring high quality die cast "Turbo Jet" medallions. These lids can be used with any open element 14 inch air cleaner, or cowl induction air cleaner. Available in chrome or black.

ACQ-396	396 Chrome Lid.....	105.99 ea.
ACQ-396-BLK	396 Black Lid.....	105.99 kit
ACQ-454	454 Chrome Lid.....	105.99 ea.
ACQ-454-BLK	454 Black Lid.....	105.99 kit
ACQ-396-375	396, 375 HP Chrome Lid.....	159.99 ea.
ACQ-396-375-BLK	396, 375 HP Black Lid.....	159.99 kit
ACQ-454-425	454, 425 HP Chrome Lid.....	159.99 ea.
ACQ-454-425-BLK	454, 425 HP Black Lid.....	159.99 kit
ACQ-454-450	454, 450 HP Chrome Lid.....	159.99 ea.
ACQ-454-450-BLK	454, 450 HP Black Lid.....	159.99 kit

Can be used with open element air cleaners or cowl induction.



APX-1400



APX-7700



ATE-5695



APJ-2153



AP-315



AP-317

### Wing Nuts, Flame Arrester & Studs

APX-1400	Chrome Wing Nut.....	5.99 ea.
APX-7700	Black Wing Nut.....	5.99 ea.
ATE-5695	Flame Arrester.....	9.99 ea.

### Carburetor Studs

APJ-2153	All w/ Holley Open Element.....	12.95 ea.
AP-315	All w/ Q-Jet.....	13.99 ea.
AP-315	1970-72 Holley w/ Cowl Induction.....	13.99 ea.
AP-317	1970-72 Q-Jet w/ Cowl Induction.....	13.99 ea.
ATE-5256	Universal w/ Point End.....	8.99 ea.



N-1010



N-1012

**Air Filter Reproduction**

Reproduction of the original style with "square mesh" design and original GM wording (silk screened) or AC Delco replacement style air filters.

N-1012	1967-69 Diagonal Mesh.....	32.95 ea.
N-1010	1970-72 Horizontal Mesh.....	32.95 ea.
ACW-212	All 14" AC Delco .....	11.99 ea.



ACX-72



ACX-72C

**BUY'N SAVE WITH KITS**

**Cowl Induction Air Cleaner Kit**

This complete kit can be added to our inner and outer door kit for a fully functioning system! Comes complete with base, filter, lid, steel flange and rubber seal! Choose from a black or chrome lid.

ACX-72	1970-72 Black Lid.....	245.67 kit
ACX-72C	1970-72 Chrome Lid.....	264.57 kit

No Volume Discount.



ACX-970

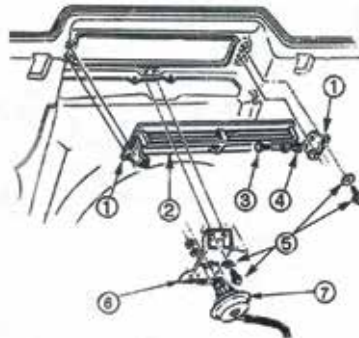

**BUY'N SAVE WITH KITS**

**Cowl Induction Outer Door Kit**

This kit contains: door brackets, hood door, door pivot bolts, pivot bushings, attaching screws, pod bracket, vacuum pod and vacuum hose.

**Kit Contains:**

- (2) Cowl Induction Door Bracket Hardware / Vacuum Pod Bracket Hardware
- (1) Windshield Washer Nozzle Mounting Screws
- (4) Cowl Induction Hose
- (1) Cowl Induction Hood Door Attaching Kit
- (1) Cowl Induction Hood Door
- (1) Cowl Induction Hood Door Brackets
- (1) Cowl Induction Vacuum Pod Bracket
- (1) Cowl Induction Vacuum Pod Actuator

ACX-970	1970-72 Outer Door Kit.....	157.32 kit
---------	-----------------------------	------------

No Volume Discount.



ACX-972

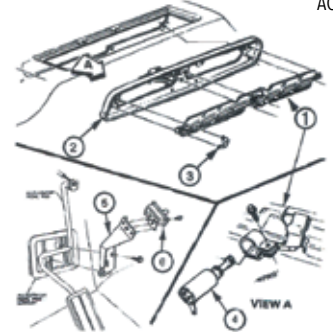

**BUY'N SAVE WITH KITS**

**Cowl Induction Inner Door Kit**

This kit contains: inner flipper door, flipper door frame, flipper retaining clips, electric solenoid, pedal switch bracket, pedal switch, wiring harness and relay switch.

**Kit Contains:**

- (1) Cowl Induction Hood Valve Frame Screw Kit
- (1) Cowl Induction Throttle Switch, 68-75 TH400 Kickdown Switch
- (1) Cowl Induction Harness
- (1) Cowl Induction Firewall Relay
- (1) Cowl Induction Valve Frame Door
- (1) Cowl Induction Valve Frame Door Clips
- (1) Cowl Induction Hood Valve Frame
- (1) Cowl Induction Solenoid, GM # 1114427
- (1) Cowl Induction Throttle Switch Bracket 68-72 Kick Down Switch Bracket

ACX-972	1970-72 Inner Door Kit.....	226.65 kit
---------	-----------------------------	------------

No Volume Discount.

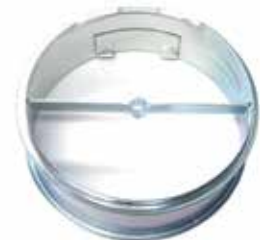

ARA-4365

**Cowl Induction Spacer**

Correct spacer used on original intake manifold.

ARA-4365	1970-72.....	39.99 ea.
----------	--------------	-----------



AMH-8922

**Cowl Induction Harness**

Reproduction of original GM.

AMH-8922 1970-72 .....58.99 ea.



ACL-1430

**Hood Valve Frame**

Correct steel frame inside of hood to support the flipper door.

ACL-1430 1970-72 .....30.99 ea.



ACL-3958

**Cowl Hood Door**

Correct steel door.

ACL-3958 1970-72 .....64.99 ea.



ACX-012

**Valve Frame (Flipper) Door**

This is the electrically controlled air door which mounts to the valve frame.

ACX-012 1970-72 .....15.99 ea.

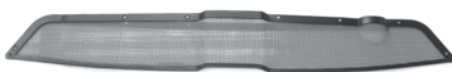

ACC-7116

**Cowl Hood Screen**

Correct steel screen attached to the rear of hood to keep debris out.

ACC-7116 1970-72 .....33.99 ea.



N-4510

**Cowl Vent Grilles**

Correct plastic grilles to keep debris out of cowl.

N-4510 1968-72 non-AC .....21.99 kit  
N-4512 1968-72 w/ AC .....21.99 kit



AIH-100



BPX-2350

**Cowl Induction Hose**

Correct non-collapsing OEM vacuum hose. (4 feet required)

AIH-100 Hose .....1.50 ea.  
BPX-2350 Retainer.....3.95 pr.



ACI-3685



AVN-101

**Cowl Hood Solenoid**

Correct electric solenoid.

ACI-3685 1970-72 .....41.99 ea.  
AVN-101 1970-72 Screw.....0.95 pr.



AX-907

**Cowl Hood Screen Screws**

This is a set of 8 correct cowl hood screen attaching screws.

AX-907 1970-72 .....5.95 kit



BX-1070

**Hood Door Bracket Hardware**

Correct set of four screws for attaching bracket to hood.

BX-1070 1970-72 .....3.95 kit



ACL-5588

**Hood Door Attaching Kit**

Correct shouldered bolts w/ P head markings w/ nylon bushings.

ACL-5588 1970-72 .....8.99 kit



BCX-130

**Hood Valve Frame Screws**

This is a set of 6 correct screws to attach the hood valve frame.

BCX-130 1970-72 .....5.95 kit



AHS-33X

**Hood Door Stopper Bumpers**

These rubber bumpers help align and make the opening of the door a smooth operation.

AHS-33X 1970-72 .....14.99 pr.



ACC-8585

**Hood Door Bracket**

New reproduction brackets for mounting door to hood.

ACC-8585 1970-72 .....27.99 pr.



AHS-99X

**Hood Door And Vacuum Pod Bracket Shim**

These metal shims help align the cowl induction hood door with the hood and make the opening and closing of the cowl induction hood door a smooth operation. These shims are also used to shim the vacuum pod mounting brackets to insure power operation.

AHS-99X 1970-72 8pc .....21.99 pr.



ACL-1684

**Valve Frame Door Clips**

Correct set of three clips to attach the flipper door to the frame.

ACL-1684 1970-72 .....6.99 kit



AQW-296

**Cowl Hood Grommet**

Correct rubber grommet for routing wiring harness.

AQW-296	1970-72	9.99 ea.
---------	---------	----------



ACC-8555



ATE-2101

**Kickdown**

Correct GM kickdown switch for TH400.

ATE-2101	1970-72 TH400 Switch	39.99 ea.
ACC-8555	1970-72 Switch Bracket	19.95 ea.
ATE-2101K	1970-72 TH400 Switch Bracket Kit	54.99 kit
06145	1966-67 TH400 Harness	38.99 ea.
11980	1968-69 TH400 Harness	39.99 ea.
17565	1971-72 TH400 Harness	28.99 ea.



AXL-913

**Flow Control Valve**

This is a correct, functional reproduction of the original valve.

AXL-913	1970-72	27.99 ea.
---------	---------	-----------



ACC-0417

**Vacuum Pod Actuator**

Monitors opening and closing of hood door.

ACC-0417	1970-72	32.99 ea.
AVN-101	Screw (to door)	0.95 pr.



BX-1070

**Vacuum Pod Bracket**

Correct bracket to hold actuator to hood.

ACC-0418	1970-72	24.99 ea.
BX-1070	Screws (4)	3.95 kit



AEH-9602

**Valve Relay**

This relay sends the "hot" signal to solenoid.

AEH-9602	1970-72	30.99 ea.
----------	---------	-----------



APX-3002

**Vacuum Advance Kits**

Our kits come complete with correct pre-bent tapered tube(s), correct white stripe vacuum hose and correct clip.

APX-3002	1967-69 SB 2bbl	15.99 kit
APX-3042	1967-69 SB 4bbl	15.99 kit
APX-2628	1967-69 SB Holley	15.99 kit
APX-3940	1966-69 BB Q-Jet	15.99 kit
APX-3946	1966-69 BB Holley	15.99 kit
APX-3944K	1970 BB Q-Jet TCS	29.99 kit
APX-4946K	1970 BB Holley TCS	29.99 kit



APR-4060 AX-301 CPN-100

**Vacuum Advance Clips**

Correct clip to retain tube to intake manifold.

APR-4060	All V8	8.95 ea.
AX-301	1970 w/ TCS	13.95 ea.
CPN-100	Hose	1.95 pr ft

GCS-S4973



**Vacuum Advance Cover**

This vacuum advance pod cover will give your distributor that show car look. Fits most GM distributors.

GCS-S4973	Chrome	5.99 ea.
-----------	--------	----------



ACK-1679

**Choke Kits**

New reproductions! Our kits come complete with thermal coil, cover, rod, retaining clip and screw.

ACK-1679	1967-69 SB Q-Jet	37.99 kit
ACK-8889	1967-69 BB Q-Jet	39.99 kit
ACK-1669	1967-69 BB Holley	36.95 kit
ACK-7072	1970-72 BB Q-Jet	46.99 kit
ACK-7071	1970-72 BB Holley	46.99 kit



AFP-4221

**Carburetor Base Gaskets & Shields**

Correct "stamped" gasket and stainless steel shield.

**Gaskets**

AFP-4221	1964-69 4 bbl. Q-Jet	6.95 ea.
AFP-4219	1970-72 4 bbl. Q-Jet	6.95 ea.
AFP-4222	1965-72 All Holley	6.95 ea.

**Shield**

ABB-7401	1964-72 All Q-Jet	13.99 ea.
----------	-------------------	-----------



DEMON-1900



**Demon Carburetors**

WICKED POWER! The ALL NEW Street Demon® redefines the street carburetor with clean looks and ease of use! The Street Demon offers enthusiasts a straightforward carburetor designed to deliver a stable idle, amazingly crisp throttle response and smooth performance. Its optimized calibration and dual mounting pattern make it Run-Ready™ Designed for use on most stock to mildly modified V8s! These carbs feature vacuum secondaries and an electric choke.

**625 CFM Carburetors**

DEMON-1900	Silver w/ Aluminum Float Bowl	402.99 ea.
DEMON-1901	Silver w/ Composite Float Bowl	402.99 ea.
DEMON-1901BK	Black w/ Aluminum Float Bowl	482.99 ea.

**750 CFM Carburetors**

DEMON-1903	Silver w/ Aluminum Float Bowl	446.99 ea.
DEMON-1904	Silver w/ Composite Float Bowl	446.99 ea.

No Volume Discount.



HOL-0-1850SA



**Holley Carburetors**

Holley is one of the most trusted carburetors of all time! Its 600 CFM of airflow, vacuum secondaries, single fuel inlet and mechanical or electric choke makes it amazingly universal. The 4160 carbs are constructed from aluminum which compared to its zinc counterpart equates to a weight savings of 40%! Being aluminum also means it will hold its shine and can be hand polished for a custom look! Don't trust your performance to just anyone, Holley is the only modular carburetor company that has been in business for over 100 years and has powered every NASCAR champion since the 60's.

HOL-0-1850SA	All 4160 600 CFM Manual Choke	346.99 ea.
HOL-0-80457SA	All 4160 600 CFM Electric Choke	359.99 ea.
HOL-0-80670	All 4150 670 CFM Electric Choke	587.99 ea.

No Volume Discount.





**Quick Fuel Technology Carburetors**  
 "Innovators in fuel systems" is more than just a by-line. Quick Fuel Technology, since it's inception in 1998, has grown exponentially in its 21 years of business culminating into the benchmark by which performance carburetors are measured.



QF-HR-600

**Hot Rod Series** is a versatile performer designed for the most discerning street enthusiast. Featuring lightweight die-cast aluminum components, the HR-Series offer all the tunability you would expect from more expensive racing carburetors, including changeable bleeds, idle feed, power valve channel restrictions, and four-corner idle. Offered in either vacuum or mechanical secondary models, all Hot Rod Series carburetors feature electric chokes and dual metering blocks for added performance. Now available in a 450 cfm model for applications with small displacement engines.

- All models feature a fully adjustable electric choke for easy starting
- Dual metering blocks w/ 4-corner idle for smooth and efficient idle quality
- Screw-in air bleeds and idle feed restrictions for quick unsurpassed tuning capability
- Dual inlet fuel bowls with sight glass windows for safe, easy float adjustment
- Universal throttle lever with sealed throttle shafts for smooth operation • Tunable secondary opening rate
- Tumble polished for long lasting shine

**4150 Carburetors Square Bore**

QF-HR-600	600CFM Mechanical.....	614.99 ea.
QF-HR-650	650CFM Mechanical.....	614.99 ea.
QF-HR-750	750CFM Mechanical.....	678.99 ea.
QF-HR-850	850CFM Mechanical.....	720.99 ea.
QF-HR-680-VS	680CFM Vacuum.....	589.99 ea.
QF-HR-780-VS	780CFM Vacuum.....	610.99 ea.

No Volume Discount.



QF-SL-450-VS

**Slayer Series** street carburetors are designed with many of the same innovations and features that are built into all QFT™ race-winning carburetors, including changeable air bleeds and power valve channel restrictions. It's designed with a secondary metering plate with changeable jets, and features all aluminum components for additional weight savings. All Slayer Series carburetors are equipped with universal throttle lever to accommodate a variety of models.

- Vacuum Secondaries • Electric Choke
- Single Metering Block • Secondary Metering Plate
- Cast Aluminum Throttle Body • Single Sight Glass Windows
- Changeable Air Bleeds • Adjustable Needles & Seats

**4160 Carburetors Square Bore Dual Inlet**

QF-SL-450-VS	450CFM Vacuum.....	427.99 ea.
QF-SL-600-VS	600CFM Vacuum.....	427.99 ea.
QF-SL-750-VS	750CFM Vacuum.....	461.99 ea.

**4160 Carburetors Square Bore Single Inlet**

QF-SL-1957E	600CFM Vacuum Silver.....	427.99 ea.
QF-BD-1957	600CFM Vacuum Black.....	517.99 ea.

No Volume Discount.



QF-SS-650

**Super Street Series** carburetors combine street-friendly drivability and track-capable performance in a single value-oriented package. Setting them apart from ordinary street carbs, they feature billet dual metering blocks and throttle-bodies that offer tighter tolerances and eliminate porosity. Not only are Super Street Series carbs available with both vacuum or mechanical secondaries, QFT™ also offers models designed and calibrated specifically for E85 fuel and blow-through forced induction applications. Running alternative fuel or boost no longer requires an expensive custom carburetor. All SS-Series carburetors are equipped with universal throttle levers to accommodate a variety of models. Bolting on the ultimate street/strip carburetor has never been easier.

- Red billet dual metering blocks & silver billet throttle bodies for improved durability
- Changeable idle, high-speed air bleeds & power valve restrictions
- Dual inlet fuel bowls with dual sight glass windows for easy float adjustment
- 4-Corner idle for precise idle and smooth transition
- Fully-adjustable electric choke with easy one wire hookup
- Race-ready with notched secondary floats and jet extensions
- Polished or Black Diamond™ finish available (some models)

**4150 Carburetors Square Bore**

QF-SS-650	650CFM Mechanical Silver.....	824.99 ea.
QF-SS-750	750CFM Mechanical Silver.....	824.99 ea.
QF-SS-850	850CFM Mechanical Silver.....	824.99 ea.
QF-BD-750	750CFM Mechanical Black.....	886.99 ea.
QF-SS-680-VS	680CFM Vacuum Silver.....	765.99 ea.
QF-SS-780-VS	780CFM Vacuum Silver.....	765.99 ea.

No Volume Discount.



QF-SQ-650

**Street-Q** carburetor is intended to deliver legendary Q-Series performance to hardcore street enthusiasts at a reduced price. The major differences between the Street-Q and the race-bred Q-Series is the substitution of cast metering blocks and a cast throttle body in place of fully-machined billet components. All of the critical functionality is retained - 2-circuit metering, downleg boosters, changeable idle and high-speed air bleeds and 4-corner idle. A universal throttle lever to accommodate a variety of models.

- Lightweight die-cast aluminum components
- Changeable idle and high-speed air bleeds
- 2-circuit metering - 4-Corner idle system
- Downleg boosters
- 700-R4 mounting holes

**4150 Carburetors Square Bore**

QF-SQ-650	650CFM Mechanical Silver.....	658.99 ea.
QF-SQ-750	750CFM Mechanical Silver.....	706.99 ea.
QF-SQ-850	850CFM Mechanical Silver.....	726.99 ea.
QF-SQ-950	950CFM Mechanical Silver.....	742.99 ea.

No Volume Discount.



QF-Q-750

**Q-Series Race** carburetors are purpose-built for the dragstrip.

To combat the g's experienced during hard launches, Q-Series carbs are equipped with notched floats and secondary jet extensions. The high-flow aluminum main body isn't just lightweight, but it also features recessed air bleed cavities for improved air flow. Die-cast venturi are machined to exacting tolerances for outstanding throttle response. Billet metering blocks ensure a uniform fuel curve, while throttle-bodies enhance durability. For those days when track conditions vary from one pass to the next, QFT's QuickLink system makes adjusting the secondaries easy on models equipped with mechanical secondaries. The Q-Series is our most comprehensive line of carburetors, with applications available for use with gasoline, methanol, and E85 fuels, forced induction, drag race, circle track, and comes in both vacuum and mechanical secondary models.

- Lightweight aluminum main body
- Mechanical secondary
- Aluminum fuel bowls with dual sight glass windows
- Billet metering blocks with 4-corner idle system
- Changeable idle feed and power valve channel restrictions
- PTFE coated and sealed shafts that have been slabbed for added air flow
- Red anodized billet metering blocks and throttle plate

**4150 Carburetors Square Bore**

QF-Q-750	750CFM Mechanical Silver/Red.....	954.99 ea.
QF-Q-750-B2	750CFM Mechanical Silver/Red*....	1021.99 ea.
QF-Q-850	850CFM Mechanical Silver/Red.....	1021.99 ea.
QF-Q-950	950CFM Mechanical Silver/Red.....	1087.99 ea.
QF-BDQ-750	750CFM Mechanical Black/Black....	1021.99 ea.

\*Draw thru supercharger applications with 2 carbs.

No Volume Discount.



QF-FX-4710

**QFX-Series** stands as the flagship model in QFT's lineup.

Raised air horns improve entry angle into the venturi while ensuring uninterrupted flow over the air bleeds. Annular boosters with CNC-machined billet aluminum inserts provide increased air flow, a stronger signal, and less turbulence. QFX carbs offer unparalleled fuel atomization with annular boosters specific for either gas, methanol, or E85 fuels. Five-emulsion billet metering blocks and four-corner idle circuits offer flexible tunability that today's high-horsepower engines demand. Ready to run out of the box, the QFX-Series carburetor will help you get to the winner's circle.

- QFX aluminum main body w/ raised venturi
- Billet aluminum metering blocks with screw in restrictions
- Aluminum fuel bowls with dual sight windows and fuel inlets
- Viton .130" Needles and Seats
- Billet Aluminum annular booster inserts
- QuickLink™ adjustable secondary opening adjustment
- Hand assembled and engine tested

**4500 Spread Bore Dominator Style**

QF-FX-4710	1150CFM Mechanical Black/Black....	1379.99 ea.
------------	------------------------------------	-------------

No Volume Discount.



BTE-1475



BMG-0095

**Carb Attaching Kits**

Correct OEM bolt kit for attaching carburetor to intake manifold.

BMG-0095	All w/Holley.....	7.99 ea.
BTE-1475	All w/Q-Jet.....	8.95 ea.

AHL-516



**Carburetor Inlet Nuts**

Correct Holley carb fuel inlet nuts & washers.

AHL-516	5/16" (stock).....	15.99 ea.
AHL-38	3/8".....	15.99 ea.

GCS-S2105



**Carburetor Velocity Stack**

High grade, chrome plated steel with a washable filter element.

GCS-S2105	Most 4 bbl .....	92.99 kit
-----------	------------------	-----------

Note: 5-1/8" carb opening.



MS142-08R



MS142-08CA

**EMS Billet Throttle Cable Brackets**

These Eddie Motorsports billet GM throttle cable brackets mount to the base of Holley carburetors. The kit includes the cable mount bracket, return springs and bracket and installation hardware.

**With 4150/4160 Series Carburetor**

MS142-08B	1964-77 Blue .....	102.99 kit
MS142-08R	1964-77 Red .....	102.99 kit
MS142-08BA	1964-77 Black Anodized .....	102.99 kit
MS142-08CA	1964-77 Clear Anodized .....	102.99 kit

**With 4500 Series Carburetor**

MS142-09B	1964-77 Blue .....	135.99 kit
MS142-09R	1964-77 Red .....	135.99 kit
MS142-09BA	1964-77 Black Anodized .....	135.99 kit
MS142-09CA	1964-77 Clear Anodized .....	135.99 kit

No Volume Discount.



N-424

**Accelerator Rod Kits**

For those using rods, our kits come complete with pre-bent rod, swivel, grommet, sleeve and hardware.

AR-4320	1964-67 SB 4 bbl*.....	19.99 kit
N-425	1966-67 BB Q-Jet.....	39.99 kit
N-424	1966-67 BB Holley.....	39.99 kit
APJ-1314	1964-67 Most.....	7.95 kit

\*may require slight modification.

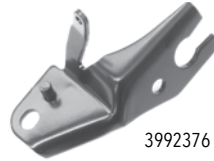

3992376



3972619

**Accelerator Brackets**

Your choice of brackets with GM numbers or without GM numbers. Both fit as original.

3992376	1969-72 Q-Jet w/ GM Numbers.....	32.95 ea.
3972619	1968-72 Holley w/ GM Numbers.....	33.99 ea.
AXK-68	1969-72 Q-Jet w/o GM Numbers.....	26.99 ea.
ADT-0014	1968-72 Holley w/o GM Numbers.....	19.95 ea.

ATH-3369KIT-H



**Accelerator Cable & Bracket Kit**

This new accelerator cable and bracket kit is the perfect solution for smooth operation when your originals are either worn or missing. This kit includes a reproduction accelerator cable, bracket and retaining clip.

ATH-3369KIT-H	1968-72 All BB/SB w/ SHP Holley.....	69.20 kit
ATH-2679KIT-Q	1968-72 All BB/SB With Q-Jet.....	66.54 kit

No Volume Discount.



AXJ-CE

AZC-88

**Accelerator Cables**

Choose from GM service replacement cables or new reproductions complete with casings and bushings as original.

ATH-3863	1968-72 SB 2 bbl GM.....	34.99 ea.
ATH-2679	1968-72 SB 4 bbl GM.....	52.99 ea.
ATH-3369	1968-72 BB Holley GM.....	49.99 ea.
AZC-88	1968-72 Cable Clip GM.....	6.95 ea.
AXJ-CE	Cable Decal.....	4.95 ea.



AS-761



AS-166



ACS-7454



ACS-0069

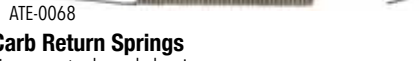

ATE-0068

**Carb Return Springs**

New correct color coded springs.

AS-761	1965-67 BB.....	9.95 ea.
AS-166	1969 SB 4bbl.....	8.95 ea.
ACS-7454	1968-72 Holley L78 LS6.....	9.95 ea.
ACS-0069	1968-69.....	8.95 ea.
ATE-0068	1969-72 Q-Jet.....	8.95 ea.

**TCS Solenoid**

Correct TCS solenoids which mount to the carburetor stud. Includes correct brackets.

1114432	1970-71 350/400.....	111.99 ea.
1114434	1970 BB.....	111.99 ea.

**BUY'N SAVE WITH KITS**

CPX-9038



**PCV Hose & Filter Kit**

Complete with hose, filter and black pinch clamp. Pieces also available separately.

CPX-9038	1967-72 Complete.....	17.95 kit
CPH-9038	Hose Only.....	12.99 ea.
CTC-1132	Pinch Clamp Only.....	0.50 ea.
CAC-3800	PCV Filter Only.....	5.95 ea.



3963569

**Intake Manifold**

This is a reproduction intake manifold with the correct W Snowflake for your Special High Performance engine!

3866963	1965 Z16 BB.....	399.95 ea.
3885069	1966-68 396/375 HP,427/450 HP... ..	399.95 ea.
3933198	1968-69 396-427SHP L88 ZL-1.....	399.95 ea.
3933163	1969 BB Aluminum 396/375 HP.....	399.95 ea.
3963569	1970 BB Low Rise LS6 / L78 / L89.....	399.95 ea.

No Volume Discount.



W8120WND

**Weiland Street Warrior Intake Manifolds**

The Weiland Street Warrior is designed for use on stock or stroker combinations that feature efficient cylinder heads. The latest advances in cam design necessitated the design of a new intake manifold, and the Weiland Street Warrior manifolds fill that void.

**Square Bore Carburetors**

W8120WND	Small Block w/ 55-86 Heads.....	210.99 ea.
W8121	Small Block w/ Vortec Heads.....	262.99 ea.

**Spread Bore Carburetors**

W8126	Small Block w/ 87-95 Heads.....	262.99 ea.
-------	---------------------------------	------------

No Volume Discount.



W8150

**Weiland Speed Warrior Intake Manifolds**

The Weiland Speed Warrior features long, separated runners for bottom-end and mid-range power, plus a special runner design and larger plenum to flow the air needed for high-rpm horsepower. All of this usable power makes this intake perfect for your street and strip hot rod!

W8150	Small Block w/ 55-86 Heads.....	240.99 ea.
W8170WND	Small Block w/ 87-95 Heads.....	245.99 ea.

No Volume Discount.



BPS-3679



BPS-7432

**Intake Studs**

Correct intake manifold studs for various uses: alternator, solenoid and power brake tube. Includes correct nut.

- BPS-3679 All 3/8" x 3/8" (Zinc)..... 5.99 ea. (p.s. bracket, alternator mount, etc.)
- BPS-7432 All 5/16" x 3/8" (Black)..... 5.99 ea. (TCS, P.B. tube, etc.)



APN-0138



APN-0238



APN-0038



APN-638



APN-738



APN-838

**Intake Manifold Vacuum Fittings**

Reproduction!! These high quality fittings for rear of intake manifold have correct "slip on" and threaded ends. These fittings have a variety of uses: power brake hose, auto transmission, air conditioning, cruise control, etc. Guaranteed to look, fit and function exactly as original.

- APN-0138 (1) Slip On Fitting.....25.99 ea.
- APN-0238 (2) Slip On Fittings.....25.99 ea.
- APN-0038 (1) Threaded Port.....25.99 ea.
- APN-638 (1) Threaded (1) Slip On.....25.99 ea.
- APN-738 (1) Threaded (2) Slip On.....25.99 ea.
- APN-838 (1) Threaded (3) Slip On.....29.95 ea.



BPI-2271

**Intake Manifold Bolts OEM**

Our OEM intake bolts feature correct size, coloring and head markings.

- BPI-4400 All SB "M" Flanged (12 pc.)..... 16.95 kit
- BPI-9140 All BB "M" Cast Intake (16 pc.).....21.95 kit
- BPI-2271 All BB "A" Aluminum Intake (16 pc.).....28.99 kit



ACT-180

**Thermostat**

High quality replacement thermostat.

- ACT-180 180-85 Degrees..... 6.95 ea.
- ACT-190 190-95 Degrees..... 6.95 ea.

**Tuff Stuff Performance Thermostats**

These thermostats flow up to 56 gallons per minute, as compared to ordinary thermostats that flow 37 gallons per minute, to maintain stated temperature.



The 50 percent increased coolant flow reduces the delay in engine warm-up times, allowing trapped air in the cooling system to escape and stabilize the pressure of the cooling system. The stainless steel construction with an extra-large center port assures increased coolant flow and bridge design increases strength, stability & reliability and incorporates a bypass valve that allows a small amount of coolant to circulate before fully opening, assuring a fast warm-up. Ideal for high performance muscle cars, street rods and customs.

- TUF-900160 160 Degree.....18.99 ea.
- TUF-900180 180 Degree.....18.99 ea.
- TUF-900195 195 Degree.....19.99 ea.

No Volume Discount.



ACI-7660



**Thermostat Housing**

Correct thermostat housing for high performance engines with aluminum intake manifolds. GM #3877660.

- ACI-7660 Aluminum.....56.99 ea.



ATE-7396



**L79 Thermostat Housing**

This is the correct goose-neck style thermostat housing for your L79 327/350 horsepower engine.

- ATE-7396 1964-68.....59.95 ea.



ABR-7660

**Thermostat Housing**

Correct thermostat housing for cast iron manifolds. This was the most common housing and was found on most V8s.

- ABR-7660 Most V8.....17.99 ea.
- GCS-S9468 Most V8, 1/2" NPT Port.....16.99 ea.



GCS-S9229

**Chrome Thermostat Housing**

Chrome steel thermostat housing with o-ring and bolts. Water neck points toward the driver side of the radiator.

- GCS-S9229 Most V8.....14.99 kit



ATR-2039



ATR-1039

**Thermostat Housing Bolts**

Correct TR head marked bolts for attaching to intake.

- ATR-2039 1964-68 SB.....7.99 ea.
- ATR-1039 1969-77 SB.....8.99 ea.
- ATR-2039 1964-72 BB.....7.99 ea.

GAC-560

GAC-760

GAC-660



**Temp Sending Units**

Correct screw in sending units.

- GAC-250 1964-72 w/o Gauges.....19.99 ea.
- GAC-560 1964-72 w/ Gauges\*.....16.95 ea.
- GAC-760 1969-70 w/ Gauges.....34.99 ea.
- GAC-660 1970-72 TCS Sender\*\*.....18.95 ea.

\*Can be used with CPX-999 harness. \*\*Correct 2 prong sending unit mounts on right side cylinder head.

ABR-0898



**AC Delco Water Pumps**

Brand new AC Delco water pumps.



- ABR-0898 1964-68 SB (Short Style).....63.95 ea.
- ABR-0918 1965-68 BB (Short Style).....119.99 ea.
- ABR-1109 1969-72 SB (Long Style).....65.95 ea.
- ABR-1002 1969-72 BB (Long Style).....89.99 ea.



ATR-3232



ATR-4334

**Water Pump OEM Attaching Bolt Kits**

Correct style attaching bolts with "TR" head markings.

- ATR-3232 1964-68 2 Bolts 2 Stud.....16.99 kit
- ATR-4334 1969-72 All 4 Bolts M Mark.....11.99 kit
- AWS-301S Stud Only (Short).....4.99 ea.

**Tuff Stuff Water Pumps**

Tuff Stuff water pumps are available in multiple different finishes. Available in standard flow or high flow (Super Cool) version for high power applications. Also available in "Smoothie" version, which features flat top casting with no top water port or plug.

**Small Block**

TUF-1354NA	1964-68 Short Style, Chrome .....	118.99 ea.
TUF-1354N	1964-68 Short Style, SC, Cast Finish .....	82.99 ea.
TUF-1354NC	1964-68 Short Style, SC, Black .....	95.99 ea.
TUF-1354NB	1964-68 Short Style, SC, Chrome .....	126.99 ea.
TUF-1354NAS	1964-68 Short Style, Smoothie, Chrome.....	124.99 ea.
TUF-1449NA	1969+ Long Style, Chrome .....	150.99 ea.
TUF-1511NC	1969+ Long Style, Platinum, Cast Finish .....	170.99 ea.
TUF-1449N	1969+ Long Style, SC, Cast Finish .....	82.99 ea.
TUF-1449NC	1969+ Long Style, SC, Black .....	95.99 ea.
TUF-1449NB	1969+ Long Style, SC, Chrome .....	168.99 ea.
TUF-1448NC	1969+ Long Style, SC, Smoothie, Cast Finish .....	131.99 ea.
TUF-1448NB	1969+ Long Style, SC, Smoothie, Polished Alum.....	168.99 ea.
TUF-1353NA7	1964-68 Short Style Smoothie Black Chrome .....	199.99 ea.
TUF-1448NA7	1969-77 Long Style Smoothie Black Chrome.....	209.99 ea.

**Big Block**

TUF-1494N	1964-68 Short Style, Cast Finish .....	89.99 ea.
TUF-1494NC	1964-68 Short Style, SC, Black.....	113.99 ea.
TUF-1494NA	1964-68 Short Style, SC, Chrome.....	150.99 ea.
TUF-1461NA	1969+ Long Style, Chrome .....	177.99 ea.
TUF-1461N	1969+ Long Style, SC, Cast Finish .....	101.99 ea.
TUF-1461NC	1969+ Long Style, SC, Black.....	121.99 ea.
TUF-1496NA7	1964-68 Short Style Smoothie Black Chrome .....	270.99 ea.
TUF-1495NA7	1964-68 Short Style, SC, Smoothie Black Chrome.....	350.99 ea.
TUF-1459NA7	1969-77 Long Style Smoothie Black Chrome .....	247.99 ea.

No Volume Discount.

**Tuff Stuff Water Pump Bolt Kits**

Chrome plated hex head bolts. Includes 4 bolts, 4 flat washers and 4 lock washers.

TUF-7675A	All SB, Short Style .....	20.99 ea.
TUF-7676A	All BB, Short Style .....	20.99 ea.



TUF-1354NA

TUF-4450A



**Tuff Stuff Chrome Heater Hose/Bypass Nipples**

Chrome plated heater hose/bypass hose fittings.

TUF-4450A	3/4" Long .....	11.99 ea.
TUF-4450B	3/4" Short.....	11.99 ea.
TUF-4450C	5/8" Short.....	11.99 ea.



TUF-7675A



AWP-1394



AWP-949



AWW-65

**Short Water Pump Washer**

This washer is for any Chevrolet engine with a short water pump. Since this part can't be seen when the pulley is installed, most people are unaware it exists, but it provides important support for the pulley.

AWW-65	1964-68 All .....	8.99 ea.
--------	-------------------	----------

\*Works on all cars with short water pump.



GCS-S9488

**Water Pump Pulley Nose**

Finish off your pulley set in style with this show quality nose. Bolts to the front of your water pump pulley when using electric fans.

GCS-S9488	SWP, Satin .....	18.99 ea.
GCS-S9488POL	SWP, Polished.....	19.99 ea.
GCS-S9489	LWP, Satin.....	17.99 ea.
GCS-S9489POL	LWP, Polished .....	22.99 ea.

Note: SWP = Short Water Pump. LWP = Long Water Pump.

GCS-S0005



GCS-S9478

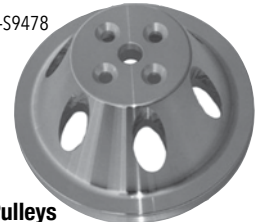

**Billet Water Pump Pulleys**

These show quality billet aluminum water pump pulleys will set your show car apart from the crowd. Made of high quality aircraft aluminum.

GCS-S9478	SB, SWP, 1 Groove, Satin .....	42.99 ea.
GCS-S9478POL	SB, SWP, 1 Groove, Polished .....	45.99 ea.
GCS-S9600	SB, SWP, 1 Groove, Chrome .....	26.99 ea.
GCS-S9479	SB, SWP, 2 Groove, Satin .....	58.99 ea.
GCS-S9479POL	SB, SWP, 2 Groove, Polished .....	60.99 ea.
GCS-S9601	SB, SWP, 2 Groove, Chrome .....	34.99 ea.
GCS-S9482	SB, LWP, 1 Groove, Satin.....	43.99 ea.
GCS-S9482POL	SB, LWP, 1 Groove, Polished.....	49.99 ea.
GCS-S9604	SB, LWP, 1 Groove, Chrome.....	26.99 ea.
GCS-S9483	SB, LWP, 2 Groove, Satin.....	61.99 ea.
GCS-S9483POL	SB, LWP, 2 Groove, Polished.....	65.99 ea.
GCS-S9605	SB, LWP, 2 Groove, Chrome .....	33.99 ea.
GCS-S8840	BB, SWP, 1 Groove, Satin .....	45.99 ea.
GCS-S8840POL	BB, SWP, 1 Groove, Polished .....	49.99 ea.
GCS-S8842	BB, SWP, 2 Groove, Satin .....	56.99 ea.
GCS-S8842POL	BB, SWP, 2 Groove, Polished .....	63.99 ea.
GCS-S9815	BB, SWP, 2 Groove, Chrome .....	36.99 ea.
GCS-S8844	BB, LWP, 2 Groove, Satin .....	58.99 ea.
GCS-S8844POL	BB, LWP, 2 Groove, Polished.....	68.99 ea.
GCS-S9723	BB, LWP, 2 Groove, Chrome.....	36.99 ea.
GCS-S0005	Tapered Seat Bolts.....	4.99 ea.

Note: SWP = Short Water Pump. LWP = Long Water Pump.



**Crank Pulleys**

All pulleys are original GM or the highest quality reproductions on the market. Each pulley is finished in factory matte black like the originals.

ACP-904	1964-67 327/350 1 Groove SWP	39.99 ea.
ACP-904-2	1964-68 327/350 2 Groove SWP	42.99 ea.
ACP-904-3	1964-68 327/350 3 Groove SWP	68.99 ea.
ACP-833	1966-67 L-79 2 Groove Deep SWP	59.99 ea.
ACP-414	1969-72 SB 3 Groove LWP	65.99 ea.
NQ-457	1969-72 350 2 Groove Deep LWP	81.99 ea.
ACP-313	1969-77 SB 1 groove LWP	56.99 ea.
ACP-203	1964-68 396 1 Groove* SWP**	49.99 ea.
ACP-108	1965-68 396/375 2 Groove Deep** SWP	54.99 ea.
ACP-333	1965-68 396/375 3 Grv Deep Cast SWP	318.99 ea.
AHQ-1396	1969-72 396 2 Groove Deep LWP	69.99 ea.
ACP-330	1969-72 396/454 3 Groove w/ AC LWP	64.99 ea.
ACP-404	1969-72 SB 2 Groove LWP	52.99 ea.

\*Without Power Steering.

\*\*For all with power steering use with ADP-61.



BFC-333

**Crank Pulley OEM Attaching Bolt Kit**

BFC-333	All w/ Fine Thread	6.95 kit
BRB-100	All w/ Coarse Thread	6.95 kit



BPB-5933



BPB-5934

**Harmonic Balancer Attaching Bolt-Washer**

BPB-5933	1964-72 Most SB	8.99 kit
BPB-5934	1965-72 All BB	12.99 kit



ASM-10A



ASM-20M

**Starter Motor**

We carry original AC Delco USA re-manufactured starter motors complete with warranty. No core charge.

ASM-10A	1964-72 SB Auto	113.99 ea.
ASM-10M	1964-72 SB Manual	113.95 ea.
ASM-20A	1965-72 BB Auto	99.99 ea.
ASM-20M	1965-72 BB Manual	102.99 ea.

No Volume Discount.



TUF-6550B

**Tuff Stuff Gear Reduction Starters**

These gear reduction starters will allow you to easily crank over your high performance engine. They use less draw than traditional replacement starters and gear reduction allows them to crank over engines with higher compression. These starters will work on both Small Block Chevy and Big Block Chevy Engines using 153 or 168 tooth flywheels. Please be sure to check your flywheel tooth count before ordering.

TUF-6550B	1.6 H.P., 11:1 Compression, White Zinc	154.99 ea.
TUF-6550A	1.6 H.P., 11:1 Compression, Chrome	197.99 ea.
TUF-6584B	1.9 H.P., 12:1 Compression, Black	150.99 ea.
TUF-6772B	2.6 H.P., 18:1 Compression, Black	191.99 ea.
TUF-3193NB	3 H.P., 18:1 Compression, White Zinc	189.99 ea.
TUF-3510A	1.9 H.P., 18:1 Compression, Chrome* OEM Style	180.99 ea.
TUF-3510B	1.9 H.P., 18:1 Compression, Black* OEM Style	134.99 ea.

\*Offset mounting bolts, 168 tooth flywheel only.



TUF-7629

**Tuff Stuff Hot Start Remote Solenoid Kit**

Give your starter an extra 12 V boost with these hot start kits from Tuff Stuff! This kit is designed to eliminate hot start problems that are common with starter-mounted solenoids. Ideal for GM full-size OEM starters.

TUF-7629	1964-77 All	25.99 kit
----------	-------------	-----------

No Volume Discount.



BV-2070

BV-2072

BV-2074

**Starter Motor Bolts OEM**

Correct "Knurled" bolts for attaching starter motor to block.

BV-2070	SB 3/8-16 x 1 7/8" (Short)	5.99 ea.
BV-2072	BB 3/8-16 x 3 5/8" (Long)	4.99 ea.
BV-2074	3/8-16 x 4 11/16" (X-Long)	6.99 ea.



APX-1443

**Starter Heat Shield**

Correct starter heat shield for most BB.

APX-1443	All BB	26.99 ea.
----------	--------	-----------

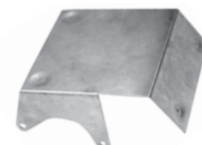

GCS-S6077

**Satin Finish Starter Heat Shield**

Protect your starter in style with this satin aluminum starter heat shield.

GCS-S6077	Satin	20.99 ea.
-----------	-------	-----------

Note: May require some custom fitting. May not clear larger starters.



ATE-4353

ABB-9655

**Starter Motor Brace**

Correct brace for attaching starter to block.

ATE-4353	1964-72 SB w/o 350.....	11.95 ea.
ATW-2516	1964-72 SB 350.....	8.95 ea.
ABB-9655	1964-72 All BB.....	12.99 ea.
APO-516	Attaching Screw.....	0.50 ea.



ABB-5790

ABN-105

**Alternator Pulleys**

ABB-5799	Standard (2-3/4" OD).....	20.99 ea.
ABB-5790	All w/ SHP (3-1/4" OD) Deep.....	44.99 ea.
ABN-105	Correct Retaining Nut.....	4.99 ea.



APX-1724



APX-2559

AVC-1144

**Alternator Accessories**

APX-1724	All Fan w/ Nut.....	15.99 kit
AVC-1144	1967-81 All Prgtail.....	4.95 ea.
APX-2559	Rear Alternator Boot.....	4.95 ea.



BN-339

BN-339	1969-72 BB Lower Stud/Nut.....	10.99 ea.
BZ-117	1965-68 BB Hardware Kit.....	18.99 kit
BRB-938	1969-72 SB Lower Bolt.....	4.95 ea.

**Alternator Hardware**

All of the correct hardware needed to mount your alternator!



APX-1138

APX-1138	1969-72 SB Spacer Brace.....	18.99 ea.
----------	------------------------------	-----------



APX-1038

APX-1038	1969-72 BB Spacer/Brace.....	15.95 ea.
----------	------------------------------	-----------



AWB-1114

AWB-1114	1964-72 Upper Adjustment Kit w/ W Bolt.....	5.99 kit
----------	---	----------



AW-506

AW-506	1964-72 Neg Cable Ground Bolt/Washer.....	0.95 ea.
--------	---	----------



ABC-23

ABC-23	1969-72 Battery Cable Clip SB.....	13.95 ea.
--------	------------------------------------	-----------

*For top of alternator*



ATE-5416

ATE-5416	1969-72 Heater Hose Retainer.....	6.99 ea.
----------	-----------------------------------	----------

*For top of alternator*



**Tuff Stuff Internally Regulated Alternators**

Designed to handle the demand for power needed for today's electronics, Tuff Stuff's high powered internally regulated alternators are perfect if you have added a set of high powered headlights or a high powered stereo system or any other electronic systems to your Chevelle. Although meant for 1971 and newer internally regulated set ups, they can be used on older models that have been converted from external to internally regulated.

TUF-7127NB	80 Amp, 1 Wire, Chrome.....	136.99 ea.
TUF-7127D	100 Amp, 1 Wire, Cast Finish.....	99.99 ea.
TUF-7127NF	100 Amp, 1 Wire, Black.....	136.99 ea.
TUF-7127ND	100 Amp, 1 Wire, Chrome.....	136.99 ea.
TUF-7127NDP	100 Amp, 1 Wire, Polished Aluminum.....	136.99 ea.
TUF-7127K	140 Amp, 1 Wire, Cast Finish.....	141.99 ea.
TUF-7127NK	140 Amp, 1 Wire, Chrome.....	156.99 ea.
TUF-7139ABULL	100 Amp, Silver Bullet, 1 Wire, Chrome.....	176.99 ea.
TUF-7140FBULL	140 Amp, Silver Bullet, 1 Wire, Black.....	194.99 ea.
TUF-7140ABULL	140 Amp, Silver Bullet, 1 Wire, Chrome.....	236.99 ea.
TUF-7127ND7	100 Amp 1 Wire Black Chrome V-Belt.....	160.99 ea.
TUF-7127ND6G7	100 Amp 1 Wire Black Chrome Serpentine Belt.....	160.99 ea.
TUF-7139ABULL7	100 Amp Silver Bullet 1 Wire Black Chrome V-Belt.....	206.99 ea.
TUF-7139ABULL6G7	100 Amp Silver Bullet 1 Wire Black Chrome Serpentine Belt.....	208.99 ea.
TUF-7127NK7	140 Amp 1 Wire Black Chrome V-Belt.....	183.99 ea.
TUF-7127NK6G7	140 Amp 1 Wire Black Chrome Serpentine Belt.....	184.99 ea.
TUF-7140ABULL7	140 Amp Silver Bullet 1 Wire Black Chrome V-Belt.....	277.99 ea.
TUF-7140ABULL6G7	140 Amp Silver Bullet 1 Wire Black Chrome Serpentine Belt.....	280.99 ea.

**Tuff Stuff Alternator Accessories**

TUF-7500A	Chrome Alternator Case Kit.....	70.99 kit
TUF-7600A	Chrome Fan and Pulley Kit, Single Groove.....	25.99 kit
TUF-7600B	Chrome Fan and Pulley Kit, Double Groove.....	29.99 kit
TUF-7610E	Chrome Alternator Pulley, Single Groove.....	19.99 ea.



### Tuff Stuff Externally Regulated Alternators

All Tuff Stuff alternators are hand built-in Cleveland, Ohio and are tested to meet or exceed OEM specifications. All Tuff Stuff alternators are made from 100% new components and carry a one year limited warranty. All alternators are for 12 volt, negative ground systems, except where noted.

TUF-7102	80 Amp Cast Aluminum V-Belt .....	99.99 ea.
TUF-7102NA	80 Amp Chrome V-Belt .....	137.99 ea.
TUF-7102NAP	80 Amp Polished Aluminum V-Belt .....	137.99 ea.
TUF-7102NF	80 Amp Black V-Belt .....	132.99 ea.
TUF-7102NC	100 Amp Chrome V-Belt .....	140.99 ea.
TUF-7102NCP	100 Amp Polished Aluminum V-Belt .....	140.99 ea.
TUF-7102NE	100 Amp Black V-Belt .....	132.99 ea.
TUF-7102NFBW	100 Amp Black Wrinkle V-Belt .....	136.99 ea.
TUF-7102NKBW	140 Amp Black Wrinkle V-Belt .....	164.99 ea.

No Volume Discount.



### Billet Alternator Fan

Polished billet aluminum.  
GCS-S8867 Polished ..... 14.99 ea.



### Chrome Alternator Fan w/ Pulley

Chrome plated steel OEM style alternator fan with chrome single groove pulley. Includes nut.  
GCS-S9446 Chrome ..... 16.99 kit



### Alternator Positive Terminal Cap Red

This is a new reproduction red plastic GM style alternator positive terminal cap and retainer kit. Check alternator to cylinder head clearance before ordering. Some applications are tight.

APX-ALT-CAP 1964-77 ..... 13.99 set



### Alternator Conversion Kits

These alternator conversion kits will make it easier than ever to install a modern alternator on your classic.

27555	External to Internal SI Style .....	28.99 ea.
37787	External to Internal CS Style .....	35.99 ea.
500295	SI to CS130D Style .....	36.99 ea.
500802	SI to Ford 3G Style .....	36.99 ea.

### Diode Kit

This kit is designed to prevent alternator feed-back to the ignition circuit. A common problem associated with internal regulated alternators.

500541 SI Series Diode Kit ..... 19.99 ea.

**NO CORE CHARGE**



### Alternators

Rebuilt alternator made in the USA. Each alternator is 100% tested and rebuilt to exceed OEM specs.

AIT-6961	41 Amp External Reg .....	79.95 ea.
AIT-6963	55 Amp External Reg .....	82.99 ea.
AIT-3342	63 Amp Internal Reg .....	84.99 ea.

No Volume Discount.



### Tuff Stuff Alternator Pigtails

Replace worn or broken alternator connectors with Tuff Stuff's replacement pigtails to eliminate any electrical issues. These will fit factory alternators.

TUF-7520B	Externally Regulated 10DN .....	11.99 ea.
TUF-7520A	Internally Regulated 10SI .....	8.99 ea.



### Alternator Dress Up Kit

This kit is designed to take your stock internally regulated alternator and make it show ready. This kit includes a chrome alternator case, pulley, fan and hardware.

GCS-S6679 1973-85 GM ..... 59.99 kit

Note: For 1973-85 internal regulated alternators only.

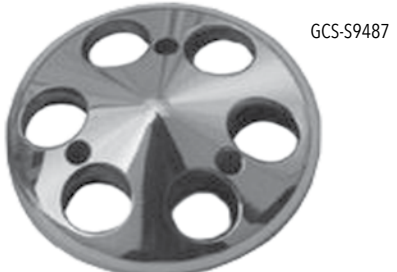

### Billet Alternator Pulleys

Show quality billet alternator pulleys.

GCS-S9487	1 Groove, Satin .....	30.99 ea.
GCS-S9487POL	1 Groove, Polished .....	34.99 ea.
GCS-S9447	2 Groove, Chrome .....	20.99 ea.

**Small Block Alternator Brackets**

OE style reproduction alternator brackets for your small block Chevy.

AAB-65L



AAB-65L 1964-68 SB Lower..... 17.95 ea.  
*\*Use with AAB-64L if you have headers.*

ACE-5333



ACE-5333 1969-72 SB Lower..... 17.99 ea.

AAB-3400



AAB-3400 1964-68 SB Upper..... 37.99 ea.

AAB-64L

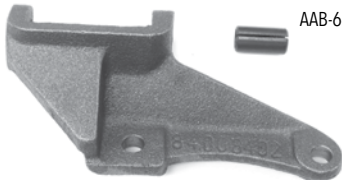

AAB-64L 1964-68 SB Lower..... 39.95 ea.  
*For exhaust manifolds.*

ACE-2956



ACE-2956 1969-72 SB Upper..... 34.99 ea.

**Big Block Alternator Brackets**

OE style reproduction alternator brackets for your big block Chevy.

AAB-4500



AAB-4500 1965-68 BB Upper..... 21.99 ea.

ARZ-0027



ARZ-0027 1965-68 BB Lower ..... 46.95 ea.

AK-173



AK-173 1969-72 BB Upper..... 24.99 ea.

AK-175



AK-175 1969-72 BB Lower ..... 20.99 ea.

AR-0180



**1965-68 SHP Alternator Bracket Kit**

Correct upper and lower bracket stamped "GT" for all 1965-68 SB.

AR-0180 1965-68 SHP ..... 79.95 kit

**BUY'N SAVE WITH KITS**



**1965-68 Big Block Alternator Bracket Kit**

This is a complete set of alternator brackets and hardware for your 1965-68 Chevelle big block with short water pump. This kit works on all cars with short water pumps.

AA-45KIT 1965-68 BB Short Pump..... 87.26 kit



**1969-72 Big Block Alternator Mounting Kit**

Reproduction of upper-lower brackets, lower mounting stud, lower spacer-brace and upper adjustment bolt w/ special washer.

AKK-301 1969-72 All BB..... 70.99 kit



**1970-73 Big Block Alternator Mounting Kit**









This kit comes with the upper alternator bracket featuring the correct 70+ hole, lower alternator bracket, lower mounting stud, lower spacer brace, upper adjustment bolt, and special washer for your 1970-1973 Chevelle big block.

AKK-305 1970-73 All BB..... 69.99 kit



### OE Style Chrome Alternator Brackets





These high quality brackets will give your show car that finishing touch!

	GCS-S9315			GCS-S9637		GCS-S9318		
GCS-S9315	SB Upper SWP.....	17.99 ea.	GCS-S9637	SB Lower LWP (69-75).....	8.99 ea.	GCS-S9318	BB Upper LWP (69-92).....	17.99 ea.
	GCS-S9316			GCS-S9502		GCS-S9638		
GCS-S9316	SB Upper LWP (69-75).....	17.99 ea.	GCS-S9502	BB Lower SWP.....	39.99 ea.	GCS-S9638	BB Lower LWP (69-92).....	9.99 ea.
	GCS-S9317			GCS-S9581		GCS-S9254		
GCS-S9317	SB Upper LWP (76-86).....	18.99 ea.	GCS-S9581	BB Upper SWP.....	16.99 ea.	GCS-S9254	Bracket for Headers.....	13.99 ea.



### Custom Style Alternator Brackets

These chrome plated steel alternator brackets will give your engine a unique custom look that will stand out from the crowd.

	GCS-S9319			GCS-S9320		GCS-S1637		
GCS-S9319	SB Upper SWP.....	16.99 ea.	GCS-S9320	V8 Upper LWP (69-75).....	14.99 ea.	GCS-S1637	SB Upper LWP (76-86).....	23.99 ea.
	GCS-S9321			GCS-S1647		GCS-S1647		
GCS-S9321	SB Upper LWP (76-86).....	15.99 ea.	GCS-S1647	BB Upper LWP (69-92).....	23.99 ea.			

### Timing Covers

New covers complete with crankshaft seal.

AJ-408	1968-76 All Small Block.....	48.95 ea.
AJ-SB-8	1969-70 SB w/ 8" Balancer*.....	96.99 set
AJ-850	1965-72 All Big Block.....	53.99 ea.
AJ-BB-7	1966-77 BB w/ 7" Balancer*.....	95.99 set
AJ-BB-8	1966-77 BB w/ 8" Balancer*.....	95.99 set
BTC-650	Correct Attaching Bolts.....	8.95 kit

\*Factory OEM style.



### Chrome Timing Covers

Brilliantly polished timing cover with a rigid sealing surface.

GCS-S4932	SB SWP Chrome.....	23.99 ea.
GCS-S4934	SB LWP Chrome.....	23.99 ea.
GCS-S4935	BB All Chrome.....	23.99 ea.
GCS-S4935R	BB All Unfinished Steel.....	20.99 ea.

Note: These covers may not work with some double roller timing chains. Check clearance before starting engine. Doubling of the gaskets or shims may be required to use cover with a short water pump. SWP = Short water pump. LWP = Long water pump.



### 2 Piece Aluminum Timing Covers

An excellent upgrade for your engine. Rigid sealing surface for positive seal and it looks great, too!

GCS-S6040	SB Polished Billet.....	30.99 ea.
GCS-S6040C	SB Chrome Billet.....	55.99 ea.
GCS-S8422	BB Polished Billet.....	54.99 ea.
GCS-S8422C	BB Chrome Billet.....	62.99 ea.

Note: These covers may not work with some double roller timing chains. Check clearance before starting engine. Doubling of the gaskets or shims may be required to use cover with a short water pump.





ATP-07

**Timing Cover Pointers**

Correct pointer for adjustment of engine timing.

ATP-07	1965-68 SB.....	8.99 ea.
ATP-36	1969-72 SB.....	7.99 ea.
ATP-47	1965-72 SB w/ 7" Bal.....	13.99 ea.
ATP-07	1965-72 BB SHP w/ 8" Bal.....	8.99 ea.



GCS-S4961

**Chrome Adjustable Timing Pointers**

Provides a convenient way to adjust and verify your engine's ignition timing. Finished brilliant chrome plated steel.

GCS-S9178	SB 7".....	9.99 ea.
GCS-S9179	SB 8".....	9.99 ea.
GCS-S4961	BB 8".....	5.99 ea.
GCS-S9180	BB 8" Adjustable.....	6.99 ea.



GCS-S6041

GCS-S6042C

**SB Billet Timing Cover Pointer**

Provides a convenient way to adjust and verify your engine's ignition timing. Adjustable and can be used with 6" or 7" balancers.

GCS-S6041C	Chrome Plated Billet.....	26.99 ea.
GCS-S6042	Ball Milled.....	28.99 ea.
GCS-S6042C	Ball Milled Chrome.....	28.99 ea.
GCS-S4960	Chrome Plated Steel.....	6.99 ea.
GCS-S6041	Billet.....	27.99 ea.



GCS-S2083

**Chrome Holley Carburetor Throttle Return Kit**

Designed to make mounting the spring a snap! Works on most Holley carburetor applications.

GCS-S2083	Holley.....	16.99 kit
-----------	-------------	-----------

Note: Due to the universal nature of this part, fitting and/or modifications may be required.



ACE-1400

**Distributor Hold Down**

Correct retaining hardware for distributors

ACE-1400	All V8.....	13.99 kit
----------	-------------	-----------



GCS-S5116

**Custom Distributor Hold Down Kit**

Designed to secure your distributor settings and look good doing it. Choose from chrome or billet.

GCS-S4116	Chrome.....	6.99 ea.
GCS-S5116	Billet.....	19.99 ea.



GRC-12835

**Radio Capacitor**

Came from the factory on all cars with radio. Correct length lead wire & brass connector. Stamped 1964452 "DR" & ".3MF" as original.

GRC-12834	1964-71.....	39.99 ea.
GRC-12835	1970-74.....	39.99 ea.



N-2441

**Tune Up Kit**

Tune up kit with new points, condenser and rotor.

N-2441	1964-73 All.....	49.99 ea.
--------	------------------	-----------



ALI-65



ALI-3119

BAN-516

**Coil Bracket**

Reproduction of original comes with retaining screw.

ALI-65	1965 L79.....	99.95 ea.
ALI-3119	All V8.....	20.99 ea.
BAN-516	Correct SEMS Bolts.....	1.95 pr.



ALI-1504

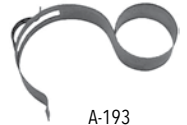

A-193

**Starter Solenoid Wire Clip**

Correct clip for retaining wire harness to solenoid.

ALI-1504	1964-67 All V8.....	17.99 ea.
A-193	1968-72 All V8.....	24.95 ea.



GCS-S9366

**Chrome Ignition Coil Bracket**

This brightly chrome plated ignition coil bracket will look great in your engine compartment. Fits most round cylinder style ignition coils.

GCS-S9366	Coil Bracket.....	8.99 ea.
-----------	-------------------	----------



GCS-S3112

**HEI Distributor Pigtail**

GCS-S3112	All.....	13.99 ea.
-----------	----------	-----------



1971244



**Distributor Cap**

Choose from AC Delco replacement distributor cap or reproduction distributor cap with GM numbers. Red cap features heavy duty brass terminals for high performance engines.

1971244	Black Cap.....	79.99 ea.
AAD-308	Replacement.....	22.95 ea.



ADS-2100-SC-CLEAR



ADS-2100-SC-RED

**HEI Distributor**

Chrome aluminum HEI electronic distributor w/ built-in 50K coil.

ADS-2100	All V8	94.99 ea.
ADS-2100-SC-RED	All V8, Red Super Cap	99.99 ea.
ADS-2100-SC-CLEAR	All V8, Clear Super Cap	97.99 ea.
GCS-S3938-BLUE	16 Blue Super Cap*	90.99 ea.

\* For 292 Inline 6 cyl. only.



ACCEL-59107



**Accel Replacement HEI Distributor**

Using all new components, these distributors feature: High performance ACCEL Electronics. All new components-housing castings, ce. Direct plug-in replacement with factory type connector. Fits standard deck height small and big block engines. Coil Not Included!

ACCEL-59107	All w/ HEI	176.99 ea.
-------------	------------	------------

No Volume Discount.



MSD-8362



**MSD HEI Distributor**

For value conscious enthusiasts, the Street Fire HEI is a great choice! We know the importance of a centrifugal advance in a distributor so our engineers made sure that the Street Fire received an advance assembly with coated weights and welded weight pins (not just pressed in like other models). Another area that you cannot afford to scrimp on is with a distributor gear. The Street Fire is fit with the same gear that is used on our Pro-Billet models. The metallurgy of this gear has been refined for years to perform through the harshest conditions.

MSD-8362	All, Red Cap 4 Pin*	213.99 ea.
MSD-8365	All Billet, Red Cap 4 Pin*	560.99 ea.

Note: Standard deck height blocks only. Will not fit gen 5 and 6 big blocks. \*Refers to the amount of terminals on the ignition module. No Volume Discount.



MSD-8360



**MSD Pro Billet Distributor**

The Pro-Billet Ready-to-Run distributor is the perfect upgrade for outdated points distributors or bulky HEIs. Simply install the distributor in the engine, connect three wires, the coil and fire it up!

MSD-8360	Chevy V8*	453.99 ea.
MSD-85551	Chevy V8**	352.99 ea.

\*Does not have nor can accept a vacuum advance canister.

\*\*Must be used with a MSD 6,7, or 8 ignition box.

Note: Standard deck height blocks only. Will not fit gen 5 and 6 big blocks. No Volume Discount.



**Mallory Unilite Distributor**

A legend returns - the tried and true Mallory Unilite Distributor line is back! The easy three wire hookup of the Unilite makes running a stock coil, a Mallory performance coil and even a Mallory HyFire CD ignition a snap. Supplied with a quality cap and rotor, the Mallory Unilite also provides a fully adjustable mechanical advance to dial in the perfect timing curve for a multitude of engine combinations. The Unilite features a compact housing that lends itself well to applications where space is a premium due to tight firewall clearance or blower applications.

MAL-3748201	All SBC, BBC*	398.99 ea.
-------------	---------------	------------

\*Standard deck height blocks only. Will not fit gen 5 and 6 big blocks. No Volume Discount.



MSD-6201



**MSD Ignition**

An MSD Ignition will improve the overall performance of your engine thanks to its high output capacitive discharge sparks. Below 3,000 rpm the ignition delivers multiple sparks that will clean up the idle, improve starting and throttle response. If you're looking to improve the performance of your modified mill, we have the answer. Whether you've done a cam swap, or bolted on a carb, intake and headers, the 6A is a surefire way to harness all the ponies under your hood. Step up to the 6AL to have an engine saving rev limiter.

MSD-6201	Red All 6A	292.99 ea.
MSD-6425	Red All 6AL	339.99 ea.
MSD-64253	Black All 6AL	339.99 ea.
MSD-6421	Red All 6AL-2	403.99 ea.

No Volume Discount.



GAC-505

**Coil**

Choose from our new reproduction Delco coils with GM numbers or GM replacement coil.

GAC-505	1964-73 All Replace	39.95 ea.
---------	---------------------	-----------

\*427/454 transistor ignition. No Volume Discount.



GCS-S2039BK

**External Ignition Coils**

Choose from our upgraded external ignition coils. 45,000-volt output. Anodized finish, includes pigtails and hardware for installation.

GCS-S2039BK	All, Black	55.99 ea.
GCS-S2039BLU	All, Blue	57.99 ea.

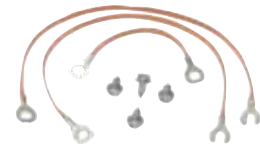

APJ-5240

**Ground Strap Kit**

Correct braided copper wire and ends complete with OEM screws.

APJ-5240	1964+ (3 pc.)	19.99 kit
----------	---------------	-----------



APX-1300



APX-8100



APX-1200

**Wire Separators**

Correct spark plug wire separators.

APX-1300	1969-72 SB/BB Left Rear	17.99 ea.
APX-1200	1969-72 SB Left Front	17.99 ea.
APX-8100	All BB Right Side	17.99 ea.



AX-423



AX-486



AX-486A

**Spark Plug Wire Stands**

New reproduction of originals.

AX-423	All SB (Right Side)	14.95 ea.
AX-486A	1968 All SB (Left Side)	27.95 ea.
AX-486	1969-72 All SB (Left Side)	27.95 ea.



APX-5022

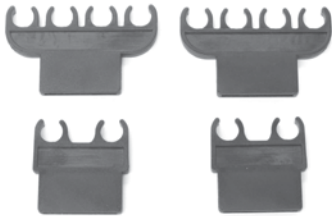

APX-5023

**Valve Cover Spark Plug Wire Loom Kits**

Correct spark plug wire separators for valve covers.

APX-5022	SB (6 pc.).....	21.99 kit
APX-5023	BB (4 pc.).....	12.99 kit



**"Dated" Spark Plug Wire Set**

New reproduction wire set correctly dated for your specific car, pre-cut and ready to install! Each set features correct colored wires and correct angle "cut" boots. Please give your sales rep your desired date. Non-HEI cars only.

Here's how to order:

ALL-70BB1Q.....99.99 set

*\*For example, if the build date of your car was on or before January 15th of the model year order 3rd quarter of the previous year. If the build date was after January 15th of the model year order 1st quarter of that year. i.e. A 1970 Chevelle built on or before Jan 15th of 1970 would receive 3-Q-69 and after would be 1-Q-70.*



AHC-1508

**Spark Plug Wire Sets**

New pre-cut OEM replacements.

AHC-1508	All SB.....	39.95 set
AHC-2508	All BB.....	39.95 set
AHC-3508	All w/ HEI.....	54.99 set



MSD-35593

**MSD Ignition Spark Plug Wires**

Engineered from the inside out, the 8.5 offers everything you have ever wanted in a wire; incredibly low resistance without electronic interference! In a single 12 inch length of Super Conductor Wire there is only 40 - 50 ohms of resistance!

**Without Headers**

MSD-31359 Red, SBC 350 HEI w/o Headers.... 118.99 kit

**With Headers**

MSD-35593	Black, SBC 350 HEI* Cap .....	124.99 kit
MSD-35599	Red, SBC 350 HEI* Cap.....	124.99 kit
MSD-35603	Black, BBC 350 HEI* Tower Cap ...	130.99 kit
MSD-35609	Red, BBC 350 HEI* Tower Cap ....	130.99 kit
MSD-35653	Black, SBC 350 HEI* Tower Cap. ...	127.99 kit
MSD-35659	Black, SBC 350 HEI* Cap .....	127.99 kit

\*Works on any HEI or MSD style cap with male terminals.

No Volume Discount.

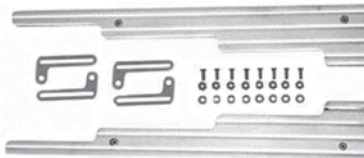

GCS-S6038



GCS-S6038X

**Billet Spark Plug Wire Looms Small Block**

These wire looms will keep your spark plug wires neat and organized, minimizing wear on the wires. Also prevents cross firing and grounding of the wires. Choose from plain, ball milled or milled flames in either polished billet or chrome billet. Includes mounting hardware.

GCS-S6039	Plain, Polished .....	55.99 kit
GCS-S6039C	Plain, Chrome .....	83.99 kit
GCS-S6038	Ball Mill, Polished .....	54.99 kit
GCS-S6038C	Ball Mill, Chrome .....	80.99 kit
GCS-S6038X	Flames, Polished .....	61.99 kit
GCS-S6038XC	Flames, Chrome.....	90.99 kit

Note: Fits up to 9.5 mm wires.



GCS-S7251

**Universal Chrome Wire Looms Big Block**

These wire looms will keep your spark plug wires neat and organized, minimizing wear on the wires. Also prevents cross firing and grounding of the wires.

GCS-S7251	Universal.....	23.99 kit
-----------	----------------	-----------

Note: Fits up to 9 mm wires.



AC43

**AC Delco Spark Plugs**

This is a brand new set of 8 spark plugs for your Chevrolet. These high quality reproduction AC Delco spark plugs feature the correct green AC and markings as original.

AC43	1964-70 #43 .....	62.99 set
AC44	1964-70 #44 .....	62.99 set
AC45	1964-70 #45 .....	62.99 set

Note: The number on the plug refers to it's operating temperature. The lower number is a cooler running plug which is typically found on the SHP high performance engines. A hotter, higher numbered plug would be used in engines where plug fouling may be or is a problem.



APX-650

**Spark Plug Heat Shield Kit SB**

Correct die stamped shields and arms for most small blocks without Rams Horn style manifolds. Complete with mounting hardware.

APX-650	1964-72 SB.....	44.99 kit
BXX-650	Bolts (4) .....	1.00 kit

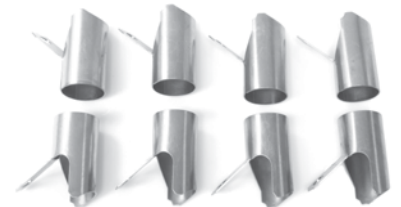

AT-3030

**OEM Style Spark Plug Heat Shield Kit BB**

This is a set of correctly stamped spark plug heat shields which are silver Cadmium plated just as original.

AT-3030	1965-72 BB .....	62.99 kit
---------	------------------	-----------



APX-6584

**Spark Plug Heat Shield Kit BB**

Correct stamped shields for various Chevrolet cars with BB engines (8pcs).

APX-6584	1965-72 BB .....	39.99 kit
----------	------------------	-----------



AD-052



AZ-840



ASH-695

### Smog Tube & Extension

Correct pre-bent powder coated AIR smog tubes and extensions.

AD-252	1969-72 SB Tubes w/o AC .....	119.99 pr.
AD-052	1969-72 BB Tubes w/o AC .....	109.99 pr.
AZ-840	1967-72 Extension .....	8.95 ea.

### Smog Hose Kit

Original OEM ribbed hose complete with white stripe vacuum hose, T fittings and clamps.

ASH-695	All SB Complete .....	41.95 kit
ASH-69B	All BB Complete .....	41.95 kit
CPN-100	OEM Vacuum Hose Only .....	1.95 pr ft



AVC-100



AVC-542



GCS-S6145BK

### 1968 Small Block SHP Valve Covers

Accurate reproductions of the original 1968 Special High Performance (SHP) valve covers in chrome or ready to paint EDP coating.

AVC-542	Chrome .....	170.99 pr.
AVC-543	Paintable .....	129.99 pr.

### "Motion" Valve Covers

Original style Cal Custom finned valve covers featuring the notorious Baldwin Motion die cast logos.

AVC-100	Most BB (Blank) .....	199.00 pr.
MOTION-VC	Most BB "Motion" .....	289.95 pr.

Note: 2-5/8" - 3" inside clearance.



ATE-4207



GCS-S6142



GCS-S6145POL

### Finned Aluminum Valve Covers

Reproduction of original GM high performance valve covers.

ATE-4207	SB .....	229.99 pr.
HVC-28	Flag Decal .....	10.99 ea.

### Fabricated LS1 Valve Covers

2.5" height to clear aftermarket valve train. Includes oil cap, O-ring type gasket and bolts. Available with or without mounts for coil brackets.

GCS-S6141	LS1, No Coil Bracket Mounts, Anodized .....	203.99 pr.
GCS-S6141C	LS1, No Coil Bracket Mounts, Chrome .....	233.99 pr.
GCS-S6141POL	LS1, No Coil Bracket Mounts, Polished .....	221.99 pr.
GCS-S6142	LS1, w/ Coil Bracket Mounts, Anodized .....	182.99 pr.
GCS-S6142C	LS1, w/ Coil Bracket Mounts, Chrome .....	220.99 pr.
GCS-S6142POL	LS1, w/ Coil Bracket Mounts, Polished .....	203.99 pr.
GCS-S6142G	LS1 O-Ring Type Gasket .....	10.99 pr.
GCS-S6142BOLT	LS1 Valve Cover Bolt Kit .....	8.99 kit
GCS-S6143	LS1 Coil Mounting Brackets .....	27.99 pr.

### Fabricated Tall Height Valve Covers

High quality fabricated aluminum valve covers. Mounting hardware included. Available with or without breather holes.

GCS-S6144C	SB, No Hole, Chrome .....	179.99 pr.
GCS-S6144POL	SB, No Hole, Polished .....	157.99 pr.
3-3/4" height		
GCS-S6145	SB, Flat Top, w/ Hole, Anodized .....	144.99 pr.
GCS-S6145C	SB, Flat Top, w/ Hole, Chrome .....	167.99 pr.
GCS-S6145POL	SB, Flat Top, w/ Hole, Polished .....	152.99 pr.
GCS-S6145BK	SB, Flat Top, w/ Hole, Black .....	164.99 pr.
GCS-S6147	SB, Flat Top, No Hole, Anodized .....	129.99 pr.
GCS-S6147C	SB, Flat Top, No Hole, Chrome .....	148.99 pr.
GCS-S6147POL	SB, Flat Top, No Hole, Polished .....	129.99 pr.
3-7/8" height		
GCS-S6244	BB, Long Screw, No Hole, Anodized ..	181.99 pr.
GCS-S6244C	BB, Long Screw, No Hole, Chrome ..	203.99 pr.
GCS-S6244POL	BB, Long Screw, No Hole, Polished ..	194.99 pr.
3 1/2" height		
GCS-S6248	BB, Short Screw, w/ Hole, Anodized ..	175.99 pr.
GCS-S6248POL	BB, Short Screw, w/ Hole, Polished ..	161.99 pr.
3-1/2" height		

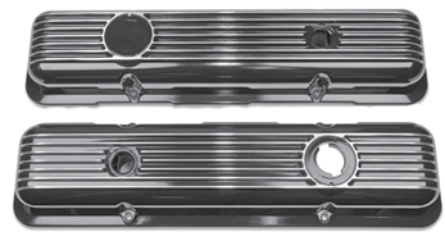

ATE-4207-BLK

### Finned Aluminum Valve Covers - Black

Black finned aluminum valve covers based on the popular LT-1 covers.

ATE-4207-BLK	SB .....	229.95 pr.
--------------	----------	------------



GCS-S6047BK

**Small Block Center Bolt Ball Milled Valve Covers**

These aluminum valve covers are a great custom touch to any street machine or sleeper.

GCS-S6047BK Center Bolt Small Block.....150.99 pr.  
Fits 1987 and newer small block with center bolt heads except LS.



GCS-S6336

**Small Block Tall Valve Covers**

These high quality small block Chevy valve covers are a great way to dress up your motor, as well as gain some extra clearance for roller rockers.

GCS-S6336 Chevrolet Logo, Black .....277.99 pr.  
GCS-S7618 Chevrolet Logo, Orange .....274.99 pr.  
GCS-S6341POL Chevrolet Logo, Polished .....314.99 pr.  
GCS-S7617 383 Stroker Logo, Black .....236.99 pr.  
GCS-S7619 383 Stroker Logo, Orange .....258.99 pr.



AVC-540

**1967 Chevrolet Script Valve Covers**

Excellent reproductions of the original stamped "Chevrolet" valve covers in chrome or ready to paint EDP coating. These valve covers feature the correct wire retainers and "O" stamp.

AVC-540 Chrome.....199.99 pr.  
AVC-541 Paintable.....154.99 pr.



XA-101S-OE



**BUY'N SAVE**  
WITH KITS

**Big Block Valve Cover Kit**

Save money on our complete kit! All kits come complete with the following items: (2) valve covers, (2) gaskets, valve cover retainers and TR bolts, (2) V.C. grommets, V.C. oil cap, V.C. elbow and hose and V.C. wire separators.

XA-101 w/o Left Slant w/ Drippers .....169.04 kit  
XA-101S w/ Left Side Slant\* w/ Drippers .....169.04 kit

\*Use slanted valve covers when brake booster clearance may be an issue.

OE kits with silver gaskets, correct oil cap and Tonawanda decal.

XA-101-OE w/o Left Slant w/ Drippers .....186.03 kit  
XA-101S-OE w/ Left Slant\* w/ Drippers .....186.07 kit

\*Use slanted valve covers when brake booster clearance may be an issue.



ALS-1065

**Original Style Chrome Valve Covers**

These reproduction covers offer the highest quality chrome plating, correct wire stands and factory oil deflectors "drippers". Valve covers are available with a left side slant to increase booster clearance in tight engine compartments. Also available in tall style to fit roller rockers.

ALS-1065 All BB w/o Slant .....69.99 pr.  
ALS-1165 All BB w/ Left Side Slant.....69.99 pr.  
ACC-3362 All BB w/o Drippers.....51.99 pr.  
ACC-3365 All BB w/ Slant w/o Drippers.....51.99 pr.  
ALS-1065XT All BB Tall w/o Left Slant.....89.95 pr.  
ALS-1165XT All BB Tall w/ Left Slant.....89.95 pr.



396TVC-1

**"Turbo Jet" Valve Covers**

Cal Custom finned valve covers featuring the famous "Turbo Jet" medallions.

396TVC-1	All BB "396".....	299.99 pr.
427TVC-1	All BB "427".....	229.95 pr.
454TVC-1	All BB "454".....	229.95 pr.
502TVC-1	All BB "502".....	229.95 pr.
572TVC-1	All BB "572".....	229.95 pr.

2-5/8" - 3" inside clearance. Will work with most roller rockers.



427VC-1

**"427" Valve Covers**

Like our "YENKO" covers with cast "427" medallions.

427VC-1	Most BB "427".....	229.95 pr.
427VC-R	Most BB "427" Red.....	229.95 pr.

2-5/8" - 3" inside clearance. Will work with roller rockers.



AT-3662



AT-3666

**Small Block Valve Covers**

New original style early small block Chevrolet covers. These covers come ready to install in correct Chevrolet Orange or chrome plated.

AT-3662	SB Chrome Covers.....	144.99 pr.
AT-3666	SB Orange Covers.....	119.99 pr.



454VC-R

**"454" Valve Covers**

Original Cal Custom style valve covers featuring red "454" medallions.

454VC-R	Most BB "454".....	229.95 pr.
---------	--------------------	------------

2-5/8" - 3" inside clearance. Will work with most roller rockers.



HARREL-VC

**Dick Harrel Aluminum Valve Covers**

"Cal Custom" finned aluminum covers feature the notorious Dick Harrel die cast medallions.

HARREL-VC	Most BB.....	229.95 pr.
-----------	--------------	------------

2-5/8" - 3" inside clearance. Will work with most roller rockers.



GCS-9215B

**Black Painted Valve Covers**

This is a pair of high quality tall black painted valve covers. A great inexpensive custom touch to any street machine or sleeper!

GCS-9215B	1964-77 SB.....	31.99 pr.
-----------	-----------------	-----------



SS427VC-R

**"SS 427" Valve Covers**

Original Cal Custom style valve covers featuring red "SS 427" medallions.

SS427VC-R	Most BB "SS 427".....	279.95 pr.
-----------	-----------------------	------------

2-5/8" - 3" inside clearance. Will work with most roller rockers.



YSCVC-1

**"Yenko" Valve Covers**

These "Cal Custom" style finned aluminum covers feature the notorious "YENKO" Red, White and Blue die cast logos.

YSCVC-1	Most BB "YENKO".....	229.95 pr.
---------	----------------------	------------

2-5/8" - 3" inside clearance



ALS-1165-OJ

**Big Block Valve Covers - Chevrolet Orange**

This is a pair of brand new big block valve covers painted in Chevy orange. These valve covers are correct for most big blocks and will fit cars with power brakes.

ALS-1165-OJ	All Big Block.....	109.99 pr.
-------------	--------------------	------------



AFP-059

**Valve Cover Gaskets**

AFP-057	All SB.....	11.99 pr.
AFP-059	All BB.....	22.99 pr.
AFI-9797	BB w/ Silver Coating.....	25.99 pr.



APB-1027



APB-1023

**Valve Cover Retainers OEM Bolt Kits**

Correct steel stamped zinc plated retainers & OEM bolts.

APB-1023	SB TR Bolts (16 pc.).....	14.95 kit
APB-2023	BB TR Bolts (28 pc.).....	23.99 kit
APB-1027	SB M Aluminum (8 pc.).....	16.99 kit



APO-2043



APR-2136

**Valve Cover Oil Caps**

Choose from either chrome GM replacement, chrome reproduction with correct "S" or black rubber push-in cap.

APX-5763	Replacement.....	6.95 ea.
APR-2136	Reproduction "S".....	17.99 ea.
APO-2043	Rubber "OIL".....	5.95 ea.



APB-3508



APB-3509

**Valve Cover Grommet Original GM**

APB-3508	All SB.....	9.99 pr.
APB-3509	All BB.....	12.99 pr.



APT-3509



APT-3960

**Valve Cover Elbows**

Correct GM steel valve cover elbows.

APT-3960	All SB.....	12.95 ea.
APT-3509	All BB.....	12.99 ea.



APH-3843



APH-2109

**Valve Cover Hose**

Correct marked OEM hose which extends from valve cover to air cleaner base. Choose from open or closed element.

APH-3961	All SB Open.....	12.99 ea.
APH-3843	All BB Open.....	5.99 ea.
APH-2109	1970-72 BB Closed Element.....	15.99 ea.



AEH-999

**Oil Pans**

OEM supplier.

AJ-221	1964-72 SB w/o SHP.....	119.99 ea.
AEH-999	1965-72 All BB.....	169.99 ea.



**Small Block Finned Aluminum Oil Pans**

These finned aluminum oil pans will help keep your oil cooler and add some custom style to your street machine or sleeper. New mounting bolts and drain plug are included.

GCS-S8442BK	1955-79 SB.....	105.99 ea.
<i>2-piece rear main seal, drivers side dipstick.</i>		
GCS-S8443BK	1980-85 SB.....	105.99 ea.
<i>2-piece rear main seal, passenger side dipstick.</i>		
GCS-S8444BK	1986 + SB.....	115.99 ea.
<i>1-piece rear main seal, passenger side dipstick.</i>		



APC-744

**Oil Pan Clip**

Correct clip for retaining positive battery cable routing to solenoid.

APC-744	All SB-BB.....	5.95 ea.
---------	----------------	----------



BPO-1988



**Oil Drain Bolt/Washer**

Original GM.

BPO-1988	All SB/BB.....	6.95 ea.
----------	----------------	----------



ACP-1SB

**Oil Pan Gasket Set**

Correct OEM gaskets.

ACP-1SB	All SB.....	19.95 ea.
ACP-2BB	All BB.....	16.95 ea.



BOP-2002

**Oil Pan Attaching OEM Bolt Kit**

Correct "L" head marked bolts for attaching pan to block

BOP-2001	All SB (18 pc.).....	9.95 ea.
BOP-2002	All BB (24 pc.).....	26.99 ea.



AJ-4

**Oil Pan Baffle / Windage Tray**

Often installed on most High Performance cars, this "windage tray" was used to keep oil from splashing the crankshaft. A MUST!

AJ-4	Small Block.....	44.99 ea.
AJ-6	Big Block.....	29.99 ea.



NFX-25

**Oil Canister - Filter**

Reproduction of early canister style filter.

NFX-25	PF-25 AC Filter "White".....	26.99 ea.
--------	------------------------------	-----------





**Oil Pressure Fittings**

N-137	1968+ All SB .....	7.99 ea.
N-133	All BB w/o SHP .....	18.99 ea.
N-142	All BB w/ SHP .....	24.99 ea.
N-A6474	Back of Gauge Fitting .....	6.95 ea.



**Oil Dipstick Kits**  
Complete with tube and gauge (stick).

ATE-1567	1964-79 SB (Green Dot) .....	33.99 ea.
ATE-1576	1965-72 BB (Yellow Dot) .....	49.99 ea.

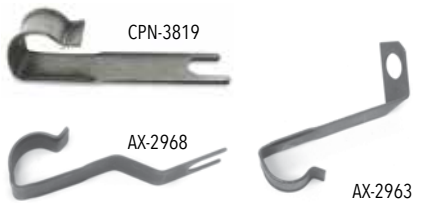

**PCV Retaining Hose Clip**  
Reproduction of original PCV hose retaining clip, with correct bends and black phosphate coating.

CPN-3819	All w/ Holley .....	16.99 ea.
AX-2963	1965-67 BB Q-Jet .....	24.99 ea.
AX-2968	1966 BB 360 HP .....	16.99 ea.



**Oil Pressure Lines**  
Correct material lines with correct fittings for all cars with gauges.

N-1131	1964-67 (Steel Coiled) .....	33.95 ea.
CHO-3200	1968+ (Black Plastic) .....	10.99 ea.



**Chrome Dipsticks w/ Braided Tubes**  
Stainless steel braided tube with chrome handle.

**Bell Housing Mount**

GCS-S5004	TH350 .....	45.99 ea.
GCS-S5005	TH400 .....	45.99 ea.
GCS-S5006	TH700-R4 .....	45.99 ea.

**Firewall Mount**

GCS-S5104	TH350/TH400 29" .....	52.99 ea.
GCS-S5106	TH700-R4 .....	52.99 ea.



**TCS Littlefuse Rel**  
This is an reproduction of the correct littlefuse TCS relay. This authentic reproduction features 4 prongs as original.

ATCS-33R	1970-72 .....	54.99 ea.
----------	---------------	-----------

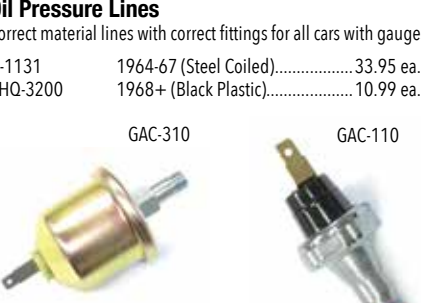

**Oil Pressure Switches**  
Correct GM switches for cars without manual gauges.

GAC-310	1969 w/ Gauges .....	39.99 ea.
GAC-110	1970-72 w/ Gauges .....	11.95 ea.
GAC-110	1964-72 w/o Gauges .....	11.95 ea.



**Billet Engine Dipstick with Braided Tube**  
Show quality billet aluminum dipstick with braided tube.

GCS-S5002	1955-79 SB .....	38.99 ea.
GCS-S5001	1980-95 SB .....	38.99 ea.
GCS-S5003	1965-90 BB .....	44.99 ea.

*Note: Oil level varies depending on the oil pan used. You may need to mark the dipstick with your own new full level mark.*



**TCS Transmission Switches**  
Correct TCS switch located on transmission.

ATS-21MP	1970-75 Pin Style .....	36.99 ea.
ATS-21MS	1970-75 Spade Style .....	36.99 ea.

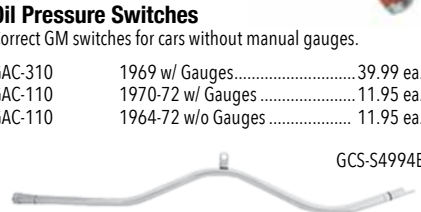

**Chrome Transmission Dipsticks and Tubes**  
Show quality dipsticks are an excellent upgrade to any engine compartment. Includes dipstick & tube.

GCS-S4922	Powerglide .....	15.99 ea.
GCS-S9421	TH350 .....	15.99 ea.
GCS-S9421BA	TH350 Billet Handle .....	24.99 ea.
GCS-S4994	TH350 34" .....	16.99 ea.
GCS-S4994BA	TH350 34" Billet Handle .....	19.99 ea.
GCS-S4995	TH400 24" .....	13.99 ea.
GCS-S4995BA	TH400 24" Billet Handle .....	17.99 ea.



**Billet Aluminum Engine Dipstick**  
Show quality dipstick with billet handle. 11.5" length.

GCS-S6060	Handle .....	0.99 ea.
-----------	--------------	----------

*Note: Oil level varies depending on the oil pan used. You may need to mark the dipstick with your own new full level mark.*



**TCS Wire Retainer**  
Correct reproduction for Muncie.

ATS-653	1970-74 w/ Muncie .....	21.99 ea.
---------	-------------------------	-----------

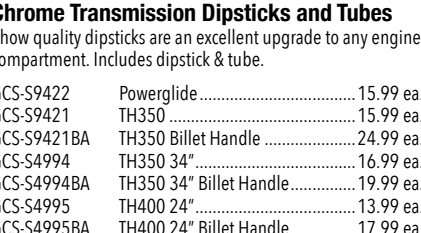

**Chrome/Billet Dipsticks & Tubes**  
Show quality dipsticks with matching tubes. A great upgrade to any engine compartment!

GCS-S4957	1955-79 SB, Chrome, 19" .....	7.99 ea.
GCS-S4957BA	1955-79 SB, Billet, 19" .....	13.99 ea.
GCS-S9420	1980-82 SB, Chrome, 23" .....	9.99 ea.
GCS-S9420BA	1980-82 SB, Billet, 23" .....	15.99 ea.
GCS-S9231	1983-85 SB, Chrome, 24.5" .....	11.99 ea.
GCS-S9231BA	1983-85 SB, Billet, 24.5" .....	13.99 ea.
GCS-S4958	1965-90 BB, Chrome, 21" .....	10.99 ea.
GCS-S4958BA	1965-90 BB, Billet, 21" .....	12.99 ea.

*Note: Oil level varies depending on the oil pan used. You may need to mark the dipstick with your own new full level mark.*



**Engine Block Lifting Ring**  
These correct steel stamped lifting rings were installed at the engine plant for ease of installation.

APX-1015	Most SB .....	36.99 set
APX-1115	All BB .....	25.99 set
BPX-230	Lifting Ring Bolt .....	0.95 ea.



**Motor Mount Clip**  
Correct clip for attaching positive cable to right side motor mount.

ATW-2853	Most V8's .....	19.95 ea.
----------	-----------------	-----------



AMC-103KIT



**Engine Mounting Kits**

Perfect for converting to a V8 or for upgrading your small block to a big block! Each kit includes all of the necessary motor mounts, frame brackets, motor mount thru bolts, frame bracket bolts and motor mount to block bolts so you can do the job right!

AMC-10SBKIT	1964-67 SB.....	140.28 kit
AMC-103KIT	1964-67 BB .....	135.78 kit
ACE-9794KIT	1968-72 V8.....	140.21 kit

No Volume Discount.

ENG-103KIT-G



**Poly Engine Mount Kits**

Same as our OE style engine mount kits with upgraded Energy Suspension Poly motor mounts. The poly mounts can take the abuse of todays high performance engines, yet still absorb driveline vibrations. They are available in Poly Graphite black or red.

ENG-10SBKIT-G	1964-67 SB Black.....	196.07 kit
ENG-10SBKIT-R	1964-67 SB Red.....	196.07 kit
ENG-103KIT-G	1964-67 BB Black.....	191.57 kit
ENG-103KIT-R	1964-67 BB Red.....	191.57 kit
ENG-9794KIT-G	1968-72 V8 ALL* Black .....	178.04 kit
ENG-9794KIT-R	1968-72 V8 ALL* Red.....	178.04 kit

\*Except 307. No Volume Discount.



**UMI Poly Engine Mounting Kit**

UMI's poly engine mount kit is a bolt-in direct replacement for those worn out factory rubber and clamshell mounts.

UMI-90071	1978-88 All Small Block Chevy...	119.99 kit
-----------	----------------------------------	------------



AMC-103

**Frame Brackets**

Reproduction of the long discontinued GM brackets for mounting the engine to frame of car. Sold in matched pairs.

AMC-10SB	1964-67 SB.....	89.99 pr.
AMC-103	1964-67 BB.....	84.99 pr.
ACE-9794	1968-72 All V8.....	62.99 pr.
APX-2339	1964-72 All V8 Bolts To Frame.....	6.95 kit

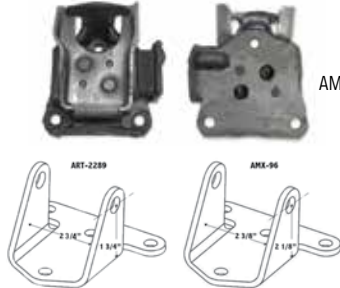

AMX-96

**Motor Mounts OEM**

These new motor mounts are from GM's original supplier! MADE IN USA!!! Measure your frame brackets before ordering.

ART-2289	1964-67 Most V8.....	39.99 pr.
AMX-96	1968-72 Most V8.....	69.95 pr.

Use ART-2289 w/ AMC-10SB & AMC-103. Use AMX-96 for ACE-9794.



**Poly Graphite Motor Mounts**

Energy Suspension mounts can take the abuse of todays high performance engines. Poly Graphite bushings can last longer than stock rubber mounts while handling more power, yet able to absorb most driveline vibrations.

3-1114G	1964-67 Black 2-5/8" W x 3/4" H.....	50.99 ea.
3-1114R	1964-67 Red 2-5/8" W x 3/4" H.....	50.99 ea.
3-1117G	1968-72 Black 2-3/8" W x 1-3/16" H.....	55.99 ea.
3-1117R	1968-72 Red 2-3/8" W x 1-3/16" H.....	55.99 ea.
3-1116G	1973-88* Black.....	34.99 ea.
3-1116R	1973-88* Red.....	34.99 ea.

Two mounts required per car.\*You must reuse your original clamshells on the 1973-88 by drilling out the rivets and replacing the rubber insert with the new Poly Graphite mount.

**Motor Mount Attaching Bolt Kit**

Correct style bolts for attaching mount to block.

BJ-998	All (12 pc.).....	8.95 kit
--------	-------------------	----------



**Motor Mount "Thru" Bolt Kit**

Correct OEM bolts for retaining mount to frame bracket. Comes complete with special high strength washers and cadmium plated locking nuts as original.

APB-9057	1964-67 All 4.5".....	9.99 kit
APB-7057	1968-72 All 3.5".....	6.95 kit



GCS-S6053

**Stainless Steel Kickdown Cables**

Show quality look with more adjustability than your factory cable.

GCS-S6053	TH350.....	40.99 ea.
GCS-S6051	TH700-R4.....	46.99 ea.

Note: For carburetor applications only.



GCS-S9620

GCS-S9619

**Chrome Throttle Cable Brackets**

Designed to work with your GM throttle cable on most carburetor applications. Available with or without kickdown provision.

GCS-S9619	w/o Kickdown.....	11.99 kit
GCS-S9620	w/ Kickdown.....	11.99 kit

Note: Due to the universal nature of this part fitting and/or modifications may be required.



**Chrome Universal Carburetor Throttle Return Kit**

GCS-S2291

Designed to make mounting the spring a snap! Works on most carburetors.

GCS-S2291	Universal.....	7.99 kit
-----------	----------------	----------

Note: Due to the universal nature of this part fitting and/or modifications may be required.



ATH-3369

AZC-88

**Accelerator Cables**

Choose from GM service replacement cables or new reproductions complete with casings and bushings as original.

ATH-3863	1968-72 SB 2 bbl GM.....	34.99 ea.
ATH-2679	1968-72 SB 4 bbl GM.....	52.99 ea.
ATH-3862	1968-72 BB Q-Jet GM.....	39.99 ea.
ATH-3369	1968-72 BB Holley GM.....	49.99 ea.
336969R	1968-72 Repro for Holley.....	21.99 ea.
3972679R	1968-72 Repro for Q-Jet.....	21.95 ea.
AZC-88	1968-72 Cable Clip GM.....	6.95 ea.
AXJ-CE	Cable Decal.....	4.95 ea.



AWM-4169K



**Wiper Motor**

New correct wiper motor assembly and washer pump ready to install.

AWM-4169	1968-72 w/ Hidden Wipers 1st Design Motor Only.....	169.99 ea.
AWM-4169K	1968-72 w/ Hidden Wipers 1st Design with Washer Pump.....	199.99 ea.

**Windshield Wiper Motors**

Original AC Delco re-manufactured units built with original cores. *No Volume Discount.*

AWM-119



AWM-119	1964-66 1 Speed.....	149.95 ea.
---------	----------------------	------------

AWM-8242



AWM-8242	1968-72 w/o Hidden .....	149.99 ea.
----------	--------------------------	------------

AWM-83T



AWM-83T	1966-67 2 Speed 3 Terminal .....	149.95 ea.
AWM-84T	1967 2 Speed 4 Terminal.....	159.99 ea.

AWM-4169R



AWM-4169R	1968-72 w/ Hidden* .....	169.99 ea.
-----------	--------------------------	------------

\*Replacement style. Plug is not in original location.\* Second design with slot for electrical connector in the base plate.



AWP-6971W



**OEM Style Washer Pump**

New OE style reproduction washer pump with correct white nozzles!

AWP-6971W 1968-72 w/ Hidden Wipers.....59.99 ea.  
AWP-64C 1964-77 Cover Only.....19.99 ea.

AWP-6971



AWP-6971-2D



AWP-6488



**Washer Pumps**

Original washer pumps.

AWP-6971 1968-72 w/o Hidden .....79.99 ea.  
AWP-64C 1964-77 Cover Only.....19.99 ea.  
AWP-6488 1964-77 Single Speed Cover Only.....14.99 ea.  
AWP-6971-2D 1968-72 w/ Hidden 2nd Design\* .....79.99 ea.

\* Second design with slot for electrical connector in the base plate.

WIPERKIT-HIDE-C



**Hidden Wiper Arm & Transmission Kits**

Looking to refurbish or replace major components of your wiper system? Look no further with Ground Up Motor Sports's exclusive wiper kits! This hidden wiper kit includes two wiper arms, two wiper blades and the wiper transmission arm. Deluxe kits include a wiper motor.

WIPERKIT-HIDE-C 1968-72 Chrome Arms..... 197.98 kit  
WIPERKIT-HIDE 1968-72 Satin Arms..... 197.95 kit

**Deluxe Kits**

WIPERKIT-HIDE-DLX-C 1968-72 Chrome Arms..... 350.97 kit  
WIPERKIT-HIDE-DLX 1968-72 Satin Arms..... 350.94 kit

No Volume Discount.



APW-STRAP-L



APW-2401

**Wiper Motor Mount Kit**

Correct steel rubber grommets & screws for mounting motor to firewall.

APW-2401 1964-72 All .....11.99 kit  
AWS-2002 1964-77 All Screws Only ..... 6.99 set  
APW-STRAP w/o Hidden Wipers .....3.99 ea.  
APW-STRAP-L w/ Hidden Wipers ..... 4.99 ea.



AWS-992



AWS-7

**Wiper Motor Seals**

Correct foam rubber seal for firewall.

AWS-992 1964-65 2 Speed ..... 7.99 ea.  
AWS-6 1964-66 1 Speed ..... 4.95 ea.  
AWS-7 1967 All ..... 6.99 ea.  
AWS-792 1968-72 w/o Hidden ..... 6.99 ea.  
AWS-992 1968-72 w/ Hidden ..... 7.99 ea.

**LWA-1400K CLOSE UP**



LWA-1400K

LWA-68-PIN

**Wiper Transmission Arm**

Finally available, reproduction wiper transmission arm.

LWA-1418X 1964-65 All .....119.95 ea.  
LWA-1400J 1966-67 All .....119.95 ea.  
LWA-1400K 1968-72 All .....119.99 ea.  
AWS-1001 1964-72 Screws (to Cowl) (4pc.) ..... 7.99 set  
LWA-68-PIN 1968-72 w/ Hidden ..... 11.99 ea.

AWA-688



**Wiper Motor Arm**

Correct wiper motor arm with ball stud.

AWA-688 1968-72 ..... 19.99 ea.

AWM-SEAL



**Hidden Wiper Motor Arm Seal**

AWM-SEAL 1964 2 Speed 1968-77 ..... 14.99 ea.

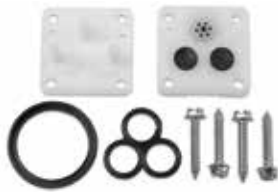

AHL-5400

### Washer Pump Repair Kit

Correct white plastic nozzle, rubber seals and screws to repair your original washer pump.

AHL-5400 1964-72 All ..... 11.99 ea.



NTN-681

### Washer Nozzles

Reproduction washer nozzles complete with correct mounting screws.

NTN-647 1964-65 All ..... 29.99 pr.  
 NTN-667 1966-67 All ..... 29.99 pr.  
 NTN-681 1968-69 All ..... 29.99 pr.  
 NT-612 1970-72 All ..... 29.99 pr.  
 AVN-101 Correct Screws ..... 0.95 pr.



AWJ-0892



AWJ-0083

### Washer Jars

Correct white plastic washer jars.

AWJ-0083 1964-69 All ..... 6.99 ea.  
 AWJ-0083-CAP 1964-69 Jar & Cap Kit ..... 12.70 kit  
 AWJ-0892 1970-72 All ..... 16.95 ea.  
 AWJ-0892K 1970-72 Jar & Cap Kit ..... 22.41 kit  
 AWJ-10M 1970-72 Mounting Screws ..... 0.95 pr.  
 1964-69 uses bracket. 1970-72 screws to fender.

AWB-8939



### Washer Jar Bracket

Correct bracket for mounting jar to fender.

AWB-8939 1964-69 All ..... 11.99 ea.  
 AVB-591 Mounting Screws ..... 0.95 pr.

APX-9738



### Washer Cap Kit

Correct GM cap, ribbed hose and pick up screen.

APX-9738 1964-72 All Cap Kit ..... 7.95 kit  
 AWJ-8372 1964-72 Cap Only ..... 4.95 ea.  
 AWJ-100 1964-72 Screen Only ..... 2.95 ea.



APH-1132

### Washer Hose Kit

Correct GM ribbed thin walled style washer hose in pre cut lengths (7/32 - 11/32 diameter. This kit does one car.)

APH-1132 1964-72 All ..... 11.95 kit



WFL-7072

### Wiper Fluid Level Sensor

This monitor mounts in the windshield washer fluid jar and attaches the fiber optic line in the wire harness and transmits the fluid level to a monitor on the dash.

WFL-7072 1970-72 All ..... 69.99 ea.

*Must reuse your original fiber optic line and dash monitor.*

*No volume discount.*



GAC-723

### Horn Relay

New reproduction of the original GM Delco style relay.

GAC-723 1964-71 ..... 52.95 ea.  
 GAC-775 1972-73 ..... 56.99 ea.  
 AVN-506 Mounting Screw ..... 0.95 ea.



ACY-100



ACY-KIT

### Frame & Body Marking Crayon Kit

These paint sticks are used for final detailing to replicate the marks left on the frame and other parts of the car, just like when it came down the factory assembly line.

ACY-100 All (2pc) ..... 5.99 kit  
 ACY-KIT All (12 pc) ..... 34.99 kit



NC-113

### Hood Insulation

Correct die stamped OEM material for insulating the underside of the hood. A MUST for final detailing!

NC-108 1964 All ..... 29.99 ea.  
 NC-109 1965 All ..... 29.99 ea.  
 NC-112 1966 All ..... 29.99 ea.  
 NC-113 1967 All ..... 29.99 ea.  
 NC-114 1968-69 All ..... 29.99 ea.  
 NC-115 1970-72 Flat ..... 29.99 ea.  
 NC-116 1970-72 SS 1st Design ..... 29.99 ea.  
 NC-117 1970-72 CI 2nd Design ..... 29.99 ea.  
 NC-169 1973-77 All ..... 36.99 ea.



ADR-3-GM



ADR-3H



ADR-3-CHROME

### Horns

Reproduction Delco Remy horns correct for most Chevelles. These horns feature the correct high and low notes. Brackets included.

ADR-3-GM 1964-72 Universal Horn Set ..... 139.99 kit  
 ADR-3-CHROME 1964-72 Repro Chrome ..... 159.99 pr.  
 ADR-3H 1964-77 Horn Set\* ..... 159.99 kit

*\*Brackets may require some modification.*



AMH-15

### Underhood Lamp

Complete with bracket, hardware, harness and built-in switch.

AMH-15 1967-77 All ..... 52.99 kit



GRC-12834

**Voltage Regulator Radio Capacitor**

Came from the factory on all cars with radio. Correct length lead wire & white connector. Stamped 1964086 "DR" & ".5MF" as original.

GRC-12834	1967-71	39.99 ea.
GRC-12835	1970-74	39.99 ea.



R89-TOP



R59-TOP

**Battery Toppers**

This new plastic injection molded cover will give your modern battery the look and feel of an original! This topper works with Group 24-60 sized batteries only. Inside size = 6-7/8 x 10-3/8.

R59-TOP	1967-72 R-59	54.99 ea.
R89-TOP	1969-72 R-89 Side	54.99 ea.



ASR-64ABB



ASR-64ASB

**Spring Ring Cables**

Reproduction of the original factory installed spring type cables sold as a matched pair with GM numbers.

ASR-64ASB	1964-67 SB	160.18 pr.
ASR-64ABB	1964-67 BB	160.18 pr.
ASR-68ASB	1968 SB	111.92 pr.
ASR-68ABB	1968 BB	160.18 pr.
ASR-69ASB	1969-72 SB	160.18 pr.
ASR-69ABB	1969-72 BB	160.18 pr.



500723

**Trunk Mounted Battery Cable Kit Top Post**

This is a true 1 gauge battery cable kit. Overall cable length of 18 feet, and the negative cable includes a 36 inch 10 gauge secondary lead. Complete with terminal lugs, crimp tool and shrink tubing.

500723	All w/ Top Post	189.99 kit
--------	-----------------	------------

No volume discount.



AST-1001

**Side Terminal Battery Cables**

Correct cables for cars with the heavy duty R-89 batteries with correct GM part numbers.

AST-1001	1969-72 HD	124.99 kit
----------	------------	------------



GAC-515



GAC-515GM

**Voltage Regulator**

New correct GM replacement.

GAC-515	1964-71 All D635	84.99 ea.
GAC-515GM	1964-71 All D635 OE Style	94.99 ea.
AVX-515	1968-71 Screws (2)	0.95 kit
AWX-818	1964-67 Mounting Kit	6.95 kit



GQH-118

**Electric Junction Block**

Original GM junction block for attaching positive lead from battery to main harness. Mounts to radiator support. Includes correct nut.

GQH-118	1964-72 All	9.95 ea.
---------	-------------	----------



ABR-9533

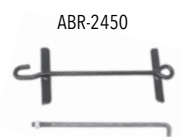

ABR-2450

**Battery Retainer Kits**

Complete battery retainer kits with all correct hardware.

ABR-2450	1964-65 All	15.95 kit
ABR-9533	1966-72 All	3.99 kit

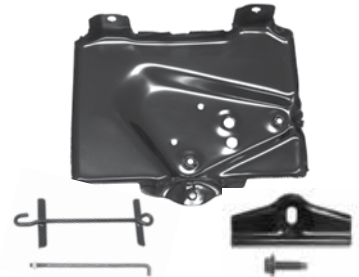

ABT-6006K

**Battery Trays**

Reproduction EDP coated battery trays.

ABT-6465	1964-65 All (Tray Only)	22.99 ea.
ABT-6465K	1964-65 (Tray & Retainer)	35.05 kit
ABT-6006	1966 All (Tray Only)	16.99 ea.
ABT-6006K	1966 All Kit (Tray & Retainer)	17.83 kit
ABT-0067	1967 All (Tray Only)	22.99 ea.
ABT-0067K	1967 All Kit (Tray & Retainer)	22.93 kit
ABT-6872	1968-72 All (Tray Only)	16.99 ea.
ABT-682K	1968-72 Kit (Tray & Retainer)	18.88 kit
ABT-7888	1978-88 All (Tray Only)	36.99 ea.



GCS-S9323

**Stainless Steel Battery Tray With Hold Downs**

Universal fit. Fits batteries measuring 7-1/2 long, 13-1/4 wide, 9-1/4 tall. Does not include hooks.

GCS-S9323	Universal Fit	39.99 kit
-----------	---------------	-----------



TENDER-0128

**Battery Tender**

The Battery Tender Plus is a 1.25 amp battery charger designed to fully charge a battery and maintain it at proper storage voltage without the damaging effects caused by trickle chargers. Included is a quick connect harness for hard to reach areas. Temperature compensated to ensure optimum charge voltage according to ambient temperature. Automatically switches from full charge to float charging mode. Battery Tender at 1.25 amps will charge as fast or faster than any 3 amp charger available. Reverse Polarity Protection to ensure user safety. Complete 4-step charging program (Initialization, Bulk Charge, Absorption Mode, Float Mode).

TENDER-0128	Battery Tender	59.95 ea.
-------------	----------------	-----------



FG2001



FG2005



FG2031



FG2044



FG2003



FG2007



FG2042



FG2046

### Fender Gripper

If you spend a lot of time working under the hood but don't want to scratch your paint a Fender Gripper is the answer! Made of non-slip material, the Fender Gripper will not slide off slick surfaces.

- Soft and cushioned for protection
- Tools will not slip off fender cover
- Completely washable 22 X 34 standard size
- Strong PVC product reinforced with nylon mesh
- Impervious to motor oil, coolant, lacquer thinner, brake fluid, etc.
- Many favorite brand logos are available
- Will not harm your paint

FG2001	Bowtie.....	29.99 ea.
FG2003	Genuine Chevrolet.....	29.99 ea.
FG2005	Heartbeat of America.....	29.99 ea.
FG2007	Chevrolet Racing.....	29.99 ea.
FG2048	El Camino.....	29.99 ea.
FG2031	Chevelle.....	29.99 ea.
FG2042	General Motors.....	29.99 ea.
FG2044	SS.....	29.99 ea.
FG2046	Super Sport.....	29.99 ea.
FGSS396	SS396 Logo.....	29.99 ea.
FGGUM	Ground Up Motors Logo.....	29.99 ea.



### Eddie Motorsports Billet Hood Hinges

These billet hood hinges are machined from 6061-T6 aluminum and will add an awesome custom touch to your engine compartment. They bolt-in and require no cutting of your sheet metal. Complete with stainless steel nitrogen gas shocks and all stainless steel fasteners.

M= Machined  
P= Polished  
R= Red Fusioncoat  
B= Blue Fusioncoat  
W= White Fusioncoat

PR= Purple Fusioncoat  
BK= Gloss Black Fusioncoat  
BKA= Gloss Black Anodized  
MB= Matte Black Fusioncoat



MBA= Matte Black Anodized  
CL= Clear Coat  
CA= Clear Anodized

M

P

R, B, W, PR, BK,  
BKA, MB, MBA,  
CL, CA

MS149-40	1964 All	.....695.99 pr.....	745.99 pr.....	690.99 pr.
MS149-53	1965-67 All	.....695.99 pr.....	745.99 pr.....	690.99 pr.
MS149-58	1968 All	.....695.99 pr.....	745.99 pr.....	720.99 pr.
MS149-57	1969-72 All	.....695.99 pr.....	745.99 pr.....	720.99 pr.



RHG-BH12

### Billet Hood Hinges

Give your engine bay a custom touch with these affordable billet hood hinges! These hood hinges come complete with heavy duty struts and hardware. Sold as a pair with hardware.

RHG-BH11	1965-67 All	.....459.99 kit
RHG-BH12	1968 All	.....449.99 kit

No Volume Discount.



RHG-996L

### OE Style Pre-Assembled Hood Hinges

These hood hinges are for the purist who won't settle for anything less than the best! Sold each or as a set of left and right hinges with the correct springs pre-installed. They feature an OE correct black phosphate coating just like the OEM.

RHG-142WSK	1965-67 All LH & RH	.....116.98 ea.
RHG-142WSL	1965-67 All LH	.....64.99 ea.
RHG-142WSR	1965-67 All RH	.....64.99 ea.
RHG-996K	1968 All LH & RH	.....199.99 kit
RHG-996L	1968 All LH	.....100.99 ea.
RHG-996R	1968 All RH	.....100.99 ea.
RHG-998K	1970-72 All LH & RH	.....209.99 kit
RHG-998L	1970-72 All LH	.....100.99 ea.
RHG-998R	1970-72 All RH	.....100.99 ea.
BPA-381	3/8" x 1 Bolt	.....0.65 ea.

Note: Bolts are not included.



RHG-68L



RHS-642

### Hood Hinges

High quality reproduction hood hinges.

RHG-64L	1964 All LH	.....64.99 ea.
RHG-64R	1964 All RH	.....64.99 ea.
RHG-142L	1965-67 All LH	.....44.99 ea.
RHG-142R	1965-67 All RH	.....44.99 ea.
RHG-667L	1965-67 All LH	.....120.99 ea.
RHG-667R	1965-67 All RH	.....120.99 ea.
RHG-68L	1968 All LH	.....49.99 ea.
RHG-68R	1968 All RH	.....49.99 ea.
RHG-69L	1969 All LH	.....49.99 ea.
RHG-69R	1969 All RH	.....49.99 ea.
RHG-70L	1970-72 All LH	.....49.99 ea.
RHG-70R	1970-72 All RH	.....49.99 ea.
RHG-73L	1973-77 All LH	.....72.99 ea.
RHG-73R	1973-77 All RH	.....72.99 ea.
RHS-642	1964-77 Hood Hinge Spring	.....15.99 ea.

RHG-68KWS



### Hood Hinge Kit 1968-72 Repro Style

These are high quality reproduction hood hinges complete with springs and featuring a black EDP coating.

RHG-68KWS	1968 All LH & RH	.....119.99 kit
RHG-69KWS	1969 All LH & RH	.....119.99 kit
RHG-70KWS	1970-72 All LH & RH	.....119.99 kit
BPA-381	3/8" x 1" Bolt	.....0.65 ea.

Note: Bolts are not included.



**Eddie Motorsports Billet Hood Latch Assembly**

CNC machined from a solid chunk of 6061-T6 aluminum and stainless steel. This is a direct replacement for your cheap stock stamped steel hood latch. The EMS billet hood latch kit comes complete with a billet aluminum base plate and billet stainless steel pilot bolt and retaining cup. Stainless steel fasteners and billet aluminum finishing washers are also included.

M = Machined Fusioncoat  
P = Polished  
R = Red  
B = Blue Fusioncoat  
W = White Fusioncoat

PR = Purple Fusioncoat  
BK = Gloss Black Fusioncoat  
BKA = Gloss Black Anodized  
MB = Matte Black Fusioncoat  
MBA = Matte Black Anodized

CL = Clear Coat  
CA = Clear Anodized



		<u>M</u>	<u>P</u>	<u>R, B, W, PR,</u> <u>BK, BKA, MB,</u> <u>MBA, CL, CA</u>
MS276-20	1965	183.99 ea.	213.99 ea.	172.99 ea.
MS276-21	1966	138.99 ea.	160.99 ea.	172.99 ea.
MS276-15	1967	183.99 ea.	213.99 ea.	172.99 ea.
MS276-10	1968-69	169.99 ea.	189.99 ea.	167.99 ea.
MS276-12	1970-72	179.99 ea.	189.99 ea.	172.99 ea.



**Hood Catch**

Correct catch which mounts on underside of hood.

RHR-64	1964 All	39.95 ea.
RHR-66	1966 All	39.99 ea.
RHR-L70	1970-72 All	44.99 ea.
RHR-70	1970-72 All OE Correct	60.99 ea.



**Hood Pin Kit - Hair Pin Style**

Universal chrome hood pin kit for use on any vehicle.

GCS-S4051	All	9.95 kit
-----------	-----	----------



HPK-BC



HPK-BB

**Billet Aluminum Hood Pin Kits Peel N Stick**

These hood pin kits are a great way to add that protouring/racing look without drilling or cutting your hood. The pin mounts are either chrome plated or black aluminum with chrome pins and feature rubber coated cables. They attach with high quality double sided 3M adhesive tape.

HPK-BC	Chrome All	29.99 kit
HPK-BB	Black All	29.99 kit



RVL-65A



RVL-66A



RVL-69



RVL-70A

**Hood Latch Support**

Correct support that runs vertically and attaches to the radiator support.

RVL-65A	1965 All	39.99 ea.
RVL-66A	1966 All	39.99 ea.
RVL-67A	1967 All	39.99 ea.
RVL-68	1968 All	42.99 ea.
RVL-69	1969 All	39.99 ea.
RVL-70A	1970 All	39.99 ea.
RVL-1488G	1971-72 All	39.99 ea.



RHR-70X

**Hood Release Handle**

Reproduction of this often missing or broken pull handle.

RHR-70X	1970-72 All	29.99 ea.
---------	-------------	-----------

RHL-65



**1964-65 Hood Release**

Reproduction hood release assembly.

RHL-65	1964-65 All	84.99 ea.
--------	-------------	-----------

RHL-66



**1966 Hood Release**

Reproduction hood release assembly.

RHL-66	1966 All	94.99 ea.
--------	----------	-----------

RHL-67



**1967 Hood Release**

Reproduction hood release assembly.

RHL-67	1967 All	94.99 ea.
--------	----------	-----------

RHL-68



**1968 Hood Release**

Reproduction hood release assembly.

RHL-68	1968 All	99.99 ea.
--------	----------	-----------

RHL-69



**1969 Hood Release**

Reproduction hood release assembly.

RHL-69	1969 All	59.99 ea.
--------	----------	-----------

RHR-59



**1970-72 Hood Release**

Reproduction hood release assembly.

RHR-59	1970-72 All	89.99 ea.
--------	-------------	-----------

IRC-7377



**1973-77 Hood Release Cable and Handle**

Inside hood release cable and handle.

IRC-7377	1973-77 All	74.99 ea.
----------	-------------	-----------





Detail shot of a Master Body Hardware kit. These kits have all of the hard to find items that are not available anywhere else!



**AMK Master Body Hardware Kit**

Master body kits contain just about every piece of hardware to assemble the body of your Chevelle. Each kit contains hardware for your battery tray, bumpers, filler panel, filler panel moldings, bumper brackets, cowl vent panel, door latches, emblems, eyebrows, fender braces, fenders, front tie bar, grille, grille brackets, grille moldings, headlamps, headlamps bezels, hood, hood hinges, hood latch, hood latch support, license plate, mirrors, parking lamps, tail lamps, trunk latch, trunk lid hinges, wheel opening moldings, wheel houses, radiator support and more! This kit truly has it all!

64AB	1964 Chevelle	259.99 kit
65AB	1965 Chevelle	259.99 kit
66AB	1966 Chevelle	249.99 kit
67AB	1967 Chevelle	259.99 kit
68AB	1968 Chevelle	259.99 kit
69AB	1969 Chevelle	249.99 kit
70AB	1970 Chevelle	254.99 kit
71AB	1971 Chevelle	249.99 kit
64EB	1964 El Camino	299.99 kit
65EB	1965 El Camino	299.99 kit
66EB	1966 El Camino	299.99 kit
67EB	1967 El Camino	279.99 kit
68EB	1968 El Camino	279.99 kit
69EB	1969 El Camino	269.99 kit
70EB	1970 El Camino	274.99 kit
71EB	1971 El Camino	279.99 kit



**AMK Interior Screw Kit**

64AN-CP	1964-65 Chevelle Coupe	159.99 set
64AN-CV	1964-65 Chevelle Convertible	139.99 set
66AN-CP	1966 Chevelle Coupe	164.99 set
66AN-CV	1966 Chevelle Convertible	159.99 set
67AN-CP	1967 Chevelle Coupe	189.99 set
67AN-CV	1967 Chevelle Convertible	179.99 set
68AN-CP	1968 Chevelle Coupe	199.99 set
68AN-CV	1968 Chevelle Convertible	189.99 set
69AN-CP	1969 Chevelle Coupe	199.99 set
69AN-CV	1969 Chevelle Convertible	194.99 set
70AN-CP	1970-72 Chevelle Coupe	224.99 set
70AN-CV	1970-72 Chevelle Convertible	219.99 set

**AC Box Under Hood Hardware**

All the hardware related to the AC under the hood on the firewall forwards.

64AA-F	1964-65	29.99 kit
66AA-F	1966	34.99 kit
67AA-F	1967	26.99 kit
68AA-F	1968	49.99 kit
69AA-F	1969	49.99 kit
70AA-F	1970-72	42.99 kit

**AC On Engine Hardware**

All the hardware related to the AC brackets on the engine.

64AA-SB	1964-65 SB	32.99 kit
66AA-SB	1966-67 SB	33.99 kit
66AA-BB	1966 BB	39.99 kit
67AA-SB	1967 SB w/ Smog	29.99 kit
67AA-BB	1967 BB	44.99 kit
68AA-SB	1968 SB	29.99 kit
68AA-SB	1968 SB w/ Smog	31.99 kit
68AA-BB	1968 BB	44.99 kit
69AA-SB	1969 SB	42.99 kit
69AA-BB	1969 BB	34.99 kit
70AA-SB	1970 SB	39.99 kit
70AA-BB	1970-72 BB	36.99 kit
71AA-SB	1971 SB	36.99 kit
72AA-SB	1972 SB	36.99 kit

**Master Chassis Kit**

Typical kit includes fasteners to attach: accelerator lever & support, axle housing, springs, axle retainer plates, brake booster & hose, brake cables, brake plates, brake hose retainers & brackets, brake valve & pressure switch, calipers & brackets & shields, upper & lower control arms, control arm bushings, differential cover, driveshaft, engine mounts, fuel filler neck cover, fuel hoses, gas tank, grease fittings, idler arm, master cylinder & push rod, parking brake control, pitman arm, radius rod & bracket & bumper, shocks & brackets, stabilizer bar brackets and end links (includes rubber), steering gear & rag joint, steering linkage & ball joints, speedometer cable, trans, suspension bumper, transmission crossmember & insulator, wheel cylinders.

64AS-SB	1964-67 SB Drum Brakes (331 pc)	269.99 kit
65AS-BB	1965-67 BB Drum Brakes (339 pc)	289.99 kit
67AS-BB	1967 BB Disc Brakes (338 pc)	289.99 kit
68AS-DRSB	1968 SB Drum Brakes (341 pc)	279.99 kit
68AS-DCSB	1968 SB Disc Brakes (346 pc)	289.99 kit
68AS-BB	1968 BB Disc Brakes (345 pc)	279.99 kit
69AS-DRSB	1969 SB Drum Brakes (339 pc)	294.99 kit
69AS-DCSB	1969 SB Disc Brakes (337 pc)	299.99 kit
69AS-BB	1969 BB Disc Brakes (349 pc)	319.99 kit
70AS-DRSB	1970 SB Drum Brakes (335 pc)	279.99 kit
70AS-DCSB	1970 SB Disc Brakes (333 pc)	319.99 kit
70AS-BB	1970 BB Disc Brakes (349 pc)	339.99 kit
71AS-DRSB	1971-72 SB Drum Brakes (337 pc)	279.99 kit
71AS-DCSB	1971-72 SB Disc Brakes (337 pc)	299.99 kit
71AS-BB	1971-72 BB Disc Brakes (352 pc)	319.99 kit

No Volume Discount.

**AC Box Under Dash Hardware**

All the hardware related to the AC under the dash.

64AA-R	1964-65	18.99 kit
66AA-R	1966	24.99 kit
67AA-R	1967	24.99 kit
68AA-R	1968	29.99 kit
69AA-R	1969	32.99 kit
70AA-R	1970	26.99 kit
71AA-R	1971	24.99 kit
72AA-R	1972	24.99 kit

**Engine Master Hardware Kits**

The authentic hardware you need to correctly reassemble the engine components that attach to the long block. Typical kits include fasteners for: air cleaner, carburetor & choke cover, crank pulley & damper, distributor, exhaust manifold, exhaust pipe, engine fan, fuel pump plate & plug, heat shield, ignition coil & strap, intake manifold & plug, oil filter valve, oil pan, PCV adapter, PCV hose clamps, timing cover, valve covers, water neck, water pump.

67-Z28	1967-68 SB (174 pc)	144.99 kit
66-SBS	1968 SB w/o AC (153 pc)	129.99 kit
66-SBA	1968 SB w/ AC (164 pc)	139.99 kit
68-BBH	1968 BB Aluminum Intake (149 pc)	144.99 kit
68-BBS	1968 BB Cast Iron Intake (159 pc)	144.99 kit
69-SB	1969-71 SB (170 pc)	134.99 kit
69-Z28	1969 SB (162 pc)	129.99 kit
69-BBH	1969-72 BB Aluminum Intake (149 pc)	149.99 kit
69-BBS	1969-72 BB Cast Iron Intake (143 pc)	139.99 kit
72-SB	1972-73 SB (139 pc)	129.99 kit
72-Z28	1972-73 (145 pc)	124.99 kit

No Volume Discount.

**OEM Bolts - They Just Make Sense!**

It makes sense to use new bolts on new or restored parts! From bumper to bumper, we cover your entire vehicle. We have made our name and reputation on providing those hard to find detailing parts that separates your classic from the rest. All of our bolts are either original, OEM parts from original GM manufacturers or top quality reproductions. Manufactured with original head markings and correct plating (zinc, black phosphate and oiled, gold cadmium and silver cadmium), these bolts make assembly a breeze! Like our OEM paints, new bolt sets are what make a top flight restoration!

BFE-8002



**Front End Fastener Kit**

Over 175 pieces individually bagged!  
Includes everything you need to assemble your front end!



BFE-8001 1964-72 All .....69.99 kit



ISK-70A

**Interior Screw Kits**

**Basic**  
ISK-64A 1964-67 Chevelle .....22.95 kit  
ISK-68A 1968-69 Chevelle .....23.95 kit  
ISK-70A 1970-72 Chevelle .....24.95 kit  
ISK-64E 1964-72 El Camino .....21.95 kit



**OEM Complete**

**AMK inc PRODUCTS**  
64AN-CP 1964-65 Chevelle Coupe .....159.99 set  
64AN-CV 1964-65 Chevelle Convertible...139.99 set  
66AN-CP 1966 Chevelle Coupe.....164.99 set  
66AN-CV 1966 Chevelle Convertible .....159.99 set  
67AN-CP 1967 Chevelle Coupe.....189.99 set  
67AN-CV 1967 Chevelle Convertible .....179.99 set  
68AN-CP 1968 Chevelle Coupe.....199.99 set  
68AN-CV 1968 Chevelle Convertible .....189.99 set  
69AN-CP 1969 Chevelle Coupe.....199.99 set  
69AN-CV 1969 Chevelle Convertible .....194.99 set  
70AN-CP 1970-72 Chevelle Coupe .....224.99 set  
70AN-CV 1970-72 Chevelle Convertible ..219.99 set

AWB-1114



**Alternator Upper Adjustment Kit**

Correct WB head marked bolt with washers.

AWB-1114 1964-72 All .....5.99 kit

BRB-938



BN-339

**Alternator Lower Attaching Hardware**

BRB-938 1969-72 SB Bolt.....4.95 ea.  
BN-339 1969-72 BB Stud .....10.99 ea.

APX-1038



**Alternator Spacer Brace**

APX-1038 1969-72 BB.....15.95 ea.



AW-506

**Alternator Neg Cable Bolt**

AW-506 All .....0.95 ea.



ABN-105

**Alternator Fan Nut**

ABN-105 All .....4.99 ea.



IXP-03

**Arm Rest Pads Screws**

OE style reproduction arm rest pad screws.

IXP-03 Attaching Screw.....0.50 ea.



NX-281

**Brake Cable Retainer**

Correct clip for all cars (3 required).

NX-281 1964-72 All .....3.99 ea.

BPB-716



BPB-716K

**Bumper Bolts**

Correct chrome pan head bumper bolts complete with hardware. 7/16" x 1".

BPB-716 All .....1.95 ea.  
BPB-716K All (8 pc.) .....17.99 kit



BMP-1000

**Brake Caliper Bolts**

Correct bolts/pins for mounting caliper to bracket. Two per caliper.

BMP-1000 1964-77 Single Piston .....2.99 ea.  
*Single piston calipers only.*

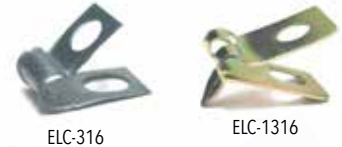

ELC-316

ELC-1316



ELC-516

ELC-1516



ELC-10P

BLC-056

**Brake Line Clips**

Correct clips for attaching hard brake lines to frame.  
(Tabbed clips push into frame holes.)

ELC-316 3/16" Front.....1.99 ea.  
ELC-1316 3/16" w/Tab .....4.99 ea.  
ELC-1516 5/16" Main.....1.99 ea.  
ELC-516 5/16" w/Tab .....4.99 ea.  
ELC-038T 3/8" w/Tab\* .....3.99 ea.  
ELC-10P Double Push In .....3.95 ea.  
BLC-056 Clip Bolt .....0.50 ea.

*\*Use on main line with armor shielding.*



BHP-1645



BHP-0516



**Body Bolt Kit**

Correct black flanged head bolts and washers.

BHP-1643 1964-67 Coupe/El Camino .....19.95 kit  
BHP-1645 1964-67 Convertible.....21.95 kit  
BHP-0516 1968-72 Coupe/El Camino .....22.95 kit  
BHP-0517 1968-72 Convertible.....23.95 kit



**BCN-716**

**Body Cage Nuts**

BCN-716 All 7/16" ..... 9.99 ea.



**RSK-E7**

**Bed & Tailgate Bolt Kit**

Complete kit with all correct bolts and screws for hinges, tailgate and bed floor.

RSK-E7 1968-72 El Camino ..... 47.99 kit



**BBF-13**

**Bumper Bracket Bolts**

New bumper bracket bolts with correct teeth washers and nut.

BBF-13 All ..... 6.99 ea.



**BAG-D1**

**Bezel Attaching Kits**

Basic hardware kit for installation of bezels.

BAG-D1 1964-72 All ..... 7.99 kit



**ABR-2450**

**ABR-9533**

**Battery Retainer Kits**

ABR-2450 1964-65 All ..... 15.95 kit

ABR-9533 1966-72 All ..... 3.99 kit

**Battery Retainer Kits**

ABR-2450 1964-65 All ..... 15.95 kit

ABR-9533 1966-72 All ..... 3.99 kit



**BSW-180070**

**Bench Seat Washers**

These washers go between the seat and the hinge on all bench seat cars. It keeps the hinge from damaging the seat material.

BSW-180070 All ..... 3.99 pr.

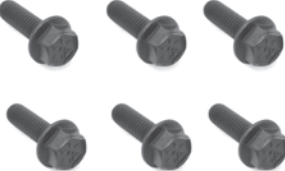

**BPB-9021**

**Bellhouse Attaching Kit**

BPB-9021 1964-77 All (6 pc.) ..... 8.95 kit



**AP-315**

**AP-317**

**Carb Studs**

Correct carb studs for cowl induction.

AP-315 Holley ..... 13.99 ea.

AP-317 Q-Jet ..... 13.99 ea.



**BAN-516**

**Coil Bracket Screws**

BAN-516 All ..... 1.95 pr.



**BTE-1475**

**BMG-0095**

**Carburetor Attaching Kits**

BTE-1475 All Q-Jet ..... 8.95 ea.

BMG-0095 All Holley ..... 7.99 ea.

**Carburetor Attaching Kits**

BTE-1475 All Q-Jet ..... 8.95 ea.

BMG-0095 All Holley ..... 7.99 ea.



**FBC-799**

**Clutch Pedal Booster Rod & Clip**

For use with power disc brakes.

FBC-799 Booster Rod Clip ..... 9.99 ea.

FBF-606 Booster Rod Fork ..... 14.95 ea.



**BCP-373**

**Caliper Backing Plate Bolt**

Plate to Spindle ..... 20.99 ea.



**NRM-1888**

**Cylinder Head Bolts**

NRM-1888 1965-72 BB (32 pc.) ..... 79.99 kit



**DS-594**

**DS-595**

**Control Arm Shims**

DS-594 1/16" ..... 2.99 ea.

DS-595 1/8" ..... 2.99 ea.



**FPB-97**

**FPB-103**

**Clutch Pedal Bushing & Bumper**

Correct nylon bushing used for ease of pedal.

FPB-97 All Bushing ..... 2.99 ea.

FPB-103 All Bumper ..... 3.99 ea.



**BPX-0918**

**Control Arm to Frame Bolts**

4 serrated bolts and 4 locking nuts for one car.

BPX-0918 1964-72 All ..... 18.99 kit



BPX-8542

**Control Arm Upper Washers**

Complete kit to do one car.

BPX-8542 1964-72 All ..... 19.95 kit



BPB-1430

**Control Arm Bolts-Lower Front & Rear**

BPB-1430 All ..... 7.99 ea.



BPC-7000

**Crossmember Bolts**

BPC-7000 To Frame ..... 6.95 kit  
BTE-7939 To Transmission ..... 0.95 ea.



LMC-3645

**Convertible Well Molding Clips**

Complete set of correct well molding clips.

LMC-3650 1964-65 ..... 39.99 set  
LMC-3645 1966-67 ..... 39.99 set  
LMC-3640 1968-72 ..... 39.99 set



AX-907

**Cowl Hood Screen Screws**

This is a set of 8 correct cowl hood screen attaching screws.

AX-907 1970-72 ..... 5.95 kit



MAP-64A

**Convertible Top Alignment Pin**

Correct chrome alignment pin that mounts to the header bow to guide it in place to the windshield frame.

MAP-GUIDE-66 1966-67 Alignment Pin Guide ..... 21.99 pr.  
MAP-64A 1968-72 Pin ..... 14.99 ea.



ACE-1400

**Distributor Hold Down**

Correct retaining hardware for distributor.

ACE-1400 All ..... 13.99 kit



BPX-1275

BPX-1299

**Door Strikers w/ Washer**

BPX-1275 GM Replacement ..... 12.99 ea.  
BPX-1299 Reproduction\* ..... 13.99 ea.  
BPX-1299K Reproduction Pair ..... 25.18 kit  
*\*Correct Allen Head Zinc Plated.*



MS277-20M



**EMS Stainless Strikers**

Replace your plain steel strikers with these attractive Eddie Motorsports Chevelle stainless steel door striker bolts. These billet striker bolts are cut with a Torx head and fit most Chevy muscle cars.

MS277-20M Machined ..... 55.99 pr.  
MS277-20P Polished ..... 62.99 pr.

RBR-067



**Door Lock Rod Bellcrank Retainer Clip**

Two required to mount one bellcrank to door frame.

RBR-067 1969-72 Chevelle ..... 6.99 ea.

IXP-18



**Door Panel Plugs**

Correct plugs for attaching door panel clips. Buy the kit and save!

IXP-18K Plug Kit (12 pc.) ..... 19.10 kit  
IXP-18 All Plug ..... 1.99 ea.



IDP-109

**Door Panel Screws**

Correct size attaching screw for door panels.

IDP-109 All ..... 0.50 ea.



BAV-2622

RHS-9

BAV-2623



**Door Hinge Hardware**

Correct OEM bolts and heavy spring.

BAV-2622 1964-67 Phillips ..... 1.99 ea.  
BAV-2623 1964-72 Hex ..... 1.99 ea.  
RHS-9 1964-72 Spring ..... 8.99 ea.  
BAV-2622K Phillips (6) Hex (18) ..... 32.95 kit  
BAV-2623K Hex (24) ..... 29.61 kit



BPX-1225

**Door Hinge Pin Kits**

Correct hinge pins and brass bushings for repairing all 4 of your door hinges.

BPX-1225 1966-67 (12 pc.) ..... 16.99 ea.  
BPX-2225 1968-72 (12 pc.) ..... 15.99 ea.

*\*May require slight modification to hinges.*



GDB-68-REG

**Door Track Hardware**

This bolt kit is used to attach the window regulator, window tracks, door latch and other internal pieces to the door.

GDB-68-REG 1968-72 Small Washer (12 pc.) ..... 13.99 kit  
GDB-68-REG-LRG 1968-72 Large Washer (8 pc.) ..... 17.99 kit



RRI-11360

**Door Rod Insulators**

This is a set of two correct door lock rod insulator shields which protect the long door opening rods in the doors.

RRI-11360 1964-72 ..... 7.99 set



RW-069-A

**Door Window Hardware Kit**

These convenient window hardware kits include all of the necessary parts to rebuild the rollers, guides and bushings on the quarter window regulators. Made in USA.

- RW-069-A 1968-69 Door .....59.99 kit
- RW-070-A 1970-72 Door .....39.99 kit
- RW-066-A-REAR 1966-67 1/4 Window.....64.99 kit
- RW-069-A-REAR 1968-72 1/4 Window.....62.99 kit



GGG-761

**Door Glass Guide Screws**

- GGG-761 1968-72 (8 pc.) .....2.99 kit



GGP-1485Y

**Door Glass Guide Plates**

Correct front door glass guide plates.

- GGP-1485Y 1968-72 Felt Covered Steel ..... 26.99 pr.
- GGP-7072 1970-72 Plastic..... 8.99 ea.

GGF-557



**Door Glass Guide Felts**

- GGF-557 (4 pc.) ..... 8.99 set

GGS-1485Q



**Door Glass Stabilizers**

Correct front door glass stabilizers.

- GGS-1485Q 1970-72 ..... 16.99 pr.

GCS-1485N



**Door Glass Support**

Correct front door glass support.

- GCS-1485N 1970-72 ..... 11.99 ea.



GWR-15365



GWR-15366

**Door Glass Washers**

Plastic washer that is used to protect the door. Mounts between the glass and the metal fasteners within the door. 1.5 inch diameter.

- GWR-15365 1964-77 w/ Step ..... 3.99 ea.
- GWR-15366 1964-77 ..... 3.99 ea.



GDS-15231



GDS-1485P

**Door Glass Stopper**

Correct front door glass stopper.

- GDS-15231 1968-72 .....13.99 ea.
- GDS-1485P 1970-72 ..... 11.99 ea.



ALI-2228

**Exhaust Stud Kit**

Correct studs for mounting exhaust pipe to manifold. Our kit comes complete with 3 long & 3 short studs and 6 correct locking nuts.

- ALI-2228 All SB - BB.....22.99 kit



APB-1382

**OEM Exhaust Manifold Bolts**

Correct head marked and colored bolts for mounting exhaust manifolds to block.

- APB-1382 SB w/ Washers (24 pc.).....39.99 kit
- APB-1821 BB Flanged Head (16 pc.).....23.99 kit
- APB-3506 BB Loose Washer (32 pc.).....26.99 kit



MS275-38

**EMS Stainless Hood Adjusters**

Eddie Motorsports stainless steel hood adjusters are machined completely from stainless steel. They will not rust or corrode. Sold individually.

- MS275-38 Machined .....38.99 ea.
- MS275-38P Polished .....39.99 ea.



APC-0100



BPX-2792

**Fan and Shroud Attaching Kits**

Correct style bolts/studs for attaching fan to water pump.

- BPX-2792 Attaching Stud Kit 12 Piece.....6.95 kit
- BPX-2791 Attaching Bolt Kit 8 Piece.....5.95 kit
- APC-0100 1968-72 All Lower Shroud Clips .....2.95 pr.



BCI-4753

BPX-4755

**Fuel Tank Hardware**

Correct OEM bolts and clips.

- BCI-4753 1964-67 All .....8.95 kit
- BPX-4755 1968-72 All .....12.95 kit



ACE-4867



ACE-9599

**Fuel Pump Hardware**

- AJE-395 All Activating Rod ..... 15.99 ea.
- ACE-9599 All SB Plate ..... 10.99 ea.
- ACE-4867 Fuel Pump Bolts.....6.99 kit



BPA-5160



BPA-5161



BPA-381



BPA-385

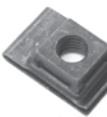

BFJ-516

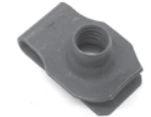

BJF-038

**Fender Front End Bolts**

- BPA-5160 5/16" Bolt w/o Washer ..... 0.69 ea.
- BPA-5161 5/16" Bolt w/ Washer ..... 0.59 ea.
- BPA-381 3/8" x 1" Bolt..... 0.65 ea.
- BPA-385 3/8" x 1-1/2" Bolt ..... 0.75 ea.
- BFJ-516 Fender J Clip 5/16" ..... 1.99 ea.
- BJF-038 Fender J Clip 3/8" ..... 1.50 ea.

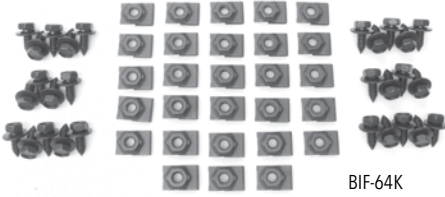

BIF-64K

**Fender Inner Bolt Kit**

BIF-64K 1964-72 All (56 pc.)\* .....29.99 ea.  
\*5/16" Bolts



EBB-691

**Flex Hose Bolts**

Correct OEM brake fluid bolt with hollow center and (2) special washers for attaching flex hose to caliper.

EBB-691 All w/ Disc Brakes .....3.99 ea.



GDS-707

**Front Door Glass Side Stop**

GDS-707 1970-72 .....21.99 ea.



GGP-706

**Front Door Glass Glide Plate**

GGP-706 1970-72 .....13.99 ea.



BCW-51

**Fender Cup Washers**

BCW-51 1964-72 All Zinc .....3.99 ea.



BPB-5116

**Flywheel Attaching Kit**

BPB-5116 1964-77 4 Speed .....19.99 kit  
BPB-5118 1964-77 Auto .....18.99 kit



APX-2339

**Frame Bracket Bolt Kit**

APX-2339 1964-88 To Frame .....6.95 kit



BAG-D2

**Grille Attaching Kits**

BAG-D1 1964-72 All .....7.99 kit



BPB-5934

**Harmonic Balancer Bolt**

BPB-5933 All SB w/ Washer .....8.99 kit  
BPB-5934 All BB w/ Washer .....12.99 kit



LHS-64

LHS-70

**Headlamp Springs**

Correct spring used for proper adjustment.

LHS-64 1964-67 All .....2.99 ea.  
LHS-70 1968-70 All .....1.50 ea.  
LHS-71 1971-75 All .....2.95 ea.



LHA-64K

**Headlamp Adjustment Kit**

Plastic nuts and screws for headlamp adjustment. Each kit does one car.

LHA-64K 1964-70 All (8 pc.) .....7.95 kit  
LHA-73K 1971-72 All (4 pc.) .....5.95 kit  
LHA-789K 1978-79 (6 pc.) .....11.95 kit  
LHA-801K 1980-81 (6 pc.) .....18.99 kit  
LHA-827K 1982-87 (6 pc.) .....15.95 kit



RDR-72K

RDR-67

**Hinge Detent Rollers**

Correct machined detent rollers for lower hinges.

RDR-67 1965-67 All .....16.95 kit  
RDR-72K 1968-72 All .....27.99 kit

BCX-130

**Hood Valve Frame Screws**

This is a set of 6 correct screws to attach the hood valve frame.

BCX-130 1970-72 .....5.95 kit



BPQ-4011

**Hood Adjustment Bolts**

BPQ-4011 1964-72 All .....9.95 kit



BPQ-41-REAR

**Hood Stop Studs**

New hood stop studs that mount on cowl firewall. Special head with "C". 2 are used per car.

BPQ-41-REAR 1970-77 .....23.99 pr.



BPQ-BUMPER-REAR

**Hood Bumpers Rear**

These hard to find rubber hood bump stops are finally available! Sold in pairs they slide into a groove on both sides of the hood and rest on the cowl when the hood is closed to stop the hood from shaking.

BPQ-BUMPER-REAR 1968-72 .....4.95 pr.

BX-1070

**Hood Door Bracket Hardware**

Correct set of four screws for attaching bracket to hood.

BX-1070 1970-72 .....3.95 kit

BPA-381

**Hood Hinge Bolt**

BPA-381 3/8" x 1" .....0.65 ea.

ACL-5588

**Hood Door Attaching Kit**

Correct shouldered bolts with P head markings with nylon bushings.

ACL-5588 1970-72 .....8.99 kit



**Intake Studs**  
Correct intake manifold studs for various uses: alternator, solenoid and power brake tube. Includes correct nut.

BPS-3679 All 3/8" x 3/8" (Zinc)..... 5.99 ea.  
(p.s. bracket, alternator mount, etc.)  
BPS-7432 All 5/16" x 3/8" (Black)..... 5.99 ea.  
(TCS, P.B. tube, etc.)



BPI-4400



BPI-2271

**Intake Manifold Kits**

BPI-4400 1967-72 SB "M" (12 pc.)..... 16.95 kit  
BPI-9140 BB Cast "M" (16 pc.)..... 21.95 kit  
BPI-2271 BB Alum. "A" (16 pc.)..... 28.99 kit



BPX-9873

**Idle Arm Bolts**

BPX-9873 To Frame..... 3.95 pr.

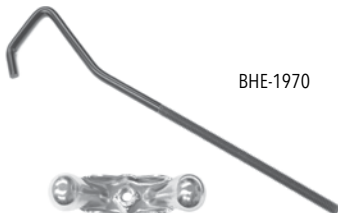

BHE-1970

**Jack/Tire Retainer Kit**

BHE-1970 1964-72 All ..... 14.99 set



BPA-53K

**License Plate Attaching Kit**

BPA-53K All (4 pc.)..... 3.95 kit



APB-7057

**Motor Mount "Thru" Bolt Kit**

Correct OEM bolts for retaining mount to frame bracket. Comes complete with special high strength washers and cadmium plated locking nuts as original.

APB-9057 1964-67 All 4.5" ..... 9.99 kit  
APB-7057 1968-72 All 3.5" ..... 6.95 kit



BJ-998

**Motor Mount Attaching Bolt Kit**

Correct style bolts for attaching mount to block

BJ-998 All (12 pc.)..... 8.95 kit



ATW-2853

**Motor Mount Clip**

Correct clip for attaching positive cable to right side motor mount.

ATW-2853 Most V8s ..... 19.95 ea.



MHQ-1234

**Mirror Mounting Kit**

Complete with bracket, gaskets, & screws.

MT-1820 1964-65 ..... 4.95 kit  
MHQ-1234 1966-69 ..... 4.95 kit  
MT-1970 1970-72 ..... 4.95 kit

Non-remote mirror.



BSL-516

**Nuts Self Locking**

BSL-516 5/16" Zinc..... 0.40 ea.  
BSL-38 3/8" Zinc..... 0.50 ea.  
BSL-716 7/16" Zinc..... 0.75 ea.  
BSL-12 1/2" Zinc..... 0.95 ea.

BPO-1988



**Oil Drain Bolt w/ Washer**

BPO-1988 All ..... 6.95 ea.



BOP-2001



BOP-2002

**Oil Pan Attaching OEM Bolt Kit**

Correct "L" head marked bolts for attaching pan to block.

BOP-2001 All SB (18 pc.)..... 9.95 ea.  
BOP-2002 All BB (24 pc.)..... 26.99 ea.



BFC-333

**Pulley Attaching Bolts**

BFC-333 All Fine (6 pc.) ..... 6.95 kit  
BRB-100 All Coarse (6 pc.) ..... 6.95 kit



BSB-1970

**Power Steering Hardware Kits**

Our kits feature all correct hardware to attach power steering brackets to engine. A MUST!

CPZ-1513 1965-68 SS 396 ..... 22.95 kit  
BSB-69SB 1969-72 All SB ..... 22.99 kit  
BSB-1969 1969 All BB ..... 22.99 kit  
BSB-1970 1970-72 All BB ..... 12.95 kit



BPP-12

BPP-10

BPP-34

**Push-In Plugs**

BPP-12 1/2" Cowl Top, etc. .... 0.75 ea.  
BPP-34 3/4" Wheelhouse ..... 1.00 ea.  
BPP-10 1" Trunk Extension ..... 1.25 ea.  
BPP-138 1-3/8" Rubber Plug ..... 1.50 ea.



BPP-8386

**Pressure Plate Bolts**

BPP-8386 All Manual (12 pc.).....9.99 kit



GTS-177

**Quarter Window Roller Tension Spring**

This commonly missing spring is used to keep tension on the window roller so that the window goes up and down smoothly.

GTS-177 1968-72 ..... 5.99 ea.



GGG-15232

**Quarter Window Stop**

Correct reproduction of the quarter window stop, with the correct plastic coated end and correct bolt hole as original.

GGG-15232 1968-72 ..... 12.99 ea.



GWR-060

**Quarter Window Roller Assembly**

Complete window roller assembly for rear quarter including center lower guide roller and threaded stud assembly.

GWR-060 1968-72 All ..... 16.99 ea.



GWR-060A

**Quarter Window Roller Backing Washer**

Correct backing washer for roller.

GWR-060A 1968-72 ..... 5.99 ea.



GWR-060B

**Quarter Window Roller Nylon Bushing**

Correct nylon bushing for roller.

GWR-060B 1968-72 ..... 6.99 ea.



BPP-70Q

**Quarter Plug**

Correct plug and orange gasket used to plug the rear quarter panel drain hole. These plugs are made of steel.

BPP-70Q 1970-72 ..... 21.99 pr.



BRE-2008

**Rear End Cover Bolt**

BRE-2008 All Flanged.....0.95 ea.



GGG-746

**Rear 1/4 Window Glass Side Stop**

GGG-746 1968-72 ..... 15.99 ea.



GGP-707-REAR

**Rear Side Glass Glide Plate**

GGP-707-REAR 1970-72 ..... 13.99 ea.



GDS-708

**Rear 1/4 Window Lower Stop**

GDS-708 1970-72 ..... 13.95 ea.



BPP-084

**Rubber Body Plugs**

Reproduction body plugs. GM licensed.

BPP-084 1964-72 1" .....7.99 pr.

BPP-039 1968-69 (6 pc.) .....14.99 kit



BSB-759

**Steering Box Bolt**

BSB-759 All ..... 6.99 ea.



GCS-S0005

**Stainless Water Pump Bolts**

Tapered head bolts used to mount the pulley to the water pump when using an electric cooling fan in place of a water pump mounted fan.

GCS-S0005 Bolts ..... 4.99 ea.



DSB-12959

**Rear Sway Bar Washers**

Correct washers used on the nut side so that the nuts do not dig into the arms.

DSB-12959 1964-72 (4 pc.) .....11.99 kit



BV-2072

BV-2074

BV-2070

**Starter Bolts**

BV-2070 3/8" x 1-7/8" Short ..... 5.99 ea.

BV-2072 3/8" x 3-5/8" Long ..... 4.99 ea.

BV-2074 3/8" x 4-11/16" Extra Long ..... 6.99 ea.



BPX-1950

**Sheet Metal Screw Kit**

Over 20 pieces for small under hood items.

BPX-1950 All .....5.95 kit



BPX-9715



BPX-9715-REAR

**Shock Mounting Kit**

Correct GM front shock mounting kit with (4) clips and (4) OEM bolts/washers.

BPX-9715 1964-88 All Front .....8.99 kit

BPX-9715-REAR 1968-88 Rear Upper Shock Mounting Hardware .....8.95 kit



ATJ-411



**Steering Coupler Bolt**

Correct OEM style bolt for coupler.

ATJ-411 1964-76 All ..... 5.99 ea.

BAR-1295



**Sway Bar Bolt**

Correct mounting bolt for stock front sway bar.

BAR-1295 Correct Bolt ..... 0.75 ea.

FTH-049



**Shifter Cable Clip**

Correct push-on clip which mounts to shifter.

FTH-049 Push-on Clip (to shifter) ..... 7.99 ea.

EBC-22



**Shifter Cable Clip**

Correct clip for mounting cable.

EBC-22 Mounting Clip ..... 3.99 ea.



BSB-56



BSB-5-SBL

BSB-561

**Seat Belt Anchor Bolts**

BSB-56 All Front Outer ..... 6.99 ea.  
 BSB-56 1964-68 Front Inner ..... 6.99 ea.  
 BSB-561 1969-72 Front Inner ..... 6.99 ea.  
 BSB-561 All Rear ..... 6.99 ea.  
 BSB-5-SBL All Fully Threaded Shank ..... 6.99 ea.  
 1969-72 used (2) front seat belts.

BSM-5NT



BSM-516



**Seat Mounting Bolts**

BSM-516 All Front Bolts ..... 1.35 ea.  
 BSM-5NT All Rear Nuts ..... 1.35 ea.



BRS-12659

**Seat Back Release Screws**

Correct screws to hold the folding seat back assembly in the seat back.

BRS-12659 1969-72 (8 pc.) ..... 10.99 kit



KMC-15KWS

**Trim Stud Repair Kit OE GM**

OEM GM replacement trim studs for mounting front and rear window moldings and some rocker moldings. These studs come with a sealant to prevent corrosion.

KMC-15KWS 1964-88 All (8 pc) ..... 34.99 kit



JSB-E33

**Tailgate Bumpers**

Correct rubber stop bumpers which prevent the tailgate from hitting metal on metal.

JSB-E33 1968-72 El Camino ..... 1.99 ea.



RTG-647RB

**Tailgate Hinge Rebuild Kit**

Correct pins and bushings to make both tailgate hinges work like new. Original head markings and brass bushings to match originals.

RTG-647RB 1964-67 ..... 23.99 kit  
 RTG-682RB 1968-72 ..... 23.99 kit



RCK-E5

**Tailgate Cable Kit**

Complete kit with cables, springs and bolts.

RCK-E5 1968-77 El Camino ..... 36.99 set



RTH-E4817

**Tailgate Handle**

Reproduction inner tailgate handle with nylon washer.

RTH-E4817 1968-72 ..... 18.99 ea.



RGK-200

**Tailgate/Bed Fastener Kit**

Correct set of fasteners for tailgate and rear of bed.

RGK-200 1964-72 El Camino ..... 10.99 kit



RTS-1490E

**Tailgate Cable Springs**

Correct pair of tailgate cable springs.

RTS-1490E 1964-72 ..... 4.95 pr.  
 RTS-1490F 1973-77 ..... 4.95 pr.



RTH-1490H

**Tailgate Hinges**

Reproduction tailgate hinges to replace your worn out originals.

RTH-1490H 1968-72 ..... 184.99 pr.



INL-15190

**Top Cylinder To Frame Hardware**

This is a set of the correct bolts, bushings, washers and nuts to connect the convertible top cylinder to the top frame.

INL-15190 1968-72 ..... 25.99 ea.



**Thermostat Housing**

ATR-1039	Most SB Bolt/Stud.....	8.99 ea.
ATR-2039	All SB-BB Bolt.....	7.99 ea.
ATR-3039	1967-68 Gooseneck.....	8.99 kit



**Transmission Mounting Hardware**

BTE-307	To Bellhousing (8 pc.).....	8.95 kit
BTE-7939	To Rear Mount.....	0.95 ea.



**Timing Cover Bolt Kit**

BTC-650	"L" Sems Bolts.....	8.95 kit
---------	---------------------	----------



**Valve Cover Bolts**

APB-1023	SB "TR" (16 pc.).....	14.95 kit
APB-2023	BB "TR" (28 pc.).....	23.99 kit
APB-1027	SB "M" (8 pc.).....	16.99 kit

*M bolts were used on finned aluminum valve covers.*



**Voltage Regulator Nuts and Screws**

AVX-515	1968-71 All.....	0.95 kit
---------	------------------	----------



**Water Pump OEM Attaching Bolt Kits**

Correct style attaching bolts with "TR" head markings.

ATR-3232	1964-68 2 Bolts 2 Stud.....	16.99 kit
ATR-4334	1969-72 All 4 Bolts M Mark.....	11.99 kit
AWS-301S	Stud Only (Short).....	4.99 ea.



**Wing Nuts, Flame Arrester & Studs**

APX-1400	Chrome Wing Nut.....	5.99 ea.
APX-7700	Black Wing Nut.....	5.99 ea.
ATE-5695	Flame Arrester.....	9.99 ea.

**Carburetor Studs**

APJ-2153	All w/ Holley Open Element	
	1-1/2" Long.....	12.95 ea.
AP-315	All w/ Q-Jet 3-3/8" Long.....	13.99 ea.
AP-315	1970-72 Holley w/ Cowl Induction.....	13.99 ea.
AP-317	1970-72 Q-Jet w/ Cowl Induction 5-3/16" Long.....	13.99 ea.
ATE-5256	Universal w/ Point End 4-1/4" Long.....	8.99 ea.



**Window Roller Tool**

Allows you to easily install window rollers.

TRIM-WR	All.....	18.99 ea.
---------	----------	-----------



**Window Retainers**

Two piece window glass retainer used to hold the side window glass to the regulator.

GWR-12660	1968-72.....	6.99 pr.
GWR-15365	1964-77 Plastic Washer Only.....	3.99 ea.



**Window Rollers**

Correct replacement window rollers.

WR-344	1964-65 Lower Rear 1/4.....	9.99 ea.
WR-068	1964-65 Door.....	8.99 ea.
WR-343	1966-67 1/4 Window.....	9.99 ea.
WR-76	1968-72 Lower Rear 1/4.....	8.95 ea.
WR-78	1969-72 Door.....	13.99 ea.
WR-065	1968-72 Lower Rear 1/4.....	8.95 ea.

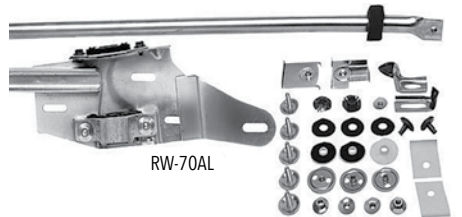

**Window Track And Hardware Kits**

This convenient door window track & hardware kit is great for when you are changing out your door glass.

RW-70AL	1970-72 Chevelle LH.....	189.99 set
RW-70AR	1970-72 Chevelle RH.....	189.99 set

*Ships Oversize. No Volume Discount.*



**1966 Chevelle Bezel Clips**

Correct kit for retaining tail light bezels to car.

LTR-CLIP	1966 Chevelle.....	11.95 set
----------	--------------------	-----------

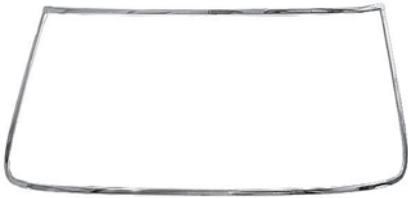

**Front and Rear Window Molding Kits**

New high quality, reproduction stainless windshield molding kits offer a very nice fit and finish and will really freshen up your car's exterior.

KX-64R	1964-65 Coupe Windshield (5 pc.)	159.99 kit
KX-64V	1964-65 Convert Windshield (5 pc.)	179.95 kit
KX-64R	1964-67 El Camino Windshield	159.99 kit
KX-67R	1966-67 Coupe Windshield (5 pc.)	159.95 kit
KX-67V	1966-67 Convert Windshield (5 pc.)	199.99 kit
KX-68R	1968-72 Coupe Windshield (3 pc.)	89.95 kit
KX-88F	1978-88 Monte Windshield Silver	209.99 kit
KX-88FB	1978-88 Monte Windshield Black	249.99 kit
KXA-64R	1964-65 Coupe Rear Window	164.99 kit
KEL-64R	1964-67 El Camino Rear Window	169.95 kit
KX-66R	1966-67 Coupe Rear Window	159.99 kit
KX-68G	1968-72 Coupe Rear Window	159.95 kit
KEL-68R	1968-72 El Camino Rear Window	169.95 kit
KX-88R	1978-88 Monte Rear Window Silver	259.99 kit

All window moldings ship Oversize and well protected. Not eligible for free shipping.



KDF-1429A

**El Camino Door Frame Moldings**

Reproduction door frame moldings.

KDF-1429	1964-67 (4 pc.)	139.99 pr.
KDF-1429A	1968-72 (4 pc.)	142.99 pr.

Ships Oversize. Not eligible for free shipping.



KWF-1485X

**Door Window Frames & Sashes**

Reproductions of door window frames and sashes.

Sash Moldings

KWF-1417Q	1964-65 Chevelle LH/RH	169.99 set
KWF-1417R	1966-67 Chevelle LH/RH	169.99 set

Window Frames

KWF-1485X	1968-72 El Camino LH	149.95 ea.
KWF-1485W	1968-72 El Camino RH	149.95 ea.

Ships Oversized. Not eligible for free shipping.

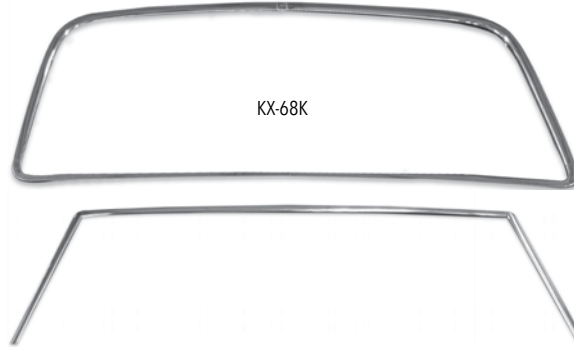

KX-68K



**BUY'N SAVE**  
WITH KITS

**1968-72 GM Restoration Window Moldings**

These high quality window moldings are our own tooling and have been used on our own restoration projects, so you can be sure that they are the highest quality on the market!

KX-68R	1968-72 Coupe Front	89.95 kit
KX-68-VT	1968-72 Convertible Upper/Sides (3 pc.)	149.95 kit
KX-1424D	1968-72 Convertible Upper Only	59.99 ea.
KX-68G	1968-72 All Rear	159.95 kit
KX-68K	1968-72 All Front & Rear	242.82 kit
KX-68DLX	Coupe Front & Rear w/ Clips	388.56 kit

All window moldings ship oversize and well protected.

Not eligible for free shipping.



**Windshield Molding Clips**

Complete set of clips for one car.

KMC-64KITA	1964-67 All	17.99 kit
KMC-68KITA	1968-72 All	9.95 kit

Some clips may vary slightly from factory, but will fit and function as original.

**Rear Window Molding Clips**

Complete set of clips for one car.

KMC-64KITR	1964-65 Coupe	19.99 kit
KMC-66KITR	1966-67 Coupe	9.95 kit
KMC-678K	1968-72 Coupe	9.95 kit
KMC-E64	1964-67 El Camino	11.99 kit
KMC-E68	1968-72 El Camino	9.95 kit

Some clips may vary slightly from factory, but will fit and function as original.



KDX-70K



**Roof Drip Molding Kits**

Beautiful stainless steel complete reproduction drip rail molding kits.

KDX-65K	1964-65 Coupe (6 pc.)	109.99 kit
KDX-67K	1966-67 Coupe (2 pc.)*	64.99 kit
KDX-69K	1968-69 Coupe (6 pc.)	99.95 kit
KDX-70K	1970-72 Coupe (6 pc.)	89.95 kit
KRD-6X	1964-67 El Camino (2 pc.)	69.95 pr.
KRD-8X	1968-72 El Camino (6 pc.)	99.95 kit

All roof drip moldings ship Oversize and well protected. Not eligible for free shipping. \*1966-67 are extruded aluminum as original.



KLM-3A

**Lower Windshield Molding**

Beautiful reproduction of the often missing or damaged wide lower windshield molding. This stainless steel piece is manufactured to exact factory specs.

KLM-3A	1968-72 Molding	149.99 ea.
KLM-3SK	Attaching Screws (7 pc.)	3.95 kit
KLM-10533	End Clips w/ Screws	7.99 pr.

These moldings ship Oversize and well protected. Not eligible for free shipping.



LWA-647



LWB-64



LWA-69B



LWB-72



**Wiper Arms & Blades**

LWA-647	1964-67 All Chrome Arm.....	23.99 ea.
LWA-69B	1964-67 All Satin Silver Arm*.....	19.95 ea.
LWB-64	1964-67 15" Blade.....	16.95 ea.
LWB-72	1968-72 16" Blade.....	17.99 ea.
LWA-7888	1978-88 All Black.....	89.99 pr.

\*Satin silver is not correct but fits exactly the same as the chrome version.



WIPERKIT-15



LWA-68K

**Windshield Wiper Arm & Blade Kits**

If your original wiper arms and blades were damaged or have gone missing over the years, finding good replacements was a major headache until now. These kits include a pair of wiper arms, complete with blades.

WIPERKIT-15	1964-67 All Chrome.....	69.60 kit
LWA-68K	1968-72 w/ Hidden Satin.....	99.95 kit
LWA-68K-C	1968-72 w/ Hidden Chrome.....	99.99 kit

No Volume Discount.



WIPERKIT-HIDE-C



**Hidden Wiper Arm & Transmission Kits**

Looking to refurbish or replace major components of your wiper system? Look no further with Ground Up Motor Sports's exclusive wiper kits! This hidden wiper kit includes two wiper arms, two wiper blades and the wiper transmission arm. Deluxe kits include a wiper motor.

WIPERKIT-HIDE-C	1968-72 Chrome Arms.....	197.98 kit
WIPERKIT-HIDE	1968-72 Satin Arms.....	197.95 kit

**Deluxe Kits With Wiper Motor**

WIPERKIT-HIDE-DLX-C	1968-72 Chrome Arms.....	350.97 kit
WIPERKIT-HIDE-DLX	1968-72 Satin Arms.....	350.94 kit

No Volume Discount.

### Vinyl Tops

Original style double seamed tops in correct Levant grain.

**Chevelle**

VT-645B	1964-65 Black.....	179.99 ea.
VT-645WHT	1964-65 White.....	179.99 ea.
VT-667B	1966-67 Black.....	179.99 ea.
VT-667WHT	1966-67 White.....	179.99 ea.
VT-6872B	1968-72 Black.....	179.99 ea.
VT-6872WHT	1968-72 White.....	199.99 ea.
VT-TT161	1968-72 Non Padded OE Style Black.....	289.99 ea.



**El Camino**

VT-E647	1964-67 Black.....	179.99 ea.
VT-E6872	1968-72 Black.....	199.99 ea.



### Vinyl Top Molding Sets

Reproduction vinyl top molding sets with correct cast and stainless pieces.

KT-667	1966-67 Coupe (4 pc.).....	144.99 kit
KT-1462	1968-69 Coupe (7 pc.).....	169.95 kit
KT-1463	1970-72 Coupe (7 pc.).....	179.95 kit
KT-3455	1968-72 El Camino.....	89.99 pr.



### Vinyl Top Corner Moldings

New die cast chrome corner moldings.

KT-0689	1968-69 Chevelle Rear.....	69.99 pr.
KT-4724	1970-72 Chevelle Front.....	49.99 pr.
KT-4275	1970-72 Chevelle Rear.....	99.99 pr.
KT-7072M	1970-72 Monte Carlo.....	74.99 pr.

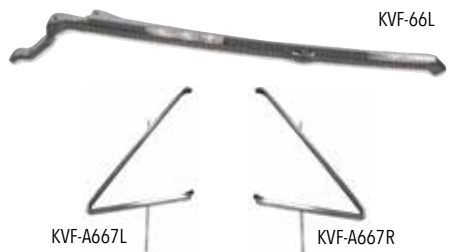

### Vent Window Frames

Triple process chrome plated and polished to a high luster.

KVF-66L	1966-67 LH.....	134.99 ea.
KVF-66R	1966-67 RH.....	134.99 ea.
KVF-66-KIT	1966-67 LH/RH Frame on Door..	269.88 pr.
KVF-A667L	1966-67 LH Frame on Glass.....	99.99 ea.
KVF-A667R	1966-67 RH Frame on Glass.....	99.99 ea.
KVF-A667K	1966-67 LH/RH Frame on Glass..	179.98 kit



### Roof Weatherstrip Channel

High luster stainless. Bolts into roof channel to retain weatherstrip. Includes blow out clips.

RRC-A64	1964-65 (6 pc.).....	209.99 kit
RRC-A66	1966-67 (6 pc.).....	209.99 kit
RRC-A68	1968 (6 pc.).....	209.99 kit
RRC-A69	1969 (6 pc.).....	209.99 kit
RRC-70A	1970-72 (6 pc.).....	219.99 kit
BRR-221	1964-72 Screws (36 pc.).....	30.99 kit

This item Ships oversize.



### Quarter Window Molding

Our triple chrome moldings come complete with rubber seals which glue the glass to the chrome.

KQT-1651	1964-65 All.....	82.99 pr.
KQT-1665	1966-67 All.....	77.99 pr.
KQT-1671	1968 All.....	84.99 pr.
KQT-169	1969-72 All.....	84.99 pr.

Note: Adhesive sold separately. Use JSS-3M



### Quarter Glass Seals

Correct rubber seal which slides into the quarter window and seals the front and rear windows. Available in high quality molded rubber or steel core with rubber coating as factory.

JSS-5109	1964-65 Rubber.....	9.99 pr.
JSS-5111	1966-67 Rubber.....	9.95 pr.
JSS-67SC	1966-67 Steel.....	29.99 pr.
JSS-2525	1968-72 Steel.....	18.99 pr.



### Window Molding Stud/Pin Kit

Self tapping screws replace the original body studs used to retain factory window or vinyl top molding clips.

KMC-15	1964-88 (12 pc.).....	3.50 kit
--------	-----------------------	----------

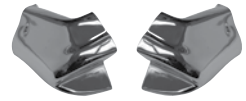

### Convertible End Caps

New polished stainless steel end caps.

KEC-667	1966-67.....	94.99 pr.
---------	--------------	-----------



### Convertible Top Hooks

Correct convertible top hooks & latches.

MHL-701K	1964-72.....	39.99 kit
----------	--------------	-----------



### Convertible Well Molding

Reproduction of the rear body "pinch weld" molding in polished stainless steel as original.

LWM-838	1964-65 All.....	199.99 set
LWM-839	1966-67 All.....	189.99 set
LWM-840	1968-72 All.....	189.99 set
LMC-3650	1964-65 Clips.....	39.99 set
LMC-3645	1966-67 Clips.....	39.99 set
LMC-3640	1968-72 Clips.....	39.99 set

No Volume Discount. Ships Oversize. Not eligible for free shipping.



### Convertible Knuckles

Correct die cast convertible top "knuckles" which attach the ends of the windshield header and secure the top hooks in place.

KEC-70K	1968-72.....	74.99 pr.
---------	--------------	-----------



### Convertible Top Latches

MTL-64AL	1964-65 LH.....	111.99 ea.
MTL-64AR	1964-65 RH.....	111.99 ea.
MTL-66AL	1966-67 LH.....	111.99 ea.
MTL-66AR	1966-67 RH.....	111.99 ea.
MTL-68AL	1968-72 LH.....	111.99 ea.
MTL-68AR	1968-72 RH.....	111.99 ea.



**Vinyl Header Cover**

Correct vinyl material to cover the header on your 1968-72 Chevelle convertible.

MHM-682	1968-72	16.99 ea.
---------	---------	-----------

Please state color.



KMC-15KWS

**Trim Stud Repair Kit OE GM**

OEM GM replacement trim studs for mounting front and rear window moldings and some rocker moldings. These studs come with a sealant to prevent corrosion.

KMC-15KWS	1964-88 All (8 pc)	34.99 kit
-----------	--------------------	-----------

**Lower Side Body Molding Kits**

Complete sets of quality lower body side moldings complete with hardware.

KLM-1475	1967 El Camino (8 pc.)	239.99 kit
KLM-1783	1968 Chevelle Malibu (6 pc.)	199.99 kit
KLM-67M	1967 Malibu (8 pc.)	229.95 kit
KLM-67M-CLIPS	1967 Malibu Clips (64 pc.)	36.95 kit
KLM-1786	1968 Chevelle SS (8 pc.)	219.99 kit
KLM-3320	1968 El Camino (8 pc.)	219.99 kit
KLM-1789	1969 Chevelle Malibu (8 pc.)	199.95 kit
KLM-3323	1969 El Camino (8 pc.)	219.99 kit
KLM-3325	1970-72 El Camino (10 pc.)	279.99 kit

*Ships Oversize. Not eligible for free shipping.*



KLM-67M-CLIPS

**Rocker Panel Moldings**

Beautiful reproduction rocker panel moldings with correct accents and complete with hardware.

KRP-580L	1964 Chevelle Malibu LH	66.95 ea.
KRP-580R	1964 Chevelle Malibu RH	66.95 ea.
KRP-583L	1964 Chevelle SS LH	59.95 ea.
KRP-583R	1964 Chevelle SS RH	59.95 ea.
KRP-1362L	1965 Chevelle Malibu SS LH	64.99 ea.
KRP-1362R	1965 Chevelle Malibu SS RH	64.99 ea.
KRP-231L	1966 Chevelle/El Camino SS LH	69.99 ea.
KRP-231R	1966 Chevelle/El Camino SS RH	69.99 ea.
KRP-231-KIT	1966 Chevelle Rocker & Ext Moldings 4pc	233.97 kit
KRP-585L	1967 Chevelle SS LH	69.99 ea.
KRP-585R	1967 Chevelle SS RH	69.99 ea.
KRP-1437	1970-72 Chevelle LH	64.99 ea.
KRP-1436	1970-72 Chevelle RH	64.99 ea.
KRP-1436K	1970-72 RH & LH Kit	116.98 kit

*Ships Oversize. Not eligible for free shipping.*



KAR-211

KEC-64F

KAR-7629

KEC-64R

**Rocker Panel Extension Moldings & End Caps**

Brand new moldings featuring correct black accents on 1966 and mounting clips. Ready to install!

KAR-211	1964 Chevelle	124.95 pr.
KAR-7629	1966 Chevelle SS Rear Extensions	129.99 pr.
KAR-M1433F	1966 El Camino LH	99.99 ea.
KAR-M1433E	1966 El Camino RH	99.99 ea.
KEC-64F	1964 Front Caps	39.99 pr.
KEC-64R	1964 Rear Caps	39.99 pr.



KH-1354

**Hood Moldings**

Correct die stamped moldings for front of hood.

KH-130	1964 All	69.95 ea.
KH-1351	1965 All	49.99 ea.
KH-1353	1966 All	49.99 ea.
KH-1354	1967 All	44.95 ea.
KH-1200	1968-69 Header All	32.99 ea.



KHR-51

**Rear Hood Edge Molding**

Reproduction hood edge moldings.

KH-293	1968-69 All	39.99 ea.
KH-293	1970-72 Non-SS	39.99 ea.
KHR-51	1970-72 SS	39.99 ea.



KHS-64

KH-66

KHS-70MC

**Hood Spears**

Reproduction hood spears.

KHS-64	1964 All	79.95 ea.
KHS-65	1965 All (Die-cast)	149.99 ea.
KH-66	1966 All	39.99 ea.
KHS-70MC	1970-72 Monte Carlo	82.99 ea.



EHT-335

**Dixco Hood Tach**

Dixco style hood tach that was originally used on several aftermarket applications for super cars including Yenko, Motion and Big Daddy Don Garlits. You can add this to any car for a cool vintage super car look. White, paint to match.

EHT-335	Dixco Tach	209.99 ea.
---------	------------	------------



KH-2901-GM

**Top of Fender Moldings**

Reproduction moldings which mount to the top of the fenders to "connect" to the rear hood edge molding.

KH-2901-GM 1968-72 w/ Seals ..... 26.99 pr.



KL-1245



KHI-1468K



KC-1255



NL-100



**Hood Insert Ornaments**

Reproduction Super Sport hood ornaments.

KL-1245 1966 Inserts ..... 109.99 pr.  
KHI-1468K 1966 Housings Cast Primed ..... 169.95 pr.  
KC-1255 1967 Ornaments ..... 119.99 pr.  
NL-100 1968-69 Hood Louvers ..... 99.99 pr.



N-4510



**Cowl Vent Grilles**

Correct plastic grilles to keep debris out of cowl.

N-4510 1968-72 Non-AC ..... 21.99 kit  
N-4512 1968-72 w/ AC ..... 21.99 kit  
N-2054 1973-77 All ..... 67.99 ea.



XTD-1630

BTB-56



XTD-10B

**Fuel Tank Door**

Correct spring loaded fuel tank door.

XTD-64D 1964-65 Door ..... 39.99 ea.  
XTD-64K 1964-65 Door Kit ..... 41.83 kit  
XTD-1600 1966-67 Door ..... 54.99 ea.  
XTD-1630 1968-72 Door ..... 26.99 ea.  
XTD-1630K 1968-72 Door Kit ..... 30.13 kit  
XTD-7720FD 1978-88 Flip Down Conversion ..... 19.95 kit  
XTD-10B Door Bumper ..... 1.95 ea.  
BTB-56K Door Bolt ..... 2.59 pr.



RFD-1475L

**El Camino Fuel Tank Door**

Reproduction fuel door which mounts on the quarter panel.

RFD-1475HT 1964-67 ..... 96.99 ea.  
RFD-1475L 1968-72 ..... 57.99 ea.



MK-907

**1967 Remote Rear View Mirror**

Reproduction of the ultra rare remote rear view mirror featuring the correct length cable, interior chrome bezel, mounting kit and highly polished triple chrome finish.

MK-907 1967 All ..... 169.99 ea.  
No Volume Discount.

3921816



**1968 Remote Rear View Mirror**

Reproduction of the ultra rare remote rear view mirror featuring the correct length cable, mounting kit and highly polished triple chrome finish.

3921816 1968 All ..... 169.99 ea.  
No Volume Discount.



MA-70R

**1970-72 Remote Rear View Mirror**

Long discontinued by GM, this OE style reproduction remote rear view mirror offers a perfect replacement or upgrade to your original mirror. Each mirror comes ready to install with cable and switch. We also offer a matching non-functional mirror for the passenger side.

MA-70R 1970-72 Remote ..... 139.99 ea.  
MA-70XR 1970-72 RH ..... 109.99 ea.

Does not fit El Camino. No Volume Discount.

MA-71R



**1971-72 Remote Bullet Style Rear View Mirror**

Reproduction of the ultra rare bullet style remote rear view mirror found on some 1971 and 1972 Chevelles. This kit has everything you need including cable, interior bezel, hardware and paintable mirror.

MA-71R 1971-72 LH ..... 109.95 ea.  
Does not fit El Camino. No Volume Discount.

EMG-231



**1973-77 Mirror Glass**

Correct reproduction bullet mirror glass.

EMG-231 1973-77 LH ..... 26.99 ea.  
EMG-156 1973-77 RH ..... 26.99 ea.

Note: Does not feature wording.



**1964-65 Premium Mirror**  
Premium upgrade mirror. Manufactured out of die-cast zinc with small intricate details and triple chrome plating.

MIR-1035-PQ 1964-65 .....69.99 ea.

**1966-68 Premium Mirror**  
Premium upgrade mirror. Features correct rib line on top of the base. Will not droop like aftermarket mirrors.

MHQ-3171-PQ 1966-68 .....53.95 ea.

**1969-72 Premium Mirror**  
Premium upgrade mirror. Features correct rib line on top of the base. Will not droop like aftermarket mirrors.

MHQ-1316R-PQ 1968-69 RH .....52.99 ea.  
MHQ-1316L-PQ 1968-69 LH .....52.99 ea.



**Mirror Mounting Kits** MHQ-1234  
Complete with bracket, gasket and screws.

MT-1820 1964-65 All .....4.95 kit  
MHQ-1234 1966-69 All .....4.95 kit  
MT-1970 1970-72 All .....4.95 kit  
MHQ-7377 1973-77 All .....6.95 ea.



**Door Handle Gasket Set**  
Complete set of die stamped gaskets for both door handles and lock cylinders.

MEH-4551 1964-72 All .....3.95 kit



**Door Edge Moldings**  
Reproduction door edge guards.

KE-1357 1966-67 Chevelle .....32.95 pr.  
KE-1358 1968-69 Chevelle .....32.95 pr.  
KE-1359 1970-72 Chevelle .....32.95 pr.  
KE-1358 1968-72 El Camino .....32.95 pr.



**Side View Mirrors**

Reproduction triple chrome plated side view mirror. There are many different mirrors on the market, but these are tried and true. We use them on our own cars!

MIR-1035 1964-65 w/ Bowtie .....33.95 ea.  
MHQ-3171 1966-68 Bowtie All .....36.99 ea.  
MRR-68 1966-67 w/o Bowtie .....29.99 ea.  
MHQ-1316L 1968-69 LH .....36.99 ea.  
MHQ-1316R 1968-69 RH .....36.99 ea.  
MA-1812 1970-72 LH or RH .....39.99 ea.  
MA-1812-PQ 1970-72 LH/RH .....46.95 ea.  
MIR-7377L 1973-77 LH .....99.99 ea.  
MIR-7377R 1973-77 RH .....99.99 ea.

*Note: 1968-69 mirrors and 1970-72 mirrors are identical except that the pivot is in a slightly different position as factory.*



**TrimParts Door Handle Kits**

High quality door handles made exclusively by TrimParts in the USA. Fit and function is exact to original. Highest quality on the market!

**Chevelle**  
MPX-4154 1964-65 GM 5716870 .....72.99 pr.  
MPX-4155 1966-67 GM 9706526 .....69.99 pr.  
MPX-4780 1968-69 GM 9712351 .....64.99 pr.  
MPX-4782 1970-72 GM 9717592 .....75.99 pr.

**El Camino**  
MPX-4154 1964-65 GM 5716870 .....72.99 pr.  
MPX-4155 1966-67 GM 9706526 .....69.99 pr.  
MPX-4890 1968-72 GM 9712350 .....64.99 pr.



**Mirror Kits**

Complete kit with (2) rear view mirrors and (2) mirror mounting kits.

MIR-64K 1964-65 Bowtie .....59.75 kit  
MIR-71K 1966-67 Bowtie .....62.88 kit  
MIR-88K 1966-67 w/o Bowtie .....50.98 kit  
MIR-69K 1968-69 Rectangle .....62.88 kit  
MIR-70K 1970-72 Rectangle .....67.98 kit



**Door Handle Kits**

Complete kit with (2) door handles, (1) gasket set, and (1) push button set.

MPX-6967 1964-67 All .....49.99 kit  
MPX-689 1968-69 All .....49.99 kit  
MPX-7286 1970-72 Chevelle .....49.99 kit  
MPX-689 1968-72 El Camino .....49.99 kit  
*1968-72 El Camino door handles are the same as 1968-69 Chevelle door handles.*



**1978-88 Door Handles**

This brand new outer door handle is a perfect replacement for your missing or pitted original. This door handle will really help to freshen up the exterior of your 2 door coupe.

MPX-78GL 1978-88 LH .....17.99 ea.  
MPX-78GR 1978-88 RH .....17.99 ea.





**Eddie Motorsports Billet Door Handles**

EMS billet door handles are CNC machined from solid chunks of 6061-T6 aluminum and will add an awesome custom touch to your exterior. Not only are EMS door handle assemblies stunning to look at but they are also more durable than the factory pieces which are prone to rust, pitting and breakage. Made in USA. Stainless steel fasteners are included.

M = Machined P = Polished R = Red Fusioncoat B = Blue Fusioncoat W = White Fusioncoat PR = Purple Fusioncoat BK = Gloss Black Fusioncoat BKA = Gloss Black Anodized MB = Matte Black Fusioncoat MBA = Matte Black Anodized CL = Clear Coat CA = Clear Anodized

MS277-10\_\_ 1964-67 All Billet Door Handles  
M= 399.99 pr..... P= 415.99 pr..... OTHER= 321.99 pr.

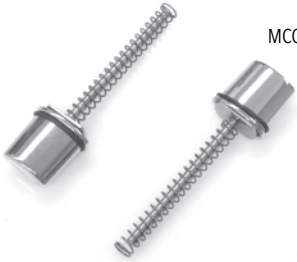

MCC-5255

**Door Handle Push Buttons**  
This is a complete door handle push button kit. This kit includes (2) buttons, (2) rubber rings, (2) springs and (2) retainers for a complete replacement.

MCC-5255 1964-72 All ..... 18.95 kit

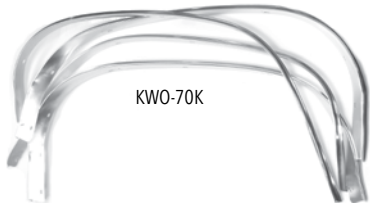

KWO-70K

**Wheel Opening Moldings**

Reproduction extruded aluminum moldings sold in sets of four.

KWO-64K	1964 Chevelle.....	109.95 set
KWO-65K	1965 Chevelle.....	109.95 set
KWO-66K	1966 Chevelle.....	109.95 set
KWO-67K	1967 Chevelle.....	109.95 set
KWO-69K	1968-69 Chevelle.....	99.99 set
KWO-69K-GM	1968-69 Chevelle GM Resto.....	199.99 set
KWO-70K	1970-72 Chevelle.....	99.99 set
KWO-70K-GM	1970-72 Chevelle GM Resto.....	200.99 set
KWO-E64	1964 El Camino.....	111.99 set
KWO-E65	1965 El Camino.....	111.99 set
KWO-E66	1966 El Camino.....	111.99 set
KWO-E67	1967 El Camino.....	111.99 set
KWO-E689	1968-69 El Camino.....	111.99 kit
KWO-E70	1970-72 El Camino.....	111.99 set
KWO-70MC	1970-72 Monte Carlo.....	199.95 set

*Ships Oversize. Not eligible for free shipping. No Volume Discount.*

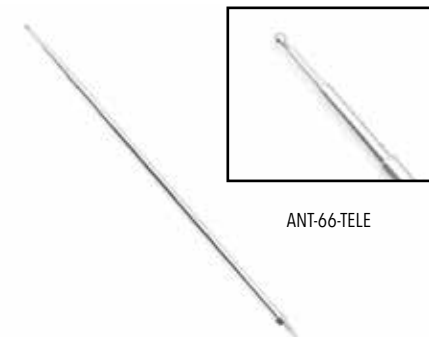

ANT-66-TELE

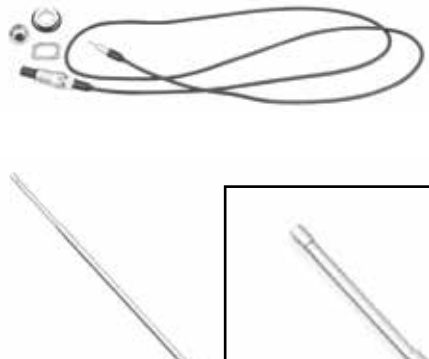

ANT-67-TELE

**Front Telescoping Antenna Kit - OE Correct**

These are excellent reproductions of the original telescoping front antenna assembly, complete with hardware and cable.

ANT-66-TELE	1964-66 All Front.....	89.99 kit
ANT-67-TELE	1967 All Front.....	89.99 kit



ANT-69AMOE

**1969 Correct AM Mast & Nut**

Reproduction AM antenna mast featuring the correct oval tip with groove.

ANT-69AMOE	1969 AM.....	62.99 ea.
------------	--------------	-----------



ANT-03

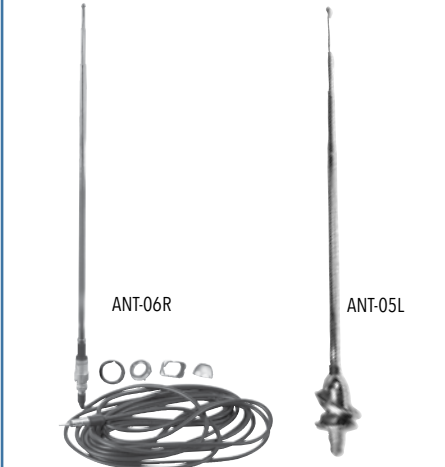

ANT-06R

ANT-05L

**Antenna Kits**

Our kits come complete with correct cable, antenna base, gasket and fixed mast for front fender.

ANT-03	1964-65 All Front.....	49.99 kit
ANT-06	1966-68 All Front.....	49.99 kit
ANT-02	1969 All Front.....	49.99 kit
ANT-05L	1964 Rear "Dummy".....	79.99 ea.
ANT-05R	1964 Rear "Live".....	69.99 kit
ANT-06L	1965-66 Rear "Live"*.....	69.99 ea.
ANT-06R	1965-66 Rear "Live".....	69.95 ea.
ANT-067R	1967 Rear RH Live Telescoping ...	89.99 kit

\*No cable included.



ANT-7088

**Antenna Lead Wire**

Correct lead that mounts to the top of the dash. The windshield antenna plugs into this and the lead goes to the radio.

ANT-7088	1970-77 All.....	34.99 ea.
----------	------------------	-----------



KAB-68AR

**Rear Antenna Bezel**

Correct antenna bezel for rear mounted antenna.

KAB-68AR	1968-69.....	19.99 ea.
----------	--------------	-----------

**BUY'N SAVE**  
WITH KITS



### 1964 Chevelle Grille Kit

This complete grille kit offers you big savings and includes (1) grille, (2) headlamp bezels, (2) eyebrow moldings, (1) upper molding, (1) lower molding and (1) hood molding.

GRILLEKIT-64 1964 All .....490.37 kit



### 1965 Chevelle Grille Kit

This complete grille kit offers you big savings and includes (1) grille, (2) headlamp bezels, (2) below headlamp moldings, (2) eyebrow moldings and (1) hood molding.

GRILLEKIT-65 1965 All .....380.62 kit

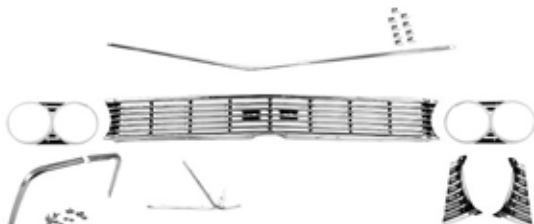

### 1966 Chevelle Grille Kit

This complete grille kit offers you big savings and includes (1) grille, (2) headlamp bezels, (2) fender eyebrow moldings, (2) outer grille extensions, (1) center valance molding, (2) outer valance moldings and (1) hood molding.

GRILLEKIT-66M 1966 Malibu .....466.07 kit  
GRILLEKIT-66S 1966 SS.....466.07 kit



### 1967 Chevelle Grille Kit

This complete grille kit offers you big savings and includes (1) grille, (2) headlamp bezels, (2) outer grille extensions and (1) hood molding.

GRILLEKIT-67M 1967 Malibu .....319.36 kit  
GRILLEKIT-67S 1967 SS.....319.36 kit



### 1968 Chevelle Grille Kit

This complete grille kit offers you big savings and includes (1) grille, (2) upper grille extensions, (2) lower grille extensions, (1) header molding and (2) eyebrow moldings.

GRILLEKIT-68 All Silver .....336.48 kit  
GRILLEKIT-68B SS Silver w/ Black .....327.48 kit  
GRILLEKIT-68X All Silver w/bezels .....566.47 kit  
GRILLEKIT-68XB SS Silver w/ Black .....557.47 kit



### 1969 Chevelle Grille Kit

This complete grille kit offers you big savings and includes (1) grille, (1) header molding, (1) center grille molding, (1) lower grille molding, (2) grille extensions, (2) grille extension moldings, (2) between headlamp moldings and (2) eyebrow moldings.

GRILLEKIT-69 1969 SS.....385.20 kit  
GRILLEKIT-69M 1969 Malibu .....388.56 kit  
*Add 4 headlight bezels for a special price!*  
GRILLEKIT-69X SS w/ Bezels .....557.88 kit  
GRILLEKIT-69XM Malibu w/ Bezels.....561.45 kit



### 1970 Chevelle Grille Kit

This complete grille kit offers you big savings and includes (1) grille, (4) horizontal moldings, (4) "C" end moldings and (2) center vertical moldings.

GRILLEKIT-70 1970 Black .....189.85 kit  
GRILLEKIT-701 1970 Silver.....189.85 kit  
*Add 4 headlight bezels for a special price!*  
GRILLEKIT-70X Black w/ Bezels .....315.84 kit  
GRILLEKIT-701X Silver w/ Bezels .....315.84 kit



### 1971 Chevelle Grille Kit

This complete grille kit offers you big savings and includes; (1) grille, (3) center grille moldings and (2) outer grille moldings.

GRILLEKIT-71 1971 Silver.....224.08 kit  
GRILLEKIT-71B 1971 Black .....224.08 kit  
*Add 2 headlight bezels for a special price!*  
GRILLEKIT-71X 1971 Silver w/ Bezels .....323.07 kit  
GRILLEKIT-71XB 1971 Black w/ Bezels .....323.07 kit



### 1972 Chevelle Grille Kit

This complete grille kit offers you big savings and includes (1) grille and (2) moldings for SS or (4) moldings for regular Chevelle.

GRILLEKIT-72M 1972 Malibu .....139.99 kit  
GRILLEKIT-72SS 1972 SS.....139.99 kit  
*Add 2 headlight bezels for a special price!*  
GRILLEKIT-72XM w/ Bezels .....237.48 kit  
GRILLEKIT-72SX SS w/ Bezels .....237.48 kit

No Volume Discount. All Grille Kits ship Oversize. Emblems sold separately.

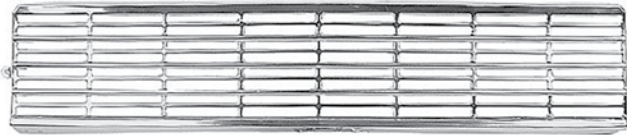

**1964 Grille** LMF-64  
High quality reproduction aluminum grille.  
LMF-64 1964 All ..... 159.99 ea.  
*Ships Oversize. Not eligible for free shipping.*

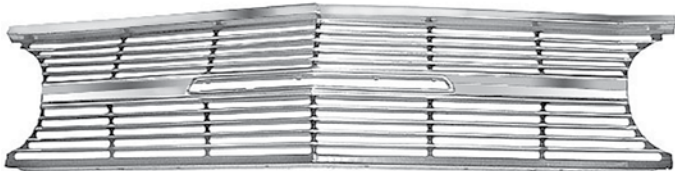

**1965 Grille** LDR-1365  
High quality reproduction; perfect if your original grille is missing or broken.  
LDR-1365 1965 All ..... 169.99 ea.  
*Ships Oversize. Not eligible for free shipping.*



**1966 Grille** LEH-66M  
High quality reproduction grille available in silver for Malibu or black for Super Sport  
LEH-66M 1966 Malibu ..... 119.95 ea.  
LEH-665 1966 SS ..... 119.95 ea.  
*Ships Oversize. Not eligible for free shipping.*



**1967 Grille** LEH-67M  
High quality reproduction grille with correct accenting available for Malibu or for Super Sport.  
LEH-67M 1967 Malibu ..... 119.95 ea.  
LEH-67S 1967 SS ..... 119.95 ea.  
*Ships Oversize. Not eligible for free shipping.*



**1968 Grille** LEH-5400  
High quality reproduction grille featuring the exact same intricate design as the original.  
LEH-5400 1968 All Silver ..... 209.99 ea.  
LEH-5400 1968 SS Silver w/ Black Accents ..... 209.99 ea.  
*Ships Oversize. Not eligible for free shipping.*



**1969 Grille** LEH-2789  
High quality reproduction plastic molded grille.  
LEH-2789 1969 w/o Holes ..... 139.95 ea.  
LEH-2789R 1969 Reproduction ..... 144.95 ea.  
*\*Reproduction is drilled for molding. Ships Oversize. Not eligible for free shipping.*



**1970 Grille** LEH-6117R  
High quality reproduction injection molded plastic grille.  
LEH-6117R 1970 Black ..... 129.95 ea.  
LEH-701 1970 Silver ..... 129.95 ea.  
*Ships Oversize. Not eligible for free shipping.*



**1971 Grille** LEH-2409  
High quality reproduction injection molded plastic grille in silver or black.  
LEH-2409 1971 Silver ..... 129.99 ea.  
LEH-2409B 1971 Black ..... 129.99 ea.  
*Ships Oversize. Not eligible for free shipping.*



**1972 Grille** LEH-9000  
High quality reproduction injection molded plastic grille in black.  
LEH-9000 1972 All ..... 105.99 ea.  
*Ships Oversize. Not eligible for free shipping.*



LEH-79EL



LEH-82EL

**1978-87 Grilles**  
High quality reproduction injection molded plastic grilles.  
LEH-78EL 1978 Malibu/El Camino ..... 89.99 ea.  
LEH-79EL 1979 Malibu/El Camino ..... 129.99 ea.  
LEH-81EL 1981 Malibu/El Camino ..... 99.99 ea.  
LEH-82EL 1982-87 Malibu El Camino ..... 89.99 ea.  
LEH-83MC 1983-86 Monte Carlo NON SS/LS ..... 59.99 ea.  
LEH-86442B 1986 Cutlass 442 Black ..... 199.99 pr.  
LEH-86442S 1986 Cutlass 442 Silver ..... 199.99 pr.  
LEH-87GNB 1987 Buick Regal GN Black ..... 499.99 ea.  
*Ships Oversize. Not eligible for free shipping.*



LVM-1418

**1965 Below Headlamp** LVM-1418  
1965 All ..... 32.99 pr.



BAG-69A

**Deluxe Grille Mounting Kits**

Complete kits with all of the correct factory hardware to properly mount your grille.

BAG-64A	1964 (21 pc.).....	16.99 kit
BAG-65A	1965 (23 pc.).....	14.99 kit
BAG-66A	1966 (16 pc.).....	12.95 kit
BAG-67A	1967 (34 pc.).....	18.99 kit
BAG-68A	1968 (31 pc.).....	19.99 kit
BAG-69A	1969 (51 pc.).....	18.99 kit
BAG-70A	1970 (15 pc.).....	15.99 kit
BAG-71A	1971-72 (15 pc.).....	11.95 kit
BAG-73A	1973 (48 pc.).....	16.95 kit



BAG-D1

**Grille Attaching Kits**

Basic hardware kit for installation of grille and bezels.

BAG-D1	1964-72 All .....	7.99 kit
--------	-------------------	----------



KGB-69

KGB-69U

**1969 Grille Brackets**

Correct brackets for attaching upper grille to header panel and correct bezel/grille brackets.

KGB-69U	1969 Upper.....	18.95 pr.
KGB-69	1969 All Bezels (4 pc.) .....	32.95 kit



RGS-A68

**1968-70 Grille Mounting Brackets**

Reproduction of the hard to find grille mounting brackets.

RGS-A68	1968 All .....	139.99 kit
RGS-A69	1969 All .....	139.99 kit
RGS-A70	1970 All .....	244.99 kit



**1964 Grille Moldings**

LGM-1366

LGM-1366	1964 Upper.....	69.99 ea.
LGM-64L	1964 Lower.....	74.99 ea.



**1968-69 Grille Moldings**

OE style reproduction grille moldings. Buy the complete set and save!

KH-1200	1968-69 Header.....	32.99 ea.
LGM-1285	1969 Center.....	55.99 ea.
LGM-1260	1969 Lower.....	44.99 ea.
LGX-69	1969 (3 pc.).....	120.57 kit

*Moldings ship Oversize. No Volume Discount on kits.*



**1970 Grille Molding Kit**

This Chevelle parts kit includes all of the correct moldings to put the finishing touches on your grille.

LGX-70	1970 .....	80.99 kit
--------	------------	-----------

*Ships Oversize. Not eligible for free shipping.*



LGM-71L

**1971 Grille Moldings**

OE style reproduction grille moldings.

Buy the complete set and save!

LGM-71E

LGM-71L	1971 Center.....	26.99 ea.
LGM-71E	1971 Outer .....	49.99 pr.
LGX-71	1971 (5 pc.).....	118.99 kit

*Ships Oversize. Not eligible for free shipping.*



**1972 Grille Moldings**

LGM-72

OE style reproduction grille moldings.

Buy the complete set and save!

LGM-72U	1972 Upper.....	29.99 ea.
LGM-72C	1972 Center.....	29.99 ea.
LGM-72L	1972 Lower.....	29.99 ea.
LGX-72SS	1972 Super Sport (2 pc.).....	53.98 kit
LGX-72	1972 (4 pc.).....	107.96 kit

*Ships Oversize. Not eligible for free shipping.*



LVM-203

**1966 Valance Moldings**

OE style reproduction lower valance moldings. Buy the set and save!

LVM-203	1966 Center .....	62.99 ea.
LVM-1140	1966 Outer .....	74.99 pr.
LGX-66	1966 All (3 pc.).....	124.18 kit



LGX-815

LGX-975



LGX-267

LGX-112K

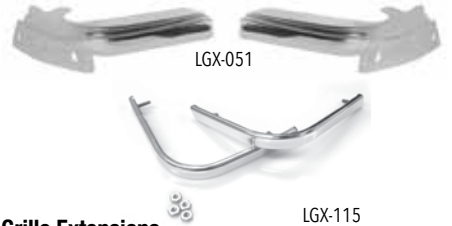

LGX-051

LGX-115

**Grille Extensions**

Reproduction grille extensions with correct material and accenting.

LGX-815	1966 All .....	39.99 pr.
LGX-975	1967 All .....	89.99 pr.
LGX-267	1968 Upper.....	33.95 pr.
LGX-051	1968 Lower.....	26.99 pr.
LGX-112K	1969 Pair .....	34.99 kit
LGX-115	1969 Moldings.....	39.99 pr.



**1964 Chevelle Headlight Bezels**

LHB-564

Beautiful reproduction professionally stamped and painted.

LHB-564	1964 All .....	99.95 pr.
---------	----------------	-----------



**1965 Chevelle Headlight Bezels**

LHB-565

Excellent reproduction with correct creases and paint.

LHB-565	1965 All .....	99.95 pr.
---------	----------------	-----------



**1966 Chevelle Headlight Bezels**

LHB-566

Reproduction crafted of anodized aluminum with correct paint.

LHB-566	1966 All .....	99.95 pr.
---------	----------------	-----------



**1967 Chevelle Headlight Bezels**

LHB-567

Reproductions with correct curves and paint.

LHB-567	1967 All .....	99.95 pr.
---------	----------------	-----------

**1967 Chevelle Headlight Bezel Clips**

These headlights bezel clips are used to space out the bottoms of the headlight bezels.



LHBR-67

LHBR-67 1967 All ..... 12.95 pr.



**1968 Chevelle Headlight Bezels**

Beautiful anodized aluminum reproductions to replace your originals exactly.

LHB-568

LHB-568 1968 All ..... 229.99 kit



**1969 Chevelle Headlight Bezels**

Correctly painted reproductions to replace your originals exactly.

LHB-569

LHB-569 1969 All ..... 159.99 kit



**1970 Chevelle Headlight Bezels**

Reproduction die cast chrome plated bezels.

LHX-1676

LHX-1676 1970 All ..... 139.99 kit



LHX-1398

**1971 Chevelle Headlight Bezels**

Reproduction headlight bezels.

LHX-1398 1971 All ..... 109.99 pr.



LHX-1399

**1972 Chevelle Headlight Bezels**

Reproduction die cast chrome plated bezels.

LHX-1399 1972 All ..... 109.99 pr.



LHB-7677

**1976-77 Headlamp Bezels**

Chrome plated high quality reproductions.

LHB-7677 1976-77 Malibu ..... 149.99 pr.



LGM-69S

**1969 Between Headlamp**

These moldings add the finishing touch between the headlamps.

LGM-69S 1969 All ..... 39.99 pr.



RF-70XL



RF-71XR

LEB-70

**Fender Extensions**

Reproduction fender extensions.

RF-70XL 1970 Chevelle LH ..... 69.99 ea.  
RF-70XR 1970 Chevelle RH ..... 69.99 ea.  
LEB-70 1970 Chevelle Brackets ..... 32.99 kit  
RF-70EL 1970 El Camino LH ..... 59.99 ea.  
RF-70ER 1970 El Camino RH ..... 59.99 ea.  
RF-71XL 1971-72 Chevelle LH ..... 199.99 ea.  
RF-71XR 1971-72 Chevelle RH ..... 199.99 ea.



LHM-23

**1970 Headlamp Extension Molding**

This special lower extension molding appeared on various 1970 Chevilles and adds a nice finishing touch.

LHM-23 1970 All ..... 89.99 pr.



LFH-912

**1964 Eyebrow Moldings**

Correct anodized aluminum eyebrow molding with hardware.

LFH-912 1964 All ..... 69.99 pr.



LFH-239

**1965 Eyebrow Moldings**

Correct anodized aluminum eyebrow molding with hardware.

LFH-239 1965 All ..... 69.99 pr.



LFH-200

**1966 Eyebrow Moldings**

Correct anodized aluminum eyebrow molding with hardware.

LFH-200 1966 All ..... 69.99 pr.



LEB-68C

**1968 Eyebrow Moldings**

Correct anodized aluminum eyebrow molding with hardware.

LEB-68C 1968 All ..... 69.99 pr.



LFH-1230

LFH-621

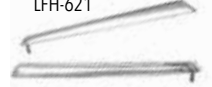

**1969 SS Eyebrow Moldings**

Correct "short" anodized aluminum eyebrow molding.

LFH-621 1969 SS ..... 55.99 pr.

**1969 Malibu Eyebrow Moldings**

Correct "long" anodized aluminum eyebrow molding with hardware.

LFH-1230 1969 Malibu ..... 59.95 pr.



LHS-64

LHS-70



LHA-64K

**Headlamp Adjustment Kit**

Plastic nuts and screws for headlamp adjustment. Each kit does one car.

LHA-64K 1964-70 All (8 pc.) ..... 7.95 kit  
LHA-73K 1971-72 All (4 pc.) ..... 5.95 kit  
LHA-789K 1978-79 (6 pc.) ..... 11.95 kit  
LHA-801K 1980-81 (6 pc.) ..... 18.99 kit  
LHA-827K 1982-87 (6 pc.) ..... 15.95 kit

**Headlamp Springs**

Correct spring used for proper adjustment.

LHS-64 1964-67 All ..... 2.99 ea.  
LHS-70 1968-70 All ..... 1.50 ea.  
LHS-71 1971-75 All ..... 2.95 ea.

BAG-D1

**Bezel Attaching Kits**

Basic hardware kit for installation of bezels.

BAG-D1 1964-72 All ..... 7.99 kit



LHB-7AA

**1964-70 Headlamp Bucket Kit**

Complete kit includes (4) buckets, (4) trim rings and (12) screws.

LHB-7AA 1964-70 Set of (4) ..... 99.99 kit

LHB-989

**1971-72 Headlamp Buckets**

Reproduction headlamp buckets.

LHB-989 1971-72 LH ..... 35.99 ea.  
LHB-988 1971-72 RH ..... 35.99 ea.

LHR-10K

LHR-574

**Headlamp Retainer**

Correct stainless steel rings and attaching screws.

LHR-574 1964-70 All ..... 13.95 ea.  
LHR-K4 1964-70 All (8 pc.) ..... 50.66 kit  
LHR-663 1971-72 All ..... 11.99 ea.  
LHR-K4 1964-70 All (4 pc.) ..... 50.66 kit  
LHR-10K Screws (3 pc.) ..... 0.95 kit

**Front Bumpers**

These are the highest quality reproduction bumpers on the market. Each bumper starts out with a nickel core and is then triple chrome plated for a beautiful shine. You will not find a nicer reproduction bumper.

	MAU-64F	1964 All .....	239.99 ea.
	MAU-65F	1965 All .....	269.99 ea.
	MAU-66F	1966 All .....	259.99 ea.
	MAU-67F	1967 All .....	259.99 ea.
	MAU-67F-PQ	1967 All Premium Quality .....	315.99 ea.
	MAU-68F	1968 All .....	239.99 ea.
	MAU-69F	1969 All .....	259.99 ea.
	MAU-70F	1970 Chevelle.....	259.99 ea.
	MAU-E70	1970 El Camino .....	269.99 ea.
	MAU-71F	1971-72 All .....	259.99 ea.

**Rear Bumpers**

These are the highest quality reproduction bumpers on the market. Each bumper starts out with a nickel core and is then triple chrome plated for a beautiful shine. You will not find a nicer reproduction bumper.

	MAU-64R	1964 Chevelle / El Camino .....	239.99 ea.
	MAU-65R	1965 Chevelle / El Camino .....	239.99 ea.
	MAU-66R	1966 Chevelle.....	259.99 ea.
	MAU-67R	1967 Chevelle.....	269.99 ea.
	MAU-67R-PQ	1967 Chevelle Premium Quality .....	339.99 ea.
	MAU-68R	1968 Chevelle.....	269.99 ea.
	MAU-69R	1969 Chevelle.....	259.99 ea.
	MAU-70R	1970 Chevelle.....	229.99 ea.
	MAU-71R	1971-72 Chevelle .....	239.99 ea.

*All bumpers ship Oversize 2. Not eligible for free shipping.*

**Bumper Bolts**

Correct chrome pan head bumper bolts complete with hardware. 7/16" x 1".

BPB-716	All .....	1.95 ea.
BPB-716K	All Front & Rear.....	17.99 kit
BPB-E74F	1974-77 El Camino Front.....	19.95 kit
BPB-E73R	1973-77 El Camino Rear.....	19.99 kit
BPB-E78R	1978-87 El Camino Rear* .....	25.99 kit

\*Without rubber impact strip.

BPB-716





### Bumper Kits

Replace both of your pitted, missing or old bumpers at the same time and save!

BUMPER-KIT64	1964 Chevelle .....	448.17 kit	BUMPER-KIT70	1970 Chevelle .....	457.17 kit
BUMPER-KIT65	1965 Chevelle .....	475.17 kit	BUMPER-KIT70RK	1970 Chevelle SS w/ Pad .....	547.17 kit
BUMPER-KIT66	1966 Chevelle .....	484.17 kit	BUMPER-KIT71	1971-72 Chevelle .....	466.17 kit
BUMPER-KIT67	1967 Chevelle .....	493.17 kit	BUMPER-KIT70E	1970 El Camino .....	493.17 kit
BUMPER-KIT68	1968 Chevelle .....	475.17 kit	BUMPER-KIT71E	1971-72 El Camino .....	484.17 kit
BUMPER-KIT69	1969 Chevelle .....	484.17 kit	<i>Ships Oversize 2. Not eligible for free shipping.</i>		

**BUY'N SAVE**  
WITH KITS



### 1970 Chevelle SS Rear Bumper

This is the same triple chrome plated bumper as on the previous page, but with a professionally installed correct SS rear pad on it to save you the hassle. This pad features all new tooling and looks just like original!

MAU-70RK	1970 Super Sport .....	329.99 ea.
----------	------------------------	------------

*Ships Oversize 2. Not eligible for free shipping.*



MAU-E70

MAU-E8R



RBF-E7888R

### El Camino & Monte Carlo Bumpers

Excellent quality triple chrome plated bumpers for your El Camino.

MAU-64F	1964 El Camino Front .....	239.99 ea.
MAU-E70	1970 El Camino/Monte Front .....	269.99 ea.
MAU-64R	1964 El Camino Rear .....	239.99 ea.
MAU-E6R	1966 El Camino Rear .....	259.99 ea.
MAU-E7R	1967 El Camino Rear .....	279.99 ea.
MAU-E8R	1968-72 El Camino Rear .....	259.99 ea.
MAU-70MC-REAR	1970-72 Monte All Rear .....	399.99 ea.
MAU-MC71F	1971 Monte Front .....	239.99 ea.
MAU-MC72F	1972 Monte Front .....	239.99 ea.
RIB-81	1981-82 Monte Front Impact Bar* .....	99.99 ea.
RIB-81R	1981-88 Monte Rear Impact Bar* .....	109.99 ea.
RIB-83	1983-86 Monte Front Impact Bar* .....	99.99 ea.

\*Except LS & SS. Ships Oversize 2. Not eligible for free shipping.

### 1978-87 El Camino Rear Bumper Filler Panels

This bumper filler panel fills the gap behind the bumper and rear of the quarter panels.

RBF-E7888R	1978-87 .....	54.99 pr.
------------	---------------	-----------



MCF-1413

### Rear Bumper Pads

These are reproductions of the original GM rear bumper pads found on SS models.

MCF-1413	1970 Chevelle SS .....	139.99 ea.
MCF-71	1971 Monte Carlo SS .....	399.99 ea.

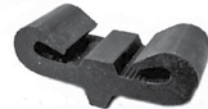

### Front Bumper Bracket Reinforcement Rubber Insulator

Correct front bumper bracket reinforcement rubber insulator.

MRI-70A	1970-72 .....	6.95 ea.
---------	---------------	----------



BTB-56



XTD-10B



### Fuel Tank Door

XTD-1630

Correct spring loaded fuel tank door.

XTD-64D	1964-65 Door .....	39.99 ea.
XTD-1600	1966-67 Door .....	54.99 ea.
XTD-1630	1968-72 Door .....	26.99 ea.
XTD-10B	Door Bumper .....	1.95 ea.
BTB-56K	Door Bolt .....	2.59 pr.



MLB-70



MLB-1424

### License Plate Brackets

Reproduction brackets for mounting license plates.

MLB-1424	1964-65 Rear .....	59.95 ea.
MLB-70	1970-72 Front .....	17.99 ea.
XTD-8287	1981-87 Monte Front .....	19.95 ea.



BBF-4564

### Bumper Bracket Bolt Kit

These complete hardware kits make mounting bumper brackets a snap!

BBF-4541	1964-66 All Front 14pc .....	18.99 kit
BBF-4564	1964-65 Chevelle Rear 16pc .....	22.99 kit
BBF-4522	1964-65 El Camino Rear 26pc .....	31.99 kit
BBF-4543	1966 Chevelle Rear 26pc .....	31.99 kit
BBF-4519	1967 All Front 14pc .....	25.99 kit
BBF-4521	1967 Chevelle Rear 26pc .....	28.99 kit
BBF-5510	1967 El Camino Rear 26pc .....	31.99 kit
BBF-4482	1968-69 All Front 16pc .....	22.99 kit
BBF-4507	1968 Chevelle Rear 26pc .....	33.99 kit
BBF-4484	1969 Chevelle Rear 24pc .....	25.99 kit
BBF-4487	1968-69 El Camino Rear 22pc .....	29.99 kit
BBF-5969	1970-72 All Front 16pc .....	20.99 kit
BBF-4215	1970-72 Chevelle Rear 12pc .....	19.99 kit
BBF-5972	1970-72 El Camino Rear 20pc .....	31.99 kit



**Bumper Guards & Cushions**

Great replacements for your pitted or missing originals!

MBG-71	1971-72 Front w/ Cushions .....	89.95 pr.
MBG-71R	1971-72 Rear w/ Cushions.....	114.99 pr.
MBS-702A	1970-72 Front Cushions Only.....	39.99 pr.



**Bumper Brackets**

Reproduction bumper bracket sets with all necessary brackets for mounting your front or rear bumper.

**Front**

MBB-64F	1964 All (4 pc.).....	129.99 kit
MBB-65F	1965 All (4 pc.).....	129.99 kit
MBB-66F	1966 All (4 pc.).....	129.99 kit
MBB-67F	1967 All (4 pc.).....	129.99 kit
MBB-68F	1968 All (4 pc.).....	129.99 kit
MBB-69F	1969 All (4 pc.).....	129.99 kit
MBB-70F	1970 All (4 pc.).....	129.99 kit
MBB-71F	1971-72 All (8 pc.).....	129.99 kit

**Rear**

MBB-64R	1964-65 All (5 pc.).....	129.99 kit
MBB-66R	1966-67 Chevelle (4 pc.).....	129.99 kit
MBB-66E	1966-67 El Camino (4 pc.).....	129.99 kit
MBB-68R	1968 Chevelle (5 pc.).....	129.99 kit
MBB-69R	1969 Chevelle (3 pc.).....	129.99 kit
MBB-70R	1970 Chevelle (4 pc.).....	129.99 kit
MBB-71R	1971-72 Chevelle (4 pc.).....	129.99 kit
MBB-1410	1968-72 El Camino (7 pc.).....	129.99 kit

No Volume Discount.



**1964-67 Bumper Bracket Washer**

Correct washers used to align front & rear bumpers.

BBW-64A	1964-67 (4 pc.).....	11.99 set
---------	----------------------	-----------



**Bumper Bracket Bolts**

New bumper bracket bolts with correct teeth washers and nut.

BBF-13	All.....	6.99 ea.
--------	----------	----------



**BUY'N SAVE**  
WITH KITS

**1966 Lens & Bezel Kit**

This kit contains all items needed to give your rear a make over; all (2) lenses, (2) bezels, (2) retainers and a complete set of clips.

LBZKIT-66	1966 Chevelle.....	231.14 kit
-----------	--------------------	------------



**1967-1969 Tail Lamp Kits**

Includes (2) bezels, (2) bezel seals, (2) lenses and (2) gaskets for an easy and convenient replacement!

LBR-1100K	1967 Chevelle.....	194.36 kit
LBR-1380K	1968 Chevelle.....	226.76 kit
LBR-1381KIT	1969 Chevelle.....	192.56 kit



**1966 Chevelle Bezels**

Beautifully reproduced anodized aluminum.

LTB-2310	1966 Chevelle.....	62.95 pr.
----------	--------------------	-----------



**1966 Chevelle Retainers**

Correct tail lamp retainers.

LTB-2315	1966 Chevelle.....	31.99 ea.
----------	--------------------	-----------



**Tail Lens Housings**

Reproductions of these hard to find tail lamp housings.

LTH-65	1965 w/ Gaskets.....	139.99 pr.
LTH-67L	1967 LH.....	219.99 ea.
LTH-67R	1967 RH.....	219.99 ea.
LTH-68L	1968 LH.....	219.99 ea.
LTH-68R	1968 RH.....	219.99 ea.
LTH-69L	1969 LH.....	219.99 ea.
LTH-69R	1969 RH.....	219.99 ea.
LTH-70K	1970 Pair.....	129.99 pr.
LTH-70-RETNR	1970-75 Housing Retainer.....	11.99 ea.

1970 constructed of high quality plastic. 71-72 Coming Soon.





JQS-66

**Quarter Panel Extension Seal**

Correct seal between extension and 1/4 panel.

JQS-66	1966-67 Chevelle .....	9.99 pr.
JQS-68	1968-69 Chevelle .....	9.99 pr.

**1966 Chevelle Clips**

Correct kit for retaining bezels to car.

LTR-CLIP	1966 Chevelle.....	11.95 set
----------	--------------------	-----------



LTH-E7

**El Camino Tail Lens Bezels**

Reproduction tail lamp bezels for your El Camino.

LTH-E4	1964 Bezels .....	142.99 pr.
LTH-G4	1964-65 Gasket .....	21.95 pr.
LTH-E5	1965 Bezels .....	142.99 pr.
LTH-E9	1968-69 Bezels .....	139.99 pr.
LTH-G9	1968-69 Gasket .....	21.95 pr.
LTH-E7	1970-72 Bezels .....	139.99 pr.
LTH-G7	1970-72 Gasket .....	21.95 pr.



LBR-1100



LBR-1380



LBR-1381

**Tail Lens Bezels**

Beautiful die cast and triple chrome plated bezels with correct semi black accenting original grain and mounting studs.

LTB-2310	1966 Chevelle.....	62.95 pr.
LBR-1100	1967 Chevelle.....	149.99 pr.
LBR-1380	1968 Chevelle.....	139.99 pr.
LBR-1381	1969 Chevelle.....	129.99 pr.



LBG-69

**Tail Lamp Bezel Gaskets**

Correct sponge tail lamp bezel gaskets for Chevelles.

JSS-1456	1966 (to body).....	5.99 pr.
JSS-5196	1967 (to body).....	13.99 pr.
LBG-68	1968 .....	15.99 pr.
LBG-69	1969 .....	6.99 pr.
LBG-69-INNER	1969 (to body).....	44.99 pr.



KRC-641

**Rear Panel C Moldings**

Correct anodized aluminum rear "C" moldings complete with mounting hardware.

KRC-641	1964 Chevelle.....	74.99 pr.
KRC-651	1965 Chevelle.....	82.99 pr.



**BUY'N SAVE**  
WITH KITS

KRM-69K



**Rear Panel Moldings**

High quality aluminum extruded reproductions featuring all correct accenting and clips.

KRM-64U	1964 Upper.....	49.99 ea.
KRM-64L	1964 Lower.....	49.99 ea.
KRM-65U	1965 Upper.....	39.99 ea.
KRM-65L	1965 Lower.....	39.99 ea.
KRM-65TU	1965 Upper Die Cast.....	119.99 ea.
KRM-65TL	1965 Lower Die Cast.....	119.99 ea.
KRM-66	1966 Upper/Lower.....	30.99 ea.
KRM-67T	1967 Trunk Lid Edge.....	49.99 ea.
KRM-67U	1967 Upper.....	49.99 ea.
KRM-67L	1967 Lower.....	49.99 ea.
KRM-68U	1968 Upper.....	49.99 ea.
KRM-68L	1968 Lower.....	49.99 ea.
KRM-69U	1969 Upper.....	49.99 ea.
KRM-69L	1969 Lower.....	49.99 ea.

All rear panel moldings ship Oversize. Not eligible for free shipping.

**Rear Panel Molding Kits**

Replace all of your rear panel moldings at once and save!

KRM-64K	1964 (2 pc.).....	89.98 kit
KRM-65K	1965 (4 pc.).....	287.96 kit
KRM-66K	1966 (2 pc.).....	55.78 kit
KRM-67K	1967 (3 pc.).....	134.97 kit
KRM-68K	1968 (2 pc.).....	89.98 kit
KRM-69K	1969 (2 pc.).....	89.98 kit

All rear panel moldings ship Oversize. Not eligible for free shipping.

**1964 Chevelle Rear Panel Molding Kit**

If your original center rear Chevelle tail panel moldings have seen better days or are entirely missing, you can now replace them with this new reproduction set to restore the rear of your car. While the originals were die cast, this excellent injection molded plastic panel set is a great cost effective solution to restoring originals. *No Volume Discount.*

KRT-A64	1964 Chevelle.....	299.99 kit
---------	--------------------	------------



KRT-A64

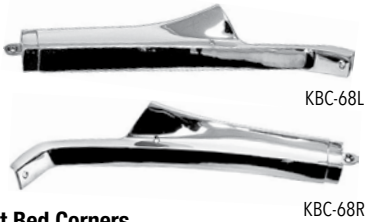

**Front Bed Corners**

Reproduction front bed corner moldings.

KBC-68L	1968-72 LH.....	53.99 ea.
KBC-68R	1968-72 RH.....	53.99 ea.
KBC-68F	1968-72 LH/RH.....	97.18 pr.



**Rear Bed Corners**

Reproduction rear bed corner moldings.

KBC-64R	1964-67.....	79.99 pr.
KBC-68RL	1968-72 LH.....	44.99 ea.
KBC-68RR	1968-72 RH.....	44.99 ea.
KBC-78G	1978-87.....	76.95 pr.



**Rear Corner Vertical Moldings**

Die cast reproductions of the pieces that connect the bed corners to the tail lamp bezels.

KCV-3	1968-72 El Camino.....	39.99 pr.
-------	------------------------	-----------

**Front of Bed Molding**

Correct molding which fits below the rear window, complete with clips.

KFB-8	1968-72 El Camino.....	49.95 pr.
KBM-108L	1978-87 LH.....	89.95 ea.
KBM-108R	1978-87 RH.....	89.95 ea.

*Ships Oversize. Not eligible for free shipping.*

**Bed Rail Moldings**

High quality stainless steel reproduction bedrail moldings with correct mounting clips.

KBR-67	1964-67 LH/RH.....	63.99 ea.
KBR-7	1968-72 LH/RH.....	59.99 ea.
KBR-78G	1978-87 LH/RH.....	176.99 pr.
KMC-0372	1978-87 Clips.....	7.95 ea.

*Ships Oversize. Not eligible for free shipping.*



**Bed Molding Kits**

Complete kit with all necessary moldings.

**1964-67 kit includes:** (2) bed rails, (2) rear corners and (1) top of tailgate molding all with clips.

**1968-72 kit includes:** (2) bed rails, (2) front corners, (2) rear corners, (2) corner verticals, (1) top of tailgate and (1) front of bed molding all with clips.

**1978-87 kit includes:** (1) pair of long bed moldings, (1) pair of upper cab moldings, (1) top of tailgate molding, (1) pair of rear corner top bed moldings, (1) set of hardware and clips.

KBM-1X	1964-67 El Camino.....	263.66 kit
KBM-5X	1964-67 El Camino w/ Cab Moldings.....	533.62 kit
KBM-3X	1968-72 El Camino.....	430.05 kit
KBM-78K	1978-87 El Camino.....	469.99 kit

*Ships Oversize. Not eligible for free shipping.*

**Tailgate Molding Kits**

Save when you buy a pair of upper & lower.



KTM-68X	1968-69 (2 pc.).....	88.18 pr.
KTM-70X	1970-72 (2 pc.).....	88.18 pr.



**Tailgate Extension Moldings**

Correct small moldings that fit between the tailgate panel moldings and tail lamp bezels.

KTE-2	1968-69 El Camino.....	19.99 pr.
-------	------------------------	-----------



**Top Tailgate Moldings**

Correct top of tailgate moldings with clips

KTG-64	1964-67 El Camino.....	84.99 ea.
KTG-70	1968-72 El Camino.....	69.95 ea.

*Ships Oversize. Not eligible for free shipping.*

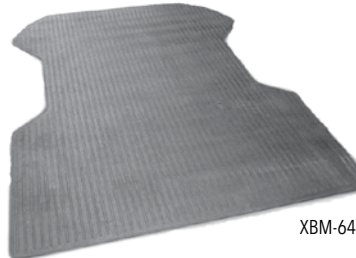

**Bed Mat**

New heavy duty rubber mat to provide the ultimate protection for your bed. Utility Quality.

XBM-64	1964-67 El Camino.....	149.99 ea.
XBM-70	1968-72 El Camino.....	149.99 ea.
XBM-73	1973-77 El Camino.....	149.99 ea.
XBM-78	1978-88 El Camino.....	179.99 ea.

*Ships Oversize. Not eligible for free shipping.*



**Cab Molding Kit**

Brand new high quality chrome upper cab molding for your El Camino.

KBM-E64	1964-67.....	299.95 kit
KCM-78G	1978-87 Upper Cab Moldings....	159.95 pr.

*Ships Oversize. Not eligible for free shipping.*



**Tailgate Handle**

Reproduction inner tailgate handle with nylon washer.

RTH-E4817	1968-72.....	18.99 ea.
-----------	--------------	-----------

**Tailgate Moldings**

High quality anodized aluminum moldings with correct paint schemes and attaching clips.

KTM-68U	1968-69 Upper.....	48.99 ea.
KTM-68L	1968-69 Lower.....	48.99 ea.
KTM-70U	1970-72 Upper.....	48.99 ea.
KTM-70L	1970-72 Lower.....	48.99 ea.

### Fenders

Our reproduction fenders are manufactured to duplicate the originals in both fit and appearance. All fenders come EDP coated. Just as with original GM fenders, we recommend test fitting before painting or modifying.

No Volume Discount. All fenders ship Truck Freight to a commercial address. Not eligible for free shipping.



- RF-65L 1965 All LH .....389.99 ea.
- RF-65R 1965 All RH .....389.99 ea.



- RF-66L 1966 All LH .....319.99 ea.
- RF-66R 1966 All RH .....319.99 ea.



- RF-67TL 1967 All LH .....319.99 ea.
- RF-67TR 1967 All RH .....319.99 ea.



- RF-68TL 1968 All LH .....319.99 ea.
- RF-68TR 1968 All RH .....319.99 ea.



- RF-69TL 1969 All LH .....319.99 ea.
- RF-69TR 1969 All RH .....319.99 ea.

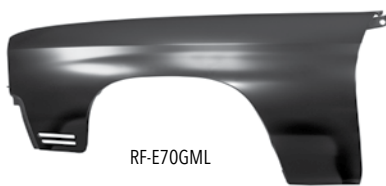

- RF-70GML 1970 Chevelle LH .....319.99 ea.
- RF-70GMR 1970 Chevelle RH .....319.99 ea.
- RF-E70GML 1970 El Camino/Wagon LH .....279.99 ea.
- RF-E70GMR 1970 El Camino/Wagon RH .....279.99 ea.

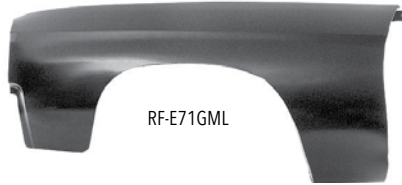

- RF-71GML 1971-72 Chevelle LH .....319.99 ea.
- RF-71GMR 1971-72 Chevelle RH .....319.99 ea.
- RF-E71GML 1971-72 El Camino/Wagon LH ...329.99 ea.
- RF-E71GMR 1971-72 El Camino/Wagon RH...329.99 ea.
- RF-78L 1978-81 Malibu/El Camino LH ...319.99 ea.
- RF-78R 1978-81 Malibu/El Camino RH...319.99 ea.
- RF-82L 1982-87 Malibu/El Camino LH ...319.99 ea.
- RF-82R 1982-87 Malibu/El Camino RH...319.99 ea.

BUY'N SAVE

WITH KITS

Fender Kits

These kits include a pair of fenders at a great price!

- RF-65TK 1965 All.....645.98 kit
- RF-66TK 1966 All.....639.98 kit
- RF-67TK 1967 All.....639.98 kit
- RF-68TK 1968 All.....639.98 kit
- RF-69TK 1969 All.....639.98 kit
- RF-70TK 1970 All.....539.98 kit
- RF-712TK 1971-72 All .....539.98 kit



- RFB-3900 1966-72 All .....23.99 pr.



### Inner Fender to Radiator Support Brackets

This is a pair of 1970 Chevelle inner fender to radiator support brackets which are stamped from heavy gauge steel as original.

- RSB-3470 1970 All .....34.99 pr.



### Front Inner Fenders

Brand new die-stamped inner fender wells.

- RIF-65L 1965 All LH .....144.99 ea.
- RIF-65R 1965 All RH .....144.99 ea.
- RIF-65AK 1965 All RH/LH .....314.97 kit
- RIF-66AL 1966 All LH .....119.99 ea.
- RIF-66AR 1966 All RH .....119.99 ea.
- RIF-66AK 1966 All Pair.....269.97 kit
- RIF-67AL 1967 All LH .....119.99 ea.
- RIF-67AR 1967 All RH .....119.99 ea.
- RIF-67AK 1967 All Pair.....215.98 kit
- RIF-68SL 1968-72 All LH .....119.99 ea.
- RIF-68SR 1968-72 All RH .....119.99 ea.
- RIF-68KIT 1968-72 All Pair.....227.98 kit
- RIF-73P 1973-77 All Plastic.....249.99 pr.
- RIF-78EM 1978-87 El Camino, 78-83 Malibu ...399.99 pr.
- BIF-64K Hardware Kit.....29.99 ea.
- RIFS-787 1978-80 All Inner Fender Shields.....44.95 pr.

*Ships Oversize 2. Not eligible for free shipping.*



RFP-702L

### Fender Patches

High quality fender patches for this commonly rusted area.

- RFP-64L 1964-65 All LH .....49.99 ea.
- RFP-64R 1964-65 All RH .....49.99 ea.
- RFP-66L 1966-67 All LH .....49.99 ea.
- RFP-66R 1966-67 All RH .....49.99 ea.
- RFP-89L 1968-69 Chevelle LH .....49.99 ea.
- RFP-89R 1968-69 Chevelle RH .....49.99 ea.
- RFP-702L 1970-72 Chevelle LH .....54.99 ea.
- RFP-702R 1970-72 Chevelle RH .....54.99 ea.
- RFP-89L 1968-72 El Camino LH .....49.99 ea.
- RFP-89R 1968-72 El Camino RH .....49.99 ea.



RRS-65



RRS-68-HQHD

**Radiator Supports**

Reproduction radiator supports.

RRS-65	1965 All .....	199.99 ea.
RRS-66R	1966 All .....	139.99 ea.
RRS-667	1967 All .....	139.99 ea.
RRS-089	1968-69 All .....	169.99 ea.
RRS-07M	1970 All .....	169.99 ea.
RRS-712	1971-72 All .....	149.99 ea.
RRS-8188	1981-88 Monte Carlo .....	489.99 ea.
RSB-1330	1981-88 Monte Carlo 3 pc Support Brace Kit .....	79.95 kit

These high quality supports are made of the finest steel and tooling. They are made as original and would be a great addition to any restoration.

RRS-68-HQHD	1968 All, HD Cooling .....	249.99 ea.
RRS-69-HQHD	1969 All, HD Cooling .....	249.99 ea.
RRS-70-HQHD	1970 All, HD Cooling .....	249.99 ea.
RRS-712-HQHD	1971-72 All, HD Cooling .....	249.99 ea.

No Volume Discount. Ships Oversize 2. Not eligible for free shipping.

RRS-7SB



**Radiator to Frame Brackets**

Replacement for the hard to find brackets which the radiator support bushings mount to. Stamped from heavy gauge steel as original.

RRS-7SB	1970-72 .....	69.99 pr.
---------	---------------	-----------



BFE-8002



**Front End Fastener Kit**

Over 175 pieces all individually bagged to attach all of your front end sheet metal including fenders, grille, inner fenders, hood, etc.

BFE-8001	1964-72 All .....	69.99 kit
----------	-------------------	-----------

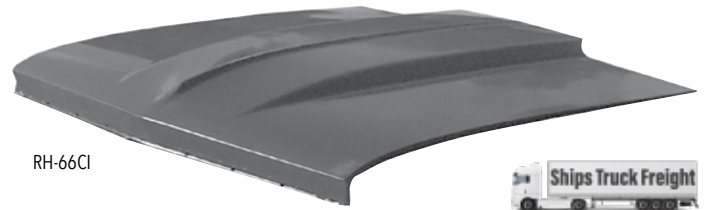

RH-66CI

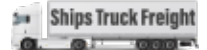

**Cowl Induction Hoods**

These are the hoods that GM should have made! Let people know your ride means business with one of these 2" cowl hoods!

RH-66CI	1966 All .....	369.99 ea.
RH-67CI	1967 All .....	389.99 ea.
RH-68CI	1968-69 All .....	439.99 ea.
RH-812	1981-88 Monte Carlo 2" Cowl .....	439.99 ea.
RH-814FG	1981-88 Monte Carlo 2" Cowl Fiberglass .....	575.99 ea.
RH-872	1978-88 Buick Regal GN 2" Cowl .....	399.99 ea.
RH-8187-2	1978-88 Malibu/ El Camino 2" Cowl .....	539.99 ea.

No Volume Discount. Ships Truck Freight to a commercial address. Not eligible for free shipping. Use 1969 hinges with 1968-69 hoods.



RH-65



**1965 Chevelle Hood**

This is a reproduction of the nearly impossible to find 1965 Chevelle flat hood. This hood is a perfect replacement for your damaged original so you will no longer have to search the junkyards and swap meets for a decent hood.

RH-65	1965 All .....	439.99 ea.
-------	----------------	------------

No Volume Discount. Ships Truck Freight to a commercial address. Not eligible for free shipping.



KL-1245



KHI-1468K



**1966 Chevelle Hoods**

Reproduction die-stamped flat hoods and Super Sport hoods.

RH-66SSKIT	1966 SS Hood w/ Ornaments .....	557.94 kit
RH-66SS	1966 Super Sport Hood Only .....	339.99 ea.
KHI-1468K	1966 Ornament Housings Only .....	169.95 pr.
KL-1245	1966 Ornament Inserts Only .....	109.99 pr.
RH-66M	1966 Standard .....	359.99 ea.

No Volume Discount. Ships Truck Freight to a commercial address. Not eligible for free shipping.



**BUY'N SAVE WITH KITS**

**1967 Chevelle Hoods**

Reproduction die-stamped Super Sport hood.

RH-67SSKIT	1967 SS Hood w/ Ornaments .....	413.98 kit
RH-67SSKITH	SS Hood w/ Ornaments, & Front Edge Molding .....	454.44 kit
RH-67SS	1967 Super Sport Hood Only .....	339.99 ea.
KC-1255	1967 Louvers Only .....	119.99 pr.

No Volume Discount. Ships Truck Freight to a commercial address. Not eligible for free shipping.



**BUY'N SAVE WITH KITS**

**1968-69 Chevelle Hoods**

Reproduction die-stamped Super Sport hood.

RH-689SSKIT	1968-69 SS Hood w/ Ornaments .....	488.98 kit
RH-689SS	1968-69 Super Sport Hood Only .....	389.99 ea.
NL-100	1968-69 Louvers Only .....	99.99 pr.

Use 1969 hinges for 1968.

No Volume Discount. Ships Truck Freight to a commercial address. Not eligible for free shipping.



**1970-72 SS Domed Chevelle Hood**

Reproduction die-stamped Super Sport hood.

RH-702	1970-72 All w/o Cowl Induction .....	399.99 ea.
--------	--------------------------------------	------------



**1970-72 Chevelle Hoods**

Reproduction die-stamped Super Sport or Cowl Induction hoods.

RH-70RK	1970-72 SS Cowl Hood Kit .....	886.08 kit
RH-70R	1970-72 All Cowl Induction Hood .....	439.99 ea.
ACX-970	1970-72 Outer Cowl Door Kit .....	157.32 kit
HPK-100	1970-72 Complete Hood Pin Set .....	34.99 kit
MSS-2970	1970-72 SS Stripe Stencil Kit .....	49.99 kit
NC-117	1970-72 Hood Insulation* .....	29.99 ea.

No Volume Discount. \*Fits reproduction cowl hood listed above. Ships Truck Freight to a commercial address. Not eligible for free shipping.

**Hood Hinge Kit 1968-72 Repro Style**

These are high quality reproduction hood hinges complete with springs and featuring a black EDP coating.

RHG-68KWS	1968 All LH & RH .....	119.99 kit
RHG-69KWS	1969 All LH & RH .....	119.99 kit
RHG-70KWS	1970-72 All LH & RH .....	119.99 kit
BPA-381	3/8" x 1" Bolt .....	0.65 ea.

Note: Bolts are not included.

**OE Style Pre-Assembled Hood Hinges**

These hood hinges are for the purist who won't settle for anything less than the best! Sold each or as a set of left and right hinges with the correct springs pre-installed. They feature an OE correct black phosphate coating just like the OEM.

RHG-142WSK	1965-67 All LH & RH ...	116.98 ea.
RHG-142WSL	1965-67 All LH .....	64.99 ea.
RHG-142WSR	1965-67 All RH .....	64.99 ea.
RHG-996K	1968 All LH & RH .....	199.99 kit
RHG-996L	1968 All LH .....	100.99 ea.
RHG-996R	1968 All RH .....	100.99 ea.
RHG-997K	1969 All LH & RH .....	199.99 kit
RHG-997L	1969 All LH .....	100.99 ea.
RHG-997R	1969 All RH .....	100.99 ea.
RHG-998K	1970-72 All LH & RH .....	209.99 kit
RHG-998L	1970-72 All LH .....	100.99 ea.
RHG-998R	1970-72 All RH .....	100.99 ea.
BPA-381	3/8" x 1" Bolt .....	0.65 ea.

Note: Bolts are not included.

**Hood Hinges**

High quality reproduction hood hinges.

RHG-64L	1964 All LH .....	64.99 ea.
RHG-64R	1964 All RH .....	64.99 ea.
RHG-142L	1965-67 All LH .....	44.99 ea.
RHG-142R	1965-67 All RH .....	44.99 ea.
RHG-667L	1965-67 All LH	
	Licensed GM Resto .....	120.99 ea.
RHG-667R	1965-67 All RH	
	Licensed GM Resto .....	120.99 ea.
RHG-68L	1968 All LH .....	49.99 ea.
RHG-68R	1968 All RH .....	49.99 ea.
RHG-69L	1969 All LH .....	49.99 ea.
RHG-69R	1969 All RH .....	49.99 ea.
RHG-70L	1970-72 All LH .....	49.99 ea.
RHG-70R	1970-72 All RH .....	49.99 ea.
RHG-73L	1973-77 All LH .....	72.99 ea.
RHG-73R	1973-77 All RH .....	72.99 ea.
RHS-642	1964-77 Hood Hinge Spring .....	15.99 ea.
RHG-818L	1981-88 Monte Carlo LH .....	79.95 ea.
RHG-818R	1981-88 Monte Carlo RH .....	79.95 ea.





**Eddie Motorsports Billet Hood Hinges**

These billet hood hinges are machined from 6061-T6 aluminum and will add an awesome custom touch to your engine compartment. They Bolt-in and require no cutting of your sheet metal. Complete with stainless steel nitrogen gas shocks and all stainless steel fasteners.

M = Machined  
P = Polished  
R = Red Fusioncoat  
B = Blue Fusioncoat

W = White Fusioncoat  
PR = Purple Fusioncoat  
BK = Gloss Black Fusioncoat  
BKA = Gloss Black Anodized

MB = Matte Black Fusioncoat  
MBA = Matte Black Anodized  
CL = Clear Coat  
CA = Clear Anodized



M

P

R, B, W, PR, BK,  
BKA, MB, MBA,  
CL, CA

MS149-56	1964 All	.....695.99 pr.....	725.99 pr.....	690.99 pr.
MS149-55	1965-67 All	.....650.99 pr.....	675.99 pr.....	690.99 pr.
MS149-58	1968 All	.....695.99 pr.....	745.99 pr.....	720.99 pr.
MS149-57	1969-72 All	.....695.99 pr.....	745.99 pr.....	720.99 pr.

\*One year warranty.

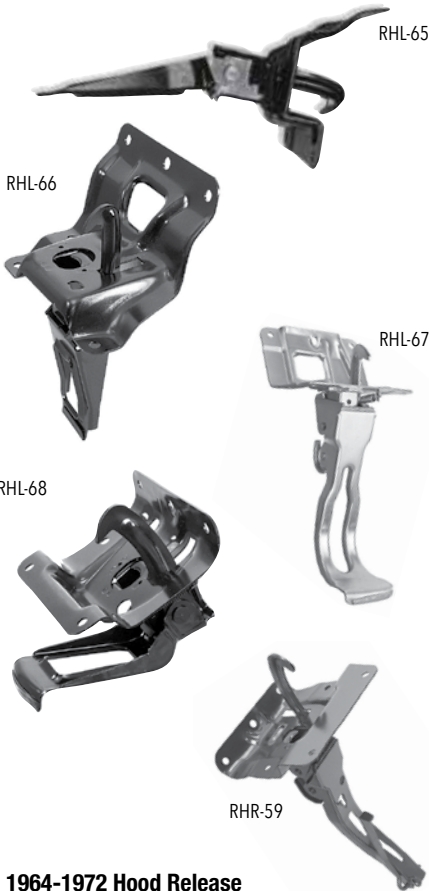

**1964-1972 Hood Release**

Reproduction hood release assemblies

RHL-65	1964-65 All	.....84.99 ea.
RHL-66	1966 All	.....94.99 ea.
RHL-67	1967 All	.....94.99 ea.
RHL-68	1968 All	.....99.99 ea.
RHL-69	1969 All	.....99.99 ea.
RHR-59	1970-72 All	.....89.99 ea.



**Billet Hood Hinges**

Give your engine bay a custom touch with these affordable billet hood hinges! These hood hinges come complete with heavy duty struts and hardware. Sold as a pair with hardware.

RHG-BH11	1965-67 All	.....459.99 kit
RHG-BH12	1968 All	.....449.99 kit

No Volume Discount.



**Hood Latch Support**

Correct support that runs vertically and attaches to the radiator support.

RVL-65A	1965 All	.....39.99 ea.
RVL-66A	1966 All	.....39.99 ea.
RVL-67A	1967 All	.....39.99 ea.
RVL-68	1968 All	.....42.99 ea.
RVL-69	1969 All	.....39.99 ea.
RVL-70A	1970 All	.....39.99 ea.
RVL-1488G	1971-72 All	.....39.99 ea.



**Hood Release Handle**

Reproduction of this often missing or broken pull handle.

RHR-70X	1970-72 All	.....29.99 ea.
---------	-------------	----------------



**Eddie Motorsports Billet Hood Latch Assembly**

CNC machined from a solid chunk of 6061-T6 aluminum and stainless steel. This is a direct replacement for your cheap stock stamped steel hood latch. The EMS billet hood latch kit comes complete with a billet aluminum base plate and billet stainless steel pilot bolt and retaining cup. Stainless steel fasteners and billet aluminum finishing washers are also included.

M = Machined Fusioncoat  
P = Polished  
R = Red  
B = Blue Fusioncoat  
W = White Fusioncoat

PR = Purple Fusioncoat  
BK = Gloss Black Fusioncoat  
BKA = Gloss Black Anodized  
MB = Matte Black Fusioncoat  
MBA = Matte Black Anodized



CL = Clear Coat  
CA = Clear Anodized

M

P

R, B, W, PR,  
BK, BKA, MB,  
MBA, CL, CA

MS276-20	1965	.....183.99 ea.....	213.99 ea.....	228.99 ea.
MS276-21	1966	.....138.99 ea.....	160.99 ea.....	172.99 ea.
MS276-15	1967	.....183.99 ea.....	213.99 ea.....	172.99 ea.
MS276-10	1968-69	.....169.99 ea.....	189.99 ea.....	167.99 ea.
MS276-12	1970-72	.....179.99 ea.....	189.99 ea.....	172.99 ea.



### Hood Catch

Correct catch which mounts on underside of hood.

RHR-64	1964 All .....	39.95 ea.
RHR-66	1966 All .....	39.99 ea.
RHR-L70	1970-72 All .....	44.99 ea.
RHR-70	1970-72 All OE Style .....	60.99 ea.



### Hood Pin Kit OE Style

This is a set of OE style reproduction hood pins which were originally found on Super Sport models. Each kit includes (2) pins, (2) plates, (2) gaskets, (2) cables and all necessary hardware.

HPK-100	1970-72 SS .....	34.99 kit
---------	------------------	-----------

*No Volume Discount.*



### Hood Pin Kit - Hair Pin Style

Universal chrome hood pin kit for use on any vehicle.

GCS-S4051	All .....	12.99 kit
-----------	-----------	-----------



HPK-BC



HPK-BB

### Billet Aluminum Hood Pin Kits Peel N Stick

These hood pin kits are a great way to add that protouring/racing look without drilling or cutting your hood. The pin mounts are either chrome plated or black aluminum with chrome pins and feature rubber coated cables. They attach with high quality double sided 3M adhesive tape.

HPK-BC	Chrome All .....	29.99 kit
HPK-BB	Black All .....	29.99 kit



RDP-66A

### Dash Top Panel

Complete dash top panel which is a great replacement for this commonly rotted out area.

RDP-66A	1966 .....	299.99 ea.
RDP-67A	1967 .....	299.99 ea.

*Ships Oversize.*



RVP-4031

### Splash Panel/Filler Panel

This panel fills the gap behind the bumper and ties the front end together.

RVP-65F	1965 3pc.....	89.99 kit
RVP-4031	1966 All .....	74.99 ea.
RVP-2150	1967 All .....	74.99 ea.
RVP-68	1968 All .....	74.99 ea.
RVP-92	1969 All .....	74.99 ea.
RVP-A70	1970 All .....	79.99 ea.

*Ships Oversize. Not eligible for free shipping.*



RHP-689A

### Header Panel

Reproduction of this often damaged front edge header molding.

RHP-689A	1968-69 All .....	149.99 ea.
RHP-82	1982-87 Malibu/El Camino .....	199.99 ea.

*Ships Oversize. Not eligible for free shipping.*



RTB-70

### Front Fender Tie Brace

Correct steel panel that ties the top of the fenders together.

RTB-65	1965 Upper Grille Plate All .....	84.99 ea.
RTB-1487ZB	1967 Upper Grille Plate All .....	79.99 ea.
RTB-70	1970-72 All .....	79.99 ea.

*Ships Oversize. Not eligible for free shipping.*



### 1964-67 Cowl Panel

RCP-64

Louvered piece of sheet metal installs directly below the windshield behind the hood.

RCP-64	1964-67 All .....	199.99 ea.
--------	-------------------	------------



RWP-1461G



RFP-1461B

### Firewalls

Brand new complete firewalls.

RFP-66A	1964-67 Firewall w/o AC* .....	369.99 ea.
RFP-1461IA	1964-67 Firewall Heater Delete .....	349.99 ea.
RFP-1461A	1968-72 Firewall w/ AC .....	349.99 ea.
RFP-1461H	1968-72 Firewall Convertible w/ AC.....	349.99 ea.
RFP-1461B	1968-72 Firewall w/o AC .....	349.99 ea.
RFP-1461C	1968-72 Firewall Heater Delete .....	349.99 ea.
RWP-1461G	1968-69 Firewall Wiper Plate.....	32.95 ea.

*Ships Truck Freight to a commercial address. Not eligible for free shipping. No Volume Discount.*

*\* Correct for 1966-67. Can be modified to fit 1964-65.*



RFP-1461-VL

RFP-1461-VR



RFP-1461F

### Firewall Brackets

Reproduction firewall brackets (where your body bushings attach).

RFP-1461F	1968-72 Coupe.....	139.99 pr.
RFP-1461-VL	1968-72 Convertible LH .....	79.99 ea.
RFP-1461-VR	1968-72 Convertible RH .....	79.99 ea.



RDP-1424A

### Dash Repair/Windshield Channel

This new repair panel replaces the often rusted out area where the base of the windshield and dash come together. This panel runs the full length of the dash.

RDP-430	1964-67 All .....	56.99 ea.
RDP-1424A	1968-72 w/ Pre-Welded Brackets..	84.99 ea.
RDP-3468	1968-72 w/ Brackets (Not Attached) .....	109.99 ea.

BP-1417Z 1970-72 Bridge End Plates..... 59.99 pr.

*\*May require some modification for 1968-69. Ships Oversize. Not eligible for free shipping.*

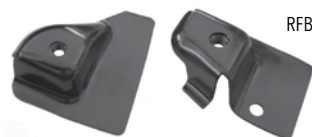

RFB-3468

### Fender to Firewall Brackets

These brackets provide the mounting points for the fenders.

RFB-3468	1968-72 All .....	59.99 pr.
----------	-------------------	-----------





RDS-66AR



### Door Skins

Door skins are perfect for repairing doors that have not rusted through the inner shell. These stamped steel panels replace your old rusty skin.

RDS-65AL	1964-65 Chevelle/El Camino LH.....	149.99 ea.
RDS-65AR	1964-65 Chevelle/El Camino RH.....	149.99 ea.
RDS-66AL	1966-67 Chevelle/El Camino LH.....	149.99 ea.
RDS-66AR	1966-67 Chevelle/El Camino RH.....	149.99 ea.
RDS-68AL	1968 Chevelle LH.....	139.99 ea.
RDS-68AR	1968 Chevelle RH.....	139.99 ea.
RDS-69AL	1969 Chevelle LH.....	139.99 ea.
RDS-69AR	1969 Chevelle RH.....	139.99 ea.
RDS-70AL	1970-72 Chevelle LH.....	159.99 ea.
RDS-70AR	1970-72 Chevelle RH.....	159.99 ea.
RDS-68EL	1968-72 El Camino LH.....	199.99 ea.
RDS-68ER	1968-72 El Camino RH.....	199.99 ea.
RDS-78L	1978-85 Malibu/El Camino LH.....	249.99 ea.
RDS-78R	1978-85 Malibu/El Camino RH.....	249.99 ea.
RDS-81GNL	1980-87 Regal Cutlass LH.....	299.99 ea.
RDS-81GNR	1980-87 Regal Cutlass RH.....	299.99 ea.
RDS-81MCL	1981-85 Monte Carlo LH.....	224.99 ea.
RDS-81MCR	1981-85 Monte Carlo RH.....	224.99 ea.
RDS-86EL	1986-87 El Camino LH.....	242.99 ea.
RDS-86ER	1986-87 El Camino RH.....	242.99 ea.
RDS-86MCL	1986-88 Monte Carlo LH.....	329.99 ea.
RDS-86MCR	1986-88 Monte Carlo RH.....	329.99 ea.

No Volume Discount. Ships Oversize 2. Not eligible for free shipping.



RSH-66L



### Door Shells

These full door shells feature the outer door skin welded to the shell as original. Perfect when your entire door has rusted through.

RSH-64L	1964-65 Chevelle LH.....	399.99 ea.
RSH-64R	1964-65 Chevelle RH.....	399.99 ea.
RSH-66L	1966-67 Chevelle/El Camino LH.....	379.99 ea.
RSH-66R	1966-67 Chevelle/El Camino RH.....	379.99 ea.
RSH-68AL	1968 Chevelle LH.....	329.99 ea.
RSH-68AR	1968 Chevelle RH.....	329.99 ea.
RSH-69AL	1969 Chevelle LH.....	329.99 ea.
RSH-69AR	1969 Chevelle RH.....	329.99 ea.
RSH-70AL	1970-72 Chevelle LH.....	379.99 ea.
RSH-70AR	1970-72 Chevelle RH.....	379.99 ea.
RSH-78L	1978-85 Malibu/El Camino LH.....	689.99 ea.
RSH-78R	1978-85 Malibu/El Camino RH.....	689.99 ea.
RSH-81GNL	1978-85 Regal Cutlass LH.....	626.99 ea.
RSH-81GNR	1978-85 Regal Cutlass RH.....	626.99 ea.
RSH-81MCL	1981-85 Monte Carlo LH.....	499.95 ea.
RSH-81MCR	1981-85 Monte Carlo RH.....	499.95 ea.
RSH-86EL	1986-87 El Camino LH.....	689.99 ea.
RSH-86ER	1986-87 El Camino RH.....	689.99 ea.
RSH-86MCL	1986-88 Monte Carlo LH.....	599.99 ea.
RSH-86MCR	1986-88 Monte Carlo RH.....	640.99 ea.

No Volume Discount. Ships Truck Freight to a commercial address. Not eligible for free shipping.



RHS-9

BAV-2623



BAV-2622



### Door Hinge Hardware

Correct OEM bolts and heavy spring.

BAV-2622	1964-67 Phillips.....	1.99 ea.
BAV-2623	1964-72 Hex.....	1.99 ea.
RHS-9	1964-72 Spring.....	8.99 ea.
BAV-2622K	Phillips (6 pc.) Hex (18 pc.).....	32.95 kit
BAV-2623K	Hex (24 pc.).....	29.61 kit



BPX-1225

### Door Hinge Pin Kits

Correct hinge pins and brass bushings for repairing all 4 of your door hinges.

BPX-1225	1966-67 (12 pc.).....	16.99 ea.
BPX-2225	1968-72 (12 pc.).....	15.99 ea.

\*May require slight modification to hinges.

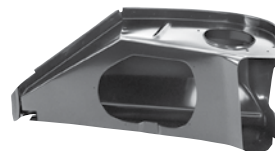

RCS-68R

### Cowl Shoulder Assembly

Complete replacement for this often rotted out area.

RCS-66L	1966-67 LH.....	179.99 ea.
RCS-66R	1966-67 RH.....	179.99 ea.
RCS-68L	1968-72 LH.....	169.99 ea.
RCS-68R	1968-72 RH.....	169.99 ea.



RCP-66AFL

### 1966-67 Cowl Side Outer - Front Panel

RCP-66L	1966-67 LH.....	89.99 ea.
RCP-66R	1966-67 RH.....	89.99 ea.



RCP-66L

### 1966-67 Cowl Front Panel

RCP-66AFL	1966-67 LH.....	89.99 ea.
RCP-66AFR	1966-67 RH.....	89.99 ea.



RCP-7L

### 1968-72 Cowl Side Panel

RCP-7L	1968-72 LH.....	69.99 ea.
RCP-7R	1968-72 RH.....	69.99 ea.





### Door Hinge Pillar Assembly

Complete door hinge pillar assembly which provides the mounting points for the door hinges.

RDH-66AL	1966-67 LH	.....269.99 ea.
RDH-66AR	1966-67 RH	.....269.99 ea.
BP-1417Z	1970-72 Windshield Bridge Plates	..... 59.99 pr.
RDH-1417H	1970-72 LH w/ Kick Panel	.....399.99 ea.
RDH-1417G	1970-72 RH w/ Kick Panel	.....399.99 ea.

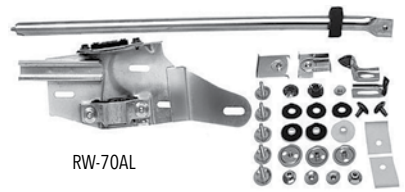

### Window Track And Hardware Kits

This convenient door window track & hardware kit is great for when you are changing out your door glass.

RW-70AL	1970-72 Chevelle LH	..... 189.99 set
RW-70AR	1970-72 Chevelle RH	..... 189.99 set

*Ships Oversize. No Volume Discount.*



### Hinge Detent Rollers

Correct machined detent rollers for lower hinges.

RDR-67	1965-67 All	..... 16.95 kit
RDR-72K	1968-72 All	..... 27.99 kit



### Door Hinges

Reproduction door hinges.

<b>Upper</b>		
RDH-64U	1964-65 LH/RH	.....64.99 ea.
RDH-529U	1966-67 LH/RH	.....55.99 ea.
RDH-170U	1968-72 LH/RH	.....59.99 ea.
RDH-737UL	1973-77 LH	.....94.99 ea.
RDH-737UR	1973-77 RH	.....94.99 ea.
RDH-78UL	1978-88 All LH	.....62.99 ea.
RDH-78UR	1978-88 All RH	.....69.95 ea.
<b>Lower</b>		
RDH-2590	1964-65 LH	.....64.99 ea.
RDH-2595	1964-65 RH	.....64.99 ea.
RDH-346LL	1966-67 LH	.....55.99 ea.
RDH-346LR	1966-67 RH	.....55.99 ea.
RDH-088LL	1968-72 LH	.....62.99 ea.
RDH-088LR	1968-72 RH	.....62.99 ea.
RDH-737L	1973-77 All LH/RH	.....64.99 ea.
RDH-78L	1978-88 All LH/RH	.....59.95 ea.

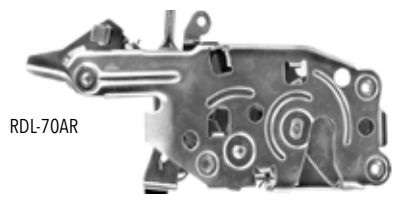

RDL-70AR



RDL-SCREW

### Door Latch Assemblies

Reproduction door latch assemblies.

RDL-1543L	1964-65 LH	..... 79.99 ea.
RDL-1542R	1964-65 RH	..... 79.99 ea.
RDL-67AL	1966-67 LH	..... 79.99 ea.
RDL-67AR	1966-67 RH	..... 79.99 ea.
RDL-67AK	1966-67 Kit (Both Sides)	..... 143.98 kit
RDL-68AL	1968 LH	..... 79.99 ea.
RDL-68AR	1968 RH	..... 79.99 ea.
RDL-68AK	1968 Kit (Both Sides)	..... 143.98 kit
RDL-69AL	1969 LH	..... 79.99 ea.
RDL-69AR	1969 RH	..... 79.99 ea.
RDL-69AK	1969 Kit (Both Sides)	..... 143.98 kit
RDL-70AL	1970-72 LH	..... 79.99 ea.
RDL-70AR	1970-72 RH	..... 79.99 ea.
RDL-70AK	1970-72 Kit (Both Sides)	..... 143.98 kit
RDL-828L	1980-88 All LH	..... 72.99 ea.
RDL-828R	1980-88 All RH	..... 72.99 ea.
RDL-SCREW	1964-77 Screw 3 pc*	..... 6.95 set

\*Part Notes: This kit does one door latch. One kit required per door.



BPX-1275

BPX-1299

### Door Strikers w/ Washer

BPX-1275	GM Replacement	..... 12.99 ea.
BPX-1299	Reproduction*	..... 13.99 ea.
BPX-1299K	Reproduction Pair	..... 25.18 kit

\*Correct Allen Head Zinc Plated.

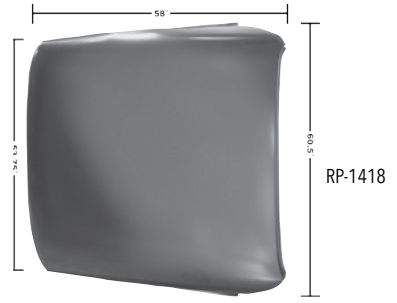

RP-1418

### Roof Panel

Full replacement roof panel for your Chevelle or El Camino. Don't forget to add the braces!

RP-66A	1966-67 Chevelle	..... 479.99 ea.
RP-1418	1968-72 Chevelle	..... 429.99 ea.
RP-1428E	1968-72 El Camino	..... 339.95 ea.
RT-7888	1978-88 Monte T-Top Trim	..... 289.99 set

*Ships Truck Freight to a commercial address. Not eligible for free shipping. No Volume Discount.*



RPB-1418A

### Roof Panel Braces

Correct roof panel braces for replacing damaged originals.

RPB-1418A	1970-72 Chevelle	..... 199.95 kit
<i>(Includes all braces &amp; wire bows for complete replacement.)</i>		
RPB-1428EA	1968-72 El Camino	..... 249.99 kit
<i>(Includes front, middle and rear braces.)</i>		



RIB-1418P

### Roof Panel Inner Brace Kit

These braces provide the proper mounting points for the bows.

RIB-1418U	1964-65 Chevelle	..... 219.99 kit
RIB-1418P	1968-72 Chevelle	..... 279.99 kit
RPB-1418T	1968-72 El Camino	..... 229.95 kit

*(Includes front corners, rear corners and side roof braces.)*



KPR-1418R

### Drip Rails & Supports

New steel drip rails which your moldings attach to and vertical drip rail supports which attach to the A-pillars.

KPR-667	1966-67 Chevelle Roof Drip Rails	..... 199.99 pr.
KPR-1418N	1968-72 Chevelle Drip Rail Pillar Supports	..... 69.99 pr.
KPR-1418R	1968-69 Chevelle Roof Drip Rails	..... 119.95 pr.
KPR-1418S	1970-72 Chevelle Roof Drip Rails	..... 129.99 kit
KPR-M1429B	1964-67 El Camino A-Pillar RH	..... 74.99 set
KPR-M1429C	1964-67 El Camino A-Pillar LH	..... 74.99 set

*Ships Oversize. Not eligible for free shipping.*

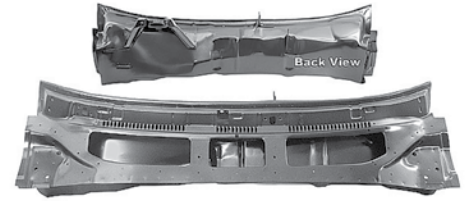

RCP-1419WT

### 1968-72 Cowl Panel

This lower cowl panel offers a complete replacement for this often rotted out area. This complete cowl panel includes the entire wiper valley so you can be sure to eliminate any rust or rot all in one shot.

RCP-1419AWT	1968-69	..... 399.99 ea.
RCP-1419WT	1970-72	..... 399.99 ea.

*Ships Oversize 2. Not eligible for free shipping.*



RLC-66AU



RLC-66AL

**1966-67 Lower Cowl**

Great replacement for this commonly rotted out lower cowl area.

- RLC-66AL 1966-67 Lower.....219.99 ea.
  - RLC-66AU 1966-67 Upper.....159.99 ea.
- Ships Oversize.*

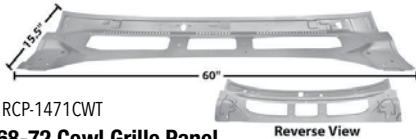

RCP-1471CWT

**1968-72 Cowl Grille Panel**

Reproduction perfect for replacing this commonly rotted area. Features Weld-Thru primer.

- RCP-69-TOP 1968-69.....199.95 ea.
  - RCP-1471CWT 1970-72.....229.99 ea.
- Ships Oversize 2.*



RDP-1455

**Steel Dash Panel**

This is a reproduction of the steel dash panel for Chevelle and El Camino.

- RDP-1455 1968 All .....399.99 ea.
- Oversize 2. No Volume Discount. Not eligible for free shipping.*



IXM-68L



IXM-68R

**Windshield Pillar Moldings**

- IXM-68L 1968-72 Coupe Steel LH.....134.99 ea.
- IXM-68R 1968-72 Coupe Steel RH.....134.99 ea.
- IXM-68K 1968-72 Coupe Steel Pair.....242.98 kit



RWP-66AIL

**Windshield Pillar**

Inner windshield pillar replacement used to replace this common rust area.

- RWP-66AIL 1966-67 Inner LH .....109.99 ea.
- RWP-66AIR 1966-67 Inner RH .....109.99 ea.
- RWP-682AL 1968-72 Outer LH.....99.99 ea.
- RWP-682AR 1968-72 Outer RH .....99.99 ea.



RPW-1461J

**Windshield Pillar Wrap**

This piece of sheet metal is used to wrap the outside of the windshield pillar and measures approximately 26 inches long by 7 inches wide at the base.

- RPW-1461K 1966-67 LH.....109.99 ea.
- RPW-1461J 1966-67 RH .....109.99 ea.



RWB-1418AA

**Windshield Frame Bridge**

This convertible windshield frame bridge sits above the windshield and provides the mounting points for the visors, rear view mirror and top molding.

- RWB-1418AA 1970-72 Convertible.....199.99 ea.



RWA-64L

**Wheel Arch Patches**

High quality wheel arch patch. Perfect for replacing the commonly rotted out area around the wheel opening.

**Chevelle**

- RWA-64L 1964-65 All LH.....59.99 ea.
  - RWA-64R 1964-65 All RH .....59.99 ea.
  - RWA-66L 1966-67 All LH.....59.99 ea.
  - RWA-66R 1966-67 All RH .....59.99 ea.
  - RWA-68L 1968-69 All LH.....59.99 ea.
  - RWA-68R 1968-69 All RH .....59.99 ea.
  - RWA-70L 1970-72 All LH.....69.99 ea.
  - RWA-70R 1970-72 All RH .....69.99 ea.
- G-Body**
- RWA-818L 1981-88 Olds Cutlass 442 LH.....89.99 ea.
  - RWA-818R 1981-88 Olds Cutlass 442 RH .....89.99 ea.
  - RWA-817L 1981-88 Buick Regal GN LH .....89.99 ea.
  - RWA-817R 1981-88 Buick Regal GN RH .....89.99 ea.

**Quarter Plug**

Correct plug and orange gasket used to plug the rear quarter panel drain hole. These plugs are made of steel.



- BPP-70Q 1970-72 .....21.99 pr.



R-1472S

**Complete Chevelle Wheelhouse Assemblies**

These complete wheelhouse assemblies feature the inners and others already welded together!

- R-1472S 1970-72 Coupe LH.....279.99 ea.
  - R-1472R 1970-72 Coupe RH.....279.99 ea.
  - R-1472Z 1970-72 Convertible LH .....289.95 ea.
  - R-1472Y 1970-72 Convertible RH .....289.95 ea.
  - RWH-29-IMT 1970-72 Coupe Extra Wide\*.....659.99 pr.
  - RWH-818AL 1981-88 Monte Carlo LH .....299.99 ea.
  - RWH-818AR 1981-88 Monte Carlo RH .....299.99 ea.
- Ships Oversize 2. Not eligible for free shipping. No Volume Discount. \*10.5" wide at the widest point and 9" wide in the center.*



R-1472N

**Complete El Camino Wheelhouse Assemblies**

These complete wheelhouse assemblies feature the inners and others already welded together!

- R-1472N 1968-72 LH .....289.99 ea.
  - R-1472M 1968-72 RH .....289.99 ea.
- Ships Oversize 2. Not eligible for free shipping. No Volume Discount.*



**Inner Wheelhouse/Trunk Patch**

This die stamped panel replaces the most commonly rusted area in the trunk. It extends from the inner wheel well joint approximately 8" to where the inner wheelhouse meets the trunk.

- RG-23L 1968-72 LH.....69.99 ea.
  - RG-23R 1968-72 RH .....69.99 ea.
  - RG23-KIT 1968-72 Pair.....125.98 kit
- Ships Oversize. Not eligible for free shipping.*



RWH-191L

**Chevelle Inner Rear Wheelhouses**

New inner rear section of wheelhouse which installs between the trunk area and seams to the outer wheelhouse. It is always a good idea to replace your wheelhouses when you replace your quarter panels!

- RWH-191L 1964-67 LH.....99.99 ea.
  - RWH-191R 1964-67 RH .....99.99 ea.
  - RWH-191K 1964-67 All Pair .....179.98 kit
  - RWH-291L 1968-72 Coupe LH.....84.99 ea.
  - RWH-291R 1968-72 Coupe RH .....84.99 ea.
  - RWH-301L 1970-72 Convertible LH .....159.99 ea.
  - RWH-301R 1970-72 Convertible RH .....159.99 ea.
- Ships Oversize 2. Not eligible for free shipping. No Volume Discount.*



RWH-65OTL

**Outer Rear Wheelhouses**

Correct steel wheelhouses which attach to the inside of the quarter panel. It is always a good idea to replace your wheelhouses when you replace your quarter panels! Buy the pair and save 10%. Just ask your sales rep!

**Chevelle**

- RWH-65OTL 1964-65 LH.....89.99 ea.
- RWH-65OTR 1964-65 RH .....89.99 ea.
- RWH-66OTL 1966-67 LH.....84.99 ea.
- RWH-66OTR 1966-67 RH .....84.99 ea.
- RWH-68OTL 1968-69 LH.....69.99 ea.
- RWH-68OTR 1968-69 RH .....69.99 ea.
- RWH-72OTL 1970-72 Coupe LH .....69.99 ea.
- RWH-72OTR 1970-72 Coupe RH .....69.99 ea.
- RWH-72OTK 1970-72 Coupe Pair.....125.98 kit
- RWH-72COTL 1970-72 Convertible LH .....116.99 ea.
- RWH-72COTR 1970-72 Convertible RH .....109.95 ea.

**El Camino & G-Body**

- RWH-68OTL 1968-72 El Camino LH.....69.99 ea.
  - RWH-68OTR 1968-72 El Camino RH .....69.99 ea.
  - RWH-780L 1978-87 El Camino LH .....134.99 ea.
  - RWH-780R 1978-87 El Camino RH .....134.99 ea.
  - RWH-818MCO L 1981-88 Monte Carlo LH .....139.99 ea.
  - RWH-818MCO R 1981-88 Monte Carlo RH .....139.99 ea.
- 1968-72 El Camino are the same as 1968-69 Chevelle. Ships Oversize. Not eligible for free shipping. No Volume Discount.*

### Quarter Panels

If your original quarter panels are dented or rotted right through to the ground, these reproduction quarter panels are the perfect replacement! There is no need to spend a fortune on an NOS quarter because these reproductions feature a complete door jamb area, complete trunk jamb area and full roof sail panel. These are extremely high quality pieces, so you can be sure to get the best fit possible.

No Volume Discount. All quarter panels ship Truck Freight to a commercial address. Not eligible for free shipping.



RFQ-645L

RFQ-645L	1964-65 Chevelle Coupe LH.....	419.99 ea.
RFQ-645R	1964-65 Chevelle Coupe RH.....	419.99 ea.
RFQ-645K	1964-65 Chevelle Coupe (Buy The Pair And Save).....	839.98 kit

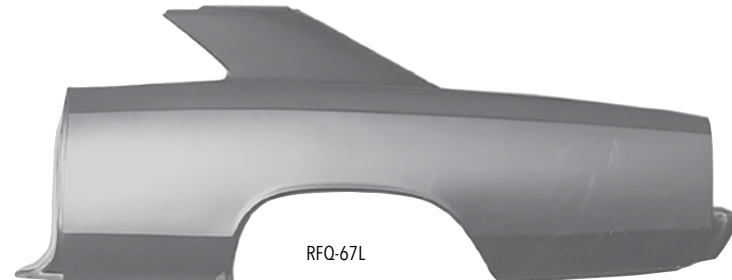

RFQ-67L

RFQ-67L	1966-67 Chevelle Coupe LH.....	429.99 ea.
RFQ-67R	1966-67 Chevelle Coupe RH.....	429.99 ea.
RFQ-67K	1966-67 Chevelle Coupe (Buy The Pair And Save).....	859.98 kit



RFQ-68L

RFQ-68L	1968 Chevelle Coupe LH.....	399.99 ea.
RFQ-68R	1968 Chevelle Coupe RH.....	399.99 ea.
RFQ-68K	1968 Chevelle Coupe (Buy The Pair And Save).....	719.98 kit



RFQ-69L

RFQ-69L	1969 Chevelle Coupe LH.....	399.99 ea.
RFQ-69R	1969 Chevelle Coupe RH.....	399.99 ea.
RFQ-69K	1969 Chevelle Coupe (Buy The Pair And Save).....	719.98 kit



RFQ-405L

RFQ-405L	1970-72 Chevelle Coupe LH.....	399.99 ea.
RFQ-405R	1970-72 Chevelle Coupe RH.....	399.99 ea.
RFQ-405K	1970-72 Chevelle Coupe (Buy The Pair And Save).....	719.98 kit
RFQ-404L	1970-72 Chevelle Convertible LH.....	499.99 ea.
RFQ-404R	1970-72 Chevelle Convertible RH.....	499.99 ea.
RFQ-404K	1970-72 Chevelle Convertible (Buy The Pair And Save).....	899.98 kit



RFQ-1475HN



RFQ-E7R

RFQ-1475HN	1964-65 El Camino LH.....	499.99 ea.
RFQ-1475HM	1964-65 El Camino RH.....	499.99 ea.
RFQ-E7L	1968-72 El Camino LH.....	469.99 ea.
RFQ-E7R	1968-72 El Camino RH.....	469.99 ea.
RFQ-E78L	1978-87 El Camino LH.....	619.99 ea.
RFQ-E78R	1978-87 El Camino RH.....	619.99 ea.
RFQ-818L	1981-88 Monte Carlo LH OE Quality.....	399.99 ea.
RFQ-818R	1981-88 Monte Carlo RH OE Quality.....	399.99 ea.



RQS-64L

### Quarter Panel Skins

These quarter panel repair skins offer a quick and inexpensive way to repair your original factory quarter panels without fully cutting them out. They extend from the upper belt line down. Fits all coupes and convertibles.

RQS-64L	1964-65 Chevelle LH 85" x 29".....	279.99 ea.
RQS-64R	1964-65 Chevelle RH 85" x 29".....	279.99 ea.
RQS-66L	1966-67 Chevelle LH 88" x 30".....	279.99 ea.
RQS-66R	1966-67 Chevelle RH 88" x 30".....	279.99 ea.
RQS-68L	1968 Chevelle LH 77" x 27".....	279.99 ea.
RQS-68R	1968 Chevelle RH 77" x 27".....	279.99 ea.
RQS-69L	1969 Chevelle LH 77" x 27".....	279.99 ea.
RQS-69R	1969 Chevelle RH 77" x 27".....	279.99 ea.
RQS-70L	1970-72 Chevelle LH 77" x 27".....	279.99 ea.
RQS-70R	1970-72 Chevelle RH 77" x 27".....	279.99 ea.
RQS-74L	1973-77 Chevelle LH 77" x 27".....	199.95 ea.
RQS-74R	1973-77 Chevelle RH 77" x 27".....	199.95 ea.
RQS-E73L	1973-77 El Camino LH.....	299.99 ea.
RQS-E73R	1973-77 El Camino RH.....	299.99 ea.
RQS-E6L	1968-72 El Camino LH.....	299.99 ea.
RQS-E6R	1968-72 El Camino RH.....	299.99 ea.
RQS-E73L	1973-77 El Camino LH 78" x 30".....	299.99 ea.
RQS-E73R	1973-77 El Camino RH 78" x 30".....	299.99 ea.
RQS-78E80L	1978-87 El Camino LH.....	299.99 ea.
RQS-78E80R	1978-87 El Camino RH.....	299.99 ea.
RQS-810LDSL	1981-88 Cutlass 442 LH.....	199.99 ea.
RQS-810LDSR	1981-88 Cutlass 442 RH.....	199.99 ea.



RQR-645L



RQR-66L



RQR-68L



RQR-70L

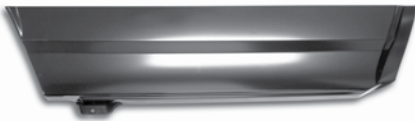



RQR-8L

**Quarter Panel Patches**

High quality die stamped lower quarter panel repair panels are perfect when your entire quarter panel isn't rotted out!

<b>Chevelle</b>	
RQR-645L	1964-65 LH..... 54.99 ea.
RQR-645R	1964-65 RH..... 54.99 ea.
RQR-66L	1966-67 LH..... 59.99 ea.
RQR-66R	1966-67 RH..... 59.99 ea.
RQR-68L	1968 LH..... 54.99 ea.
RQR-68R	1968 RH..... 54.99 ea.
RQR-69AL	1969 LH..... 59.99 ea.
RQR-69AR	1969 RH..... 59.99 ea.
RQR-70L	1970-72 LH..... 59.99 ea.
RQR-70R	1970-72 RH..... 59.99 ea.
RQR-81OLDSRL	1981-88 Cutlass 442 Rear LH ..... 69.99 ea.
RQR-81OLDSRR	1981-88 Cutlass 442 Rear RH..... 69.99 ea.
RQR-8187L	1981-87 Regal GN Rear LH ..... 99.99 ea.
RQR-8187R	1981-87 Regal GN Rear RH ..... 99.99 ea.

<b>El Camino</b>	
RQR-8L	1968-72 LH..... 59.99 ea.
RQR-8R	1968-72 RH..... 59.99 ea.
RQR-78EFL	1978-87 El Camino Front LH..... 89.99 ea.
RQR-78EFR	1978-87 El Camino Front RH..... 89.99 ea.
RQR-78L	1978-87 El Camino Rear LH..... 79.99 ea.
RQR-78R	1978-87 El Camino Rear RH..... 79.99 ea.



**1964-67 Full Floor Pan w/ Braces & Rear Seat Pan**

This complete floor pan features all braces as well as rear seat panel already installed! This will save you hours over welding in individual pieces of floor pan!

RFP-647XP	1964-67 Chevelle.....	539.99 ea.
RFP-1462W	1964-67 Full w/o Braces .....	459.99 ea.

*No Volume Discount. Ships Truck Freight to a commercial address. Not eligible for free shipping.*

**1968-72 Full Floor Pan w/ Braces & Rear Seat Pan**

This complete floor pan features all braces as well as rear seat panel already installed! This will save you hours over welding in individual pieces of floor pan!

RFP-1462X	1968-72 Chevelle .....	669.99 ea.
-----------	------------------------	------------

*No Volume Discount. Ships Truck Freight to a commercial address. Not eligible for free shipping.*





**1968-72 Full Floor Pan w/ Braces, Rear Seat Pan & Rockers**

This is the ultimate monster floor pan featuring all braces, rear seat panel and rocker panels completely assembled saving you a ton of time and money over individually piecing together a floor!

RFP-1462Y	1968-72 Chevelle .....	939.99 ea.
-----------	------------------------	------------

*No Volume Discount. Ships Truck Freight to a commercial address. Not eligible for free shipping.*





**1968-72 Full Floor Pan**

This is an excellent basic replacement full floor minus the braces, rear seat pan and rocker panels.

RFP-1462	1968-72 Chevelle .....	319.99 ea.
----------	------------------------	------------

*No Volume Discount. Ships Truck Freight to a commercial address. Not eligible for free shipping.*



**1964-67 Full Floor Pan w/ Braces Inner Rockers & Rear Seat Pan**

This complete floor pan features all the braces, the inner rockers and the rear seat pan. Also included are seatbelt provisions, rear seat hold and wiring hold downs. This will save you hours of labor over welding in individual floor pan patches!

RFP-647XP-AMD 1964-67 Chevelle.....599.99 ea.  
No Volume Discount. Ships truck freight to a commercial address. Not eligible for free shipping.



**1968-72 Full Floor Pan w/ Braces Inner Rockers & Rear Seat Pan**

This complete floor pan features all the braces, the inner rockers and the rear seat pan. Also included are seatbelt provisions, rear seat hold and wiring hold downs. This will save you hours of labor over welding in individual floor pan patches!

RFP-1462X-AMD 1968-72 Chevelle .....699.99 ea.  
No Volume Discount. Ships truck freight to a commercial address. Not eligible for free shipping.

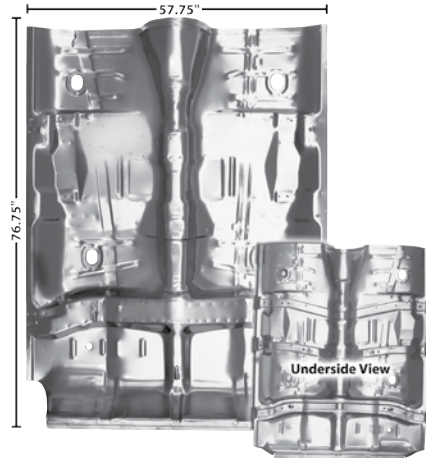

**1968-69 El Camino Full Floor Pan w/ Braces**

This complete full floor pan includes the front, center and rear floor pan braces and will save you a ton of time and money over welding together individual pieces and braces!

RFP-1462ZB 1968-69 El Camino .....799.95 ea.  
No Volume Discount. Ships Truck Freight to a commercial address. Not eligible for free shipping.

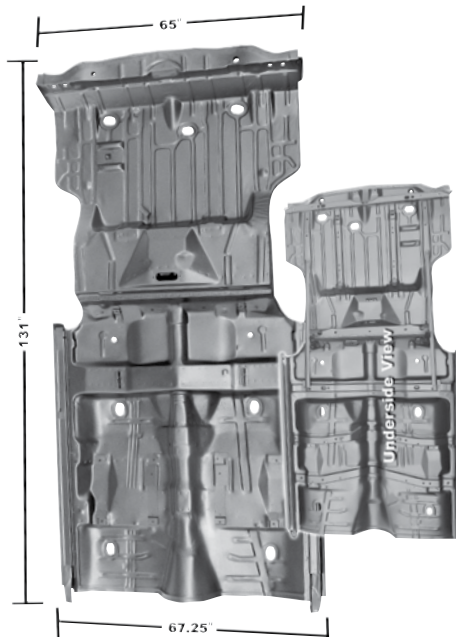

**Complete Full Floor Pan with Complete Trunk Pan**

This complete monster floor pan with trunk floor is the ultimate solution for rotted out floors and will replace the entire old underside of your Chevelle in one shot. This huge floor pan includes the floor pan braces, rockers, rear seat pan and trunk pan already assembled, which will save you hours of labor over welding together individual pieces!

RFP-1462YB 1968 Chevelle.....2599.99 ea.  
No Volume Discount. Ships Truck Freight to a commercial address. Not eligible for free shipping.



**1978-88 El Camino, Malibu Full Floor**

The days of welding together pieces of floors are finally over. This new El Camino, Caballero and Malibu full floor pan is a direct replacement for your old, rotted floor and will save you tons of time and money because you won't have to weld-in and finish individual pieces.

RFP-7888 1978-88 All \* .....469.99 ea.

\* Direct replacement for 1978-87 El Camino. May require some cutting on the rear for Malibu, Monte Carlo, Regal, Cutlass and Grand Prix. This is the floor pan only. It does not include any braces or brackets.

Ships Truck Freight To A Commercial Address. Not eligible for free shipping.



**Half Side Floor Pans**

Full half side floor panels which seam in the middle. All 1964-67 floor panels feature wiring harness retainers as well as gas pedal mounting plate as original.

RP-64FL 1964-67 Chevelle LH.....119.99 ea.  
RP-64FR 1964-67 Chevelle RH.....119.99 ea.  
RP-68FL 1968-72 Chevelle LH.....119.99 ea.  
RP-68FR 1968-72 Chevelle RH.....119.99 ea.  
RP-64FL 1964-72 El Camino LH\*.....119.99 ea.  
RP-64FR 1964-72 El Camino RH\*.....119.99 ea.  
RFP-78L 1978-88 El Camino\*\* LH.....199.99 ea.  
RFP-78R 1978-88 El Camino\*\* RH .....199.99 ea.

\*Will require modification to fit El Camino.  
\*\* Can be cut to fit Malibu and Monte Carlo  
Ships Truck Freight to a commercial address. Not eligible for free shipping.



**1964-1967**



RFP-64FL



RFP-64FR

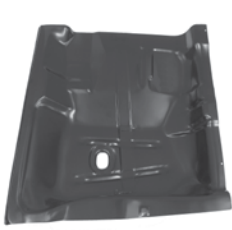

RFP-64RL

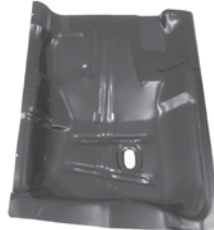

RFP-64RR

**1968-1972**



RFP-72FL



RFP-72FR



RFP-72RL



RFP-72RR

**Floor Pan Patches**

These front floor patches are high quality and constructed of heavy gauge steel. Perfect when only portions of your floor are rotted out.

RFP-64FL	1964-67 Chevelle Front LH.....	79.99 ea.
RFP-64FR	1964-67 Chevelle Front RH.....	79.99 ea.
RFP-64FL	1964-72 El Camino Front LH.....	79.99 ea.
RFP-64FR	1964-72 El Camino Front RH.....	79.99 ea.
RFP-72FL	1968-72 Chevelle Front LH.....	79.99 ea.
RFP-72FR	1968-72 Chevelle Front RH.....	79.99 ea.
RFP-64RL	1964-67 Chevelle Rear LH.....	69.99 ea.
RFP-64RR	1964-67 Chevelle Rear RH.....	69.99 ea.
RFP-64RL	1964-72 El Camino Rear LH.....	69.99 ea.
RFP-64RR	1964-72 El Camino Rear RH.....	69.99 ea.
RFP-72RL	1968-72 Chevelle Rear LH.....	69.99 ea.
RFP-72RR	1968-72 Chevelle Rear RH.....	69.99 ea.
RFP-78FL	1978-87 El Camino Front LH*.....	99.99 ea.
RFP-78FR	1978-87 El Camino Front RH*.....	99.99 ea.
RFP-78RL	1978-87 El Camino Rear LH*.....	99.99 ea.
RFP-78RR	1978-87 El Camino Rear RH*.....	99.99 ea.

\*Can be used on other G-bodies with modifications.

*Ships Oversize. Not eligible for free shipping.*

**BUY'N SAVE WITH KITS**



**Floor Pan Patch Kit**

This Chevelle floor pan patch kit includes front left and right floor pan patches and rear left and right floor pan patches. This is a great lower cost alternative to a full floor pan because this kit can ship via UPS instead of truck freight.

RFP-64K	1964-67 Chevelle.....	269.96 kit
RFP-64K	1964-72 El Camino.....	269.96 kit
RFP-72K	1968-72 Chevelle.....	269.96 kit

*Ships Oversize 2. Not eligible for free shipping.*

*No Volume Discount.*



RTB-64L



RTB-64R



RTB-68L



RTB-68R

**Toe Boards**

This toe board or floor pan extension connects the front of the floor pan to the firewall and is a commonly rotted out area. Now includes part of the transmission hump.

RTB-64L	1964-67 LH.....	62.99 ea.
RTB-64R	1964-67 RH.....	62.99 ea.
RTB-68L	1968-72 LH.....	62.99 ea.
RTB-68R	1968-72 RH.....	62.99 ea.

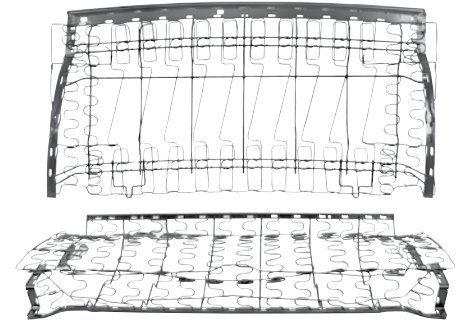

ISF-1402H



ISA-668L

**Bucket Seat Frames**

Complete bucket seat frame assemblies with seat springs already installed!

ISA-668L	1966-68 LH.....	439.99 ea.
ISA-668R	1966-68 RH.....	419.99 ea.
ISA-669	1969-72 All.....	419.99 ea.

*No Volume Discount. Ships Oversize 2.*

*Not eligible for free shipping.*

**Rear Seat Frames**

This is a reproduction rear seat frame which includes the back and bottom. This is a complete replacement for your worn out original springs.

ISF-1402H	1970-72.....	599.99 ea.
-----------	--------------	------------

*No Volume Discount. Ships Truck Freight.*

*Not eligible for free shipping.*



**Convertible Top Frame Assembly**

Fully assembled. The perfect replacement for your rusted out or bent original!

MCT-1417Y	1970-72 Convertible.....	1199.99 ea.
-----------	--------------------------	-------------

*For power top only.*

*This item ships Truck Freight to a Commercial Address.*



RST-76D

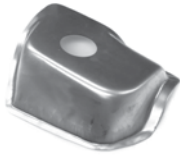

RST-76A

### Shifter Tunnel Pans

Correct stamped steel hump which was factory installed on all 3 or 4 speed cars.

RST-76D	1964-67 All	54.99 ea.
RST-76A	1964-67 Universal	59.99 ea.
RST-66W-O	1966-67 Chrome	119.99 ea.
RST-72D	1968-72 w/ Console	69.99 ea.
RST-72A	1968-72 w/o Console	69.99 ea.
RST-73D	1973-77 All	79.99 ea.
IQ-4015	1978-88 All Plastic	29.95 ea.



RIP-1489T

### Inner Rocker Panels

Reproduction die stamped inner rocker panels for an exact replacement.

RIP-647L	1964-67 LH	79.99 ea.
RIP-647R	1964-67 RH	79.99 ea.
RIP-1489T	1968-72 LH	56.99 ea.
RIP-1489S	1968-72 RH	56.99 ea.
RIP-5970	1964-72 All Drain Plugs	7.99 pr.
RIP-5970	1964-77 Inner Rocker Drain Plugs	7.99 pr.
RIP-78L	1978-88 LH Monte Carlo	99.99 ea.
RIP-78R	1978-88 RH Monte Carlo	99.99 ea.

*Ships Oversize. Not eligible for free shipping.*



RRP-682L

### Outer Rocker Panels

Correct gauge stamped steel full outer rocker panels with original mounting points.

RRP-647L	1964-67 LH	109.99 ea.
RRP-647R	1964-67 RH	109.99 ea.
RRP-682L	1968-72 LH	109.99 ea.
RRP-682R	1968-72 RH	109.99 ea.
RRP-E68L	1968-72 El Camino LH	159.99 ea.
RRP-E68R	1968-72 El Camino RH	159.99 ea.
RRP-78L	1978-88 LH Monte Carlo	199.99 ea.
RRP-78R	1978-88 RH Monte Carlo	199.99 ea.

*Ships Oversize. Not eligible for free shipping.*



RBR-64L

### Body Brace Repair

New die stamped panel that extends from wheel well area to meet trunk. This panel includes the body mount brace.

RBR-64L	1964-67 LH	93.95 ea.
RBR-64R	1964-67 RH	93.95 ea.

*Ships Oversize. Not eligible for free shipping.*



### Rear Seat Floor Pan

Installs under rear seat of car.

RSP-64L	1964-67 Chevelle LH	79.99 ea.
RSP-64R	1964-67 Chevelle RH	79.99 ea.

*Ships Oversize. Not eligible for free shipping.*



RSP-682

### Rear Seat Floor Pan

This new one piece under seat pan is complete with seat belt mounting plates.

RSP-647	1964-67 Chevelle	139.99 ea.
RSP-682	1968-72 Chevelle/El Camino	109.99 ea.

*Ships Oversize. Not eligible for free shipping. Requires modification for El Camino.*



IBX-99KR

### Chevelle Rear Seat Retainer Kit

This rear seat retainer kit contains all four of the necessary retainers to hold the rear seat of your Chevelle in place.

IBX-99KR	1964-72 Chevelle	22.95 kit
BSM-REAR	1964-67 Seat Back Bolts	9.99 pr.

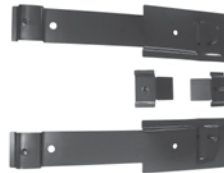

IBX-89K

### Bucket Seat Brackets

This is a reproduction bucket seat mounting bracket kit which will correctly mount both seats.

IBX-64K	1964-65 All	42.99 kit
IBX-89K	1966-72 All	49.99 kit
IBX-89K-FR	1966-68 All Front/Rear Set	57.99 kit
IBX-RELO	All (4pc) Relocation Brackets	34.99 kit

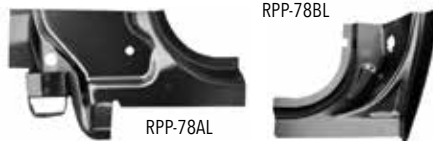

RPP-78AL

RPP-78BL

### Door Jamb Repair Patches

These patches repair the commonly rusted area at the front and back of the door jamb at the bottom of the A and B pillars.

RPP-78AL	1978-88 LH A-Pillar Monte Carlo	119.99 ea.
RPP-78AR	1978-88 RH A-Pillar Monte Carlo	119.99 ea.
RPP-78BL	1978-88 LH B-Pillar Monte Carlo	119.99 ea.
RPP-78BR	1978-88 RH B-Pillar Monte Carlo	119.99 ea.

*Fits 2 door only.*



RCR-1419

### Rocker to Cowl Reinforcements

Heavy gauge rocker to cowl reinforcement panels. Features Weld-Thru primer.

RDH-66LL	1966-67 LH	59.99 ea.
RDH-66LR	1966-67 RH	59.99 ea.
RCR-1419	1968-72	144.99 pr.

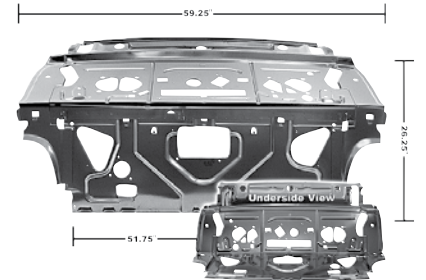

### Rear Deck Repair Panel

This is a brand new rear deck repair panel which replaces the commonly rusted area under the rear deck package tray and includes the rear seat divider.

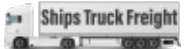

RDP-1462ZA	1968-72 Chevelle	549.99 ea.
------------	------------------	------------

*Ships truck freight to a commercial address only. Not eligible for free shipping. No Volume Discount.*

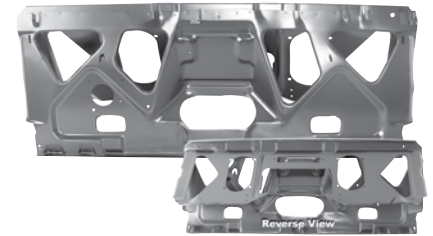

RPT-3468

### Rear Seat Mounting Panel

This piece replaces the entire rear seat mounting area which is commonly rotted out on convertibles.

RSP-1462LA	1970-72 Convertible	413.99 ea.
------------	---------------------	------------

*Oversize 2. Not eligible for free shipping. No Volume Discount.*



### Rear Package Tray Panel

Features correct details and heavy gauge steel as original. This panel will save you time and money over trying to fabricate patch panels for this commonly rusted out area.

RDP-645A	1964-65 Coupe	219.99 ea.
RDP-1462-ZE	1966-67 Coupe	299.99 ea.
RPT-3468	1968-72 Coupe	229.99 ea.
RSE-667L	1966-67 Extension LH	94.99 ea.
RSE-667R	1966-67 Extension RH	94.99 ea.
RSE-682L	1968-72 Extension LH	84.99 ea.
RSE-682R	1968-72 Extension RH	89.99 ea.

*Oversize 2. Not eligible for free shipping. No Volume Discount.*



### Package Tray Floor Braces

This is a pair of correct package tray braces (also referred to as X-braces).

RPT-66A	1966-67	39.99 pr.
---------	---------	-----------



RWC-64A

**Under Seat Wire Channel**

This is a correct Chevelle wire channel which is located under the seat.

RWC-64A	1964-67 Chevelle .....	49.99 kit
---------	------------------------	-----------



RFB-84RR



RFB-85RR



RFB-86RR



RFB-87RR

**Above Axle Crossmembers**

Correct steel crossmembers which go under the front of the trunk directly above the rear end.

RFB-84RR	1964-67 Chevelle .....	99.99 ea.
RFB-85RR	1968-69 Chevelle .....	109.99 ea.
RFB-86RR	1970 Chevelle.....	109.99 ea.
RFB-87RR	1971-72 Chevelle .....	109.99 ea.

*Ships Oversize. Not eligible for free shipping.*



RFR-1424E



RFR-1424J



RFR-1424K



RFR-1424L

**Rear Cross Rails**

These are the correct rear frame cross rails which go under the rear of the trunk.

RFR-1424E	1964-67 .....	99.99 ea.
RFR-1424J	1968-69 .....	99.99 ea.
RFR-1424K	1970 .....	99.99 ea.
RFR-1424L	1971-72 .....	99.99 ea.

*Ships Oversize. Not eligible for free shipping.*



RFB-84F



RFB-85M



RFB-84R



RFB-85R

**Floor Pan Braces**

These braces are a must when replacing any parts of your floor pan! These often rusted body braces support the floor pans under the front, middle and rear seats and offer the necessary support. All braces feature correct contours and cage nuts.

RFB-84F	1964-72 Front.....	99.99 ea.
RFB-737F	1973-77 Front.....	99.99 kit
RFB-85M	1964-72 Middle.....	99.99 ea.
RFB-737M	1973-77 Middle.....	99.99 kit
RFB-84R	1964-67 Rear.....	99.99 ea.
RFB-85R	1968-72 Rear.....	109.99 ea.
RFB-737R	1973-77 Rear.....	99.99 kit

*Ships Oversize. Not eligible for free shipping.*



RFR-68A

**Rear Frame Crossmember**

Ties the back of the frame together.

RFR-64A	1964-67 Chevelle .....	139.99 ea.
RFR-68A	1968-72 Chevelle .....	139.99 ea.

*Ships Oversize.*



RFB-64A

**Body Mount Frame Repair Bracket**

RFB-64A	1964-67 Chevelle .....	29.99 ea.
---------	------------------------	-----------



BCN-716



RCH-86L

**Partial Floor Pan Braces**

These partial braces extend approximately 16" from the outboard sides to the driveshaft. Cage nuts are included.

RCH-86L	1964-72 All Front LH.....	59.99 ea.
RCH-86R	1964-72 All Front RH.....	59.99 ea.
RCH-87L	1964-72 All Middle LH.....	58.95 ea.
RCH-87R	1964-72 All Middle RH.....	58.95 ea.
BCN-716	1964-72 All Cage Nut Only.....	9.99 ea.





Ships Truck Freight

### Full One Piece Trunk Floor Pans

Finally a complete one piece trunk floor is available for your Chevelle! This full floor measures approximately 61" x 56.5" and features body and fuel braces, rear reinforcement bracket, jack and spare tire brackets and correct "ribbed" floor stampings. This floor extends into the back of the rear seat as well as into the rear body panel.

RTF-164	1964-67 Chevelle*	499.99 ea.
RTF-168	1968 Chevelle	499.99 ea.
RTF-169	1969 Chevelle	499.99 ea.
RTF-170	1970 Chevelle	499.99 ea.
RTF-171	1971-72 Chevelle	499.99 ea.

\*Tail panel may require slight trimming.

No Volume Discount. Ships Truck Freight to a commercial address. Not eligible for free shipping.

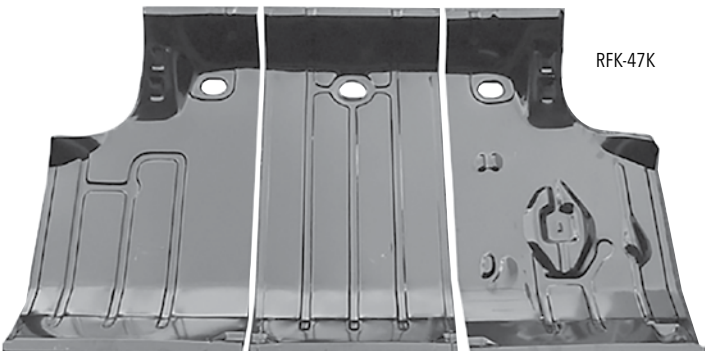

RFK-47K

**BUY'N SAVE WITH KITS**

### Trunk Floor Repair Patches

These individual trunk floor pieces are perfect when your entire trunk isn't rotted out and also allows you to save on shipping as opposed to a full trunk floor. Buy the set of all 3 and save!

RTF-64L	1964-67 LH	54.99 ea.
RTF-64C	1964-67 Center	54.99 ea.
RTF-64R	1964-67 RH	54.99 ea.
RTF-68L	1968-72 LH	54.99 ea.
RTF-68C	1968-72 Center	54.99 ea.
RTF-68R	1968-72 RH	54.99 ea.
RFK-47K	1964-67 (3 pc.)	148.47 kit
RFK-82K	1968-72 (3 pc.)	148.47 kit

No Volume Discount. Ships Oversize.

Not eligible for free shipping.

**BUY'N SAVE WITH KITS**

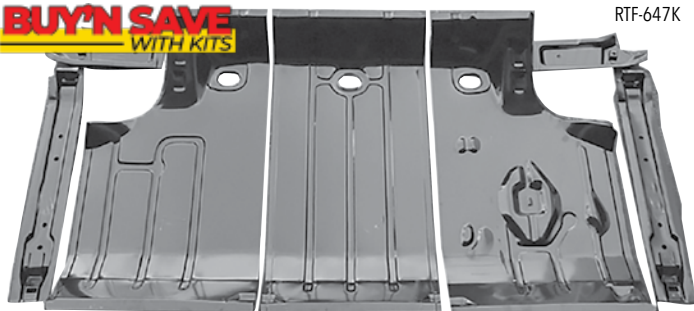

RTF-647K

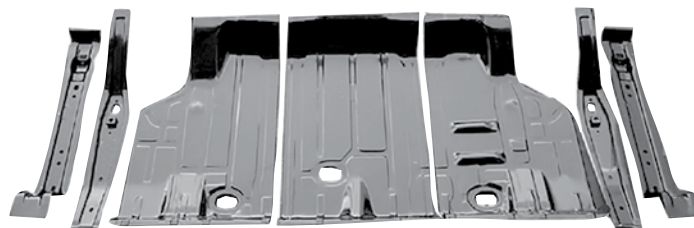

RTF-682K

### Trunk Floor Kits

This 7 piece kit includes (3) trunk floor sections, (2) frame braces and (2) fuel tank braces so you can do the job right while saving money.

RTF-647K	1964-67 Chevelle (7 pc.)	299.99 kit
RTF-682K	1968-72 Chevelle (7 pc.)	299.99 kit

No Volume Discount. Ships Oversize.

Not eligible for free shipping.



### Trunk Floor Center Pan

This is a correct die stamped Chevelle center floor section which is perfect when only the center of your trunk floor is rotted out. Features all of the factory lines and contours. Measures 46W x 34L.

RTF-68U	1968-72	179.99 ea.
---------	---------	------------

No Volume Discount. Ships Oversize.

Not eligible for free shipping.

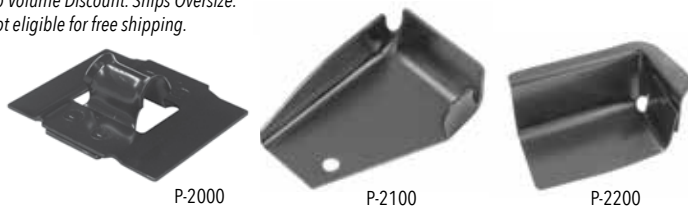

P-2000

P-2100

P-2200

### Spare Tire Anchor Plates

Correct spare tire hold down and jack floor brackets.

P-2000	1964-72 Anchor Plate	11.99 ea.
P-2100	1964-67 Jack Bracket	9.95 ea.
P-2200	1968-72 Jack Bracket	11.99 ea.

RTB-647



RTB-682



**Fuel Tank Braces**

Correct braces that attach to the trunk floor and support the tank straps.

RTB-647	1964-67 Chevelle LH & RH .....	44.99 ea.
RTB-682	1968-72 Chevelle LH & RH .....	39.99 ea.
RTB-E64	1964-67 El Camino .....	89.99 pr.
RTB-E68	1968-72 El Camino .....	94.95 pr.

RBB-64R



RBB-68R

**Trunk Floor Braces**

Correct stamped steel braces that support the trunk floor. All braces include correct cage nuts.

RBB-64L	1964-67 LH .....	42.99 ea.
RBB-64R	1964-67 RH .....	42.99 ea.
RBB-68L	1968-72 LH .....	49.99 ea.
RBB-68R	1968-72 RH .....	49.99 ea.

RQE-702L



RQE-702R

**Trunk Drop Offs/Quarter Panel Extensions**

These die stamped drop offs connect the inside lower rear of the quarter panel to the outside of the trunk.

RQE-64L	1964-65 LH .....	44.99 ea.
RQE-64R	1964-65 RH .....	44.99 ea.
RQE-66L	1966-67 LH .....	44.99 ea.
RQE-66R	1966-67 RH .....	44.99 ea.
RQE-68L	1968 LH .....	44.99 ea.
RQE-68R	1968 RH .....	44.99 ea.
RQE-69L	1969 LH .....	44.99 ea.
RQE-69R	1969 RH .....	44.99 ea.
RQE-702L	1970-72 LH .....	49.99 ea.
RQE-702R	1970-72 RH .....	49.99 ea.

RDP-100



**Trunk/Floor Pan Drain Plug**

Correct die stamped floor drain plug.

RDP-100	1964-72 All .....	3.95 ea.
RDP-7488	1978-88 All .....	13.99 ea.

**Rear Tail Lamp Panels**

Reproduction rear body panels.



RTP-645-C 1964-65 Center Tail Panel ..... 139.99 ea.



RTP-645-EL 1964-65 LH Extension\* ..... 79.99 ea.  
RTP-645-ER 1964-65 RH Extension\* ..... 79.99 ea.  
\*Must modify for 1964 models.



RTP-66 1966 Chevelle ..... 169.99 ea.



RTP-67 1967 Chevelle ..... 149.99 ea.



RTP-69B 1968-69 Chevelle w/ Brackets... 199.99 ea.



RTP-702 1970-72 Chevelle ..... 144.99 ea.  
*Ships Oversize. Not eligible for free shipping.*



RTP-645



RTP-69A

**Complete Rear Tail Lamp Panels**

This is a brand new complete and correct tail lamp panel which will replace your damaged original exactly.

RTP-645	1964-65 Chevelle .....	279.99 ea.
RTP-68A	1968 Chevelle .....	199.99 ea.
RTP-69A	1969 Chevelle .....	199.99 ea.

*Ships Oversize. Not eligible for free shipping.*



RVP-70

**Rear Valance Panels**

Reproduction steel valance panel which extends horizontally from each quarter panel and mounts below bumper.

RVP-70	1970 Chevelle .....	89.99 ea.
RVP-712	1971-72 Chevelle .....	89.99 ea.

*Ships Oversize. Not eligible for free shipping.*

RTG-8A



**Trunk Weatherstrip Gutter**

This Chevelle trunk weatherstrip gutter set includes both of the metal channels which are required to properly mount your trunk weatherstrip.

RTG-4A	1964-65 Chevelle .....	74.99 pr.
RTG-6A	1966-67 Chevelle .....	72.99 pr.
RTG-8A	1968-72 Chevelle .....	66.99 pr.

**Trunk Gutter Side Braces**

Correct stamped steel side braces which support the trunk gutter.

RTB-64BL	1964-65 LH .....	39.99 ea.
RTB-64RL	1964-65 LH .....	39.99 ea.



RTB-1462T



RTB-68AL



RTP-645-RL

**Tail Lamp Panel Braces**

Correct tail lamp panel support braces.

RTB-66K	1966 (3 pc.) .....	149.99 kit
RTB-66AL	1966 Chevelle LH .....	54.99 ea.
RTB-66AR	1966 Chevelle RH .....	54.99 ea.
RTB-68AL	1968-69 LH .....	32.99 ea.
RTB-68AR	1968-69 RH .....	32.99 ea.
RTB-689K	1968-69 (2 pc) .....	54.99 kit

**Tail Light Reinforcement**

Correct tail panel reinforcement brackets.

RTP-645-RL	1964-65 LH .....	15.99 ea.
RTP-645-RR	1964-65 RH .....	15.99 ea.

**Tail Lamp Panel Support Brace**

Correct tail lamp panel support brace.

RTB-645	1964-65 .....	33.99 ea.
RTB-1461P	1968-69 .....	49.99 ea.
RTB-1462T	1970-72 .....	44.99 ea.
RTB-66-T	1966 Center .....	54.99 ea.
RTB-671BK	(2 pc.) LH/RH .....	124.99 pr.



RFR-78EL



RFR-78ER

**1978-88 Rear Frame Rails & Floor Pan Repair**

Perfect for repairing the often rotted rear section of the chassis and trunk floor behind the rear wheels.

**Partial Replacement Rear Frame Rails**

RFR-78GL	1978-88 2 Door Coupe LH .....	169.99 ea.
RFR-78GR	1978-88 2 Door Coupe RH .....	169.99 ea.
RFR-78EL	1978-88 El Camino LH .....	169.99 ea.
RFR-78ER	1978-88 El Camino RH .....	169.99 ea.

**Trunk Floor To Frame Repair Plates**

RFB-78G	1978-88 2 Door Coupe .....	84.99 set
BCN-788	1978-88 Body Cage Nut Only Fits All .....	11.99 ea.

*Ships Oversize. Not eligible for free shipping.*



RTL-67

**Trunk Lids**

Reproduction of the often rotted or damaged trunk lid.

RTL-67	1966-67 Chevelle .....	219.95 ea.
RTL-6872	1968-72 Chevelle 1970-72 Monte Carlo.....	219.99 ea.
RTL-8187	1981-87 Regal .....	569.99 ea.

No Volume Discount. Ships Truck Freight to a commercial address. Not eligible for free shipping.



RWP-645

**Rear Window to Trunk Panel**

Reproduction stamped steel panel which fits between the rear window and the trunk lid.

RWP-645	1964-65 Coupe.....	84.99 ea.
RWP-645-OE	1964-65 Coupe Complete OE Style .....	89.99 ea.
RWP-667	1966-67 Coupe.....	69.99 ea.
RWP-682	1968-72 Coupe.....	59.99 ea.
RWP-68V	1968-72 Convertible.....	89.99 ea.

Ships Oversize 2. Not eligible for free shipping.

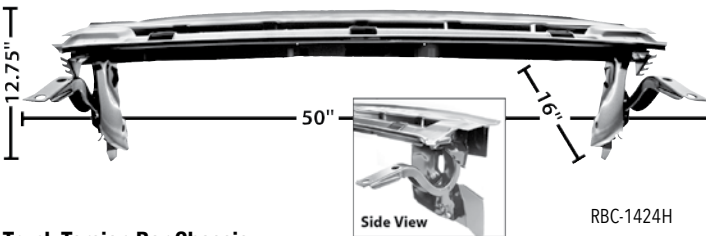

RBC-1424H

**Trunk Torsion Bar Chassis**

Brand new convertible trunk torsion bar chassis which is an exact replacement for your worn out original assembly.

RBC-1424H	1970-72 Convertible.....	349.99 ea.
-----------	--------------------------	------------

Ships Oversize. Not eligible for free shipping. Does not include torsion bars.



RLS-097

**Trunk Torsion Rods**

Correct torsion rods for holding up trunk lid.

RLS-097	1964-65 All .....	59.99 pr.
RLS-098	1966-67 All .....	59.99 pr.
RLS-099	1968-72 Convertible.....	59.99 pr.
RLS-100	1968-72 Coupe.....	59.99 pr.



MS149-09

**Eddie Motorsports Billet Trunk Hinges**

These billet trunk hinges are CNC machined from high quality 6061-T6 aluminum. They utilize Nitrogen filled gas struts that replace the stock torsion springs and high quality Delrin bushings for smooth reliable operation. The hinges are designed as direct fit, "bolt on" parts with some minor drilling required for fastening of the strut mount. The hinges come complete with mounting hardware, brackets (where required) and gas struts.

M = Machined	W = White Fusioncoat	MB = Matte Black Fusioncoat
P = Polished	PR = Purple Fusioncoat	MBA = Matte Black Anodized
R = Red Fusioncoat	BK = Gloss Black Fusioncoat	CL = Clear Coat
B = Blue Fusioncoat	BKA = Gloss Black Anodized	CA = Clear Anodized

		M	P	R, B, W, PR, BK, BKA, MB, MBA, CL, CA
MS149-09	1966-67 All .....	425.99 pr.....	465.99 pr.....	495.99 pr.
MS149-10	1968-72 All .....	425.99 pr.....	465.99 pr.....	495.99 pr.

**1968-72 Trunk Hinges**

Reproduction trunk hinges to replace your worn out originals.

RTH-1489DA	1968-72 Coupe.....	155.99 pr.
RTH-1489DD	1970-72 Convertible.....	195.95 pr.

RTH-1489DA

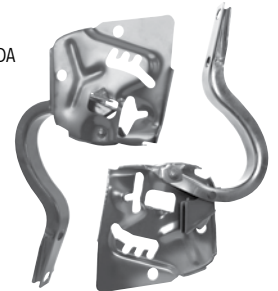

**Trunk Wire Clip**

Correct clips used to hold the power trunk or trunk light wires to the hinge.

GWC-SPK	1964-77 All .....	19.99 pr.
---------	-------------------	-----------



GWC-SPK



RTL-1019

**Trunk Latch**

Correct trunk latch inside of the trunk lid.

RTL-1019	1968-72 .....	29.95 ea.
TLB-716	1964-77 Latch Bolts (5pc).....	9.99 set

**Trunk Catch (Striker)**

Mounts inside the trunk to catch the trunk latch.

RTL-6470	1964-69 .....	26.99 ea.
RTB-66-T	1966-67 Brace .....	54.99 ea.
RLC-1462U	1970-72 .....	20.99 ea.



RTL-6470

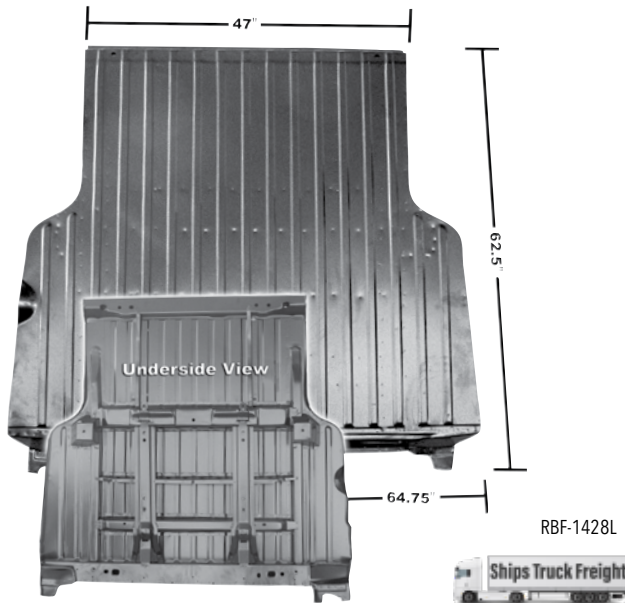

RBF-1428L

**El Camino Bed Floor Panel**

This is a complete bed floor with braces and roll pan.

- RBF-1428L 1968-72 Bed With Supports & Roll Pan.....1099.95 ea.
- RBF-78 1978-87 Full Bed Floor w/o Braces.....499.99 ea.

No Volume Discount. All floors ship Truck Freight to a commercial address. Not eligible for free shipping.



RBF-1428H

**El Camino Bed Floor w/ Braces**

Complete bed panel with under panel support braces.

- RBF-1428H 1968-72.....749.95 ea.

No Volume Discount. All floors ship Truck Freight to a commercial address. Not eligible for free shipping.



RIO-1475HC

**El Camino Complete Inner Quarters**

Complete inner quarter panels with wheelhouse already attached!

- RIO-1475HC 1968-72 El Camino LH.....799.95 ea.
- RIO-1475GC 1968-72 El Camino RH.....799.95 ea.

No Volume Discount. Ships Truck Freight to a commercial address. Not eligible for free shipping.



RTG-1428

**Complete Tailgates**

Reproduction ready to install complete tailgates.

- RTG-1429D 1964-67.....419.95 ea.
- RTG-1428 1968-72 w/o Backup Light Holes.....269.95 ea.
- RTG-1429 1968-72 w/ Backup Light Holes.....329.99 ea.
- RTG-78 1978-87.....499.99 ea.

No Volume Discount. Ships Truck Freight to a commercial address. Not eligible for free shipping.



RTG-64



RTG-92

**El Camino Tailgate Skins**

Reproduction tailgate skins, perfect when your inner structure has not rotted out.

- RTG-64 1964-66 w/ Emblem Holes.....169.99 ea.
- RTG-67 1967 w/o Emblem Holes.....169.99 ea.
- RTG-68 1968 w/o Reverse Light Holes.....169.99 ea.
- RTG-92 1969-72 w/ Reverse Light Holes.....169.99 ea.

No Volume Discount. Ships Truck Freight to a commercial address. Not eligible for free shipping.



RGL-1429A

**El Camino Tailgate Latch Set**

Complete set of new latches for tailgate.

- RGL-1429A 1968-72 El Camino.....99.95 set



**El Camino Spare Tire Panel**  
 Reproduction panel which mounts behind the seat in the spare tire area.  
 RTP-1428A 1968-72 El Camino ..... 164.99 ea.  
*Ships Oversize. Not eligible for free shipping. No Volume Discount.*



**El Camino Below Rear Window Panel** RFB-1428B  
 This corrugated steel panel fits below the rear window.  
 RFB-1428B 1968-72 El Camino ..... 249.99 ea.  
 RFB-78 1978-87 El Camino ..... 249.99 ea.  
*Ships Oversize. Not eligible for free shipping. No Volume Discount.*



**El Camino Front Bed Lift Panel** RBP-28C  
 Reproduction of the front bed lift out panel.  
 RBP-28C 1968-72 El Camino ..... 124.99 ea.  
*Ships Truck Freight to a Commercial Address only. Not eligible for free shipping.*



**El Camino Inner Panels** RIB-1475HA  
 Reproduction stamped inner bed panels.  
 RIB-1475HA 1968-72 El Camino LH ..... 279.99 ea.  
 RIB-1475GA 1968-72 El Camino RH ..... 279.99 ea.  
 RIB-78L 1978-87 El Camino LH ..... 199.99 ea.  
 RIB-78R 1978-87 El Camino RH ..... 199.99 ea.  
*Ships Oversize. Not eligible for free shipping. No Volume Discount.*



**El Camino Bed to Quarter Fillers** RQF-1462R, RQF-1462Q  
 Correct filler panels which install between the bed and quarter panels.  
 RIB-1475HQ 1964-67 LH ..... 119.99 ea.  
 RIB-1475HP 1964-67 RH ..... 119.99 ea.  
 RQF-1462R 1968-72 LH ..... 179.99 ea.  
 RQF-1462Q 1968-72 RH ..... 134.99 ea.

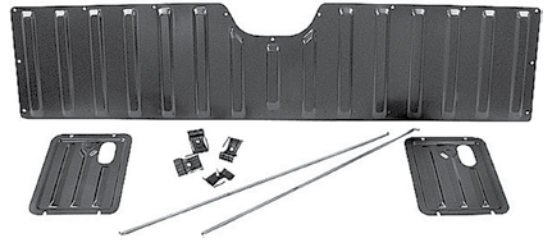

**El Camino Tailgate Inner Panel Kit** RGP-E5  
 Bolt-in panels for the inside of your tailgate.  
 RGP-E3 1964-67 El Camino 3 pc ..... 169.95 kit  
 RGP-E5 1968-72 El Camino 9 pc ..... 104.99 ea.  
*No Volume Discount. Ships Oversize. Not eligible for free shipping.*



**El Camino Rear Window Panel** RWP-E4  
 Correct steel repair panel between rear window and bed.  
 RWP-E4 1964-67 El Camino ..... 46.99 ea.  
 RWP-E8 1968-72 El Camino ..... 59.99 ea.  
*Ships Oversize. Not eligible for free shipping.*



**El Camino Rear Window Shelf Panel** RSP-1428D  
 Correct weld-in panel which installs behind the rear seat and below the rear window inside of the cab.  
 RSP-1428D 1968-72 El Camino ..... 129.99 ea.  
*Ships Oversize. Not eligible for free shipping.*



**El Camino Bed Lift Panel Support** RBP-1428G  
 Reproduction bed lift panel support.  
 RBP-1428G 1964-67 El Camino ..... 129.99 ea.  
*Ships Oversize. Not eligible for free shipping.*



**El Camino Divider Panel Kit** RDP-1428F  
 Reproduction divider panel with cutouts.  
 RDP-1428F 1964-67 El Camino ..... 199.99 kit  
*Ships Oversize. Not eligible for free shipping.*



**Rear of Bed Roll Pan** RBF-1428K  
 Reproduction roll pan for the rear of the bed.  
 RBF-1428K 1968-72 ..... 329.95 ea.  
*No Volume Discount. Ships Truck Freight to a commercial address. Not eligible for free shipping.*



**Rear Bed Cross Rail** RBF-1428J  
 Reproduction rear cross bar for the rear of the bed.  
 RBF-1428J 1968-72 ..... 99.99 ea.  
*No Volume Discount. Ships Oversize 2. Not eligible for free shipping.*

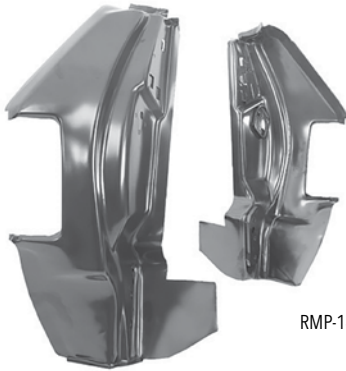

RMP-1423B

**El Camino Tail Lamp Mounting Panels**

Brand new tail lamp mounting panels to replace your rusty originals.

RMP-1475HS	1964-65 LH .....	96.95 ea.
RMP-1475HR	1964-65 RH .....	96.95 ea.
RMP-1423B	1968-72 LH .....	92.95 ea.
RMP-1423A	1968-72 RH .....	92.95 ea.

*Ships Oversize. Not eligible for free shipping.*



RIB-1475HB

**El Camino Front Inner Quarter Panels**

Reproduction stamped front inner quarter panels.

RIB-1475HB	1968-72 El Camino LH .....	79.99 ea.
RIB-1475GB	1968-72 El Camino RH .....	79.99 ea.



RFD-1475L

**El Camino Fuel Tank Door**

Reproduction of the often damaged or missing fuel tank door.

RFD-1475HT	1964-67 .....	89.99 ea.
RFD-1475L	1968-72 .....	57.99 ea.



RTG-647RB

**Tailgate Hinge Rebuild Kit**

Correct pins and bushings to make both tailgate hinges work like new. Original head markings and brass bushings to match originals.

RTG-647RB	1964-67 .....	23.99 kit
RTG-682RB	1968-72 .....	23.99 kit

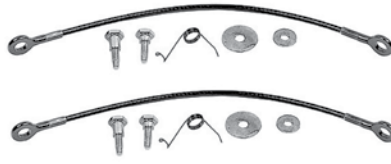

RCK-E5



RTC-78EL

**Tailgate Cables**

Reproduction tailgate cables featuring top quality sheathed cables. 1968-77 kits come with cables, springs, and bolts.

RCK-E5	1968-77 w/ Hardware .....	36.99 set
RTC-78EL	1978-88 Cables Only .....	39.95 pr.



JSB-E33

**Tailgate Bumpers**

Correct rubber stop bumpers which prevent the tailgate from hitting metal on metal.

JSB-E33	1968-72 El Camino .....	1.99 ea.
---------	-------------------------	----------



RTH-E4817

**Tailgate Handle**

Reproduction inner tailgate handle with nylon washer.

RTH-E4817	1968-72 .....	18.99 ea.
-----------	---------------	-----------



RGK-200

**Tailgate/Bed Fastener Kit**

Correct set of fasteners for tailgate and rear of bed.

RGK-200	1964-72 El Camino .....	10.99 kit
---------	-------------------------	-----------



RTH-6467E

**Tailgate Support Straps**

These El Camino tail gate support straps are identical to original equipment and features the correct center and outer pivots for smooth operation every time. Correct mounting hardware is included for both the tailgate and body side of your vehicle.

RTH-6467E	1964-67 .....	129.99 kit
-----------	---------------	------------

*No volume discount.*



RSK-E7

**Bed & Tailgate Bolt Kit**

Complete kit with all correct bolts and screws for hinges, tailgate and bed floor.

RSK-E7	1968-72 El Camino .....	47.99 kit
--------	-------------------------	-----------



RTH-1490H

**Tailgate Hinges**

Reproduction tailgate hinges to replace your worn out originals.

RTH-1490H	1968-72 .....	184.99 pr.
-----------	---------------	------------

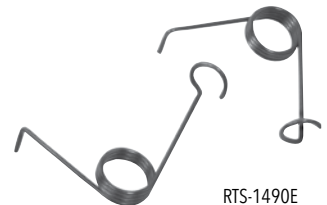

RTS-1490E

**Tailgate Cable Springs**

Correct pair of tailgate cable springs.

RTS-1490E	1964-72 .....	4.95 pr.
RTS-1490F	1973-87 .....	4.95 pr.

**Factory Style Window Glass**

This factory style Softray tinted window glass for your Chevelle is the perfect replacement for your cracked or missing original glass. All glass is available with factory date coding for an additional fee.



**Complete Glass Kits**

Save when you buy a complete set of replacement window glass!

GL-64AK	1964 Coupe (8pc)	.....	749.99	kit
GL-65AK	1965 Coupe (8pc)	.....	799.99	kit
GL-66AK	1966-67 Coupe (8pc)	.....	819.99	kit
GL-68AK	1968 Coupe (8pc)	.....	826.99	kit
GL-69AK	1969 Coupe (6pc)	.....	799.99	kit
GL-70AKA	1970-72 Coupe w/ Antenna (6pc)	.....	899.99	kit
GL-70AK	1970-72 Coupe (6pc)	.....	819.99	kit
GL-64AVK	1964-65 Convertible (7pc)	.....	699.99	kit
GL-66AVK	1966-67 Convertible (7pc)	.....	699.99	kit
GL-68AVK	1968 Convertible (7pc)	.....	719.99	kit
GL-69AVK	1969 Convertible (5pc)	.....	649.99	kit
GL-70AVKA	1970-72 Convertible w/ Antenna (5pc)	.....	699.99	kit
GL-70AVK	1970-72 Convertible (5pc)	.....	699.99	kit

No Volume Discount. Ships Truck Freight to a Commercial Address. Not eligible for free shipping.



**Windshield Glass**

- 1964-65 Chevelle, Malibu, SS 2dr Hardtop
- 1964-67 Chevelle 300, 300 Deluxe 2dr Sedan
- 1964-67 300, Deluxe, Malibu 4dr Sedan
- 1964-65 Chevelle Convertible
- 1964-65 Chevelle 300 2dr Wagon
- 1964-65 Chevelle 4dr Wagon



1964-67 El Camino	GL-64AF	Windshield.....	148.99	ea.		
1966-67 Chevelle, Malibu 2dr Hardtop	1966-67 Chevelle Convertible	GL-66AF	Windshield.....	117.99	ea.	
1968-69 Chevelle, Malibu 2dr Sedan	1968-69 Chevelle 2dr Coupe	1968-72 El Camino	GL-68AF	Windshield.....	129.99	ea.
1968-69 Chevelle Convertible	GL-68AFV	Windshield.....	150.99	ea.		
1970-72 Chevelle, Malibu 2dr Sedan	1970-72 El Camino	1970-72 Monte Carlo	GL-68AFA	Windshield.....	169.99	ea.

1970-72 Chevelle Convertible  
GL-68AFVA Windshield.....174.99 ea.  
No Volume Discount. Ships Truck Freight to a Commercial Address. Not eligible for free shipping.

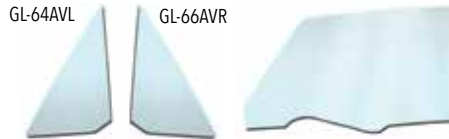

**Vent Window Glass**

1964-65 All Chevelle / 1964-67 El Camino	1966-67 Chevelle 300, 300 Deluxe 2dr Sedan	1966-67 Chevelle 300, 300 Deluxe 4dr Sedan	1966-67 Chevelle 4dr Wagon	GL-64ADL
GL-64AVL	Vent LH.....	55.99	ea.	
GL-64AVR	Vent RH.....	55.99	ea.	

1966-67 Chevelle Malibu, 2dr Hardtop & Convertible	GL-66AVL	Vent LH.....	68.99	ea.
	GL-66AVR	Vent RH.....	68.99	ea.

1968 Chevelle 2dr Coupe	1968 Chevelle Convertible	GL-68AVL	Vent LH.....	63.99	ea.
		GL-68AVR	Vent RH.....	63.99	ea.

1968 Chevelle 2dr Sedan	1968-72 El Camino	GL-68AVSL	Vent LH.....	63.99	ea.
		GL-68AVSR	Vent RH.....	63.99	ea.

*Ships Oversize. Not eligible for free shipping.*

1964 Chevelle, Malibu, SS 2dr Hardtop	GL-64ADL	Door LH.....	126.99	ea.
	GL-64ADR	Door RH.....	126.99	ea.

1964 Chevelle Convertible	GL-64AVDL	Door LH.....	126.99	ea.
	GL-64AVDR	Door RH.....	126.99	ea.

1965 Chevelle, Malibu, SS 2dr Hardtop	GL-65ADL	Door LH.....	126.99	ea.
	GL-65ADR	Door RH.....	126.99	ea.

1965 Chevelle Convertible	GL-65AVDL	Door LH.....	126.99	ea.
	GL-65AVDR	Door RH.....	126.99	ea.

1964-67 El Camino	GL-64EDL	Door LH.....	126.99	ea.
	GL-64EDR	Door RH.....	126.99	ea.

1964-65 Chevelle 300 2dr Wagon	GL-64ADWL	Door LH.....	135.99	ea.
	GL-64ADWR	Door RH.....	135.99	ea.

1966-67 Chevelle, Malibu 2dr Coupe	1966-67 Chevelle Convertible	GL-66ADL	Door LH.....	137.99	ea.
		GL-66ADR	Door RH.....	137.99	ea.

1966-67 Chevelle 300, 300 Deluxe 2dr Sedan	GL-66ADSL	Door LH.....	187.99	ea.
	GL-66ADSR	Door RH.....	187.99	ea.

1968 Chevelle, Malibu 2dr Coupe & Convertible	GL-68ADL	Door LH.....	139.99	ea.
	GL-68ADR	Door RH.....	139.99	ea.

1969 Chevelle, Malibu 2dr Coupe & Convertible	GL-69ADL	Door LH.....	149.99	ea.
	GL-69ADR	Door RH.....	139.99	ea.

1968-69 Chevelle 2dr Sedan	GL-68ASDL	Door LH.....	119.99	ea.
	GL-68ASDR	Door RH.....	100.99	ea.

1970-72 Chevelle 2dr Coupe & Convertible	GL-70ADL	Door LH.....	149.99	ea.
	GL-70ADR	Door RH.....	149.99	ea.

1968-72 El Camino	GL-70EDL	Door LH.....	126.99	ea.
	GL-70EDR	Door RH.....	126.99	ea.

*Ships Oversize 2. Not eligible for free shipping.*



IVH-67

**Vent Window Handles**

OE style reproduction die cast chrome handles.

IVH-52	1964-65 Chevelle	.....	36.99	pr.
IVH-67	1966-67 Chevelle	.....	39.95	pr.
IVH-52	1964-67 El Camino	.....	36.99	pr.



**Quarter Window Glass**

1964-65 Chevelle, Malibu, SS 2dr Coupe	GL-64AQL	Quarter LH.....	99.99	ea.
	GL-64AQR	Quarter RH.....	99.99	ea.

1964-65 Chevelle Convertible	GL-64AVQL	Quarter LH.....	99.99	ea.
	GL-64AVQR	Quarter RH.....	99.99	ea.

1964-65 Chevelle 2dr Sedan	GL-64AOSL	Quarter LH.....	124.99	ea.
	GL-64AOSR	Quarter RH.....	124.99	ea.

1966-67 Chevelle Malibu, SS 2dr Coupe	GL-66AQL	Quarter LH.....	98.99	ea.
	GL-66AQR	Quarter RH.....	98.99	ea.

1966-67 Chevelle Convertible	GL-66AVQL	Quarter LH.....	98.99	ea.
	GL-66AVQR	Quarter RH.....	98.99	ea.

1966-67 Chevelle 2dr Sedan	GL-66AVSL	Quarter LH.....	177.99	ea.
	GL-66AVSR	Quarter RH.....	177.99	ea.

1968-69 Chevelle, Malibu 2dr	GL-68AQL	Quarter LH.....	108.99	ea.
	GL-68AQR	Quarter RH.....	108.99	ea.

1968-69 Chevelle Convertible	GL-68AVQL	Quarter LH.....	108.99	ea.
	GL-68AVQR	Quarter RH.....	108.99	ea.

1968-72 Chevelle 2dr Sedan	GL-68AOSL	Quarter LH.....	107.99	ea.
	GL-68AOSR	Quarter RH.....	107.99	ea.

1970-72 Chevelle, Malibu, 2dr Coupe	GL-70AQL	Quarter LH.....	99.99	ea.
	GL-70AQR	Quarter RH.....	99.99	ea.

Ships Oversize. Not eligible for free shipping.				
---	--	--	--	--

1964-65 Chevelle, Malibu, SS 2dr Coupe	GL-64AR	Rear.....	245.99	ea.
--	---------	-----------	--------	-----

1964-65 Chevelle 300, 300 Deluxe 2dr Sedan	GL-64ARS	Rear.....	247.99	ea.
--	----------	-----------	--------	-----

1966-67 Chevelle, Malibu 2 dr Coupe	GL-66AR	Rear.....	126.99	ea.
-------------------------------------	---------	-----------	--------	-----

1968-72 Chevelle All 2dr Coupe & Sedan	GL-68AR	Rear.....	209.99	ea.
--	---------	-----------	--------	-----

1964-67 El Camino	GL-64ER	Rear.....	182.99	ea.
-------------------	---------	-----------	--------	-----

1968-72 El Camino	GL-68ER	Rear.....	175.99	ea.
-------------------	---------	-----------	--------	-----

No Volume Discount. Ships Truck Freight to a Commercial Address. Not eligible for free shipping.

### Power Window Retrofit Kits

Ground Up Motor Sports exclusive power window kits are the best available on the market today! They Bolt-into the original mounting holes making for a hassle free installation. Using 1018 cold-roll steel, bronze oilite thrust bearing at all the pivot points and heat treated metal for all gears results in a quality smooth operating regulator that will last for many years. The motors are all brand new and have been thoroughly tested for quality and feature a strong dependable motor. Kits include: new regulators, new ACI window motors, a new completed wiring harness, your choice of switches and the conduit from the a-pillar to the door. F/R= Front and Rear Kit



#### Chevelle Kits

PWK-64CH	1964-65 Coupe F/R Chrome Switches.....	972.99 kit
PWK-64CH-NOST	1964-65 Coupe F/R Nostalgic Switches.....	1124.99 kit
PWK-64CHV-NOST	1964-67 Convertible F/R Nostalgic Switches .....	1124.99 kit
PWK-64CH-CRANK	1964-65 Coupe F/R Crank Switches .....	1288.99 kit
PWK-64CHV-CRANK	1964-65 Convertible F/R Crank Switches .....	1288.99 kit
PWK-66CH-NOST	1966-67 Coupe F/R Nostalgic Switches.....	1124.99 kit
PWK-66CH-CRANK	1966-67 Coupe F/R Crank Switches .....	1288.99 kit
PWK-66CH	1966-67 All F/R Chrome Switches .....	972.99 kit
PWK-64CH-2-CHROME	1964-67 Coupe Front Only Chrome Switches .....	497.99 kit
PWK-64CH-2-BLACK	1964-67 Coupe Front Only Black Switches.....	498.99 kit
PWK-64CH-2-NOST	1964-67 Coupe Front Only Nostalgic Switches .....	588.99 kit
PWK-64CH-2-CRANK	1964-67 Coupe Front Only Crank Switches.....	650.99 kit
PWK-68CH	1968 All F/R Chrome Switches .....	972.99 kit
PWK-68CH-NOST	1968 All F/R Nostalgic Switches .....	1124.99 kit
PWK-68CH-CRANK	1968 All F/R Crank Switches .....	1288.99 kit
PWK-68CH-2-CHROME	1968 All Front Only Chrome Switches .....	497.99 kit
PWK-68CH-2-BLACK	1968 All Front Only Black Switches .....	498.99 kit
PWK-68CH-2-NOST	1968 All Front Only Nostalgic Switches.....	588.99 kit
PWK-68CH-2-CRANK	1968 All Front Only Crank Switches .....	650.99 kit
PWK-69CH	1969 All F/R Chrome Switches .....	972.99 kit
PWK-69CH-NOST	1969 All F/R Nostalgic Switches .....	1124.99 kit
PWK-69CH-CRANK	1969 All F/R Crank Switches .....	1288.99 kit
PWK-69CH-2-CHROME	1969 All Front Only Chrome Switches .....	497.99 kit
PWK-69CH-2-BLACK	1969 All Front Only Black Switches .....	498.99 kit
PWK-69CH-2-NOST	1969 All Front Only Nostalgic Switches.....	588.99 kit
PWK-69CH-2-CRANK	1969 All Front Only Crank Switches .....	650.99 kit
PWK-70CH	1970-72 All F/R Chrome Switches .....	972.99 kit
PWK-70CH-NOST	1970-72 All F/R Nostalgic Switches .....	1124.99 kit
PWK-70CH-CRANK	1970-72 All F/R Crank Switches.....	1288.99 kit
PWK-70CH-2-CHROME	1970-72 All Front Only Chrome Switches.....	497.99 kit
PWK-70CH-2-BLACK	1970-72 All Front Only Black Switches .....	498.99 kit
PWK-70CH-2-NOST	1970-72 All Front Only Nostalgic Switches .....	588.99 kit
PWK-70CH-2-CRANK	1970-72 All Front Only Crank Switches .....	650.99 kit
PWK-73CH-CHROME	1973-77 Front Only Chrome Switches .....	511.99 kit
PWK-73CH-BLACK	1973-77 Front Only Black Switches.....	513.99 kit
PWK-73CH-NOST	1973-77 Front Only Nostalgic Switches .....	603.99 kit
PWK-73CH-CRANK	1973-77 Front Only Crank Switches.....	664.99 kit

#### El Camino Kits

PWK-64EL	1964-67 Chrome Switches .....	497.99 kit
PWK-64EL-BLACK	1964-67 Black Switches .....	498.99 kit
PWK-64EL-NOST	1964-67 Nostalgic Switches.....	588.99 kit
PWK-64EL-CRANK	1964-67 Crank Switches.....	562.99 kit
PWK-68EL	1968-72 Chrome Switches .....	497.99 kit
PWK-68EL-BLACK	1968-72 Black Switches .....	498.99 kit
PWK-68EL-NOST	1968-72 Nostalgic Switches .....	588.99 kit
PWK-68EL-CRANK	1968-72 Crank Switches.....	650.99 kit
PWK-73EL-CHROME	1973-77 Chrome Switches .....	511.99 kit
PWK-73EL-BLACK	1973-77 Black Switches .....	513.99 kit
PWK-73EL-NOST	1973-77 Nostalgic Switches.....	603.99 kit
PWK-73EL-CRANK	1973-77 Crank Switches.....	664.99 kit

#### G-body Cutlass, Monte Carlo, Regal, Grand Prix, El Camino

PWK-7887G-CHROME	1978-87 Front Chrome Switches.....	497.99 kit
PWK-7887G-BLACK	1978-87 Front Black Switches .....	498.99 kit
PWK-7887G-NOST	1978-87 Front Nostalgic Switches.....	588.99 kit
PWK-7887G-CRANK	1978-87 Front Crank Switches .....	618.99 kit

No Volume Discount. Not eligible for free shipping.



REG-1463C

### Window Regulators

Complete regulators with rollers.

#### Chevelle Front Manual

REG-1547L	1966-67 LH.....	79.99 ea.
REG-1547R	1966-67 RH .....	79.99 ea.
REG-1548L	1968 LH.....	82.99 ea.
REG-1548R	1968 RH.....	82.99 ea.
REG-69FL	1969 LH.....	89.99 ea.
REG-69FR	1969 RH.....	89.99 ea.
REG-70FL	1970-72 LH.....	79.99 ea.
REG-70FR	1970-72 RH .....	79.99 ea.

#### Chevelle Rear Manual

REG-R68L	1968-72 LH.....	69.99 ea.
REG-R68R	1968-72 RH .....	69.99 ea.

#### El Camino Front Manual

REG-1547L	1966-67 LH.....	79.99 ea.
REG-1547R	1966-67 RH .....	79.99 ea.
REG-1548L	1968-72 LH.....	82.99 ea.
REG-1548R	1968-72 RH .....	82.99 ea.

#### El Camino Front Power (with Motor)

REG-1463C	1968-72 LH.....	122.95 ea.
REG-1463B	1968-72 RH .....	122.95 ea.

#### Chevelle Front Power (with Motor)

REG-1463C	1968 LH .....	122.95 ea.
-----------	---------------	------------



RSC-6667A

### Front Door Window Lower Sash Channel Set

This is an OE quality reproduction Chevelle front door window lower sash channel which houses the window rollers to allow the window to lower and raise.

RSC-6667A	1966-67 Coupe.....	169.99 pr.
-----------	--------------------	------------



GDA-1485ZB

### 1970-1972 Chevelle Clear Door Glass Assemblies

Make replacing your door window easy with this complete assembly. Features all new clear glass, as well as new tracks. Installs just as original, and will save you hours messing with your window to get it right.

GDA-1485ZB	2 Door Coupe/Convertible LH .....	319.99 ea.
GDA-1485ZA	2 Door Coupe/Convertible RH.....	319.99 ea.

No Volume Discount. Ships Oversize.



GWM-22

### Power Window Motors

This is a high quality brand new power window motor. These fit front or rear windows.

GWM-22	1964-68 RH .....	99.99 ea.
GWM-23	1964-68 LH.....	99.99 ea.
GWM-22	1969-72 LH.....	99.99 ea.
GWM-23	1969-72 RH .....	99.99 ea.





### Power Window Grommets & Conduits

These are the correct conduits and grommets that run from the A-pillar to the door on cars with power windows and/or locks.

GHB-484	1964-67 All .....	59.99 pr.
GHB-488	1969-72 All .....	42.99 pr.
GHB-6481	1964-77 Grommet Only .....	9.99 ea.



### Door Window Hardware Kits

This convenient door window hardware kit includes all of the necessary hardware to rebuild the rollers, guides and bushings on the quarter window regulators. Made in USA.

RW-069-A	1969-72 Door .....	59.99 kit
RW-066-A-REAR	1966-67 1/4 Window .....	64.99 kit
RW-069-A-REAR	1968-72 1/4 Window .....	62.99 kit



### Rear 1/4 Window Lower Stop

GDS-708	1970-72 .....	13.99 ea.
---------	---------------	-----------



### Front Door Glass Side Stop

GDS-707	1970-72 .....	21.99 ea.
---------	---------------	-----------



### Front Door Glass Glide Plate

GGP-706	1970-72 .....	13.99 ea.
---------	---------------	-----------



### Door Glass Guide Screws

GGS-761	1968-72 (8 pc.) .....	2.99 kit
---------	-----------------------	----------



### Rear 1/4 Window Glass Side Stop

GGS-746	1968-72 .....	15.99 ea.
---------	---------------	-----------



### Rear Side Glass Glide Plate

GGP-707-REAR	1970-72 .....	13.99 ea.
--------------	---------------	-----------



### Door Glass Guide Plates & Felts

Correct front door glass guide plates.

GGP-1485Y	1968-72 Felt Covered Steel .....	26.99 pr.
GGP-7072	1970-72 Plastic .....	8.99 ea.
GGF-557	(4 pc.) Felt Only .....	8.99 set

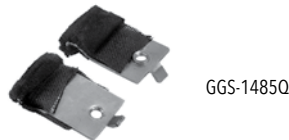

### Door Glass Stabilizers

Correct front door glass stabilizers.

GGS-1485Q	1970-72 .....	16.99 pr.
-----------	---------------	-----------



### Door Glass Stopper & Support

Correct front door glass stopper.

GDS-1485P	1970-72 Front .....	11.99 ea.
GDS-15231	1968-72 .....	13.99 ea.
GCS-1485N	1970-72 Front Support .....	11.99 ea.



### Quarter Window Roller Tension Spring

This commonly missing spring is used to keep tension on the window roller so that the window goes up and down smoothly.

GTS-177	1968-72 .....	5.99 ea.
---------	---------------	----------



### Window Rollers

Correct replacement window rollers.

WR-344	1964-65 Lower Rear 1/4 .....	9.99 ea.
WR-068	1964-65 Door .....	8.99 ea.
WR-343	1966-67 1/4 Window .....	9.99 ea.
WR-76	1968-72 Lower Rear 1/4 .....	8.95 ea.
WR-78	1969-72 Door .....	13.99 ea.
WR-065	1968-72 Lower Rear 1/4 .....	8.95 ea.



### Quarter Window Roller Assembly

Complete window roller assembly for rear quarter including center lower guide roller and threaded stud assembly.

GWR-060	1968-72 All Roller Assembly .....	16.99 ea.
GWR-060A	1968-72 Backing Washer .....	5.99 ea.
GWR-060B	1968-72 Nylon Bushing .....	6.99 ea.
GWR-060C	1968-72 Rubber Washer .....	1.99 ea.



### Quarter Window Stop

Correct reproduction of the quarter window stop, with the correct plastic coated end and correct bolt hole as original.

GGS-15232	1968-72 .....	12.99 ea.
-----------	---------------	-----------



### Door Glass Washers & Retainer

Plastic washer that is used to protect the door. Mounts between the glass and the metal fasteners within the door. 1.5 inch diameter.

GWR-15365	1964-77 w/ Step .....	3.99 ea.
GWR-15366	1964-77 .....	3.99 ea.
GWR-12660	1968-72 Retainer .....	6.99 pr.

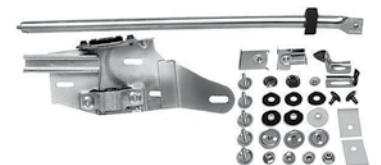

### 1970-72 Door Window Track And Hardware Kit

This convenient door window track & hardware kit is great for when you are changing out your door glass.

RW-70AL	All LH .....	189.99 set
RW-70AR	All RH .....	189.99 set

No Volume Discount.

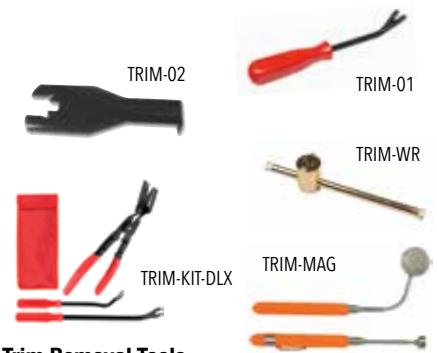

### Trim Removal Tools

TRIM-01	Door Panel Removal Tool .....	9.97 ea.
TRIM-02	Window Crank/Door Handle Removal .....	6.99 ea.
TRIM-WR	Window Roller Removal Tool .....	18.99 ea.
TRIM-MAG	Mirror & Magnet Kit 2pc .....	14.95 set
TRIM-KIT-DLX	Trim Removal Tools 3pc .....	29.99 ea.



JR-64K

**Junior Weatherstrip Kits**

Our most popular weatherstrip kit includes all of the basic soft trim components that commonly crack and wear out on your Chevelle. Included are (2) door opening weatherstrips, (2) roofrail weatherstrips (coupe only) and (1) trunk weatherstrip.

JR-64K	1964-65 Coupe.....	135.97 kit
JR-66K	1966-67 Coupe.....	135.98 kit
JR-68K	1968 Coupe.....	135.97 kit
JR-69K	1969-72 Coupe.....	127.98 kit
JR-64KV	1964-65 Convertible.....	76.48 kit
JR-66KV	1966-67 Convertible.....	76.49 kit
JR-68KV	1968 Convertible.....	76.48 kit
JR-69KV	1969-72 Convertible.....	71.98 kit
JR-73K	1973-77 All.....	167.98 kit

**BUY'N SAVE**  
WITH KITS

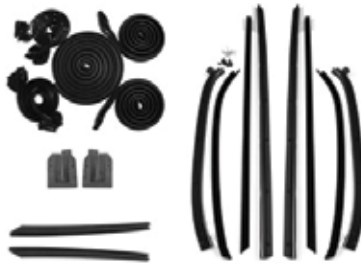

**Deluxe Weatherstrip Kits** JDX-70K8

This NEW and IMPROVED kit now includes OEM factory style window felts. This kit is great when you want to replace all of the major weatherstripping on your car. Included are (2) door weatherstrips, (2) roof rail weatherstrips (coupe only), (1) trunk weatherstrip, (1) OEM style windowfelt set, (2) door "U" rubbers and (2) quarter glass seals.

JDX-64K8	1964 Coupe (8 pc.) Felts .....	297.45 kit
JDX-65K8	1965 Coupe (8 pc.) Felts .....	271.95 kit
JDX-66K8	1966-67 Coupe (8 pc.) Felts .....	314.42 kit
JDX-68K4	1968 Coupe (4 pc.) Felts .....	280.45 kit
JDX-69K4	1969 Coupe (4 pc.) Felts .....	280.45 kit
JDX-70K4	1970-72 Coupe (4 pc.) Felts .....	280.45 kit
JDX-68K8	1968 Coupe (8 pc.) Felts .....	322.95 kit
JDX-69K8	1969 Coupe (8 pc.) Felts .....	297.45 kit
JDX-70K8	1970-72 Coupe (8 pc.) Felts .....	297.45 kit
JDX-64KV8	1964 Convertible (8 pc.) Felts .....	237.92 kit
JDX-65KV8	1965 Convertible (8 pc.) Felts .....	212.42 kit
JDX-66KV8	1966-67 Convertible (8 pc.) Felts .....	254.93 kit
JDX-68KV4	1968 Convertible (4 pc.) Felts .....	220.96 kit
JDX-68KV8	1968 Convertible (8 pc.) Felts .....	263.46 kit
JDX-69KV4	1969 Convertible (4 pc.) Felts .....	220.96 kit
JDX-69KV8	1969 Convertible (8 pc.) Felts .....	246.46 kit
JDX-70KV4	1970-72 Convertible (4 pc.) Felts .....	220.96 kit
JDX-70KV8	1970-72 Convertible (8 pc.) Felts .....	237.96 kit



**Door Opening Weatherstrip** JSS-5003

This brand new state of the art door weatherstrip features correct extruded rubber with correct molded ends and push in clips just like original.

JSS-LM12N	1964-65 2Dr Wagon .....	88.99 pr.
JSS-5003	1964-65 2Dr Coupe/Convertible.....	69.99 pr.
JSS-5001	1964-65 2Dr Sedan.....	69.99 pr.
JSS-LM12P	1964-67 4Dr Sedan/Wagon, Fr .....	69.99 pr.
JSS-LM12Q	1964-67 4Dr Sedan, Rear.....	79.99 pr.
JSS-LM12W	1964-67 4Dr Wagon, Rear .....	88.99 pr.
JSS-5000	1966-67 2Dr Coupe/Convertible.....	69.99 pr.
JSS-LM12R	1966-67 2Dr Sedan.....	69.99 pr.
JSS-LM12W	1966-67 4Dr Hardtop, Front.....	69.99 pr.
JSS-LM12X	1966-67 4Dr Hardtop, Rear.....	69.99 pr.
JSS-5011	1968 2Dr Coupe/Convertible.....	69.99 pr.
JSS-5022	1969-72 2Dr Coupe/Convertible.....	84.99 pr.
JSS-LM12S	1968-69 2Dr Sedan.....	69.99 pr.
JSS-12T	1968-72 4Dr Sedan/Wagon, Fr .....	79.99 pr.
JSS-12U	1968-72 4Dr Sedan/Wagon, Rear ...	74.99 pr.
JSS-12Y	1973-77 2Dr Coupe .....	79.99 pr.
JSS-12Z	1973-77 4Dr Sedan, Front.....	124.99 pr.
JSS-E64	1964-65 El Camino .....	62.99 pr.
JSS-E66	1966-67 El Camino .....	62.99 pr.
JSS-E68	1968-72 El Camino .....	62.99 pr.
JSS-16JM	1978-81 Monte Carlo 2Dr .....	99.99 pr.
JSS-16JG	1982-88 Monte Carlo 2Dr .....	99.99 pr.
JSS-16JE	1978-88 El Camino, Malibu 2Dr .....	99.99 pr.
JSS-16S	1978-88 G-Body 4Dr Front .....	99.99 pr.
JSS-16SR	1978-88 G-Body 4Dr Rear Except Wagon .....	99.99 pr.
JSS-16SW	1978-88 G-Body 4Dr Rear Wagon Only .....	99.99 pr.



JSS-5090

**Convertible Top Weatherstrip Kits**

New state of the art Metro convertible top weatherstrip kit featuring steel frames with molded rubber, correct seams and extension flaps. Header seal has correct pins and molded corners. Made in USA.

JSS-5090	1964-65.....	239.99 kit
JSS-5092	1966-67.....	299.99 kit
JSS-5093	1968-72.....	314.99 kit



JSK-45K

**Rubber Stopper Kits**

Complete set of rubber stoppers including doors, trunk lid, hood, side of hood and fuel tank door.

JSK-45K	1964-65 Chevelle.....	19.99 kit
JSK-E64	1964-65 El Camino.....	19.99 kit
JSK-66K	1966 Chevelle.....	19.99 kit
JSK-E66	1966 El Camino .....	19.99 kit
JSK-67K	1967 Chevelle.....	19.99 kit
JSK-E67	1967 El Camino .....	19.99 kit
JSK-E82	1968-72 El Camino .....	19.99 kit
JSK-82K	1968-72 Chevelle.....	19.99 kit



JSS-4579

**Roof Rail Weatherstrip Guides**

Correct rear guides for your roof rail weatherstrip.

JSS-4579	1969-72 All .....	16.99 pr.
----------	-------------------	-----------



JSS-5005

**Roof Rail Weatherstrip**

Correct extruded rubber that seals the roof line of the car in from the elements.

JSS-5005	1964-65 Coupe .....	69.99 pr.
JSS-5009	1966-67 Coupe .....	69.99 pr.
JSS-5006	1966-67 4 Door Hardtop.....	89.99 pr.
JSS-5012	1968 Coupe.....	69.99 pr.
JSS-5024	1969-72 Coupe .....	74.99 pr.
JSS-5019	1973-77 Chevelle 2Dr.....	119.99 pr.
JSS-5019-4D	1973-77 Chevelle 4Dr.....	119.99 pr.
JSS-5019E	1973-77 El Camino .....	69.99 pr.
JSS-5020M	1978-88 Monte Carlo 2Dr .....	109.99 pr.
JSS-5020	1978-87 Malibu, Cut, Lemans 2Dr .....	115.99 pr.
JSS-5020E	1978-87 El Camino .....	99.99 pr.

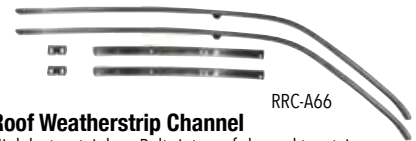

RRC-A66

**Roof Weatherstrip Channel**

High luster stainless. Bolts into roof channel to retain weatherstrip. Includes blow out clips.

RRC-A64	1964-65 6pc.....	209.99 kit
RRC-A66	1966-67 6pc.....	209.99 kit
RRC-A68	1968 6pc.....	209.99 kit
RRC-A69	1969 6pc.....	209.99 kit
RRC-70A	1970-72 6pc.....	219.99 kit

*This item Ships Oversize.*



BRR-221

### Roof Rail Weatherstrip Screws

Accurate reproduction of original roof rail weatherstrip screws. Correct head diameter and profile. Screws attach coupe roof rail weatherstrip channel, pillars and convertible top weatherstrip to frame.

BRR-221 1964-72 (36 pc.).....30.99 kit



### Quarter Glass Seals

JSS-5109

Correct rubber seal which attaches to the quarter window and seals the front and rear windows. Available in high quality molded rubber or steel core with rubber coating as factory.

JSS-5109	1964-65 Rubber .....	9.99 pr.
JSS-5111	1966-67 Rubber .....	9.95 pr.
JSS-675C	1966-67 Steel Core.....	29.99 pr.
JSS-2525	1968-72 Steel Core.....	18.99 pr.
JQF-0370	1978-87 El Cam Rubber & Felt w/ Bead .....	46.99 pr.

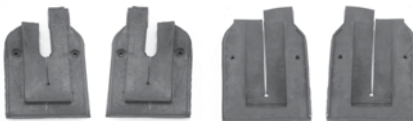

JSS-5113

JSS-5114

JSS-5115



### Door Jamb U Rubbers

Correct steel core rubber.

JSS-5113	1964-65 All .....	19.99 pr.
JSS-5114	1966-67 All .....	19.99 pr.
JSS-5115	1968-72 All .....	19.99 pr.

JSS-7011



### Vent Channel Run

Correct rubber flocked weatherstrip that runs vertically in the vent frame.

JSS-7013	1964-65 All .....	24.99 pr.
JSS-7012	1966-67 All .....	24.99 pr.
JSS-7011	1968 Chevelle.....	28.99 pr.

JSS-5102



### Vent Window Seals

Correct vent window weatherstrip.

JSS-5102	1964-65 All .....	79.99 pr.
JSS-5103	1966-67 Coupe/Cvt.....	79.99 pr.
JSS-5104	1968 Coupe/Convertible .....	89.99 pr.
JV-E47	1964-67 El Camino* .....	99.99 pr.
JV-E82	1968-72 El Camino* .....	99.99 pr.

\*El Camino also fits Chevelle sedan and wagon.

JSS-5162

### Steering Column Seal

Correct neoprene seal for firewall.

JSS-5162	1964-67 All .....	5.99 ea.
JSS-5151	1968-72 All .....	6.99 ea.
JSS-115	1978-81 Monte Carlo .....	7.99 ea.



JDG-E3



### Door Glass Weatherstrip

Correct felt material that door glass seals into (runs from inside of door to top of vent). Does one car.

JDG-E3	1964-72 El Camino .....	39.99 ea.
--------	-------------------------	-----------



JHC-813

### "A" Arm Dust Shields

Correct die stamped material that seals the engine compartment. Mounts to inner fender wells complete with staples.

JHC-810	1964-65 All .....	17.99 pr.
JHC-812	1966 All .....	17.99 pr.
JHC-813	1967 All .....	17.99 pr.
JHC-814	1968-72 Steel Fenders.....	17.99 pr.
JHC-815	1968-72 Plastic Fenders .....	17.99 pr.
JHC-330	1973-77 All .....	17.99 pr.

JSS-309



### Trunk Weatherstrip

Correct molded trunk weatherstrip.

JSS-309	1964-77 Chevelle .....	19.99 ea.
JSS-T7377	1973-77 All .....	24.99 ea.
JSS-101	1978-88 Monte Carlo .....	45.99 ea.

JSS-TG14



### Tailgate Seals

Constructed of soft, closed-cell EDPM sponge rubber so you don't have to slam it shut.

JSS-TG14	1964-67 Wagon.....	82.99 ea.
JSS-TG16	1968-72 Wagon.....	109.99 ea.
JSS-TG15	1973-77 Wagon.....	74.99 ea.
JTS-1740	1978-87 El Camino Tailgate.....	35.99 ea.



JFP-68A2



JFP-68A1

### Firewall Plug

Correct plug used to fill extra hole in the firewall at the throttle cable location on all TH400 and manual transmission cars.

JFP-68A1	1968-72 1st Design Triangular .....	13.99 ea.
JFP-68A2	1968-72 2nd Design Square .....	13.99 ea.

JSS-0911



### Convertible Header Seal

This seal features correct molded ends just as original GM.

JSS-0911	1966-67 Convertible.....	59.99 ea.
JSS-091	1968-72 Convertible.....	59.99 ea.

JSS-5039

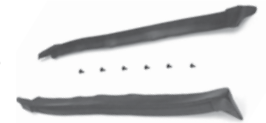

### Pillar Post Weatherstrip

Correct heavy duty molded rubber that runs vertically on the pillar posts.

JSS-5039	1964-65 Convertible.....	62.99 pr.
JSS-5040	1966-67 Convertible.....	69.99 pr.
JSS-5041	1968 Convertible.....	69.99 pr.
JSS-5042	1969-72 Convertible.....	59.99 pr.

JQS-66



### Quarter Panel Extension Seal

Correct seal between extension and 1/4 panel.

JQS-66	1966-67 Chevelle .....	9.99 pr.
JQS-68	1968-69 Chevelle .....	9.99 pr.

JFS-68A



### Inner Fender to Cowl Seals

Correct molded seals which attach to the inner fenders.

JFS-68A	1968-72 .....	16.99 pr.
---------	---------------	-----------

JBS-65



### Rear Bumper to Body Seal

Correct heavy die stamped rubber seal.

JBS-65	1964-65 Chevelle (4 pc.) .....	21.99 kit
JBS-67	1966-67 Chevelle .....	9.99 pr.
JBS-E68	1968-72 El Camino.....	18.99 ea.

JSS-5023



### 1970-72 Vertical Quarter Glass Seals

Correct quarter glass seals which run vertically on the rear edges of the quarter windows.

JSS-5023	1970-72 .....	44.99 pr.
----------	---------------	-----------



BRR-1VA

BRR-1VA-B

### 1968-1972 Chevelle Convertible Top Weatherstrip Hold Down Screw Kits

These are the correct screws used to hold the weatherstrip seals to the top frame on convertibles. Please compare to your originals to make sure the colors match before ordering.

BRR-1VA-B	1968-72 Black Set.....	11.99 kit
BRR-1VA	1968-72 Silver Set .....	12.99 kit



CH181A

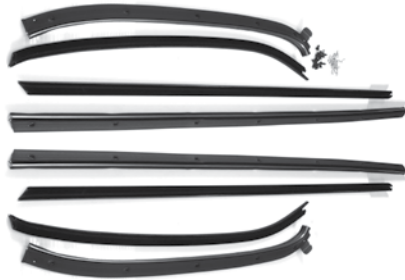

CH194A



CH183A  
Detail

**Outer Window Felt Kits**

These reproduction window felts feature correct stainless round beads with flocked rubber sealing strips. All include the correct anti-rattle bumpers attached.

**Chevelle & Wagon**

CH175A	1964-65 Coupe (4 pc.).....	109.99 kit
CH176A	1964-65 Convertible (4 pc.).....	109.99 kit
CH177A	1966-67 Coupe (4 pc.).....	129.99 kit
CH178A	1966-67 Convertible (4 pc.).....	129.99 kit
CH209A	1966-67 2 Door Sedan (4 pc.).....	159.99 kit
CH179A	1968 Coupe (4 pc.).....	129.99 kit
CH180A	1968 Convertible (4 pc.).....	129.99 kit
CH305A	1968 Station Wagon (4 pc.).....	149.99 kit
CH181A	1969 Coupe (4 pc.).....	129.99 kit
CH182A	1969 Convertible (4 pc.).....	129.99 kit
CH308A	1969 4 Door Hardtop (4 pc.).....	106.99 kit
CH183A	1970-72 Coupe (4 pc.).....	129.99 kit
CH184A	1970-72 Convertible (4 pc.).....	129.99 kit
CH306A	1968-72 Wagon Tailgate (1 pc.).....	69.99 kit
MT121A	1981-88 Monte Carlo 2 Door w/ Special.....	Molding (2 pc.).....79.99 kit
MT122A	1981-88 Monte Carlo 2 Door w/o Special.....	Molding (2 pc.).....79.99 kit
CH314A	1978-83 Malibu 4 Door Wagon (4 pc.).....	199.99 kit
<b>El Camino</b>		
CH212A	1964 El Camino (2 pc.).....	89.99 pr.
CH213A	1965 El Camino (2 pc.).....	89.99 pr.
CH214A	1966-67 El Camino (2 pc.).....	89.99 pr.
CH215A	1968-72 El Camino (2 pc.).....	89.99 kit

**Complete Window Felt Kits**

These reproduction window felts feature correct stainless round beads with flocked rubber sealing strips. All include the correct anti-rattle bumpers attached.

**Chevelle & Wagon**

CH128A	1964 Coupe (8 pc.).....	159.99 kit
CH129A	1964 Convertible (8 pc.).....	159.99 kit
CH131A	1964 2 Dr Sedan (8 pc.).....	129.99 kit
CH130A	1964 2 Dr Wagon (4 pc.).....	94.99 kit
CH132A	1964 4 Dr Sedan (8 pc.).....	129.99 kit
CH133A	1965 Coupe (8 pc.).....	129.99 kit
CH134A	1965 Convertible (8 pc.).....	129.99 kit
CH136A	1965 2 Dr Sedan (8 pc.).....	129.99 kit
CH135A	1965 2 Dr Wagon (4 pc.).....	94.99 kit
CH137A	1965 4 Dr Sedan (8 pc.).....	129.99 kit
CH185A	1966-67 Coupe (8 pc.).....	179.99 kit
CH186A	1966-67 Convertible (8 pc.).....	179.99 kit
CH188A	1966-67 2 Dr Sedan (8 pc.).....	199.99 kit
CH269A	1966-67 4 Dr Hardtop (8 pc.).....	219.99 kit
CH189A	1966-67 4 Dr Sedan (8 pc.).....	199.99 kit
CH303A	1964-67 Wagon Tailgate (2 pc.).....	99.99 kit
CH190A	1968 Coupe (8 pc.).....	179.99 kit
CH191A	1968 Convertible (8 pc.).....	179.99 kit
CH193A	1968 2 Dr Sedan (8 pc.).....	199.99 kit
CH194A	1969 Coupe (8 pc.).....	149.99 kit
CH195A	1969 Convertible (8 pc.).....	159.99 kit

CH196A	1969 2 Dr Sedan (8 pc.).....	199.99 kit
CH238A	1969 4 Dr Sedan (8 pc.).....	199.99 kit
CH304A	1969-72 Concourse 4 Dr Wagon (6 pc.).....	299.99 kit
CH197A	1970-72 Coupe (8 pc.).....	149.99 kit
CH198A	1970-72 Convertible (8 pc.).....	149.99 kit
MT126A	1978-80 Monte Carlo 2 Dr w/ Special Molding (4 pc.).....	149.99 kit
MT110A	1978-79 Monte Carlo 2 Dr w/o Special Molding (4 pc.).....	149.99 kit
MT111A	1981-88 Monte Carlo 2 Dr w/ Special Molding (4 pc.).....	149.99 kit
MT112A	1981-88 Monte Carlo 2 Dr w/o Special Molding (4 pc.).....	149.99 kit
CH208R	1978-81 Malibu 2 Dr (6 pc.).....	189.99 kit
CH314A	1978-83 Malibu 4 Dr Wagon (8 pc.).....	199.99 kit
<b>El Camino</b>		
CH130A	1964 El Camino (4 pc.).....	94.99 kit
CH135A	1965 El Camino (4 pc.).....	94.99 kit
CH187A	1966-67 El Camino (4 pc.).....	149.99 kit
CH192A	1968-72 El Camino (4 pc.).....	119.99 kit

**Replacement Style Window Felt Kits**

These replacement style felts feature a flat chrome bead vs the originals which have a round rolled bead.

**Complete Replacement Style Felt Kits Chevelle & Wagon**

CH245R	1964 Coupe (8 pc.).....	149.99 kit
CH256R	1964 Convertible (8 pc.).....	149.99 kit
CH268R	1965 2 Door Hardtop (8 pc.).....	129.99 kit
CH258R	1965 Convertible (8 pc.).....	149.99 kit
CH216R	1964-65 2 Door Wagon Tailgate (2 pc.).....	69.99 kit
CH138R	1966-67 2 Door Hardtop (8 pc.).....	139.99 kit
CH139R	1966-67 Convertible (8 pc.).....	139.99 kit
CH141R	1966-67 2 Door Sedan (8 pc.).....	139.99 kit
CH142R	1966-67 4 Door Sedan (8 pc.).....	139.99 kit
CH143R	1968 Coupe (8 pc.).....	149.99 kit
CH144R	1968 Convertible (8 pc.).....	149.99 kit
CH146R	1968 2 Door Sedan (8 pc.).....	149.99 kit
CH147R	1969 Coupe (8 pc.).....	149.99 kit
CH148R	1969 Convertible (8 pc.).....	149.99 kit
CH149R	1969 2 Door Sedan (8 pc.).....	149.99 kit

CH150R	1970-72 Coupe (8 pc.).....	149.99 kit
CH151R	1970-72 Convertible (8 pc.).....	149.99 kit
<b>El Camino</b>		
CH264R	1964 El Camino (4 pc.).....	99.99 kit
CH265R	1965 El Camino (4 pc.).....	99.99 kit
CH140R	1966-67 El Camino (4 pc.).....	94.99 kit
CH298R	1978-87 El Camino (4 pc.).....	139.99 kit
<b>Outers Only Chevelle</b>		
CH210R	1966-67 2 Door Hardtop (4 pc.).....	99.99 kit
CH243R	1969 Coupe (4 pc.).....	109.99 kit
CH244R	1970-72 Coupe (4 pc.).....	81.99 kit
CH211R	1970-72 Convertible (4 pc.).....	99.99 kit
<b>El Camino</b>		
CH145R	1968-72 El Camino (4 pc.).....	99.99 kit
CH309R	1978-87 El Camino (2 pc.).....	74.99 kit



Replacement Style Flat Bead



OEM Style Round





### Hood to Cowl Seal

Correct style rubber seals which mount on the rear hood edge and top of cowl to seal in the engine compartment.

JSS-5070	1964-67 .....	12.99 ea.
JSS-0570	1978-88 All .....	29.99 ea.
JSS-5075	1968-72 .....	13.99 ea.
JSS-5071	1968-72 Rear On Hood .....	12.99 ea.

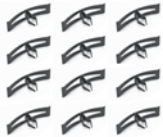

JCS-5077

### Hood to Cowl Seal Clips

Correct clips for attaching seal to top of cowl.

JCS-5075	1968-72 Plastic (8pc) .....	6.95 kit
JCS-5077	1968-72 Steel (12pc) .....	12.99 kit

*Steel is correct for 1968-69 and plastic is correct for 1970-72.*

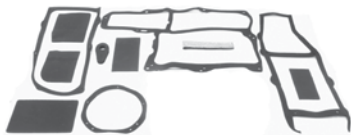

JHC-7264

### Heater Box Seal Kit

Correct die stamped kit contains all inner and outer box seals.

JHC-7364	1964-72 w/o AC .....	36.99 ea.
JHC-7264	1964-67 w/ AC .....	34.99 ea.
JHC-7468	1968-72 w/ AC .....	34.99 ea.

### American Autowire Classic Update Series Kits

Classic Update complete wiring kits are made for the restoration enthusiast who wants some modern amenities in their classic vehicle. These kits include everything you need to modernize your classic vehicle: Headlight, Dimmer and Ignition Switches; Boots, Tubes and Grommets; Fuses, Relays and Flashers; Original Connectors, Terminals and Disconnects.

#### 1964-72 Chevelle

- Replacement headlight switch with internal 30 amp circuit breaker included. Retention collar nut, adjustable length shaft and custom knob are also included.
  - Standard turn signal flasher, hazard flasher and horn relay mounted on fuse panel.
  - Fuse box designed to fit in original location. All required hardware supplied. New ATO fuse allows easy fuse and circuit breaker accessibility. Harness is laid out and formed to allow for nearly all aftermarket accessories such as; gauge packages, wiper systems, heat and air conditioning systems, etc.
  - Original switch connector bodies! (Exclusive to American Autowire)
  - Original Dash Panel instrument cluster connector.
  - Steering column connectors can plug directly into most aftermarket steering columns or stock 1968-1969 GM columns that use stock GM turn signal switches.
  - Under dash courtesy lamps for use in addition to your original dome/interior lighting.
  - Instrument Cluster wiring has a "cluster harness disconnect" system for easy service and assembly. Original terminals and connectors (another American Autowire exclusive) are provided for stock cluster connections. Connects into most popular aftermarket gauges such as AUTOMETER, CLASSIC INSTRUMENTS, DAKOTA DIGITAL, STEWART WARNER, VDO and others.
  - Rear body harness assembly plugs into the main harness in the stock location. Longer leads allow for stock/custom routing of the wires. Rear body wiring has backup light lead wires with correct lamp sockets, stop and tail light lead wires with correct lamp sockets, terminals to mate with the license plate connection wire, side marker lead and ground wires with lamp sockets and fuel tank sender wire with trunk grommet and tank connection.
  - GM bulkhead connectors for the engine and front light wiring (another American Autowire exclusive) and allow for easy installation with original or custom routing.
  - Engine wiring includes connectors for original points type as well as H.E.I. distributors. Power and Tach connectors supplied for GM H.E.I. distributors. Alternator connectors are supplied for GM "SI" series internally regulated alternators. GM "CS" series alternator adapter is available separately.
  - Original style light sockets, switch body connectors, terminals, etc.
  - Front lighting includes extra long leads that can be routed for stock or optional appearances.
- All headlight, parking and directional light connectors (lamp socket pigtails are also provided for 1971-72 applications) and terminals are provided along with a switched trigger wire for an electric fan relay (usually recommended with AC).

500981	1964-67 .....	674.99 ea.
510158	1968-69 .....	719.99 ea.
510105	1970-72 .....	773.99 ea.

### BPO-BUMPER-REAR



### Hood Bumpers Rear

These slide into a groove on both sides of the hood and rest on the cowl when the hood is closed.

BPO-BUMPER-REAR	1968-72 .....	4.95 pr.
-----------------	---------------	----------



DSB-83

### Steering Shaft Boot

This hard to find rubber boot covers the steering column knuckle.

DSB-83	1968-72 All .....	34.99 ea.
DBR-647	1964-77 Retainer .....	8.99 ea.



JSK-70K

### SS Rear of Hood Seal

Correct rear of hood seal for all SS cars. Pre-cut with clips included!

JSK-70K	1970-72 SS .....	14.95 kit
---------	------------------	-----------



JS-5500

### Convertible Top Frame to Body Seal

Hard to find seals mount to the body where the top frame enters.

JS-5500	1964-67 .....	39.99 pr.
JS-5505	1968-72 .....	69.99 pr.



JHC68

### Paint Seal Kit

This kit is a must for all of those partial or full restorations!

JHC64	1964 Chevelle .....	22.99 kit
JHE64	1964 El Camino .....	22.99 kit
JHC65	1965 Chevelle .....	22.99 kit
JHE65	1965 El Camino .....	22.99 kit
JHC66	1966 Chevelle .....	22.99 kit
JHE66	1966 El Camino .....	22.99 kit
JHC67	1967 Chevelle .....	22.99 kit
JHE67	1967 El Camino .....	22.99 kit
JHC68	1968 Chevelle .....	22.99 kit
JHE68	1968 El Camino .....	22.99 kit
JHC69	1969 Chevelle .....	22.99 kit
JHE69	1969 El Camino .....	22.99 kit
JHC70	1970 Chevelle .....	22.99 kit
JHE70	1970 El Camino .....	28.99 kit
JHC71	1971-72 Chevelle .....	22.99 kit
JHE71	1971-72 El Camino .....	22.99 kit



### El Camino & Station Wagon Add-On Kits

Add-on for your El Camino or Station Wagon. Provides the necessary rear body wiring.

500999	1964-67 .....	45.99 kit
510166	1968-72 .....	51.99 kit

*Note: Does not support ammeters.*

*If you have a station wagon or El Camino you will need 510166 add-on kit.*

*No Volume Discount.*



**American Autowire Highway 22 Wiring Kit**

The Highway 22

Complete Modular wiring system kit includes all the necessary wiring for headlights including: a three position headlight switch; a 40 amp electric fan or fuel pump relay; heavy duty power and accessory expansion; micro-relays for horns and turn signals; an accessory harness for radio, electric wipers, heater, air conditioning, fuel pump and interior lighting. This kit also contains a floor mounted dimmer switch; an ignition switch that has been designed for either dash or column mounting and includes all the connectors and terminals. The Highway 22 was designed to promote complete mounting flexibility and creativity in specialty electrical systems. These kits are perfect if you plan to do a LS/EFI swap as this kit includes dedicated battery and ignition circuits for electronic fuel injection (EFI).

510760 1964-75 All Universal GM..... 557.99 kit  
No Volume Discount.

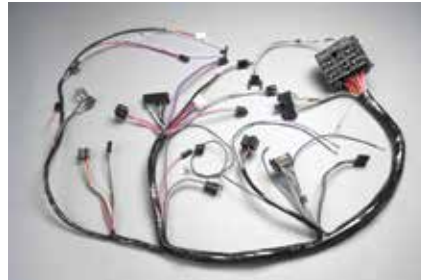

**Dash Harness Classic Auto Fuse Series**

Our new Classic Auto Fuse Series dash harnesses allow you to maintain the easy plug and play function of original factory type harnesses, while converting the entire fuse block to an Auto Fuse Series (ATO Type) fuse block. This gives you the flexibility to add additional power circuits without the installation headaches normally associated with this type of fuse box conversion. There is no cutting or modifying of any sort. Just plug it in and turn it on. It is completely compatible with the other original harnesses in your car.

39404	1968 w/ Warning Lights .....	615.99 ea.
39405	1968 w/ Gauges .....	615.99 ea.
39406	1969 w/ Warning Lights .....	615.99 ea.
39407	1969 w/ Warning Lights and Air Conditioning .....	615.99 ea.
39408	1969 w/ Gauges .....	615.99 ea.
39409	1969 w/ Gauges and Air Conditioning .....	615.99 ea.
39410	1970 Super Sport Round Gauges w/ Warning Lights .....	615.99 ea.
39377	1970 Super Sport Round Gauges w/ Gauges .....	615.99 ea.
39412	1970 Sweep Style Speedometer .....	615.99 ea.
39413	1971 Super Sport Round Gauges w/ Warning Lights .....	615.99 ea.
39414	1971 Super Sport Round Gauges w/ Gauges .....	615.99 ea.
39415	1971 Sweep Style Speedometer .....	615.99 ea.
39416	1972 Super Sport Round Gauges w/ Warning Lights .....	615.99 ea.
39417	1972 Super Sport Round Gauges w/ Gauges .....	615.99 ea.
39418	1972 Super Sport Round Gauges w/ Warning Lights & Seatbelt Light .....	615.99 ea.
39419	1972 Super Sport Round Gauges w/ Gauges & Seatbelt Light .....	615.99 ea.
39420	1971 Sweep Style Speedometer .....	615.99 ea.
39421	1972 Sweep Style Speedometer & Seatbelt Light .....	615.99 ea.

No Volume Discount.



**Spare Fuse Power Wiring Extension**

Used to add the functionality of the three extra spare fuses if desired.

39383 All ..... 34.99 ea.



**Accessory Terminal & Connector Kit**

Used to access the front of the ATO fuse block accessory ports, while maintaining the indexing capability of the cavities on the fuse block.

39384 All ..... 16.99 ea.



**Glass Fuse Series Accessory Adapter Kit**

Converts old accessory style indexed connectors to new ATO style connectors so you can plug your old accessories into your ATO fusebox with no modifications to connectors.

39385 All ..... 37.99 ea.



**Fuse & Flasher Kit**

Includes (2) flashers, (1) complete set of ATO fuses, plus (1) spare of each amperage.

39463	1970 .....	24.99 ea.
39464	1968 .....	24.99 ea.
39465	1972 .....	24.99 ea.
39466	1969,1971 .....	24.99 ea.



**Wiring Harnesses**

When you are looking to restore your electrical system, look no further than Ground Up Motor Sports! All of our harnesses are hand assembled in the USA and are guaranteed exactly as original. Our harnesses always match the factory color code and gauge sizes using correct connectors, terminals and non-adhesive and cloth tape. Our restoration harnesses are simply the best in the industry.



**AC Harness**

04940	1964 All .....	149.99 ea.
04895	1965-66 All .....	128.99 ea.
10770	1967 All .....	141.99 ea.
11880	1968 All .....	148.99 ea.
12955	1969 All .....	148.99 ea.
14965	1970 All .....	127.99 ea.
15440	1971 All .....	148.99 ea.
16465	1972 All .....	146.99 ea.

**Clock Harness**

18275	1964-65 Top of Dash .....	23.99 ea.
01365	1968-69 Dash Mounted .....	25.99 ea.
18600	1970-72 Dash Mounted* .....	22.99 ea.

\*For sweep style speedometer.

**Console Ext Harness**

09665	1966 Auto Transmission .....	43.99 ea.
09670	1966 All for Clock & Courtesy .....	30.99 ea.
10590	1967 Auto Transmission .....	38.99 ea.
11475	1967 All for Clock & Courtesy .....	30.99 ea.
11930	1968 Auto Transmission .....	54.99 ea.
28190	1969-72 Auto Transmission .....	51.99 ea.
11920	1968-72 Manual Transmission .....	25.99 ea.

**Console Harness**

04985	1964 Auto .....	73.99 ea.
04990	1964-65 4 Speed .....	29.99 ea.
05910	1965 Auto .....	78.99 ea.
09680	1966 Auto .....	60.99 ea.
09675	1966 4 Speed .....	60.99 ea.
11485	1967 Auto, Clock, Courtesy .....	61.99 ea.
11480	1967 4 Speed, Clock, Courtesy .....	55.99 ea.
11925	1968-72 Auto .....	54.99 ea.
11915	1968-72 4 Speed .....	33.99 ea.

**Courtesy Lamp Harness**

07130	1964 Dome El Camino*	32.99 ea.
06880	1964 Dome Sedan	31.99 ea.
06885	1964 Dome Coupe	24.99 ea.
07100	1964 Dome Wagon	31.99 ea.
28450	1964-65 Dash All	43.99 ea.
07840	1965-67 Dome El Camino*	25.99 ea.
07575	1965 Dome Sedan	36.99 ea.
07580	1965 Dome Coupe	29.99 ea.
07835	1965-67 Dome Wagon	20.60 ea.
17590	1966-67 Dome Sedan	26.99 ea.
17600	1966-67 Coupe	26.99 ea.
28490	1966-67 Dash All	38.99 ea.
30205	1968-72 Dome All	34.99 ea.
28530	1968 Dash All	40.99 ea.
28950	1969-70 Dash All	41.99 ea.
15295	1971-72 Dash All	42.99 ea.

\*You must reuse your original connector.

**Cowl Induction Harness**

Reproduction of original GM.

AMH-8922	1970-72	58.99 ea.
----------	---------	-----------

**Cruise Control Harness**

10775	1967	77.99 ea.
11885	1968	81.99 ea.
13185	1969-72	80.99 ea.

**Dash Harness**

Complete with fuse box.

05780	1964 w/ Warning Lights	529.99 ea.
05785	1964 Chevelle w/ Gauges	529.99 ea.
05955	1965 w/ Warning Lights	529.99 ea.
05960	1965 Chevelle w/ Gauges	529.99 ea.
17605	1966 w/o Gauges	599.99 ea.
09455	1966 Auto Column	529.99 ea.
10200	1966 Column w/ AC	529.99 ea.
09460	1966 w/ Gauges	529.99 ea.
10205	1966 w/ Gauges & AC	529.99 ea.
10540	1967 w/ Warning Lights	529.99 ea.
10535	1967 w/ Gauges	529.99 ea.
11760	1968 w/ Warning Lights	542.99 ea.
11780	1968 w/ Gauges	542.99 ea.
17410	1969 w/ Warning Lights	542.99 ea.
12935	1969 w/ Lights & AC	542.99 ea.
12980	1969 w/ Gauges	542.99 ea.
12985	1969 Gauges & AC	542.99 ea.
15075	1970 SS w/ W. Lights	542.99 ea.
15065	1970 SS w/ Gauges	542.99 ea.
14720	1970 Sweep Style	542.99 ea.
15265	1971 SS w/ W. Lights	542.99 ea.
15270	1971 SS w/ Gauges	575.99 ea.
16290	1971 Sweep Style	574.99 ea.
16420	1972 SS w/ W. Lights	606.99 ea.
16425	1972 SS w/ Gauges	574.99 ea.
17405	1972 Sweep Style	621.99 ea.
15490	1973 Lower Half w/ Gauges*	665.99 ea.

(Includes fuse box.)

15495	1973 Upper Half w/ Gauges*	345.99 ea.
-------	----------------------------	------------

\*Requires use of original harness.

20740	1974 w/ Gauges	690.99 ea.
-------	----------------	------------

No Volume Discount.

**Engine Harness**

17750	1964 6 Cyl W. Lights	135.99 ea.
33115	1964 6 Cyl Gauges	135.99 ea.
05730	1964 V8 Warning Lights	127.99 ea.
05735	1964 V8 Gauges	127.99 ea.
05965	1965 6 Cyl W. Lights	129.99 ea.
05975	1965 6 Cyl Gauges	132.99 ea.
05970	1965 V8 Warning Lights	127.99 ea.
17610	1965 SB Gauges	127.99 ea.
06140	1965 396 Gauges	127.99 ea.
05965	1966 6 Cyl W. Lights	129.99 ea.
14020	1966 6 Cyl W. Lights Int AC*	180.99 ea.
05975	1966 6 Cyl Gauges	132.99 ea.
14020	1966 6 Cyl Gauges Int AC*	180.99 ea.
05970	1966 SB W. Lights	127.99 ea.
09510	1966 SB W. Lights Int AC*	170.99 ea.
17610	1966 SB Gauges	127.99 ea.
10440	1966 SB Gauges Int AC*	180.99 ea.
10605	1966 327/350 SHP	137.99 ea.
10610	1966 327/350 SHP Int AC*	186.99 ea.
17385	1966 327 SHP Gauges	126.99 ea.
18605	1966 327 SHP Ggs Int AC*	186.99 ea.
09630	1966 396 W. Lights	127.99 ea.
09515	1966 396 W. Lights Int AC*	187.99 ea.
10430	1966 396 Gauges	127.99 ea.
10450	1966 396 Gauges Int AC*	187.99 ea.

\*with integrated AC. AC wiring is incorporated into the dash and engine harnesses.

11255	1967 6 Cyl W. Lights	146.99 ea.
11280	1967 V8 Warning Lights	130.99 ea.
11285	1967 V8 Gauges	130.99 ea.
10565	1967 396 W. Lights	126.99 ea.
10570	1967 396 Gauges	126.99 ea.
14015	1968 6 Cyl W. Lights	119.99 ea.
12005	1968 6 Cyl W. Lts Idle Stop	119.99 ea.
11805	1968 V8 Warning Lights	130.99 ea.
12070	1968 396 Warning Lights	130.99 ea.
12075	1968 All V8 Gauges	145.99 ea.
12000	1968 Gauges, Idle Stop	135.99 ea.
14015	1969 6 Cyl W. Lights	119.99 ea.
12005	1969 6 Cyl W. Lts Idle Stop	119.99 ea.
17615	1969 SB Warning Lights	130.99 ea.
17620	1969 SB Gauges	130.99 ea.
17625	1969 Gauges, Idle Stop	135.99 ea.
12070	1969 396 W. Lights	130.99 ea.
13150	1969 396 Light, Idle Stop	130.99 ea.
17630	1969 396 Ggs. Idle Stop	130.99 ea.
14695	1970 6 Cyl Auto Trans	183.99 ea.
15085	1970 6 Cyl Manual Trans	189.99 ea.
14700	1970 SB Auto	181.99 ea.
15090	1970 SB 4 Speed	181.99 ea.
15100	1970 BB Auto	189.99 ea.
15095	1970 BB 4 Speed	154.99 ea.
17640	1971 6 Cyl Auto Trans	189.99 ea.
17635	1971 6 Cyl Manual Trans	201.99 ea.
17435	1971 SB Auto	178.99 ea.
17455	1971 SB 4 Speed	186.99 ea.
17440	1971 SB TH400	190.99 ea.
17445	1971 BB Auto	184.99 ea.
17450	1971 BB 4 Speed	183.99 ea.
16430	1972 6 Cyl W. Lights*	230.99 ea.
16435	1972 V8 Warning Lights*	212.99 ea.
16450	1972 V8 Gauges*	212.99 ea.

\*17365 required for 4 Speed.

17490	1972 TH400 W. Lights	212.99 ea.
17645	1972 V8, TH400, Gauges	212.99 ea.
17430	1972 BB, TH400, Lights	212.99 ea.
17415	1972 BB, Auto, Gauges	183.99 ea.
17425	1972 BB 4 Speed, Lights	212.99 ea.
17420	1972 BB 4 Speed, Gauges	212.99 ea.
17015	1973 6 Cyl W. Lights	244.99 ea.
15500	1973 SB W. Lights*	232.99 ea.
15505	1973 SB Gauges*	232.99 ea.

\*17365 required for 4 Speed.

16565	1973 SB, TH400, W. Lights	231.99 ea.
16570	1973 SB, TH400, Gauges	231.99 ea.
19010	1973 BB Auto W. Lights	239.99 ea.
19005	1973 BB Manual W. Lights	260.99 ea.
19020	1973 BB Auto Gauges	239.99 ea.
19015	1973 BB Manual Gauges	260.99 ea.
16595	1974 6 Cyl W. Lights	230.99 ea.
22605	1974 SB Auto W. Lights	210.99 ea.
22590	1974 SB Auto Gauges	209.99 ea.
22610	1974 SB Manual W. Lights	219.99 ea.
22595	1974 SB Manual Gauges	219.99 ea.
19010	1974 BB Auto W. Lights	239.99 ea.
19005	1974 BB Manual W. Lights	260.99 ea.
19020	1974 BB Auto Gauges	239.99 ea.
19015	1974 BB Manual Gauges	260.99 ea.
18615	1975 6 Cyl w/o Int Cyl Head	251.99 ea.
18610	1975 6 Cyl w/ Int Cyl Head	251.99 ea.
36007	1975 V8	230.99 ea.
19045	1975 V8, TH400, HEI	218.99 ea.

**Engine Harness For HEI**

Specially modified harnesses for use with your retrofitted HEI ignition for an easy installation.

38988	1964 V8 Warning Lights	138.99 ea.
38957	1964 V8 Gauges	138.99 ea.
38936	1965 V8 Warning Lights	138.99 ea.
38953	1965 V8 Gauges	124.99 ea.
38936	1966 SB w/ Lights	138.99 ea.
39073	1966 SB w/ Lights Int AC*	180.99 ea.
38953	1966 SB Gauges	124.99 ea.
39091	1966 SB Gauges Int AC*	191.99 ea.
38974	1966 327/350 SHP	155.99 ea.
39137	1966 327/350 SHP Int AC*	197.99 ea.
39040	1966 327 SHP Gauges	143.99 ea.
39231	1966 327 SHP Ggs Int AC*	197.99 ea.
38955	1966 396 w/ Lights	138.99 ea.
39039	1966 396 w/ Lights Int AC*	203.99 ea.
38963	1966 396 Gauges	138.99 ea.
39074	1966 396 Gauges Int AC*	199.99 ea.

\*with integrated AC. AC wiring is incorporated into the dash and engine harnesses.

38935	1967 SB w/ Lights	140.99 ea.
38989	1967 SB Gauges	140.99 ea.
38937	1967 396 w/ Lights	140.99 ea.
38983	1967 396 Gauges	140.99 ea.
38959	1968 SB w/ Lights	140.99 ea.
38947	1968-69 396 w/ Lights	140.99 ea.
38978	1968 V8 w/ Gauges	139.99 ea.
39077	1968 V8 Gauges, Idle Stop	148.99 ea.
38960	1969 SB w/ Lights	140.99 ea.
39012	1969 SB w/ Lights, Idle Stop	149.99 ea.
39004	1969 SB Gauges	140.99 ea.
39232	1969 SB Gauges, Idle Stop	150.99 ea.
38947	1969 396 w/ Lights	140.99 ea.
39011	1969 396 w/ Lights, Idle Stop	139.99 ea.
38939	1969 396 Gauges	140.99 ea.
39022	1969 396 Gauges, Idle Stop	139.99 ea.
38934	1970 SB Auto Trans	187.99 ea.
39023	1970 SB Manual Trans	187.99 ea.
38928	1970 BB Auto Trans	199.99 ea.
38931	1970 BB Manual Trans	169.99 ea.
38948	1971 SB Auto Trans	191.99 ea.
39041	1971 SB Manual Trans	205.99 ea.
39031	1971 350 w/ TH400	205.99 ea.
38975	1971 BB Auto Trans	199.99 ea.
38990	1971 BB Manual Trans	196.99 ea.
41330	1972 SB Warning Lights	234.99 ea.
41332	1972 SB Gauges	223.99 ea.
41334	1972 SB w/ TH400 Warning Lights	191.00 ea.
41335	1972 SB w/ TH400 Gauges	223.99 ea.
41336	1972 BB Auto Warning Lights	234.99 ea.
41338	1972 BB Auto Gauges	253.99 ea.
41340	1972 BB Manual Warning Lights	238.99 ea.
41342	1972 BB Manual Gauges	238.99 ea.



**FACTORY FIT!**

**Forward Lamp Harness**

05745	1964 Warning Lights	224.99 ea.
05740	1964 Gauges	206.99 ea.
18010	1965 Warning Lights	206.99 ea.
09400	1965 Gauges	206.99 ea.
10060	1966 Warning Lights	219.99 ea.
10065	1966 Gauges	208.99 ea.
17395	1967 Warning Lights	206.99 ea.
11515	1967 Gauges	208.99 ea.
11775	1968 Warning Lights	219.99 ea.
11810	1968 Gauges	222.99 ea.
18015	1969 Warning Lights	199.99 ea.
12960	1969 Gauges	230.99 ea.
15160	1970 Warning Lights SB	238.99 ea.
14685	1970 Warning Lights AC	221.99 ea.
14690	1970 Gauges	230.99 ea.
17465	1971 Warning Lights	219.99 ea.
15275	1971 Warning Lights AC	230.99 ea.
17460	1971 Gauges	230.99 ea.
16455	1972 All	219.99 ea.
19035	1973 All	231.99 ea.
19040	1974 All Ex. Laguna	257.99 ea.

**Fuel Sender Harness**

28495	1967 Chevelle	28.99 ea.
28480	1967 El Camino/Wagon	24.99 ea.
28540	1968-69 Chevelle	27.99 ea.
28535	1968-72 El Camino	24.99 ea.
11910	1968-72 Wagon	28.99 ea.
28940	1970-72 Chevelle	22.99 ea.

**Glove Box Harness**

Plugs into glove box light switch assembly.

33830	1970 All	23.99 ea.
-------	----------	-----------

**Headlight Extension Harness**

39668	1976-77	51.99 ea.
-------	---------	-----------

**Horn Wire Harness**

27735	1968-69 Single Horn	19.99 ea.
27740	1968-69 Dual Horn	19.99 ea.
15055	1970-72 Single Horn	19.99 ea.
27730	1970-72 Dual Horn	19.99 ea.

**Idle Stop Solenoid Wire**

Fits all V8 except big block with manual trans.

17495	1970	16.99 ea.
-------	------	-----------

**Intermediate Harness**

HI210	1965-67 All	99.99 ea.
17700	1969 Coupe	115.99 ea.
17710	1969 Convertible	116.99 ea.
17715	1970-72 Coupe	115.99 ea.
19950	1970-71 Convertible	138.99 ea.
36411	1972 Convertible	139.99 ea.
RWC-64A	1964-67 Metal Wire Shield	49.99 kit

**Kickdown Harness**

06145	1966-67 TH400	38.99 ea.
11980	1968-69 TH400	39.99 ea.

**Kickdown Extension Harness**

Goes from gas pedal switch to engine harness.

17565	1971-72 TH400	28.99 ea.
-------	---------------	-----------

**Neutral Safety Switch Jumper**

Dash harness to column neutral safety switch; necessary for column shift auto cars.

28485	1966-67	17.99 ea.
-------	---------	-----------

28240



**Neutral Safety Switch Extension Harness**

From dash to clutch switch.

28240	1969-73	34.99 ea.
-------	---------	-----------

**Power Accessory Feed Wire**

28230	1964 Starter Solenoid to Firewall Circuit Breaker, All Pwr Acc	21.99 ea.
28430	1965-66 Horn Relay to Circuit Breaker, All Pwr Acc	18.99 ea.
07590	1965-66 Power Feed, Circuit Breaker to Power Seat Harness	23.99 ea.
10755	1967 Horn Relay to Circuit Breaker, All Power Accessories	14.99 ea.
28220	1968-71 Horn Relay to Circuit Breaker, All Power Accessories	15.99 ea.
35550	1968-69 Circuit Breaker to Main Harness, pwr window, pwr top, & seat	14.99 ea.
28215	1970-72 Circuit Breaker to Main Harness, (1) pwr window, top, & seat	19.99 ea.
36861	1970-72 Circuit Breaker to Main Harness, multi pwr window, top, & seat	26.99 ea.

**Power Antenna Harness**

32520	1966 All Exc Convertible	33.99 ea.
32525	1966 Convertible	32.99 ea.

**Power Seat Harness**

06945	1964 4-Way Bench	149.99 ea.
07595	1965-66 4-Way Bench*	149.99 ea.
07600	1965 4-Way Bucket, Drivers Side	127.99 ea.
07020	1966 4-Way Bucket, Drivers Side	127.99 ea.
32325	1967 4-Way Bench	149.99 ea.

\*Requires use of original harness.

**Power Seat Motor Relay and Adapter Harness**

Includes new standard type relay and adapter to mate to factory harness.

40146	1964-75	66.99 ea.
-------	---------	-----------

**Power Tailgate Relay and Adapter Harness**

Includes new standard type relay and adapter to mate to factory harness.

39440	1967-72	43.99 ea.
-------	---------	-----------

**Power Tailgate Window Harness**

Underdash harness that connects the switch to the ribbon cable on the body.

28505	1965-67 Wagon	67.99 ea.
-------	---------------	-----------

**Power Top Harness**

22015	1964 Ribbon Cable	67.99 ea.
06080	1965-67 Ribbon Cable	67.99 ea.
21940	1968 Intermediate	71.99 ea.
21930	1969 Intermediate	71.99 ea.
35715	1970 Intermediate	67.99 ea.

**Power Window Harness**

06960	1964 LH Door	190.99 ea.
<i>Except 2 door wagon &amp; El Camino</i>		
07145	1964 LH Door & Crossover	202.99 ea.
<i>For El Camino &amp; all 2 door wagons</i>		
06965	1964 Underdash Crossover	128.99 ea.
<i>Except 2 door wagon &amp; El Camino. You must reuse your original plastic 3 terminal connector</i>		
06955	1964 RH Door All	143.99 ea.
06985	1964 2dr Sedan 1/4 Window	54.99 ea.
<i>You must reuse your original plastic 3 terminal connector</i>		
06990	1964 Coupe 1/4 Window	78.99 ea.
<i>You must reuse your original plastic 3 terminal connector</i>		
06995	1964 Convertible 1/4 Window	78.99 ea.
<i>You must reuse your original plastic 3 terminal connector</i>		
07170	1964 Coupe Extension, Rear 1/4 Window harness to motor	22.99 ea.
07005	1964 Convertible, Extension, Rear 1/4 Window harness to motor	29.99 ea.
07610	1965 LH Door	196.99 ea.
<i>Except 2 door wagon &amp; El Camino</i>		
07145	1965 LH Door & Crossover	202.99 ea.
<i>For El Camino &amp; all 2 door wagons</i>		
07615	1965 Underdash Crossover	190.99 ea.
<i>Except 2 door wagon &amp; El Camino. You must reuse your original plastic 3 terminal connector</i>		
07605	1965 RH Door All	143.99 ea.
07635	1965 2dr Sedan 1/4 Window	95.99 ea.
<i>You must reuse your original plastic 3 terminal connector</i>		
07640	1965 Coupe 1/4 Window	72.99 ea.
<i>You must reuse your original plastic 3 terminal connector</i>		
07695	1965 Convertible 1/4 Window	78.99 ea.
<i>You must reuse your original plastic 3 terminal connector</i>		
07655	1965 Coupe Extension, Rear 1/4 Window harness to motor	22.99 ea.
07660	1965 Convertible, Extension, Rear 1/4 Window harness to motor	22.99 ea.
08260	1966 LH Door	190.99 ea.
<i>Except 2 door wagon &amp; El Camino</i>		
07145	1966 LH Door & Crossover	202.99 ea.

4432791



GWS-712

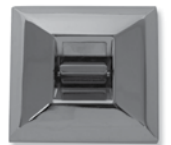

GWS-711

**Power Window Switch**

Correct OEM style power window switch.

4432790	1964-70 1 Window	42.99 ea.
4432793	1964-70 2 Window	54.99 ea.
4432791	1964-70 4 Window	69.99 ea.
GWS-711	1971-77 1 Window	44.99 ea.
GWS-712	1971-77 2 Window	52.99 ea.
GWS-714	1971-72 4 Window	69.99 ea.
GRW-016	All Circuit Breaker 30 amp	18.99 ea.

**Power Window Switch Retainer**

GWS-634	1964-77 1 Button	9.95 ea.
GWS-635	1964-77 4 Button	25.00 ea.



**For El Camino & All 2 Door Wagons**

07615	1966 Underdash Crossover .....	190.99 ea.
<i>Except 2 door wagon &amp; El Camino. You must reuse your original plastic 3 terminal connector</i>		
27310	1966 RH Door All .....	115.99 ea.
07635	1966 2dr Sedan 1/4 Window .....	95.99 ea.
<i>You must reuse your original plastic 3 terminal connector</i>		
07640	1966 Coupe 1/4 Window .....	72.99 ea.
<i>You must reuse your original plastic 3 terminal connector</i>		
07695	1966 Convertible 1/4 Window .....	78.99 ea.
<i>You must reuse your original plastic 3 terminal connector</i>		
07655	1966 Coupe Extension, Rear 1/4 Window harness to motor .....	22.99 ea.
07660	1966 Convertible, Extension, Rear 1/4 Window harness to motor .....	22.99 ea.
08260	1967 LH Door .....	190.99 ea.
<i>Except El Camino</i>		
30955	1966 LH Door & Crossover .....	206.99 ea.
<i>For El Camino</i>		
07615	1967 Underdash Crossover .....	190.99 ea.
<i>Except El Camino. Not for ignition relay. You must reuse your original plastic 3 terminal connector</i>		
32455	1967 Underdash Crossover .....	190.99 ea.
<i>Except El Camino. For use with ignition relay. You must reuse your original plastic 3 terminal connector</i>		
27310	1967 RH Door All .....	115.99 ea.
07640	1967 Coupe 1/4 Window .....	72.99 ea.
<i>You must reuse your original plastic 3 terminal connector</i>		
07695	1967 Convertible 1/4 Window .....	78.99 ea.
<i>You must reuse your original plastic 3 terminal connector</i>		
07655	1967 Coupe Extension, Rear 1/4 Window harness to motor .....	22.99 ea.
07660	1967 Convertible, Extension, Rear 1/4 Window harness to motor .....	22.99 ea.
31135	1968 LH Door .....	189.99 ea.
14165	1968 RH Door .....	115.99 ea.
39470	1969 LH Door .....	218.99 ea.
<i>with under dash crossover</i>		
37817	1969 RH Door .....	118.99 ea.
14405	1969 1/4 Windows .....	152.99 ea.
31140	1970 LH Door .....	209.99 ea.
<i>with under dash crossover</i>		
14470	1970 RH Door .....	129.99 ea.
14505	1970 1/4 Windows .....	160.99 ea.
31140	1971 LH Door .....	209.99 ea.
<i>with under dash crossover</i>		
14470	1971 RH Door .....	129.99 ea.
14505	1971 1/4 Windows .....	160.99 ea.
39471	1972 LH Door .....	224.99 ea.
<i>with under dash crossover</i>		
14470	1972 RH Door .....	129.99 ea.
14505	1972 1/4 Windows .....	160.99 ea.

**Power Window Relay & Adapter Harness**

Includes new standard type relay and adapter to mate to factory harness.

39440	1967-72 .....	43.99 ea.
-------	---------------	-----------

**Radio & Speaker Harness**

With 4 speaker stereo.

36251	1970-72 .....	122.99 ea.
-------	---------------	------------

*Does not fit El Camino*



**Rear Lamp Harness**

07175	1964 HT w/o Backup .....	155.99 ea.
07180	1964 HT w/ Backup .....	155.99 ea.
07185	1964 Convertible All .....	155.99 ea.
07125	1964 El Camino .....	155.99 ea.
07545	1965 HT w/o Backup .....	167.99 ea.
07550	1965 HT w/ Backup .....	155.99 ea.
07555	1965 Convertible All .....	149.99 ea.
07800	1965 El Camino .....	155.99 ea.
08240	1966 Coupe .....	155.99 ea.
17655	1966 Convertible .....	155.99 ea.
08255	1966 El Camino .....	161.99 ea.
13925	1967 Coupe .....	155.99 ea.
13930	1967 Convertible .....	155.99 ea.
14060	1967 El Camino .....	161.99 ea.
17675	1968 HT, B/Up in Bump .....	188.99 ea.
17680	1968 Convertible, B/Up in Bump .....	211.99 ea.
14115	1968 El Camino .....	189.99 ea.
17690	1969 Chevelle .....	108.99 ea.
14230	1969 El Camino .....	177.99 ea.
14745	1970 Chevelle .....	149.99 ea.
14485	1970-72 El Camino .....	169.99 ea.
17695	1971-72 Chevelle .....	161.99 ea.

**Rear Window Defroster Harness**

14185	1968 .....	57.99 ea.
14415	1969 .....	59.99 ea.
14555	1970-72 .....	59.99 ea.

**Seat Belt Warning Extension Harness**

From intermediate body connector to seat belt.

19955	1972 .....	42.99 ea.
-------	------------	-----------

**Speaker Harness**

06905	1964 Rear Seat .....	23.99 ea.
33430	1965-69 4 Stereo Speakers .....	78.99 ea.
18510	1965-69 to Rear Seat .....	48.99 ea.
36251	1970-72 4 Stereo Speakers .....	122.99 ea.

**Speed Warning Harness**

11045	1966-67 All .....	23.99 ea.
17735	1968 All .....	23.99 ea.
17730	1969 All .....	23.99 ea.

**Tachometer Harness**

04950	1964 Dash Mounted .....	41.99 ea.
05170	1964 Column Mounted .....	47.99 ea.
05905	1965 In Dash .....	45.99 ea.
09710	1966 Front of Dash .....	54.99 ea.
10985	1967 Front of Dash .....	54.99 ea.
11060	1967 Turn Signal Leads .....	15.99 ea.

**TCS Jumper Wire**

Connects to passenger side temp sending unit on cars with gauges or AC only.

17740	1971 .....	16.99 ea.
-------	------------	-----------

**TCS Transmission Switch Extension Harness**

Connect engine harness to switch on manual transmission.

17365	1972 .....	44.99 ea.
-------	------------	-----------

*For use with engine harness 16430, 19635, 16450.*

17355	1973 .....	44.99 ea.
-------	------------	-----------

*For use with engine harness 15500, 15505.*



**Transistor Ignition Harness**

21260	1964 Harness .....	83.99 ea.
<i>Amplifier to extension harness</i>		
33225	1964 Amplifier Extension .....	44.99 ea.
<i>From internal circuit board to amplifier housing connector</i>		
21270	1964 Extension Harness .....	95.99 ea.
<i>Starter motor, coil &amp; distributor</i>		
21265	1964 Power Feed .....	19.99 ea.
<i>Ignition switch to extension harness</i>		
28365	1965 Harness .....	70.99 ea.
<i>Amplifier to extension harness</i>		
33225	1965 Amplifier Extension .....	44.99 ea.
<i>From internal circuit board to amplifier housing connector</i>		
21270	1965 Extension Harness .....	95.99 ea.
<i>Starter motor, coil &amp; distributor</i>		
28435	1965 Power Feed .....	24.99 ea.
<i>Ignition switch to extension harness</i>		
28475	1966 Harness .....	70.99 ea.
<i>Amplifier to extension harness</i>		
33225	1966 Amplifier Extension .....	44.99 ea.
<i>From internal circuit board to amplifier housing connector</i>		
28385	1966 Extension Harness .....	88.99 ea.
<i>Starter motor, coil &amp; distributor</i>		
28460	1966 Power Feed .....	24.99 ea.
<i>Ignition switch to extension harness</i>		

**Transistor Ignition Replacement Module**

Replaces original circuitboard in amplifier.

32270	1964-66 .....	177.99 ea.
-------	---------------	------------

**Trunk Lamp Assembly**

Complete light harness with bulb and extension harness.

36379	1966-67 All .....	43.99 ea.
35520	1968-69 All .....	39.99 ea.
36380	1970-72 All .....	39.99 ea.

**Wiper Motor Harness**

28420	1964 1 Speed .....	25.99 ea.
40910	1964 2 Speed 1st Design .....	29.99 ea.
<i>90 degree terminals on back of your switch.</i>		
28440	1964 2 Speed 2nd Design .....	28.99 ea.
<i>Straight terminals on back of your switch.</i>		
28415	1965 1 Speed .....	32.99 ea.
28425	1965 2 Speed .....	34.99 ea.
28465	1966 2 Speed .....	34.99 ea.
28470	1966 Extension .....	20.99 ea.
<i>Goes from wiper motor harness to wiper motor switch.</i>		
28255	1970 Electro-Tip Wipers .....	63.99 ea.



**AC Delco Spark Plugs**

This is a brand new set of 8 spark plugs for your Chevelle. These high quality reproduction AC Delco spark plugs feature the correct green AC and number markings as original.

AC43	1964-70 #43 .....	62.99 set
AC44	1964-70 #44 .....	62.99 set
AC45	1964-70 #45 .....	62.99 set

*Note: The number on the plug refers to its operating temperature. The lower number is a cooler running plug which is typically found on the SHP high performance engines. A hotter, higher numbered plug would be used in engines where plug fouling may be or is a problem.*

**PACKARD RADIO TVRS LR 3-**

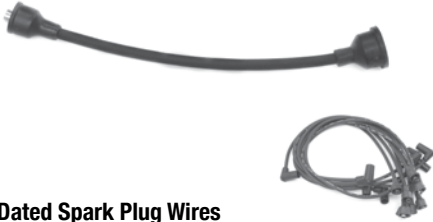

**Dated Spark Plug Wires**

New reproduction wire set correctly dated for your specific car, pre-cut and ready to install! Each set features correct colored wires and correct angle "cut" boots. The date coding identified the quarter and year in which the wires were produced. As an example, a wire date coded as 1-Q-67 would have been produced in the first quarter of 1967.

Research has shown that most cars had spark plug wires installed that were dated from 1 to 4 quarters prior to the build date of the car.

ALL-64SB3Q	1964 SB "3-Q-63"	99.99 set
ALL-64SB1Q	1964 SB "1-Q-64"	99.99 set
ALL-65SB3Q	1965 SB "3-Q-64"	99.99 set
ALL-65SB1Q	1965 SB "1-Q-65"	99.99 set
ALL-66SB1Q	1966 SB "1-Q-66"	99.99 set
ALL-67SB3Q	1967 SB "3-Q-66"	99.99 set
ALL-67SB1Q	1967 SB "1-Q-67"	99.99 set
ALL-68SB3Q	1968 SB "3-Q-67"	99.99 set
ALL-68SB1Q	1968 SB "1-Q-68"	99.99 set
ALL-68BB3Q	1968 BB "3-Q-67"	99.99 set
ALL-68BB1Q	1968 BB "1-Q-68"	99.99 set
ALL-69SB3Q	1969 SB "3-Q-68"	99.99 set
ALL-69SB1Q	1969 SB "1-Q-69"	99.99 set
ALL-69BB3Q	1969 BB "3-Q-68"	99.99 set
ALL-69BB1Q	1969 BB "1-Q-69"	99.99 set
ALL-70SB3Q	1970 SB "3-Q-69"	99.99 set
ALL-70SB1Q	1970 SB "1-Q-70"	99.99 set
ALL-70BB3Q	1970 BB "3-Q-69"	99.99 set
ALL-70BB1Q	1970 BB "1-Q-70"	99.99 set
ALL-71SB3Q	1971 SB "3-Q-70"	99.99 set
ALL-71SB1Q	1971 SB "1-Q-71"	99.99 set
ALL-72SB3Q	1972 SB "3-Q-71"	99.99 set
ALL-72SB1Q	1972 SB "1-Q-72"	99.99 set
ALL-73SB3Q	1973 SB "3-Q-72"	99.99 set
ALL-73SB1Q	1973 SB "1-Q-73"	99.99 set



AHC-1508

**Spark Plug Wire Sets**

New pre-cut OEM replacements.

AHC-1508	All SB w/o HEI	39.95 set
AHC-2508	All BB w/o HEI	39.95 set
AHC-3508	1973-77 HEI	54.99 set



**Retaining Straps**

Correct push-in style plastic retainers

BPX-2350	All	3.95 pr.
----------	-----	----------



AHC-1

AHC-2

**Harness Retaining Clips**

Correct retaining clips for harness.

AHC-1	Clip Style #1	4.95 ea.
AHC-2	Clip Style #2	4.95 ea.



**Harness Wire Ties**

Original GM wire ties used for various hoses, cables and harnesses.

BJN-300	Short	3.99 ea.
BJN-600	Long	5.99 ea.



**Breakerless SE Ignition Conversion**

The Breakerless SE ignition kit is designed to convert GM V8 engines originally equipped with breaker points, windowed style distributor cap and stock coil to solid-state electronic ignition. No distributor modification, disassembly or removal is required. Easier starting.

38131	Breakerless SE Conversion	154.99 kit
-------	---------------------------	------------



ADS-2100

ADS-2100-SC-RED

**HEI Distributor**

Chrome aluminum HEI electronic distributor with built-in 50K coil.

ADS-2100	All V8	94.99 ea.
ADS-2100-SC-RED	All V8, Red Super Cap	99.99 ea.
ADS-2100-SC-CLEAR	All V8, Clear Super Cap	97.99 ea.
GCS-S3938-BLUE	16 Blue Super Cap*	90.99 ea.

\* For 292 Inline 6 cyl. only.



GCS-S2039BK



GCS-S2039BLU

**External Ignition Coils**

Choose from our upgraded external ignition coils. 45,000-volt output. Anodized finish, includes pigtails and hardware for installation.

GCS-S2039BK	All, Black	55.99 ea.
GCS-S2039BLU	All, Blue	57.99 ea.



**HEI Distributor Pigtail**

GCS-S3112	All	13.99 ea.
-----------	-----	-----------



ASR-64ABB

**Spring Ring Cables**

Reproduction of the original factory installed spring type cables sold as a matched pair with GM numbers.

ASR-64ASB	1964-67 SB	160.18 pr.
ASR-64ABB	1964-67 BB	160.18 pr.
ASR-68ASB	1968 SB	111.92 pr.
ASR-68ABB	1968 BB	160.18 pr.
ASR-69ASB	1969-72 SB	160.18 pr.
ASR-69ABB	1969-72 BB	160.18 pr.



**Side Terminal Battery Cables**

Correct cables for cars with the heavy duty R-89 batteries with correct GM part numbers.

AST-1001	1969-72 HD	124.99 kit
----------	------------	------------



GCS-S6323

**Billet Aluminum Battery Trays**

Secure your battery in style! Fits Optima batteries.

- GCS-S6323 Optima Group 34/78 Top/Side Post.....91.99 kit
- GCS-S6324 Optima Group 35 Top Post.....73.99 kit
- GCS-S6325 Optima Group 75/25 Top/Side Post.....83.99 kit



GCS-S9323

**Universal Stainless Battery Tray**

This polished stainless steel tray will secure your battery in style! Fits batteries measuring 7.5" L x 13.25" W x 9.25" tall.

- GCS-S9323 Battery Tray.....43.99 kit



**Coil**

Choose from our new reproduction Delco coils with GM numbers or GM replacement coil.

- GAC-505 1964-73 All Replace.....39.95 ea.  
\*427/454 transistor ignition.



ALI-3119



ALI-65

BAN-516

**Coil Bracket**

Reproduction of original comes with retaining screw.

- ALI-65 1965 L79.....99.95 ea.
- ALI-3119 All V8.....20.99 ea.
- BAN-516 SEMS Bolts.....1.95 pr.

N-2441



**Tune Up Kit**

Tune up kit with new points, condenser and rotor.

- N-2441 1964-73 All .....49.99 ea.



ACI-3685

**Cowl Hood Solenoid**

Correct electric solenoid.

- ACI-3685 1970-72 .....41.99 ea.



**Distributor Cap**

Choose from AC Delco replacement distributor cap or reproduction distributor cap with GM numbers. Red cap features heavy duty brass terminals for high performance engines.

- 1971244 Black Cap.....79.99 ea.
- AAD-308 Replacement.....22.95 ea.



ACE-1400

**Distributor Hold Down**

Correct retaining hardware for distributors.

- ACE-1400 All V8.....13.99 kit



GRA-8172

**Air Conditioner Relay**

Correct GM blower motor relay.

- GRA-8172 1964-68 w/ AC.....22.95 ea.
- GRA-885 1969-72 w/ AC.....54.99 ea.



GBS-689

**Blower Motor Switches**

- GBS-645 1964-65 w/o AC .....44.95 ea.
- GBS-645AC 1964-65 w/ AC .....44.95 ea.
- GBS-667 1966-67 w/o AC .....44.95 ea.
- GBS-689 1968-69 w/o AC .....29.99 ea.
- GBS-712 1970-72 w/o AC .....60.00 ea.
- GAC-383 1970-72 w/ AC .....34.99 ea.

GBL-852



GBL-852-CC



GSR-12999

**Brake Light Switches**

OE style brake light switches located above the brake pedal.

- GBL-852 1964-72 All w/o Cruise Control .....7.95 ea.
- GBL-852-CC 1964-77 All w/ Cruise Control .....24.99 ea.
- GSR-12999 Retainer.....7.99 ea.



GRW-016

**Circuit Breaker**

Correct 30 amp breaker used for power windows, power doors, power tailgates and power tops.

- GRW-016 1964-71 .....18.99 ea.

GT-159



GT-69



**Convertible Top Switch**

- GT-159 1964-68 .....34.99 ea.
- GT-69 1969 .....59.95 ea.
- GT-159 1970-72 .....34.99 ea.
- GW-458 1964-69 Switch Bracket .....18.99 ea.



GWC-68A

**Under Dash Wire Clip**

Holds the main harness under the dash where it comes through the firewall.

- GWC-68A 1968-72 All .....16.99 ea.



GSR-6076

**Power Seat Relay**

Correct for cars with 4 or 6 way seats. Replaces OEM 5717528.

- GSR-6076 1964-76 All .....59.95 ea.



AEH-9602

**Cowl Induction Relay**

New relay which mounts to firewall.

AEH-9602 1970-72 w/ CI ..... 30.99 ea.



ATE-2101

**Cowl Induction Throttle Switch**

Operates the opening of door.

ATE-2101 1970-72 ..... 39.99 ea.



ACC-8555

**Cowl Induction Throttle Switch Bracket**

Correct bracket with hardware.

ACC-8555 1970-72 ..... 19.95 ea.



GDJ-11



GDJ-10



GDJ-3F

**Door Jamb Switches**

GDJ-11 Dual Pin (Male) ..... 7.99 ea.  
GDJ-10 Single Pin (Male) ..... 9.99 ea.  
GDJ-3F Single Pin (Female) ..... 8.99 ea.



GHB-484



GHB-488



GHB-6481

**Power Window Grommets & Conduits**

These are the correct conduits and grommets that run from the A-pillar to the door on cars with power windows and/or locks.

GHB-484 1964-67 All ..... 59.99 pr.  
GHB-488 1969-72 All ..... 42.99 pr.  
GHB-6481 1964-77 Grommet Only ..... 9.99 ea.



GAC-515



**Voltage Regulator**

New correct replacement.

GAC-515 1964-71 All D635 ..... 84.99 ea.  
GAC-515GM GM Reproduction ..... 94.99 ea.  
AVX-515 1968-71 Screws (2) ..... 0.95 kit  
AWX-818 1964-67 Mounting Kit ..... 6.95 kit



GAC-515GM

GQH-118



**Electric Junction Block**

Original GM junction block for attaching positive lead from battery to main harness. Mounts to radiator support. Includes correct nut.

GQH-118 1964-72 All ..... 9.95 ea.



GDT-0330

**Electrical Harness Tape**

Correct non-stick factory style tape. Over 100 feet.

GDT-0330 All ..... 11.95 ea.



18000

**Glove Box Lamp**

Complete assembly with socket, switch, bulb and correct harness.

18000 1964-69 All ..... 20.99 kit  
33830 1970-71 Harness Only ..... 23.99 ea.



APJ-5240

**Ground Strap Kit**

Correct braided copper wire and ends complete with OEM screws.

APJ-5240 1964+ (3 pc) ..... 19.99 kit



GFS-502

**Turn Signal & Hazard Light Switch**

Correct flasher switch that plugs into fuse box.

GFS-502 1964-77 ..... 11.95 ea.



GAC-808



GAC-808-HARNS

**Headlight Dimmer Switch**

Correct floor mounted high beam switch located on floor.

GAC-808 1964-76 All ..... 8.95 ea.  
GAC-7802 1978-88 All Switch On Column ..... 14.99 ea.  
GAC-808-HARNS 1964-76 All Harness ..... 6.95 ea.



GHR-88

**Headlamp Switch Nut**

Correct special metal nut used for retaining switch to the dash.

GHR-66 1964-67 ..... 11.99 ea.  
GHR-88 1969-72 All ..... 12.99 ea.



GHS-588

**Headlight Switch**

GHS-588 1964-69 All ..... 19.99 ea.  
GHS-217 1970 All 7 Pin w/ Terminals ..... 21.99 ea.  
GHS-588 1971-73 All ..... 19.99 ea.



GGS-70A

**1970-72 Headlight Switch & Gauge Ground Strap**

This ground strap was included on all cars that came from the factory with round Super Sport gauges. This ground strap is a must for assuring proper gauge operation as well as making sure the headlamps are not back fed into the system. This is a commonly missing item.

GGS-70A Super Sport ..... 29.95 ea.

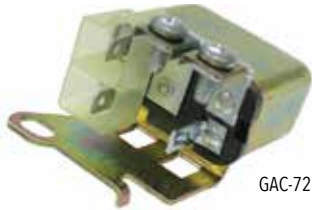

GAC-723

### 1964-71 Horn Relay

Reproduction featuring Delco Remy logo and correct coloring.

GAC-723	1964-71	52.95 ea.
---------	---------	-----------



GAC-775

### 1972-73 Horn Relay

Replacement for GM numbers 3996283 and 6273328.

GAC-775	1972-73	56.99 ea.
---------	---------	-----------

GIS-821



GIS-052



GIS-042

### Ignition Switch

GIS-170	1964 All	16.95 ea.
GIS-821	1966-67 All	37.99 ea.
GIS-001	1968 All	32.95 ea.
GIS-042	1969-72 w/o Tilt	29.99 ea.
GIS-052	1969-72 w/ Tilt	26.99 ea.



ISB-1498D

### Steering Column Bracket

Correct bracket which retains the steering column to the dash.

ISB-1498D	1968-72	69.99 ea.
-----------	---------	-----------



GAC-70SS

### Instrument Socket

Correct plastic twist-in socket for actuating printed circuit board.

GAC-70SS	1970-72 SS	3.95 ea.
GAC-70SS-KIT	1970-72 SS (14 pc.)	49.95 kit



### Printed Circuit Boards

Reproduction instrument board.

GPC-521	1970-72 SS w/ Gauges	71.95 ea.
GPC-523	1970-72 SS w/ Lights	71.95 ea.
GPC-788G	1978-81 Rally w/ Gauges	74.99 ea.
GPC-781W	1978-81 Rally w/ Warn Lights	99.99 ea.
GPC-788W	1981-87 Rally w/ Warn Lights	79.99 ea.



GNS-2248

### Neutral Start Switch

Correct safety switch located at pedal which prevents your car from being started in gear.

GNS-2248	1969 4 Speed	74.99 ea.
GNS-1588	1970 4 Speed	59.99 ea.
GNS-1589	1971-72 4 Speed	79.99 ea.



GNS-13

### Neutral Safety Switch

Correct switch at base of steering column for proper engine & reverse light activation.

GNS-13	1964-66 PG Column	22.99 ea.
GNS-23	1965-66 TH	21.99 ea.
GNS-696	1965-67 Auto Console	69.99 ea.
GNS-33	1969-72 4 Speed Reverse Lights	52.99 ea.
GDR-411	1968-72 Auto Console	34.99 ea.
GNS-35	1969-73 Auto Column	21.99 ea.



1993661

### Reverse Lamp Switch

1993661	1964 4 Speed	69.99 ea.
1993307	1965-68 4 Speed	69.99 ea.



GT-159

### Power Tailgate Window Switch

GT-159	1964-68 Wagon	34.99 ea.
--------	---------------	-----------



GWR-772

### Power Window Relay

Correct reproduction of this hard to find relay.

GWR-772	1967-72	52.99 ea.
---------	---------	-----------



4432791



GWS-712

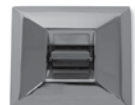

GWS-711

### Power Window Switch

Correct OEM style power window switch.

4432790	1964-70 1 Window	42.99 ea.
4432793	1964-70 2 Window	54.99 ea.
4432791	1964-70 4 Window	69.99 ea.
GWS-711	1971-77 1 Window	44.99 ea.
GWS-712	1971-77 2 Window	52.99 ea.
GWS-714	1971-72 4 Window	69.99 ea.
GRW-016	All Circuit Breaker 30 Amp	18.99 ea.
36048	1964-70 Pigtail Single Switch	24.99 ea.

### Power Window Switch Retainer

GWS-634	1964-77 1 Button	9.95 ea.
GWS-635	1964-77 4 Button	25.00 ea.



GLS-71

### Power Lock Switch

Die cast and chrome plated. It reads LOCK and has the correct square corners and profile. Replaces GM number 1725099

GLS-71	1971-77	59.99 ea.
--------	---------	-----------



GHD-6472

### Body Wiring Hold Down

Interior body floor panel wiring hold down clip used to hold body harness to floor pan.

GHD-6472	1964-72 All	4.99 ea.
----------	-------------	----------

Note: Typically 3 required.



**Reverse Switch Extension Harness**

Correct harness which plugs into firewall.

05100	1964 All Manual	28.99 ea.
19240	1965 All Manual	28.99 ea.
10665	1966-68 All Manual	31.99 ea.



**Fuel Sending Unit Harness**

New reproduction with correct boot.

28495	1967 Chevelle	28.99 ea.
28480	1967 El Camino	24.99 ea.
28540	1968-69 Chevelle	27.99 ea.
28535	1968-72 El Camino	24.99 ea.
28940	1970-72 Chevelle	22.99 ea.



1114432

**TCS Solenoid**

Correct TCS solenoids which mount to the carburetor stud. Includes correct brackets.

1114432	1970-71 350/400	111.99 ea.
1114434	1970 BB	111.99 ea.



**TCS Wire Retainer**

Correct reproduction for Muncie.

ATS-653	1970-74 w/ Muncie	21.99 ea.
---------	-------------------	-----------

Note: Mounts to transmission.



**Firewall Wiring Clip**

Holds main harness to firewall.

GWC-70F	1970-72 All	18.99 ea.
---------	-------------	-----------



**TCS Littlefuse Relay**

This is a reproduction of the correct littlefuse TCS relay. This authentic reproduction features 4 prongs as original.

ATCS-33R	1970-72	54.99 ea.
----------	---------	-----------

ATS-21MP

ATS-21MS



**TCS Transmission Switches**

Correct TCS switch located on transmission.

ATS-21MP	1970-75 Pin Style	36.99 ea.
ATS-21MS	1970-75 Spade Style	36.99 ea.



**TCS Temp Sending Unit**

Correct 2 prong sending unit mounts on right side cylinder head.

GAC-660	1970 All	18.95 ea.
---------	----------	-----------



GTR-92

**Turn Signal Repair**

Correct white plastic repair arm that the turn signal handle attaches to.

GTR-92	1964-66 w/o Tilt	12.95 ea.
GTR-303	1967-68 w/o Tilt	13.99 ea.
GTR-305	1969-72 All	15.99 ea.



**Speaker/Trunk/Blower Motor Wire Clips**

Used to hold the wiring under the dash, power trunk or trunk light wires to hinge, speaker wires to package tray or blower motor wire to vent.

GWC-SPK	1964-77 All	19.99 pr.
---------	-------------	-----------



GWS-103



GWS-106

**Wiper Switch**

GWS-641	1964 1 Speed	49.99 ea.
GWS-642	1964 2 Speed	44.99 ea.
GWS-651	1965 1 Speed	44.99 ea.
GWS-101	1965 2 Speed	49.99 ea.
GWS-102	1966 2 Speed	49.99 ea.
GWS-103	1967 2 Speed	41.99 ea.
GWS-104	1968 w/o Hidden	53.99 ea.
GWS-442	1968 w/ Hidden	49.99 ea.
GWS-106	1969-71 w/o Hidden	54.99 ea.
GWS-107	1969-71 w/ Hidden	49.99 ea.
1994180	1972 w/o Hidden	59.99 ea.
1994131	1972 w/ Hidden	59.99 ea.

\*Will not work with pulse/intermittent wipers.



GTS-62



GTS-623



GTS-623T



GTS-304

**Turn Signal Switches**

Complete switch assemblies with correct plug-in harnesses.

GTS-62	1964-66 w/o Tilt BPC	99.99 ea.
GTS-623	1964-66 w/o Tilt Guide	69.99 ea.
GTS-623T	1964-66 w/ Tilt	79.99 ea.
GTS-304	1967-68	54.99 ea.
GTS-6208	1969-72	54.99 ea.
GTS-6208GM	1969-76 OEM Style	59.99 ea.



GRC-12834

**Voltage Regulator Radio Capacitor**

Came from the factory on all cars with radio. Correct length lead wire & white connector. Stamped 1964086 "DR" & ".5MF" as original.

GRC-12834	1967-71	39.99 ea.
GRC-12835	1970-74	39.99 ea.



**Spring Ring Cables**

Reproduction of the original factory installed spring type cables sold as a matched pair with GM numbers.

ASR-64ASB	1964-67 SB	160.18 pr.
ASR-64ABB	1964-67 BB	160.18 pr.
ASR-68ASB	1968 SB	111.92 pr.
ASR-68ABB	1968 BB	160.18 pr.
ASR-69ASB	1969-72 SB	160.18 pr.
ASR-69ABB	1969-72 BB	160.18 pr.



500626

**Classic Dash LED and Terminal Kit**

This is the same LED kit for your turn signals, high beam indicator and brake light that is included with our complete Classic Dash panel kits. It can be used when buying a blank panel only.

500626	1964-88	29.99 kit
--------	---------	-----------

*No Volume Discount.*



TENDER-0128



**Battery Tender**

The Battery Tender Plus is a 1.25 amp battery charger designed to fully charge a battery and maintain it at proper storage voltage without the damaging effects caused by trickle chargers. Included is a quick connect harness for hard to reach areas. Temperature compensated to ensure optimum charge voltage according to ambient temperature. Automatically switches from full charge to float charging mode. Battery Tender at 1.25 amps will charge as fast or faster than any 3 amp charger available. Reverse Polarity Protection to ensure user safety. Complete 4-step charging program (Initialization, Bulk Charge, Absorption Mode, Float Mode).

TENDER-0128	Battery Tender	59.95 ea.
-------------	----------------	-----------



28450



28950

**Courtesy Lamp Harness**

Correct harness for under dash light.

28450	1964-65 All	43.99 ea.
28490	1966-67 All	38.99 ea.
28530	1968 All	40.99 ea.
28950	1969-70 All	41.99 ea.
15295	1971-72 All	42.99 ea.
500081	1964-77 All Universal 2 Lights	32.99 ea.



GSS-883



GSS-893

**Side Marker Socket**

GSS-883	1968-72 All	5.95 ea.
GSS-893	1969-77 All 90 Degree (158 & 194 Bulb)	5.95 ea.



**Classic Dash Wiring Harness**

This is the same wiring harness that is included with our complete Classic Dash panel kits. It can be used when buying a blank panel only. Includes LED and terminal kit.

120-64-5200	1964-65	178.95 kit
120-66-5200	1966-67	190.95 kit
120-68-5200	1968-69	190.95 kit
120-70-5200	1970-72	190.95 kit

*No Volume Discount.*



**Electronic Speedometer Sender**

This speedometer sending unit is required for correct operation of your electronic speedometer.

FSU1000	1964-72	109.99 ea.
---------	---------	------------

*No Volume Discount.*



GLS-154

**Tail Lamp Socket**

Correct socket for bulb.

GLS-157	1964-68 All (1157 Bulb)	8.95 ea.
GLS-154	1969-72 All (1157 Bulb)	11.95 ea.
GLS-70	1969-77 All 2 <sup>nd</sup> Design (1156 Bulb)	11.95 ea.



**License Plate Lamp Socket**

GPS-558	1964-69 All	4.95 ea.
---------	-------------	----------



**MADE IN THE USA**

LED-7



LED-7-HALO



LED-7-AMBER



**LED Headlamps**

Upgrade your weak old headlights with a pair of high-performance LED headlights! Producing 4,000 lumens at 6,000 kelvin color temperature, these LED headlights are rated for 22,000 operating hours at 25 watts and only 2-amp draw. Made In the USA!

LED-5	1964-70 LED .....	643.98 set
LED-5-HALO	1964-70 LED White Halo .....	810.98 set
LED-5-AMBER	1964-70 LED Amber Halo .....	749.98 set
LED-7	1971-77 LED .....	352.99 pr.
LED-7-HALO	1971-77 LED White Halo .....	458.99 pr.
LED-7-AMBER	1971-77 LED Amber Halo .....	458.99 pr.

No Volume Discount.



LHT-7PB-HI



LHT-7PB-HI Detail



LHT-7T-HI Detail



FACTORY T3

HI-INTENSITY T3

**T-3 Headlamps**

Upgrade your weak old original T3 and Power Beam headlights with a pair of high performance headlights from Ground Up Motor Sports! These headlamps utilize modern bulb filaments with a much brighter high/low beam, which are considerably brighter than the original factory and Power Beam units. These fit and function exactly as original which makes installing these a breeze. They feature a T3 or Power Beam logo and look just like the originals! We tested these on our own 1969 Camaro in our warehouse and you can really see the difference!

LHTT3-HI	1964-70 All (4 Piece Set).....	149.99 set
LHT-7PB-HI	1971-77 All.....	139.99 pr.
LHT-7T-HI	1971-77 All .....	149.99 pr.

No Volume Discount.

LHB-A



LHB-B



LHB-D



**Headlamp Assemblies**

Headlamp assemblies complete with bucket, stainless trim ring and Wagner bulb (the same bulb that GM used as a replacement during service).

LHB-A	1967-69 LH or RH Outer.....	49.99 ea.
LHB-B	1967-69 LH or RH Inner.....	49.99 ea.
LHB-679K	1967-69 LH & RH 4pc .....	179.96 kit
LHB-B	1970 LH Inner .....	49.99 ea.
LHB-C	1970 RH Outer.....	49.99 ea.
LHB-D	1970 RH Inner .....	49.99 ea.
LHB-A	1970 LH Outer.....	49.99 ea.
LHB-70K	1970 LH & RH 4pc.....	179.96 kit



### Parking Lamp Housings Chevelle & El Camino

Complete parking lamp assemblies featuring correct lens and plug in harness ready to install. Buy the pair to replace both together and save!



LPH-2290 1964 All LH/RH ..... 69.99 ea.



LPH-2300L 1965 LH ..... 59.99 ea.  
LPH-2300R 1965 RH ..... 59.99 ea.



LPH-2340L 1966 LH ..... 59.99 ea.  
LPH-2340R 1966 RH ..... 59.99 ea.



LPH-2351L 1967 LH ..... 59.99 ea.  
LPH-2351R 1967 RH ..... 59.99 ea.



LPH-2356 1968 LH/RH ..... 59.99 ea.



LPH-E69L 1969 El Camino LH ..... 66.99 ea.  
LPH-E69R 1969 El Camino RH ..... 66.99 ea.



LPH-2366L



LPH-2369L

LPH-2366L 1969 SS LH ..... 69.99 ea.  
LPH-2366R 1969 SS RH ..... 69.99 ea.  
LPH-2369L 1969 Malibu LH ..... 62.99 ea.  
LPH-2369R 1969 Malibu RH ..... 62.99 ea.



LPH-2360 1970 Malibu LH/RH ..... 59.99 ea.



LPH-2361 1970 SS LH/RH ..... 62.99 ea.



LH-L70B 1970 El Camino LH/RH ..... 69.99 ea.



LPH-73A

LPH-767A

LPH-73A 1973 LH/RH\* Chevelle/El Camino ..... 52.99 ea.  
LPH-767A 1976-77 LH/RH\* Chevelle/El Camino .. 58.99 ea.  
*\*These are housings with lenses only.*

### BUY 'N SAVE WITH KITS



### Parking Lamp Housing Kits

Buy the pair and save!

LAMP-KIT64	1964 All	125.98 kit
LAMP-KIT65	1965 All	107.98 kit
LAMP-KIT66	1966 All	107.98 kit
LAMP-KIT67	1967 All	107.98 kit
LAMP-KIT68	1968 All	107.98 kit
LAMP-KIT69	1969 Chevelle	113.38 kit
LAMP-KIT69SS	1969 Chevelle SS	125.98 kit
LAMP-KIT69E	1969 El Camino	120.58 kit
LAMP-KIT70M	1970 Malibu	107.98 kit
LAMP-KIT70SS	1970 Chevelle SS	113.38 kit
LAMP-KIT70E	1970 El Camino	125.98 kit



### Parking Lamp Gaskets

Correct sponge material as original.

LG-2168	1964 All	6.99 pr.
LG-4151	1965-66 All	6.99 pr.
LG-5191	1967-68 All	6.99 pr.
LG-5198	1969 Chevelle	6.99 pr.
LG-1230	1969 El Camino	6.99 pr.
LG-5200	1970 Chevelle	6.99 pr.
LG-1232	1970 El Camino	6.99 pr.
LG-5203	1971-72 Chevelle	6.99 pr.
LG-1234	1971-72 El Camino	6.99 pr.

**Parking Lamp Lenses**

If your original housings and wires are okay, we offer replacement lenses so you don't have to replace your whole assembly.



LPL-4247 1964 All ..... 36.99 pr.



LPL-4248 1965 All ..... 45.99 pr.



LPL-4249 1966 All ..... 34.95 pr.



LPL-4250 1967 All ..... 36.95 pr.



LPL-4505 1968 All ..... 45.99 pr.



LPL-4252 1969 Non-SS ..... 34.95 pr.



LPL-4253 1969 SS ..... 69.99 pr.



LPL-1555 1970 SS Clear ..... 21.99 ea.  
LPL-70M 1970 Chevelle & Malibu NON SS Amber ..... 55.99 pr.



LPL-70E 1970 El Camino ..... 47.99 pr.  
LTS-696 1970 El Camino Screws ..... 9.99 kit



LPL-71AN 1971 Chevelle ..... 67.99 pr.  
LPL-71BN 1971 El Camino ..... 69.99 pr.



LPL-72AN1 1972 Chevelle Amber ..... 63.99 pr.  
LPL-72BN1 1972 El Camino Amber ..... 65.99 pr.



LPL-72AN2 1972 Chevelle Clear ..... 59.99 pr.  
LPL-72BN2 1972 El Camino Clear ..... 77.99 pr.



LPL-72MC-L 1972 Monte Carlo LH ..... 39.99 ea.  
LPL-72MC-R 1972 Monte Carlo RH ..... 39.99 ea.



LPL-747A 1974-77 Chevelle/El Camino ..... 28.99 ea.



LPB-1430



LPB-1475

**Parking Lamp Bezels**

Reproduction bezels.

LPB-1430 1971 Chevelle ..... 84.99 pr.  
LPB-1475 1972 Chevelle ..... 84.99 pr.  
LPB-71E 1971 El Camino ..... 84.99 pr.  
LPB-72E 1972 El Camino ..... 84.99 pr.



**1986-1988 Monte Carlo LS Side Marker Lamp Assembly**

Replace your cracked or missing original side markers with these brand new assemblies made from original GM tooling! Original GM part number 5974357 LH, 5974358 RH.

LSM-4086L LH ..... 59.99 ea.  
LSM-4086R RH ..... 59.99 ea.



DT-2100466

**Digi-Tails LED Parking Light Kits**

Dramatically enhance your front lights with high intensity wide-angled LEDs that maximize light output, making your lights safer and brighter. Easy to install!

DT-2100466	1966 All.....	99.95 kit
DT-2100467	1967 All.....	99.95 kit
DT-2100468	1968 All.....	99.95 kit
DT-2100469	1969 Chevelle.....	99.95 kit
DT-2100470	1970 Chevelle.....	99.95 kit

Note: See note under led flasher.

DT-200002



**Electronic LED Flasher**

This electronic LED flasher is recommended for use with LED tail lights and parking lights.

DT-200002	LED Flasher 2 Prong.....	19.95 ea.
DT-200003	LED Flasher 3 Prong.....	24.95 ea.

Note: If LED front parking lights are the ONLY LED lights you're installing, then you do not need an electronic LED flasher. If you are installing both LED tail light AND LED front lights then two electronic LED flashers are required. Housing and lenses are not included.

DT-200010



**LED Turn Signal Bulbs**

These LED light bulbs are the perfect complement to your new Digi-Tails tail lights for applications where specific parking light kits are not available.

DT-200010	1157 LED Amber Bulb.....	19.95 ea.
DT-200015	1157 HP LED Amber Bulb, 11 Watt.....	31.95 ea.



LSB-4523 Installed



LSB-4524

**1968 Side Markers**

Beautiful die cast triple chrome plated engine call-outs. Lenses are as original.

LSB-4520	1968 Front 307.....	95.99 pr.
LSB-4521	1968 Front 327.....	95.99 pr.
LSB-4522	1968 Front 350.....	93.99 pr.
LSB-4523	1968 Front 396.....	64.99 pr.
LSB-4524	1968 Front 427.....	86.99 pr.
LSB-459	1968 Front No Engine Size.....	8.99 ea.
LSG-X68	Gaskets w/ No Engine Size (4).....	6.99 kit
LSG-4166	Gaskets w/ Engine Size (2).....	7.99 kit
LSM-9885	1968 Lens.....	8.99 ea.



LSM-2143



LSM-7103



LSB-350

**1969 350 Front Sidemarker Bezels**

Correct side marker bezel, includes triple chrome plating and black accenting as original.

LSB-350	1969 "350".....	105.99 pr.
---------	-----------------	------------



LSM-777A

**1969 Side Marker Nuts**

Set of 8 PAL type self threading nuts for 3/16 studs.

LSM-777A	1969 (8 pc.).....	7.99 ea.
----------	-------------------	----------

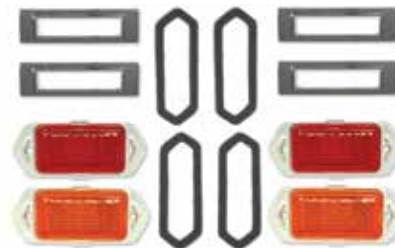

**1969 Side Markers**

LSB-749K

Chrome bezels and correct lenses with markings.

LSB-749K	Complete Kit.....	85.42 kit
LSB-749	Chrome Bezel.....	6.99 ea.
LSB-E689R	1969 El Camino Rear.....	34.99 ea.
LSG-69A	Gaskets (4 pc.).....	6.99 kit
LSM-6813	Front Lens.....	14.99 ea.
LSM-6847	Rear Lens.....	14.99 ea.

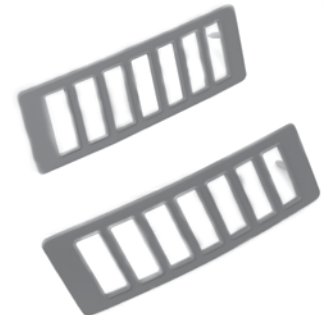

LMB-70

**1970-72 Side Markers**

Correct paintable bezels and lenses with original colors and markings. Buy the rear bezels, gaskets, & lenses and save!

LSM-2143	1970 Front Lenses.....	44.99 pr.
LSM-7103	1970-72 Rear Lenses.....	52.99 pr.
LSM-7103K	Complete Rear Kit.....	98.97 kit
LMB-70	1970-72 Bezels.....	49.99 pr.
LMG-3	1970-72 Gaskets.....	6.99 pr.



LSM-4890



LSM-4895



LMB-4790

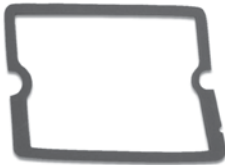

LSG-4895G

**1973-77 Side Markers**

Correct paintable bezels and lenses with original colors and markings.

LSM-4890A	1973-77 All Front LH .....	33.99 ea.
LSM-4890	1973-77 All Front RH .....	33.99 ea.
LSB-7377F	1973-77 All Front Bezels LH/RH .....	34.99 pr.
LSB-7377RL	1973-77 Chevelle Rear Bezel LH .....	22.99 ea.
LSB-7377RR	1973-77 Chevelle Rear Bezel RH .....	22.99 ea.
LSM-4895A	1973-77 El Camino Rear LH .....	33.99 ea.
LSM-4895	1973-77 El Camino Rear RH .....	33.99 ea.
LMB-4790	1973-77 Wagon, El Camino Rear Bezels .....	51.99 pr.
LSG-4895G	1973-77 El Camino Rear Gasket .....	3.95 ea.

**DIGITALS**



DT-200008

**LED Side Marker Bulbs**

A simple direct replacement for your side marker light bulb. This LED bulb features 6 super bright LEDs in a 194/T10/160 bulb package. Excellent to increase brightness and reduce heat and power consumption.

DT-200008	194 Red LED Bulbs .....	15.95 pr.
DT-200009	194 Amber LED Bulbs .....	15.95 pr.



**1970-72 El Camino Tail Lamp Reflectors**

Correct rear tail lamp reflectors made with GM tooling.

LTR-A4869	1970-72 El Camino .....	28.99 pr.
-----------	-------------------------	-----------



LSM-A4710A



**1980-1981 Malibu/El Camino Marker Light Lens**

Replace your cracked or missing original marker lens with this brand new lens which is constructed to original specifications. Original GM part # 915247 LH, 915248 RH. Made in USA.

LSM-A4710A	1980-81 Malibu/El Camino LH .....	82.99 ea.
LSM-A4710	1980-81 Malibu/El Camino RH .....	82.99 ea.

LSM-A1678



LMG-119



**1981-1988 Monte Carlo Side Marker Lamp Assemblies**

Replace your cracked or missing original side markers with these brand new assemblies made from original GM tooling! Original GM part #'s 5972203 and 5972205. Made in USA.

LSM-A1678	Monte Carlo* .....	56.99 pr.
LMG-119	Gaskets .....	6.99 pr.

\* Except 86 LS.



GSS-883

**Side Marker Sockets**

Correct side marker sockets.

GSS-883	1968-72 All .....	5.95 ea.
GSS-893	1969-77 All 90 Degree (158 & 194 Bulb) .....	5.95 ea.



GLS-157

**Tail Lamp Sockets**

Correct sockets for bulb.

GLS-157	1964-68 All .....	8.95 ea.
GLS-154	1969-72 All .....	11.95 ea.



DT-200008



DT-200016

**LED Dash Bulbs**

A simple direct replacement for your original 194 style dash light bulbs. Excellent to increase brightness and reduce heat and power consumption.

DT-200008	194 Red LED Bulbs .....	15.95 pr.
DT-200009	194 Amber LED Bulbs .....	15.95 pr.
DT-200016	194 White LED Bulbs .....	16.95 pr.



500626

**Classic Dash LED and Terminal Kit**

This is the same LED kit for your turn signals, high beam indicator and brake light that is included with our complete Classic Dash panel kits. It can be used when buying a blank panel only.

500626	1964-88 .....	29.99 kit
--------	---------------	-----------

No Volume Discount.



**LED Accent Strips**

These LED accent strips can be used for highlighting or mood lighting. Using strong double-sided tape, these can be mounted inside your car or under the hood.

LED-12-RED	12" Strip .....	20.99 ea.
LED-12-BLUE	12" Strip .....	20.99 ea.

**BUY'N SAVE**  
WITH KITS



LBR-1380K



LBR-1100K



LBR-1381KIT



**1967-1969 Tail Lamp Kits**

Includes (2) bezels, (2) lenses and (2) gaskets for an easy and convenient replacement!

- LBR-1100K 1967 Chevelle..... 194.36 kit
- LBR-1380K 1968 Chevelle..... 226.76 kit
- LBR-1381KIT 1969 Chevelle..... 192.56 kit



**Tail Lamp Lenses**

Reproduction tail lamp lenses featuring correct colors and markings.



LTL-103K 1964 Chevelle..... 47.99 pr.



LTL-64E 1964 El Camino ..... 44.95 pr.



LTL-4205 1965 w/ Chrome ..... 67.99 pr.  
LTL-4206 1965 w/o Chrome Trim ..... 50.99 pr.



LTL-65E 1965 El Camino ..... 54.99 pr.



LTL-812T 1966 Chevelle Tail Lenses.....20.99 ea.

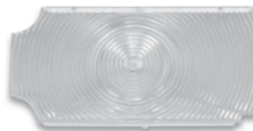

LTL-814D 1966 Chevelle Diffusers..... 17.99 ea.

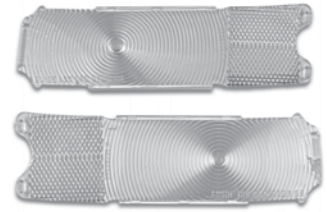

LTL-66D 1966 El Camino Diffusers ..... 24.95 pr.



LTL-66E 1966 El Camino ..... 59.95 pr.



LTL-8449 1967 Chevelle..... 44.99 pr.



LTL-67E 1967 El Camino ..... 66.95 pr.



LTL-68 1968 Chevelle..... 88.99 pr.



LTL-1097 1969 Chevelle..... 69.99 pr.



LTL-89K 1968-69 El Camino..... 69.95 pr.



**1969 Inner Tail Light Seal**

Correct inner tail light housing to body seal.

LBG-69-INNER 1969 ..... 44.99 pr.



LTL-288K 1970 Chevelle..... 99.95 pr.



LTL-7K 1970-72 El Camino..... 59.99 pr.



LA-4402 1971 Chevelle..... 129.98 pr.



LA-4407 1972 Chevelle..... 129.98 pr.



LTL-4874A 1973-77 El Cam/Wagon LH ..... 43.99 ea.  
LTL-4874 1973-77 El Cam/Wagon RH..... 43.99 ea.



LTL-0695 LTL-0697



LTL-8187L



LTL-8387R

**1978-1986 Monte Carlo/El Camino Tail Light Lens**

These are complete assemblies with red lenses, black housing, clear backup lens and all D.O.T. and Guide markings. 100% original made with the GM tooling and licensed by GM Restoration Parts. Monte Carlo lenses come with center emblem.

- LTL-0695 1978 El Camino LH ..... 107.99 ea.
- LTL-0697 1978 El Camino RH ..... 107.99 ea.
- LTL-8187L 1981-86 Non SS LH ..... 186.99 ea.
- LTL-8187R 1981-86 Non SS RH ..... 186.99 ea.
- LTL-8387L 1983-88 SS LH ..... 186.99 ea.
- LTL-8387R 1983-88 SS RH ..... 186.99 ea.

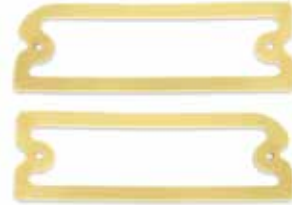

LTG-5184

**Tail Lens Gaskets**

Correct die stamped OEM material.

- LTG-5184 1964 Chevelle..... 7.99 kit
- LTG-1430 1964 El Camino ..... 6.99 kit
- LTG-5185 1965 Chevelle..... 6.99 pr.
- LTG-1432 1965 El Camino ..... 6.99 kit
- LTG-5186 1966 Chevelle..... 6.99 pr.
- LTG-1434 1966 El Camino ..... 6.99 kit
- LTG-5192 1967 Chevelle..... 6.99 pr.
- LTG-1436 1967 El Camino ..... 6.99 kit
- LTG-5210 1968 Chevelle..... 6.99 pr.
- LTG-5211 1969 Chevelle..... 6.99 pr.
- LTG-1438 1968-69 El Camino..... 6.99 kit
- LTG-5201 1970 Chevelle..... 6.99 pr.
- LTG-5212 1971-72 Chevelle ..... 6.99 pr.
- LTG-1440 1970-72 El Camino ..... 6.99 kit
- LTG-328 1973-77 El Camino ..... 6.99 kit

**DIGITAILS**



DT-1100466



DT-1100469



DT-1100470

**Digi-Tails LED Tail Lights**

Dramatically enhance your tail lights with safer, brighter and fully sequential LED light panels that are easy to install.

- DT-1100466 1966 Chevelle..... 199.95 kit
- DT-1100467 1967 Chevelle..... 199.95 kit
- DT-1100468 1968 Chevelle..... 199.95 kit
- DT-1100469 1969 Chevelle..... 199.95 kit
- DT-1100470 1970 Chevelle..... 199.95 kit
- DT-1100471 1971-72 Chevelle ..... 199.95 kit
- DT-1101086 1978-88 Monte Carlo ..... 219.95 kit

*Does not include lenses, housings or gaskets. No Volume Discount.*



**Dakota Digital LED Tail Light Conversion Kit**

Dakota Digital LED lighting systems are engineered to utilize your existing wiring harness, tail light lens and assembly. Whether you have OEM wiring or have updated to a new style harness, installation is effortless! LED Modules are included for both left and right rear brake lights. Dakota Digital Tail Lights include the LED brake / tail light modules, wiring and moisture resistant crimp-on connectors. Dakota Digital LED Tail Light Modules are backed by a Limited Lifetime Warranty.

- LAT-NR160 1964-66 Chevelle ..... 171.95 kit
- LAT-NR170 1967 Chevelle..... 233.95 kit
- LAT-NR180 1968 Chevelle..... 233.95 kit
- LAT-NR310 1969 Chevelle..... 233.95 kit
- LAT-NR320 1970 Chevelle..... 233.95 kit
- LAT-NR160 1971-72 Chevelle ..... 171.95 kit

*Does not include lenses, housings or gaskets. No Volume Discount.*

**BUY'N SAVE**  
WITH KITS



**1966 Chevelle Lens Kit**

Complete kit with tail lamp lenses, reverse lenses and diffusers lenses.

LKIT-66 1966 Chevelle..... 106.15 kit



**1966 Lens & Bezel Kit**

This kit contains all items needed to give your rear a make over; all (2) lenses, (2) bezels, (2) retainers and a complete set of clips.

LBZKIT-66 1966 Chevelle..... 231.14 kit



LKIT-71A



LKIT-72A

**1971-72 Lens Kits**

This is a set of 4 high quality reproduction Chevelle tail lamp lenses. These lenses features the original part numbers and Guide molded into the lens like the originals. When originality counts, it doesn't get any better than this! Made in USA. Kits include: (2) tail lamp and (2) reverse light lenses.

LKIT-71A 1971 Chevelle ..... 246.96 kit

LKIT-72A 1972 Chevelle ..... 246.96 kit

No Volume Discount.



**1966 Chevelle Bezels & Clips**

Beautifully reproduced anodized aluminum.

LTB-2310 1966 Chevelle..... 62.95 pr.  
LTR-CLIP 1966 Chevelle..... 11.95 set



**1966 Chevelle Retainers**

Correct tail lamp retainers.

LTB-2315 1966 Chevelle..... 31.99 ea.



**Tail Lens Housings**

Reproductions of these hard to find tail lamp housings.

LTH-65 1965 w/ Gaskets..... 139.99 pr.  
LTH-67L 1967 LH..... 219.99 ea.  
LTH-67R 1967 RH..... 219.99 ea.  
LTH-68L 1968 LH..... 219.99 ea.  
LTH-68R 1968 RH..... 219.99 ea.  
LTH-69L 1969 LH..... 219.99 ea.  
LTH-69R 1969 RH..... 219.99 ea.  
LTH-70K 1970 Pair..... 129.99 pr.  
LTH-712 1971-72 Chevelle LH/RH ..... 299.99 set  
LTH-73L 1973-77 El Camino/Wagon LH ..... 77.99 ea.  
LTH-73R 1973-77 El Camino/Wagon RH ..... 77.99 ea.  
LTH-70-RETNR 1970-75 All Housing Retainer ..... 11.99 ea.  
*1970 constructed of high quality plastic.*



**El Camino Tail Lens Bezels**

Reproduction tail lamp bezels for your El Camino.

LTH-E4 1964 Bezels ..... 142.99 pr.  
LTH-G4 1964-65 Gaskets..... 21.95 pr.  
LTH-E5 1965 Bezels ..... 142.99 pr.  
LTH-E9 1968-69 Bezels ..... 139.99 pr.  
LTH-G9 1968-69 Gaskets..... 21.95 pr.  
LTH-E7 1970-72 Bezels..... 139.99 pr.  
LTH-G7 1970-72 Gaskets..... 21.95 pr.



LBR-1100



LBR-1380



LBR-1381



**Tail Lens Bezels**

Beautiful die cast and triple chrome plated bezels with correct semi-black accenting, original grain and mounting studs.

LTB-2310 1966 Chevelle..... 62.95 pr.  
LBR-1100 1967 Chevelle..... 149.99 pr.  
LBR-1380 1968 Chevelle..... 139.99 pr.  
LBR-1381 1969 Chevelle..... 129.99 pr.

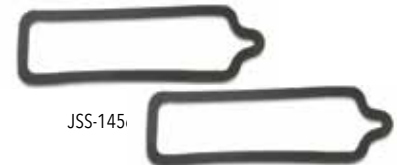

JSS-145

**Tail Lamp Bezel Gaskets**

Correct sponge tail lamp bezel gaskets for Chevelles.

JSS-1456 1966 (To Body)..... 5.99 pr.  
JSS-5196 1967 (To Body)..... 13.99 pr.  
LBG-68 1968 ..... 15.99 pr.  
LBG-69 1969 ..... 6.99 pr.  
LBG-68-INNER 1968 (To Body)..... 12.99 pr.  
LBG-69-INNER 1969 (To Body)..... 44.99 pr.



JQS-66

**Quarter Panel Extension Seal**

Correct seal between extension and 1/4 panel.

JQS-66 1966-67 Chevelle ..... 9.99 pr.  
JQS-68 1968-69 Chevelle ..... 9.99 pr.



LBL-64N

LBL-64N 1964 Chevelle..... 49.95 pr.



LBL-4230

LBL-4230 1965 Chevelle..... 34.99 pr.



LTL-813R

LTL-813R 1966 Chevelle..... 19.99 ea.  
LTL-66R 1966 El Camino ..... 32.95 pr.  
LBL-81E 1969-72 El Camino..... 25.99 ea.



LBL-4230

LBL-4230 1967 Chevelle..... 34.99 pr.



LBL-4235

LBL-4235 1968 Chevelle..... 28.99 pr.



LA-4422

LA-4422 1971 Chevelle..... 129.98 pr.



LA-4426

LA-4426 1972 Chevelle..... 129.98 pr.



LTL-4875A

LTL-4875A 1973-77 El Cam/Wagon LH..... 51.99 ea.  
LTL-4875 1973-77 El Cam/Wagon RH..... 51.99 ea.



LHA-2310



**Reverse Housings**

Complete reverse housings ready to install with lenses and gaskets.

LHA-2310 1965 Chevelle..... 44.99 ea.  
LHA-2310 1967 Chevelle..... 44.99 ea.  
LHA-2310K 1965-67 Chevelle ..... 80.98 kit  
LHA-2315 1968 Chevelle..... 49.99 ea.  
LRH-2320 1969-72 El Camino..... 74.99 ea.

LBA-2620



**Rear Bumper Reflector Assemblies**

Complete gold cadmium housing with lenses.

LBA-2620 1969-72 El Camino..... 58.99 pr.

DT-200005



**DIGITAILS**

**LED Reverse Bulbs**

These LED reverse light bulbs are the perfect complement to your new Digi-Tails LED tail lights.

DT-200005 1156 LED Reverse Bulb..... 19.95 ea.  
DT-200014 1156 HP LED Reverse Bulb,  
11 Watt..... 32.95 ea.



DT-200016

**DIGITAILS**

**LED License Plate Bulbs**

A simple direct replacement for your side marker or license plate light bulb. This WHITE LED bulb features 5 dual super bright LEDs in a 194 bulb package. Excellent to increase brightness and reduce heat and power consumption.

DT-200016 194 White LED Reverse Bulbs..... 16.95 pr.

Note: Also can be used for side marker or dash.

GPS-558



**License Plate Socket**

Correct socket for license plate bulb.

GPS-558 1964-69 All..... 4.95 ea.



LPL-338



LPL-1G

**License Plate Lenses**

Correct SAE lenses.

LPL-338 1966-72 All ..... 8.99 ea.  
LPL-1G 1966-72 Gasket ..... 4.99 ea.  
LPL-0810 1978-87 El Camino ..... 44.99 ea.



MEH-8553

MEH-1576



**License Plate Lamps**

Complete lamp assemblies with lenses.

MEH-8553 1964-65 All ..... 21.99 ea.  
MEH-1576 1966-72 All ..... 19.95 ea.



LTS-58

**Lens Screws**

Correct GM style screws for parking lamp lenses and tail lenses.

LTS-58 5/8" Long ..... 2.99 pr.  
LTS-34 3/4" Long ..... 2.99 pr.  
LTS-10 1" Long..... 2.99 pr.  
LTS-12 1 1/4" Long..... 2.99 pr.  
LTS-130 1 5/16" Long ..... 2.99 pr.  
LTS-712 1 1/4" Long ..... 1.50 pr.



BULB-69AX



**Exterior Bulb Kits**

Vehicle specific kits include (2) Park/Turn Signal Lights, (4) Side Marker Lights (except 1964-67), (2) Reverse Lights, (2) Tail/Stop Lights & Turn Signals, (1) License Light.

BULB-65AX 1964-65 ..... 17.99 kit  
BULB-66AX 1966-67 ..... 17.99 kit  
BULB-68AX 1968 ..... 17.99 kit  
BULB-69AX 1969-70 ..... 18.99 kit  
BULB-71AX 1971 ..... 18.99 kit  
BULB-69FX 1972 ..... 18.99 kit





LD-79-OE

**Door Lock Sets**

Brand new door lock cylinders complete with the correct attaching clips and gaskets.

LDL-X62B	1964-66 Early Octagon Style Key Correct Groove.....	33.99 kit
LDL-X62A	1967-68 Early Octagon Style Key .....	21.99 kit
LDL-X62SK	1964-76 Early Style Square Key .....	18.99 kit
LDL-X62RK	1964-76 Late Style Round Key .....	20.99 kit
LD-79-OE	1977-79 El Camino Round Key.....	23.99 kit



LDT-678-OE

**Door & Trunk Lock Sets OE Style Keys**

Brand new door and trunk lock cylinders keyed alike.

LDT-X62	1964-66 Chevelle Late Style Pear Key ....	29.99 kit
LDT-X69	1964-66 Chevelle Late Style Round Key .....	26.99 kit
LDT-67X	1967 Chevelle Round Key w/ Knockout.....	44.99 kit
LDT-689	1967 Chevelle Round Key w/o Knockout.....	24.99 kit
LDT-678-OE	1967 Chevelle Pear Key w/ Knockout.....	35.99 kit
LDT-68-OE	1968 Chevelle Pear Shaped Key w/ Knockout .....	52.99 kit
LDT-X69	1968-81 Chevelle/Malibu Late Style Round Key .....	26.99 kit



LCK-66A-OE

**Ignition Door & Trunk Lock Sets One Key Opens All**

Brand new ignition, door and trunk lock cylinders keyed alike. Although not factory correct, we all can agree that one key makes it easier!

LCK-X62IDT	1964 Octagon Style Key.....	47.99 kit
LCK-X65IDT	1965 Octagon Style Key.....	47.99 kit
LCK-X667IDT	1966 Octagon Style Key.....	47.99 kit
LCK-66A-OE	1966 Octagon Style Key.....	62.99 kit
LCK-67A-OE	1967 Octagon Style Key.....	62.99 kit
LCK-X68IDT	1968 Octagon Style Key .....	69.99 kit
LCK-X69IDT	1969-77 Octagon Style Key .....	64.99 kit



LID-69F

**Ignition & Door Locks**

Brand new lock cylinders and "keyed" alike keys complete with correct attaching clips and gaskets.

LID-64A	1964 All Octagon Key .....	54.99 kit
LID-6X	1964 All Square Key.....	32.99 kit
LID-65A	1965 All Octagon Key .....	39.99 kit
LID-66-OE	1966 All OE Correct Octagon Key .....	43.99 kit
LID-67F	1966-67 All Octagon Key .....	38.99 kit
LID-67SK	1966-67 All Square Key .....	36.99 kit
LID-67X	1966-67 All Replacement Style Key .....	28.99 kit
LID-68F	1968 All Octagon Key .....	38.99 kit
LID-68SK	1968 All Square Key.....	34.99 kit
LID-69F	1969-72 All Square Key .....	38.99 kit
LID-79-OE	1979-81 Malibu Square Key .....	34.99 kit



LI-65-OE

**Ignition Lock Sets OE Style Keys**

Brand new OE style ignition lock.

LI-64-OE	1964 All Pear Shaped Key w/o Knockout .....	16.99 kit
LI-65-OE	1965 All Pear Shaped Key w/o Knockout .....	15.99 kit
LI-66-OE	1966 All Pear Shaped Key w/o Knockout .....	17.99 kit
LI-67OE	1966-67 All Pear Shaped Key w/ Knockout .....	15.99 kit
LI-67SK	1966-67 All Square Shaped Key w/ Knockout .....	13.99 kit
LI-68-OE	1968 All Pear Shaped Key w/ Knockout .....	21.99 kit
LI-68SK	1968 All Square Shaped Key w/o Knockout .....	19.99 kit
LI-69-OE	1969-78 All Square Shaped Key w/o Knockout .....	21.99 kit
LI-69-OEKO	1969-78 All Square Shaped Key w/o Knockout .....	44.99 kit
LI-79-OE	1979-84 All Square Shaped Key w/o Knockout .....	22.99 kit



LGT-69A

**Glove Box & Trunk Locks**

Brand new lock cylinders and "keyed" alike keys complete with correct attaching clips and gaskets.

LGT-64A	1964-65 All .....	38.99 kit
LGT-66A	1966 All .....	34.99 kit
LGT-67A	1967 All .....	39.99 kit
LGT-68A	1968 All .....	39.99 kit
LGT-69A	1969 All .....	36.99 kit
LGT-70A	1970-72 .....	33.99 kit



LG-68A-OE

**Glove Box Lock Sets OE Style Keys**

Brand new OE style correct glove box lock set with keys.

LG-645-OE	1964-65 All Pear Shaped Key w/o Knockout .....	20.99 kit
LG-667-OE	1966-67 All Pear Shaped Key w/ Knockout .....	20.99 kit
LG-68A-OE	1968 All Pear Shaped Key w/ Knockout .....	21.99 kit
LG-69-OE	1968-69 All Round Shaped Key w/ Knockout .....	16.99 kit
LG-70-OE	1970-77 All Pear Shaped Key w/o Knockout .....	16.99 kit
LGC-6881	1968-77 All Lock Casing Only .....	11.99 kit



LGT-68X

**Glove Box Trunk Lock Sets OE Style Keys**

Brand new OE style correct glove box, trunk, lock set keyed alike. Although not factory correct, we all can agree that one key makes it easier!

LGT-64A	1964-65 Chevelle Round Style Key.....	38.99 kit
LGT-66A	1966 Chevelle Round Style Key.....	34.99 kit
LGT-67A	1967 Chevelle Round Style Key .....	39.99 kit
LGT-68A	1968 Chevelle Pear Shaped Key w/ Knockout .....	39.99 kit
LGT-68X	1968 Chevelle Round Style Key .....	34.99 kit
LGT-69A	1969 Chevelle Round Style Key w/ Knockout .....	36.99 kit
LGT-70A	1970-72 Chevelle Round Style Key w/ Knockout .....	33.99 kit



LGC-70-OE

**Glove Box Trunk & Console Lock Sets OE Style Keys**

Brand new OE style correct glove box, trunk and console lock set keyed alike. Although not factory correct, we all can agree that one key makes it easier!

LGC-66-OE	1966 Chevelle* .....	49.99 kit
LGC-67-OE	1967 Chevelle* .....	52.99 kit
LGC-70-OE	1970-72 Chevelle Round Style Key.....	59.99 kit

\*Without glove box lock casing.



ICL-13

ICK-70

ITW-8115

LC-66

**Console Locks**

Correct console locks with keys.

ICK-70	1970-72 Lock Catch .....	12.99 ea.
ICL-13	1970-72 Lock .....	24.99 ea.
ITW-8115	1970-72 Lock Retainer.....	13.99 ea.
LC-66	1966-67 Lock .....	28.99 ea.
ICL-13K	1970-72 Lock & Retainer Set.....	36.95 kit
ICL-13-PB	1970-1972 Push Button .....	23.99 ea.



**BUY 'N SAVE WITH KITS**

**Complete Lock Kits**  
Our lock kits come complete with ignition and doors keyed alike and glove box and trunk (except El Camino) keyed alike just as original. We also include all necessary clips & gaskets.

LCK-64	1964 Chevelle	79.88 kit
LCK-64E	1964 El Camino	49.99 kit
LCK-65	1965 Chevelle	71.08 kit
LCK-65E	1965 El Camino	54.99 kit
LCK-66	1966 Chevelle	62.88 kit
LCK-66E	1966-67 El Camino	44.99 kit
LCK-67	1967 Chevelle	67.13 kit
LCK-68A	1968 Chevelle	71.08 kit
LCK-68E	1968 El Camino	49.99 kit
LCK-69A	1969 Chevelle	64.58 kit
LCK-69E	1969 El Camino	42.99 kit
LCK-70A	1970-72 Chevelle	62.03 kit
LCK-70E	1970-76 El Camino	44.99 kit
LCK-77E	1977 El Camino	60.99 kit



**Complete Lock Sets OE Style Keys One Key Opens All**  
Brand new ignition, door, glove box and trunk lock cylinders keyed alike.

LCK-64A-OE	1964 Chevelle Octagon Key	61.99 kit
LCK-64E	1964 El Camino Octagon Key	49.99 kit
LCK-65A-OE	1965 Chevelle Octagon Key	61.99 kit
LCK-65E	1965 El Camino Octagon Key	54.99 kit
LCK-66A-OE	1966 Chevelle Octagon Key	62.99 kit
LCK-66E	1966-67 El Camino Octagon Key	44.99 kit
LCK-67A-OE	1967 Chevelle Original Style Key	62.99 kit
LCK-X68IDGT	1968 Chevelle Early Style Key	64.99 kit
LCK-68E	1968 El Camino Octagon Key	49.99 kit
LCK-X69IDGT	1969 Chevelle Octagon Key	69.99 kit
LCK-69E	1969 El Camino Octagon Key	42.99 kit
LCK-70A-OE	1970-77 Chevelle Octagon Key	72.99 kit
LCK-70E	1970-76 El Camino Square Key	44.99 kit
LCK-77E	1977 El Camino Square Key	60.99 kit
LCK-78E	1978-87 El Camino Square Key	48.99 kit



**Door Lock Pawls**  
Correct bracket that attaches to the end tip of the door lock cylinder. The pawl trips the inner door latch assembly to open the door.

LP-1130	1964-65 RH	6.99 ea.
LP-1129	1964-65 LH	6.99 ea.
LP-1106	1966-67 RH	6.99 ea.
LP-1107	1966-67 LH	6.99 ea.
LP-1108	1968-72 RH	6.99 ea.
LP-1109	1968-72 LH	6.99 ea.
LPC-7	1964-72 All Door Lock Pawl Clip	1.69 pr.



**Concours Lock Sets**  
This is a complete ignition and door lock set which includes OEM lock cylinders, keys, clips and gaskets. These concours correct lock sets are accepted by most judges as original. The keys have the correct knockouts and the code stamped into the key.

LID-69-OE	1969	66.99 kit
LID-70-OE	1970	66.99 kit
LID-71-OE	1971	66.99 kit
LID-72-OE	1972	66.99 kit



**Inner Door Lock Rod & Bellcrank**  
Plated reproduction threaded inner lock rod with attached bellcrank fits RH or LH door.

RLR-247	1969-1972 Chevelle	18.99 ea.
---------	--------------------	-----------

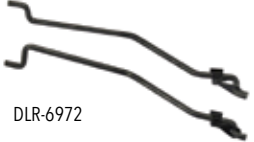

**1969-1972 Power Door Lock Actuator Rods**  
Power door lock actuator rods with clips. These rods go from the door latch to the power door lock solenoid.

DLR-6972	1969-72 All Front	29.99 pr.
----------	-------------------	-----------

*No volume discount.*



**Door/Trunk Lock Bracket**  
Correct bracket for retaining lock cylinder in place.

LTB-90	1964-72 All	2.99 ea.
--------	-------------	----------



**Trunk Lock Retainer**  
Reproduction of this hard to find bracket.

LTR-5	1968-72 Chevelle	22.99 ea.
-------	------------------	-----------



**Door, Glove Box, & Trunk Lock Sets OE Style Keys One Key Opens All**  
Brand new door, glove box and trunk lock cylinders keyed alike. Although not factory correct, we all can agree that one key makes it easier!

LDT-64-OE	1964-65 Chevelle Pear Shaped Key w/ Knockout	51.99 kit
LDT-66-OE	1966 Chevelle Pear Shaped Key w/ Knockout	52.99 kit
LDT-678-OE	1967 Chevelle Pear Shaped Key w/ Knockout	35.99 kit
LDT-67-OE	1967 Chevelle Pear Shaped Key w/ Knockout	45.99 kit
LDGT-70-OE	1967 Chevelle Round Key w/o Knockout	42.99 kit
LDT-68-OE	1968 Chevelle Pear Shaped Key w/ Knockout	52.99 kit



**Door Latch Assemblies**  
Reproduction door latch assemblies.

RDL-67AL	1966-67 LH	79.99 ea.
RDL-67AR	1966-67 RH	79.99 ea.
RDL-67AK	1966-67 Kit LH/RH	143.98 kit
RDL-68AL	1968 LH	79.99 ea.
RDL-68AR	1968 RH	79.99 ea.
RDL-68AK	1968 Kit LH/RH	143.98 kit
RDL-69AL	1969 LH	79.99 ea.
RDL-69AR	1969 RH	79.99 ea.
RDL-69AK	1969 Kit LH/RH	143.98 kit
RDL-70AL	1970-72 LH	79.99 ea.
RDL-70AR	1970-72 RH	79.99 ea.
RDL-70AK	1970-72 Kit LH/RH	143.98 kit



**Trunk Lock Sets**  
Brand new OE style trunk lock. Complete with retainer and lock rod.

LT-67RD	1964-66/68-77 Chevelle Round Key	15.99 kit
LTL-67K-OE	1964-66/68 Chevelle Pear Shaped Key w/ Knockout	17.99 kit
LT-67B-RD	1967 Chevelle Round Key	18.99 kit
LT-67-OE	1967 Chevelle Pear Shaped Key w/ Knockout	18.99 kit



**Trunk Lid Latch**  
Correct locking latch which installs inside the trunk lid.

RTL-1019	1964-72	29.95 ea.
----------	---------	-----------



**Trunk Lock Rods**  
Correct rod/shaft that connects the cylinder to the lock assembly.

TLR-458	1964-67 Chevelle	3.99 ea.
TLR-478	1968-72 Chevelle	4.99 ea.

### Grille Emblems

High quality reproduction and GM original grille emblems to freshen up your front end.



TG-387  
 TG-387 1965 Chevelle Bowtie..... 64.99 ea.



TO-1095  
 TO-1095 1966 Chevelle..... 99.99 ea.



TC-4499  
 TC-4414 1967 Bowtie..... 92.99 ea.  
 TC-4499 1968 Bowtie..... 94.99 ea.



TC-4310  
 TC-4310 1966 SS396..... 59.99 ea.  
 TC-4411 1967 SS396..... 66.99 ea.  
 TC-4413 1967 SS427..... 86.99 ea.  
 TC-4500 1968 SS396..... 72.99 ea.  
 TC-4600 1969 SS396..... 61.99 ea.  
 TK-6717 1968 SS427..... 75.99 ea.



### 427 Super Car Emblem

This emblem (GM number 3901932) was originally used on 1967 427 Impalas but it was also used by super car dealers on a lot of their conversions on fenders, hoods and trunk lids. Baldwin Motion used these emblems on the fenders of their super cars in 1969. Perfect for any super car, tribute car or custom!

TK-427 All..... 19.99 ea.



TG-036  
 TG-563 1970 SS..... 32.96 ea.  
 TG-036 1971 SS..... 53.99 ea.  
 TC-4775 1972 SS..... 49.99 ea.  
 TC-73SS 1973 SS..... 86.99 ea.



TG-427  
 TG-427 1969 Bowtie..... 74.99 ea.



TC-4674  
 TC-4674 1970 Bowtie..... 112.99 ea.



TC-4740  
 TC-4740 1971-72 Bowtie..... 99.99 ea.



TC-4741  
 TT-1180 1970 Chevelle..... 29.99 ea.  
 TC-4741 1971 Chevelle..... 32.99 ea.  
 TT-1180 1972 Chevelle..... 29.99 ea.



TG-4860  
 TG-4860 1970 Chevrolet..... 55.99 ea.  
 TG-4861 1971-72 Chevrolet..... 45.99 ea.



### 1964-67 Style Universal Cross Flag Emblems

These universal cross flag emblems can be mounted anywhere on your car for a nice custom touch while still looking vintage. Universal. Measures 2-7/8" x 4-1/2" with 3 pins on back.

TG-454 454..... 49.99 ea.  
 TG-502 502..... 49.99 ea.  
 TG-572 572..... 49.99 ea.



### 1980, 1982 Monte Carlo Grille Emblem

TG-1695 1980 & 1982\*..... 54.99 ea.  
 \* Not correct for 1981 models.



### 1982-87 El Camino/Malibu Chevrolet Grille Emblem

LG-0180 1982-87 El Camino/Malibu ..... 42.99 ea.

### Fender Emblems

Reproduction emblems to freshen up your fenders.



TG-498  
 TG-498 1964 Chevelle..... 39.96 pr.



TG-318  
 TC-4006  
 TC-4006 1964 V Cross Flag ..... 43.99 pr.  
 TG-318 1965-67 V Cross Flag ..... 15.99 ea.



LSB-4523  
 Beautiful die cast triple chrome plated engine call-outs. Lenses are as original.

LSB-4520 1968 Front 307..... 79.99 pr.  
 LSB-4521 1968 Front 327..... 95.99 pr.  
 LSB-4522 1968 Front 350..... 93.99 pr.  
 LSB-4523 1968 Front 396..... 64.99 pr.  
 LSB-4524 1968 Front 427..... 86.99 pr.  
 LSB-502 1968 Front 502..... 99.99 pr.  
 LSG-X68 Gaskets (4 pc.)..... 6.99 kit  
 LSM-9885 1968 Lens..... 8.99 ea.



TC-4530  
 TC-4530 1968 Malibu ..... 95.99 pr.



TG-939  
 TC-4673 1970 Malibu ..... 100.99 pr.  
 TG-939 1971-73 Malibu..... 77.99 pr.



### Motion Emblem

This universal Baldwin Motion die-cast emblem is perfect for custom projects.

TK-MOTION All..... 59.99 ea.



TG-9810 1971-72 350\*.....64.99 ea.  
Originally equipped on GMC Sprint but can be used on Chevelle and El Camino.



TG-9811 1971-72 454\*.....64.99 ea.  
Originally equipped on GMC Sprint but can be used on Chevelle and El Camino.



TG-4861

TG-4860 1970 Chevrolet.....55.99 ea.  
TG-4861 1971-72 Chevrolet.....45.99 ea.  
For El Camino.



**1969 350 Front Side Marker Bezels**

Correct side marker sockets. Triple chrome plating and black accenting as original.

LSB-350 1969 "350" ..... 105.99 pr.



**5th Gen Camaro Emblems**

These peel & stick factory GM emblems can be applied to any vintage muscle car for a powerful modern look. Perfect for poor touring cars!

T-12SSW SS White.....33.99 ea.  
T-12SSR SS Red.....34.99 ea.  
T-ZL1 ZL1.....49.95 ea.

TC-4875



TC-4875 1970 El Camino ..... 97.99 pr.  
TC-4876 1971-75 El Camino..... 95.99 pr.



TO-773 1969-72 SS (Per Side)..... 19.99 ea.  
TO-773K 1969-72 SS (2 Fenders).....35.98 pr.  
TO-773-PS Universal Chrome Peel N Stick.....18.99 pr.



TO-773B 1969-72 SS Black..... 41.99 pr.  
Order two pairs per car.



TO-773R 1969-72 SS Red ..... 45.99 pr.  
Order two pairs per car.



T-3100 1973 SS.....32.99 ea.  
Order two pairs per car.

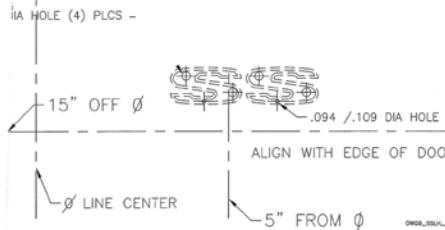

**SS Fender Template**

Convenient template which shows precise locations of SS emblems, making installation of emblems on new fenders painless.

TFT-69SS 1970-72 Chevelle .....19.95 kit



TG-833 1965-67 283..... 18.99 ea.



TG-834 1965-67 327.....14.99 ea.



TT-1430 1965-67 396 Turbo Flags..... 44.99 pr.



TT-427 1965-67 427 Turbo Flags.....44.99 ea.



TC-4651 1970-72 307..... 67.99 pr.



TC-4650 1970-72 350..... 70.99 pr.



TC-4652 1970 400..... 71.99 pr.



TT-679 1969-72 396..... 18.99 ea.



TT-1500 1970-72 454..... 33.99 pr.



TT-502 Universal w/ Pins..... 31.99 pr.

**Hood Emblems**

TC-4012

**CHEVROLET**

TC-4012 1964 Chevrolet.....59.99 kit  
TC-4216 1965 Chevrolet.....73.99 kit

**CHEVELLE**

TT-1230 1967 Chevelle.....39.99 ea.

**El Camino**

TC-4836 1967 El Camino.....47.99 ea.

**COWL INDUCTION**

**COWL INDUCTION**

TG-567 1970-72 Cowl Induction.....34.99 kit



TK-8013 1969 Yenko.....32.95 ea.



**Chrome Yenko Emblem**

While the original emblem was white this cool chrome emblem is the perfect touch to any custom.

TK-8013-C Yenko.....49.99 ea.



TK-678 1969 Yenko 427.....29.99 ea.



TT-1260 1968-69 Chevelle.....33.99 ea.



TT-1270 1969 By Chevrolet.....21.99 ea.

**el.Camino**

TP-E4851 1968-69 El Camino.....50.99 ea.



**Dick Harrell Emblem**

This universal Diecast emblem is perfect for custom projects.

DH1018 All.....59.99 ea.



**Baldwin Motion SS427 Emblem**

This emblem (GM number 7752254) was originally used on the deck lid of 1968 427 Impalas but it was also used by super car dealers on a lot of their conversions on fenders, hoods and trunk lids. Baldwin Motion often used these emblems on the valve covers of their super cars. Perfect for any super car, tribute car or custom!

TK-SS427 All.....39.99 ea.

**Quarter Panel Emblems**



TC-4011 1964 Malibu.....98.99 pr.



TC-4211 1965 Malibu.....108.99 pr.



TT-1750 1966-67 Malibu.....66.99 pr.



TC-4010 1964 Malibu SS.....100.99 pr.  
TC-4210 1965 Malibu SS.....94.99 pr.



TT-1730 1966 Super Sport.....61.99 pr.



TG-717 1967 Super Sport.....54.99 pr.



TC-4610 1969 Malibu.....94.99 pr.



TP-E4815 1964 El Camino.....147.99 pr.



TP-E4825 1965 El Camino.....152.99 pr.

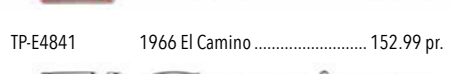

TP-E4841 1966 El Camino.....152.99 pr.

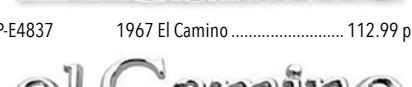

TP-E4837 1967 El Camino.....112.99 pr.



TP-E4850 1968-69 El Camino.....92.99 pr.



TP-E0855 1978-87 El Camino.....59.99 ea.92.99 pr.

**Rear Panel / Trunk Emblems**

**CHEVROLET**

TC-4149 1964-65 Chevrolet Letter.....49.99 kit



TT-1630 1964 SS Trunk.....39.99 ea.



TC-4215 1965 Malibu SS.....60.99 ea.



TC-4756 1973 SS.....86.99 ea.



TC-4208 1965 Malibu SS396.....289.99 ea.



TC-4004 1964 Bowtie (Plastic).....61.99 ea.



TC-4318 1966 Bowtie (Plastic).....59.99 ea.



TC-4313 1966 Chevelle (for SS).....109.99 ea.



TC-4314 1966 Chevelle.....114.99 ea.



TT-1760 1966 SS396.....50.99 ea.



TT-1820 1967 Chevelle Trunk.....52.99 ea.



TT-1830 1967 SS396.....41.99 ea.



TC-4501 1968 SS396.....62.99 ea.



TT-1920 1969 SS396.....43.99 ea.



TO-195S 1971-72 Rear Bumper.....44.99 ea.



TC-4502 1968 Chevelle.....53.99 ea.



TT-218 1969 Chevelle.....54.99 ea.



TT-1940 1970 Chevelle.....46.99 ea.



TT-1970 1971-72 Chevelle.....47.99 ea.

**Tailgate Emblems**



TP-E4816 1964-65 Bowtie.....75.99 ea.



TP-E4840 1966 Bowtie.....77.99 ea.



TP-E4834 1967 Bowtie.....74.99 ea.



TP-E4845 1968 Bowtie.....70.99 ea.



TP-E4873 1969-70 Bowtie.....54.95 ea.



TP-E4870 1968-70 SS396.....66.99 ea.



TP-E454 1970-72 454.....52.99 ea.



TP-E4149 1964-66 Chevrolet.....79.99 ea.



TP-E4835 1967 Chevrolet.....74.99 ea.



TP-E4852 1968-69 Chevrolet.....73.99 ea.



TP-E4880 1970-72 Chevrolet.....71.99 ea.



TP-E4881 1973-77 El Camino.....50.99 ea.



TP-ESS 1970-72 SS.....44.99 ea.



### 1967 Chevelle SS Stripes

Kit includes (2) front fender stripes, (2) rear fender stripes, (2) door stripes, (2) front quarter panel stripes, (2) rear quarter panel stripes, squeegee and instructions.

MSS-3933W	1967 SS White .....	74.95 kit
MSS-3933B	1967 SS Black .....	74.95 kit
MSS-3933R	1967 SS Red .....	74.95 kit
MSS-3933BL	1967 SS Blue .....	74.95 kit



### 1968 SS Stripes

Kit includes (1) header panel stripe, (2) front fender stripes, (2) rear fender stripes, (2) door stripes, (2) front quarter panel stripes, (2) rear quarter panel stripes, squeegee and instructions.

<b>Chevelle</b>		
MSS-4118B	1968 SS Black .....	109.95 kit
MSS-4118W	1968 SS White .....	109.95 kit
MSS-4118R	1968 SS Red .....	109.95 kit

<b>El Camino</b>		
MSS-E11B	1968 SS Black .....	109.95 kit
MSS-E11W	1968 SS White .....	109.95 kit
MSS-E11R	1968 SS Red .....	109.95 kit



### 1969 SS Stripe Kit

Kit includes (2) front fender stripes, (2) door stripes, (2) rear quarter panel stripes, squeegee and instructions.

<b>Chevelle</b>		
MSS-1966B	1969 SS Black .....	109.95 kit
MSS-1966W	1969 SS White .....	109.95 kit
MSS-1966R	1969 SS Red .....	109.95 kit
MSS-1966BL	1969 SS Blue .....	109.95 kit

<b>El Camino</b>		
MSS-E19B	1969 SS Black .....	109.95 kit
MSS-E19W	1969 SS White .....	109.95 kit
MSS-E19R	1969 SS Red .....	109.95 kit
MSS-E19BL	1969 SS Blue .....	109.95 kit



### 1969 Yenko Stripe Kit

Kit includes (1) set of SYC arrow and hood stripes, (2) front fender stripes, (2) door stripes, (2) rear quarter panel stripes (with cutouts), (2) SYC headrest decals, squeegee and instructions.

MSS-Y69	1969 Black .....	194.99 kit
MSS-Y69W	1969 White .....	189.99 kit



### 1970-72 SS Stencil Kit

Kit includes hood stripe stencils, rear deck stripes, squeegee and instructions.

MSS-2970	1970-72 Chevelle SS .....	49.99 kit
MSS-E701	1970-72 El Camino SS .....	36.99 kit



### 1971-72 Heavy Chevy Stencil Kit

Kit includes (2) front fender stripes, (2) door stripes, (2) rear quarter panel stripes, (1) Heavy Chevy header panel name, (2) Heavy Chevy fender names, (1) Heavy Chevy trunk lid name, (1) rear stripe, squeegee and instructions.

MSS-7172HC	1971-72 Black .....	229.95 kit
MSS-7172HCW	1971-72 White .....	229.95 kit



### 1973 Chevelle Stripe Kit

Kit includes (2) front fender front stripes, (2) front fender top stripes, (2) door stripes, (1) roof stripe, (2) B pillar stripes, (2) rear quarter panel stripes, squeegee, & instructions.

MSS-1973CVLB	1973 Black .....	129.95 kit
MSS-1973CVLW	1973 White .....	129.95 kit
MSS-1973CVLR	1973 Red .....	129.95 kit



### 1973-77 El Camino SS Stripe Kit

Kit includes (2) fender SS side stripes, (2) large door side stripes, (2) large rear quarter panel stripes, (1) large SS tailgate stripe, squeegee, & instructions.

MSS-73ESSB	Black .....	169.95 kit
MSS-73ESSW	White .....	169.95 kit



### Universal Rally Stripe Stencil Kit

This universal rally stripe kit makes it easy to add stripes to any year Chevelle. Based off of the 1969 Camaro Z/28 stripes this complete kit includes; (2) sets of front hood stencils, (2) trunk stencils and (1) 9/32 x 38-1/2 foot roll of stripe masking which can be cut to desired length depending on car.

MSS-0688	All .....	64.95 kit
----------	-----------	-----------

*Note: This is a universal stencil kit. Simply cut the roll of stripe masking to your desired length to add stripes to any car.*



### 1983-1988 Monte Carlo SS Stripe and Decal Kit

This is a complete Monte Carlo SS decal and stripe kit which is manufactured to meet or exceed factory specs. This GM style stripe kit will help restore your Monte Carlo SS to showroom specs. This kit includes (1) front bumper stripe, (2) front fender stripes, (2) door stripes, (2) rear quarter panel stripes, (3) Monte Carlo SS names, squeegee and instructions.

MSS-8384MCSS-BLUE	1983-84 Blue .....	239.95 kit
MSS-8586MCSS-RED	1985-86 Red .....	329.95 kit
MSS-8886MCSS-ORG	1985-86 Orange .....	329.95 kit
MSS-8788MCSS-GOLD-A	1987-88 Lt, Med, Drk* ....	319.95 kit
MSS-8788MCSS-GOLD-B	1987-88 Drk, Med, Lt* ....	319.95 kit
MSS-8788MCSS-GRAY	1987-88 Gray .....	319.95 kit
MSS-8788MCSS-RED	1987-88 Red .....	319.95 kit

\* Colors from top of car to bottom.

### Pre-Application Surface Cleaner

Remove contaminants like silicones, wax, tree sap and bug guts for a clean and adherent surface.

PREAPP	4 oz. Pre-App Cleaner .....	13.95 ea.
--------	-----------------------------	-----------



### SLIDE-ON Application Gel

Slide-On contains a special formula that resists drying until you are ready to squeegee the graphic into place. Only then does the decal "set up".

SOAG	16 oz. Application Gel .....	19.95 ea.
------	------------------------------	-----------



### SLIDE-OVER UV Protectant

Help protect your decal from harsh elements and natural aging by applying our revolutionary Slide-Over UV Protectant & Conditioner.

SOPC	8 oz. Uv Protectant .....	19.95 ea.
------	---------------------------	-----------





**Air Cleaner Decals SB**

HOJ-(Engine Horsepower)..... 8.99 ea.  
Ex. HOJ-350250 for decal above.



**Cross Flag Decals BB**

HOJ-(Engine) ..... 11.99 ea.  
Ex. HOJ-396 for decal above.



**Diecast Air Cleaner Decals**

HOJ-(Engine)-DC Diecast..... 69.99 ea.



**Turbo Jet Decals BB**

HOJ-(Horsepower)..... 11.99 ea.  
Ex. HOJ-375 for decal above.



**Diecast Turbo Jet Decals**

HOJ-(Engine) Diecast ..... 69.99 ea.



**Turbo Jet Decals 1971-74**

HOJ-(EngineHorsepower)..... 8.99 ea.  
Ex. HOJ-396300 for decal above.

**REAR**

**Air Cleaner Decal Rear**

HOJ-409 All with Cowl Induction ..... 8.99 ea.

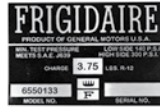

**AC Compressor Decals**

HOJ-590 1964-65 All ..... 5.99 ea.  
HOJ-599 1967-68 Red ..... 5.99 ea.  
HOJ-741 1967-68 Green ..... 5.99 ea.  
HOJ-607 1969-72 Red ..... 8.99 ea.  
HOJ-738 1969-72 Green ..... 5.99 ea.



**AIR CONDITIONED**

**AC Window Decals**

HAC-64 1964-65 ..... 5.99 ea.  
HAC-67 1966-67 ..... 8.99 ea.



**AC Box Decal**

HOJ-550 All Harrison ..... 8.99 ea.



**Brake Bail Decals**

HOJ-226 1969-70 All CN ..... 4.95 ea.



**Brake Check Valve Decal**

HOJ-333 1969-70 All CN ..... 3.95 ea.  
HOJ-335 1971-72 All CT ..... 3.95 ea.



**Turbo HydraMatic Transmission ID Tags**

Turbo HydraMatic transmission ID tag with rivet, measuring 1-1/8 inch x 1-15/16 inch. This installs on the side of the transmission case with the rivet. You must punch your own info onto the tag.

TTP-68 1968 Dark Olive ..... 29.99 ea.  
TTP-6972 1969 & 72 Yellow ..... 29.99 ea.  
TTP-70 1970 Black ..... 29.99 ea.  
TTP-71 1971 Light Blue ..... 29.99 ea.

**AS AS**

**Caliper Backing Plate Decals**

HCS-68 1968 All ..... 4.95 ea.  
HAS-70 1969 All ..... 4.95 ea.  
HDT-70 1970 All ..... 4.95 ea.



**Cooling System Decal**

HOJ-242 1970-72 All ..... 8.99 ea.



**Emission Decals**

HE-68H All Univesal ..... 8.99 ea.  
HE-CH 1969 396/375 CH ..... 8.99 ea.  
HE-DT 1970 LS6 DT ..... 8.99 ea.  
HE-U 1964-68 V8 w/o SHP ..... 8.99 ea.  
HE-CG 1969 396/325-350 CG ..... 8.99 ea.  
HE-DR 1970 396/350 4spd DR ..... 8.99 ea.  
HE-DP 1970 LS5 DP ..... 8.99 ea.  
HE-AZ 1970 LS6 AZ ..... 8.99 ea.  
HE-AX 1970 SB AX ..... 8.99 ea.  
HE-AT 1970 396/350 Auto AT ..... 8.99 ea.  
HE-CF 1969 SB CF ..... 8.99 ea.  
HE-71AT 1971 402 AT ..... 4.99 ea.  
HE-71AU 1971 454 AU ..... 8.99 ea.  
HE-72LT 1972 402 LT ..... 8.99 ea.  
HE-72LX 1972 454 LX ..... 4.99 ea.



**Coil Spring Decals**

HCS-665 1964-72 All Front ..... 7.95 ea.  
HCS-651 1964-72 All Rear ..... 7.95 ea.



**Door Jamb Decals**

HDJ-678 1967-68 Green ..... 8.99 ea.  
HDJ-69 1969 Blue ..... 7.99 ea.  
HDJ-706CA 1970-76 GM Of Canada ..... 13.99 ea.



**Fan Caution Decal**

HFA-930 All ..... 9.99 ea.



# AW AW

### Shock Decals

HSF-BL	1965 Z16 Front	7.95 pr.
HSR-BP	1965 Z16 Rear	7.95 pr.
HSF-TC	1969 SS396 F41 Front	7.95 pr.
HSR-AL	1969 SS396 F41 Rear	7.95 pr.
HSR-LU	1969 SS396 Std Rear	7.95 pr.
HSF-BK	1970 LS-6 Front	7.95 pr.
HSR-AW	1970 LS-6 Rear	7.95 pr.

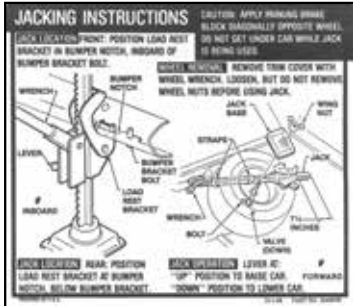

### Jacking Instructions

HJC-870	1964-66 All	8.99 ea.
HJC-871	1967 All	8.99 ea.
HJC-872	1968-69 All	8.99 ea.
HJC-715	1969 SS	8.99 ea.
HJC-873	1970 All	8.99 ea.
HJC-891	1971 All	8.99 ea.
HJC-892	1972 All	8.99 ea.

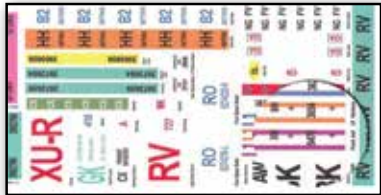

### Master Decal Kits

Convenient kit for replacing all of your factory decals for a con-course restoration. Includes brake & fuel line tags, shock & spring tags, brake cable tags, sway bars and more! Over 50 pieces.

MSKIT-6501	1965 SS396	56.99 pr.
MSKIT-6601	1966 SS396	56.99 kit
MSKIT-69	1969 SS396	56.99 kit
MSKIT-7001	1970 SS396	56.99 kit
MSKIT-705	1970 LS5	56.99 kit
MSKIT-706	1970 LS6	56.99 kit
MSKIT-75S	1970 SS Convrt	56.99 kit
MSKIT-7201	1972 LS5	56.99 kit
MSKIT-7202	1972 LS3 Convrt	56.99 kit

\*Does not include air cleaner decals.



### Air Cleaner Decal Side

HOJ-476	1968-72	8.99 ea.
HOJ-259	All w/ C.I.	8.99 ea.



### Oil Canister Decal

HOC-28	1964-67	9.99 ea.
--------	---------	----------



### Positraction Decal

HBH-797	1964-72	8.99 ea.
---------	---------	----------



### Steering Box Decals

HBA-70	1970 Power Steering BA	4.95 ea.
HDL-70	1970 Manual Steering DL	4.95 ea.



### Tire Pressure Decals

HTP-199	1964-65 All	8.99 ea.
HTP-198	1966 All	8.99 ea.
HTP-177	1967 All	8.99 ea.
HTP-172	1968 All	8.99 ea.
HTP-189	1969 All	8.99 ea.
HTP-190	1969 SS Code DW	8.99 ea.
HTP-170	1969-70 SS Code AO	8.99 ea.
HTP-173	1970-72 All	8.99 ea.

GI7775 GI7775 GI7775

GJ7776 GJ7776 GJ7776

### Trans Cooler Decal

HCL-76	1970 All w/TH	6.95 pr.
--------	---------------	----------



### Accelerator Cable Decal

AXJ-CE	1968-72 All	4.95 ea.
--------	-------------	----------

\*Correct for 1969-70.



### Tonawanda Decal

ATO-3000	All BB	8.99 ea.
----------	--------	----------



### Valve Cover Decals

HEG-66	1966-68 396/375 Manual	5.95 ea.
HJD-69	1969 396/375 Manual	5.95 ea.
HCRV-70	1970 454/450 Manual	5.95 ea.
HCRR-70	1970 454/450 Auto	5.95 ea.



### Yenko Decal Fan Shroud

HY-164	1969 Yenko S/C	10.99 ea.
--------	----------------	-----------



### Yenko Decal Valve Cover

HV-225	1969 Yenko S/C	11.99 ea.
--------	----------------	-----------

### Yenko Decal Window

HY-069	1969 Yenko S/C	10.99 ea.
--------	----------------	-----------



### Fuel Tank Stencils

Stencil kits for final detailing of fuel tank.

HTS-6401	1964	7.95 ea.
HTS-6501	1965	7.95 ea.
HTS-6601	1966	7.95 ea.
HTS-6701	1967	7.95 ea.
HTS-6801	1968	7.95 ea.
HTS-6901	1969	7.95 ea.
HTS-7001	1970	7.95 ea.
HTS-7101	1971	7.95 ea.
HTS-7201	1972	7.95 ea.

VHT-SP995



DUP-DM100



VHT-SP941



DUP-DAP1690



DUP-DAL1695



VHT-SP5251



**Engine Paint**

VHT® High Temperature Engine Enamel; Nu-Cast Aluminum; 11 oz. Aerosol  
 VHT-SP995 Nu-Cast Aluminum..... 10.99 ea.  
 VHT® High Temperature Engine Enamel; Cast Iron; 11 oz. Aerosol  
 VHT-SP997 Cast Iron..... 10.99 ea.

VHT® High Temperature Engine Enamel; Chevy Orange; 11 oz. Aerosol  
 VHT-SP123 Chevy Orange ..... 10.99 ea.

VHT® High Temperature Engine Enamel; Gloss Black; 11 oz. Aerosol  
 VHT-SP124 Gloss Black..... 10.99 ea.

VHT® High Temperature Engine Enamel; Flat Black; 11 oz. Aerosol  
 VHT-SP130 Flat Black..... 10.99 ea.

VHT® High Temperature Engine Enamel; GM Blue; 11 oz. Aerosol  
 VHT-SP135 GM Blue..... 10.99 ea.

VHT® High Temperature Engine Enamel; Motor-Brite Clear; 11 oz. Aerosol  
 VHT-SP29 Motor-Brite Clear..... 10.99 ea.

VHT® Wrinkle Plus; High Temp Wrinkle Finish; Black; 11 oz. Aerosol  
 VHT-SP201 Black Wrinkle ..... 13.99 ea.

**Trunk Paint**

Dupli-Color® Spatter Paint; Black/Gray; 11 oz. Aerosol  
 DUP-DM102 Black/Gray Spatter..... 11.99 ea.

Dupli-Color® Spatter Paint; Gray/White; 11 oz. Aerosol  
 DUP-DM100 Gray/White Spatter..... 11.99 ea.

Dupli-Color® Spatter Paint; Black/Aqua; 11 oz. Aerosol  
 DUP-DM109 Black/Aqua Spatter..... 11.99 ea.

Dupli-Color® Premium Lacquer; Clear; 12 oz. Aerosol  
 DUP-DAL1695 Clear Coat..... 9.99 ea.

AC Delco Splatter Paint Grey/White 13oz Aerosol  
 HDP-64-GW Gray/White Splatter..... 19.99 ea.

AC Delco Splatter Paint Black/Aqua 13oz Aerosol  
 HDP-68-BA Black/Aqua Splatter..... 19.99 ea.

**Vinyl Paint**

VHT Vinyl Dye Gloss Jet Black; 11 oz. Aerosol  
 VHT-SP941 Gloss Jet Black ..... 12.99 ea.

VHT Vinyl Dye White Satin; 11 oz. Aerosol  
 VHT-SP943 White Satin ..... 12.99 ea.

**Primer**

Dupli-Color® Self-Etching Primer; Green; 12 oz. Aerosol  
 DUP-DAP1690 Self-Etching Primer ..... 12.99 ea.

VHT® Prime Coat; Red Oxide; 12 oz. Aerosol  
 VHT-SP303 Red Oxide Primer..... 8.99 ea.

**Detailing Paint**

Dupli-Color® Premium Enamel; Machinery Gray; 12 oz. Aerosol. Ideal for GM shocks.  
 DUP-DA1612 Machinery Gray..... 9.99 ea.

Dupli-Color® Premium Lacquer; Flat Black; 12 oz. Aerosol  
 DUP-DAL1607 Flat Black..... 9.99 ea.

Dupli-Color® Premium Lacquer; Semi-Gloss Black; 12 oz. Aerosol  
 DUP-DAL1608 Semi-Gloss Black..... 9.99 ea.

Dupli-Color® Premium Lacquer; Gloss Black; 12 oz. Aerosol  
 DUP-DAL1677 Gloss Black..... 9.99 ea.

Dupli-Color® Premium Lacquer; Clear; 12 oz. Aerosol  
 DUP-DAL1695 Clear..... 9.99 ea.

Dupli-Color® Automotive Metallic Coating; Stainless Steel; 11 oz. Aerosol  
 DUP-SS100 Stainless Steel..... 9.99 ea.

Dupli-Color® Trim Paint; Black; 11 oz. Aerosol  
 Formulated to restore an OEM Flat Black finish to metal trim and molding around windows, body sides and other vehicle areas.  
 DUP-TP70 Black..... 9.99 ea.

VHT® Plate Finish; Chrome; 11 oz. Aerosol  
 VHT® Plate Finish™ is a unique quick drying formulation specifically created for application on metal, glass and wood or sealed plastic surfaces. This non-tarnishing epoxy finish has outstanding brilliance and corrosion resistance. VHT® Plate Finish™ is easy to use and dries in minutes. Excellent for touch-up, refinishing and decorative applications.  
 VHT-SP5251 Chrome..... 10.99 ea.

**Radiator Paint**

VHT-SP139 Radiator Black ..... 10.99 ea.



DUP-SAR102 DUP-SAR100

**Dupli-Color Spray Adhesive**

Ideal for use on vehicle carpets, headliners, accessories & more!

DUP-SAR102 Adhesive ..... 15.99 ea.

DUP-SAR100 Adhesive Remover ..... 12.99 ea.

No volume discount.



**Wheel & Tire Paint** DUP-HWP102 Shown

**Dupli-Color® Hot Tires Tire Paint; White; 0.5 oz. Paint Pen** Whether your tires are old or new, Dupli-Color® Hot Tires™ gives you a way to add color or personalize your muscle car, truck or sport compact tires. This fast-drying, durable coating allows you to touch-up faded white walls or tattoo your high performance tires. Hot Tires goes on smooth, resists fading and is available in an easy-to-use pen.  
 DUP-HT100 White Tire Paint..... 13.99 ea.

**Dupli-Color® Wheel Coating; Silver; 11 oz. Aerosol** Argent Silver for Chevrolet Rally Wheels.  
 DUP-HWP101 Argent Silver ..... 10.99 ea.

**Details® 1969-70 SS Wheel Insert Gray Paint** Correct gray for 1969-70 SS wheel inserts.  
 HDP-1214 1969-70 SS Insert Gray..... 13.99 ea.

**Dupli-Color® Wheel Coating; Graphite; 11 oz. Aerosol** Dark gray for SS 5 spoke wheels.  
 DUP-HWP102 1971+ Up SS Gray..... 10.99 ea.

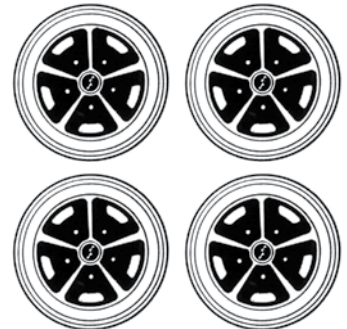

HMK-6970

**Dupli-Color Rust Barrier**

DUP-RBQ100 Quart Flat Black ..... 39.95 ea.  
 DUP-RBQ101 Quart Gloss Black..... 50.99 ea.  
 DUP-RBQ102 Quart Silver..... 50.99 ea.  
 DUP-RBG100 Gallon Flat Black..... 159.99 ea.  
 DUP-RBG101 Gallon Gloss Black ..... 159.99 ea.  
 DUP-RBG102 Gallon Silver ..... 159.99 ea.

**Dupli-Color Clear Truck Bed/Trunk Coating**

DUP-CTBA100 Aerosol..... 15.99 ea.  
 DUP-CTBQ100 Quart..... 29.99 ea.  
 DUP-CTBG100 Gallon ..... 69.95 ea.



**1969-70 SS Wheel Paint Mask Kit**

Die stamped wheel mask kit for correctly painting your SS wheels.

HMK-6970 1969-70 Wheel Mask ..... 27.95 kit



### Shop Manual Set

This set of factory manuals offers all of the information you need when you are restoring or servicing your car. Each manual is full of pictures and tutorials of everything from simple maintenance to complete removal and installation of virtually everything on the car. These are the same manuals that GM dealers used on most repair and warranty work.

HMS-65A	1965 All	.....	73.74 kit
HMS-66A	1966 All	.....	73.74 kit
HMS-67A	1967 All	.....	73.74 kit
HMS-68A	1968 All	.....	73.74 kit
HMS-69A	1969 All	.....	73.74 kit
HMS-70A	1970 All	.....	73.74 kit
HMS-71A	1971 All	.....	73.74 kit
HMS-72A	1972 All	.....	73.74 kit



### Factory Assembly Manuals

A must for all restorations! These manuals were used at the factory plants as a reference guide for linemen. These manual pages features all engineering drawings, GM numbers and torque specs.

HA-A64	1964 All*	.....	24.99 ea.
HA-A65	1965 All*	.....	24.99 ea.
HA-A66	1966 All*	.....	24.99 ea.
HA-A67	1967 All*	.....	24.99 ea.
HA-A68	1968 All*	.....	24.99 ea.
HA-A69	1969 All*	.....	24.99 ea.
HA-A70	1970 All*	.....	24.99 ea.
HA-A71	1971 All*	.....	24.99 ea.
HA-A72	1972 All*	.....	24.99 ea.

\*NOT A BOUND BOOK. Sold as loose leaf pages.



### Fisher Body Manuals

Complete information on the actual body of the car including interior, trim, door panels, glass, trunk and more!

HFB-(Year)	All	.....	26.95 ea.
------------	-----	-------	-----------

Ex. HFB-65 for 1965 Chevelle.



### Factory Owner's Manuals

Authentic reproductions of the original factory owner's manuals which came with all cars.

HDG-64A	1964 All	.....	19.99 ea.
HDG-65A	1965 All	.....	19.99 ea.
HDG-66A	1966 All	.....	19.99 ea.
HDG-67A	1967 All	.....	19.99 ea.
HDG-68	1968 All	.....	19.99 ea.
HDG-69	1969 All	.....	19.99 ea.
HDG-70A	1970 All	.....	19.99 ea.
HDG-71A	1971 All	.....	19.99 ea.
HDG-72A	1972 All	.....	19.99 ea.



### Owner's Manual Bags

Correct factory plastic bag for your owner's manual and dealer information.

HMB-1	1964-66 All	.....	14.99 ea.
HMB-2	1967-68 All	.....	14.99 ea.
HMB-3	1969-72 All	.....	14.99 ea.
HMB-4	1973-88 All	.....	14.99 ea.

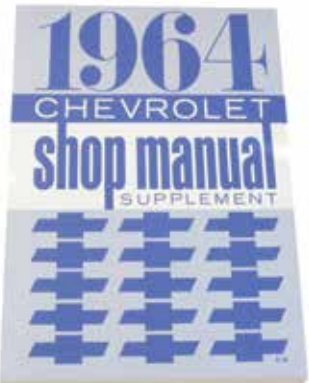

### Factory Service Manuals

This manual was used by GM dealers to service your car when new. From simple maintenance to major component repair, this manual has all of the info needed to service your car.

HSM-64	1964 All	.....	29.99 ea.
HSM-65	1965 All	.....	29.99 ea.
HSM-66	1966 All	.....	29.99 ea.
HSM-67	1967 All	.....	29.99 ea.
HSM-68	1968 All	.....	29.99 ea.
HSM-69	1969 All	.....	29.99 ea.
HSM-70	1970 All	.....	29.99 ea.
HSM-71	1971 All	.....	29.99 ea.
HSM-72	1972 All	.....	29.99 ea.



### Blank Build Sheet

Reproduction of the factory build sheet which allows you to make your own custom paper, perfect for a restoration car!

HBS-66	1966-72 All	.....	10.99 ea.
--------	-------------	-------	-----------

### Blank Window Stickers

Reproduction of the factory window sticker which allows you to make your own custom paper, perfect for a restoration car!

HOB-661	1964-65 All	.....	14.99 ea.
HOB-386	1966-67 All	.....	14.99 ea.
HOB-879	1968-69 All	.....	14.99 ea.
HOB-350	1970-72 All	.....	14.99 ea.

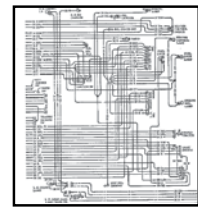

### Wiring Diagrams

Original GM wiring schematic from bumper to bumper.

HWD-(Year)A	All	.....	13.99 ea.
-------------	-----	-------	-----------

Ex. HWD-64A for 1964 Chevelle.



### Convertible Top Manuals

Reproduction convertible top manual.

HVT-4	1964 Convertible	.....	6.95 ea.
HVT-5	1965 Convertible	.....	6.95 ea.
HVT-6	1966 Convertible	.....	8.99 ea.
HVT-7	1967 Convertible	.....	6.95 ea.
HVT-8	1968 Convertible	.....	6.95 ea.



### Chevy Start Sleeve

Reproduction starting instruction sleeve which was installed on the sunvisor.

HSS-69	1969-72	.....	11.99 ea.
--------	---------	-------	-----------

**A**

**Accel**.....145

**Accelerator**

Bracket.....136

Cable.....136, 152

Decal.....239

Hardware.....32

Pad.....32

Pedal.....32

Rod.....136

**Air Cleaner**

Assembly.....130-132

Decal.....238

Flame Arrestor.....131, 168

Seal.....131

Wing Nut.....131, 168

**Air Conditioning**.....128-129

Brackets.....129

Decal.....238

Delete.....127

Harness.....212

Receiver Dryer.....128

**Aldan American**.....88

**Alternator**.....142-143

Bracket.....140-143

Fan.....141

Hardware.....140

**American Autowire**.....211-212

**American Racing**.....62

**AMK**

AC Hardware Kits.....159

Engine Hw Kits.....159

Master Body Kits.....159

Master Interior Kits.....15, 159

**Antenna**.....55, 175

Hidden.....55

Kit.....175

Lead Wire.....55, 175

**Arm Rest**.....17-19

Screws.....18, 160

**Ash Tray**

Dash.....23

Rear.....17, 19

**B**

**Battery**

Battery Topper.....156

Cable.....156, 221

Retainer.....156, 161

Tender.....156, 221

Tray.....156

**Bed**

Corner Front.....184

Corner Rear.....184

Mat.....184

Molding.....184

**Bell Crank**

Door Lock Rod.....162

**Bezel**

Antenna.....175

Dash.....21-22, 26-27

Headlamp.....178-179

Parking Lamp.....224

Tail Lamp.....227-229

Side Marker.....225-226

**Billet Accessories**

Dipstick/Tube.....151

Door Handle.....175

Door Jamb Vent.....15

Gauge Bezel.....26

Headlight Knob.....22

Hood Hinge.....157

Pedals.....33

Pulleys.....94, 138, 141

Rear View Mirror.....45

Shifter.....38-40, 103-106

Trunk Hinge.....201

**Blower Motor**

Blower Motor.....127

Resistor.....127

Switch.....217

**B&M**

Deep Pans.....109

Differential Covers.....109

Flexplate.....102

Trans Coolers.....107

Shifters.....105

Overhaul kits.....108

**Body Bolt Kit**.....82, 160

**Boot**

Convertible Top.....56

Shifter.....39, 106

Steering Shaft.....211

**Brace**

Fender.....185

Floor.....198

Fuel Tank.....200

Roof.....191

**Bracket**

AC.....129

Alternator.....142-143

Bumper.....182

Flex Hose.....74

Grille.....178

License Plate.....181

Mirror (Door).....174

Mirror (Rear View).....45

Power Steering.....93-95

Seat.....5

Washer Jar.....155

**Brakes**

Booster.....71-72

Booster/Master Kit.....71

Calipers.....67-68

Decal.....238

Disc Kits.....64-67

Distribution Block.....72

Drum.....69

Flex Hoses.....74

Hardware.....67-69, 73-75

Master Cylinder.....69-70

Pads & Trim.....32

Parking Brake.....32, 75

Pedal Assembly.....33

Proportioning Valve.....73

Rotors.....69

Shoes.....69

Wheel Cylinder.....75

**Brake Lines**

Clips.....67, 73, 160

Conversion.....64, 67, 70

Factory.....74

**Bulbs**

Exterior Kit.....230

Interior Kit.....44

**Bumper**

Bracket.....182

Bolt.....160

Bolt (to Bracket).....181-182

Control Arm.....79-80

El Camino.....180-181

Filter Panel.....189

Front/Rear.....180-181

Jack.....59

Kit.....181

Monte Carlo.....181

Tailgate.....204

Reinforcement Rubber.....181

Washer.....181

**Bushing**

Body.....82

Control Arm.....79, 85

Pedal.....33, 100

Pilot.....101

Radiator Support.....82

Shocks.....89

Sway Bar.....81

**C**

**Cable**

Accelerator.....136, 152

Battery.....156, 221

Convertible Top.....56

Heater Control.....31

Parking Brake.....75

Shifter.....98, 106

Speedometer.....106

**Cap**

Bearing.....68

Fuel Tank.....110

Master Cylinder.....69

Power Steering.....93

Radiator.....123

Washer Jar.....155

**Carburetor**.....134-135

Base Shield.....134

Block.....112

Choke Kit.....134

Stud.....131, 161

**Carpet**.....36

Firewall Guard.....35

Sill Plates.....34

**Center Link**.....77

**Cigarette Lighter**.....23

**Clock Console**.....42

**Clock**

Console.....40

Dash.....24

Harness.....213

Reset Knob.....24

**Clutch**

Clutch Kit.....101-102

Clutch Parts.....101-102

Fan.....120

Linkage.....100-103

Pedal Assembly.....33, 100

Z-Bar.....103

**Coil Spring**

Decal.....238

Insulator.....87

Lowering.....87

OE Replacement.....87

**Console**.....37-42

Clock.....40

Console Parts.....39-42

Cup Holder.....42

Harness.....212

Shell.....40

Shift Pattern.....39-41

**Control Arm**

Bushings.....79, 85

Front.....79-80

Hardware.....79, 84-85, 161-162

Rear.....83-86

Tubular Kit.....80, 83-86

**Conversion Kit**

Disc Brake.....64-67

Manual Trans.....100

Power Steering.....93

**Convertible**

Alignment Pin.....57, 162

Boot.....56

Cables.....58

Cylinder.....58

Frame.....56, 196

Harness.....214

Hose.....58

Motor.....58

Top.....56

Top Hook.....57, 171

Top Latch.....57, 171

Weatherstrip.....56, 208-209

Wedge Kit.....58

Well Liner.....57

Well Molding.....57, 171

**Cooling System**

Champion Cooling.....121

Decal.....238

Radiator.....121-122

Rad. Hoses.....124-125

Thermostat.....137

**Cowl Induction**

Air Cleaner.....130-132

Components.....130-132, 217

Cowl Induction Kits.....131-132

Harness.....132, 213

Hood.....186-187

Solenoid.....133, 217

Switch.....134, 217

**Cowl**

Lower Panel.....190

Panel.....189-192

Screen.....133

Seal.....211

Shoulder.....190

Side Panel.....190

Vent Grille.....123, 133, 173

**Crank**

Crank Pulley.....139

Window.....16-17

**Crossmember**.....99, 198

**Cross Rail**.....198

**Custom Auto Sound**.....52-55

**D**

**Dash**

Ash Tray.....23

Bezel.....21, 27

Carrier.....26

Conversion Kit.....26-28

Dash Pad.....19

Dashtop.....19

Emblem.....21

Gauges.....24-30

Harness.....212-213

Instrument Cluster.....24-30

Knobs.....22

Lens.....20, 22

Panel.....189

Repair Panel.....189

Speaker.....54

Top Panel.....189

Trim.....21

Vents.....19-20

**Dakota Digital**.....28-30, 228

**Decals**.....238-239

**Demon Carburation**.....134

**Detroit Speed**

Coilover Kit.....87

Lowering Springs.....87

Rear Speed Kit.....86

Suspension Kits.....77, 86

Sway Bar.....81, 86

Tubular Control Arms.....80, 86

**Digi-Tails**

LED Parking Lamp.....225

LED Tail Light.....228

**Disc Brakes**

Conversion.....64-67

Conversion Lines.....64, 67, 70

**Dip Stick**

Engine Oil.....151

Transmission.....100, 151

**Distributor**

Cap.....144, 217

HEI.....145, 216

Hold Down.....144, 217

Points Conversion.....216

Tune Up Kit.....144, 216

**Dome Light**.....44

**Door**

Door Jamb Switch.....218

Glass.....205

Glass Hardware.....163-164, 206-207

Handle (Exterior).....174-175

Handle (Interior).....16

Handle Mechanism.....16

Hardware.....162, 190

Hinge.....191

Hinge Bolts.....162, 190

Latch.....191

Mounting Hardware.....162, 190

Shell.....190

Skin.....	190
Striker.....	15, 162, 191
Weatherstrip.....	208-209
<b>Door Panels</b> .....	13-14
Clips & Plugs.....	15, 160, 162
Emblems.....	14
Knobs & Ferrules.....	15
Moldings.....	14
Retainer.....	14
Trim Tools.....	16
Washers.....	16
Water Shield.....	15
<b>Drain Plug</b> .....	
Oil.....	150, 165
Radiator.....	123
Rear End.....	109

**E**

<b>Eddie Motorsports</b> .....	
Door Handles.....	175
Door Jamb Vent.....	15
Door Strikers.....	15, 162, 191
Hood Adj. Bolts.....	163
Hood Hinges.....	157, 188
Hood Latches.....	158, 188
Trunk Hinges.....	201
<b>Electrical</b> .....	211-221
<b>Emblems</b> .....	14, 21, 233-236
Templates.....	234
<b>Engine</b> .....	
Decals.....	238-239
Hardware Kits.....	159
Harness.....	213
Lifting Rings.....	151
Mount.....	152
Paint.....	240

<b>Exhaust</b> .....	
Downpipe.....	115
Flowmaster.....	116
French Locks.....	114
Hangers.....	115-116
Headers.....	117-118
Heat Riser Valve.....	114
Heat Stove.....	114
Manifolds.....	114, 117
Manifold Bolts.....	114, 163
PYPES Exhaust.....	114-115
Reducer.....	115
Systems.....	115-117
Tips.....	114

**F**

<b>Fan</b> .....	
Blade.....	120
Clutch.....	120
Decal.....	238
Electric Fan.....	120-121
Hardware.....	120, 163
Shroud.....	119
Spacer.....	120
<b>Fender</b> .....	185
Bolts.....	159-160, 186
Brackets.....	189
Fender Grippers.....	157
Inner Fender Wells.....	185
Patch Panel.....	185
Support Brace.....	185
Tie Brace.....	189
Washer.....	164
<b>Filter</b> .....	
Air Cleaner.....	132
Fuel.....	112-113
Oil.....	150
<b>Firewall</b> .....	189
AC Delete.....	127
Bracket.....	189
Clip.....	220
Insulation.....	35
Rods.....	101

<b>Floor Mats</b> .....	34
<b>Floor Pan</b> .....	

Brace.....	198
Drain Plug.....	200
Full Floor.....	194-195
Half.....	195
Patch.....	196
Shifter Tunnel.....	197
Toe Board.....	196
Trunk Floor.....	199

<b>Flowmaster</b> .....	
Exhaust.....	116-117
<b>Flowtech</b> .....	118
<b>Flywheel</b> .....	101-102
Bolts.....	101, 164
Inspection Cover.....	101
<b>Forward Lamp Harness</b> .....	214
<b>Frame Marking Crayons</b> .....	155
<b>Frostbite Cooling</b> .....	122
<b>Fuel</b> .....	
Filter.....	112-113
Hose.....	111
Gauge.....	24-28

<b>Fuel Lines</b> .....	111-112
Clips.....	112
<b>Fuel Pump</b> .....	113
Hardware.....	113, 163
Pump to Carb Line.....	112
<b>Fuel Tanks</b> .....	110
Cap.....	110
Door.....	111, 181
Hardware.....	111, 163
Kit.....	110
Sender Harness.....	111, 214
Sending Unit.....	111
Straps.....	111

**G**

<b>Gaskets</b> .....	
Air Cleaner.....	131
Door Handle.....	174
Exhaust (Donut).....	114
Exhaust (Heat Riser).....	114
Heater Box.....	126, 211
Oil Pan.....	150
Paint Seal Kit.....	211
Parking Lamp.....	223
Rear End Cover.....	109
Side Marker.....	225-226
Tail Lamp.....	226-228
Valve Cover.....	150
<b>Gauges</b> .....	24-30
<b>Gforce Crossmembers</b> .....	99
<b>Glass</b> .....	205-207
Glass Hardware.....	163-164, 205-207
<b>Glove Box</b> .....	23
Door.....	23
Emblems.....	21
Lamp.....	23, 218
Lock.....	231-232
<b>Grille</b> .....	
Brackets.....	178
Extensions.....	178
Hardware.....	164, 178
Grille Kits.....	176
Moldings.....	177-179
Mounting Kit.....	164, 178

**H**

<b>Handle</b> .....	
Door Handle (Exterior).....	174-175
Door Handle (Interior).....	16
Shifter.....	37-40, 98, 103-106
Vent Window.....	16, 205
<b>Hardware</b> .....	159-167
<b>Harness Retainer</b> .....	198, 201, 210-217
<b>Harness Tape</b> .....	216
<b>Hays Clutches</b> .....	102
<b>Header</b> .....	
Cover.....	172
Exhaust.....	117-118
Header Bow.....	56
Panel.....	189
<b>Headlamp</b> .....	222

Adjustment Kit.....	179
Bezel.....	178-179
Bucket.....	179
Dimmer Switch.....	218
Hardware.....	179
Retainer.....	179
Switch.....	218

<b>Headliner</b> .....	42-43
Bows.....	42
Insulation.....	42
Trim.....	45
<b>Headrests</b> .....	6
Brackets & Guides.....	6
Covers.....	6
Locks.....	7

<b>Heater</b> .....	
Blower Motor.....	127
Box.....	127
Box Cover.....	127
Control Assembly.....	31
Control Cables.....	31
Control Lens.....	31
Control Valve.....	127
Delete Plate.....	127
Heater Core.....	126
Hoses.....	124-125

<b>Hinge</b> .....	
Door.....	190-191
Hood.....	157, 186-189
Pillar Assembly.....	191
Spring.....	187, 190
Trunk.....	201

<b>HK Wheels</b> .....	62
<b>Holley</b> .....	110, 113, 134
<b>Hood</b> .....	186-189
Adjustment.....	163-164
Catch.....	158, 188-189
Cowl Ind.....	186-189
Emblem.....	235
Hinge.....	157, 187-188
Hinge Bolt.....	164
Insulation.....	155
Latch.....	158, 188-189
Latch Support.....	158, 188
Louvers.....	173, 187
Pin Kit.....	158, 189
Spear.....	172
Tach.....	25, 172

<b>Hooker</b> .....	117, 118
<b>Horn</b> .....	155
Button.....	48-49
Cap.....	48-49
Contact Kit.....	48-49
Relay.....	155
Wire.....	214
<b>Hose</b> .....	
Bypass.....	138
Clamps.....	125, 138
Convertible Top.....	58
Cowl Induction.....	133
Fuel.....	111-112
Heater.....	124-125
Overflow.....	123
PCV.....	136
Power Brakes.....	70
Power Steering.....	95
Radiator.....	124-125
Retainers.....	123, 127
Smog House.....	147
Washer.....	155

<b>Hurst</b> .....	
Boot.....	39, 106
Crossmember.....	99
Floor Mats.....	34
Hurst/Muncie Kit.....	104
Installation Kit.....	38, 103-104
Line Lock.....	73
Shifter.....	38, 40, 103-106
Shifter Cables.....	106

**I**

<b>Idler Arm</b> .....	77
Bolts.....	77, 165

<b>Ignition</b> .....	
Coil.....	145, 216-217
Lock Cylinder.....	231-232
Switch.....	219

<b>Instrument Cluster</b> .....	
Dakota Digital.....	28-30
Gauges.....	24-30
Lenses.....	20, 22

<b>Insulation</b> .....	
Dash.....	19
Firewall.....	35
Fuel Tank.....	111
Headliner.....	42
Hood.....	155
Kick Panel.....	31

<b>Intake Manifold</b> .....	136
Bolt Kits.....	137, 165
Stud.....	137, 165
Vacuum Fittings.....	137

<b>Interior</b> .....	
Bulb Kits.....	44
Fastener Kits.....	15, 159
Interior Kits.....	3-4, 14
<b>Intermediate Steering Shaft</b> .....	97

**J**

<b>Jack</b> .....	
Bumper Jack.....	59
Decal (Instructions).....	239
Load Base.....	59
Retainer.....	59, 165
<b>Junction Block</b> .....	156

**K**

<b>Kickdown</b> .....	
Cable.....	99, 152
Harness.....	99, 214
Switch.....	99
<b>Kick Panels</b> .....	31
Cables.....	31
Insulation.....	31
Speakers.....	54

<b>Knob</b> .....	
Bucket Seat Release.....	6
Clock.....	24
Dash.....	22
Door Lock.....	15
Emergency Brake.....	32
Emergency Flasher.....	22
Headlamp.....	22
Heater Control.....	31
Radio.....	22
Seat Adjustment.....	8
Shifter.....	39, 104, 106
Wiper.....	22

**L**

<b>Lakewood Bellhousing</b> .....	102
<b>Latch</b> .....	
Convertible Top.....	57, 171
Door.....	191
Hood.....	158, 188-189
Trunk.....	201
Tailgate.....	202

<b>LED Lights</b> .....	
Accent Strips.....	226
Dash Bulb.....	226
Dome Light Bulb.....	44
License Plate Bulb.....	230
Parking Lamp Kit.....	225
Reverse Bulb.....	230
Side Marker Bulb.....	226
Tail Light Kit.....	228
Turn Signal Bulb.....	225

<b>Lens</b>	
Arm Rest.....	19
Bezel Clip.....	183, 229
Console (Rear).....	41
Dash (Instrument).....	20
Dash (Indicators).....	20
Dome Light.....	44
Heater Control.....	31
License Plate Lamp.....	230
Parking Lamp.....	224
Radio.....	22
Reverse Light.....	230
Screws.....	230
Side Marker.....	224-225
Shift Indicator.....	20, 41
Tail Lamp.....	227-228
<b>Lever</b>	
Heater Control.....	31
Tilt Wheel.....	50
Turn Signal.....	50
<b>License Plate</b>	
Bracket.....	181
Hardware.....	165, 181
Lamp.....	230
<b>Locks</b> .....	231-232
<b>M</b>	
<b>Mallory Ignition</b> .....	145
<b>Manifold</b>	
Exhaust.....	114, 117
Intake.....	136
<b>Manuals</b> .....	241
<b>Manual Transmission</b>	
Clutch Parts.....	101-103, 161
Conversion Kits.....	100
<b>Mirror</b>	
Bracket.....	45, 174
Inside.....	45
Outside.....	173-174
Remote.....	173
<b>Molding</b>	
C Molding.....	183
Clips.....	168-169
Convertible Well.....	57, 171
Dash.....	21
Door.....	169
Drip Rail.....	169
Eyebrow.....	179
Front Windshield.....	169
Grille.....	176-179
Hood.....	172
Quarter Window.....	171
Rear Window.....	169
Rocker Panel.....	172
Studs.....	167, 171
Valance.....	178
Vinyl Top.....	171
Wheel Opening.....	175
<b>Motor Mount</b> .....	152
Bolts.....	152, 165
Frame Brackets.....	152
<b>MSD</b> .....	145-146
<b>O</b>	
<b>Oil</b>	
Dipstick.....	151
Filter.....	150
Line Kit.....	151
<b>Oil Pan</b>	
Bolts.....	150
Drain Plug.....	150, 165
Engine.....	150
Gasket.....	150
Windage Tray.....	150
<b>Oil Pressure Fitting</b> .....	151
<b>Oil Pressure Switch</b> .....	151
<b>P</b>	
<b>Package Tray</b> .....	51
Insulation.....	51
Repair Panel.....	197

<b>Pad</b>	
Armrest.....	17-18
Bumper.....	181
Brake Pedal.....	32
Clutch Pedal.....	32
Convertible Top.....	56
Dash.....	19
<b>Paint</b> .....	13, 240
<b>Pan</b>	
Floor.....	194-196
Oil.....	150
Trunk.....	199
<b>Parking Brake</b>	
Cables.....	75
Kits.....	75
Knob.....	32
Pedal Assembly.....	32, 75
<b>Parking Lamps</b>	
Bezel.....	224
Housing.....	223
Lens.....	224
<b>PCV</b>	
Hose.....	136
Hose Retainer.....	151
<b>Pedal</b>	
Brake/Clutch.....	33, 100
Pads & Trim.....	33
<b>Pillar</b>	
Weatherstrip.....	209
Windshield.....	192
<b>Pilot Bushing</b> .....	101
<b>Pitman Arm</b> .....	97
<b>Plugs</b>	
Plastic.....	165
Rubber.....	166
<b>Positraction</b>	
Decal.....	239
Tag.....	109
<b>Power Brake</b>	
Booster.....	71-72
Hose.....	70
Tube.....	70
<b>Power Seat Relay</b> .....	217
<b>Power Steering</b>	
Brackets.....	94-95
Driver Pulley.....	94
Gear Box.....	96
Hardware.....	94, 165
Hose.....	95
Pulley.....	94
Pump.....	93
Rag Joint.....	96-97
Reservoir.....	95
<b>Power Window</b>	
Complete Kit.....	206
Harness.....	214
Motor.....	16, 206
Relay.....	219
Switch.....	16, 219
<b>Power Top</b>	
Cylinder.....	58
Frame.....	56, 196
Harness.....	214
Hoses.....	58
Switch.....	57, 217
<b>Printed Circuit Board</b> .....	219
<b>Pulley</b>	
Alternator.....	140-141
Bolts.....	138, 139, 160, 165
Crank.....	139
Power Steering.....	93
Water Pump.....	137-138
<b>Pump</b>	
Fuel.....	113
Power Steering.....	93
Washer.....	154
Water.....	137-138
<b>Q</b>	
<b>QA1</b> .....	90-92
<b>Quarter Panel</b>	

Extension Seal.....	183
Full.....	193
Patch.....	194
Skin.....	193
<b>Quarter Window</b>	
Glass.....	205
Seal.....	171, 209
<b>Quick Fuel</b> .....	113, 135
<b>Quietride Acoustishield</b> .....	35
<b>R</b>	
<b>Radiator</b>	
Cap.....	123
Champion Cooling.....	121
Cold Case.....	122
Clamps.....	125
Fan Shroud.....	119
Frame Bracket.....	186
Hoses.....	124-125
Mounting.....	123
OEM.....	121
Overflow Jar.....	123
Support.....	186
Show Panel.....	124
Top Panel.....	123
<b>Radio</b> .....	52-53
Bezel.....	22
Capacitor.....	144, 156
Knobs.....	22
Lens.....	22
<b>Rear End</b>	
Cover.....	109
Drain Plug.....	109
Fluid.....	109
Posi Tag.....	109
<b>Rear Lamp Harness</b> .....	215
<b>Rear Seat</b>	
Brace.....	197
Cover.....	3-5
Floor Pan.....	197
Foam.....	7
Mounting Panel.....	197
<b>Rear Panel</b>	
Braces.....	200
Molding.....	183-184
Tail Lamp Panel.....	200
<b>Rear View Mirror</b>	
Boot/Bracket.....	45
Mirror.....	45
<b>Rear Window</b>	
Corner Trim.....	45
Glass.....	205
Window to Trunk Pan.....	201
Trim.....	45
<b>Regulator</b>	
Window (Front).....	206
Window (Rear).....	206
Voltage.....	156, 218
<b>Repair Panel</b>	
Cowl.....	190-192
Dash.....	189
Fender.....	185
Package Tray.....	197
Quarter Panel.....	193-194
<b>Reverse Lamp</b> .....	230
Lockout Kit.....	104
Switch.....	107, 219
<b>Rocker Panel</b>	
Molding.....	197
Trim.....	172
<b>Roof Panel</b>	
Brace Kit.....	191
Drip Rail.....	191
Drip Molding.....	169
Weatherstrip.....	208
W.Strip Channel.....	171, 208
<b>Rubber Stopper Kit</b> .....	208
<b>S</b>	
<b>Seats</b> .....	3-8
Adjustment Knob.....	8
Back Components.....	6-7
Back & Sides.....	7

Belts.....	9-12
Belt Anchor Bolt.....	8, 167
Belt Components.....	8
Covers.....	3-5
Emblems.....	8
Foam.....	7
Frame.....	6, 8, 196
Mounting Bolt.....	5
Pre-Assembled Seats.....	5
Side Hinge Covers.....	8
Spring.....	8
Tracks & Extenders.....	5-6
Trim.....	7-8
<b>Sending Unit</b>	
Fuel.....	111
Temperature.....	137, 220
<b>Shifter</b>	
Automatic.....	37-38, 105
Ball.....	39, 104
Boot.....	39, 106
<b>Cable</b> .....	98, 106
Clip.....	101, 167
Detent.....	98
Handle.....	38, 40, 104-106
Kit.....	37-39, 106
Knob.....	39-40, 104, 106
Lens.....	20, 41
Lever.....	99
Retainer.....	98, 106
Seal Kit.....	41
Slider.....	41
Tunnel.....	40
<b>Sheet Metal</b> .....	185-204
Screws.....	166
<b>Shocks</b>	
Decal.....	239
Hardware.....	89, 166
KYB.....	89
Spiral Shocks.....	89
<b>Side Marker</b>	
Lens.....	224-225
Socket.....	221, 226
<b>SMOG System</b> .....	147
<b>Sound Deadener</b> .....	35
<b>Spare Tire</b>	
Anchor Plate.....	59, 199
Cover.....	59
Retainer.....	59, 165
<b>Spark Plug</b> .....	146, 215
Heat Shields.....	146
Loom.....	145-146
Wire.....	146, 216
<b>Speakers</b>	
Dash.....	54
Harness.....	215
Rear.....	55
<b>Speed Warning</b>	
Harness.....	215
<b>Speedometer</b>	
Cables.....	106
Gauges.....	25, 28-30
Gear.....	108
<b>Spring</b>	
Carb Return.....	136
Clutch Return.....	103
Coil.....	87
Decal.....	238
Headlamp.....	164, 179
Hinge (Hood).....	157, 187
Lowering.....	87
Seat.....	8
<b>Starter</b>	
Bolt.....	139, 166
Motor.....	139
<b>Steering</b>	
Arm.....	68
Box.....	96
Column.....	49-50
Column Parts.....	49-51
Coupler.....	97

**Steering Wheel**  
 Button/Cap.....48-49  
 Hub.....49  
 Kit.....46-48  
 Shroud.....48

**Striker**  
 Door.....15, 162  
 Glove Box.....23

**Stripe Kits**.....237

**Sunvisor**.....43-44  
 Bushing.....44  
 Support.....44

**Super Interior Kit**.....3

**Suspension**  
 Ball Joint.....77  
 End Links (Sway Bar).....81  
 Kits.....76-92

**Spindle**.....68

**Tie Rod**.....77

**Tubular Control Arms**.....80, 83-84, 86

**Sway Bar**  
 Bolt.....81, 85, 167  
 Brackets.....81  
 Bushings.....81  
 Kit.....81, 85-86  
 Rear.....85-86

**Switch**  
 Blower Motor.....217  
 Brake Light.....217  
 Convertible Top.....58, 217  
 Door Jamb.....218  
 Headlamp.....218  
 Headlamp Dimmer.....218  
 Ignition.....219  
 Nut.....21, 218  
 Neutral Safety.....107, 219  
 Neutral Start.....107, 219  
 Power Lock.....16, 219  
 Power Window.....16, 219  
 Reverse.....107-108  
 TCS.....108, 151, 220  
 Turn Signal.....220  
 Wiper/Washer.....220

**T**

**Tachometer**.....25-26  
 Conversion Harness.....25, 215  
 Hood Tach.....29, 172

**Tailgate**.....202-204  
 Bolts.....161, 167  
 Cable.....167, 204  
 Handle.....167, 184  
 Hinges.....167, 204  
 Latch.....202  
 Molding.....184  
 Switch.....219

**Taillights**  
 Bezel.....229  
 Gasket.....228-229  
 Housing.....229  
 Kit.....227, 229  
 Lens.....227-229  
 Panel.....200, 204  
 Rear Lamp Harness.....215  
 Socket.....221, 226

**TCS**  
 Relay.....151, 220  
 Sender.....137  
 Solenoid.....220  
 Switch.....108, 151, 220  
 Trans Harness.....215

**Temperature Sending Unit**.....137

**Thermostat**  
 Bolts.....137, 168  
 Housing.....137

**Throw Out Bearing**.....101-102

**Tilt**  
 Column.....49-50  
 Lever.....49

**Timing Cover**.....143  
 Bolts.....143, 168  
 Pointer.....144

**Tires**.....62

**TMI Interiors**  
 Headliner Kits.....42

**Tools**  
 Door Handle/Window.....16, 207  
 Door Panel.....16, 207  
 Glove Box Nut.....22  
 Headlamp Washer Nut.....22  
 Hog Ring Pliers.....8  
 Ignition Nut.....22  
 Window Roller.....168, 207

**Transmission**  
 Bellhousing.....101-102  
 Coolers.....107  
 Cooler Lines.....100  
 Crossmember.....99  
 Dipstick.....100, 151  
 Linkage.....100-104  
 Manual Conversion.....100  
 Mount.....99  
 Pan.....109  
 Parts.....108  
 Speedo Gear.....108  
 Tail Seal.....108  
 Vacuum Lines.....100  
 Yoke.....108

**Trunk**  
 Brace.....200  
 Bumper Jack.....59  
 Catch.....201  
 Divider Board/Insulation.....51  
 Drop Off.....200  
 Floor.....199  
 Floor Drain Plug.....59, 200  
 Hinge.....201  
 Lamp Harness.....215  
 Latch.....201, 232  
 Lock.....231-232  
 Lug Wrench.....59  
 Mat.....59  
 Paint.....59, 240  
 Spare Tire Cover.....59  
 Torsion Rod.....201  
 Weatherstrip.....209  
 Weatherstrip Gutter.....200

**Tuff Stuff**  
 AC Compressor.....128  
 Alternator.....140-141  
 Gear Reduction Start.....139  
 Water Pump.....138

**Turn Signal**  
 Cancel Cam.....49  
 Lever.....50  
 Repair.....220  
 Switch.....220

**U**

**UMI Performance**  
 Rear Chassis Brace.....82  
 Rear Control Arm.....83-84  
 Shock/Spring Kit.....89  
 Sway Bars.....81  
 Suspension Kits.....78, 80-81, 83-84  
 Tubular A-Arms.....80

**Undercover Innovations**.....123-124

**V**

**Vacuum Advance**.....134  
 Cover.....134

**Valve Cover**.....147-150  
 Decal.....147, 239  
 Elbow.....150  
 Gasket.....150  
 Grommets.....150  
 Hardware.....150, 168  
 Hose.....150  
 Oil Cap.....150  
 Wire Loom.....145-146

**Vent Channel Run**.....209

**Vent Window**.....205  
 Frame.....171  
 Glass.....205  
 Handle.....16, 205  
 Hardware.....16  
 Weatherstrip.....209

**Vintage Air**.....128

**Vinyl Top**.....171  
 Moldings.....171

**Voltage Regulator**.....156, 218  
 Screws.....156, 168, 218

**W**

**Washer**  
 Cap.....155  
 Hose Kit.....155  
 Jar.....155  
 Nozzles.....155  
 Pump.....154-155

**Water Pump**.....137-138  
 Attaching Kit.....133-138, 168  
 Bypass Hose.....138  
 Pulley.....138  
 Stud.....137, 168  
 Tuff Stuff.....138

**Weatherstrip**  
 Convertible.....57, 208-210  
 Deluxe Kit.....208  
 Door.....208  
 Dust Shield (A-Arm).....209  
 Firewall Seals.....209  
 Junior Kits.....208  
 Paint Seal Kits.....211  
 Pillar Post.....209  
 Quarter Glass.....171, 209  
 Roof Rail.....208  
 Rubber Stopper Kits.....208  
 Trunk.....209  
 Vent Window.....209  
 Window Felts.....210

**Weiland Intake**.....132

**Wheels**.....60-63  
 Cap.....63  
 Kits.....60-63  
 Lug Nuts.....61  
 Paint.....61, 240  
 Trim Rings.....63

**Wheel Opening Moldings**.....171

**Wheelhouse**  
 Inner (Front).....185  
 Inner (Rear).....192  
 Outer (Rear).....192

**Windlace**  
 Door Jamb.....16

**Window**  
 Crank.....16-17  
 Frame.....169  
 Glass (Door).....205  
 Glass (Quarter).....205  
 Glass (Windshield).....205  
 Glass Stop.....207  
 Molding.....169  
 Molding Pin / Stud.....171-172  
 Regulator.....206  
 Rollers.....168, 207  
 Stickers.....238-239  
 Switch.....16, 219  
 Tracks.....168, 190, 207  
 Trim.....45

**Window Felts**.....210

**Windshield Wipers**  
 Arm.....170  
 Blades.....170  
 Knob.....22  
 Motor.....153  
 Switch.....220  
 Transmission.....154

**Wiring Diagram**.....241





## Company Policies

### Hassle Free Returns

Products may be returned for a full refund, credit, or exchange within 30 days of receipt. Products returned after 30 days can only be returned for store credit. All returns are subject to a 25% restocking fee after 30 days. Should you need to return a part for a full refund, credit, or exchange, please contact our customer service department for a return authorization number and instructions or click the link below for our online return form. Ground Up Motors - SS396.com will not accept returned goods without prior authorization. The customer will pay freight on all return orders unless otherwise specified by Ground Up Motors - SS396.com

Ground Up Motors - SS396.com always recommends professional installation on all the products we sell. Any item which has been altered, painted, installed, or deemed non-resalable by Ground Up Motors - SS396.com will be returned to the customer at the customer's expense. Ground Up Motors - SS396.com is not responsible or liable for labor fees associated with the installation, removal, modification, or repair of any product purchased regardless of the circumstances. Ground Up Motors - SS396.com is not responsible for any damage or discoloration incurred in relation to chemical products including cleaners, waxes, polishes, paints, etc.

### Product Availability & Pricing

Availability of all items on SS396.com and in the catalogs are subject to change without notice. Ground Up Motors - SS396.com reserves the right to discontinue products, services or accessories, and/or substitute products of a similar nature (i.e. different manufactures) without notice. Ground Up Motors - SS396.com makes every effort to honor the prices contained herein. However, due to increased costs of manufacturing, materials, etc., prices can change. We reserve the right to change prices without notice. For current pricing please visit our web site, or contact a Ground Up Motors - SS396.com sales representative during normal business hours.

### Backorders

The invoice located in the packing slip of your order will notate any items that were out of stock at the time of shipping. The unavailable items will be back ordered unless otherwise specified on your order form or verbally to a sales representative when placing your order by phone. Back orders are usually shipped when the products arrive at our warehouse without prior notification. Ground Up Motors - SS396.com will make an effort to contact the customer if the backorder is more than 90 days old. If you wish to cancel a back order, please notify our customer service department immediately. The customer will be responsible for a 25% restocking fee and freight charges if the back order is cancelled or returned after the items are shipped.

### Kit Products

All Ground Up Motors - SS396.com Parts and Accessories catalogs include kits which contain a variety of products. On occasion we may run out of an item supplied with a kit. If this happens we will generally ship what is in stock and back order the item(s) which are not in stock. You may contact our sales department by phone to verify which items are not in stock at the time the order is placed. The customer may decide whether to accept the partial kit or have the entire kit back ordered until the kit is completed and all the items can be shipped at the same time. If the customer decides to accept partial delivery of the kit, then the full price of the kit will be charged to the customer and the back ordered items will be shipped no charge when they arrive at our warehouse. Customers will be charged the appropriate freight fees when applicable. Cancellation of products from a kit will be accepted at 25% below the actual current retail price of the item.

### Color Matches

Due to multiple manufacturers of products Ground Up Motors - SS396.com provides, color variations may occur. Slight color variations are common especially amongst interior products and does not constitute a defect. These products are not eligible for return for this reason. Due to variances among computer monitors the colors that appear on your screen may differ slightly from the actual color of the product. If exact color matching on interior items is a concern, please request fee samples prior to ordering. Returns on colored interior items will be subject to a restocking fee.

### Discounting

Ground Up Motor - SS396.Com is proud to offer you several ways to save money. These offers do not apply to kit items, sale items, specially priced items, or any items marked "Part eligible for free shipping: NO or Part eligible for discounting: NO. This offer only applies to items that are in stock at the time of ordering. Ground Up Motors - SS396.com reserves the right to exclude items for discounting even though they may not be noted as "No Volume Discount" in this online catalog. Discounts (including team discounts) cannot be combined. Discounting will be reflected on your final invoice after your order has shipped.

### Sales Tax Information

Orders shipped outside of Connecticut & Florida may be exempt from sales tax. Connecticut and Florida residents are required to add the appropriate current sales tax. Due to regular variations in Connecticut and Florida sales tax, rates are subject to change without notice. Connecticut and Florida orders are subject to tax, this tax will be applied to the invoice or noted at checkout online.

### Ordering Lefts and Rights

Some items in this catalog are presented as right hand (RH) or left hand (LH). RH and LH sides are determined by sitting in the vehicle. RH = passenger and LH = driver.

### Trademark and Copyright

The content of Ground Up Motors - SS396.com, including the Ground Up Motors - SS396.com Parts and Accessories catalog is copyright 2023, all rights are reserved. No part of this publication including text, photos or illustrations may be reproduced without the prior written permission of Ground Up Motors - SS396.com.

### International Orders

Ground Up Motors - SS396.com is happy to ship parts to international customers via International Economy shipping. Shipping can also be arranged per the customer and the packages will be boxed at our dock. Please call our sales department or send an email to logistics@ss396.com to get a shipping quote for the parts that you wish to order.

## Shipping Information

### Oversize Items

All items which are considered to be Oversize are items that can be shipped via UPS Ground at an Oversize rate indicating a minimum dimensional weight fee of 30 lbs for Oversize or 70 lbs for Oversize 2. Ground Up Motors - SS396.com® reserves the right to charge an Oversize fee on any item that is Oversize even though it may not be indicated as an Oversize item.

### Truck Freight

Some products in this catalog are too large or heavy to be shipped via Ground freight and must be shipped via truck freight. Ground Up Motors - SS396.com charges a minimum of \$199.00 for all orders which must be shipped via Truck Freight to a commercial address. Actual rates can be higher depending on your location and items ordered. Residential addresses require an additional \$150.00, so please provide a commercial address whenever possible. If a commercial address is not available, you can arrange pickup at the closest terminal. (Your sales rep can provide you with the location.) If an address is not deemed to be a commercial address by the carrier, additional charges may apply. These charges are the sole responsibility of the customer.

### Expedited Shipping

Ground Up Motors - SS396.com offers several expedited shipping methods for your convenience: UPS 3 Day Saver • UPS 2 Day Air • UPS Overnight Orders must be placed by 2:00 pm Mon-Thur & 12:00 pm Fri. Weekends and holidays do not count as shipping days. Ground Up Motors - SS396.com is not responsible for lost or damaged goods due to carrier mishandling. You must contact our sales department for actual shipping rates.

### Insurance

Each order is charged an insurance fee of \$1.00 per \$100.00 to insure the entire order and protect you completely from damages or loss in shipping.

### APO/FPO

Parcel post is the only means of shipping to an APO or FPO address. Due to size restrictions, the maximum shipping box cannot exceed 72" width and girth combined. All military personal must write, call or email us prior to ordering to ensure that the desired parts do not exceed the size limit.

### Damage Claims

**Ground Packages** - Always check the contents of your delivery in the presence of the person delivering the merchandise. Should any damage be present, immediately notify our customer service department so that Ground Up Motors - SS396.com can take all necessary steps to file a claim with the carrier and ensure a prompt replacement of the damaged goods. Replacement parts will normally be sent out within 2 business days after receipt of a claim number from the carrier. Ground Up Motors - SS396.com is not responsible for any damaged good that have not been reported within 3 business days of receipt of delivery. If the customer files a claim with the carrier, Ground Up Motors - SS396.com will not be responsible to pay for any replacements until the carrier pays the claim.

**Truck Freight** - You MUST check the contents of your delivery in the presence of the carrier! DO NOT ALLOW THE DELIVERY PERSON TO LEAVE PRIOR TO CHECKING YOUR SHIPMENT! Should there be any damage, you MUST note the damage on the Bill of Lading. If the damage is beyond repair, REFUSE THE SHIPMENT! The Bill of Lading is a legal document. Should you accept the shipment and sign the Bill of Lading stating the items you received are in good condition without checking them, there is NO RECOURSE with the carrier if the goods are later found to be damaged. If items are discovered to be damaged at the time of delivery and noted as damaged on the Bill of Lading or refused, immediately notify our customer service department so that Ground Up Motors - SS396.com can take all steps necessary to ensure a prompt replacement or adjustment on the damaged goods.

### Shortages

Always check the contents of your delivery to ensure that all parts ordered were received. If you are missing any items, first check your invoice to check for back-orders or drop shipments before calling our customer service department. If a shortage has occurred, please contact our customer service department immediately for a prompt replacement. Ground Up Motors - SS396.com is not responsible for any delivery shortages after 3 business days.

### Refusals

All refused deliveries will be subject to a 25% restocking fee plus return shipping charges (unless it was refused because of damage in shipping. See our damage claim policy above).





## FREE CATALOGS

Have another car? You can request additional high-quality print catalogs packed with thousands of restoration parts at [ss396.com](http://ss396.com)!

## We've moved to a new location!

2 Commerce Blvd, Palm Coast, FL 32164

### Part not in our catalog?

Visit [ss396.com](http://ss396.com) or give us a call to shop for thousands of parts & accessories just for your Chevelle or El Camino!

We love showing off our customer's cars just as much as we love showing off our cars!

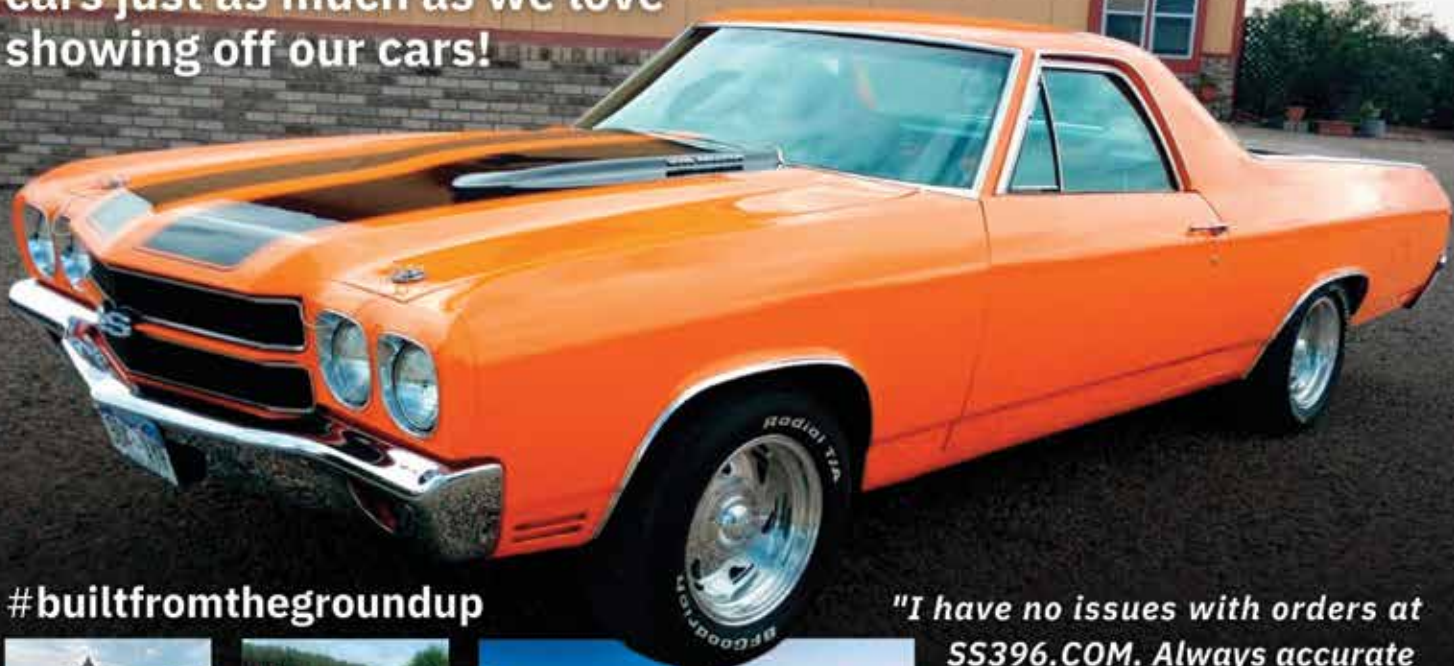

#builtfromthegroundup



*"I have no issues with orders at SS396.COM. Always accurate and prompt delivery."*

**-Dave J's  
(1970 El Camino)**

We Love to see customer cars and hear their stories. Submit your story today and have a chance to be the feature in our quarterly customer car email featuring your rides! Go online to submit your story at [ss396.com](http://ss396.com).

GROUND MOTORS - SS396.COM  
2 COMMERCE BLVD  
PALM COAST, FL 32164

PRSRT STD  
U.S. POSTAGE PAID  
PALM COAST FL 32164  
PERMIT NO. 114

CURRENT RESIDENT OR:



**1970-1972 Pro-Touring Front Spoilers**

Starting At \$139.99



Black/Paintable



Carbon-Dipped



Addictive Flow is a proud part of the Ground Up Motors family of brands.