



AKSI[®]

HERRAMIENTA PROFESIONAL

**¡ARMANDOLA
JUNTOS!**

CATÁLOGO 2024



AKSI®



Construido para durar, diseñado para la vida...

Nuestro compromiso con México y el mundo es brindar a nuestro consumidor productos de alta calidad.

A lo largo de estos años hemos enfocado nuestro esfuerzo en desarrollar un producto con la mejor relación costo / beneficio. Una labor nada sencilla pero que ya rinde grandes frutos.

En AKSI® generamos confianza, demostrando un equilibrio entre calidad y costos en cada uno de nuestros productos.

nuestras **MARCA S** nos definen



www.aksi.com.mx

ÍNDICE

A						
Abrazadera	43	Aro de luz	221	Bomba de agua	276-280	
Abrillantador, protector y restaurador	60	Aromatizantes	34-39	Bomba de pedal para inflar	52	
Aceite afloja todo, multiuso dieléctrico	49	Aspersor plástico	47	Bomba destapa caños	407	
Aceite lubricante	49	Aspiradora	292	Bomba para destapar lavabo	407	
Aceite mineral para motor de 2 tiempos	49,130	Atenuador de luz	13	Bomba para inflar	52	
Acoplador para remolque	46	Atomizador	49	Boquilla con encendido electrónico	53	
Adaptador en "Y"	47	Atornillador inalámbrico	247	Boquilla de latón para bote de gas	53,353	
Adaptador 3 a 2	25	Avellanador	47,94	Boquilla flexible con válvula check	130	
Adaptador clavija europea - americana	25	Azadón	50,73	Borla para pulidora	264	
Adaptador para matraca de cuadro	104			Bota industrial, jardinera, sanitaria	51	
Adaptador plástico de conexión rápida	47	B			Bote con aire comprimido	42
Adaptador SDS para rotomartillo	57	Banderín vial con reflejante	51,80	Bote con tapa balancín	404	
Aerórafo de succión	377	Bandola de acero	45	Bote de gas	53,77,353 53,77, 353,359	
Adhesivo acrílico - AKSIBOND	128	Bandola	45	Bote plástico con pedal	404	
Alambre de puas - corralero	50	Barra multicontacto	23,24	Botón timbre de tecla	15,17,19	
Alambre galvanizado	50	Barril de unión sencillo	43	Brazo plástico y chapetón metálico	339	
Alcayata	44	Barritas de silicón	364	Brocas	54-57	
Alicate para uñas	398	Báscula digital	49	Brocha	58,370	
Alimentador automático para mascotas	327	Base para exhibición de herramienta	418	Broquero	57	
Ambientador	38,40	Base para fotocelda	30			
Antenas	42	Batería para línea Switch	245,246	C		
Anzuelo	357	Batería Li-Ion para desbrozadora inalámbrica	247	Cabeza de latón para inflar	313	
Apagador doble sencillo	13,17	Bebedero para mascotas	327	Cable de acero	74	
Apagador escalera de tecla	16,17	Bieldo	50	Cable dúplex STP	75	
Apagador sencillo de tecla	16,17	Bisagra bidimensional	66	Cable pasa corriente	76	
Apagador triple sencillo	14,18	Blusa para dama	420	Cable THW CCA UL	75	
Arco ajustable para segueta	48	Bola de arrastre para remolque	46	Cadena de entrenamiento para mascota	319	
Arenero para gato	330	Bolígrafos promocionales	419	Cadena de plástico	82	
Armella	44	Bolsa ecológica	419,424	Cadena galvanizada	82	
Arnés para mascota	325	Bolsas para desechos de mascota	329	Cadena cromada para mascota	319	

Caja de herramientas	77	Cepillo para impermeabilizar	85,129,371	Cinta teflón	90
Cal	82,129	Cepillo para pintor	85,371	Cinta transparente	88
Calentador de agua	76	Cepillo para WC con base	407	Cinturón de seguridad para mascota	324
Cama para mascota	317,318	Cera líquida de carnauba	60	Clavadora inalámbrica	239
Camisa para caballero	420	Cerradura de barra	63	Clavadora neumática	311
Canastilla de acero inoxidable para contracanas	342	Cerradura de pomo tipo esfera	65	Clavija	26,27
Canastilla-malla	342	Cerradura para mueble	67	Clavo	84
Candado	67-69	Cerradura para vitrina	67	Coladera de ABS con rejilla cromada	343
Caña de pesca con carrete	357	Cerradura para puerta	64	Colchoneta para mascotas	318
Caña con juguete para mascota	334	Cerradura de sobreponer	62	Collar para mascota	320-323
Carda para mascota	330	Cerrojo cilindro mariposa	64	Compresor	28-286
Carda para taladro	78,79	Cerrojo doble cilindro zamac	64	Concertina	50
Carda para esmeril	78	Césped	340,341	Conector para tira LED	202
Carda para esmeriladora	78	Chaleco de seguridad	80,123	Conector rápido	313
Careta electrónica para soldar	81	Charola para rodillo	86,372	Conector rápido tipo F	315
Cargador para línea SWITCH	245,246	Chiflón	91,349,365	Conexión, hembra o macho	91
Carretilla	71	Chupón de hule	342	Conexión sencilla de latón, hembra o macho	91
Carretilla, repuestos	71,72	Cilindro para agua	419	Contacto aterrizado con dos puertos USB con placa plástica	15
Casco de seguridad	80,123	Cíncel	57, 86	Contacto aterrizado con placa plástica	14,18
Catálogo de pintura	418	Cincho de plástico	87	Contacto aterrizado y apagador escalera de tecla con placa plástica	14
Catálogo AKSI®	418	Cinta antiderrapante	90	Contacto aterrizado y apagador sencillo de tecla con placa plástica	19
Catálogo Petit®	423	Cinta canela	88	Contacto aterrizado con abrazadera	26
Cautín tipo lápiz	76	Cinta de "PELIGRO" o "PRECAUCIÓN"	87	Contacto cara de chino con abrazadera	26
Cavador	73	Cinta de aislar	89	Contacto de hule	27
Cemento	82,129	Cinta de aluminio	88	Contacto doble aterrizados con placa plástica	14,18
Cepillo curvo de alambre ondulado	84	Cinta de amarre	87	Contacto doble polarizados con placa plástica	18
Cepillo de alambre	85,371	Cinta de montaje	89	Contacto dúplex aterrizado	15,17,19,21,22
Cepillo eléctrico	259	Cinta larga de fibra de vidrio	87	Contacto polarizado	18,19,26
Cepillo eléctrico portátil	259	Cinta larga tipo cruceta	87	Contacto sencillo	15,17,19,21,22
Cepillo limpiador de terminales de batería	49,84	Cinta para ducto	88	Contacto triple aterrizados con placa plástica	14,18,19

Contra para lavabo con rebosadero	344	Cuerda de cañamo con pelota	331	Driver para tira LED COB	202	
Contra canasta	343	Cuerda tejida con 4 nudos	332			
Control automático de presión de bombas	275	Cuerda tejida tipo hueso	331,322			
Cople rápido de acero cromado	313,314	Cutter	95	E	Electrodo	113,363
Cople tipo "FF" de acero cromado	313				Eliminador de olores para mascota	316
Correa retráctil para mascota	319	D			Empaques de hule para manguera	91,349
Correa para mascota	320,321	Dado corto o largo	105,106		Encendedor tipo antorcha	77,117
Corredera de extensión	76	Dado para bujía	103		Encendedor tipo cazuela	53,77, 116,353
Correderas de cajón	76	Dado para termofusora	301,384		Engrapadora	114
Corta azulejos	92	Desarmador	98-102		Escalera	118,119
Cortacetos	267	Desbrozadora a gasolina	247, 268-271		Escoba cepillo lava coches	61,409
Cortador eléctrico de azulejos	255	Desengrasante para autos	60		Escoba de jardín	117,391
Cortador de tubo	47,93	Desengrasante para asadores	61,409		Escoba	406
Cortador de vidrio	93	Desengrasante multiusos	408		Escuadra	116
Cortadora de metales	256	Desengrasante limpiador, jabón	61,409		Escuadra esquinera	44,116, 354
Cortaperno	94	Desengrasante limpiador, crema	61,409		Esmeril de banco	266,388
Cortauñas para mascota	329	Despachador de brocas	55,413		Esmeril neumático	311
CPVC	381-383	Despachador para cinta de empaque	88		Esmeriladora	253,254
Criba reforzada	351	Destorcedor	45		Esmeriladora inalámbrica	237
Cristal para gafa de soldar	81,124, 226	Detector de humo	31		Espátula	115
Cubeta plástica	405	Disco corte de metal	108-110		Esponja abrasiva	228
Cubo plástico con exprimidor	405	Disco de cuerda para mascota	332		Estufa de gas portátil	77,359
Cubrecajuela	328	Disco diamantado	111		Estufa de mesa	358
Cubretaladros	342	Disco laminado	108,110		Exhibidor con panel multiperforado	411
Cuchara de albañil	97	Disco para desmalezadora	270		Exhibidor de artefactos eléctricos	412
Cuchara para arenero	330	Disco TRI-ARC	270		Exhibidor de brocas alta velocidad	413
Cuchilla para cortaperno	94	Dispensador para garrafón de agua	113		Exhibidor de brochas	417
Cuchilla para cortador de azulejo	92	Dispensador de bolsas para mascota	329		Exhibidor de cerradura	416
Cuchillo curvo para linoleo	97	Divisor coaxial	44		Exhibidor de escaleras	414
Cuchillo recto para electricista	97	Dominó AKSI®	419		Exhibidor de lijas	417

Exhibidor de mangueras	414	Fibra de esponja doble acción	407	Foco LED dimeable A19	155,156
Exhibidor Areon	415	Fibra esponja multiusos	408	Foco LED filamentos A19	146
Exhibidor CARRÖK	416	Fibra galvanizada	408	Foco LED filamentos A19 colores	145,146
Exhibidor de mostrador	415	Fibra metálica	408	Foco LED filamentos VELA	154
Exhibidor de pintura	417	Fibra verde clásica	407	Foco LED VELA color	191
Exhibidor de aromatizantes	415	Figuras antiderrapantes para tina	90	Foco LED FLAMA	153
Exhibidor de placas	412	Filipina para veterinaria	424	Foco LED flash filament	192
Exhibidor en panel	413	Filtro separador de agua y aceite	315	Foco LED MR16	147,149
Exhibidor gondola con caja de luz	423	Flexómetro	121	Foco LED PAR 20	151,152
Exhibidor mazos y martillos	41	Flota	120	Foco LED PAR 30	151,152
Exhibidor de abrazaderas	413	Flotador eléctrico para tinaco	281	Foco LED PAR 38	151,152, 193
Exhibidor palas y picos	414	Foco 2U	132	Foco LED UFO	161
Exhibidor para botes de cadena	414	Foco 3D mazorca	193	Foco mini SP	133,134
Exhibidor para cerraduras	416	Foco 3U	132	Foco repelente de mosquitos	195
Exhibidor para foco LED vintage	411	Foco 4U	132	Foco SP	133,134
Exhibidor para productos de pintura	417	Foco filamento A19	189	Fumigador	122,273
Exhibidor para lazo	414	Foco vintage	177,186		
Exhibidor serruchos	413	Foco incandescente para refrigerador	194		
Exhibidor tipo viga para foco LED	411	Foco incandescente VELA	190	G Gafas para soldar	81,124, 226
Exhibidores para carretilla	416	Foco LED pack	140,141	Gancho "S"	45
Exhibidores para cucharas de albañil	414	Foco LED con sensor movimiento	174	Garrucha para noria	46
Extensión de acero para rodillo	114,372	Foco LED de emergencia	174,223	Gas propelente para aerógrafos	377
Extensión eléctrica	75,120	Foco LED A20	144	Gato de patín	127
Extensión eléctrica triple de uso rudo	75,120	Foco LED A15	142	Gel abrillantador de llantas CARRÖK	60
Extensión eléctrica con porta lámpara	29,75, 120	Foco LED A19	142-144	Generador	282-283
Extensión para matraca	104	Foco LED alta potencia	170,171	Gis azul para tiralíneas	124,397
		Foco LED alta potencia tipo T con sensor	169,176	Glorificador de focos	413
E		Foco LED alta potencia tipo T	168	Gorra	422
Faja con tirantes	123	Foco LED alta potencia	170	Grapa para alambre de púas	124
Farol	204,206	Foco LED S14	189	Grapa para cable coaxial	124

Grapa cable	124	Interruptor fotocelda	30	Juego de accesorios descarga para WC	342
Grapa	114,124	Interruptor inteligente	12	Juego de accesorios neumáticos	314,315
Grasa multiuso	49,124, 130	Interruptor sencillo	20,22	Juego de brocas y cinceles SDS X2	56,86
Guante	125,126	Inyector de grasa	130	Juego de cardas para taladro	79
Guante de microfibra para lavar	61,126			Juego de charola y rodillo	86,372
Guantes de látex para limpieza	405			Juego de conectores rápidos	91,349
Guía para cable	127	J		Juego de cople F	314
		Jalador	406	Juego de cople M	314
		Jalador con esponja	61,409	Juego de coples y conectores de acero cromado	314
		Jaula de alambre para mascotas	318	Juego de cuchillas para cutter	96
H		Juego de 2 tapas para coladera	343	Juego de cuñas	97,115
Hacha	127	Juego de brocas para concreto	56	Juego de herramienta para automóvil	103
Hidrolavadora	289	Juego de brocas de alta velocidad	55	Juego de herramientas para jardín	401
Hidrolavadora eléctrica	290	Juego de brocas para concreto	56	Juego de mini pinzas	362
Hidrolavadora, aspiradora, inflador de llanta, soplador - SWITCH	240	Juego de cuchillas para navaja	96,355	Juego de pistola de aire con 5 boquillas	315
Hilo para pesca	357	Juego de 2 desarmadores	99	Juego de repuestos para remachadora tipo acordeón	391
Hilo para albañil	128	Juego de 4 puntas largas	101	Juego de sierras corta círculos	94
Hilo para desbrozadora	127	Juego de 5 cuchillas para navaja multiusos	96,355	Juego desarmadores de precisión	101
		Juego de 5 llaves combinadas	233	Juegos de llaves Allen	234
I		Juego de 5 piedras montadas	303	Juguete tipo pollo para mascota	334
Imán extensible	102	Juego de 5 puntas cortas	101	Juguete de cuerda en 8 para mascota	332
Impermeabilizante	128	Juego de 5 puntas largas	101		
Incienso ISPALLA	39	Juego de 6 dados largos	106		
Inflador de cabeza doble de zamac	315	Juego de desarmadores	100	K	
Interruptor inteligente	12	Juego de 7 puntas TORX	101	Kit de accesorios para mototool	303
Interruptor combinado de palanca	21-22	Juego de 8 brocas para madera	54	Kit de reparación para pistola	374,375, 376
Interruptor de cadena	26	Juego de 8 llaves Allen	234	Kit de reparación para aerógrafo	377
Interruptor de palanca	23	Juego de 9 dados cortos	105	Kit de repuesto para matraca	104
Interruptor de paso	26	Juego de 9 dados largos	105	Kit de lijas	227,228
Interruptor de presión "push"	26	Juego de 9 puntas para desarmador	101	Kit de manguera para jardín	349
Interruptor de timbre visible oval	22	Juego de avellanador y cortador	47,94	KIT neumático	288
Interruptor escalera	20				

L	Lámpara de campamento	223	Llana	230	Luminario LED suburbano	137,138
	Lámpara de emergencia	224	Llave angular	231	Luminario para tubo LED	158
	Lámpara de mesa	222	Llave con sensor para lavabo	335	Luz de noche	220
	Lámpara de taller	75,120	Llave de banda para filtro de aceite	230		
	Lámpara incandescente para alimentos	194	Llave de compuerta	231,402	M	
	Lámpara extermina mosquitos	224	Llave de cruz	233	Machete	351
	Lámpara tubular	157	Llave de esfera	231	Malla hexagonal	351
	Lanza pelotas para mascota	331	Llave de impacto inalámbrica	237	Malla de refuerzo	129
	Lava patas para mascota	329	Llave economizadora para lavabo	335	Mandil AKSI®	422
	Lavado en seco CARRÖK	60	Llave fundida	231	Mandil Petit®	423
	Lavadora de tapicería	291	Llave individual para lavabo	339	Maneral con jaula	373
	Lazo de polipropileno	226	Llave neumática de impacto	305,306	Mango de madera para azadón	50,73
	Lente de seguridad	226	Llave para broquero	57	Mango de madera para escoba	350,406
	Lente para careta de soldar	81	Llave para jardín	231	Mango de madera para hacha	77,127,350
	Letrero luminoso LED	222	Llave para plomero	233	Mango de madera para pala	77,350,360
	Libretas AKSI® y Maxtool®	419	Llave para tanque de gas	233	Mango metálico para escoba	406
	Lija de agua	227	Llave (STILSON)	232	Mango para zapapico	350,401
	Lija de banda	228	Llave temporizadora para lavabo	335	Mango para escoba para impermeabilizar	85,129,350,371
	Lija para esmeril	228	Lona	234	Manguera de usos generales	348
	Lija para madera	227	Luminario LED para gabinete	159	Manguera de jardín	350
	Lija para plomero	228	Luminario LED con sensor de movimiento	165,174	Manguera de nivel	348
	Lijadora	262	Luminario LED empotrable ajustable y de sobreponer	164	Manguera de repuesto para bomba	52
	Lijadora de banda	261	Luminario LED colgante	208-214	Manguera para lavabo	347
	Lijadora orbital neumática	312	Luminario LED empotrable dirigible	150	Manguera para WC	347
	Lijadora roto orbital inalámbrica	238	Luminario LED empotrable ajustable	163	Manguera para boiler	347
	Lima	229,230	Luminario LED empotrable	162	Manguera para fregadero	339,347
	Limpiador para vidrios	60	Luminario LED industrial high bay	172	Manguera industrial	348
	Limpiador para carburador	49	Luminario LED de sobreponer tipo plafón	161	Manguera LED para exterior	199
	Linterna para bicicleta	222	Luminario LED de sobreponer	159,162	Manguera para aerógrafo	377
	Linterna tipo minero	223	Luminario de sobreponer para Tubo LED	158	Manguera para aire	348

Manguera para monomando	339,347	Mochila promocional Petit®	424	Orejera ajustable	80,356
Manguera poliducto	348	Molino para carne	123,355	Overol desechable	51,356
Manguera tipo resorte	315	Molino para grano	123,355		
Manómetro de presión	313	Monomando plástico para fregadero	338		
Marro	352	Monomando plástico para lavabo	339	P	
Martillo	352	Mop	407	Pala	360
Mascarilla	81,353	Mordedera de llanta para mascota	333	Panel LED de luz directa	160
Masking tape	88	Mordedera llanta y cuerda para mascota	333	Panel LED ultra delgado	160
Masking tape azul	88	Mordedera limpia dientes para mascota	333	Paraguas	419
Matraca	104	Morral AKSI®	420	Parrilla eléctrica	359
Matraca neumática	309	Morral Petit®	424	Pasador de barra plana	65
Matraca neumática 3/8" - SEMI PRO	309	Motobomba	281	Pasador para puerta	65
Mazo	352	Motosierra	272	Pegamento para PVC, CPVC	83
Mechero de acero para bote de gas	53,353	Mostrario para CPVC	412	Pegamento de contacto	83
Mechudo	407	Mostrario para PPR	412	Pelota de cuerda con jaladera para mascota	331
Ménsula	354	Mufa con abrazadera para tubo	43	Pelota de cuerda tejida para mascota	331
Mesa para exhibición de herramienta	418	Multicontacto	25	Pelota tipo tenis para mascotas	331
Mezcladora de cocina	336,338	Multiherramienta 14 funciones	353	Pelota de vinil para mascota	333
Mezcladora para lavabo	337,339	Multiherramienta MULTI PRO	302	Pelota fluorescente para mascota	333
Mica antirayadura para protector facial	81,356	Multiherramientas 14 en 1	353	Pelota para premios	333
Mini arco para segueta	48	Multimalla	351	Pelotitas para gato	334
Mini bomba para inflar	52	Multitool con accesorios	303	Perfume para mascotas	316
Mini inyector de grasa	130			Perico	232
Mini pinza	361			Piedra para asentar	388
Mini rodillo	373	N		Piedra para guadaña	388
Mini soldadora	300	Navaja abatible	96,355	Pintura en aerosol	367,368
Mini tótem	411	Navaja multiusos	96,355	Pintura en esmalte	369
Mini esmeriladora neumática	310	Niple	313	Pintura vinílica	370
Mirilla de seguridad	67	Nivel	356	Pinza	360,363
Mochila de viaje para mascota	328	Nudo	43	Pistola aerográfica	377
				Pistola calafateadora	364

Pistola de alta presión	375	Podadora eléctrica	271	Repuesto felpa de microfibra	373
Pistola de baja presión	374	Polipasto	293	Repuesto para cortador de tubo	47,93
Pistola de calor	265	Poncho	387	Repuesto para fumigador	122
Pistola de gravedad	375,376	Portacandado	65	Repuesto para rodillo	373
Pistola de silicón	364	Prensa de hierro	387	Repuestos para encendedor tipo cazuela	53,77, 116,353
Pistola eléctrica para pintar	58,265, 373	Prensa esquinera	387	Resistencia para regadera eléctrica	345
Pistola de riego	365			Rodaja	393
Pistola para limpieza de motores	377			Rodillera profesional	80
Pistola para recubrimiento	377	R		Rodillo para pintura	373
Pistola para sopletear	315	Rafa	393	Rotomartillo	249,250
Placa ciega	13	Raqueta mata mosquito + linterna	224	Rotomartillo electroneumático	251
Placa de aluminio	20,21	Raspador	96,115	Rotomartillo inalámbrico	236,242, 243
Placa de baquelita con contacto	21	Rastrillo jardinero	117,391	Rueda abrasiva	266,388
Placa de baquelita con interruptor	20	Rebajadora (router)	260		
Placa de baquelita pasacable	20	Receptáculo para RED 8 hilos con placa plástica	15	S	
Placa de baquelita	20	Receptáculo para TV	15,17,19	Sanitizante	408
Placa de plástico	16	Receptáculo telefónico	15,17,19	Segueta bimetálica	48,396
Placa para intemperie	21	Recogedor	405	Segueta para caladora	395
Placa de plástico para cople coaxial	20	Reflector LED SMD	166	Segueta para sierra sable	396
Placa de plástico para contacto telefónico	20	Reflector LED SMD con sensor de movimiento	165,175	Sellador de silicón	364,397
Plato acero inoxidable para mascota	326	Reflector LED solar con sensor movimiento	165,175	Sensor de movimiento	31
Plato doble para mascota	325	Regadera	346,390	Separador de loseta	396
Plato plegable de silicón para mascota	326	Regulador de aire	377	Serie de luces con 24 sockets	188
Plato redondo para mascota	326	Remachadora	391,392	SERRUCHO	394
Playera cuello redondo	421	Remachadora neumática	308	Shampoo para automóvil	60
Playera tipo polo	421	Remache	392	Shampoo para mascota	316
Plomada	387	Removedor de espinas	400	Sierra caladora	257
Plug para enroscar	43	Reparador para manguera	91	Sierra caladora inalámbrica	239
Pluma ejecutiva	419	Repelente o atrayente para mascota	316	Sierra circular inalámbrica	238
Plumero electroestático	40	Repuesto de cartucho para monomando	336,339	Sierra	112,394
		Repuesto de válvula para mezcladora	336,339		

Sierra de mesa	255	Tensor gancho argolla	46	Válvula para gas	231,402
Sierra inglete	256	Termofusora para PPR	301,384	Válvula para inflar bolsas	52
Sierra sable	258	Tijera de costura	398	Vaso de aluminio	374,376
Soldadora arco eléctrico	300	Tijera de poda	400	Vaso plástico	376
Soldadora inversora	296,297	Tijera para bordar	398	Vela aromática	39
Soldadora inversora para microalambre	299	Tijera multiuso	399	Ventilador	403
Soldadora multiproceso	298	Tijera para cutícula	398		
Soplador	267	Tijera para entresacar	398		
Spot	203	Tijera para floricultura y jardinería	400	Y	
Sudadera	421	Tijera para hojalatero	399	Yeso	82,129
		Tijera para peluquero	398		
T		Tijera para sastre	398	Z	
Tablero para aromatizantes	35,415	Tijera para uñas	398	Zapapico	401
Taburete plegable	119	Tijeras de aviación	399		
Talacho	401	Tira LED COB	200,201		
Taladro de banco	252	Tira LED	197,199		
Taladro de piso	252	Tiralínea plástico	397		
Taladro eléctrico	251	Toalla de microfibra 30 cm x 30 cm	61,408		
Taladro inalámbrico	236,244	Toalla super absorbente	61		
Taladro inalámbrico sin carbones	242	Toldo para sombra	402		
Taladro neumático	307	Toldo para sombra	402		
Tapa goteras	128	Tope para puerta	67		
Tapón extensión	29	Torres para auto	401		
Taquete	397	Transportadora para mascota	328		
Tarja para sobreponer con 4 quemadores	359,396	Tripié	221		
Taza medidora Petit®	423	Tuercas para inyector de grasa	130		
Tela lava trastes	408				
Tela mosquitera	402				
Temporizador analógico	31	V		Válvula ahorradora de agua	378,402
Tenaza armador	399	Válvula check para inyector de grasa	130		

una GUÍA PARA TI

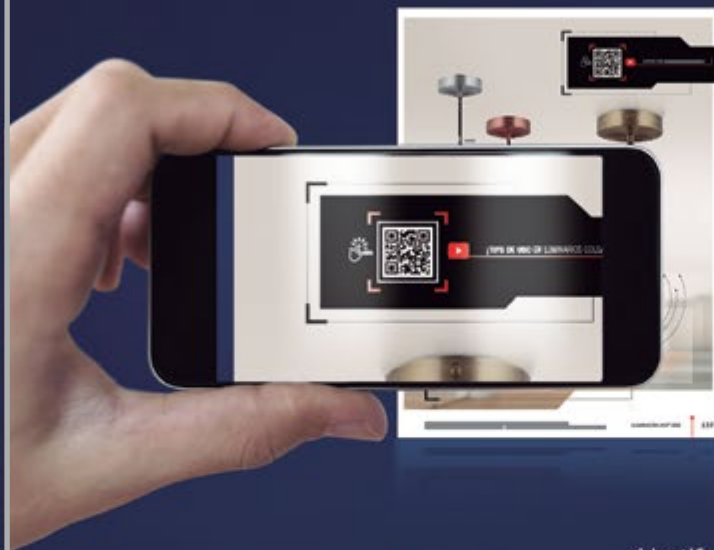

Escanéa con tu cámara o da click en los códigos QR y obtén información detallada de nuestros productos.

Descarga fichas técnicas, paletas de color, videos ilustrativos y mucho más.

NUEVO

Producto nuevo

PROX.

Producto próximo en llegar

¡Identifica el producto disponible!

Marca esta casilla para tener actualizado tu catálogo.

Esto lo podrás saber a través de la PromOferta que mensualmente indicará el producto nuevo y disponible en almacén.



CARACTERÍSTICAS del módulo

- ▶ Identifica fácil y rápidamente cada uno de los elementos de nuestro formato de módulo.
- ▶ Optimiza tu búsqueda, compara las características y la calidad de nuestros productos.
- ▶ Convéncete de que somos tu mejor opción en Herramientas.



Amplia la información de nuestros productos visitando los diversos vínculos dentro del catálogo. Ubícalos por el símbolo "click".





ARTEFACTOS

► Adaptadores . apagadores . contactos . interruptores . multicontactos . placas . portalámparas . sensores y más.



WIFI
Espacios inteligentes



► Interruptores . atenuadores . series

Interruptores Wi-Fi

CAJA

- De fácil instalación
- Controla la iluminación desde tu celular o tableta electrónica



124901
1 Apagador

124902
2 Apagadores

124903
3 Apagadores

124911
Dimmer



CÓDIGO	CARACTERÍSTICAS	TENSIÓN	POTENCIA			DISTRIB.	MAYOREO	LISTA
124901	Interruptor 1 apagador	127 V~ 240 V~	10 A / 6A / 1800 W	12	48	\$285.00	\$405.00	\$505.00
124902	Interruptor 2 apagadores	127 V~ 240 V~	10 A / 6A / 1800 W	12	48	\$305.00	\$435.00	\$540.00
124903	Interruptor 3 apagadores	127 V~ 240 V~	10 A / 6A / 1800 W	12	48	\$330.00	\$470.00	\$580.00
124911	Regulador de intensidad (dimmer)	100 V~ 240 V~	400 W	12	48	\$355.00	\$505.00	\$625.00

Serie LED Wi-Fi



- Controla la iluminación desde tu celular o tableta electrónica



CÓDIGO	POTENCIA		DISTRIB.	MAYOREO	LISTA
118275	11 W	4	\$1,750.00	\$2,500.00	\$3,085.00

CUMPLE CON LOS PARÁMETROS DE LA NOM-003-SCFI-2014 **NOM**



¡TIPS DE USO!



Descarga alguna de las dos Apps



Compatible con los asistentes de voz

ALTIMUS

Estilo y durabilidad



► Apagadores . contactos . receptáculos . timbres

Placa plástica ciega

BOLSA

► Incluye tornillería de instalación

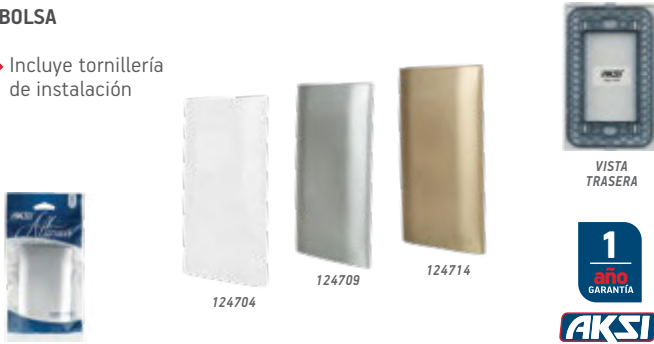

CÓDIGO	COLOR	12	144	DISTRIB.	MAYOREO	LISTA
124704	Blanco	12	144	\$12.00	\$17.10	\$21.20
124709	Plata	12	144	\$14.00	\$20.00	\$24.70
124714	Champagne	12	144	\$14.00	\$20.00	\$24.70

Atenuador de luz rotativo con placa plástica (dimmer)

BOLSA

► Ideal para utilizar con lámparas LED, halógenas e incandescentes
► Incluye tornillería de instalación



CÓDIGO	COLOR	8	96	DISTRIB.	MAYOREO	LISTA
124804	Blanco	8	96	\$59.00	\$84.00	\$104.00
124809	Plata	8	96	\$60.00	\$86.00	\$106.00
124814	Champagne	8	96	\$60.00	\$86.00	\$106.00

Apagador sencillo de tecla con placa plástica

BOLSA

► Incluye tornillería de instalación



CÓDIGO	COLOR	12	144	DISTRIB.	MAYOREO	LISTA
124801	Blanco	12	144	\$20.00	\$29.00	\$35.00
124806	Plata	12	144	\$22.00	\$31.00	\$39.00
124811	Champagne	12	144	\$22.00	\$31.00	\$39.00

Apagador de escalera sencillo de tecla con placa plástica

BOLSA

► Incluye tornillería de instalación



CÓDIGO	COLOR	12	144	DISTRIB.	MAYOREO	LISTA
124805	Blanco	12	144	\$21.00	\$30.00	\$37.00
124810	Plata	12	144	\$24.00	\$34.00	\$42.00
124815	Champagne	12	144	\$24.00	\$34.00	\$42.00

Apagador doble sencillo de tecla con placa plástica

BOLSA

► Incluye tornillería de instalación



CÓDIGO	COLOR	12	144	DISTRIB.	MAYOREO	LISTA
124802	Blanco	12	144	\$28.00	\$40.00	\$49.00
124807	Plata	12	144	\$30.00	\$43.00	\$53.00
124812	Champagne	12	144	\$30.00	\$43.00	\$53.00

Apagador triple sencillo de tecla con placa plástica

BOLSA

► Incluye tornillería de instalación



NOM

CARACTERÍSTICAS
Tensión: 127 V~ - 250 V~
Corriente: 10 A - 6 A



1
año
GARANTÍA

AKSI

CÓDIGO	COLOR			DISTRIB.	MAYOREO	LISTA
124803	Blanco	12	144	\$36.00	\$51.00	\$64.00
124808	Plata	12	144	\$39.00	\$56.00	\$69.00
124813	Champagne	12	144	\$39.00	\$56.00	\$69.00

Contacto aterrizado con placa plástica

BOLSA

► Incluye tornillería de instalación



NOM

CARACTERÍSTICAS
Tensión: 127 V~
Corriente: 15 A



1
año
GARANTÍA

AKSI

CÓDIGO	COLOR			DISTRIB.	MAYOREO	LISTA
124822	Blanco	12	144	\$24.00	\$34.00	\$42.00
124832	Plata	12	144	\$25.00	\$36.00	\$44.00
124842	Champagne	12	144	\$25.00	\$36.00	\$44.00

Contacto aterrizado y apagador sencillo de tecla con placa plástica

BOLSA

► Incluye tornillería de instalación



NOM

CARACT. CONTACTO
Tensión: 127 V~
Corriente: 15 A

CARACT. APAGADOR
Tensión: 127 V~ - 250 V~
Corriente: 10 A - 6 A



1
año
GARANTÍA

AKSI

CÓDIGO	COLOR			DISTRIB.	MAYOREO	LISTA
124821	Blanco	12	144	\$32.00	\$46.00	\$56.00
124831	Plata	12	144	\$33.00	\$47.00	\$58.00
124841	Champagne	12	144	\$33.00	\$47.00	\$58.00

Contacto aterrizado y apagador de escalera sencillo de tecla con placa plástica



BOLSA

► Incluye tornillería de instalación



NOM

CARACT. CONTACTO
Tensión: 127 V~
Corriente: 15 A

CARACT. APAGADOR
Tensión: 127 V~ - 250 V~
Corriente: 10 A - 6 A



1
año
GARANTÍA

AKSI

CÓDIGO	COLOR			DISTRIB.	MAYOREO	LISTA
124827	Blanco	12	144	\$32.00	\$46.00	\$56.00
124837	Plata	12	144	\$34.00	\$49.00	\$60.00
124847	Champagne	12	144	\$34.00	\$49.00	\$60.00

Contacto doble aterrizado con placa plástica

BOLSA

► Incluye tornillería de instalación



NOM

CARACTERÍSTICAS
Tensión: 127 V~
Corriente: 15 A



1
año
GARANTÍA

AKSI

CÓDIGO	COLOR			DISTRIB.	MAYOREO	LISTA
124823	Blanco	12	144	\$34.00	\$49.00	\$60.00
124833	Plata	12	144	\$37.00	\$53.00	\$65.00
124843	Champagne	12	144	\$37.00	\$53.00	\$65.00

Contacto triple aterrizado con placa plástica

BOLSA

► Incluye tornillería de instalación



NOM

CARACTERÍSTICAS
Tensión: 127 V~
Corriente: 15 A



1
año
GARANTÍA

AKSI

CÓDIGO	COLOR			DISTRIB.	MAYOREO	LISTA
124824	Blanco	12	144	\$45.00	\$64.00	\$79.00
124834	Plata	12	144	\$48.00	\$69.00	\$85.00
124844	Champagne	12	144	\$48.00	\$69.00	\$85.00

Contacto dúplex oculto aterrizado con placa plástica

BOLSA

► Incluye tornillería de instalación



CÓDIGO	COLOR			DISTRIB.	MAYOREO	LISTA
124825	Blanco	12	144	\$28.00	\$40.00	\$49.00
124835	Plata	12	144	\$32.00	\$46.00	\$56.00
124845	Champagne	12	144	\$32.00	\$46.00	\$56.00

Contacto aterrizado y doble puerto USB con placa plástica

BOLSA

► Incluye tornillería de instalación



CÓDIGO	COLOR			DISTRIB.	MAYOREO	LISTA
124826	Blanco	10	120	\$60.00	\$86.00	\$106.00
124836	Plata	10	120	\$63.00	\$90.00	\$111.00
124846	Champagne	10	120	\$63.00	\$90.00	\$111.00

Receptáculo telefónico de 4 hilos con placa plástica

BOLSA

► Incluye tornillería de instalación



CÓDIGO	COLOR			DISTRIB.	MAYOREO	LISTA
124851	Blanco	12	144	\$20.00	\$29.00	\$35.00
124856	Plata	12	144	\$22.00	\$31.00	\$39.00
124861	Champagne	12	144	\$22.00	\$31.00	\$39.00

Receptáculo para TV con placa plástica

BOLSA

► Incluye tornillería de instalación



CÓDIGO	COLOR			DISTRIB.	MAYOREO	LISTA
124852	Blanco	12	144	\$20.00	\$29.00	\$35.00
124857	Plata	12	144	\$22.00	\$31.00	\$39.00
124862	Champagne	12	144	\$22.00	\$31.00	\$39.00

Botón timbre de tecla con placa plástica

BOLSA

► Incluye tornillería de instalación



CÓDIGO	COLOR			DISTRIB.	MAYOREO	LISTA
124853	Blanco	12	144	\$22.00	\$31.00	\$39.00
124858	Plata	12	144	\$25.00	\$36.00	\$44.00
124863	Champagne	12	144	\$25.00	\$36.00	\$44.00

Receptáculo para RED de 8 hilos con placa plástica

BOLSA

► Incluye tornillería de instalación



CÓDIGO	COLOR			DISTRIB.	MAYOREO	LISTA
124854	Blanco	12	144	\$28.00	\$40.00	\$49.00
124859	Plata	12	144	\$31.00	\$44.00	\$55.00
124864	Champagne	12	144	\$31.00	\$44.00	\$55.00

CLASSIC

Elegancia y resistencia



► Apagadores . contactos . placas . receptáculos . timbres

Placa plástica de 1, 2 ó 3 módulos, para contacto dúplex y tapa ciega

BOLSA

► Incluye tornillería de instalación



CÓDIGO	COLOR	PRESENTACIÓN			DISTRIB.	MAYOREO	LISTA
118301	Marfil	1 Módulo	12	144	\$10.00	\$14.30	\$17.60
118302	Marfil	2 Módulos	12	144	\$10.00	\$14.30	\$17.60
118303	Marfil	3 Módulos	12	144	\$10.00	\$14.30	\$17.60
118304	Marfil	Módulo p / contacto dúplex	12	144	\$10.00	\$14.30	\$17.60
118305	Marfil	Ciega	12	144	\$10.00	\$14.30	\$17.60
118306	Blanco	1 Módulo	12	144	\$10.00	\$14.30	\$17.60
118307	Blanco	2 Módulos	12	144	\$10.00	\$14.30	\$17.60
118308	Blanco	3 Módulos	12	144	\$10.00	\$14.30	\$17.60
118309	Blanco	Módulo p / contacto dúplex	12	144	\$10.00	\$14.30	\$17.60
118310	Blanco	Ciega	12	144	\$10.00	\$14.30	\$17.60

Apagador sencillo de tecla

BOLSA



NOM

CARACTERÍSTICAS
Tensión: 127 V~ - 250 V~
Corriente: 10 A - 6 A



CÓDIGO	COLOR			DISTRIB.	MAYOREO	LISTA
118311	Marfil	12	144	\$7.00	\$10.00	\$12.30
118313	Blanco	12	144	\$7.00	\$10.00	\$12.30

Apagador de escalera de tecla

BOLSA



NOM

CARACTERÍSTICAS
Tensión: 127 V~ - 250 V~
Corriente: 10 A - 6 A



CÓDIGO	COLOR			DISTRIB.	MAYOREO	LISTA
118312	Marfil	12	144	\$10.00	\$14.30	\$17.60
118314	Blanco	12	144	\$10.00	\$14.30	\$17.60

Contacto sencillo polarizado y aterrizado



BOLSA



NOM

CARACTERÍSTICAS
Tensión: 127 V~
Corriente: 15 A

1
año
GARANTÍA

AKSI

CÓDIGO	PRESENTACIÓN	COLOR			DISTRIB.	MAYOREO	LISTA
118321	Polarizado	Marfil	12	144	\$9.00	\$12.90	\$15.90
118324	Polarizado	Blanco	12	144	\$9.00	\$12.90	\$15.90
118322	Aterrizado	Marfil	12	144	\$10.00	\$14.30	\$17.60
118325	Aterrizado	Blanco	12	144	\$10.00	\$14.30	\$17.60

Contacto dúplex oculto aterrizado



BOLSA



NOM

CARACTERÍSTICAS
Tensión: 127 V~
Corriente: 15 A

1
año
GARANTÍA

AKSI

CÓDIGO	COLOR			DISTRIB.	MAYOREO	LISTA
118323	Marfil	12	144	\$14.00	\$20.00	\$24.70
118326	Blanco	12	144	\$14.00	\$20.00	\$24.70

Receptáculo telefónico de 4 hilos y para TV

BOLSA



1
año
GARANTÍA

AKSI

CÓDIGO	COLOR			DISTRIB.	MAYOREO	LISTA
118331	Marfil	12	144	\$7.00	\$10.00	\$12.30
118333	Blanco	12	144	\$7.00	\$10.00	\$12.30
118332	Marfil	12	144	\$7.00	\$10.00	\$12.30
118334	Blanco	12	144	\$7.00	\$10.00	\$12.30

Botón timbre de tecla

BOLSA



NOM

CARACTERÍSTICAS
Tensión: 127 V~ - 250 V~
Corriente: 10 A - 6 A

1
año
GARANTÍA

AKSI

CÓDIGO	COLOR			DISTRIB.	MAYOREO	LISTA
118316	Marfil	12	144	\$10.00	\$14.30	\$17.60
118317	Blanco	12	144	\$10.00	\$14.30	\$17.60

Apagador sencillo y de escalera de tecla con placa plástica



BOLSA

► Incluye tornillería de instalación



NOM

CARACTERÍSTICAS
Tensión: 127 V~ - 250 V~
Corriente: 10 A - 6 A

1
año
GARANTÍA

AKSI

CÓDIGO	PRESENTACIÓN	COLOR			DISTRIB.	MAYOREO	LISTA
118342	Escalera	Marfil	12	144	\$18.00	\$26.00	\$32.00
118346	Escalera	Blanco	12	144	\$18.00	\$26.00	\$32.00
118341	Sencillo	Marfil	12	144	\$16.00	\$22.90	\$28.00
118345	Sencillo	Blanco	12	144	\$16.00	\$22.90	\$28.00

Apagador doble sencillo de tecla con placa plástica

BOLSA

► Incluye tornillería de instalación



NOM

CARACTERÍSTICAS
Tensión: 127 V~ - 250 V~
Corriente: 10 A - 6 A

1
año
GARANTÍA

AKSI

CÓDIGO	COLOR			DISTRIB.	MAYOREO	LISTA
118343	Marfil	12	144	\$22.00	\$31.00	\$39.00
118347	Blanco	12	144	\$22.00	\$31.00	\$39.00

Apagador triple sencillo de tecla con placa plástica

BOLSA

- Incluye tornillería de instalación



NOM

CARACTERÍSTICAS
Tensión: 127 V~ - 250 V~
Corriente: 10 A - 6 A



CÓDIGO	COLOR			DISTRIB.	MAYOREO	LISTA
118344	Marfil	12	144	\$29.00	\$41.00	\$51.00
118348	Blanco	12	144	\$29.00	\$41.00	\$51.00

Contacto aterrizado con placa plástica

BOLSA

- Incluye tornillería de instalación



NOM

CARACTERÍSTICAS
Tensión: 127 V~
Corriente: 15 A



CÓDIGO	COLOR			DISTRIB.	MAYOREO	LISTA
118362	Marfil	12	144	\$18.00	\$26.00	\$32.00
118369	Blanco	12	144	\$18.00	\$26.00	\$32.00

Contacto doble aterrizado con placa plástica

BOLSA

- Incluye tornillería de instalación



NOM

CARACTERÍSTICAS
Tensión: 127 V~
Corriente: 15 A



CÓDIGO	COLOR			DISTRIB.	MAYOREO	LISTA
118364	Marfil	12	144	\$28.00	\$40.00	\$49.00
118371	Blanco	12	144	\$28.00	\$40.00	\$49.00

Contacto triple aterrizado con placa plástica

BOLSA

- Incluye tornillería de instalación



NOM

CARACTERÍSTICAS
Tensión: 127 V~
Corriente: 15 A



CÓDIGO	COLOR			DISTRIB.	MAYOREO	LISTA
118366	Marfil	12	144	\$37.00	\$53.00	\$65.00
118373	Blanco	12	144	\$37.00	\$53.00	\$65.00

Contacto polarizado con placa plástica

BOLSA

- Incluye tornillería de instalación



NOM

CARACTERÍSTICAS
Tensión: 127 V~
Corriente: 15 A



CÓDIGO	COLOR			DISTRIB.	MAYOREO	LISTA
118361	Marfil	12	144	\$17.00	\$24.30	\$30.00
118368	Blanco	12	144	\$17.00	\$24.30	\$30.00

Contacto doble polarizado con placa plástica

BOLSA

- Incluye tornillería de instalación



NOM

CARACTERÍSTICAS
Tensión: 127 V~
Corriente: 15 A



CÓDIGO	COLOR			DISTRIB.	MAYOREO	LISTA
118363	Marfil	12	144	\$25.00	\$36.00	\$44.00
118370	Blanco	12	144	\$25.00	\$36.00	\$44.00

Contacto triple polarizado con placa plástica

BOLSA

► Incluye tornillería de instalación



CÓDIGO	COLOR			DISTRIB.	MAYOREO	LISTA
118365	Marfil	12	144	\$33.00	\$47.00	\$58.00
118372	Blanco	12	144	\$33.00	\$47.00	\$58.00

Contacto dúplex oculto aterrizado con placa plástica

BOLSA

► Incluye tornillería de instalación



CÓDIGO	COLOR			DISTRIB.	MAYOREO	LISTA
118367	Marfil	12	144	\$21.00	\$30.00	\$37.00
118374	Blanco	12	144	\$21.00	\$30.00	\$37.00

Contacto polarizado y apagador sencillo de tecla con placa plástica

BOLSA

► Incluye tornillería de instalación



CÓDIGO	COLOR			DISTRIB.	MAYOREO	LISTA
118351	Marfil	12	144	\$23.00	\$33.00	\$41.00
118353	Blanco	12	144	\$23.00	\$33.00	\$41.00

Contacto aterrizado y apagador sencillo de tecla con placa plástica

BOLSA

► Incluye tornillería de instalación



CÓDIGO	COLOR			DISTRIB.	MAYOREO	LISTA
118352	Marfil	12	144	\$24.00	\$34.00	\$42.00
118354	Blanco	12	144	\$24.00	\$34.00	\$42.00

Botón timbre de tecla con placa plástica

BOLSA

► Incluye tornillería de instalación



CÓDIGO	COLOR			DISTRIB.	MAYOREO	LISTA
118383	Marfil	12	144	\$16.00	\$22.90	\$28.00
118386	Blanco	12	144	\$16.00	\$22.90	\$28.00

Receptáculo para TV con placa plástica

BOLSA

► Incluye tornillería de instalación



CÓDIGO	COLOR			DISTRIB.	MAYOREO	LISTA
118382	Marfil	12	144	\$17.00	\$24.30	\$30.00
118385	Blanco	12	144	\$17.00	\$24.30	\$30.00

Receptáculo telefónico con placa plástica

BOLSA

► Incluye tornillería de instalación



CÓDIGO	COLOR			DISTRIB.	MAYOREO	LISTA
118381	Marfil	12	144	\$17.00	\$24.30	\$30.00
118384	Blanco	12	144	\$17.00	\$24.30	\$30.00

USO
RUDO

BASSIC

Resistencia y durabilidad



▶ Apagadores . contactos . receptáculos . timbres

Placa de 1, 2 ó 3 módulos, dúplex, ciega e interruptor vertical, de aluminio

BOLSA

▶ Incluye tornillería de instalación

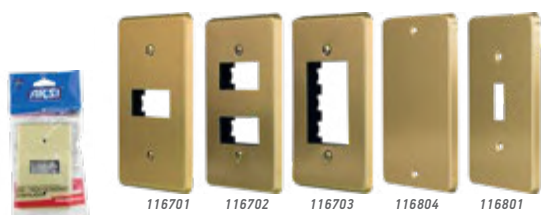
1
año
GARANTÍA

AKSI

PLACAS DE ALUMINIO

CÓDIGO	PRESENTACIÓN			DISTRIB.	MAYOREO	LISTA
116701	1 Módulo	10	100	\$14.00	\$20.00	\$24.70
116702	2 Módulos	10	100	\$14.00	\$20.00	\$24.70
116703	3 Módulos / Dúplex	10	100	\$14.00	\$20.00	\$24.70
116804	Placa ciega	10	100	\$11.00	\$15.70	\$19.40
116801	Interruptor vertical	10	100	\$11.00	\$15.70	\$19.40

Placa plástica

BOLSA

▶ Incluye tornillería de instalación

1
año
GARANTÍA

AKSI

CÓDIGO	PRESENTACIÓN			DISTRIB.	MAYOREO	LISTA
117261	Contacto telefónico	10	100	\$10.00	\$14.30	\$17.60
116815	Pasacable	10	100	\$5.40	\$7.70	\$9.50
117262	Con cople coaxial	10	100	\$10.00	\$14.30	\$17.60
116814	Placa ciega	10	100	\$5.40	\$7.70	\$9.50
116811	Interruptor vertical	10	100	\$5.40	\$7.70	\$9.50

Interruptor sencillo y fluorescente

BOLSA

- ▶ Resiste sobrecargas mayores a 10 A
- ▶ Resistencia mayor a 40 000 ciclos de operación
- ▶ Fabricado en materiales termorresistentes



NOM

CARACTERÍSTICAS
 Tensión: 127 V~
 Corriente: 10 A
1
año
GARANTÍA

AKSI

CÓDIGO	PRESENTACIÓN			DISTRIB.	MAYOREO	LISTA
116721	Sencillo	20	200	\$7.00	\$10.00	\$12.30
116722	Fluorescente	20	200	\$6.60	\$9.40	\$11.60

Interruptor de escalera sencillo y fluorescente



BOLSA

- ▶ Resiste sobrecargas mayores a 10 A
- ▶ Resistencia mayor a 40 000 ciclos de operación
- ▶ Fabricado en materiales termorresistentes



NOM

CARACTERÍSTICAS
 Tensión: 127 V~
 Corriente: 10 A
1
año
GARANTÍA

AKSI

CÓDIGO	PRESENTACIÓN			DISTRIB.	MAYOREO	LISTA
116723	Sencillo	20	200	\$7.60	\$10.90	\$13.40
116724	Fluorescente	20	200	\$7.60	\$10.90	\$13.40

Contacto sencillo

BOLSA

- ▶ Resiste sobrecargas mayores a 10 A
- ▶ Resistencia mayor a 5 000 ciclos de conexión
- ▶ Fabricado en materiales termorresistentes



NOM

CARACTERÍSTICAS
 Tensión: 127 V~
 Corriente: 10 A
1
año
GARANTÍA

AKSI

CÓDIGO	PRESENTACIÓN			DISTRIB.	MAYOREO	LISTA
116761		20	200	\$8.00	\$11.40	\$14.10

Placa para contacto redondo sencillo y dúplex de aluminio o plástico

BOLSA

- ▶ Para uso con contactos sencillos, polarizados, aterrizados y cara de chino
- ▶ Incluye tornillería de instalación

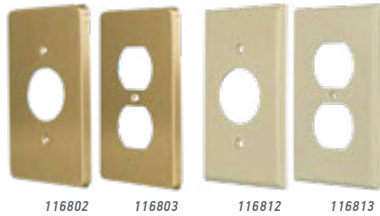

CÓDIGO	PRESENTACIÓN			DISTRIB.	MAYOREO	LISTA
116802	1 Módulo - aluminio	10	100	\$11.00	\$15.70	\$19.40
116803	2 Módulos - aluminio	10	100	\$11.00	\$15.70	\$19.40
116812	1 Módulo - plástico	10	100	\$5.40	\$7.70	\$9.50
116813	2 Módulos - plástico	10	100	\$5.40	\$7.70	\$9.50

Placa de intemperie para contacto sencillo o dúplex de plástico

BOLSA

- ▶ Para uso con contactos dobles, polarizados, aterrizados y cara de chino
- ▶ Ideal para uso en intemperie
- ▶ Incluye tornillería de instalación



CÓDIGO	PRESENTACIÓN			DISTRIB.	MAYOREO	LISTA
117272	Dúplex	10	100	\$18.00	\$26.00	\$32.00
117271	Sencillo	10	100	\$18.00	\$26.00	\$32.00

Interruptor de palanca doble horizontal

BOLSA

- ▶ Resiste sobrecargas mayores a 10 A
- ▶ Resistencia mayor a 40 000 ciclos de operación
- ▶ Fabricado en materiales termostresistentes
- ▶ Incluye tornillería



NOM

CARACTERÍSTICAS

Tensión: 125 V~ - 250 V~
Corriente: 10 A - 5 A

CÓDIGO			DISTRIB.	MAYOREO	LISTA
116823	10	100	\$20.00	\$29.00	\$35.00

Contacto dúplex aterrizado

BOLSA

- ▶ Resiste sobrecargas mayores a 15 A
- ▶ Resistencia mayor a 5 000 ciclos de conexión
- ▶ Fabricado en materiales termostresistentes
- ▶ Incluye tornillería de instalación



NOM

CARACTERÍSTICAS

Tensión: 125 V~
Corriente: 15 A

CÓDIGO			DISTRIB.	MAYOREO	LISTA
116834	10	100	\$12.00	\$17.10	\$21.20

Interruptor de palanca sencillo con contacto polarizado o aterrizado

BOLSA

- ▶ Resiste sobrecargas mayores a 15 A
- ▶ Resistencia mayor a: 5 000 ciclos - contacto y 40 000 ciclos - interruptor
- ▶ Termostresistentes



NOM

CARACT. CONTACTO

Tensión: 125 V~
Corriente: 15 A

CARACT. INTERRUPTOR

Tensión: 125 V~ - 250 V~
Corriente: 10 A - 5 A

CÓDIGO			DISTRIB.	MAYOREO	LISTA
116825	10	100	\$22.00	\$31.00	\$39.00
116824	10	100	\$23.00	\$33.00	\$41.00

Contacto sencillo aterrizado

BOLSA

- ▶ Resiste sobrecargas mayores a 15 A
- ▶ Resistencia mayor a 5 000 ciclos
- ▶ Fabricado en materiales termostresistentes
- ▶ Incluye tornillería de instalación



NOM

CARACTERÍSTICAS

Tensión: 125 V~
Corriente: 15 A

CÓDIGO			DISTRIB.	MAYOREO	LISTA
116831	10	100	\$15.00	\$21.40	\$26.00

Contacto sencillo cara de chino

BOLSA

- ▶ Resiste sobrecargas mayores a 20 A
- ▶ Resistencia mayor a 5 000 ciclos
- ▶ Fabricado en materiales termostresistentes
- ▶ Incluye tornillería de instalación



NOM

CARACTERÍSTICAS

Tensión: 250 V~
Corriente: 20 A

CÓDIGO			DISTRIB.	MAYOREO	LISTA
116832	10	100	\$16.00	\$22.90	\$28.00

Contacto sencillo mixto

BOLSA

- ▶ Resiste sobrecargas mayores a 20 A
- ▶ Resistencia mayor a 5 000 ciclos de conexión
- ▶ Fabricado en materiales termostresistentes
- ▶ Incluye tornillería de instalación



NOM

CARACTERÍSTICAS

Tensión: 125 V~
Corriente: 20 A

CÓDIGO			DISTRIB.	MAYOREO	LISTA
116833	10	100	\$16.00	\$22.90	\$28.00

Interruptor de palanca doble con placa plástica

BOLSA

- ▶ Resiste sobrecargas mayores a 15 A
- ▶ Resistencia mayor a 40 000 ciclos de operación
- ▶ Fabricado en materiales termostresistentes
- ▶ Incluye tornillería de instalación

NOM
CARACTERÍSTICAS
 Tensión: 125 V~ - 250 V~
 Corriente: 10 A - 5 A

CÓDIGO			DISTRIB.	MAYOREO	LISTA
116881	10	100	\$26.00	\$37.00	\$46.00

Contacto dúplex aterrizado con placa plástica

BOLSA

- ▶ Resiste sobrecargas mayores a 15 A
- ▶ Resistencia mayor a 5 000 ciclos de conexión
- ▶ Fabricado en materiales termostresistentes
- ▶ Incluye tornillería de instalación

NOM
CARACTERÍSTICAS
 Tensión: 125 V~
 Corriente: 15 A

CÓDIGO			DISTRIB.	MAYOREO	LISTA
116882	10	100	\$17.00	\$24.30	\$30.00

Contacto dúplex aterrizado con placa para intemperie

BOLSA

- ▶ Resiste sobrecargas mayores a 15 A
- ▶ Resistencia mayor a 5 000 ciclos de conexión
- ▶ Fabricado en materiales termostresistentes
- ▶ Incluye tornillería de instalación

NOM
CARACTERÍSTICAS
 Tensión: 125 V~
 Corriente: 15 A

CÓDIGO			DISTRIB.	MAYOREO	LISTA
116885	10	100	\$30.00	\$43.00	\$53.00

Interruptor de palanca y contacto con placa plástica

BOLSA

- ▶ Resiste sobrecargas de 15 A
- ▶ Resistencia mayor a 5 000 ciclos - contacto y 40 000 ciclos - interruptor
- ▶ Fabricado en materiales termostresistentes
- ▶ Incluye tornillería de instalación

CARACT. CONTACTO
 Tensión: 125 V~
 Corriente: 15 A

CARACT. INTERRUPTOR
 Tensión: 125 V~ - 250 V~
 Corriente: 10 A - 5 A

CÓDIGO			DISTRIB.	MAYOREO	LISTA
116883	10	100	\$30.00	\$43.00	\$53.00

Interruptor de palanca y contacto con placa de aluminio

BOLSA

- ▶ Resiste sobrecargas de 15 A
- ▶ Resistencia mayor a 5 000 ciclos - contacto y 40 000 ciclos - interruptor
- ▶ Fabricado en materiales termostresistentes
- ▶ Incluye tornillería de instalación

CARACT. CONTACTO
 Tensión: 125 V~
 Corriente: 15 A

CARACT. INTERRUPTOR
 Tensión: 125 V~ - 250 V~
 Corriente: 10 A - 5 A

CÓDIGO			DISTRIB.	MAYOREO	LISTA
116884	10	100	\$40.00	\$57.00	\$71.00

Contacto dúplex de superficie aterrizado

BOLSA

- ▶ Resiste sobrecargas mayores a 15 A
- ▶ Resistencia mayor a 5 000 ciclos de conexión
- ▶ Fabricado en materiales termostresistentes

NOM
CARACTERÍSTICAS
 Tensión: 125 V~
 Corriente: 15 A

CÓDIGO			DISTRIB.	MAYOREO	LISTA
116781	10	100	\$15.00	\$21.40	\$26.00

Contacto sencillo visible oval y plano

BOLSA

- ▶ Resiste sobrecargas de 10 A y 15 A
- ▶ Resistencia mayor a 5 000 ciclos de conexión
- ▶ Fabricado en materiales termostresistentes
- ▶ Incluye tornillería de instalación

NOM
CARACTERÍSTICAS
 Tensión: 127 V~(plano) / 125 V~(oval)
 Corriente: 10 A (plano) / 15 A (oval)

CÓDIGO	PRESENTACIÓN			DISTRIB.	MAYOREO	LISTA
116771	Plano	20	200	\$11.00	\$15.70	\$19.40
116772	Oval	20	200	\$8.00	\$11.40	\$14.10

Interruptor visible plano sencillo y de timbre

BOLSA

- ▶ Resiste sobrecargas mayores a 6 A
- ▶ Resistencia mayor a 40 000 ciclos de operación
- ▶ Fabricado en materiales termostresistentes
- ▶ Incluye base y tornillería de instalación

NOM
CARACTERÍSTICAS
 Tensión: 125 V~
 Corriente: 6 A

CÓDIGO	PRESENTACIÓN			DISTRIB.	MAYOREO	LISTA
116741	Timbre	20	200	\$12.00	\$17.10	\$21.20
116742	Sencillo	20	200	\$12.00	\$17.10	\$21.20

Interruptor visible oval sencillo y de timbre

BOLSA

- ▶ Resiste sobrecargas mayores a 4 A
- ▶ Resistencia mayor a 40 000 ciclos de operación
- ▶ Fabricado en materiales termostresistentes
- ▶ Incluye tornillería de instalación

NOM
CARACTERÍSTICAS
 Tensión: 250 V~
 Corriente: 4 A

CÓDIGO	PRESENTACIÓN			DISTRIB.	MAYOREO	LISTA
116743	Sencillo	20	200	\$7.00	\$10.00	\$12.30
116744	Timbre	20	200	\$9.00	\$12.90	\$15.90

Interruptor de palanca, vía unipolar

BOLSA

► Encendido / Apagado



117201

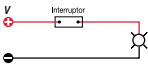

NOM

CARACTERÍSTICAS
Tensión: 125 V~
Corriente: 6 A

BOLSA



117202

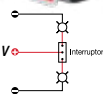

1 AÑO GARANTÍA
AKSI

CÓDIGO	TORNILLOS			DISTRIB.	MAYOREO	LISTA
117201	2	20	200	\$20.00	\$29.00	\$35.00
117202	3	20	200	\$21.00	\$30.00	\$37.00

Interruptor de palanca, doble vía

BOLSA

BOLSA



117203

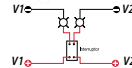

NOM

CARACTERÍSTICAS
Tensión: 125 V~ - 250 V~
Corriente: 10 A - 6 A



117204

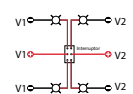

1 AÑO GARANTÍA
AKSI

CÓDIGO	TORNILLOS			DISTRIB.	MAYOREO	LISTA
117203	4	20	200	\$30.00	\$43.00	\$53.00
117204	6	20	200	\$33.00	\$47.00	\$58.00

Barra multicontacto 4 entradas, cable calibre 16 AWG

FAJILLA

- Con interruptor de protección contra sobrecargas
- Cable de 20 cm y 50 cm
- Cuerpo fabricado en PVC



NOM

CARACTERÍSTICAS
Tensión: 125 V~
Corriente: 15 A



1 AÑO GARANTÍA
AKSI

CÓDIGO	CABLE	CALIBRE			DISTRIB.	MAYOREO	LISTA
118901	20 cm	16 AWG	6	36	\$45.00	\$64.00	\$79.00
118902	50 cm	16 AWG	6	36	\$59.00	\$84.00	\$104.00

Barra multicontacto 4 entradas, cable calibre 14 AWG

FAJILLA

- Con interruptor de protección contra sobrecargas
- Cable de 20 cm y 30 cm
- Cuerpo fabricado en PVC



NOM

CARACTERÍSTICAS
Tensión: 125 V~
Corriente: 15 A



1 AÑO GARANTÍA
AKSI

CÓDIGO	CABLE	CALIBRE			DISTRIB.	MAYOREO	LISTA
118911	20 cm	14 AWG	6	36	\$56.00	\$80.00	\$99.00
118912	30 cm	14 AWG	6	36	\$75.00	\$107.00	\$132.00

Barra multicontacto 6 entradas, cable calibre 16 AWG

FAJILLA

- Con interruptor de protección contra sobrecargas
- Cable de 20 cm y 50 cm
- Cuerpo fabricado en PVC



NOM

CARACTERÍSTICAS
Tensión: 125 V~
Corriente: 15 A

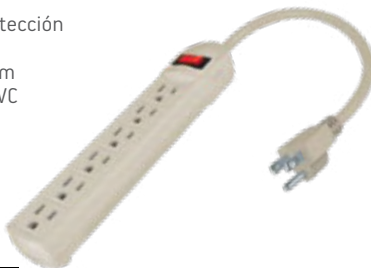

1 AÑO GARANTÍA
AKSI

CÓDIGO	CABLE	CALIBRE			DISTRIB.	MAYOREO	LISTA
118906	20 cm	16 AWG	6	36	\$49.00	\$70.00	\$86.00
118907	50 cm	16 AWG	4	24	\$70.00	\$100.00	\$123.00

Barra multicontacto 6 entradas, cable calibre 14 AWG

FAJILLA

- Con interruptor de protección contra sobrecargas
- Cable de 20 cm y 30 cm
- Cuerpo fabricado en PVC



NOM

CARACTERÍSTICAS
Tensión: 125 V~
Corriente: 15 A



1 AÑO GARANTÍA
AKSI

CÓDIGO	CABLE	CALIBRE			DISTRIB.	MAYOREO	LISTA
118921	20 cm	14 AWG	6	36	\$75.00	\$107.00	\$132.00
118922	30 cm	14 AWG	6	36	\$80.00	\$114.00	\$141.00

Barra multicontacto 6 entradas, cable calibre 16 AWG

NUEVO

FAJILLA

- ▶ Con interruptor de protección contra sobrecargas
- ▶ Cable de 20 cm
- ▶ Cuerpo fabricado policarbonato
- ▶ Colores surtidos



NOM

CARACTERÍSTICAS
Tensión: 125 V-
Corriente: 15 A

CÓDIGO	CABLE	CALIBRE		DISTRIB.	MAYOREO	LISTA
118909	20 cm	16 AWG	12	\$47.00	\$67.00	\$83.00



Crea conexiones divertidas



Barra multicontacto 6 entradas, cable calibre 14 AWG

NUEVO

FAJILLA

- ▶ Con interruptor de protección contra sobrecargas
- ▶ Cable de 75 cm
- ▶ Cuerpo fabricado policarbonato



NOM

CARACTERÍSTICAS
Tensión: 125 V-
Corriente: 15 A



CÓDIGO	CABLE	CALIBRE			DISTRIB.	MAYOREO	LISTA
118971	75 cm	14 AWG	6	36	\$105.00	\$150.00	\$185.00
118972	75 cm	14 AWG	6	36	\$110.00	\$155.00	\$195.00

Barra multicontacto 3 entradas y 2 puertos USB, cable calibre 16 AWG

NUEVO

FAJILLA

- ▶ Cable de 50 cm
- ▶ Cuerpo fabricado en PVC



NOM

CARACTERÍSTICAS
Tensión: 125 V-
Corriente: 15 A



CÓDIGO	CABLE	CALIBRE			DISTRIB.	MAYOREO	LISTA
118963	50 cm	16 AWG	4	24	\$142.00	\$205.00	\$250.00

Multicontacto de pared, 3 contactos aterrizados y 2 puertos USB

BLÍSTER

- ▶ Protege contra sobrecargas
- ▶ Supresor de picos de 300 Joules
- ▶ Ideal para hogar, oficina y salas de cómputo



NOM

CARACTERÍSTICAS
Tensión: 125 V~
Corriente: 15 A

PUERTO USB
Salida: 5 V~
Usando 1 puerto: 2.4 A
Usando 2 puertos: 1.2 A

1 año GARANTÍA

AKSI

CÓDIGO			DISTRIB.	MAYOREO	LISTA
117421	4	24	\$150.00	\$215.00	\$265.00

Multicontacto triple polarizado tipo bisagra

BOLSA

- ▶ Bisagra ajustable a diferentes ángulos
- ▶ Resistencia mayor a 5 000 ciclos de conexión
- ▶ Resiste sobrecargas de más de 15 A
- ▶ Fabricado en materiales termostresistentes



NOM

CARACTERÍSTICAS
Tensión: 125 V~
Corriente: 15 A

1 año GARANTÍA

AKSI

CÓDIGO			DISTRIB.	MAYOREO	LISTA
117414	6	36	\$23.00	\$33.00	\$41.00

Multicontacto triple aterrizado

BOLSA

- ▶ Resiste sobrecargas de más de 15 A
- ▶ Resistencia mayor a 5 000 ciclos de conexión
- ▶ Fabricado en materiales termostresistentes



NOM

CARACTERÍSTICAS
Tensión: 125 V~
Corriente: 15 A

1 año GARANTÍA

AKSI

CÓDIGO			DISTRIB.	MAYOREO	LISTA
117413	6	36	\$22.00	\$31.00	\$39.00

Multicontacto triple polarizado tipo bisagra, entradas laterales

BOLSA

- ▶ Bisagra ajustable a diferentes ángulos
- ▶ Resiste sobrecargas de más de 15 A
- ▶ Resistencia mayor a 5 000 ciclos de conexión
- ▶ Fabricado en materiales termostresistentes



NOM

CARACTERÍSTICAS
Tensión: 125 V~
Corriente: 15 A

1 año GARANTÍA

AKSI

CÓDIGO			DISTRIB.	MAYOREO	LISTA
117412	6	36	\$17.00	\$24.30	\$30.00

Multicontacto triple polarizado

BOLSA

- ▶ Resiste sobrecargas de más de 15 A
- ▶ Resistencia mayor a 5 000 ciclos de conexión
- ▶ Fabricado en materiales termostresistentes



NOM

CARACTERÍSTICAS
Tensión: 125 V~
Corriente: 15 A

1 año GARANTÍA

AKSI

CÓDIGO			DISTRIB.	MAYOREO	LISTA
117411	10	100	\$14.00	\$20.00	\$24.70

Adaptador de clavija aterrizada (espigas polarizadas)

BOLSA

- ▶ Resiste sobrecargas de más de 15 A
- ▶ Resistencia mayor a 5 000 ciclos de conexión
- ▶ Fabricado en PVC



NOM

CARACTERÍSTICAS
Tensión: 125 V~
Corriente: 15 A

1 año GARANTÍA

AKSI

CÓDIGO	PRESENTACIÓN			DISTRIB.	MAYOREO	LISTA
117402	Individual	20	200	\$7.00	\$10.00	\$12.30
117404	2 Pack	10	100	\$12.00	\$17.10	\$21.20

Adaptador de clavija aterrizada

BOLSA

- ▶ Resiste sobrecargas de más de 15 A
- ▶ Resistencia mayor a 5 000 ciclos de conexión
- ▶ Fabricado en PVC



NOM

CARACTERÍSTICAS
Tensión: 125 V~
Corriente: 15 A

1 año GARANTÍA

AKSI

CÓDIGO	PRESENTACIÓN			DISTRIB.	MAYOREO	LISTA
117403	Individual	20	200	\$6.00	\$8.60	\$10.60
117405	2 Pack	10	100	\$10.00	\$14.30	\$17.60

Adaptador de clavija europea a americana

BOLSA

- ▶ Útil para convertir una clavija europea en una americana
- ▶ Resiste sobrecargas de 6 A
- ▶ Resistencia mayor a 5 000 ciclos de conexión
- ▶ Fabricado en materiales termostresistentes



NOM

CARACTERÍSTICAS
Tensión: 250 V~
Corriente: 6 A

1 año GARANTÍA

AKSI

CÓDIGO			DISTRIB.	MAYOREO	LISTA
117401	20	200	\$8.00	\$11.40	\$14.10

Interruptor de presión "Push"

BOLSA

- ▶ Fabricado en materiales termorresistentes

NOM
CARACTERÍSTICAS
 Tensión: 125 V~
 Corriente: 3 A

1
 año
 GARANTÍA

AKSI

CÓDIGO			DISTRIB.	MAYOREO	LISTA
117211	20	200	\$9.00	\$12.90	\$15.90

Interruptor de cadena

BOLSA

- ▶ Ideal para ventiladores de techo
- ▶ Fabricado en materiales termorresistentes
- ▶ 3 Velocidades / 4 posiciones

NOM
CARACTERÍSTICAS
 Tensión: 125 V~ 250 V~
 Corriente: 6 A 3 A

1
 año
 GARANTÍA

AKSI

CÓDIGO			DISTRIB.	MAYOREO	LISTA
117212	20	200	\$20.00	\$29.00	\$35.00

Interruptor de paso

BOLSA

- ▶ Ideal para controlar el encendido de lámparas
- ▶ Útil mecanismo deslizable

NOM
CARACTERÍSTICAS
 Tensión: 250 V~
 Corriente: 3 A

1
 año
 GARANTÍA

AKSI

CÓDIGO			DISTRIB.	MAYOREO	LISTA
117213	20	200	\$7.00	\$10.00	\$12.30

Contacto y clavija sencillos abrazadera metálica

BOLSA

- ▶ Resiste sobrecargas de más de 15 A
- ▶ Resistencia mayor a 5 000 ciclos de conexión
- ▶ Fabricado en materiales termorresistentes

117351

USO RUDO

NOM
CARACTERÍSTICAS
 Tensión: 125 V~
 Corriente: 15 A

1
 año
 GARANTÍA

AKSI

CÓDIGO			DISTRIB.	MAYOREO	LISTA
117301	10	100	\$15.00	\$21.40	\$26.00
117351	10	100	\$10.00	\$14.30	\$17.60

Contacto y clavija aterrizados abrazadera metálica

BOLSA

- ▶ Resiste sobrecargas de más de 15 A
- ▶ Resistencia mayor a 5 000 ciclos de conexión
- ▶ Fabricado en materiales termorresistentes

117352

USO RUDO

NOM
CARACTERÍSTICAS
 Tensión: 125 V~
 Corriente: 15 A

1
 año
 GARANTÍA

AKSI

CÓDIGO			DISTRIB.	MAYOREO	LISTA
117302	10	100	\$15.00	\$21.40	\$26.00
117352	10	100	\$11.00	\$15.70	\$19.40

Contacto y clavija cara de chino abrazadera metálica

BOLSA

- ▶ Resiste sobrecargas de más de 15 A
- ▶ Resistencia mayor a 5000 ciclos de conexión
- ▶ Fabricado en materiales termorresistentes

117353

USO RUDO

NOM
CARACTERÍSTICAS
 Tensión: 250 V~
 Corriente: 15 A

1
 año
 GARANTÍA

AKSI

CÓDIGO			DISTRIB.	MAYOREO	LISTA
117303	10	100	\$16.00	\$22.90	\$28.00
117353	10	100	\$14.00	\$20.00	\$24.70

Contacto y clavija polarizado abrazadera plástica

BOLSA

- ▶ Resiste sobrecargas de más de 15 A
- ▶ Resistencia mayor a 5 000 ciclos de conexión
- ▶ Fabricado en materiales termorresistentes de alto impacto

117361

USO RUDO

NOM
CARACTERÍSTICAS
 Tensión: 125 V~
 Corriente: 15 A

1
 año
 GARANTÍA

AKSI

CÓDIGO			DISTRIB.	MAYOREO	LISTA
117311	10	100	\$14.00	\$20.00	\$24.70
117361	10	100	\$11.00	\$15.70	\$19.40

Contacto y clavija aterrizados abrazadera plástica

BOLSA

- ▶ Resiste sobrecargas de más de 15 A
- ▶ Resistencia mayor a 5 000 ciclos de conexión
- ▶ Fabricado en materiales termorresistentes de alto impacto

117362

USO RUDO

NOM
CARACTERÍSTICAS
 Tensión: 125 V~
 Corriente: 15 A

1
 año
 GARANTÍA

AKSI

CÓDIGO			DISTRIB.	MAYOREO	LISTA
117312	10	100	\$14.00	\$20.00	\$24.70
117362	10	100	\$12.00	\$17.10	\$21.20

Clavija plástica plana abrazadera metálica

BOLSA

- ▶ Resiste sobrecargas de 15 A
- ▶ Resistencia mayor a 5 000 ciclos de conexión
- ▶ Fabricado en materiales termorresistentes de alto impacto



NOM

CARACTERÍSTICAS
Tensión: 125 V~
Corriente: 15 A

CÓDIGO			DISTRIB.	MAYOREO	LISTA
117382	10	100	\$9.00	\$12.90	\$15.90

Clavija industrial blindada

BOLSA

- ▶ Resiste sobrecargas de 15 A
- ▶ Resistencia mayor a 5 000 ciclos de conexión
- ▶ Fabricado en materiales termorresistentes de alto impacto



NOM

CARACTERÍSTICAS
Tensión: 125 V~
Corriente: 15 A

CÓDIGO			DISTRIB.	MAYOREO	LISTA
117383	10	200	\$12.00	\$17.10	\$21.20

Contacto y clavija de hule

BOLSA

- ▶ Resiste sobrecargas de 15 A
- ▶ Resistencia mayor a 5 000 ciclos de conexión
- ▶ Fabricado en materiales termorresistentes de alto impacto

117371



117321



NOM

CARACTERÍSTICAS
Tensión: 120 V~
Corriente: 15 A

CÓDIGO			DISTRIB.	MAYOREO	LISTA
117321	20	200	\$8.00	\$11.40	\$14.10
117371	20	200	\$7.00	\$10.00	\$12.30

Clavija ovalada plástica blanca

BOLSA

- ▶ Pata plana
- ▶ Resiste sobrecargas de 10 A
- ▶ Resistencia mayor a 5 000 ciclos de conexión
- ▶ Fabricado en materiales termorresistentes



NOM

CARACTERÍSTICAS
Tensión: 125 V~
Corriente: 10 A

CÓDIGO			DISTRIB.	MAYOREO	LISTA
117374	20	200	\$5.00	\$7.10	\$8.80

Clavija ovalada plástica negra

BOLSA

- ▶ Pata plana
- ▶ Resiste sobrecargas de 10 A
- ▶ Resistencia mayor a 5 000 ciclos de conexión
- ▶ Fabricado en materiales termorresistentes



NOM

CARACTERÍSTICAS
Tensión: 125 V~
Corriente: 10 A

CÓDIGO			DISTRIB.	MAYOREO	LISTA
117373	20	200	\$5.00	\$7.10	\$8.80

Clavija redonda de hule

BOLSA

- ▶ Resiste sobrecargas de 15 A
- ▶ Resistencia mayor a 5 000 ciclos de conexión
- ▶ Fabricado en materiales termorresistentes



NOM

CARACTERÍSTICAS
Tensión: 125 V~
Corriente: 15 A

CÓDIGO			DISTRIB.	MAYOREO	LISTA
117381	20	200	\$7.00	\$10.00	\$12.30

Portalámpara con apagador de paso

BOLSA

- ▶ Resiste sobrecargas de 4 A
- ▶ Resistencia mayor a 10 000 ciclos
- ▶ Fabricado en materiales termorresistentes



NOM

CARACTERÍSTICAS
Tensión: 250 V~
Potencia: 660 W

CÓDIGO			DISTRIB.	MAYOREO	LISTA
117512	10	100	\$27.00	\$39.00	\$48.00

Portalámpara con apagador de llave

BOLSA

- ▶ Resiste sobrecargas de 4 A
- ▶ Resistencia mayor a 10 000 ciclos
- ▶ Fabricado en materiales termorresistentes



NOM

CARACTERÍSTICAS
Tensión: 250 V~
Potencia: 660 W

CÓDIGO			DISTRIB.	MAYOREO	LISTA
117513	10	100	\$27.00	\$39.00	\$48.00

Clavija plástica pata plana

BOLSA

- ▶ Pata plana
- ▶ Resiste sobrecargas de 10 A
- ▶ Resistencia mayor a 5 000 ciclos de conexión
- ▶ Fabricado en materiales termorresistentes



NOM

CARACTERÍSTICAS
Tensión: 127 V~
Corriente: 10 A

CÓDIGO			DISTRIB.	MAYOREO	LISTA
117372	20	200	\$5.00	\$7.10	\$8.80

Portalámpara con clavija (E26)

BOLSA

- ▶ Resiste sobrecargas de 5.2 A
- ▶ Resistencia mayor a 5 000 ciclos
- ▶ Fabricado en materiales termorresistentes

NOM
CARACTERÍSTICAS
 Tensión: 125 V~
 Potencia: 660 W

1
 año
 GARANTÍA

AKSI

CÓDIGO	PRESENTACIÓN			DISTRIB.	MAYOREO	LISTA
117541	Marfil	10	100	\$6.00	\$8.60	\$10.60

Portalámpara con clavija (E26)

BOLSA

- ▶ Resiste sobrecargas de 5.2 A
- ▶ Resistencia mayor a 5 000 ciclos
- ▶ Fabricado en materiales termorresistentes

NOM
CARACTERÍSTICAS
 Tensión: 125 V~
 Potencia: 660 W

1
 año
 GARANTÍA

AKSI

CÓDIGO	PRESENTACIÓN			DISTRIB.	MAYOREO	LISTA
117542	Negro	10	100	\$6.00	\$8.60	\$10.60

Portalámpara de baquelita con doble ladrón

BOLSA

- ▶ 2 contactos polarizados
- ▶ Resiste sobrecargas de 5.2 A
- ▶ Fabricado en materiales termorresistentes

NOM
CARACTERÍSTICAS
 Tensión: 125 V~
 Potencia: 660 W

1
 año
 GARANTÍA

AKSI

CÓDIGO	PRESENTACIÓN			DISTRIB.	MAYOREO	LISTA
117521	Negro	10	100	\$11.00	\$15.70	\$19.40
117522	Marfil	10	100	\$11.00	\$15.70	\$19.40

Portalámpara con interruptor de cadena y doble ladrón

BOLSA

- ▶ 2 contactos polarizados
- ▶ Resiste sobrecargas de 5.2 A
- ▶ Resistencia mayor a 10 000 ciclos
- ▶ Fabricado en materiales termorresistentes

NOM
CARACTERÍSTICAS
 Tensión: 125 V~
 Potencia: 660 W

1
 año
 GARANTÍA

AKSI

CÓDIGO			DISTRIB.	MAYOREO	LISTA
117531	10	100	\$12.00	\$17.10	\$21.20

Portalámpara con interruptor de cadena

BOLSA

- ▶ Resiste sobrecargas de 2.6 A
- ▶ Resistencia mayor a 10 000 ciclos
- ▶ Fabricado en materiales termorresistentes

NOM
CARACTERÍSTICAS
 Tensión: 250 V~
 Potencia: 660 W

1
 año
 GARANTÍA

AKSI

CÓDIGO			DISTRIB.	MAYOREO	LISTA
117504	10	100	\$20.00	\$29.00	\$35.00

Portalámpara sencillo

BOLSA

- ▶ Resiste sobrecargas de 4 A
- ▶ Fabricado en materiales termorresistentes

NOM
CARACTERÍSTICAS
 Tensión: 125 V~
 Potencia: 660 W

1
 año
 GARANTÍA

AKSI

CÓDIGO			DISTRIB.	MAYOREO	LISTA
117501	10	100	\$6.00	\$8.60	\$10.60

Portalámpara de baquelita con apagador de paso

BOLSA

- ▶ Resiste sobrecargas de 2 A
- ▶ Resistencia mayor a 10 000 ciclos
- ▶ Fabricado en materiales termorresistentes

NOM
CARACTERÍSTICAS
 Tensión: 250 V~
 Potencia: 660 W

1
 año
 GARANTÍA

AKSI

CÓDIGO			DISTRIB.	MAYOREO	LISTA
117502	10	100	\$15.00	\$21.40	\$26.00

Portalámpara de baquelita con apagador de llave

BOLSA

- ▶ Resiste sobrecargas de 2 A
- ▶ Resistencia mayor a 10 000 ciclos
- ▶ Fabricado en materiales termorresistentes

NOM
CARACTERÍSTICAS
 Tensión: 250 V~
 Potencia: 660 W

1
 año
 GARANTÍA

AKSI

CÓDIGO			DISTRIB.	MAYOREO	LISTA
117503	10	100	\$16.00	\$22.90	\$28.00

Portalámpara doble de baquelita

BOLSA

- ▶ Resiste sobrecargas de 2 A
- ▶ Fabricado en materiales termorresistentes

NOM
CARACTERÍSTICAS
 Tensión: 250 V~
 Potencia: 660 W

1
 año
 GARANTÍA

AKSI

CÓDIGO			DISTRIB.	MAYOREO	LISTA
117506	10	100	\$12.00	\$17.10	\$21.20

Portalámpara de hule con cable calibre 18 AWG

BOLSA

- ▶ Para uso en intemperie
- ▶ Cable calibre 18 AWG
- ▶ Resiste sobrecargas de 2.6 A
- ▶ Fabricado en materiales termorresistentes



NOM
CARACTERÍSTICAS
 Tensión: 250 V~
 Potencia: 660 W



CÓDIGO			DISTRIB.	MAYOREO	LISTA
117546	10	100	\$9.00	\$12.90	\$15.90

Portalámpara con cable de alimentación

FAJILLA

- ▶ Extensión con recubrimiento PVC autoextinguible
- ▶ Portalámpara de baquelita
- ▶ Cable calibre 18



HECHO EN MÉXICO
NOM
CARACTERÍSTICAS
 Tensión: 127 V~
 Frecuencia: 60 Hz
 Corriente: 10 A



CÓDIGO	LARGO		DISTRIB.	MAYOREO	LISTA
117591	4 m	30	\$45.00	\$64.00	\$79.00
117592	6 m	25	\$55.00	\$79.00	\$97.00
117593	8 m	20	\$70.00	\$100.00	\$123.00

Tapón extensión (E26)

BOLSA

- ▶ Ideal para convertir un portalámparas en un tomacorriente
- ▶ Resiste sobrecargas de 5.2 A



NOM
CARACTERÍSTICAS
 Tensión: 125 V~
 Corriente: 5.2 A



CÓDIGO			DISTRIB.	MAYOREO	LISTA
117245	40	400	\$6.00	\$8.60	\$10.60

Portalámpara de porcelana tipo Mogul (E39)

CAJA

- ▶ Resiste sobrecargas de 2.6 A



NOM
CARACTERÍSTICAS
 Tensión: 250 V~
 Potencia: 660 W



CÓDIGO			DISTRIB.	MAYOREO	LISTA
117564	10	100	\$24.00	\$34.00	\$42.00

Portalámpara de porcelana con soporte tipo escuadra (E26)

CAJA

- ▶ Resiste sobrecargas de 2.6 A



NOM
CARACTERÍSTICAS
 Tensión: 250 V~
 Potencia: 660 W



CÓDIGO			DISTRIB.	MAYOREO	LISTA
117553	10	100	\$8.00	\$11.40	\$14.10

Portalámpara de porcelana para candil soporte niple (E26)

CAJA

- ▶ Resiste sobrecargas de 2.6 A



NOM
CARACTERÍSTICAS
 Tensión: 250 V~
 Potencia: 660 W



CÓDIGO			DISTRIB.	MAYOREO	LISTA
117554	10	100	\$8.00	\$11.40	\$14.10

Portalámpara base G13

BOLSA

- ▶ Para tubo LED y fluorescente
- ▶ Incluye 1 juego (2 piezas)



NOM
CARACTERÍSTICAS
 Tensión: 250 V~
 Potencia: 660 W



CÓDIGO	BASE			DISTRIB.	MAYOREO	LISTA
117583	G13	10	100	\$12.00	\$17.10	\$21.20

Portalámpara base G5

BOLSA

- ▶ Incluye tornillería para instalación
- ▶ Incluye 1 juego (2 piezas)



NOM
CARACTERÍSTICAS
 Tensión: 125 V~
 Potencia: 660 W



CÓDIGO	BASE			DISTRIB.	MAYOREO	LISTA
117582	G5	10	100	\$11.00	\$15.70	\$19.40

Portalámpara de baquelita slim line base FA8

BOLSA

- ▶ Incluye tornillería para instalación
- ▶ Resiste sobrecargas de más de 5 A



NOM
CARACTERÍSTICAS
 Tensión: 127 V~
 Potencia: 660 W



CÓDIGO			DISTRIB.	MAYOREO	LISTA
117581	10	100	\$17.00	\$24.30	\$30.00

Portalámpara de porcelana 4" (E26)

CAJA

- ▶ Resiste sobrecargas de más de 2.64 A

NOM
CARACTERÍSTICAS
 Tensión: 125 V-
 Potencia: 250 W

1
 año
 GARANTÍA

CÓDIGO			DISTRIB.	MAYOREO	LISTA
117563	6	60	\$15.00	\$21.40	\$26.00

Portalámpara de porcelana 3 1/2" (E26)

CAJA

- ▶ Resiste sobrecargas de más de 2.64 A

NOM
CARACTERÍSTICAS
 Tensión: 125 V-
 Potencia: 250 W

1
 año
 GARANTÍA

CÓDIGO			DISTRIB.	MAYOREO	LISTA
117561	6	60	\$13.00	\$18.60	\$22.90

Portalámpara de plástico 4" (E26)

BOLSA

- ▶ Resiste sobrecargas de más de 2.6 A

NOM
CARACTERÍSTICAS
 Tensión: 250 V-
 Potencia: 660 W

1
 año
 GARANTÍA

CÓDIGO			DISTRIB.	MAYOREO	LISTA
117562	10	100	\$11.00	\$15.70	\$19.40

Portalámpara para intemperie

GRANEL

- ▶ Fabricada en aluminio
- ▶ Con tornillo para puesta a tierra

NOM
CARACTERÍSTICAS
 Tensión: 250 V-
 Potencia: 660 W

1
 año
 GARANTÍA

CÓDIGO			DISTRIB.	MAYOREO	LISTA
117575	25	50	\$50.00	\$71.00	\$88.00

Portalámpara de porcelana 4" con cadena y ladrón (E26)

CAJA

- ▶ Resistencia mayor a 5 000 ciclos

NOM
CARACTERÍSTICAS
 Tensión: 250 V-
 Potencia: 660 W

1
 año
 GARANTÍA

CÓDIGO			DISTRIB.	MAYOREO	LISTA
117565	6	60	\$52.00	\$74.00	\$92.00

Portalámpara de porcelana base cuadrada (E26)

BOLSA

- ▶ Resiste sobrecargas de más de 5.2 A

NOM
CARACTERÍSTICAS
 Tensión: 125 V-
 Potencia: 660 W

1
 año
 GARANTÍA

CÓDIGO			DISTRIB.	MAYOREO	LISTA
117551	10	100	\$8.00	\$11.40	\$14.10

Cubierta portalámpara para intemperie

GRANEL

- ▶ Fabricada en aluminio
- ▶ Incluye tapas, tornillos y empaque



CÓDIGO	No. DE TOMAS			DISTRIB.	MAYOREO	LISTA
117571	1	10	100	\$30.00	\$43.00	\$53.00
117572	2	10	100	\$30.00	\$43.00	\$53.00
117573	3	10	100	\$30.00	\$43.00	\$53.00

Interruptor fotocelda

CAJA

- ▶ Sistema de retardo (delay) que ayuda a evitar activaciones innecesarias de la lámpara
- ▶ Ideal para uso con lámparas suburbanas

NOM
CARACTERÍSTICAS
 Tensión: 110 V- - 285 V-
 Potencia: 1 000 W

1
 año
 GARANTÍA

CÓDIGO			DISTRIB.	MAYOREO	LISTA
117251	5	50	\$70.00	\$100.00	\$123.00

Base para fotocelda

CAJA

- ▶ Incluye soporte y base de fijación
- ▶ **Fotocelda NO incluida**

NOM
CARACTERÍSTICAS
 Tensión: 127 V- - 220 V-
 Corriente: 10 A - 15 A

1
 año
 GARANTÍA

CÓDIGO		DISTRIB.	MAYOREO	LISTA
117252	100	\$40.00	\$57.00	\$71.00

Sensor de movimiento con alarma y timbre

PROX. ●

CAJA

- ▶ Fabricado en ABS
- ▶ Avisa de llegada de visitantes
- ▶ Instalación en pared

Utiliza 1 pila de 9 V NO incluida



1 año GARANTÍA



NOM

CARACTERÍSTICAS	
Ángulo de detección	100°
Alcance	5 m
Alarma - timbre	60 dB
Alimentación	9 V-

CÓDIGO		DISTRIB.	MAYOREO	LISTA
124921	12	\$140.00	\$200.00	\$245.00

Sensor de movimiento para pared

PROX. ●

CAJA

- ▶ Fabricado en ABS
- ▶ Instalación en pared
- ▶ Ajustable el tiempo, la sensibilidad de luz y la distancia



1 año GARANTÍA



NOM

CARACTERÍSTICAS	
Ángulo de detección	180°
Alcance	6 a 12 m
Voltaje	100 - 130 V-

CÓDIGO		DISTRIB.	MAYOREO	LISTA
124922	24	\$115.00	\$165.00	\$205.00

Sensor de movimiento para techo

PROX. ●

CAJA

- ▶ Fabricado en policarbonato
- ▶ Instalación en techo
- ▶ Ajustable el tiempo, la sensibilidad de luz y la distancia de detección



1 año GARANTÍA



NOM

CARACTERÍSTICAS	
Ángulo de detección	360°
Alcance	4 m
Voltaje	100 - 130 V-

CÓDIGO		DISTRIB.	MAYOREO	LISTA
124923	24	\$165.00	\$235.00	\$290.00

Detector de humo

PROX. ●

CAJA

- ▶ Botón con LED indicador
- ▶ Instalación en techo o pared
- ▶ Alarma con zumbador

Utiliza 1 pila de 9 V NO incluida



1 año GARANTÍA



NOM

CARACTERÍSTICAS	
Voltaje	Pila de 9 V- / 127 V-

CÓDIGO		DISTRIB.	MAYOREO	LISTA
124931	24	\$160.00	\$230.00	\$280.00

Temporizador analógico

PROX. ●

BLÍSTER

- ▶ Fabricado en policarbonato
- ▶ Ideal para simular presencia en casa u oficinas
- ▶ Programación con periodos de 15 minutos



1 año GARANTÍA



CARACTERÍSTICAS	
Corriente	15 A
Voltaje	127 V-

CÓDIGO			DISTRIB.	MAYOREO	LISTA
124991	12	48	\$90.00	\$129.00	\$160.00



Mantenemos la seguridad de tu hogar



AROMAS

QUE INSPIRAN



► Variedad de esencias florales, frutales o finas para auto, casa y oficina. Potencializa tu venta con los nuevos exhibidores.

Aromatizante Little Joe

PROX.

BLÍSTER

- ▶ Aromas y colores extraordinarios que te acompañarán y brindarán frescura a tu automóvil
- ▶ Contenido Neto: 12 g



CÓDIGO	AROMA			DISTRIB.	MAYOREO	LISTA
133141	New car	8	320	\$55.00	\$79.00	\$97.00
133142	Cherry	8	320	\$55.00	\$79.00	\$97.00
133143	Black Joe	8	320	\$55.00	\$79.00	\$97.00
133144	Strawberry	8	320	\$55.00	\$79.00	\$97.00
133145	Flower	8	320	\$55.00	\$79.00	\$97.00
133146	Piña colada	8	320	\$55.00	\$79.00	\$97.00
133147	Bubble gum	8	320	\$55.00	\$79.00	\$97.00

Aromatizante Little Dog

PROX.

BLÍSTER

- ▶ Aromas y colores extraordinarios que te acompañarán y brindarán frescura a tu automóvil
- ▶ Contenido Neto: 12 g



CÓDIGO	AROMA			DISTRIB.	MAYOREO	LISTA
133161	Passion	8	320	\$55.00	\$79.00	\$97.00
133162	Fresh mint	8	320	\$55.00	\$79.00	\$97.00
133163	Fruit	8	320	\$55.00	\$79.00	\$97.00

Aromatizante Paradise Air Super organic

PROX.

BOLSA

- ▶ Libres de químicos sintéticos, haciendo de cada viaje una experiencia placentera y ecológica
- ▶ Contenido Neto: 46 g



CÓDIGO	AROMA			DISTRIB.	MAYOREO	LISTA
133101	Cherry	10	120	\$60.00	\$86.00	\$106.00
133102	Black	10	120	\$60.00	\$86.00	\$106.00
133103	New car	10	120	\$60.00	\$86.00	\$106.00
133104	Pure sunshine	10	120	\$60.00	\$86.00	\$106.00
133105	Tropic twist	10	120	\$60.00	\$86.00	\$106.00
133106	Cran burst	10	120	\$60.00	\$86.00	\$106.00
133107	Blue lava	10	120	\$60.00	\$86.00	\$106.00

Aromatizante Paradise Air Slim gel 90

PROX.

GRANEL

- ▶ Experimenta una sinfonía de aromas que transforman el interior de tu vehículo en un paraíso de aromas cautivadores y sofisticación
- ▶ Contenido Neto: 15 g



CÓDIGO	AROMA			DISTRIB.	MAYOREO	LISTA
133121	Cherry	12	216	\$55.00	\$79.00	\$97.00
133122	New car	12	216	\$55.00	\$79.00	\$97.00
133123	Tropic twist	12	216	\$55.00	\$79.00	\$97.00

Aromatizante Paradise Air Anywhere

PROX.

BOTELLA

- ▶ Ambientador en spray, es único y mantendrá su hogar con un olor agradable durante mucho tiempo
- ▶ Contenido Neto: 207 ml



CÓDIGO	AROMA			DISTRIB.	MAYOREO	LISTA
133131	Cherry	10	40	\$89.00	\$127.00	\$155.00
133132	Black	10	40	\$89.00	\$127.00	\$155.00
133133	Lemon lavender	10	40	\$89.00	\$127.00	\$155.00

Aromatizante Paradise Air Organic can

PROX.

CAJA

- ▶ Ambientador sólido
- ▶ Duración: 60 días
- ▶ Contiene 12 latas surtidas
- ▶ Contenido Neto por lata: 42 g



AROMA	PIEZAS
Cherry	4
New car	2
Black	2
Bubble gum	1
Tropic twist	1
Cran burst	1
Pineapple	1

CÓDIGO			DISTRIB.	MAYOREO	LISTA
133907	12	144	\$720.00	\$1,030.00	\$1,270.00

Aromatizante Paradise Air Spray Platinum

PROX.

CAJA

- ▶ Ambientador en spray
- ▶ Contiene 25 botellas surtidas
- ▶ Contenido Neto por botella: 30 ml



AROMA	PIEZAS
Black	7
New car	6
Cherry	5
Tropic twist	4
Blue lava	3

CÓDIGO			DISTRIB.	MAYOREO	LISTA
133908	25	150	\$1,650.00	\$2,355.00	\$2,910.00

Aromatizante Mon Areon



PROX.

133904
Exhibidor de cartón con 36 piezas de diferente aroma

DISTRIB.	MAYOREO	LISTA
\$576.00	\$825.00	\$1,015.00

CÓDIGO	AROMA		DISTRIB.	MAYOREO	LISTA	CÓDIGO	AROMA		DISTRIB.	MAYOREO	LISTA
124310	Patchouli lavender vanilla	24	\$16.00	\$22.90	\$28.00	124328	Vanilla black	24	\$16.00	\$22.90	\$28.00
124312	Beverly Hills	24	\$16.00	\$22.90	\$28.00	124330	Lily of the valley	24	\$16.00	\$22.90	\$28.00
124313	Miami beach	24	\$16.00	\$22.90	\$28.00	124431	Coffe	24	\$16.00	\$22.90	\$28.00
124314	Coconut	24	\$16.00	\$22.90	\$28.00	124432	Watermelon	24	\$16.00	\$22.90	\$28.00
124315	Bubble gum	24	\$16.00	\$22.90	\$28.00	124433	American dream	24	\$16.00	\$22.90	\$28.00
124317	Black crystal	24	\$16.00	\$22.90	\$28.00	124435	Leather interior	24	\$16.00	\$22.90	\$28.00
124318	Apple and cinnamon	24	\$16.00	\$22.90	\$28.00	124437	Mojito	24	\$16.00	\$22.90	\$28.00
124322	New car	24	\$16.00	\$22.90	\$28.00	124438	Lavender	24	\$16.00	\$22.90	\$28.00
124326	Strawberry	24	\$16.00	\$22.90	\$28.00						
124327	Cherry	24	\$16.00	\$22.90	\$28.00						

Aromatizante Mon Areon 24 piezas

CAJA

► Nuevas colecciones de 24 piezas



CÓDIGO	AROMAS INCLUIDOS		DISTRIB.	MAYOREO	LISTA	CÓDIGO	AROMAS INCLUIDOS		DISTRIB.	MAYOREO	LISTA	CÓDIGO	AROMAS INCLUIDOS		DISTRIB.	MAYOREO	LISTA
128446	Black crystal - 8 piezas New car - 8 piezas Cherry - 8 piezas	24	\$345.00	\$495.00	\$610.00	128447	Coconut - 4 piezas Black crystal - 4 piezas Apple & cinnamon - 4 piezas New car - 4 piezas Strawberry - 4 piezas Leather interior - 4 piezas	24	\$345.00	\$495.00	\$610.00	128448	Vanilla black - 2 piezas Beverly Hills - 2 piezas Coconut - 2 piezas Black crystal - 3 piezas Apple & cinnamon - 3 piezas New car - 3 piezas Strawberry - 3 piezas Cherry - 3 piezas Leather interior - 3 piezas	24	\$345.00	\$495.00	\$610.00

Aromatizante Fresco

BLÍSTER

► Compacto panel de madera que conserva por más tiempo el aroma
► Empaque con tester
► Contenido Neto: 4 ml



CÓDIGO	AROMA			DISTRIB.	MAYOREO	LISTA
124331	Vanilla	6	72	\$65.00	\$93.00	\$115.00
124332	Bubble gum	6	72	\$65.00	\$93.00	\$115.00
124333	Beverly Hills	6	72	\$65.00	\$93.00	\$115.00
124334	Black crystal	6	72	\$65.00	\$93.00	\$115.00
124335	Apple and cinnamon	6	72	\$65.00	\$93.00	\$115.00
124336	New car	6	72	\$65.00	\$93.00	\$115.00
124337	Cherry	N/A	6	\$65.00	\$93.00	\$115.00

PROX.

133902
Exhibidor de cartón con 24 piezas de diferente aroma

DISTRIB.	MAYOREO	LISTA
\$1,560.00	2,230.00	2,750.00

Aromatizante Smile

BLÍSTER

- ▶ Simpáticos y tiernos muñequitos con una agradable aroma
- ▶ Contenido: 1 pieza



PROX.

133905
Exhibidor de cartón con 36 piezas de diferente aroma

DISTRIB. MAYOREO LISTA
\$828.00 \$1,185.00 \$1,460.00



CÓDIGO	AROMA	📦	📦	DISTRIB.	MAYOREO	LISTA
124411	Apple & cinnamon	12	144	\$46.00	\$66.00	\$81.00
124412	Black crystal	12	144	\$46.00	\$66.00	\$81.00
124413	Strawberry	12	144	\$46.00	\$66.00	\$81.00
124414	Vanilla	12	144	\$46.00	\$66.00	\$81.00
124415	Bubble gum	12	144	\$46.00	\$66.00	\$81.00

Aromatizante Pearls

TARJETA COLGANTE

- ▶ Fino costalito con perlas que liberan gradualmente su aroma
- ▶ Empaque con tester
- ▶ Contenido: 1 costalito



PROX.

133906
Exhibidor de cartón con 18 piezas de diferente aroma

DISTRIB. MAYOREO LISTA
\$756.00 \$1,080.00 \$1,335.00



CÓDIGO	AROMA	📦	📦	DISTRIB.	MAYOREO	LISTA
124351	Black crystal	6	72	\$42.00	\$60.00	\$74.00
124352	Bubble gum	6	72	\$42.00	\$60.00	\$74.00
124353	Spring bouquet	6	72	\$42.00	\$60.00	\$74.00
124354	Citrus squash	6	72	\$42.00	\$60.00	\$74.00
124357	Apple & cinnamon	6	72	\$42.00	\$60.00	\$74.00
124358	New car	6	72	\$42.00	\$60.00	\$74.00
124359	Coconut	6	72	\$42.00	\$60.00	\$74.00

Aromatizante Dry Smile

BOLSA

- ▶ Divertidos emojis que darán armonía a tu automóvil
- ▶ Contenido: 1 pieza



PROX.

133901
Exhibidor de cartón con 36 piezas de diferente aroma

DISTRIB. MAYOREO LISTA
\$612.00 \$875.00 \$1,080.00



CÓDIGO	AROMA	📦	📦	DISTRIB.	MAYOREO	LISTA
124301	Vanilla	24	360	\$17.00	\$24.30	\$30.00
124302	Bubble gum	24	360	\$17.00	\$24.30	\$30.00
124303	No smoking	24	360	\$17.00	\$24.30	\$30.00
124304	Tutti frutti	24	360	\$17.00	\$24.30	\$30.00
124305	Fresh air	24	360	\$17.00	\$24.30	\$30.00
124306	Black crystal	24	360	\$17.00	\$24.30	\$30.00
124307	Coconut	24	360	\$17.00	\$24.30	\$30.00
124308	New car	24	360	\$17.00	\$24.30	\$30.00
124309	Apple & cinnamon	24	360	\$17.00	\$24.30	\$30.00
133001	Vanilla black	24	360	\$17.00	\$24.30	\$30.00
133002	Summer dream	24	360	\$17.00	\$24.30	\$30.00
133003	Beverly Hills	24	360	\$17.00	\$24.30	\$30.00

Aromatizante Areon X

BOLSA

- ▶ Aromatiza tu auto por largo tiempo
- ▶ Increíbles y exclusivas fragancias que cautivarán tus sentidos
- ▶ Contenido: 1 pieza



CÓDIGO	AROMA	📦	DISTRIB.	MAYOREO	LISTA
124481	Black crystal	24	\$16.00	\$22.90	\$28.00
124482	Coconut	24	\$16.00	\$22.90	\$28.00
124483	New car	24	\$16.00	\$22.90	\$28.00
124484	Strawberry	24	\$16.00	\$22.90	\$28.00

Aromatizante Fresh Wave

BLÍSTER

- ▶ Aromas y colores extraordinarios que te acompañarán y brindarán frescura a tu automóvil
- ▶ Contenido: 1 pieza



133903
Exhibidor de cartón
Capacidad: 36 piezas
de diferente aroma

DISTRIB. MAYOREO LISTA
\$864.00 \$1,235.00 \$1,525.00



124381 124382 124385 124386 124387 124388

CÓDIGO	AROMA	📦	DISTRIB.	MAYOREO	LISTA
124381	Black crystal	12	\$48.00	\$69.00	\$85.00
124382	Bubble gum	12	\$48.00	\$69.00	\$85.00
124385	Strawberry	12	\$48.00	\$69.00	\$85.00
124386	Ocean	12	\$48.00	\$69.00	\$85.00
124387	Cherry	12	\$48.00	\$69.00	\$85.00
124388	New car	12	\$48.00	\$69.00	\$85.00

Aromatizante Fresh Wave paper

BOLSA

- ▶ ¡Nuestros tenis favoritos evolucionaron! Nueva presentación, nuevos aromas
- ▶ Contenido: 1 pieza



PROX. ●



124451 124452 124453 124454 124455

CÓDIGO	AROMA	📦	DISTRIB.	MAYOREO	LISTA
124451	Black crystal	24	\$16.00	\$22.90	\$28.00
124452	New car	24	\$16.00	\$22.90	\$28.00
124453	Summer dream	24	\$16.00	\$22.90	\$28.00
124454	Cherry	24	\$16.00	\$22.90	\$28.00
124455	Bubble gum	24	\$16.00	\$22.90	\$28.00

Aromatizante Vent7

NUEVO

BLÍSTER

- ▶ Un accesorio con gran estilo para tu automóvil
- ▶ Colócalo en la rejilla del aire acondicionado
- ▶ Empaque con tester
- ▶ Contenido Neto: 4.5 ml



124401 124404

CÓDIGO	AROMA	📦	📦	DISTRIB.	MAYOREO	LISTA
124401	Black crystal	6	90	\$40.00	\$57.00	\$71.00
124404	My ocean	6	90	\$40.00	\$57.00	\$71.00

Aromatizante Liquid 5 ml

PROX. ●

BOLSA

- ▶ Aromatiza tu auto por largo tiempo
- ▶ Increíbles y exclusivas fragancias que cautivarán tus sentidos
- ▶ Contenido Neto: 5 ml



133801 133802 133803 133804 133805 133806 133807 133808 133809

CÓDIGO	AROMA	📦	📦	DISTRIB.	MAYOREO	LISTA
133801	Black crystal	12	216	\$30.00	\$43.00	\$53.00
133802	Bubble gum	12	216	\$30.00	\$43.00	\$53.00
133803	Apple & cinnamon	12	216	\$30.00	\$43.00	\$53.00
133804	New car	12	216	\$30.00	\$43.00	\$53.00
133805	Mountain fresh	12	216	\$30.00	\$43.00	\$53.00
133806	Tutti frutti	12	216	\$30.00	\$43.00	\$53.00
133807	Strawberry	12	216	\$30.00	\$43.00	\$53.00
133808	Coconut	12	216	\$30.00	\$43.00	\$53.00
133809	Summer dream	12	216	\$30.00	\$43.00	\$53.00

Aromatizante Perfume 35 ml

BLÍSTER

- ▶ Aromatizante de 35 ml de fragancia
- ▶ Rocíalo sobre el colgante incluido o sobre el tapete de tu auto y obtén una extensión de tu fragancia favorita
- ▶ Empaque con tester



124461 124462 124463 124464 124465 124466 124467 124468 124469



CÓDIGO	AROMA		DISTRIB.	MAYOREO	LISTA
124461	Vanilla	12	\$70.00	\$100.00	\$123.00
124462	Bubble gum	12	\$70.00	\$100.00	\$123.00
124463	Apple & cinnamon	12	\$70.00	\$100.00	\$123.00
124464	Black crystal	12	\$70.00	\$100.00	\$123.00
124465	Strawberry	12	\$70.00	\$100.00	\$123.00
124466	New car	12	\$70.00	\$100.00	\$123.00
124467	Spring bouquet	12	\$70.00	\$100.00	\$123.00
124468	Coconut	12	\$70.00	\$100.00	\$123.00
124469	Californian cherry	12	\$70.00	\$100.00	\$123.00

Exhibición

Exhibidor de piso con 42 ganchos

- ▶ Exhibidor metálico
- ▶ 42 ganchos para exhibición

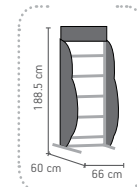

El precio no incluye los productos exhibidos



CÓDIGO	DISTRIB.	MAYOREO	LISTA
220333	\$2,270.00	\$3,245.00	\$4,005.00

Aromatizante Ken

BLÍSTER

- ▶ Perdurable e intenso aroma que podrás utilizar en ambientes abiertos o cerrados
- ▶ Empaque con tester
- ▶ Contenido Neto: 30 g



124361 124362 124363 124364 124365 124366 124367 124368



CÓDIGO	AROMA			DISTRIB.	MAYOREO	LISTA
124361	Strawberry	6	72	\$75.00	\$107.00	\$132.00
124362	Black crystal	6	72	\$75.00	\$107.00	\$132.00
124363	Apple and cinnamon	6	72	\$75.00	\$107.00	\$132.00
124364	New car	6	72	\$75.00	\$107.00	\$132.00
124365	Vanilla	6	72	\$75.00	\$107.00	\$132.00
124366	Coconut	6	72	\$75.00	\$107.00	\$132.00
124367	Cherry	6	72	\$75.00	\$107.00	\$132.00
124368	Bubble gum	6	72	\$75.00	\$107.00	\$132.00

Aromatizante Gel

CAJILLA

- ▶ Agradable aroma de fácil uso
- ▶ Colócalo en tu auto bajo el asiento, el maletero o en el portavasos
- ▶ Empaque con tester
- ▶ Contenido Neto: 80 g



124375 124376 124377



CÓDIGO	AROMA		DISTRIB.	MAYOREO	LISTA
124375	Wish	12	\$105.00	\$150.00	\$185.00
124376	Black crystal	12	\$105.00	\$150.00	\$185.00
124377	Apple & cinnamon	12	\$105.00	\$150.00	\$185.00

Varillas Garden Aromas FLORAL-FRUTAL

CAJA

- ▶ Varitas difusoras que esparcen el aroma gradualmente
- ▶ Aromas de 50 ml de fragancia
- ▶ Te hará disfrutar de una agradable fragancia que convertirá tu hogar y oficina en un lugar más acogedor



127531 127532 127533 127534 127535 127536

CÓDIGO	AROMA		DISTRIB.	MAYOREO	LISTA
127531	French garden	24	\$100.00	\$143.00	\$175.00
127532	Spa	24	\$100.00	\$143.00	\$175.00
127533	Violet	24	\$100.00	\$143.00	\$175.00
127534	Jasmine	24	\$100.00	\$143.00	\$175.00
127535	Mango	24	\$100.00	\$143.00	\$175.00
127536	Rose valley	24	\$100.00	\$143.00	\$175.00

Varillas Home

CAJA

- ▶ Varitas difusoras que esparcen el aroma gradualmente
- ▶ Conoce nuestros aromas que detonan **alegría y calidez**
- ▶ Aromas de 150 ml de fragancia
- ▶ Cada aroma está diseñado para poder destacar los espacios en tu hogar y convertirlos en lugares armónicos y cálidos



127541 127542 127543 127544 127545 127546

CÓDIGO	AROMA		DISTRIB.	MAYOREO	LISTA
127541	Sunny home	12	\$250.00	\$355.00	\$440.00
127542	Lilac	12	\$250.00	\$355.00	\$440.00
127543	Black crystal	12	\$250.00	\$355.00	\$440.00
127544	Vanilla	12	\$250.00	\$355.00	\$440.00
127545	Spring bouquet	12	\$250.00	\$355.00	\$440.00
127546	Silver linen	12	\$250.00	\$355.00	\$440.00

Varillas exclusive

CAJA

- ▶ Varitas difusoras que esparcen el aroma gradualmente
- ▶ Aromas que brindan **refinados toques de elegancia**
- ▶ Aromas de 150 ml de fragancia
- ▶ Exclusivas fragancias creadas especialmente para gustos sofisticados que buscan armonizar el ambiente con sutiles notas de olor
- ▶ Exquisito complemento para perfumar tu hogar



127551 127552 127553

CÓDIGO	AROMA		DISTRIB.	MAYOREO	LISTA
127551	Aurum	12	\$430.00	\$615.00	\$760.00
127552	Precious leather	12	\$430.00	\$615.00	\$760.00
127553	Ecu	12	\$430.00	\$615.00	\$760.00

Aromatizante Clima fresh

TARJETA COLGANTE

- ▶ Armoniza tus espacios desde el aire acondicionado
- ▶ De fácil colocación
- ▶ Contenido: 1 pieza



124471

124472

124473

CÓDIGO	AROMA			DISTRIB.	MAYOREO	LISTA
124471	Lovely home	12	288	\$45.00	\$64.00	\$79.00
124472	Secret garden	12	288	\$45.00	\$64.00	\$79.00
124473	Blue ocean	12	288	\$45.00	\$64.00	\$79.00

Exhibición

Exhibidor de metal Home

- ▶ Exhibidor metálico
- ▶ 5 Repisas para exhibición

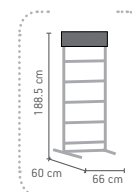

El precio no incluye los productos exhibidos

CÓDIGO	DISTRIB.	MAYOREO	LISTA
220334	\$3,500.00	\$5,000.00	\$6,175.00

Incienso artesanal Ispalla

CAJA

- ▶ Inciensos 100% naturales
- ▶ Aromas sin fragancias ni perfumes artificiales
- ▶ De origen sostenible y orgánico
- ▶ Hecho a mano
- ▶ Ingredientes no tóxicos
- ▶ No contienen carbón
- ▶ Caja con 10 varitas
- ▶ Inciensos creados para los amantes de la espiritualidad, relajación y tranquilidad



PALO SANTO: Amaderado dulce, ahumado	Limpia malas energías. Relajante y purificador. Alivia estrés y ansiedad.
MIRRA Y PALO SANTO: Amaderado dulce	Purificación intensa de energía y espíritu. Eleva la frecuencia de vibraciones personales. Fortalece la energía positiva y el amor.
COPAL Y PALO SANTO: Musgoso ahumado	Crea un puente entre lo celestial y terrenal. Limpia las conexiones espirituales. Limpia energía de objetos y espacios.
RUDA Y PALO SANTO: Herbal ahumado	Atrae buena fortuna especialmente para el trabajo, nuevos proyectos y amor. Repele malas energías. Aroma intenso.
ROMERO Y PALO SANTO: Apinado amaderado	Crea un campo de protección, amor y purificación. Despierta el alma y mente, estimulando la creatividad y memoria.
EUCALIPTO Y PALO SANTO: Mentolado amaderado	Fortalece el espíritu y motiva la mente. Estimula la creatividad. Protege, relaja y limpia energías negativas.
LAVANDA Y PALO SANTO: Floral amaderado	Tranquiliza los pensamientos y nivela las emociones. Desintoxica la energía y estimula la relajación.
ROSAS Y PALO SANTO: Floral amaderado	Relajación profunda del cuerpo, renovación de vibras románticas. Crea conexiones emocionales.
JAZMÍN Y PALO SANTO: Floral amaderado	Activa las vibraciones altas, estimula un ambiente alegre. Reduce la pesadez y motiva la creatividad.



CÓDIGO	AROMA		DISTRIB.	MAYOREO	LISTA
127561	Palo santo	24	\$28.00	\$40.00	\$49.00
127562	Palo santo y mirra	24	\$28.00	\$40.00	\$49.00
127563	Palo santo y copal	24	\$28.00	\$40.00	\$49.00
127564	Palo santo y ruda	24	\$28.00	\$40.00	\$49.00
127565	Palo santo y romero	24	\$28.00	\$40.00	\$49.00
127566	Palo santo y eucalipto	24	\$28.00	\$40.00	\$49.00
127567	Palo santo y lavanda	24	\$28.00	\$40.00	\$49.00
127568	Palo santo y rosas	24	\$28.00	\$40.00	\$49.00
127569	Palo santo y jazmín	24	\$28.00	\$40.00	\$49.00

Aromatizante Blue eye

BOLSA

- ▶ El ojo turco es un amuleto que te protege de envidias y negatividad, atrayendo buena energía
- ▶ Contenido: 1 pieza



CÓDIGO	AROMA		DISTRIB.	MAYOREO	LISTA
124494	Black crystal	24	\$16.00	\$22.90	\$28.00
124495	Bubble gum	24	\$16.00	\$22.90	\$28.00
124496	Tutti frutti	24	\$16.00	\$22.90	\$28.00
124497	Strawberry	24	\$16.00	\$22.90	\$28.00

Aromatizante Hamsa

BOLSA

- ▶ Una nueva forma de atraer la suerte y el amor a donde quiera que vayas. Hamsa es un símbolo de paciencia, atrae la buena suerte y aleja las malas energías.
- ▶ Contenido: 1 pieza



CÓDIGO	AROMA		DISTRIB.	MAYOREO	LISTA
124447	Black crystal	24	\$16.00	\$22.90	\$28.00
124448	Vanilla black	24	\$16.00	\$22.90	\$28.00
124449	Ocean	24	\$16.00	\$22.90	\$28.00

Scented candle

CAJILLA

- ▶ Crea un ambiente positivo en tu hogar con las velas aromáticas
- ▶ Velas de 120 gramos



CÓDIGO	AROMA		DISTRIB.	MAYOREO	LISTA
127521	Apple & cinnamon	6	\$85.00	\$121.00	\$150.00
127522	Vanilla black	6	\$85.00	\$121.00	\$150.00
127523	Black crystal	6	\$85.00	\$121.00	\$150.00

Arôgli®

Espacios que brillan

Plumero electrostático

PROX. 

FAJILLA

- ▶ Gracias a su carga electrostática, las partículas de polvo se adhieren al plumero, evitando que se dispersen en el aire y vuelvan a caer sobre la superficie
- ▶ Ideal para limpiar todo tipo de superficie
- ▶ Su diseño versátil te permite llegar a lugares de difícil acceso, como esquinas y rendijas estrechas



CÓDIGO		DISTRIB.	MAYOREO	LISTA
133999	36	\$37.00	\$53.00	\$65.00

Ambientador / Eliminador de olores

AEROSOL DE 400 ml

- ▶ Fórmula especialmente fabricada para ambientar con exquisita y duradera fragancia



Encapsula los malos olores desde raíz

127501 127502 127503 127504 127505 127506

CÓDIGO	AROMA			DISTRIB.	MAYOREO	LISTA
127501	Manzana canela	12	24	\$45.00	\$64.00	\$79.00
127502	Lavanda	12	24	\$45.00	\$64.00	\$79.00
127503	Frutos rojos	12	24	\$45.00	\$64.00	\$79.00
127504	Aires de la montaña	12	24	\$45.00	\$64.00	\$79.00
127505	Brisas del mar	12	24	\$45.00	\$64.00	\$79.00
127506	Flor de jazmín y algodón	12	24	\$45.00	\$64.00	\$79.00

Lustrador de muebles

AEROSOL DE 400 ml

- ▶ Elimina el polvo, huellas y manchas sin dejar rastro
- ▶ Mejora la apariencia de tus muebles dando brillo
- ▶ Se adentra en la textura de la madera protegiéndola de efectos externos



CÓDIGO	AROMA			DISTRIB.	MAYOREO	LISTA
127581	Limón	12	24	\$50.00	\$71.00	\$88.00
127582	Lavanda	12	24	\$50.00	\$71.00	\$88.00





COLECCIÓN SDS

► Abrazaderas . alambre . antenas . armellas . arcos . bandolas . botas . bombas . brocas . cinceles

Antena giratoria 360° **HD^{TV}**

CAJA

- ▶ Mejor recepción de canales en alta definición - HD
- ▶ Mejora la calidad de imagen de tu TV
- ▶ Control remoto 8 m de alcance
- ▶ Receptor con botón para operar manualmente
- ▶ Fácil de usar
- ▶ Alcance de 20 km

INCLUYE:
12 m cable coaxial (antena - receptor)
1 m cable coaxial (receptor - televisión)

NOM



1
año
GARANTÍA

AKSI

CÓDIGO		DISTRIB.	MAYOREO	LISTA
116101	6	\$315.00	\$450.00	\$555.00

Antena giratoria 360° máxima recepción **HD^{TV}**

CAJA

- ▶ Mejor calidad de canales en alta definición - HD
- ▶ Mejora la calidad de imagen de tu TV
- ▶ Control remoto 8 m de alcance
- ▶ Receptor con botón para operar manualmente
- ▶ Alcance de 20 km

INCLUYE:
12 m cable coaxial (antena - receptor)
1 m cable coaxial (receptor - televisión)

NOM



1
año
GARANTÍA

AKSI

CÓDIGO		DISTRIB.	MAYOREO	LISTA
116102	6	\$340.00	\$485.00	\$600.00

Antena para exteriores **HD^{TV}**

CAJA

- ▶ Mejor recepción de canales en alta definición - HD
- ▶ Frecuencia: UHF 470 - 862 MHz
- ▶ Impedancia: 75 Ω
- ▶ Ganancia: 12 dB
- ▶ Fácil de instalar

INCLUYE:
10 m cable coaxial (antena - receptor)



1
año
GARANTÍA

AKSI

CÓDIGO		DISTRIB.	MAYOREO	LISTA
116114	20	\$215.00	\$305.00	\$380.00

Antena para exteriores **HD^{TV}**

CAJA

- ▶ Mejor recepción de canales en alta definición - HD
- ▶ Mejora la calidad de imagen de tu TV
- ▶ Receptor UHF
- ▶ Fácil de instalar

INCLUYE:
10 m cable coaxial (antena - receptor)



1
año
GARANTÍA

AKSI

CÓDIGO		DISTRIB.	MAYOREO	LISTA
116112	20	\$175.00	\$250.00	\$310.00

Antena para exteriores **HD^{TV}**

CAJA

- ▶ Mejor recepción de canales en alta definición - HD
- ▶ Mejora la calidad de imagen de tu TV
- ▶ Receptor UHF
- ▶ Fácil de instalar

INCLUYE:
10 m cable coaxial (antena - receptor)



1
año
GARANTÍA

AKSI

CÓDIGO		DISTRIB.	MAYOREO	LISTA
116113	20	\$140.00	\$200.00	\$245.00

Antena para interiores **HD^{TV}**

CAJA

- ▶ Recepción omnidireccional 360°
- ▶ Base magnética
- ▶ Frecuencia: UHF 470 - 862 MHz
- ▶ Impedancia: 75 Ω
- ▶ Ganancia: 22 dB

INCLUYE:
5 m cable coaxial
1 Adaptador dúplex coaxial - USB
1 Amplificador de señal USB



NOM

1
año
GARANTÍA

AKSI

CÓDIGO		DISTRIB.	MAYOREO	LISTA
116123	40	\$120.00	\$170.00	\$210.00

Antena para interior ultra delgada **HD^{TV}**

CAJA

- ▶ Para señales digitales
- ▶ Alta calidad y durabilidad

INCLUYE:
2 m cable coaxial (antena - receptor)



1
año
GARANTÍA

AKSI

CÓDIGO		DISTRIB.	MAYOREO	LISTA
116125	50	\$105.00	\$150.00	\$185.00

Removedor de polvo 300 ml aire comprimido

PROX.

AEROSOL

- ▶ Incluye extensión para llegar a lugares difíciles
- ▶ Utiliza gas seco ultra filtrado
- ▶ Seguro para utilizar en equipos energizados



Usos recomendados



Audio



Gamer



Taller



Hogar



Computación

CÓDIGO		DISTRIB.	MAYOREO	LISTA
119577	12	\$50.00	\$71.00	\$88.00

Abrazadera de acero inoxidable

BOLSA

- ▶ Disponibles en anchos de: 5/16" - Cód. 102201 y 102202 1/2" - Cód. 102203 a 102225
- ▶ Tornillo de acero templado con cabeza hexagonal y ranura para desarmador tipo plano, con acabado galvanizado
- ▶ Banda de acero inoxidable
- ▶ Templadas con dureza de 40-45 HRC
- ▶ Para usos generales



PRECIO POR PIEZA

CÓDIGO	MODELO	DIÁMETRO	PIEZAS X BOLSA	DISTRIB.	MAX.	LISTA
102201	004	10 mm -16 mm	20	100 pzas.	400 pzas.	\$2.60 \$3.70 \$4.60
102202	006	13 mm -19 mm	20	100 pzas.	400 pzas.	\$2.60 \$3.70 \$4.60
102203	04	10 mm -16 mm	10	100 pzas.	400 pzas.	\$4.80 \$6.90 \$8.50
102204	06	13 mm -19 mm	10	100 pzas.	400 pzas.	\$4.80 \$6.90 \$8.50
102205	08	16 mm -23 mm	10	50 pzas.	200 pzas.	\$5.40 \$7.70 \$9.50
102206	10	19 mm -27 mm	10	50 pzas.	200 pzas.	\$5.40 \$7.70 \$9.50
102207	12	16 mm -32 mm	10	50 pzas.	200 pzas.	\$5.40 \$7.70 \$9.50
102208	16	19 mm -38 mm	10	50 pzas.	200 pzas.	\$6.00 \$8.60 \$10.60
102209	20	19 mm -44 mm	10	50 pzas.	200 pzas.	\$6.00 \$8.60 \$10.60
102210	24	32 mm -51 mm	10	50 pzas.	200 pzas.	\$7.00 \$10.00 \$12.30
102211	28	38 mm -57 mm	10	50 pzas.	200 pzas.	\$7.00 \$10.00 \$12.30
102212	32	40 mm -64 mm	5	20 pzas.	80 pzas.	\$7.60 \$10.90 \$13.40
102213	36	46 mm -70 mm	5	20 pzas.	80 pzas.	\$8.00 \$11.40 \$14.10
102214	40	57 mm -76 mm	5	20 pzas.	80 pzas.	\$9.00 \$12.90 \$15.90
102215	44	67 mm -83 mm	5	20 pzas.	80 pzas.	\$9.60 \$13.70 \$16.90
102216	48	65 mm -89 mm	5	20 pzas.	80 pzas.	\$9.60 \$13.70 \$16.90
102217	52	72 mm -95 mm	5	20 pzas.	80 pzas.	\$10.00 \$14.30 \$17.60
102218	56	78 mm -101 mm	5	20 pzas.	80 pzas.	\$10.00 \$14.30 \$17.60
102219	60	84 mm -108 mm	5	20 pzas.	80 pzas.	\$11.00 \$15.70 \$19.40
102220	64	91 mm -114 mm	5	20 pzas.	80 pzas.	\$12.00 \$17.10 \$21.20
102221	72	105 mm -127 mm	5	20 pzas.	80 pzas.	\$12.00 \$17.10 \$21.20
102222	80	118 mm -140 mm	5	10 pzas.	40 pzas.	\$13.00 \$18.60 \$22.90
102223	88	130 mm -152 mm	5	10 pzas.	40 pzas.	\$14.00 \$20.00 \$24.70
102224	96	141 mm -165 mm	5	10 pzas.	40 pzas.	\$15.00 \$21.40 \$26.00
102225	104	156 mm -178 mm	5	10 pzas.	40 pzas.	\$15.00 \$21.40 \$26.00

Mínimo a surtir 1 bolsa con 20 ó 10 ó 5 piezas

Abrazadera para tubo tipo uña

BOLSA

- ▶ Ideal para el soporte de tubería conduit y cobre
- ▶ Con doble costilla de refuerzo
- ▶ Cuerpo fabricado en acero

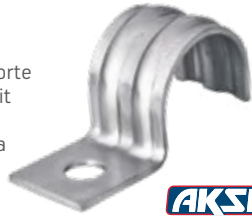

PRECIO POR PIEZA

CÓDIGO	DIÁMETRO	PZAS X BOLSA	DISTRIB.	MAYOREO	LISTA
102314	3/8"	20	800 pzas.	\$1.00 \$1.40	\$1.80
102307	1/2"	20	400 pzas.	\$1.00 \$1.40	\$1.80
102308	3/4"	20	400 pzas.	\$1.40 \$2.00	\$2.50
102309	1"	20	400 pzas.	\$1.90 \$2.70	\$3.40
102310	1 1/4"	20	200 pzas.	\$3.20 \$4.60	\$5.60
102311	1 1/2"	20	200 pzas.	\$3.80 \$5.40	\$6.70
102312	2"	20	200 pzas.	\$4.60 \$6.60	\$8.10

Mínimo a surtir 1 bolsa con 20 piezas

Abrazadera para tubo tipo omega

BOLSA

- ▶ Ideal para el soporte de tubería conduit y cobre
- ▶ Con costilla de refuerzo
- ▶ Cuerpo fabricado en acero



PRECIO POR PIEZA

CÓDIGO	DIÁMETRO	PZAS X BOLSA	DISTRIB.	MAX.	LISTA
102313	3/8"	20	800 pzas.	\$1.10 \$1.60	\$1.90
102301	1/2"	20	400 pzas.	\$1.10 \$1.60	\$1.90
102302	3/4"	20	400 pzas.	\$1.50 \$2.10	\$2.60
102303	1"	20	400 pzas.	\$2.00 \$2.90	\$3.50
102304	1 1/4"	20	200 pzas.	\$3.60 \$5.10	\$6.40
102305	1 1/2"	20	200 pzas.	\$4.20 \$6.00	\$7.40
102306	2"	20	200 pzas.	\$5.00 \$7.10	\$8.80

Mínimo a surtir 1 bolsa con 20 piezas

Mufa con rosca y mufa con abrazadera para tubo

GRANEL

- ▶ Fabricada en aluminio
- ▶ Impide que la lluvia entre a la instalación eléctrica



117242

117241



CÓDIGO	TUBO	TIPO	DISTRIB.	MAYOREO	LISTA
117241	1 1/4"	Rosca	10 50	\$42.00 \$60.00	\$74.00
117242	1 1/4"	Abrazadera	10 50	\$42.00 \$60.00	\$74.00

Nudo (perro) de hierro nodular

BOLSA

- ▶ Cuerpo de hierro nodular
- ▶ Gancho de acero SAE1015
- ▶ Acabado galvanizado



PRECIO POR PIEZA

CÓDIGO	DIÁMETRO	PZAS X BOLSA	DISTRIB.	MAYOREO	LISTA
303305	1/8"	6 600	\$1.80 \$2.60	\$3.20	
303306	3/16"	6 600	\$3.00 \$4.30	\$5.30	
303307	1/4"	6 360	\$4.50 \$6.40	\$7.90	
303308	5/16"	6 360	\$5.00 \$7.10	\$8.80	
303309	3/8"	6 180	\$7.00 \$10.00	\$12.30	
303310	1/2"	6 60	\$13.00 \$18.60	\$22.90	

Mínimo a surtir 1 bolsa con 6 piezas

Conector tipo campana anillo suelto

BOLSA

- ▶ Para cable coaxial
- ▶ Para instalaciones de antenas o cable
- ▶ Tipo F con anillo suelto



PRECIO POR PIEZA

CÓDIGO	CABLE	PIEZAS X BOLSA	DISTRIB.	MAX.	LISTA
116140	RG 59	100 25 bolsas 100 bolsas	\$0.90 \$1.30	\$1.60	
116141	RG 6	100 25 bolsas 100 bolsas	\$0.90 \$1.30	\$1.60	

Mínimo a surtir 1 bolsa con 100 piezas

Conector de enrosacar

BOLSA

- ▶ Para cable coaxial
- ▶ Para instalaciones de antenas o cable
- ▶ Tipo F



PRECIO POR PIEZA

CÓDIGO	CABLE	PIEZAS X BOLSA	DISTRIB.	MAX.	LISTA
116142	RG 59	100 25 bolsas 100 bolsas	\$0.90 \$1.30	\$1.60	
116143	RG 6	100 25 bolsas 100 bolsas	\$0.70 \$1.00	\$1.20	

Mínimo a surtir 1 bolsa con 100 piezas

Barril de unión sencillo RG 6

BOLSA

- ▶ Para cable coaxial
- ▶ Para instalaciones de antenas o cable
- ▶ Tipo F



PRECIO POR PIEZA

CÓDIGO	CABLE	PIEZAS X BOLSA	DISTRIB.	MAX.	LISTA
116144	RG 6	100 25 bolsas 50 bolsas	\$1.70 \$2.40	\$3.00	

Mínimo a surtir 1 bolsa con 100 piezas

Divisor coaxial de 1 entrada a 2, 3 ó 4 salidas

PROX.

CABALLETE

- ▶ Cuerpo metálico con acabado anticorrosivo
- ▶ Para señal UHF, VHF y FM
- ▶ Separa la señal proveniente de una fuente a 2, 3 ó 4 salidas



CÓDIGO	SALIDAS			DISTRIB.	MAYOREO	LISTA
116171	2	20	200	\$8.00	\$11.40	\$14.10

CÓDIGO	SALIDAS			DISTRIB.	MAYOREO	LISTA
116172	3	10	100	\$10.00	\$14.30	\$17.60

CÓDIGO	SALIDAS			DISTRIB.	MAYOREO	LISTA
116173	4	10	100	\$11.00	\$15.70	\$19.40

Armella cerrada

CAJA

- ▶ Ideal para sujetar o colgar en cualquier tipo de superficie
- ▶ Fabricadas en acero galvanizado



PRECIO POR CAJA

CÓDIGO	DENOMINACIÓN COMÚN	PIEZAS X CAJA			DISTRIB.	MAYOREO	LISTA
119011	17 x 40	144	12	\$22.00	\$31.00	\$39.00	
119012	18 x 50	144	12	\$44.00	\$63.00	\$78.00	
119013	19 x 60	144	12	\$59.00	\$84.00	\$104.00	
119014	20 x 70	144	12	\$79.00	\$113.00	\$139.00	
119015	21 x 80	144	12	\$105.00	\$150.00	\$185.00	
119016	22 x 100	72	12	\$85.00	\$121.00	\$150.00	
119017	23 x 110	72	12	\$99.00	\$141.00	\$175.00	

Mínimo a surtir 1 caja con 72 ó 144 piezas

Armella abierta

CAJA

- ▶ Ideal para sujetar o colgar en cualquier tipo de superficie
- ▶ Fabricadas en acero galvanizado



PRECIO POR CAJA

CÓDIGO	DENOMINACIÓN COMÚN	PIEZAS X CAJA			DISTRIB.	MAYOREO	LISTA
119021	17 x 40	144	12	\$35.00	\$50.00	\$62.00	
119022	18 x 50	144	12	\$49.00	\$70.00	\$86.00	
119023	19 x 60	144	12	\$60.00	\$86.00	\$106.00	
119024	20 x 70	144	12	\$80.00	\$114.00	\$141.00	
119025	21 x 80	144	12	\$99.00	\$141.00	\$175.00	
119026	22 x 100	72	12	\$85.00	\$121.00	\$150.00	
119027	23 x 110	72	12	\$115.00	\$165.00	\$205.00	

Mínimo a surtir 1 caja con 72 ó 144 piezas

Alcayata roscada

CAJA

- ▶ Ideal para sujetar o colgar en cualquier tipo de superficie
- ▶ Fabricadas en acero galvanizado



PRECIO POR CAJA

CÓDIGO	DENOMINACIÓN COMÚN	PIEZAS X CAJA			DISTRIB.	MAYOREO	LISTA
119031	16 x 20	144	12	\$35.00	\$50.00	\$62.00	
119032	18 x 50	144	12	\$55.00	\$79.00	\$97.00	
119033	19 x 60	144	12	\$75.00	\$107.00	\$132.00	
119034	20 x 70	144	12	\$90.00	\$129.00	\$160.00	
119035	21 x 80	144	12	\$115.00	\$165.00	\$205.00	
119036	22 x 90	144	12	\$175.00	\$250.00	\$310.00	
119037	22 x 100	72	12	\$105.00	\$150.00	\$185.00	
119038	23 x 110	72	12	\$190.00	\$270.00	\$335.00	

Mínimo a surtir 1 caja con 72 ó 144 piezas

Escuadra esquinera

BOLSA

- ▶ Fabricadas de acero galvanizado
- ▶ Ideales para sostener objetos o reforzar esquineros

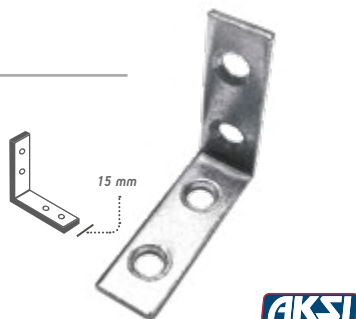

AKSI

CÓDIGO	MEDIDA	PIEZAS X BOLSA			DISTRIB.	MAYOREO	LISTA
106601	25 x 15 mm	50	6	24	\$48.00	\$69.00	\$85.00
106602	30 x 15 mm	50	6	24	\$65.00	\$93.00	\$115.00
106603	50 x 15 mm	50	3	12	\$90.00	\$129.00	\$160.00
106604	60 x 15 mm	24	6	24	\$60.00	\$86.00	\$106.00
106605	75 x 15 mm	24	3	18	\$80.00	\$114.00	\$141.00
106606	80 x 15 mm	24	3	18	\$105.00	\$150.00	\$185.00
106607	100 x 15 mm	24	3	12	\$130.00	\$185.00	\$230.00

Mínimo a surtir 1 bolsa

Escuadra esquinera con tornillos

BLÍSTER

- ▶ Set de 4 escuadras con 16 tornillos
- ▶ Fabricadas de acero galvanizado
- ▶ Ideales para sostener objetos o reforzar esquineros

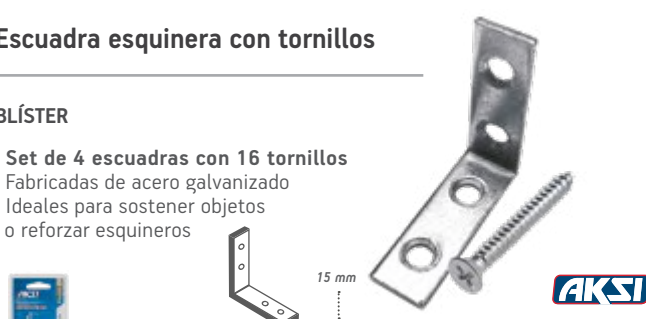

AKSI

PRECIO POR SET

CÓDIGO	MEDIDA			DISTRIB.	MAYOREO	LISTA
106611	25 x 15 mm	12	144	\$16.00	\$22.90	\$28.00
106612	30 x 15 mm	12	144	\$17.00	\$24.30	\$30.00
106613	50 x 15 mm	12	144	\$21.00	\$30.00	\$37.00
106614	60 x 15 mm	12	72	\$23.00	\$33.00	\$41.00
106615	75 x 15 mm	12	72	\$32.00	\$46.00	\$56.00
106617	100 x 15 mm	12	72	\$50.00	\$71.00	\$88.00

Bandola mosquetón de acero

BOLSA

- ▶ Cuerpo fabricado en acero SAE1008
- ▶ Acabado galvanizado
- ▶ Resistente a la corrosión



NO USAR PARA ESCALAR

TI MAXTOOL

PRECIO POR PIEZA

CÓDIGO	DIÁMETRO	PIEZAS X BOLSA	DISTRIB.	MAYOREO	LISTA	
303347	3/16"	6	144	\$6.00	\$8.60	\$10.60
303348	1/4"	6	144	\$7.00	\$10.00	\$12.30
303349	5/16"	6	144	\$10.00	\$14.30	\$17.60
303350	3/8"	6	144	\$15.00	\$21.40	\$26.00
303351	1/2"	6	144	\$25.00	\$36.00	\$44.00

Mínimo a surtir 1 bolsa con 6 piezas

Bandola mosquetón de acero con seguro

BOLSA

- ▶ Cuerpo fabricado en acero SAE1008
- ▶ Seguro fabricado en acero SAE1010
- ▶ Acabado galvanizado
- ▶ Resistente a la corrosión



NO USAR PARA ESCALAR

TI MAXTOOL

PRECIO POR PIEZA

CÓDIGO	DIÁMETRO	PIEZAS X BOLSA	DISTRIB.	MAYOREO	LISTA	
303352	3/16"	6	144	\$7.00	\$10.00	\$12.30
303353	1/4"	6	144	\$9.00	\$12.90	\$15.90
303354	5/16"	6	144	\$14.00	\$20.00	\$24.70
303355	3/8"	6	144	\$20.00	\$29.00	\$35.00
303356	1/2"	6	144	\$35.00	\$50.00	\$62.00

Mínimo a surtir 1 bolsa con 6 piezas

Bandola de acero con seguro

BOLSA

- ▶ Cuerpo fabricado en acero SAE1008
- ▶ Seguro fabricado en acero SAE1010
- ▶ Acabado galvanizado
- ▶ Resistente a la corrosión



NO USAR PARA ESCALAR

TI MAXTOOL

PRECIO POR PIEZA

CÓDIGO	DIÁMETRO	PIEZAS X BOLSA	DISTRIB.	MAYOREO	LISTA	
303323	1/8"	6	144	\$5.00	\$7.10	\$8.80
303324	3/16"	6	144	\$6.00	\$8.60	\$10.60
303325	1/4"	6	144	\$7.00	\$10.00	\$12.30
303326	5/16"	6	144	\$11.00	\$15.70	\$19.40
303327	3/8"	6	144	\$18.00	\$26.00	\$32.00
303328	1/2"	6	144	\$32.00	\$46.00	\$56.00

Mínimo a surtir 1 bolsa con 6 piezas

Bandola mosquetón de aluminio

BOLSA

- ▶ Acabado en color rojo metálico



NO USAR PARA ESCALAR

TI MAXTOOL

PRECIO POR PIEZA

CÓDIGO	DIÁMETRO	PIEZAS X BOLSA	DISTRIB.	MAYOREO	LISTA	
303339	3/16"	6	144	\$7.00	\$10.00	\$12.30
303340	1/4"	6	144	\$8.00	\$11.40	\$14.10
303341	9/32"	6	144	\$9.00	\$12.90	\$15.90
303342	5/16"	6	144	\$11.00	\$15.70	\$19.40

Mínimo a surtir 1 bolsa con 6 piezas

Bandola rápida de aluminio

BOLSA

- ▶ Acabado en color rojo metálico



NO USAR PARA ESCALAR

TI MAXTOOL

PRECIO POR PIEZA

CÓDIGO	DIÁMETRO	PIEZAS X BOLSA	DISTRIB.	MAYOREO	LISTA	
303343	3/16"	6	144	\$7.00	\$10.00	\$12.30
303344	1/4"	6	144	\$8.00	\$11.40	\$14.10
303345	9/32"	6	144	\$10.00	\$14.30	\$17.60
303346	5/16"	6	144	\$11.00	\$15.70	\$19.40

Mínimo a surtir 1 bolsa con 6 piezas

Bandola destorcedor de latón

BOLSA

- ▶ Cuerpo fabricado en latón sólido que brinda mayor resistencia
- ▶ Acabado pulido natural

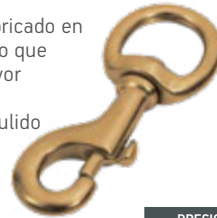

NO USAR PARA ESCALAR

TI MAXTOOL

PRECIO POR PIEZA

CÓDIGO	DIÁMETRO	LONGITUD	PIEZAS X BOLSA	DISTRIB.	MAYOREO	LISTA	
303329	5/8"	2"	6	144	\$40.00	\$57.00	\$71.00
303330	3/4"	3"	6	144	\$45.00	\$64.00	\$79.00
303331	1"	3 1/2"	6	144	\$60.00	\$86.00	\$106.00
303332	1 1/8"	4"	6	144	\$90.00	\$129.00	\$160.00
303333	1 1/4"	4 1/4"	6	144	\$100.00	\$143.00	\$175.00

Mínimo a surtir 1 bolsa con 6 piezas

Bandola destorcedor de zinc

BOLSA

- ▶ Acabado niquelado
- ▶ Resistente a la corrosión



NO USAR PARA ESCALAR

TI MAXTOOL

PRECIO POR PIEZA

CÓDIGO	DIÁMETRO	LONGITUD	PIEZAS X BOLSA	DISTRIB.	MAYOREO	LISTA	
303334	7/16"	2"	6	144	\$7.00	\$10.00	\$12.30
303335	7/16"	3"	6	144	\$11.00	\$15.70	\$19.40
303336	5/8"	3 1/2"	6	144	\$13.00	\$18.60	\$22.90
303337	7/8"	4"	6	144	\$18.00	\$26.00	\$32.00
303338	3/4"	4 1/4"	6	144	\$27.00	\$39.00	\$48.00

Mínimo a surtir 1 bolsa con 6 piezas

Destorcedor de zinc

BOLSA

- ▶ Fabricado en zinc acabado niquelado
- ▶ Resistente a la corrosión



NO USAR PARA ESCALAR

TI MAXTOOL

PRECIO POR PIEZA

CÓDIGO	DIÁMETRO	PIEZAS X BOLSA	DISTRIB.	MAYOREO	LISTA	
303318	1/8"	6	144	\$7.00	\$10.00	\$12.30
303319	5/32"	6	144	\$11.00	\$15.70	\$19.40
303320	3/16"	6	144	\$13.00	\$18.60	\$22.90
303321	1/4"	6	144	\$14.00	\$20.00	\$24.70
303322	5/16"	6	144	\$17.00	\$24.30	\$30.00

Mínimo a surtir 1 bolsa con 6 piezas

Gancho "S"

BOLSA

- ▶ Fabricado en acero SAE1015
- ▶ Acabado galvanizado
- ▶ Resistente a la corrosión



NO USAR PARA ESCALAR

TI MAXTOOL

PRECIO POR PIEZA

CÓDIGO	DIÁMETRO	CAP. DE CARGA	PIEZAS X BOLSA	DISTRIB.	MAYOREO	LISTA	
303311	3/16"	16.9 kg	6	144	\$4.00	\$5.70	\$7.10
303312	1/4"	40.3 kg	6	144	\$5.00	\$7.10	\$8.80
303313	5/16"	77 kg	6	144	\$7.00	\$10.00	\$12.30

Mínimo a surtir 1 bolsa con 6 piezas

Garrucha para noria

BOLSA

- ▶ También conocidas como poleas para tendedero
- ▶ Fabricada en aleación metálica
- ▶ Polea con acabado latonado
- ▶ Cuerpo con acabado níquelado
- ▶ Resistente a la corrosión



IT MAXTOOL

PRECIO POR PIEZA

CÓDIGO	DIÁMETRO	PIEZAS X BOLSA		DISTRIB.	MAYOREO	LISTA
303314	3/4"	6	144	\$11.00	\$15.70	\$19.40
303315	1"	6	144	\$18.00	\$26.00	\$32.00
303316	1 1/2"	6	144	\$30.00	\$43.00	\$53.00
303317	2"	6	144	\$55.00	\$79.00	\$97.00

Mínimo a surtir 1 bolsa con 6 piezas

Tensor gancho argolla

BOLSA

- ▶ Cuerpo fabricado en zinc
- ▶ Gancho y argolla fabricados en acero al carbono
- ▶ Acabado galvanizado
- ▶ Resistente a la corrosión



IT MAXTOOL

PRECIO POR PIEZA

CÓDIGO	DIÁMETRO	CARGA	PIEZAS X BOLSA		DISTRIB.	MAYOREO	LISTA
303301	3/16"	41 kg	6	144	\$8.00	\$11.40	\$14.10
303302	1/4"	50 kg	6	144	\$13.00	\$18.60	\$22.90
303303	5/16"	100 kg	6	144	\$20.00	\$29.00	\$35.00
303304	3/8"	200 kg	6	96	\$27.00	\$39.00	\$48.00

Mínimo a surtir 1 bolsa con 6 piezas

Cómo poner tu carga?

El peso desigual puede afectar la dirección, los frenos y el control de oscilación.

En general, el 60% del peso de la carga debe estar en la mitad delantera del remolque y el 40% en la mitad trasera (a menos que el fabricante indique algo diferente). Cuando colocas la carga, querrás que esté equilibrada de lado a lado, manteniendo el centro de gravedad cerca del suelo y sobre el eje del remolque.

Sujeta tu carga
Después de equilibrar la carga, debes sujetarla en el lugar. Una carga sin sujetar puede desplazarse cuando el vehículo está en movimiento y causar inestabilidad del remolque.

✓ Correcto



Remolque con carga equilibrada

✗ Incorrecto



Remolque no equilibrado



Exceso de peso

Si la cavidad para la rueda está desplazando el neumático, hay demasiado peso de lengüeta. Resuélvelo colocando los artículos más pesados en el centro del remolque.



Peso en equilibrio

Una lengüeta equilibrada te brinda el control total del auto y el remolque. Si la lengüeta del remolque está paralela al suelo, entonces está equilibrada.



Peso insuficiente

Si hay demasiado peso en la parte trasera del remolque, se puede elevar levemente la parte trasera del auto. Resuélvelo colocando artículos más pesados en el centro del remolque.

Bola de arrastre para remolque, 3 500 lb

PROX.

CAJA PLÁSTICA

- ▶ Fabricada en acero cromado resistente a la corrosión
- ▶ Tuerca hexagonal y arandela de presión
- ▶ Para acopladores de bola de 2" de diámetro



10 años GARANTÍA

AKSI

CÓDIGO	CARGA			DISTRIB.	MAYOREO	LISTA
116321	3 500 lb	4	12	\$115.00	\$165.00	\$205.00

Acoplador para remolque, 3 500 lb

PROX.

CAJA

- ▶ Acople en bola de 2"
- ▶ Fabricado en acero galvanizado resistente a la corrosión
- ▶ Enganche a remolque rápido y seguro
- ▶ Para barra de remolque de 2 1/2"



10 años GARANTÍA

AKSI

CÓDIGO	CARGA			DISTRIB.	MAYOREO	LISTA
116331	3 500 lb	4	12	\$285.00	\$405.00	\$505.00

Avellanador

BLÍSTER

- ▶ Para tubos de \varnothing 3/16" - 5/8"



CÓDIGO	DIÁMETRO			DISTRIB.	MAYOREO	LISTA
112120	3/16" - 5/8"	6	24	\$200.00	\$285.00	\$355.00

Juego de avellanador y cortador de tubo

BLÍSTER

- ▶ Para tubos de \varnothing 3/16" - 5/8"
- ▶ Corta tubos de cobre, aluminio y latón



CÓDIGO	DIÁMETRO			DISTRIB.	MAYOREO	LISTA
112122	3/16"	6	12	\$310.00	\$445.00	\$545.00

Cortador de tubo 1 1/8"

BLÍSTER

- ▶ Útil para cortar tubos de cobre, aluminio y latón
- ▶ Aditamento retráctil, para quitar rebabas
- ▶ Cuerpo ligero y resistente

Repuestos para cortador de tubo

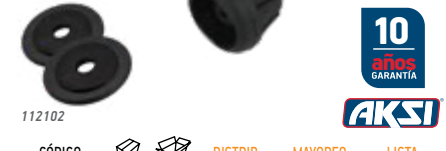

CÓDIGO			DISTRIB.	MAYOREO	LISTA
112101	6	72	\$120.00	\$170.00	\$210.00
112102	12	72	\$28.00	\$40.00	\$49.00

Adaptador metálico en "Y"

TARJETA

- ▶ Regulador de agua con válvulas de cerrado
- ▶ Fabricado en aleación de zinc con acabado cromado resistente a la corrosión
- ▶ No genera óxido
- ▶ Cuerda estándar NPT
- ▶ Incluye empaque



CÓDIGO	DIÁMETRO			DISTRIB.	MAYOREO	LISTA
102416	3/4"	6	48	\$46.00	\$66.00	\$81.00

Adaptador plástico en "Y"

BOLSA

- ▶ Regulador de agua con válvulas de cerrado
- ▶ Fabricado en plástico ABS de alta resistencia
- ▶ Cuerda estándar NPT
- ▶ Incluye empaque



CÓDIGO	DIÁMETRO			DISTRIB.	MAYOREO	LISTA
302301	3/4"	6	48	\$20.00	\$29.00	\$35.00

Adaptador plástico de conexión rápida

GRANEL

- ▶ Práctica y rápida conexión y desconexión
- ▶ Cuerda estándar NPT para cualquier pistola, chiflón de riego, o hidrolavadoras



CÓDIGO	ROSCA	TIPO	PZAS X BOLSA		DISTRIB.	MAYOREO	LISTA
102410	3/4"	Macho	24	96	\$5.00	\$7.10	\$8.80
102417	3/4"	Hembra	24	96	\$5.00	\$7.10	\$8.80

Aspersor plástico 1 vía de 11"

TARJETA

- ▶ Clip y retenes ajustables
- ▶ Área de riego regulable de 0° hasta 360°
- ▶ Estaca de plástico ABS de 19,5 cm



CÓDIGO	CARACTERÍSTICA			DISTRIB.	MAYOREO	LISTA
300501	1 VÍA	6	72	\$37.00	\$53.00	\$65.00

Aspersor plástico 2 vías de 11"

TARJETA

- ▶ Clip y retenes ajustables
- ▶ Área de riego regulable de 0° hasta 360°
- ▶ Estaca de plástico ABS de 19,5 cm



CÓDIGO	CARACTERÍSTICA			DISTRIB.	MAYOREO	LISTA
300502	2 VÍAS	6	72	\$40.00	\$57.00	\$71.00

Seguetas bimetálicas de 18 y 24 dpp

CAJA PLÁSTICA

- ▶ Dientes fabricados en acero alta velocidad
- ▶ Cuerpo altamente flexible, brinda resistencia y durabilidad

CAJA PLÁSTICA
CON 50 PIEZAS



PRECIO POR SEGUETA

CÓDIGO	SEGUETA	DIENTES		DISTRIB.	MAYOREO	LISTA
107501	12"	18 dpp	20 cajas	\$12.00	\$17.10	\$21.20
107502	12"	24 dpp	20 cajas	\$12.00	\$17.10	\$21.20

Mínimo a surtir 1 caja plástica con 50 seguetas

Seguetas bimetálicas de 18 y 24 dpp, set de 2 piezas

BLÍSTER

- ▶ Dientes fabricados en acero alta velocidad
- ▶ Cuerpo altamente flexible, brinda resistencia y durabilidad



PRECIO POR SET

CÓDIGO	SEGUETA	DIENTES			DISTRIB.	MAYOREO	LISTA
107503	12"	18 dpp	15	150	\$35.00	\$50.00	\$62.00
107504	12"	24 dpp	15	150	\$35.00	\$50.00	\$62.00

Arco profesional tubular

FUNDA DE CARTÓN

- ▶ Para seguetas de 12"
- ▶ Mayor resistencia
- ▶ Mango de aluminio con grip
- ▶ Resistente y ligero



3
años
GARANTÍA

AKSI

CÓDIGO	SEGUETA			DISTRIB.	MAYOREO	LISTA
103601	12"	12	36	\$125.00	\$180.00	\$220.00

Arco de solera

FUNDA DE CARTÓN

- ▶ Mango de plástico ABS
- ▶ Cuerpo de solera
- ▶ Para seguetas estándar de 12"



18
meses
GARANTÍA

ITI MAXTOOL

CÓDIGO	SEGUETA			DISTRIB.	MAYOREO	LISTA
301001	12"	6	36	\$63.00	\$90.00	\$111.00

Arco de solera ajustable

FUNDA DE CARTÓN

- ▶ Cuerpo de solera móvil, con 3 posiciones
- ▶ Para seguetas estándar de 8", 10" y 12"



18
meses
GARANTÍA

ITI MAXTOOL

CÓDIGO	SEGUETA			DISTRIB.	MAYOREO	LISTA
301004	12"	6	36	\$60.00	\$86.00	\$106.00

Mini arco

TARJETA

- ▶ Mango ergonómico de plástico ABS
- ▶ Diseñado para hacer cortes en espacios pequeños y ángulos difíciles



18
meses
GARANTÍA

ITI MAXTOOL

CÓDIGO	SEGUETA			DISTRIB.	MAYOREO	LISTA
301003	10" - 12"	6	72	\$27.00	\$39.00	\$48.00

Atomizadores

BOLSA

- ▶ Sistema de atomización regulable
- ▶ Tamaño ideal para trabajos ligeros
- ▶ Excelente durabilidad en todo tipo de aplicaciones de limpieza



CÓDIGO	CAPACIDAD		DISTRIB.	MAYOREO	LISTA
103501	500 ml	75	\$25.00	\$36.00	\$44.00
103502	1 L	40	\$30.00	\$43.00	\$53.00

Báscula digital de cocina, 1 g / 10 kg

PROX.

CAJA

- ▶ Indicador de peso
- ▶ Función TARA (peso neto sin recipiente)
- ▶ Pantalla LCD
- ▶ Apagado automático
- ▶ Utiliza 2 pilas AA incluidas



CÓDIGO	CAPACIDAD			DISTRIB.	MAYOREO	LISTA
128701	10 kg	6	36	\$100.00	\$143.00	\$175.00

Aceite aflojatodo multiusos dieléctrico

AEROSOL

- ▶ Libera mecanismos trabados
- ▶ Protege contra la oxidación y corrosión
- ▶ Elimina la humedad

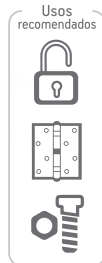

CÓDIGO	CONTENIDO		DISTRIB.	MAYOREO	LISTA
119531	110 ml	12	\$24.00	\$34.00	\$42.00
119532	235 ml	12	\$30.00	\$43.00	\$53.00
119533	400 ml	12	\$46.00	\$66.00	\$81.00

Aceite mineral para motor de 2 tiempos

BOTE DE PLÁSTICO

- ▶ Alta resistencia a la oxidación
- ▶ Alarga hasta el 80% la vida del motor
- ▶ Ideal para podadoras, desbrozadoras, motocicletas, motosierras



CÓDIGO	CONTENIDO		DISTRIB.	MAYOREO	LISTA
119581	120 ml	24	\$21.00	\$30.00	\$37.00
119583	250 ml	24	\$33.00	\$47.00	\$58.00

Aceite lubricante multiusos

BOTE DE PLÁSTICO

- ▶ Protege contra la oxidación y corrosión
- ▶ Lubrica partes móviles
- ▶ Limpia superficies de metal



CÓDIGO	CONTENIDO			DISTRIB.	MAYOREO	LISTA
119541	60 ml	10	100	\$19.00	\$27.00	\$34.00
119542	120 ml	10	100	\$26.00	\$37.00	\$46.00

Limpiador para carburador y partes metálicas

AEROSOL

- ▶ Limpia y remueve grasa, aceite, polvo y suciedad
- ▶ Excelente limpiador de partes metálicas en general
- ▶ Útil para limpiar interior y exterior de carburadores
- ▶ Para motores de 2 y 4 tiempos



CÓDIGO	CONTENIDO		DISTRIB.	MAYOREO	LISTA
119551	400 ml	12	\$49.00	\$70.00	\$86.00

Cepillo limpiador de terminales de batería 4 en 1

BLÍSTER

- ▶ Limpia las terminales y postes de baterías
- ▶ Para limpieza de tubería de 1/2" y 3/4"
- ▶ Cerdas de acero



CÓDIGO			DISTRIB.	MAYOREO	LISTA
128401	12	144	\$48.00	\$69.00	\$85.00

Grasa multiuso 450 g

BOTE DE PLÁSTICO

- ▶ Gran adhesividad y estabilidad mecánica
- ▶ Para chasis, baleros, equipo agrícola, industrial y de construcción



CÓDIGO	CONTENIDO		DISTRIB.	MAYOREO	LISTA
119591	450 g	12	\$80.00	\$114.00	\$141.00

Alambre de púas ranchero

ROLLO

- ▶ Fabricado con dos alambres galvanizados con púas de triple enrollado de corte diagonal
- ▶ Separación de 5" entre púas
- ▶ Rendimiento aproximado de 10,8 m/kg
- ▶ Resistencia de ruptura: 431 kg mín.
- ▶ Púas calibre 14



CÓDIGO	PRESENTACIÓN	CALIBRE	DISTRIB.	MAYOREO	LISTA
117051	34 kg	12.5	\$1,400.00	\$2,000.00	\$2,470.00
117052	30 kg	12.5	\$1,250.00	\$1,785.00	\$2,205.00

Alambre de púas corralero

ROLLO

- ▶ Fabricado con dos alambres galvanizados trenzados
- ▶ Separación de 5" entre púas
- ▶ Rendimiento aproximado de 18 m/kg
- ▶ Púas calibre 15



CÓDIGO	PRESENTACIÓN	CALIBRE	DISTRIB.	MAYOREO	LISTA
117053	360 m	15	\$1,000.00	\$1,430.00	\$1,765.00
117054	300 m	15	\$870.00	\$1,245.00	\$1,535.00

Alambre galvanizado

ROLLO

- ▶ Ideal para instalaciones eléctricas, plafones, jardinería y reparaciones generales
- ▶ Rollo de 1 kg



CÓDIGO	CALIBRE	RENDIMIENTO		DISTRIB.	MAYOREO	LISTA
117041	12.5	27 m/kg	20 rollos	\$50.00	\$71.00	\$88.00
117042	14.5	47 m/kg	20 rollos	\$52.00	\$74.00	\$92.00
117043	16	65 m/kg	20 rollos	\$53.00	\$76.00	\$93.00
117044	18	110 m/kg	20 rollos	\$58.00	\$83.00	\$102.00
117045	20	230 m/kg	20 rollos	\$59.00	\$84.00	\$104.00
117046	22	321 m/kg	20 rollos	\$61.00	\$87.00	\$108.00

Azadón tipo Lane

NEUVO

GRANEL

- ▶ Forjados en una sola pieza para mayor durabilidad



CÓDIGO	PESO	ANCHO DE HOJA		DISTRIB.	MAY.	LISTA
111251	1.6 lb (0.72) kg	7 1/4" (18.5 cm)	6 24	\$105.00	\$150.00	\$185.00
111252	1.7 lb (0.77) kg	7 3/4" (19.5 cm)	6 24	\$110.00	\$155.00	\$195.00
111253	1.8 lb (0.81) kg	7 3/4" (19.5 cm)	6 24	\$115.00	\$165.00	\$205.00

Azadón tipo Lane con mango

PROX.

GRANEL

- ▶ Forjados en una sola pieza para mayor durabilidad



CÓDIGO	ANCHO DE HOJA		DISTRIB.	MAYOREO	LISTA
111256	7 1/4" (18.5 cm)	1	\$200.00	\$285.00	\$355.00
111257	7 3/4" (19.5 cm)	1	\$205.00	\$295.00	\$360.00
111258	7 3/4" (19.5 cm)	1	\$210.00	\$300.00	\$370.00

Concertina galvanizada 47 m

PROX.

GRANEL

- ▶ Fabricada en lámina de acero galvanizado
- ▶ Navaja larga de 4 u 8 puntas incisivas



CÓDIGO	SEGURIDAD	PESO	DISTRIB.	MAYOREO	LISTA
117055	Máxima: 8 puntas	5.3 kg	\$475.00	\$680.00	\$840.00
117056	Alta: 4 puntas	4.9 kg	\$410.00	\$585.00	\$725.00

Mango para azadón, 48"

PROX.

GRANEL

- ▶ Mango de madera de 48" (121 cm)
- ▶ Para uso en azadones tipo Lane AKSI



CÓDIGO	DISTRIB.	MAYOREO	LISTA
109309	\$100.00	\$143.00	\$175.00

Bieldo con mango largo

PROX.

GRANEL

- ▶ Cabeza forjada
- ▶ Para trabajos en ranchos y granjas

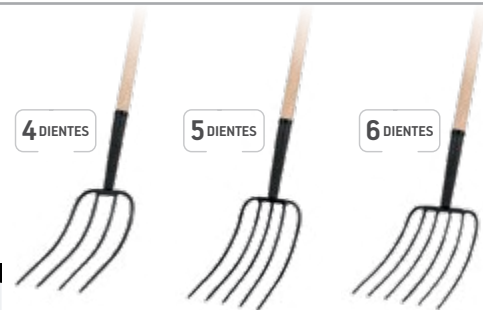

CARACTERÍSTICAS			
	111241	111242	111243
Ancho	8 1/2" (22 cm)	9" (23 cm)	13" (33 cm)
Altura	12 3/4" (32 cm)	12 3/4" (32 cm)	13 1/4" (34 cm)
Largo de mango	48" (122 cm)	48" (122 cm)	48" (122 cm)

CÓDIGO	DIENTES		DISTRIB.	MAYOREO	LISTA
111241	4	6	\$285.00	\$405.00	\$505.00
111242	5	6	\$300.00	\$430.00	\$530.00
111243	6	6	\$375.00	\$535.00	\$660.00

Bota jardinera

BOLSA

- ▶ Diseñada para laborar en ambientes húmedos
- ▶ Resistente al fango, lodo, agua y vapor
- ▶ Altura: 35 cm



SUELA ANTIDERRAPANTE 1...



CÓDIGO	TALLA		DISTRIB.	MAYOREO	LISTA
114401	24	10	\$160.00	\$230.00	\$280.00
114402	25	10	\$160.00	\$230.00	\$280.00
114403	26	10	\$160.00	\$230.00	\$280.00
114404	27	10	\$160.00	\$230.00	\$280.00
114405	28	10	\$160.00	\$230.00	\$280.00
114406	29	10	\$160.00	\$230.00	\$280.00

Bota sanitaria

BOLSA

- ▶ Fabricadas en PVC
- ▶ Suela antiderrapante de gran durabilidad
- ▶ Diseñada para la industria alimentaria, procesamiento de cárnicos y laboratorios.
- ▶ Altura: 35 cm



SUELA ANTIDERRAPANTE 1...



CÓDIGO	TALLA		DISTRIB.	MAYOREO	LISTA
114411	25	10	\$220.00	\$315.00	\$390.00
114412	26	10	\$220.00	\$315.00	\$390.00
114413	27	10	\$220.00	\$315.00	\$390.00
114414	28	10	\$220.00	\$315.00	\$390.00
114415	29	10	\$220.00	\$315.00	\$390.00
114416	30	10	\$220.00	\$315.00	\$390.00

Bota industrial

BOLSA

- ▶ Fabricadas en PVC
- ▶ Suela antiderrapante de gran durabilidad
- ▶ Diseñada para servicios de limpieza, sector automotriz y ganadero
- ▶ Altura: 35 cm



SUELA ANTIDERRAPANTE 1...



CÓDIGO	TALLA		DISTRIB.	MAYOREO	LISTA
114421	25	10	\$220.00	\$315.00	\$390.00
114422	26	10	\$220.00	\$315.00	\$390.00
114423	27	10	\$220.00	\$315.00	\$390.00
114424	28	10	\$220.00	\$315.00	\$390.00
114425	29	10	\$220.00	\$315.00	\$390.00
114426	30	10	\$220.00	\$315.00	\$390.00

Banderín vial con reflejante

CABALLETE

- ▶ Incluye tubo plástico
- ▶ Resistente a los rayos UV
- ▶ Ideal para obras en construcción, estacionamiento, tránsito vial, etc.



CÓDIGO	MEDIDA			DISTRIB.	MAYOREO	LISTA
108181	33 x 30 cm	10	100	\$30.00	\$43.00	\$53.00
108182	48 x 48 cm	10	100	\$32.00	\$46.00	\$56.00

Complemento para tu seguridad

Overol desechable

BOLSA

- ▶ Espesor 0,28 mm
- ▶ Tela interior de polipropileno
- ▶ Tela exterior de polietileno
- ▶ Ideal para trabajar con líquidos no abrasivos
- ▶ Repelente



CÓDIGO	TALLA			DISTRIB.	MAYOREO	LISTA
107931	Ch	5	25	\$70.00	\$100.00	\$123.00
107932	M	5	25	\$70.00	\$100.00	\$123.00
107933	G	5	25	\$70.00	\$100.00	\$123.00
107934	XG	5	25	\$70.00	\$100.00	\$123.00

Bomba para inflar de 21"

GRANEL

- ▶ Adaptador metálico de seguridad para pivote
- ▶ Sistema de doble cilindro metálico, para un inflado más rápido
- ▶ Mango plástico ergonómico y soporte de pedal abatible

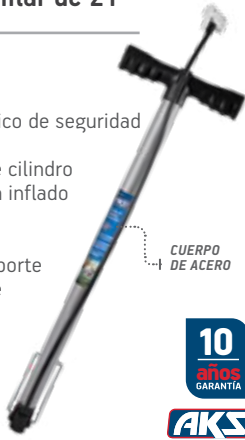

CUERPO DE ACERO



CÓDIGO	TAMAÑO	PIEZAS X BOLSA	📦	DISTRIB.	MAYOREO	LISTA
110002	53 cm - 21"	N/A	12	\$105.00	\$150.00	\$185.00

Bomba para inflar de 20"

GRANEL

- ▶ Manguera de mayor espesor reforzada con tejido de Nylon® que brinda mayor tiempo de vida
- ▶ Mango plástico ergonómico y soporte de pedal abatible



CUERPO METÁLICO



CÓDIGO	TAMAÑO	DIÁMETRO	📦	DISTRIB.	MAYOREO	LISTA
110001	51 cm - 20"	1 13/16"	15	\$120.00	\$170.00	\$210.00

Bomba para inflar de 19"

GRANEL

- ▶ Manguera de mayor espesor reforzada con tejido de Nylon® que brinda mayor tiempo de vida
- ▶ Mango plástico y soporte de pedal abatible



CUERPO METÁLICO



CÓDIGO	TAMAÑO	DIÁMETRO	📦	DISTRIB.	MAYOREO	LISTA
302901	48 cm - 19"	1 1/4"	15	\$100.00	\$143.00	\$175.00

Accesorios

Válvula para inflar

CABALLETE / BOLSA

- ▶ Fabricadas en acero inoxidable
- ▶ Acabado pulido
- ▶ Disponible en presentación de 10 ó 100 piezas



110003



CÓDIGO	TAMAÑO	PIEZAS X BOLSA	📦	📦	DISTRIB.	MAYOREO	LISTA
110003	1/8"	100	10	100 bolsas	\$85.00	\$121.00	\$150.00
110006	1/8"	10	24 bolsas	240 bolsas	\$15.00	\$21.40	\$26.00

Repuesto de manguera para bomba

CABALLETE / BOLSA

- ▶ Se recomienda utilizar en los modelos AKSI® y MAXTOOL®
- ▶ Manguera de mayor espesor reforzada con tejido de Nylon®



*Nylon® es una marca registrada



CÓDIGO	TAMAÑO	DIÁMETRO	📦	DISTRIB.	MAYOREO	LISTA
110004	48 cm - 19"	N/A	200	\$20.00	\$29.00	\$35.00

◀ Vuelve útil tus equipos con nuestras refacciones.

Bomba mini para inflar

TARJETA

- ▶ Recomendable para ciclismo urbano y recreación
- ▶ Cuerpo de aluminio ligero
- ▶ Mango fabricado en plástico ABS y manguera de poliuretano
- ▶ Base de pedal abatible
- ▶ Clip de fijación para bicicletas



BASE ABATIBLE



CLIP Para sujetarla al cuadro de la bicicleta



CÓDIGO	📦	📦	DISTRIB.	MAYOREO	LISTA
110005	6	48	\$85.00	\$121.00	\$150.00

Bomba de pedal para inflar

CAJA

- ▶ Manguera flexible de PVC y válvula de aluminio
- ▶ Cilindro de acero para obtener alta presión de aire
- ▶ Conector reforzado con seguro para evitar fugas de aire
- ▶ Pedal que facilita el inflado
- ▶ Ideal para inflar neumáticos de bicicletas, autos, motocicletas, balones, etc.



CUERPO DE ACERO



INCLUDE:
1 Adaptador para inflables
1 Válvula para balones

CÓDIGO	📦	DISTRIB.	MAYOREO	LISTA
302911	20	\$79.00	\$113.00	\$139.00

Boquilla para bote de gas, 1/4 de vuelta

BLÍSTER

- ▶ Fabricada de latón
- ▶ Ajuste preciso de flama
- ▶ Encendido manual
- ▶ Con difusor de calor



FABRICADO EN LATÓN



CÓDIGO			DISTRIB.	MAYOREO	LISTA
124201	6	48	\$150.00	\$215.00	\$265.00

Boquilla para bote de gas, roscable

BLÍSTER

- ▶ Fabricada de latón
- ▶ Ajuste preciso de flama
- ▶ Encendido manual
- ▶ Con difusor de calor

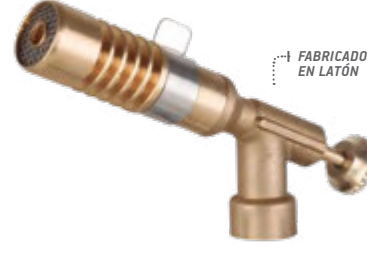

FABRICADO EN LATÓN



CÓDIGO			DISTRIB.	MAYOREO	LISTA
124202	6	48	\$150.00	\$215.00	\$265.00

Boquilla con encendido electrónico para lata, 1/4 de vuelta

PROX.

BLÍSTER

- ▶ Cuerpo de aluminio
- ▶ Ajuste preciso de flama
- ▶ Encendido instantáneo



CÓDIGO			DISTRIB.	MAYOREO	LISTA
124221	6	36	\$150.00	\$215.00	\$265.00

Boquilla con encendido electrónico para lata, roscable

PROX.

BLÍSTER

- ▶ Cuerpo de aluminio
- ▶ Ajuste preciso de flama
- ▶ Encendido instantáneo



CÓDIGO			DISTRIB.	MAYOREO	LISTA
124222	6	36	\$150.00	\$215.00	\$265.00

Mechero para bote de gas roscable y de 1/4 de vuelta

BLÍSTER

Entrada Roscable



Entrada 1/4 de vuelta

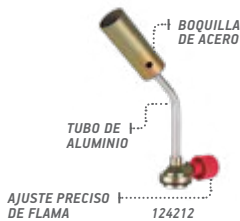

124212



124211



CÓDIGO	ENTRADA			DISTRIB.	MAYOREO	LISTA
124211	1/4 de vuelta	6	48	\$70.00	\$100.00	\$123.00
124212	Roscable	6	48	\$70.00	\$100.00	\$123.00

Cartuchos de gas

Encendedor y repuestos



119571 119572



124101

124109



CARTUCHO DE GAS CON VÁLVULA ROSCADA

CÓDIGO	CONTENIDO			DISTRIB.	MAYOREO	LISTA
119571	275 gr.	N/A	6	\$37.00	\$53.00	\$65.00

CARTUCHO DE GAS CON VÁLVULA 1/4 DE VUELTA

119572	220 gr.	6	24	\$37.00	\$53.00	\$65.00
--------	---------	---	----	---------	---------	---------

ENCENDEDOR TIPO CAZUELA Y REPUESTOS

CÓDIGO	PRODUCTO			DISTRIB.	MAYOREO	LISTA
124101	Encendedor	6	36	\$22.00	\$31.00	\$39.00
124109	Repuestos	N/A	300	\$14.00	\$20.00	\$24.70

Broca de alta velocidad dorada

CAJA PLÁSTICA

- ▶ Fabricada en acero alta velocidad que brinda mayor durabilidad
- ▶ Exactitud en su diámetro de corte



ángulo de corte



ángulo de corte



PRECIO POR BROCA

CÓDIGO	MEDIDA	ZANCO	ÁNGULO	PIEZAS X CAJA PLÁSTICA		DISTRIB.	MAYOREO	LISTA
100331	1/16"	●	118°	10	500	\$6.00	\$8.60	\$10.60
100332	5/64"	●	118°	10	500	\$6.00	\$8.60	\$10.60
100333	3/32"	●	118°	10	500	\$6.00	\$8.60	\$10.60
100334	7/64"	●	118°	10	500	\$7.00	\$10.00	\$12.30
100335	1/8"	●	118°	10	360	\$7.00	\$10.00	\$12.30
100336	9/64"	●	118°	10	360	\$9.00	\$12.90	\$15.90
100337	5/32"	●	118°	10	120	\$10.00	\$14.30	\$17.60
100338	11/64"	●	118°	10	100	\$12.00	\$17.10	\$21.20
100339	3/16"	▲	135°	10	100	\$14.00	\$20.00	\$24.70
100340	13/64"	▲	135°	10	100	\$17.00	\$24.30	\$30.00
100341	7/32"	▲	135°	10	100	\$19.00	\$27.00	\$34.00
100342	15/64"	▲	135°	10	50	\$21.00	\$30.00	\$37.00
100343	1/4"	▲	135°	10	50	\$23.00	\$33.00	\$41.00
100344	17/64"	▲	135°	10	40	\$27.00	\$39.00	\$48.00
100345	9/32"	▲	135°	10	40	\$30.00	\$43.00	\$53.00
100346	19/64"	▲	135°	5	48	\$35.00	\$50.00	\$62.00
100347	5/16"	▲	135°	5	48	\$38.00	\$54.00	\$67.00
100348	21/64"	▲	135°	5	48	\$44.00	\$63.00	\$78.00
100349	11/32"	▲	135°	5	48	\$49.00	\$70.00	\$86.00
100350	23/64"	▲	135°	5	48	\$53.00	\$76.00	\$93.00
100351	3/8"	▲	135°	5	48	\$57.00	\$81.00	\$101.00
100352	25/64"	▲	135°	5	48	\$65.00	\$93.00	\$115.00
100353	13/32"	▲	135°	5	48	\$73.00	\$104.00	\$129.00
100354	27/64"	▲	135°	5	48	\$89.00	\$127.00	\$155.00
100355	7/16"	▲	135°	5	48	\$91.00	\$130.00	\$160.00
100356	29/64"	▲	135°	5	48	\$94.00	\$134.00	\$165.00
100357	15/32"	▲	135°	5	48	\$105.00	\$150.00	\$185.00
100358	31/64"	▲	135°	5	48	\$115.00	\$165.00	\$205.00
100359	1/2"	▲	135°	5	40	\$120.00	\$170.00	\$210.00

Mínimo a surtir 1 caja plástica

Broca de alta velocidad dorada

BLÍSTER

- ▶ Fabricada en acero alta velocidad que brinda mayor durabilidad
- ▶ Exactitud en su diámetro de corte

ángulo de corte



ángulo de corte



CÓDIGO	MEDIDA	ZANCO	ÁNGULO			DISTRIB.	MAYOREO	LISTA
100373	3/32"	●	118°	6	48	\$9.00	\$12.90	\$15.90
100374	7/64"	●	118°	6	48	\$10.00	\$14.30	\$17.60
100375	1/8"	●	118°	6	48	\$10.00	\$14.30	\$17.60
100376	9/64"	●	118°	6	48	\$11.00	\$15.70	\$19.40
100377	5/32"	●	118°	6	48	\$12.00	\$17.10	\$21.20
100378	11/64"	●	118°	6	48	\$14.00	\$20.00	\$24.70
100379	3/16"	▲	135°	6	48	\$16.00	\$22.90	\$28.00
100381	7/32"	▲	135°	6	48	\$23.00	\$33.00	\$41.00
100383	1/4"	▲	135°	6	48	\$26.00	\$37.00	\$46.00
100387	5/16"	▲	135°	6	48	\$44.00	\$63.00	\$78.00
100391	3/8"	▲	135°	6	48	\$62.00	\$89.00	\$109.00
100395	7/16"	▲	135°	6	48	\$100.00	\$143.00	\$175.00
100399	1/2"	▲	135°	6	48	\$130.00	\$185.00	\$230.00

Broca de alta velocidad dorada

CAJA PLÁSTICA CON 1 BROCA

- ▶ Fabricada en acero alta velocidad que brinda mayor durabilidad
- ▶ Exactitud en su diámetro de corte
- ▶ Para broqueros de 1/2"



ángulo de corte



PRECIO POR BROCA

CÓDIGO	MEDIDA	ZANCO	ÁNGULO			DISTRIB.	MAYOREO	LISTA
100365	5/8"	▲	118°	25	50	\$215.00	\$305.00	\$380.00
100366	3/4"	▲	118°	25	50	\$295.00	\$420.00	\$520.00
100367	1"	▲	118°	25	50	\$455.00	\$650.00	\$805.00

Mínimo a surtir 1 caja plástica con 1 broca

Brocas para madera, juego de 8

BLÍSTER

- ▶ Fabricadas en acero al carbono
- ▶ Brocas incluidas: 1/8", 5/32", 3/16", 1/4", 9/32", 5/16", 7/32" y 3/8"



CÓDIGO			DISTRIB.	MAYOREO	LISTA
100531	6	72	\$54.00	\$77.00	\$95.00

Broca de alta velocidad

CAJA PLÁSTICA

- ▶ Fabricada en acero alta velocidad que brinda mayor durabilidad
- ▶ Exactitud en su diámetro de corte
- ▶ Zanco recto para mandriles universales



ángulo de corte



ángulo de corte



PRECIO POR BROCA

CÓDIGO	MEDIDA	ÁNGULO	PIEZAS X CAJA PLÁSTICA		DISTRIB.	MAYOREO	LISTA
100301	1/16"	118°	10	500	\$5.00	\$7.10	\$8.80
100302	5/64"	118°	10	500	\$5.00	\$7.10	\$8.80
100303	3/32"	118°	10	500	\$5.00	\$7.10	\$8.80
100304	7/64"	118°	10	500	\$6.00	\$8.60	\$10.60
100305	1/8"	118°	10	360	\$6.00	\$8.60	\$10.60
100306	9/64"	118°	10	360	\$7.00	\$10.00	\$12.30
100307	5/32"	118°	10	120	\$8.00	\$11.40	\$14.10
100308	11/64"	118°	10	100	\$9.00	\$12.90	\$15.90
100309	3/16"	135°	10	100	\$12.00	\$17.10	\$21.20
100310	13/64"	135°	10	100	\$13.00	\$18.60	\$22.90
100311	7/32"	135°	10	100	\$15.00	\$21.40	\$26.00
100312	15/64"	135°	10	50	\$18.00	\$26.00	\$32.00
100313	1/4"	135°	10	50	\$19.00	\$27.00	\$34.00
100314	17/64"	135°	10	40	\$21.00	\$30.00	\$37.00
100315	9/32"	135°	10	40	\$26.00	\$37.00	\$46.00
100316	19/64"	135°	5	48	\$29.00	\$41.00	\$51.00
100317	5/16"	135°	5	48	\$33.00	\$47.00	\$58.00
100318	21/64"	135°	5	48	\$37.00	\$53.00	\$65.00
100319	11/32"	135°	5	48	\$41.00	\$59.00	\$72.00
100320	23/64"	135°	5	48	\$46.00	\$66.00	\$81.00
100321	3/8"	135°	5	48	\$49.00	\$70.00	\$86.00
100322	25/64"	135°	5	48	\$56.00	\$80.00	\$99.00
100323	13/32"	135°	5	48	\$62.00	\$89.00	\$109.00
100324	27/64"	135°	5	48	\$73.00	\$104.00	\$129.00
100325	7/16"	135°	5	48	\$75.00	\$107.00	\$132.00
100326	29/64"	135°	5	48	\$78.00	\$111.00	\$138.00
100327	15/32"	135°	5	48	\$86.00	\$123.00	\$150.00
100328	31/64"	135°	5	48	\$94.00	\$134.00	\$165.00
100329	1/2"	135°	5	40	\$97.00	\$139.00	\$170.00

Mínimo a surtir 1 caja plástica

Broca para vidrio y azulejo

BLÍSTER

- ▶ Punta de carburo de tungsteno para un mejor barrenado
- ▶ Zanco recto para mandriles universales



CÓDIGO	MEDIDA			DISTRIB.	MAYOREO	LISTA
100501	1/8"	6	72	\$20.00	\$29.00	\$35.00
100502	3/16"	6	72	\$22.00	\$31.00	\$39.00
100503	1/4"	6	72	\$29.00	\$41.00	\$51.00
100504	5/16"	6	72	\$29.00	\$41.00	\$51.00
100505	3/8"	6	72	\$34.00	\$49.00	\$60.00
100506	1/2"	6	72	\$46.00	\$66.00	\$81.00

Brocas alta velocidad, juego de 5

BLÍSTER

- ▶ Brocas incluidas: 1/16", 3/32", 1/8", 3/16", 1/4"



CÓDIGO			DISTRIB.	MAYOREO	LISTA
100330	6	144	\$52.00	\$74.00	\$92.00

Broca de alta velocidad

CAJA PLÁSTICA CON 1 BROCA

- ▶ Fabricada en acero alta velocidad que brinda mayor durabilidad
- ▶ Exactitud en su diámetro de corte
- ▶ Zanco recto para mandriles universales



ángulo de corte



PRECIO POR BROCA

CÓDIGO	MEDIDA	ZANCO			DISTRIB.	MAYOREO	LISTA
100361	5/8"	▼	25	50	\$155.00	\$220.00	\$275.00
100362	3/4"	▼	25	50	\$240.00	\$345.00	\$425.00

Mínimo a surtir 1 caja plástica con 1 broca

Despachador para brocas de alta velocidad

- ▶ Fabricado en lámina de acero con mica frontal
- ▶ Incluye 4 cajones y 30 compartimentos
- ▶ No incluye brocas



El precio NO incluye los productos exhibidos

CÓDIGO	DISTRIB.	MAYOREO	LISTA
220429	\$1,900.00	\$2,715.00	\$3,350.00

Broca para concreto

CAJA PLÁSTICA O BLÍSTER

- ▶ Doble vía de enfriamiento y desalojo de material
- ▶ Punta de carburo de tungsteno para un mejor barrenado
- ▶ Zanco recto para mandriles universales

PRECIO POR CAJA PLÁSTICA O BLÍSTER



CAJA PLÁSTICA CON 10 BROCAS

PRECIO POR BROCA

CÓDIGO	MEDIDA		DISTRIB.	MAYOREO	LISTA
100415	1/8" x 4"	120	\$5.00	\$7.10	\$8.80
100401	3/16" x 4"	120	\$6.00	\$8.60	\$10.60
100402	1/4" x 4"	120	\$7.00	\$10.00	\$12.30
100403	1/4" x 6"	100	\$9.00	\$12.90	\$15.90
100404	1/4" x 12"	40	\$16.00	\$22.90	\$28.00
100405	5/16" x 4"	120	\$10.00	\$14.30	\$17.60
100406	5/16" x 6"	100	\$14.00	\$20.00	\$24.70
100407	5/16" x 12"	32	\$21.00	\$30.00	\$37.00
100408	3/8" x 5"	60	\$16.50	\$23.60	\$29.00
100409	3/8" x 6"	40	\$17.00	\$24.30	\$30.00
100410	3/8" x 12"	20	\$27.00	\$39.00	\$48.00
100411	1/2" x 6"	40	\$23.50	\$34.00	\$41.00
100412	1/2" x 12"	20	\$38.00	\$54.00	\$67.00

Mínimo a surtir: 1 caja plástica con 10 brocas

BLÍSTER CON 1 BROCA

PRECIO POR BLÍSTER

CÓDIGO	MEDIDA			DISTRIB.	MAYOREO	LISTA
100441	3/16" x 4"	6	72	\$8.00	\$11.40	\$14.10
100442	3/16" x 6"	6	72	\$9.00	\$12.90	\$15.90
100443	1/4" x 4"	6	72	\$9.00	\$12.90	\$15.90
100444	1/4" x 6"	6	72	\$12.00	\$17.10	\$21.20
100445	5/16" x 4"	6	72	\$13.00	\$18.60	\$22.90
100446	5/16" x 6"	6	72	\$16.00	\$22.90	\$28.00
100447	3/8" x 5"	6	72	\$18.00	\$26.00	\$32.00
100448	3/8" x 6"	6	72	\$20.00	\$29.00	\$35.00
100449	1/2" x 6"	6	72	\$25.00	\$36.00	\$44.00

Brocas para concreto, juego de 4 y 5

BLÍSTER

- ▶ Brocas incluidas juego 4 brocas: 3/16"x4", 1/4"x4", 5/16"x4" y 3/8"x5"
- ▶ Brocas incluidas juego 5 brocas: 3/16"x4", 1/4"x4", 5/16"x4", 1/4"x5" y 3/8"x5"



100413

100414



CÓDIGO			DISTRIB.	MAYOREO	LISTA
100413	6	96	\$32.00	\$46.00	\$56.00
100414	6	96	\$40.00	\$57.00	\$71.00

Broca para concreto X2 SDS

TARJETA PLÁSTICA

- ▶ Punta de cruz, de carburo de tungsteno
- ▶ Cuerpo de acero al cromo
- ▶ Zanco compatible con rotomartillos SDS



CÓDIGO	MEDIDA			DISTRIB.	MAYOREO	LISTA
100451	3/16" x 4"	10	300	\$18.00	\$26.00	\$32.00
100452	3/16" x 6"	10	200	\$19.00	\$27.00	\$34.00
100453	3/16" x 8"	10	150	\$24.00	\$34.00	\$42.00
100454	1/4" x 4"	10	300	\$19.00	\$27.00	\$34.00
100455	1/4" x 6"	10	200	\$20.00	\$29.00	\$35.00
100456	1/4" x 8"	10	150	\$25.00	\$36.00	\$44.00
100457	1/4" x 10"	10	150	\$30.00	\$43.00	\$53.00
100458	1/4" x 12"	10	100	\$33.00	\$47.00	\$58.00
100459	5/16" x 6"	10	200	\$24.00	\$34.00	\$42.00
100460	5/16" x 12"	10	100	\$39.00	\$56.00	\$69.00
100461	3/8" x 6"	10	150	\$31.00	\$44.00	\$55.00
100462	3/8" x 8"	10	150	\$36.00	\$51.00	\$64.00
100463	3/8" x 12"	10	100	\$44.00	\$63.00	\$78.00
100464	3/8" x 18"	10	60	\$57.00	\$81.00	\$101.00
100465	3/8" x 24"	10	60	\$70.00	\$100.00	\$123.00
100466	7/16" x 6"	10	150	\$34.00	\$49.00	\$60.00
100467	7/16" x 12"	10	100	\$47.00	\$67.00	\$83.00
100468	1/2" x 6"	10	150	\$45.00	\$64.00	\$79.00
100469	1/2" x 12"	10	100	\$60.00	\$86.00	\$106.00
100470	1/2" x 18"	10	40	\$85.00	\$121.00	\$150.00
100471	1/2" x 24"	10	40	\$100.00	\$143.00	\$175.00
100472	9/16" x 6"	10	150	\$55.00	\$79.00	\$97.00
100473	9/16" x 12"	10	50	\$70.00	\$100.00	\$123.00
100474	5/8" x 8"	10	60	\$75.00	\$107.00	\$132.00
100475	5/8" x 12"	10	50	\$90.00	\$129.00	\$160.00
100476	5/8" x 24"	10	20	\$130.00	\$185.00	\$230.00
100477	3/4" x 8"	5	60	\$108.00	\$155.00	\$190.00
100478	3/4" x 10"	5	40	\$110.00	\$155.00	\$195.00
100479	3/4" x 12"	5	40	\$125.00	\$180.00	\$220.00
100480	3/4" x 18"	5	20	\$135.00	\$195.00	\$240.00
100481	7/8" x 8"	5	40	\$125.00	\$180.00	\$220.00
100482	7/8" x 11"	5	40	\$140.00	\$200.00	\$245.00
100483	7/8" x 18"	5	20	\$185.00	\$265.00	\$325.00
100484	1" x 10"	5	40	\$165.00	\$235.00	\$290.00
100485	1" x 18"	5	20	\$225.00	\$320.00	\$395.00

Brocas y cinceles X2 SDS, juego de 15 piezas

NUEVO

MALETÍN

- ▶ 12 Brocas incluidas
- ▶ 3 Cinceles incluidos
- ▶ Estuche metálico

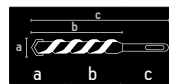

1/4"	2"	4"
1/4"		
5/16"	3 3/8"	6"
3/8"		
1/2"		
3/16"	5 1/2"	8"
1/4"		
5/8"	5 1/4"	
1/4"	7 1/4"	10"
5/16"		
3/8"	9"	12"
1/2"		



CUERPO DE ACERO
5140
PARA CONCRETO
PARA FABRICAR EN
CARBURO DE TUNGSTENO



CÓDIGO			DISTRIB.	MAYOREO	LISTA
100491	5	96	\$640.00	\$915.00	\$1,130.00

Cinzel SDS para rotomartillo

GRANEL

- ▶ Zanco 9/16" SDS
- ▶ Fabricados en acero al cromo



CÓDIGO	DESCRIPCIÓN	ANCHO	LARGO			DISTRIB.	MAYOREO	LISTA
100201	Cinzel de punta	---	10"	6	48	\$48.00	\$69.00	\$85.00
100202	Cinzel plano delgado	3/4"	10"	6	48	\$48.00	\$69.00	\$85.00
100203	Cinzel plano grueso	1 1/2"	10"	6	48	\$62.00	\$89.00	\$109.00
100204	Cinzel para azulejo	1 1/2"	10 1/2"	6	36	\$110.00	\$155.00	\$195.00
100205	Cinzel para acanalado	3/4"	10"	6	48	\$76.00	\$109.00	\$134.00

Adaptador SDS para rotomartillo 1/2"

NUEVO

BLÍSTER

- ▶ Fabricados en Acero al Cromo
- ▶ Convierte salida SDS a broquero convencional



CÓDIGO			DISTRIB.	MAYOREO	LISTA
100492	6	48	\$25.00	\$36.00	\$44.00

Broca plana de manita

BLÍSTER

- ▶ Fabricada en acero alto carbono
- ▶ Zanco hexagonal de 1/4", evita que se patine
- ▶ Sistema de ensamble rápido

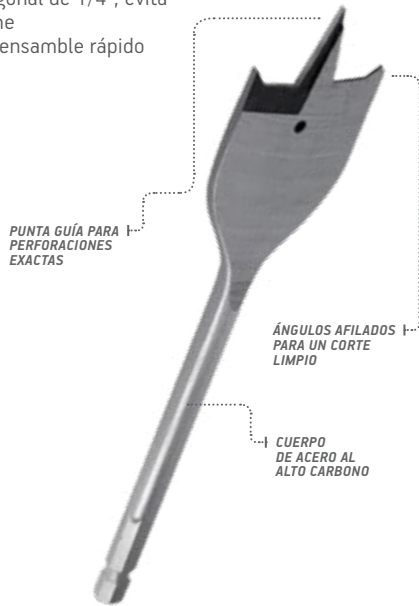

CÓDIGO	MEDIDA			DISTRIB.	MAYOREO	LISTA
100511	1/4"	6	72	\$18.00	\$26.00	\$32.00
100512	5/16"	6	72	\$19.00	\$27.00	\$34.00
100513	3/8"	6	72	\$19.00	\$27.00	\$34.00
100514	7/16"	6	72	\$20.00	\$29.00	\$35.00
100515	1/2"	6	72	\$20.00	\$29.00	\$35.00
100516	5/8"	6	72	\$21.00	\$30.00	\$37.00
100517	3/4"	6	72	\$22.00	\$31.00	\$39.00
100518	7/8"	6	72	\$23.50	\$34.00	\$41.00
100519	1"	6	72	\$26.00	\$37.00	\$46.00
100520	1 1/8"	6	72	\$29.00	\$41.00	\$51.00
100521	1 1/4"	6	72	\$32.00	\$46.00	\$56.00
100522	1 1/2"	6	72	\$36.00	\$51.00	\$64.00

Broquero con llave

BLÍSTER

- ▶ Broquero fabricado con mordazas en acero al cromo
- ▶ Llave fabricada en acero al carbono



CÓDIGO	MEDIDA			DISTRIB.	MAYOREO	LISTA
112201	1/2"	6	36	\$55.00	\$79.00	\$97.00
112209	3/8"	6	36	\$50.00	\$71.00	\$88.00

Llave para broquero

BLÍSTER

- ▶ Fabricado en acero al carbono



CÓDIGO	MEDIDA			DISTRIB.	MAYOREO	LISTA
112210	1/2"	12	72	\$15.00	\$21.40	\$26.00
112211	3/8"	12	72	\$13.00	\$18.60	\$22.90

Brocha profesional con mango de polipropileno



FAJILLA

- ▶ Cerda extra larga y abundante, deja un acabado fino
- ▶ Ideal para usar con todo tipo de pintura
- ▶ Mango macizo, inyectado en una sola pieza
- ▶ Alto rendimiento, uso profesional



Cerdas + largas



CÓDIGO	ANCHO	COLOR			DISTRIB.	MAYOREO	LISTA
111101	1/2"		6	72	\$6.00	\$8.60	\$10.60
111102	1"		6	72	\$9.00	\$12.90	\$15.90
111103	1 1/2"		6	72	\$12.00	\$17.10	\$21.20
111104	2"		6	72	\$15.00	\$21.40	\$26.00
111105	2 1/2"		6	72	\$18.00	\$26.00	\$32.00
111106	3"		6	72	\$25.00	\$36.00	\$44.00
111107	4"		6	72	\$43.00	\$61.00	\$76.00
111108	5"		6	72	\$59.00	\$84.00	\$104.00
111109	6"		6	72	\$68.00	\$97.00	\$120.00

Brocha con mango plástico



BOLSA

- ▶ Cerdas perfectamente adheridas al mango que no se desprenden



CÓDIGO	ANCHO			DISTRIB.	MAYOREO	LISTA
301501	1/2"	24	600	\$4.00	\$5.70	\$7.10
301502	1"	24	600	\$5.00	\$7.10	\$8.80
301503	1 1/2"	24	480	\$6.00	\$8.60	\$10.60
301504	2"	24	480	\$8.00	\$11.40	\$14.10
301505	2 1/2"	12	240	\$10.00	\$14.30	\$17.60
301506	3"	12	180	\$13.00	\$18.60	\$22.90
301507	4"	12	120	\$22.00	\$31.00	\$39.00
301508	5"	6	120	\$28.00	\$40.00	\$49.00
301509	6"	6	120	\$35.00	\$50.00	\$62.00

Brochas con mango plástico, 2 Pack y 3 Pack

BOLSA / CABALLETE

- ▶ Cerdas perfectamente adheridas al mango que no se desprenden



CÓDIGO	ANCHO			DISTRIB.	MAYOREO	LISTA
301514	1/2", 1" y 1 1/2"	12	60	\$15.00	\$21.40	\$26.00
301515	2" y 2 1/2"	12	60	\$18.00	\$26.00	\$32.00

NUEVO

Complemento

PISTOLA PARA PINTAR eléctrica 550 W

- Para pintura de agua o esmalte.
- De uso profesional en el hogar, talleres de pintura y hojalatería.
- Permite cubrir mayor superficie en tiempos cortos de operación.

Más detalles en: **Página 265**



NOM

1

Año de garantía

ESPECIFICACIONES TÉCNICAS

Tensión / frecuencia	127 V ~ / 60 Hz
Potencia	550 W
Corriente	4.5 A
Capacidad	800 ml
Flujo máximo	600 ml / min
Boquilla	∅ 2.5 cm

CÓDIGO		DISTRIB.	MAYOREO	LISTA
190651	10	\$700.00	\$1,000.00	\$1,235.00

NUEVO



Carrocerías



Llantas y rines



Faros

Lavado en seco

Shampoo con cera de carnauba

- ▶ Shampoo neutro con cera de carnauba para el lavado y encerado de su auto
- ▶ Altamente espumoso
- ▶ Fácil enjuague
- ▶ Remueve polvo, hollín, lodo, etc.
- ▶ Proporciona un acabado brillante
- ▶ Rendimiento aproximado:
500 ml - 20 lavadas / 1 litro - 40 lavadas



CARRÖK
MEXICO

CÓDIGO	PRESENTACIÓN		DISTRIB.	MAYOREO	LISTA
127401	500 ml	10	\$45.00	\$64.00	\$79.00
127402	1 L	10	\$70.00	\$100.00	\$123.00

Abrillantador de interiores

- ▶ Limpia la suciedad y el polvo
- ▶ Provee brillo y repelencia al agua sin ser una fórmula grasosa
- ▶ Protege de los rayos UV-B
- ▶ Previene grietas, decoloraciones y envejecimiento prematuro
- ▶ Uso en tablero, asientos de vinil, panel de puertas, consolas y molduras externas del vehículo



CARRÖK
MEXICO

CÓDIGO	PRESENTACIÓN		DISTRIB.	MAYOREO	LISTA
127411	500 ml	10	\$65.00	\$93.00	\$115.00

Gel negro abrillantador

- ▶ Provee un brillo profundo e intensifica el color negro del neumático
- ▶ Excelente durabilidad
- ▶ Resina fijadora que actúa como película protectora



CARRÖK
MEXICO

CÓDIGO	PRESENTACIÓN		DISTRIB.	MAYOREO	LISTA
127421	500 ml	10	\$55.00	\$79.00	\$97.00

Cera líquida de carnauba

- ▶ Nueva fórmula que permite la limpieza del vehículo y la restauración del brillo original
- ▶ Protege de los rayos UV-B
- ▶ La cera de carnauba proporciona un brillo duradero
- ▶ Reduce la adherencia de suciedad en la superficie



CARRÖK
MEXICO

CÓDIGO	PRESENTACIÓN		DISTRIB.	MAYOREO	LISTA
127431	500 ml	10	\$55.00	\$79.00	\$97.00

Limpiador de vidrios

- ▶ Fórmula que proporciona brillo cristalino
- ▶ Secado rápido
- ▶ Alta humectación sin dejar residuos
- ▶ Protege de la suciedad en carretera
- ▶ Excelente para la limpieza de espejos y faros



CARRÖK
MEXICO

CÓDIGO	PRESENTACIÓN		DISTRIB.	MAYOREO	LISTA
127441	500 ml	10	\$37.00	\$53.00	\$65.00

Desengrasante para autos

- ▶ Limpiador y desengrasante multiusos
- ▶ Fórmula a base de agua
- ▶ Disuelve y elimina la grasa sin esfuerzo
- ▶ Excelente en carrocería



CARRÖK
MEXICO

CÓDIGO	PRESENTACIÓN		DISTRIB.	MAYOREO	LISTA
127451	500 ml	10	\$48.00	\$69.00	\$85.00

Lavado en seco

NUEVO

- ▶ Limpieza en seco
- ▶ Acabado tipo encerado
- ▶ Encapsula la suciedad sin rayar
- ▶ Lava, encera y protege tu automóvil



CARRÖK
MEXICO

CÓDIGO	PRESENTACIÓN		DISTRIB.	MAYOREO	LISTA
127403	500 ml	10	\$65.00	\$93.00	\$115.00

Impermeabilizante de textiles

PROX.

- ▶ Ayuda a repeler líquidos de los textiles
- ▶ No modifica el aspecto, la sensación al tacto ni la respiración de las telas
- ▶ Ideal para proteger el tapizado del automóvil



CARRÖK
MEXICO

CÓDIGO	PRESENTACIÓN		DISTRIB.	MAYOREO	LISTA
127465	500 ml	10	\$280.00	\$400.00	\$495.00

Toalla super absorbente

FAJILLA

- ▶ Microfibra profesional
- ▶ Ultra suave, antirayaduras
- ▶ Ideal para secar
- ▶ Super absorbente
- ▶ No desprende pelusa



CÓDIGO	TAMAÑO	FAJILLA	DISTRIB.	MAYOREO	LISTA
125305	40 x 40 cm	24	\$48.00	\$69.00	\$85.00

Toalla para secar

FAJILLA

- ▶ Microfibra profesional
- ▶ Ultra suave, antirayaduras
- ▶ Ideal para pulir, encerar o secar
- ▶ Fibras de poliéster y poliamida
- ▶ No desprende pelusa

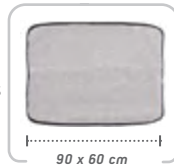

CÓDIGO	TAMAÑO	FAJILLA	DISTRIB.	MAYOREO	LISTA
125306	90 x 60 cm	24	\$53.00	\$76.00	\$93.00

Guante de microfibra

FAJILLA

- ▶ Alta capacidad de absorción
- ▶ Ideal para detallar tu auto o para uso en el hogar en superficies sensibles
- ▶ No deja rayones
- ▶ Fácil de lavar



CÓDIGO	TAMAÑO	FAJILLA	DISTRIB.	MAYOREO	LISTA
125307	21 x 27 cm	24	\$60.00	\$86.00	\$106.00

Toalla de microfibra

BOLSA

- ▶ Máxima absorción
- ▶ Compacta
- ▶ Fácil de lavar
- ▶ Se seca en muy poco tiempo

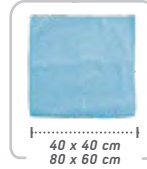

CÓDIGO	TAMAÑO	FAJILLA	DISTRIB.	MAYOREO	LISTA
125302	40 x 40 cm	96	\$13.00	\$18.60	\$22.90
125303	80 x 60 cm	30	\$30.00	\$43.00	\$53.00

Toalla de microfibra 3 pack

BOLSA

- ▶ Máxima absorción
- ▶ Compacta
- ▶ Fácil de lavar
- ▶ Se seca en muy poco tiempo

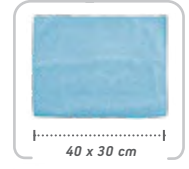

CÓDIGO	TAMAÑO	FAJILLA	DISTRIB.	MAYOREO	LISTA
125304	40 x 30 cm	100	\$30.00	\$43.00	\$53.00

NUEVA LÍNEA

Conoce la nueva colección AKSI® Clean



CÓDIGO	USO	PRESENTACIÓN	FAJILLA	DISTRIB.	MAYOREO	LISTA
127455	Desengrasante para asadores	1 litro	10	\$89.00	\$127.00	\$155.00
127461	Jabón desengrasante y exfoliante para manos	1 litro	10	\$120.00	\$170.00	\$210.00
127462	Jabón desengrasante y exfoliante para manos	500 ml	10	\$75.00	\$107.00	\$132.00
127463	Crema exfoliante desengrasante para manos	1 litro	10	\$135.00	\$195.00	\$240.00
127464	Crema exfoliante desengrasante para manos	500 ml	10	\$79.00	\$113.00	\$139.00
127466	Impermeabilizante de telas	500 ml	10	\$280.00	\$400.00	\$495.00

Cepillo lavacoches

GRANEL

- ▶ Ideal para la limpieza de interiores, tapetes y neumáticos



CÓDIGO	FAJILLA	DISTRIB.	MAYOREO	LISTA
800191	10	\$90.00	\$129.00	\$160.00

Jalador con esponja

GRANEL

- ▶ Práctico limpiador para vidrios de casa y automóvil
- ▶ Con paleta aplicador y limpiador de goma



CÓDIGO	FAJILLA	DISTRIB.	MAYOREO	LISTA
800301	24	\$40.00	\$57.00	\$71.00



REFORZANDO TU SEGURIDAD



APERTURA DE PUERTA

Las puertas se caracterizan por su tipo de apertura, ya sea a la derecha o a la izquierda, dependiendo de ello existen cerraduras especiales para cada una.



Apertura izquierda



Apertura derecha

Cerradura de sobreponer llave tradicional / fácil instalación

BASIC

BLÍSTER / CAJA

- ▶ Cilindro de latón sólido
- ▶ Útil en puertas de metal y madera
- ▶ Picaporte con botón de seguridad
- ▶ Incluye tornillería de instalación
- ▶ Incluye 3 llaves



CILINDRO ENSAMBLADO A LA CERRADURA

25 años GARANTÍA

SEGURIDAD ACS

CÓDIGO	INSTALACIÓN	EMPAQUE			DISTRIB.	MAYOREO	LISTA
114503	Izquierda	Blister	3	12	\$165.00	\$235.00	\$290.00
114504	Derecha	Blister	3	12	\$165.00	\$235.00	\$290.00
114501	Izquierda	Caja	6	24	\$150.00	\$215.00	\$265.00
114502	Derecha	Caja	6	24	\$150.00	\$215.00	\$265.00

Cerradura de sobreponer llave tetra / fácil instalación

BASIC

PROX.

CAJA

- ▶ Cilindro de latón sólido
- ▶ Útil en puertas de metal y madera
- ▶ Picaporte con botón de seguridad
- ▶ Incluye tornillería de instalación
- ▶ Incluye 3 llaves tetra



LLAVE TETRA

25 años GARANTÍA

SEGURIDAD ACS

CÓDIGO	INSTALACIÓN	EMPAQUE			DISTRIB.	MAYOREO	LISTA
114505	Izquierda	Caja	6	24	\$240.00	\$345.00	\$425.00
114506	Derecha	Caja	6	24	\$240.00	\$345.00	\$425.00

Cerradura de barra fija llave tradicional

BASIC

BLÍSTER / CAJA

- ▶ Cilindro de latón sólido
- ▶ Útil en puertas de metal y madera
- ▶ Incluye tornillería de instalación
- ▶ Incluye 3 llaves

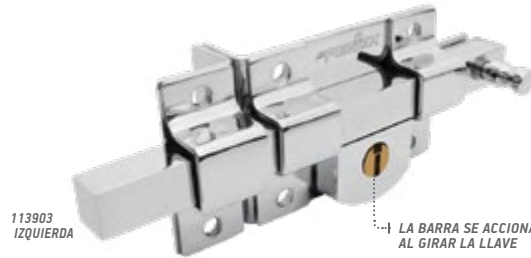

113903 IZQUIERDA

PROX.



BLÍSTER

CÓDIGO	ACABADO	INSTALACIÓN			DISTRIB.	MAVOREO	LISTA
113903	Cromo	Izquierda	3	12	\$215.00	\$305.00	\$380.00
113904	Cromo	Derecha	3	12	\$215.00	\$305.00	\$380.00

CAJA

CÓDIGO	ACABADO	INSTALACIÓN			DISTRIB.	MAVOREO	LISTA
113901	Cromo	Izquierda	6	24	\$160.00	\$230.00	\$280.00
113902	Cromo	Derecha	6	24	\$160.00	\$230.00	\$280.00

Cerradura de barra fija llave tetra

BASIC

PROX.

CAJA

- ▶ Cilindro de latón sólido
- ▶ Útil en puertas de metal y madera
- ▶ Incluye tornillería de instalación
- ▶ Incluye 3 llaves tetra



113907 IZQUIERDA



LLAVE TETRA



TIPOS DE BARRA

BARRA FIJA:

La barra se acciona al girar la llave, tanto del interior como del exterior.

BARRA LIBRE:

Se acciona cuando se gira la llave desde el exterior, pero en el interior puede deslizarse con la mano, siempre y cuando la llave esté insertada.

Cerradura de barra libre llave tradicional

BASIC

PROX.

CAJA

- ▶ Cilindro de latón sólido
- ▶ Útil en puertas de metal y madera
- ▶ Incluye tornillería de instalación
- ▶ Incluye 3 llaves



113905 IZQUIERDA



Cerradura de barra libre llave tetra

BASIC

PROX.

CAJA

- ▶ Cilindro de latón sólido
- ▶ Útil en puertas de metal y madera
- ▶ Incluye tornillería de instalación
- ▶ Incluye 3 llaves tetra



LLAVE TETRA



CÓDIGO	ACABADO	INSTALACIÓN			DISTRIB.	MAVOREO	LISTA
113905	Cromo	Izquierda	6	24	\$160.00	\$230.00	\$280.00
113906	Cromo	Derecha	6	24	\$160.00	\$230.00	\$280.00

CÓDIGO	ACABADO	INSTALACIÓN			DISTRIB.	MAVOREO	LISTA
113909	Cromo	Izquierda	6	24	\$220.00	\$315.00	\$390.00
113910	Cromo	Derecha	6	24	\$220.00	\$315.00	\$390.00

Cerrojo doble cilindro



BLÍSTER

- ▶ Cilindro de zamak con 5 pernos de combinación
- ▶ Cerrojo con perno de acero endurecido anti segueta
- ▶ Incluye tornillería de instalación
- ▶ Incluye 2 llaves



CÓDIGO	DESCRIPCIÓN			DISTRIB.	MAYOREO	LISTA
307201	Latón brillante	4	24	\$135.00	\$195.00	\$240.00
307202	Latón antiguo	4	24	\$135.00	\$195.00	\$240.00
307203	Cromo mate	4	24	\$135.00	\$195.00	\$240.00



18 meses GARANTÍA

IT MAXTOOL

IDEAL PARA COLOCAR EN LA PUERTA PRINCIPAL

Cerrojo cilindro - mariposa



BLÍSTER

- ▶ Cilindro de zamak con 5 pernos de combinación
- ▶ Cerrojo con perno de acero anti segueta
- ▶ Incluye tornillería de instalación
- ▶ Incluye 2 llaves



CÓDIGO	DESCRIPCIÓN			DISTRIB.	MAYOREO	LISTA
307204	Latón brillante	4	24	\$115.00	\$165.00	\$205.00
307205	Latón antiguo	4	24	\$115.00	\$165.00	\$205.00
307206	Cromo mate	4	24	\$115.00	\$165.00	\$205.00



18 meses GARANTÍA

IT MAXTOOL

IDEAL PARA COLOCAR EN LA PUERTA PRINCIPAL

Cerradura de entrada principal gatillo-perilla y cerrojo doble cilindro

CAJA

- ▶ Cilindro de latón sólido
- ▶ Cerrojo con perno de acero anti segueta
- ▶ Incluye tornillería de instalación
- ▶ Incluye 3 llaves



CÓDIGO	DESCRIPCIÓN		DISTRIB.	MAYOREO	LISTA
113961	Latón brillante	4	\$750.00	\$1,070.00	\$1,325.00
113962	Latón antiguo	4	\$750.00	\$1,070.00	\$1,325.00
113963	Cromo mate	4	\$750.00	\$1,070.00	\$1,325.00



25 años GARANTÍA

SEGURIDAD

IDEAL PARA COLOCAR EN LA PUERTA PRINCIPAL

BASIC

Cerradura de pomo

CAJA / BLÍSTER

- ▶ Mecanismo cilíndrico
- ▶ Incluye tornillería de instalación
- ▶ Incluye 2 llaves



12 meses GARANTÍA

IT MAXTOOL

CERRADURA EN CAJA

CÓDIGO	ACABADO	USO			DISTRIB.	MAYOREO	LISTA
307121	Latón brillante	Entrada	6	36	\$86.00	\$123.00	\$150.00
307122	Latón brillante	Recámara	6	36	\$86.00	\$123.00	\$150.00
307123	Latón brillante	Baño	6	36	\$85.00	\$121.00	\$150.00
307124	Latón antiguo	Entrada	6	36	\$86.00	\$123.00	\$150.00
307125	Latón antiguo	Recámara	6	36	\$86.00	\$123.00	\$150.00
307126	Latón antiguo	Baño	6	36	\$85.00	\$121.00	\$150.00
307127	Cromo mate	Entrada	6	36	\$86.00	\$123.00	\$150.00
307128	Cromo mate	Recámara	6	36	\$86.00	\$123.00	\$150.00
307129	Cromo mate	Baño	6	36	\$85.00	\$121.00	\$150.00

CERRADURA EN BLÍSTER

CÓDIGO	ACABADO	USO			DISTRIB.	MAYOREO	LISTA
307101	Latón brillante	Entrada	6	36	\$95.00	\$136.00	\$170.00
307102	Latón brillante	Recámara	6	36	\$95.00	\$136.00	\$170.00
307103	Latón brillante	Baño	6	36	\$90.00	\$129.00	\$160.00
307104	Latón antiguo	Entrada	6	36	\$95.00	\$136.00	\$170.00
307105	Latón antiguo	Recámara	6	36	\$95.00	\$136.00	\$170.00
307106	Latón antiguo	Baño	6	36	\$90.00	\$129.00	\$160.00
307107	Cromo mate	Entrada	6	36	\$95.00	\$136.00	\$170.00
307108	Cromo mate	Recámara	6	36	\$95.00	\$136.00	\$170.00
307109	Cromo mate	Baño	6	36	\$90.00	\$129.00	\$160.00

Pasador para puerta con cadena

STONE

BLÍSTER

- ▶ Aleación metálica
- ▶ Con botón de resorte
- ▶ Incluye tornillería de instalación

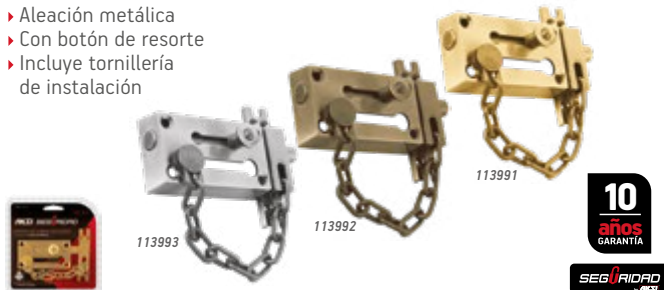

10 años GARANTÍA

SEGURO RIDRO

CÓDIGO	ACABADO			DISTRIB.	MAYOREO	LISTA
113991	Latón brillante	6	36	\$115.00	\$165.00	\$205.00
113992	Latón antiguo	6	36	\$115.00	\$165.00	\$205.00
113993	Cromo mate	6	36	\$115.00	\$165.00	\$205.00

Pasador de barra plana

STONE

BLÍSTER

- ▶ Fabricados en acero
- ▶ Botón con cuerda
- ▶ Incluye tornillería de instalación

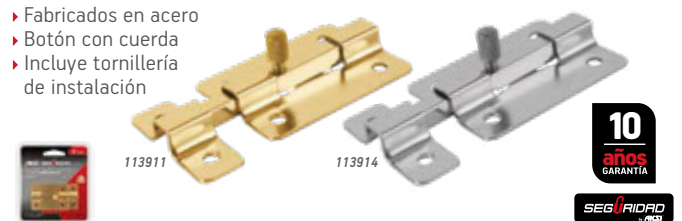

10 años GARANTÍA

SEGURO RIDRO

CÓDIGO	MEDIDA	ACABADO			DISTRIB.	MAYOREO	LISTA
113911	2"	Latón brillante	6	36	\$25.00	\$36.00	\$44.00
113912	3"	Latón brillante	6	36	\$35.00	\$50.00	\$62.00
113913	4"	Latón brillante	6	36	\$50.00	\$71.00	\$88.00
113914	2"	Cromo brillante	6	36	\$25.00	\$36.00	\$44.00
113915	3"	Cromo brillante	6	36	\$35.00	\$50.00	\$62.00
113916	4"	Cromo brillante	6	36	\$50.00	\$71.00	\$88.00

Portacandado de acero galvanizado

BASIC

CABALLETE

- ▶ Fabricados en acero al carbono
- ▶ Acabado galvanizado
- ▶ Incluye tornillería de instalación
- ▶ Estructura de gran resistencia



10 años GARANTÍA

SEGURO RIDRO

CÓDIGO	MEDIDA			DISTRIB.	MAYOREO	LISTA
106706	1 3/4"	6	72	\$10.00	\$14.30	\$17.60
106707	2 1/2"	6	72	\$15.00	\$21.40	\$26.00
106708	3 1/4"	6	72	\$22.00	\$31.00	\$39.00
106709	4 1/2"	6	72	\$24.00	\$34.00	\$42.00

Pasador para puerta abatible

BASIC

BLÍSTER

- ▶ Aleación metálica
- ▶ Incluye tornillería de instalación



10 años GARANTÍA

SEGURO RIDRO

CÓDIGO	ACABADO			DISTRIB.	MAYOREO	LISTA
113994	Latón brillante	6	36	\$75.00	\$107.00	\$132.00
113995	Latón antiguo	6	36	\$75.00	\$107.00	\$132.00
113996	Cromo mate	6	36	\$75.00	\$107.00	\$132.00

Bisagra bidimensional 110°

BOLSA

- Bisagra oculta para gabinete
- Juego de 2 bisagras
- Fabricadas en acero
- Cierre automático
- Incluye tornillería de instalación

2
pzas.



CÓDIGO	COBERTURA		DISTRIB.	MAYOREO	LISTA
106502	Completa	50	\$16.00	\$22.90	\$28.00
106504	Media	50	\$16.00	\$22.90	\$28.00
106506	Interna	50	\$16.00	\$22.90	\$28.00

Bisagra rectangular con perno remachado, latonada

CAJA

- Cuerpo de acero
- Incluye tornillería de instalación
- Perno remachado



PRECIO POR PIEZA

CÓDIGO	MEDIDA		DISTRIB.	MAYOREO	LISTA
106411	1" x 15/16"	10 pzas x caja 10 cajas	\$2.40	\$3.40	\$4.20
106412	1 1/2" x 1 3/16"	10 pzas x caja 10 cajas	\$3.40	\$4.90	\$6.00
106413	2" x 1 1/2"	10 pzas x caja 10 cajas	\$4.60	\$6.60	\$8.10
106414	2 1/2" x 1 11/16"	10 pzas x caja 10 cajas	\$6.00	\$8.60	\$10.60
106415	3" x 2"	10 pzas x caja 10 cajas	\$9.00	\$12.90	\$15.90
106416	3 1/2" x 2 5/32"	10 pzas x caja 10 cajas	\$12.00	\$17.10	\$21.20
106417	4" x 2 7/8"	10 pzas x caja 10 cajas	\$15.00	\$21.40	\$26.00

Mínimo a surtir 1 caja con 10 piezas

Bisagra rectangular con perno remachado, acero pulido

CAJA

- Cuerpo de acero
- NO incluye tornillería de instalación
- Perno remachado



PRECIO POR PIEZA

CÓDIGO	MEDIDA		DISTRIB.	MAYOREO	LISTA
106418	1" x 15/16"	10 pzas x caja 10 cajas	\$2.00	\$2.90	\$3.50
106419	1 1/2" x 1 3/16"	10 pzas x caja 10 cajas	\$2.40	\$3.40	\$4.20
106420	2" x 1 1/2"	10 pzas x caja 10 cajas	\$3.20	\$4.60	\$5.60
106421	2 1/2" x 1 11/16"	10 pzas x caja 10 cajas	\$4.00	\$5.70	\$7.10
106422	3" x 2"	10 pzas x caja 10 cajas	\$5.80	\$8.30	\$10.20
106423	3 1/2" x 2 5/32"	10 pzas x caja 10 cajas	\$8.00	\$11.40	\$14.10
106424	4" x 2 7/8"	10 pzas x caja 10 cajas	\$11.00	\$15.70	\$19.40

Mínimo a surtir 1 caja con 10 piezas

Bisagra cuadrada cabeza redonda latón antiguo

CAJA

- Cuerpo de acero
- Incluye tornillería de instalación
- Perno suelto con cabeza redonda



PRECIO POR PIEZA

CÓDIGO	MEDIDA		DISTRIB.	MAYOREO	LISTA
106425	2" x 2"	10 pzas x caja 10 cajas	\$11.00	\$15.70	\$19.40
106426	2 1/2" x 2 1/2"	10 pzas x caja 10 cajas	\$14.00	\$20.00	\$24.70
106427	3" x 3"	10 pzas x caja 10 cajas	\$16.00	\$22.90	\$28.00
106428	3 1/2" x 3 1/2"	10 pzas x caja 10 cajas	\$22.00	\$31.00	\$39.00
106429	4" x 4"	10 pzas x caja 10 cajas	\$27.00	\$39.00	\$48.00

Mínimo a surtir 1 caja con 10 piezas

Bisagra cuadrada cabeza redonda latonada

CAJA

- Cuerpo de acero
- Incluye tornillería de instalación
- Perno suelto con cabeza redonda



PRECIO POR PIEZA

CÓDIGO	MEDIDA		DISTRIB.	MAYOREO	LISTA
106406	2" x 2"	10 pzas x caja 10 cajas	\$11.00	\$15.70	\$19.40
106407	2 1/2" x 2 1/2"	10 pzas x caja 10 cajas	\$14.00	\$20.00	\$24.70
106408	3" x 3"	10 pzas x caja 10 cajas	\$16.00	\$22.90	\$28.00
106409	3 1/2" x 3 1/2"	10 pzas x caja 10 cajas	\$22.00	\$31.00	\$39.00
106410	4" x 4"	10 pzas x caja 10 cajas	\$27.00	\$39.00	\$48.00

Mínimo a surtir 1 caja con 10 piezas

Bisagra cuadrada cabeza redonda cromo mate

CAJA

- Cuerpo de acero
- Incluye tornillería de instalación
- Perno suelto con cabeza redonda



PRECIO POR PIEZA

CÓDIGO	MEDIDA		DISTRIB.	MAYOREO	LISTA
106435	2" x 2"	10 pzas x caja 10 cajas	\$11.00	\$15.70	\$19.40
106436	2 1/2" x 2 1/2"	10 pzas x caja 10 cajas	\$14.00	\$20.00	\$24.70
106437	3" x 3"	10 pzas x caja 10 cajas	\$16.00	\$22.90	\$28.00
106438	3 1/2" x 3 1/2"	10 pzas x caja 10 cajas	\$22.00	\$31.00	\$39.00
106439	4" x 4"	10 pzas x caja 10 cajas	\$27.00	\$39.00	\$48.00

Mínimo a surtir 1 caja con 10 piezas

Bisagra cuadrada cabeza plana latón antiguo

CAJA

- Cuerpo de acero
- Incluye tornillería de instalación
- Perno suelto con cabeza plana



PRECIO POR PIEZA

CÓDIGO	MEDIDA		DISTRIB.	MAYOREO	LISTA
106430	2" x 2"	10 pzas x caja 10 cajas	\$11.00	\$15.70	\$19.40
106431	2 1/2" x 2 1/2"	10 pzas x caja 10 cajas	\$14.00	\$20.00	\$24.70
106432	3" x 3"	10 pzas x caja 10 cajas	\$16.00	\$22.90	\$28.00
106433	3 1/2" x 3 1/2"	10 pzas x caja 10 cajas	\$22.00	\$31.00	\$39.00
106434	4" x 4"	10 pzas x caja 10 cajas	\$27.00	\$39.00	\$48.00

Mínimo a surtir 1 caja con 10 piezas

Bisagra cuadrada cabeza plana latonada

CAJA

- Cuerpo de acero
- Incluye tornillería de instalación
- Perno suelto con cabeza plana



PRECIO POR PIEZA

CÓDIGO	MEDIDA		DISTRIB.	MAYOREO	LISTA
106401	2" x 2"	10 pzas x caja 10 cajas	\$11.00	\$15.70	\$19.40
106402	2 1/2" x 2 1/2"	10 pzas x caja 10 cajas	\$14.00	\$20.00	\$24.70
106403	3" x 3"	10 pzas x caja 10 cajas	\$16.00	\$22.90	\$28.00
106404	3 1/2" x 3 1/2"	10 pzas x caja 10 cajas	\$22.00	\$31.00	\$39.00
106405	4" x 4"	10 pzas x caja 10 cajas	\$27.00	\$39.00	\$48.00

Mínimo a surtir 1 caja con 10 piezas

Bisagra cuadrada cabeza plana cromo mate

CAJA

- Cuerpo de acero
- Incluye tornillería de instalación
- Perno suelto con cabeza plana



PRECIO POR PIEZA

CÓDIGO	MEDIDA		DISTRIB.	MAYOREO	LISTA
106440	2" x 2"	10 pzas x caja 10 cajas	\$11.00	\$15.70	\$19.40
106441	2 1/2" x 2 1/2"	10 pzas x caja 10 cajas	\$14.00	\$20.00	\$24.70
106442	3" x 3"	10 pzas x caja 10 cajas	\$16.00	\$22.90	\$28.00
106443	3 1/2" x 3 1/2"	10 pzas x caja 10 cajas	\$22.00	\$31.00	\$39.00
106444	4" x 4"	10 pzas x caja 10 cajas	\$27.00	\$39.00	\$48.00

Mínimo a surtir 1 caja con 10 piezas

Cerradura de vitrina

CAJA

- ▶ Cuerpo y cilindro de aleación metálica
- ▶ Incluye 2 llaves



CÓDIGO	ACABADO	12	96	DISTRIB.	MAYOREO	LISTA
303601	Cromo	12	96	\$35.00	\$50.00	\$62.00

Cerradura para mueble

CAJA

- ▶ Cilindro sistema de teclas
- ▶ Incluye tornillería de instalación
- ▶ Incluye 2 llaves



CÓDIGO	ACABADO	12	144	DISTRIB.	MAYOREO	LISTA
303602	Cromo	12	144	\$23.00	\$33.00	\$41.00
303603	Latón	12	144	\$23.00	\$33.00	\$41.00

Mirilla de seguridad

BASIC

BLÍSTER

- ▶ Fabricadas en latón
- ▶ Para puertas con espesor de 1 3/8" a 2 3/16"



CÓDIGO	ACABADO	6	36	DISTRIB.	MAYOREO	LISTA
113921	Latón brillante	6	36	\$60.00	\$86.00	\$106.00
113922	Latón antiguo	6	36	\$60.00	\$86.00	\$106.00
113923	Cromo mate	6	36	\$60.00	\$86.00	\$106.00

Tope para puerta tipo recto BASIC

BLÍSTER

- ▶ Aleación metálica
- ▶ Goma protectora



CÓDIGO	ACABADO	6	36	DISTRIB.	MAYOREO	LISTA
113981	Latón brillante	6	36	\$34.00	\$49.00	\$60.00
113982	Cromado	6	36	\$34.00	\$49.00	\$60.00

Tope para puerta tipo codo STONE

BLÍSTER

- ▶ Aleación metálica
- ▶ Goma protectora
- ▶ Incluye tornillería de instalación



CÓDIGO	ACABADO	6	36	DISTRIB.	MAYOREO	LISTA
113985	Latón brillante	6	36	\$38.00	\$54.00	\$67.00
113986	Cromado	6	36	\$38.00	\$54.00	\$67.00

Tope para puerta tipo domo BASIC

BLÍSTER

- ▶ Aleación metálica
- ▶ Goma protectora
- ▶ Incluye tornillería de instalación



CÓDIGO	ACABADO	6	36	DISTRIB.	MAYOREO	LISTA
113983	Latón brillante	6	36	\$35.00	\$50.00	\$62.00
113984	Cromado satinado	6	36	\$35.00	\$50.00	\$62.00

Candado de hierro para cortina con llave de puntos

PROX.

BLÍSTER

- ▶ Cilindro de latón
- ▶ Gancho de acero resistente al corte
- ▶ Incluye 3 llaves



CÓDIGO	TAMAÑO	SEGURIDAD	6	36	DISTRIB.	MAYOREO	LISTA
112711	70 mm	Alta	6	36	\$95.00	\$136.00	\$170.00
112712	80 mm	Alta	6	36	\$105.00	\$150.00	\$185.00
112713	90 mm	Alta	6	36	\$115.00	\$165.00	\$205.00

Candado de latón sólido anti palanca 75 mm

CAJA / BLÍSTER

- ▶ Incluye 3 llaves
- ▶ Para cortina metálica
- ▶ Cuerpo de latón
- ▶ Llave tradicional



CÓDIGO	SEGURIDAD	6	36	DISTRIB.	MAYOREO	LISTA
112702	Alta	6	36	\$230.00	\$330.00	\$405.00

BLÍSTER

CÓDIGO	SEGURIDAD	4	24	DISTRIB.	MAYOREO	LISTA
112701	Alta	4	24	\$240.00	\$345.00	\$425.00

Candado de hierro anti palanca 70 mm

BLÍSTER

- ▶ Incluye 2 llaves
- ▶ Para cortina metálica
- ▶ Cuerpo de hierro
- ▶ Llave tradicional



CÓDIGO	SEGURIDAD	6	36	DISTRIB.	MAYOREO	LISTA
305111	Alta	6	36	\$75.00	\$107.00	\$132.00

Candado laminado

BLÍSTER

- ▶ Cuerpo laminado
- ▶ Gancho fabricado en acero con doble cerrojo
- ▶ Cilindro de latón sólido
- ▶ Incluye 2 llaves



18
meses
GARANTÍA

IT MAXTOOL

CÓDIGO	TAMAÑO	6	36	DISTRIB.	MAYOREO	LISTA
305101	30 mm	6	36	\$30.00	\$43.00	\$53.00
305102	40 mm	6	36	\$40.00	\$57.00	\$71.00
305103	50 mm	6	36	\$50.00	\$71.00	\$88.00

Candado de hierro

BLÍSTER / CAJA

- ▶ Cuerpo de hierro, gran resistencia y durabilidad
- ▶ Pernos de latón sólido
- ▶ Incluye 2 llaves



18
meses
GARANTÍA

IT MAXTOOL

CÓDIGO	TAMAÑO	SEGURIDAD	6	36	DISTRIB.	MAYOREO	LISTA
305123	30 mm	3	6	36	\$20.00	\$29.00	\$35.00
305124	40 mm	3	6	36	\$25.00	\$36.00	\$44.00
305125	50 mm	3	6	36	\$39.00	\$56.00	\$69.00

CAJA

CÓDIGO	TAMAÑO	SEGURIDAD	6	36	DISTRIB.	MAYOREO	LISTA
305120	30 mm	3	10	60	\$15.00	\$21.40	\$26.00
305121	40 mm	3	10	60	\$19.00	\$27.00	\$34.00
305122	50 mm	3	10	60	\$32.00	\$46.00	\$56.00

Candado de hierro con llave anti gonzúa

PROX.

BLÍSTER

- ▶ Cuerpo de hierro
- ▶ Gancho de acero resistente al corte
- ▶ Seguro tipo perno
- ▶ Incluye 4 llaves



10
años
GARANTÍA

SEGURIDAD
+30

CÓDIGO	TAMAÑO	SEGURIDAD	6	48	DISTRIB.	MAYOREO	LISTA
108331	40 mm	5	6	48	\$80.00	\$114.00	\$141.00
108332	50 mm	6	6	36	\$90.00	\$129.00	\$160.00
108333	60 mm	6	6	36	\$100.00	\$143.00	\$175.00
108334	70 mm	6	6	36	\$120.00	\$170.00	\$210.00

Candado de hierro con llave de puntos

PROX.

BLÍSTER

- ▶ Cuerpo de hierro
- ▶ Gancho de acero resistente al corte
- ▶ Incluye 4 llaves



10
años
GARANTÍA

SEGURIDAD
+30

CÓDIGO	TAMAÑO	SEGURIDAD	6	48	DISTRIB.	MAYOREO	LISTA
108321	40 mm	5	6	48	\$70.00	\$100.00	\$123.00
108322	50 mm	6	6	36	\$80.00	\$114.00	\$141.00
108323	60 mm	6	6	36	\$90.00	\$129.00	\$160.00
108324	70 mm	6	6	36	\$100.00	\$143.00	\$175.00

Candado de hierro con llave de puntos

PROX.

CAJA

- ▶ Cuerpo de hierro
- ▶ Gancho de acero resistente al corte
- ▶ Incluye 3 llaves



18
meses
GARANTÍA

IT MAXTOOL

CÓDIGO	TAMAÑO	SEGURIDAD	6	72	DISTRIB.	MAYOREO	LISTA
305141	32 mm	4	12	72	\$15.00	\$21.40	\$26.00
305142	38 mm	4	6	72	\$18.00	\$26.00	\$32.00
305143	50 mm	5	6	48	\$27.00	\$39.00	\$48.00

Candado de combinación de disco

BLÍSTER

- ▶ Combinación fija



18
meses
GARANTÍA

IT MAXTOOL

CÓDIGO	SEGURIDAD	6	36	DISTRIB.	MAYOREO	LISTA
305130	3	6	36	\$38.00	\$54.00	\$67.00

Candado metálico gancho corto y largo

CAJA / BLÍSTER

- ▶ Cilindro y pernos de latón sólido
- ▶ Gancho endurecido de doble cerrojo
- ▶ Cuerpo de hierro, gran resistencia y durabilidad
- ▶ Incluye 3 llaves



GANCHO CORTO EN CAJA

CÓDIGO	TAMAÑO	SEGURIDAD			DISTRIB.	MAYOREO	LISTA
108301	30 mm	3	10	60	\$25.00	\$36.00	\$44.00
108302	40 mm	3	10	60	\$32.00	\$46.00	\$56.00
108303	45 mm	4	10	60	\$40.00	\$57.00	\$71.00
108304	50 mm	4	10	60	\$50.00	\$71.00	\$88.00

GANCHO LARGO EN CAJA

108305	30 mm	3	10	60	\$26.00	\$37.00	\$46.00
108306	40 mm	3	10	60	\$35.00	\$50.00	\$62.00
108307	45 mm	4	10	60	\$45.00	\$64.00	\$79.00
108308	50 mm	4	10	40	\$55.00	\$79.00	\$97.00

GANCHO CORTO EN BLÍSTER

CÓDIGO	TAMAÑO	SEGURIDAD			DISTRIB.	MAYOREO	LISTA
108309	30 mm	3	6	36	\$29.00	\$41.00	\$51.00
108310	40 mm	3	6	36	\$39.00	\$56.00	\$69.00
108311	45 mm	4	6	36	\$47.00	\$67.00	\$83.00
108312	50 mm	4	6	36	\$60.00	\$86.00	\$106.00

GANCHO LARGO EN BLÍSTER

108313	30 mm	3	6	36	\$32.00	\$46.00	\$56.00
108314	40 mm	3	6	36	\$42.00	\$60.00	\$74.00
108315	45 mm	4	6	36	\$53.00	\$76.00	\$93.00
108316	50 mm	4	6	36	\$60.00	\$86.00	\$106.00

Candado maletero

BLÍSTER

- ▶ Combinación de 3 dígitos que se puede personalizar y reajustar al gusto
- ▶ Variedad de colores



CÓDIGO			DISTRIB.	MAYOREO	LISTA
112802	8	48	\$29.00	\$41.00	\$51.00

Juego de 2 candados maleteros

BLÍSTER

- ▶ Combinación de 3 dígitos que se puede personalizar y reajustar
- ▶ Variedad de colores
- ▶ Incluye 2 piezas



CÓDIGO			DISTRIB.	MAYOREO	LISTA
112801	12	36	\$45.00	\$64.00	\$79.00



**AGILIZAMOS
TU TRABAJO**

► Conoce los nuevos productos de uso agrícola que facilitarán tu proyecto.

Carretilla tubular 6 ft³-100 L llanta reforzada

GRANEL

- ▶ Concha fabricada en lámina de acero calibre 20
- ▶ Bastidor de tubo de acero
- ▶ Llanta neumática reforzada de 16" x 4"



CÓDIGO		DISTRIB.	MAYOREO	LISTA
111803	1	\$1,100.00	\$1,570.00	\$1,940.00

Carretilla tubular 5 ft³-70 L llanta reforzada

GRANEL

- ▶ Concha fabricada en lámina de acero calibre 22
- ▶ Bastidor de tubo de acero
- ▶ Llanta neumática reforzada de 16" x 4"



CÓDIGO		DISTRIB.	MAYOREO	LISTA
111802	1	\$1,000.00	\$1,430.00	\$1,765.00

Carretilla tubular 4,5 ft³-65 L llanta reforzada

GRANEL

- ▶ Concha fabricada en lámina de acero calibre 22
- ▶ Bastidor de tubo de acero
- ▶ Llanta neumática reforzada de 16" x 4"



CÓDIGO		DISTRIB.	MAYOREO	LISTA
111801	1	\$950.00	\$1,355.00	\$1,675.00

Carretilla tubular 6 ft³-100 L llanta sólida

GRANEL

- ▶ Concha fabricada en lámina de acero calibre 20
- ▶ Bastidor de tubo de acero
- ▶ Llanta sólida de 16" x 4"



CÓDIGO		DISTRIB.	MAYOREO	LISTA
111823	1	\$1,150.00	\$1,645.00	\$2,030.00

Carretilla tubular 5 ft³-70 L llanta sólida

GRANEL

- ▶ Concha fabricada en lámina de acero calibre 22
- ▶ Bastidor de tubo de acero
- ▶ Llanta sólida de 16" x 4"



CÓDIGO		DISTRIB.	MAYOREO	LISTA
111822	1	\$1,050.00	\$1,500.00	\$1,850.00

Carretilla tubular 4,5 ft³-65 L llanta sólida

GRANEL

- ▶ Concha fabricada en lámina de acero calibre 22
- ▶ Bastidor de tubo de acero
- ▶ Llanta sólida de 16" x 4"



CÓDIGO		DISTRIB.	MAYOREO	LISTA
111821	1	\$1,000.00	\$1,430.00	\$1,765.00

Carretilla tubular 5 ft³ - 70 L

GRANEL

- ▶ Concha fabricada en lámina de acero calibre 23
- ▶ Bastidor de tubo de acero
- ▶ Llanta neumática reforzada de 14 1/2" x 3 1/2"



CÓDIGO	CAPACIDAD		DISTRIB.	MAYOREO	LISTA
308001	5 ft ³ - 70 L	1	\$850.00	\$1,215.00	\$1,500.00

Concha para carretilla 5 ft³ - 70 L

GRANEL

- ▶ Concha fabricada en lámina de acero calibre 23



CÓDIGO	CAPACIDAD		DISTRIB.	MAYOREO	LISTA
308041	5 ft ³ - 70 L	1	\$320.00	\$455.00	\$565.00

Concha para carretilla

GRANEL

- ▶ Concha fabricada en lámina de acero calibre 22



CÓDIGO	CAPACIDAD		DISTRIB.	MAYOREO	LISTA
111840	4,5 ft ³ - 65 L	1	\$365.00	\$520.00	\$645.00
111841	5 ft ³ - 70 L	1	\$415.00	\$595.00	\$730.00
111844	6 ft ³ - 100 L	1	\$540.00	\$770.00	\$955.00

Refacciones para carretillas

Jgo. de tornillería
(14 piezas)

BOLSA



111838

Tirante, puente y soporte
para carretilla

GRANEL



TIRANTE PUENTE SOPORTE

Eje para llanta

BOLSA Y GRANEL

- ▶ Compatible con otras carretillas



111836

Jgo. de chumaceras
para carretilla

BOLSA Y GRANEL

- ▶ Compatible con otras carretillas



111837

Bastidor para carretilla

GRANEL

- ▶ AKSI® espesor 1.75 mm
- ▶ MAXTOOL® espesor 1.55 mm



111839

308039



CÓDIGO	DESCRIPCIÓN			DISTRIB.	MAYOREO	LISTA
111838	Jgo. de tornillería con 14 piezas	Bolsa c/ 14 piezas	30 Bolsa	\$40.00	\$57.00	\$71.00
111842	Tirante, puente y soporte para carretilla	N/A	1	\$200.00	\$285.00	\$355.00
111836	Eje para llanta	N/A	50	\$27.00	\$39.00	\$48.00
111837	Jgo. de chumaceras para carretilla	Bolsa c/2 piezas	300 Bolsas	\$27.00	\$39.00	\$48.00
111839	Bastidor para carretilla	N/A	5	\$230.00	\$330.00	\$405.00
308039	Bastidor para carretilla	N/A	5	\$180.00	\$255.00	\$320.00

Cámara

GRANEL Y BOLSA

- ▶ Compatible con otras carretillas
- ▶ Llanta de 5 cuerdas
- ▶ Llanta de 16" x 4"
- ▶ Más resistente



111831

111832

Baleros

CABALLETE Y GRANEL

- ▶ Compatible con otras carretillas



111834

Llanta reforzada de 5
cuerdas con rin y baleros

GRANEL

- ▶ Compatible con otras carretillas
- ▶ Llanta de 5 cuerdas
- ▶ Llanta de 16" x 4"
- ▶ Más resistente



111843

Llanta sólida con
rin, eje y baleros

GRANEL

- ▶ Compatible con otras carretillas
- ▶ Llanta de 14"
- ▶ Más resistente



111849

Llanta reforzada de 3
cuerdas con rin y baleros

GRANEL

- ▶ Compatible con otras carretillas
- ▶ Llanta de 3 cuerdas
- ▶ Llanta de 14.5" x 3 1/2"



308043



CÓDIGO	DESCRIPCIÓN			DISTRIB.	MAYOREO	LISTA
111831	Llanta reforzada de 5 cuerdas sin cámara	N/A	N/A	\$120.00	\$170.00	\$210.00
111832	Cámara	N/A	N/A	\$35.00	\$50.00	\$62.00
111834	Baleros	Bolsa c/2 piezas	50 Bolsas	\$16.00	\$22.90	\$28.00
111835	Balero a granel	N/A	300 Piezas	\$8.00	\$11.40	\$14.10
111843	Llanta reforzada de 5 cuerdas con rin y baleros	N/A	N/A	\$260.00	\$370.00	\$460.00
111849	Llanta sólida con accesorios	N/A	N/A	\$270.00	\$385.00	\$475.00
308043	Llanta reforzada de 3 cuerdas con rin y baleros MAXTOOL	N/A	N/A	\$190.00	\$270.00	\$335.00

Cavador tipo Atlas

NUEVO

GRANEL

- ▶ Hojas de acero templado
- ▶ Mango redondo



CARACTERÍSTICAS

Largo de mango: 45" (114 cm)
 Espesor de hoja: 1.9 mm
 Apertura máxima: 5 1/4" (13.5 cm)



CÓDIGO	MANGO		DISTRIB.	MAYOREO	LISTA
111221	45"	6	\$375.00	\$535.00	\$660.00

Cavador tipo Hércules

NUEVO

GRANEL

- ▶ Hojas de acero templado
- ▶ Mango cuadrado



CARACTERÍSTICAS

Largo de mango: 48" (122 cm)
 Espesor de hoja: 2.7 mm
 Apertura máxima: 6 1/2" (16.5 cm)



CÓDIGO	MANGO		DISTRIB.	MAYOREO	LISTA
111222	48"	6	\$470.00	\$670.00	\$830.00



Azadón tipo Lane

GRANEL

- ▶ Forjados en una sola pieza para mayor durabilidad



CÓDIGO	PESO	ANCHO DE HOJA		DISTRIB.	MAY.	LISTA	
111251	1.6lb (0.72)kg	7 1/4" (18.5 cm)	6	24	\$105.00	\$150.00	\$185.00
111252	1.7lb (0.77)kg	7 3/4" (19.5 cm)	6	24	\$110.00	\$155.00	\$195.00
111253	1.8lb (0.81)kg	7 3/4" (19.5 cm)	6	24	\$115.00	\$165.00	\$205.00

Azadón tipo Lane con mango

PROX.

GRANEL

- ▶ Forjados en una sola pieza para mayor durabilidad



CÓDIGO	ANCHO DE HOJA		DISTRIB.	MAYOREO	LISTA
111256	7 1/4" (18.5 cm)	1	\$200.00	\$285.00	\$355.00
111257	7 3/4" (19.5 cm)	1	\$205.00	\$295.00	\$360.00
111258	7 3/4" (19.5 cm)	1	\$210.00	\$300.00	\$370.00

Complementos para trabajos agrícolas

Mango para azadón, 48"

PROX.

GRANEL

- ▶ Mango de madera de 48" (121 cm)
- ▶ Para uso en azadones tipo Lane AKSI



CÓDIGO	DISTRIB.	MAYOREO	LISTA
109309	\$100.00	\$143.00	\$175.00

Cable de acero - 7 x 7 hilos

NUEVO

CARRETE

- Fabricado en acero con acabado galvanizado



NO USAR PARA ESCALAR



Presentación: 75 m

CÓDIGO	DIÁMETRO	PRESENTACIÓN		DISTRIB.	MAYOREO	LISTA
130501	1/16"	Carrete plástico	4	\$200.00	\$285.00	\$355.00
130502	3/32"	Carrete plástico	4	\$270.00	\$385.00	\$475.00
130503	1/8"	Carrete plástico	4	\$400.00	\$570.00	\$705.00
130504	3/16"	Carrete plástico	4	\$700.00	\$1,000.00	\$1,235.00
130505	1/4"	Carrete plástico	4	\$1,200.00	\$1,715.00	\$2,115.00
130506	5/16"	Carrete de madera	4	\$1,950.00	\$2,785.00	\$3,440.00
130507	3/8"	Carrete de madera	1	\$2,700.00	\$3,855.00	\$4,765.00
130508	1/2"	Carrete de madera	1	\$4,800.00	\$6,855.00	\$8,465.00

Presentación: 300 m

CÓDIGO	DIÁMETRO	PRESENTACIÓN		DISTRIB.	MAYOREO	LISTA
130511	1/16"	Carrete plástico	4	\$675.00	\$965.00	\$1,190.00
130512	3/32"	Carrete plástico	4	\$950.00	\$1,355.00	\$1,675.00
130513	1/8"	Carrete plástico	4	\$1,450.00	\$2,070.00	\$2,560.00
130514	3/16"	Carrete de madera	1	\$2,700.00	\$3,855.00	\$4,765.00
130515	1/4"	Carrete de madera	1	\$4,600.00	\$6,570.00	\$8,115.00

Presentación: 450 m

CÓDIGO	DIÁMETRO	PRESENTACIÓN		DISTRIB.	MAYOREO	LISTA
130521	1/16"	Carrete plástico	4	\$980.00	\$1,400.00	\$1,730.00
130523	1/8"	Carrete de madera	1	\$2,200.00	\$3,145.00	\$3,880.00

Cable de acero - 7 x 19 hilos

NUEVO

CARRETE

- Fabricado en acero con acabado galvanizado

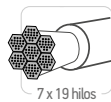

NO USAR PARA ESCALAR



Presentación: 75 m

CÓDIGO	DIÁMETRO	PRESENTACIÓN		DISTRIB.	MAYOREO	LISTA
130551	3/32"	Carrete plástico	4	\$540.00	\$770.00	\$955.00
130552	1/8"	Carrete plástico	4	\$500.00	\$715.00	\$880.00
130553	3/16"	Carrete plástico	4	\$780.00	\$1,115.00	\$1,375.00
130554	1/4"	Carrete plástico	4	\$1,200.00	\$1,715.00	\$2,115.00
130555	5/16"	Carrete de madera	4	\$2,000.00	\$2,855.00	\$3,530.00
130556	3/8"	Carrete de madera	1	\$2,800.00	\$4,000.00	\$4,940.00
130557	7/16"	Carrete de madera	1	\$3,800.00	\$5,430.00	\$6,705.00
130558	1/2"	Carrete de madera	1	\$4,800.00	\$6,855.00	\$8,465.00

Presentación: 300 m

CÓDIGO	DIÁMETRO	PRESENTACIÓN		DISTRIB.	MAYOREO	LISTA
130561	3/32"	Carrete de madera	4	\$2,000.00	\$2,855.00	\$3,530.00
130562	1/8"	Carrete de madera	4	\$1,850.00	\$2,645.00	\$3,265.00
130563	3/16"	Carrete de madera	1	\$2,900.00	\$4,145.00	\$5,115.00
130564	1/4"	Carrete de madera	1	\$4,500.00	\$6,430.00	\$7,940.00

Cable de acero recubierto de PVC 7 x 7 hilos

NUEVO

CARRETE

- Fabricado en acero con acabado galvanizado
- Recubrimiento de PVC, brinda protección a productos que se fijan o aseguran con el cable



NO USAR PARA ESCALAR



Presentación: 75 m

CÓDIGO	DIÁMETRO	PRESENTACIÓN		DISTRIB.	MAYOREO	LISTA
130531	1/16"	Carrete plástico	4	\$300.00	\$430.00	\$530.00
130532	3/32"	Carrete plástico	4	\$370.00	\$530.00	\$655.00
130533	1/8"	Carrete plástico	4	\$500.00	\$715.00	\$880.00
130534	3/16"	Carrete de madera	4	\$900.00	\$1,285.00	\$1,590.00
130535	1/4"	Carrete de madera	1	\$1,450.00	\$2,070.00	\$2,560.00

Presentación: 300 m

CÓDIGO	DIÁMETRO	PRESENTACIÓN		DISTRIB.	MAYOREO	LISTA
130541	1/16"	Carrete plástico	4	\$1,050.00	\$1,500.00	\$1,850.00
130542	3/32"	Carrete de madera	1	\$1,350.00	\$1,930.00	\$2,380.00
130543	1/8"	Carrete de madera	1	\$1,850.00	\$2,645.00	\$3,265.00
130544	3/16"	Carrete de madera	1	\$3,400.00	\$4,855.00	\$5,995.00
130545	1/4"	Carrete de madera	1	\$5,400.00	\$7,715.00	\$9,525.00

Cable de acero recubierto de PVC 7 x 19 hilos

NUEVO

CARRETE

- Fabricado en acero con acabado galvanizado
- Recubrimiento de PVC, brinda protección a productos que se fijan o aseguran con el cable

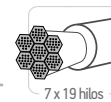

NO USAR PARA ESCALAR



Presentación: 75 m

CÓDIGO	DIÁMETRO	PRESENTACIÓN		DISTRIB.	MAYOREO	LISTA
130571	3/32"	Carrete plástico	4	\$640.00	\$915.00	\$1,130.00
130572	1/8"	Carrete plástico	4	\$600.00	\$855.00	\$1,060.00
130573	3/16"	Carrete de madera	4	\$900.00	\$1,285.00	\$1,590.00
130574	1/4"	Carrete de madera	1	\$1,400.00	\$2,000.00	\$2,470.00

Presentación: 300 m

CÓDIGO	DIÁMETRO	PRESENTACIÓN		DISTRIB.	MAYOREO	LISTA
130581	3/32"	Carrete de madera	1	\$2,400.00	\$3,430.00	\$4,235.00
130582	1/8"	Carrete de madera	1	\$2,250.00	\$3,215.00	\$3,970.00
130583	3/16"	Carrete de madera	1	\$3,400.00	\$4,855.00	\$5,995.00
130584	1/4"	Carrete de madera	1	\$5,300.00	\$7,570.00	\$9,350.00

Cable THW CCA UL

CAJA

- ▶ Para uso en interiores
- ▶ Recubrimiento antífama
- ▶ Cable THW, 75° C, 600 V
- ▶ Longitud 100 m



CÓDIGO	CALIBRE	COLOR		DISTRIB.	MAYOREO	LISTA
110371	8	Negro	1	\$1,400.00	\$2,000.00	\$2,470.00
110372	8	Rojo	1	\$1,400.00	\$2,000.00	\$2,470.00
110373	8	Blanco	1	\$1,400.00	\$2,000.00	\$2,470.00
110374	8	Verde	1	\$1,400.00	\$2,000.00	\$2,470.00
110376	10	Negro	1	\$850.00	\$1,215.00	\$1,500.00
110377	10	Rojo	1	\$850.00	\$1,215.00	\$1,500.00
110378	10	Blanco	1	\$850.00	\$1,215.00	\$1,500.00
110379	10	Verde	1	\$850.00	\$1,215.00	\$1,500.00
110381	12	Negro	1	\$570.00	\$815.00	\$1,005.00
110382	12	Rojo	1	\$570.00	\$815.00	\$1,005.00
110383	12	Blanco	1	\$570.00	\$815.00	\$1,005.00
110384	12	Verde	1	\$570.00	\$815.00	\$1,005.00

Cable dúplex STP (CCA)

ROLLO

- ▶ Cable flexible, ideal para ensamblarse con clavijas y contactos en el armado de extensiones
- ▶ Para uso con electrodomésticos acorde a sus especificaciones
- ▶ 2 Cordoncitos de CCA con aislamiento individual de PVC
- ▶ 300 V, 60°
- ▶ Rollo con 100 m



CÓDIGO	CALIBRE	COLOR		DISTRIB.	MAYOREO	LISTA
110351	12	Blanco	1	\$980.00	\$1,400.00	\$1,730.00
110352	14	Blanco	1	\$700.00	\$1,000.00	\$1,235.00
110353	16	Blanco	1	\$500.00	\$715.00	\$880.00
110354	18	Blanco	1	\$350.00	\$500.00	\$615.00

Portalámpara con cable de alimentación

FAJILLA

- ▶ Extensión con recubrimiento de PVC, autoextinguible
- ▶ Clavija polarizada
- ▶ Portalámpara de baquelita
- ▶ Cable calibre 18



CÓDIGO	LARGO		DISTRIB.	MAYOREO	LISTA
117591	4 m	30	\$45.00	\$64.00	\$79.00
117592	6 m	25	\$55.00	\$79.00	\$97.00
117593	8 m	20	\$70.00	\$100.00	\$123.00

Lámpara de taller

FAJILLA

- ▶ Clavija polarizada
- ▶ Cable 2x16 AWG
- ▶ Doble recubrimiento de PVC
- ▶ Interruptor de encendido



CÓDIGO	LARGO		DISTRIB.	MAYOREO	LISTA
113701	15 m	3	\$295.00	\$420.00	\$520.00

Extensión triple de uso rudo calibre 16

FAJILLA

- ▶ Clavija polarizada
- ▶ Cable 2x16 AWG
- ▶ Doble recubrimiento de PVC
- ▶ 3 contactos
- ▶ Material autoextinguible



CÓDIGO	LARGO		DISTRIB.	MAYOREO	LISTA
110315	2 m	6	\$33.00	\$47.00	\$58.00
110316	4 m	6	\$53.00	\$76.00	\$93.00
110317	6 m	6	\$73.00	\$104.00	\$129.00
110318	8 m	6	\$94.00	\$134.00	\$165.00
110319	10 m	5	\$110.00	\$155.00	\$195.00
110320	12 m	5	\$135.00	\$195.00	\$240.00
110321	15 m	4	\$160.00	\$230.00	\$280.00
110322	20 m	3	\$225.00	\$320.00	\$395.00
110323	25 m	2	\$285.00	\$405.00	\$505.00
110324	30 m	2	\$340.00	\$485.00	\$600.00

Extensión doméstica calibre 16 blanca

FAJILLA

- ▶ Clavija polarizada
- ▶ Recubrimiento de PVC
- ▶ Material autoextinguible



CÓDIGO	LARGO		DISTRIB.	MAYOREO	LISTA
110301	2 m	12	\$21.00	\$30.00	\$37.00
110302	3 m	12	\$27.00	\$39.00	\$48.00
110303	4 m	12	\$33.00	\$47.00	\$58.00
110304	5 m	12	\$40.00	\$57.00	\$71.00
110305	6 m	12	\$45.00	\$64.00	\$79.00
110306	8 m	12	\$55.00	\$79.00	\$97.00
110307	10 m	12	\$68.00	\$97.00	\$120.00

Extensión doméstica calibre 16 café

FAJILLA

- ▶ Clavija polarizada
- ▶ Recubrimiento de PVC
- ▶ Material autoextinguible



CÓDIGO	LARGO		DISTRIB.	MAYOREO	LISTA
110334	2 m	72	\$23.00	\$33.00	\$41.00
110335	3 m	72	\$30.00	\$43.00	\$53.00
110336	4 m	72	\$36.00	\$51.00	\$64.00
110337	5 m	72	\$43.00	\$61.00	\$76.00
110338	6 m	72	\$50.00	\$71.00	\$88.00
110339	8 m	48	\$62.00	\$89.00	\$109.00
110340	10 m	48	\$75.00	\$107.00	\$132.00

Cables pasa corriente 2 y 3 metros

FUNDA PLÁSTICA

- ▶ Caimanes fabricados en acero cobrizado, óptima sujeción al poste de la batería y mejor conducción de la corriente
- ▶ Recubrimiento de cable de PVC autoextinguible



12
meses
GARANTÍA

IT MAXTOOL

CÓDIGO	LONGITUD	CALIBRE			DISTRIB.	MAYOREO	LISTA
304902	2 m	10 AWG	5	20	\$90.00	\$129.00	\$160.00
304901	3 m	10 AWG	5	20	\$100.00	\$143.00	\$175.00

Calentador de agua

CABALLETE

- ▶ Gran durabilidad por la calidad de su resistencia (uso doméstico)
- ▶ Calentamiento más rápido del agua



NOM



12
meses
GARANTÍA

IT MAXTOOL

CÓDIGO	MODELO	MEDIDA			DISTRIB.	MAYOREO	LISTA
304602	2	400 W - 5 L	12	96	\$23.00	\$33.00	\$41.00
304603	3	460 W - 8 L	12	96	\$24.00	\$34.00	\$42.00
304604	4	880 W - 15 L	12	96	\$24.00	\$34.00	\$42.00
304605	5	900 W - 18 L	12	96	\$26.00	\$37.00	\$46.00
304606	6	1000 W - 20 L	12	96	\$27.00	\$39.00	\$48.00
304607	Jumbo	1000 W - 25 L	12	96	\$30.00	\$43.00	\$53.00

Cautín tipo lápiz 30 W, uso ligero

BLÍSTER

- ▶ Ideal para trabajos de electrónica, caseros y escolares
- ▶ Útil para reparaciones electrónicas



NOM



12
meses
GARANTÍA

IT MAXTOOL

CÓDIGO	POTENCIA			DISTRIB.	MAYOREO	LISTA
301802	30 W	4	24	\$45.00	\$64.00	\$79.00

Cautín tipo lápiz 30 W, con accesorios

BLÍSTER

- ▶ Ideal para trabajos de electrónica, caseros y escolares

INCLUYE:
1 desarmador punta de cruz
1 punta de repuesto Soldadura
Pasta para soldar



NOM



12
meses
GARANTÍA

IT MAXTOOL

CÓDIGO	POTENCIA			DISTRIB.	MAYOREO	LISTA
301801	30 W	4	24	\$60.00	\$86.00	\$106.00

Corredera de extensión

GRANEL

- ▶ Fabricadas en acero
- ▶ Fácil y rápido deslizamiento de cajones



IT MAXTOOL

CÓDIGO	MEDIDA			DISTRIB.	MAYOREO	LISTA
305711	30 cm	15	15	\$41.00	\$59.00	\$72.00
305712	35 cm	15	15	\$49.00	\$70.00	\$86.00
305713	40 cm	15	15	\$56.00	\$80.00	\$99.00
305714	45 cm	15	15	\$64.00	\$91.00	\$113.00
305715	50 cm	15	15	\$68.00	\$97.00	\$120.00
305716	55 cm	15	15	\$79.00	\$113.00	\$139.00
305717	60 cm	15	15	\$84.00	\$120.00	\$148.00

Corredera de cajón

GRANEL

- ▶ Fabricadas en acero al carbono
- ▶ Pintadas con pintura electrostática
- ▶ Fácil y rápido deslizamiento de cajones



IT MAXTOOL

CÓDIGO	COLOR	MEDIDA		DISTRIB.	MAYOREO	LISTA
305701	Blanco	30 cm	25	\$22.00	\$31.00	\$39.00
305702	Blanco	35 cm	25	\$25.00	\$36.00	\$44.00
305703	Blanco	40 cm	25	\$30.00	\$43.00	\$53.00
305704	Blanco	45 cm	25	\$33.00	\$47.00	\$58.00
305705	Blanco	50 cm	25	\$36.00	\$51.00	\$64.00

Corredera de cajón

GRANEL

- ▶ Fabricadas en acero al carbono
- ▶ Pintadas con pintura electrostática
- ▶ Fácil y rápido deslizamiento de cajones



IT MAXTOOL

CÓDIGO	COLOR	MEDIDA		DISTRIB.	MAYOREO	LISTA
305706	Café	30 cm	25	\$22.00	\$31.00	\$39.00
305707	Café	35 cm	25	\$25.00	\$36.00	\$44.00
305708	Café	40 cm	25	\$30.00	\$43.00	\$53.00
305709	Café	45 cm	25	\$33.00	\$47.00	\$58.00
305710	Café	50 cm	25	\$36.00	\$51.00	\$64.00

Cartuchos de gas

AEROSOL

- ▶ Ideal para sopletes, mecheros, lámparas y estufillas
- ▶ Gas butano / propano
- ▶ Ideal para estufa portátil



CÓDIGO	TIPO DE VÁLVULA	CONTENIDO	DISTRIB.	MAYOREO	LISTA
119571	Roscada	275 gr	6	\$37.00	\$53.00 \$65.00
119572	1/4 de vuelta	220 gr	6	\$37.00	\$53.00 \$65.00

Encendedor tipo cazuela y repuestos

CABALLETE Y BOLSA PLÁSTICA (REPUESTOS)

- ▶ Ideal para soldadura de gas
- ▶ Piedra de chispeo intercambiable
- ▶ Cazuela niquelada y mango cromado



REPUESTO 124109 CONTIENE 5 PIEZAS



CÓDIGO	DISTRIB.	MAYOREO	LISTA
124101	6	36	\$22.00 \$31.00 \$39.00
124109	N/A	300	\$14.00 \$20.00 \$24.70

Encendedor tipo antorcha, con o sin cartucho

BLÍSTER

- ▶ Botón de ignición
- ▶ Botón de seguridad
- ▶ Flama ajustable
- ▶ Mecanismo de recarga a través de una ventana
- ▶ Encendido electrónico
- ▶ Variedad de colores



CÓDIGO	CARACTERÍSTICAS	DISTRIB.	MAYOREO	LISTA
310301	Sin cartucho	12 144	\$22.00	\$31.00 \$39.00
310302	Con cartucho	12 120	\$30.00	\$43.00 \$53.00

Estufa de gas portátil

CAJA

- ▶ Sistema de apagado automático en caso de alta presión de gas
- ▶ Útil para acampar o para emergencias en casa
- ▶ Funciona con un cartucho de gas butano / propano de 1/4 de vuelta, no incluida



ESTUCHE INCLUIDO

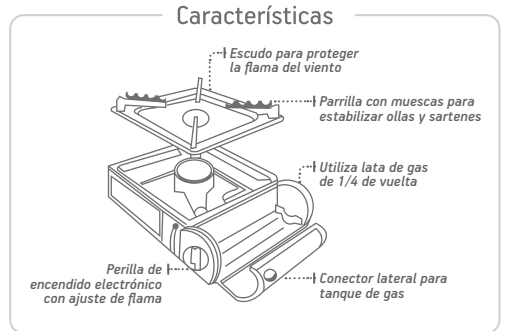

CÓDIGO	DISTRIB.	MAYOREO	LISTA
116021	6	\$430.00	\$615.00 \$760.00

Cabo para zapapico, hacha de media y labor entera de 36"



GRANEL

- ▶ Mango de madera perfilada de encino estufado con un tratamiento especial para eliminar el exceso de humedad



CÓDIGO	DISTRIB.	MAYOREO	LISTA
109304	1	\$78.00	\$111.00 \$138.00
109303	1	\$98.00	\$140.00 \$175.00

Caja para herramienta 12"

GRANEL

- ▶ Fabricada en polipropileno de alto impacto
- ▶ Tapa con organizadores y entrada para candado



CÓDIGO	MEDIDA	DISTRIB.	MAYOREO	LISTA
111711	12"	6	\$68.00	\$97.00 \$120.00

Caja para herramienta 16" y 19"

GRANEL

- ▶ Fabricada en polipropileno de alto impacto
- ▶ Tapa con 2 organizadores y entrada para candado
- ▶ Charola desmontable y amplio compartimento de almacenaje
- ▶ Cajas apilables



NO INCLUYE HERRAMIENTAS

CÓDIGO	MEDIDA	DISTRIB.	MAYOREO	LISTA
111712	16"	12	\$140.00	\$200.00 \$245.00
111713	19"	12	\$205.00	\$295.00 \$360.00

Carda de copa alambre ondulado

DOBLE BLÍSTER

- ▶ Para cepillado ligero dejando un acabado fino
- ▶ Ideal en superficies irregulares grandes
- ▶ Calibre 0,35 mm



ACERO AL CARBONO



MÁX. VEL. 12,500 rpm



CÓDIGO	ENTRADA	DIÁMETRO			DISTRIB.	MAYOREO	LISTA
116621	5/8"	3"	4	24	\$55.00	\$79.00	\$97.00
116626	14 mm	3"	4	24	\$50.00	\$71.00	\$88.00

MÁX. VEL. 10,000 rpm

CÓDIGO	ENTRADA	DIÁMETRO			DISTRIB.	MAYOREO	LISTA
116622	5/8"	4"	4	24	\$85.00	\$121.00	\$150.00
116627	14 mm	4"	4	24	\$75.00	\$107.00	\$132.00

MÁX. VEL. 6,500 rpm

CÓDIGO	ENTRADA	DIÁMETRO			DISTRIB.	MAYOREO	LISTA
116623	5/8"	5"	4	24	\$110.00	\$155.00	\$195.00
116628	14 mm	5"	4	24	\$110.00	\$155.00	\$195.00

Carda para esmeril 6"

DOBLE BLÍSTER

- ▶ Para cepillado ligero dejando acabado fino
- ▶ Para limpieza de superficies
- ▶ Incluye adaptadores
- ▶ Calibre 0,35 mm



MÁX. VEL. 6,000 rpm



CÓDIGO	ESPESOR	DIÁMETRO			DISTRIB.	MAYOREO	LISTA
116601	3/4"	6"	4	24	\$95.00	\$136.00	\$170.00
116602	13/16"	6"	4	24	\$105.00	\$150.00	\$185.00
116603	1 1/8"	6"	4	24	\$110.00	\$155.00	\$195.00

Carda de copa alambre trenzado fino

DOBLE BLÍSTER

- ▶ Para cepillado pesado dejando un acabado áspero
- ▶ Ideal en superficies planas grandes
- ▶ Calibre 0,35 mm



ACERO AL CARBONO



MÁX. VEL. 12,500 rpm



CÓDIGO	ENTRADA	DIÁMETRO			DISTRIB.	MAYOREO	LISTA
116631	5/8"	3"	4	24	\$55.00	\$79.00	\$97.00
116635	14 mm	3"	4	24	\$55.00	\$79.00	\$97.00

MÁX. VEL. 8,500 rpm

CÓDIGO	ENTRADA	DIÁMETRO			DISTRIB.	MAYOREO	LISTA
116632	5/8"	4"	4	24	\$90.00	\$129.00	\$160.00
116636	14 mm	4"	4	24	\$90.00	\$129.00	\$160.00

MÁX. VEL. 6,500 rpm

CÓDIGO	ENTRADA	DIÁMETRO			DISTRIB.	MAYOREO	LISTA
116633	5/8"	5"	4	24	\$115.00	\$165.00	\$205.00
116637	14 mm	5"	4	24	\$115.00	\$165.00	\$205.00

Carda para esmeriladora 6"

DOBLE BLÍSTER

- ▶ Ideal en espacios reducidos
- ▶ Entrada de 5/8"
- ▶ Para limpieza de soldadura
- ▶ Espesor 3/4"



DIÁMETRO: 6"

MÁX. VEL. 9,000 rpm



CÓDIGO	CALIBRE	TRENZADO			DISTRIB.	MAYOREO	LISTA
116611	0.35 mm	Fino	4	24	\$110.00	\$155.00	\$195.00
116612	0.50 mm	Grueso	4	24	\$110.00	\$155.00	\$195.00

Carda de copa alambre trenzado grueso

DOBLE BLÍSTER

- ▶ Para cepillado agresivo dejando un acabado burdo
- ▶ Ideal en superficies planas grandes
- ▶ Calibre 0,5 mm



ACERO AL CARBONO



MÁX. VEL. 6,500 rpm



CÓDIGO	ENTRADA	DIÁMETRO			DISTRIB.	MAYOREO	LISTA
116641	5/8"	5"	4	24	\$115.00	\$165.00	\$205.00
116646	14 mm	5"	4	24	\$115.00	\$165.00	\$205.00

Carda para esmeriladora 6" x 3/4"

DOBLE BLÍSTER

- ▶ Ideal en espacios reducidos
- ▶ Para limpieza de soldaduras
- ▶ Entrada de 5/8"



MÁX. VEL. 9,000 rpm



CÓDIGO	ESPESOR	DIÁMETRO			DISTRIB.	MAYOREO	LISTA
116613	3/4"	6"	4	24	\$110.00	\$155.00	\$195.00

Juego de cardas para taladro 4 piezas

DOBLE BLÍSTER



CONTENIDO

- Carda de lija 3"
- Carda circular de alambre 3"
- Carda de copa de alambre 2"
- Carda de copa miniatura de alambre 3/4"

MÁX. VEL. 4,500 rpm



CÓDIGO	DIÁMETRO	BLÍSTER	DISTRIB.	MAYOREO	LISTA
116691	6	36	\$100.00	\$143.00	\$175.00

Carda circular para taladro alambre grueso

DOBLE BLÍSTER

- ▶ Ideal en espacios reducidos
- ▶ Fabricada en acero
- ▶ Calibre 0,30 mm



MÁX. VEL. 4,500 rpm



CÓDIGO	DIÁMETRO	BLÍSTER	DISTRIB.	MAYOREO	LISTA
308801	2"	6 36	\$15.00	\$21.40	\$26.00
308802	3"	6 36	\$22.00	\$31.00	\$39.00

Carda de copa para taladro alambre grueso

DOBLE BLÍSTER

- ▶ Para cepillado ligero dejando un acabado fino
- ▶ Ideal en superficies irregulares grandes
- ▶ Calibre 0,30 mm



MÁX. VEL. 4,500 rpm



CÓDIGO	DIÁMETRO	BLÍSTER	DISTRIB.	MAYOREO	LISTA
308811	1 3/4"	6 36	\$22.00	\$31.00	\$39.00
308812	2 3/4"	6 36	\$29.00	\$41.00	\$51.00

Carda circular para taladro, alambre fino

DOBLE BLÍSTER

- ▶ Ideal en espacios reducidos
- ▶ Para remover residuos de pintura y pulir
- ▶ Calibre 0,20 mm



MÁX. VEL. 4,500 rpm



CÓDIGO	DIÁMETRO	BLÍSTER	DISTRIB.	MAYOREO	LISTA
116651	1 1/2"	6 36	\$18.00	\$26.00	\$32.00
116652	2"	6 36	\$20.00	\$29.00	\$35.00
116653	3"	6 36	\$25.00	\$36.00	\$44.00
116654	4"	6 36	\$35.00	\$50.00	\$62.00

Carda circular para taladro, alambre grueso

DOBLE BLÍSTER

- ▶ Ideal en espacios reducidos
- ▶ Para remover residuos de pintura y pulir
- ▶ Calibre 0,30 mm



MÁX. VEL. 4,500 rpm



CÓDIGO	DIÁMETRO	BLÍSTER	DISTRIB.	MAYOREO	LISTA
116661	2"	6 36	\$18.00	\$26.00	\$32.00
116662	3"	6 36	\$24.00	\$34.00	\$42.00
116663	4"	6 36	\$34.00	\$49.00	\$60.00

Carda de copa para taladro, alambre fino

DOBLE BLÍSTER

- ▶ Para cepillado suave dejando un acabado extra fino
- ▶ Ideal en superficies irregulares
- ▶ Para remover residuos de pintura y pulir
- ▶ Calibre 0,20 mm



MÁX. VEL. 4,500 rpm



CÓDIGO	DIÁMETRO	BLÍSTER	DISTRIB.	MAYOREO	LISTA
116671	1 3/4"	6 36	\$26.00	\$37.00	\$46.00
116672	2 3/4"	6 36	\$32.00	\$46.00	\$56.00

Carda de copa para taladro, alambre grueso

DOBLE BLÍSTER

- ▶ Para cepillado ligero dejando un acabado fino
- ▶ Ideal en superficies irregulares
- ▶ Para remover residuos de pintura y pulir
- ▶ Calibre 0,30 mm



MÁX. VEL. 4,500 rpm



CÓDIGO	DIÁMETRO	BLÍSTER	DISTRIB.	MAYOREO	LISTA
116681	3/4"	6 36	\$18.00	\$26.00	\$32.00
116682	1"	6 36	\$21.00	\$30.00	\$37.00
116683	1 1/8"	6 36	\$24.00	\$34.00	\$42.00
116684	1 3/4"	6 36	\$24.00	\$34.00	\$42.00
116685	2 3/4"	6 36	\$34.00	\$49.00	\$60.00

Chaleco brigadista con cinta reflejante

CABALLETE

- ▶ Fabricado en 100% poliéster
- ▶ Cintas reflejantes de 2" en frente y espalda
- ▶ Cierre frontal
- ▶ Broches laterales ajustables
- ▶ 4 Bolsas con cierre
- ▶ Para uso de día y de noche
- ▶ Unitalla



108111



108117 108112 108113 108115 108114



108120 108118 108116 108121 108119



CÓDIGO	COLOR			DISTRIB.	MAYOREO	LISTA
108111	Amarillo	3	60	\$190.00	\$270.00	\$335.00
108112	Azul marino	3	60	\$190.00	\$270.00	\$335.00
108113	Azul rey	3	60	\$190.00	\$270.00	\$335.00
108114	Beige	3	60	\$190.00	\$270.00	\$335.00
108115	Gris	3	60	\$190.00	\$270.00	\$335.00
108116	Naranja	3	60	\$190.00	\$270.00	\$335.00
108117	Negro	3	60	\$190.00	\$270.00	\$335.00
108118	Rojos	3	60	\$190.00	\$270.00	\$335.00
108119	Rosa	3	60	\$190.00	\$270.00	\$335.00
108120	Verde	3	60	\$190.00	\$270.00	\$335.00
108121	Vino	3	60	\$190.00	\$270.00	\$335.00

Banderín vial con banda reflejante

CABALLETE

- ▶ Incluye tubo plástico
- ▶ Resistente a los rayos UV
- ▶ Ideal para obras en construcción, estacionamiento, tránsito vial, etc.



108181

108182



CÓDIGO	MEDIDA			DISTRIB.	MAYOREO	LISTA
108181	33 x 30 cm	10	100	\$30.00	\$43.00	\$53.00
108182	48 x 48 cm	10	100	\$32.00	\$46.00	\$56.00

Chaleco con cinta doble

CABALLETE

- ▶ Resistente a los rayos UV
- ▶ Fabricado en poliéster
- ▶ Para uso de día y de noche
- ▶ Unitalla



108101

108102

108103



CÓDIGO	COLOR			DISTRIB.	MAYOREO	LISTA
108101	Amarillo	5	50	\$50.00	\$71.00	\$88.00
108102	Naranja	5	50	\$50.00	\$71.00	\$88.00
108103	Verde	5	50	\$50.00	\$71.00	\$88.00

Cascos de seguridad, 6 clips

BOLSA

- ▶ Casco Tipo 1 clase E
- ▶ Diseño reforzado
- ▶ Fabricado con polipropileno de alto impacto resistente a voltajes de hasta 20 000 V
- ▶ Suspensión plástica



108201



108205

108204

108203

108202



CÓDIGO	COLOR		DISTRIB.	MAYOREO	LISTA
108201	Amarillo	40	\$95.00	\$136.00	\$170.00
108202	Azul	40	\$95.00	\$136.00	\$170.00
108203	Verde	40	\$95.00	\$136.00	\$170.00
108204	Blanco	40	\$95.00	\$136.00	\$170.00
108205	Naranja	40	\$95.00	\$136.00	\$170.00

Chaleco de seguridad, malla con bandas reflejantes

CABALLETE

- ▶ Bandas reflejantes
- ▶ Malla ligera de poliéster
- ▶ Unitalla



307702

307703



CÓDIGO	COLOR			DISTRIB.	MAYOREO	LISTA
307701	Naranja	5	50	\$35.00	\$50.00	\$62.00
307702	Verde	5	50	\$35.00	\$50.00	\$62.00
307703	Amarillo	5	50	\$35.00	\$50.00	\$62.00

Cascos de seguridad, 4 clips

PROX.

BOLSA

- ▶ Casco Tipo 1 clase E
- ▶ Fabricado con polipropileno de alto impacto resistente a voltajes de hasta 20 000 V
- ▶ Suspensión plástica



309301



309304

309302

309303



CÓDIGO	COLOR		DISTRIB.	MAYOREO	LISTA
309301	Amarillo	40	\$72.00	\$103.00	\$127.00
309302	Blanco	40	\$72.00	\$103.00	\$127.00
309303	Azul	40	\$72.00	\$103.00	\$127.00
309304	Naranja	40	\$72.00	\$103.00	\$127.00

Orejera protectora

CABALLETE

- ▶ Ideal para uso industrial o actividades donde el nivel sonoro sea alto
- ▶ Orejera con almohadillas
- ▶ Ajustable al tamaño de la cabeza



10 años GARANTÍA



CÓDIGO			DISTRIB.	MAYOREO	LISTA
108004	4	40	\$85.00	\$121.00	\$150.00

Rodillera Profesional

TARJETA COLGANTE

- ▶ Tiras elásticas de ajuste
- ▶ Cápsula de PVC rígido que protege de clavos, vidrios, piedras etc.
- ▶ Acoginado suave y plantilla de gel para mayor estabilidad



3 años GARANTÍA



CÓDIGO			DISTRIB.	MAYOREO	LISTA
107841	2	12	\$245.00	\$350.00	\$430.00

Careta para soldar y filtro

BOLSA

- ▶ Fabricada en polipropileno resistente a impactos y altas temperaturas
- ▶ Fajilla plástica con cremallera de ajuste preciso
- ▶ Careta con antefiltro transparente y ventana móvil



105821

105801



CÓDIGO	DESCRIP.	FILTRO	CAJA	BOLSA	DISTRIB.	MAYOREO	LISTA
105801	Careta	12 Sombras	N/A	12	\$100.00	\$143.00	\$175.00
105820	Filtro	11 Sombras	100	600	\$5.00	\$7.10	\$8.80
105821	Filtro	12 Sombras	100	600	\$5.00	\$7.10	\$8.80

Protector facial con refuerzo de aluminio y repuestos

CABALLETE

- ▶ Mica de policarbonato anti rayadura con refuerzo de aluminio
- ▶ Suspensión con ajuste tipo matraca



107832

107831



CÓDIGO	DESCRIP.	CAJA	BOLSA	DISTRIB.	MAYOREO	LISTA
107831	Protector	10		\$150.00	\$215.00	\$265.00
107832	Mica	36		\$70.00	\$100.00	\$123.00

Gafas para soldar y repuestos

CABALLETE

- ▶ Marco facial con cinta elástica
- ▶ Sombra no. 6
- ▶ Ideal para soldar y para uso en oxicorte
- ▶ Repuestos de policarbonato



105832

105831



CÓDIGO	ACABADO	CAJA	BOLSA	DISTRIB.	MAYOREO	LISTA
105802	Gafas	6	36	\$70.00	\$100.00	\$123.00
105831	Cristal transparente	20	120	\$8.00	\$11.40	\$14.10
105832	Filtro 6 sombras	20	120	\$8.00	\$11.40	\$14.10

Careta electrónica para soldar

CAJA

- ▶ Oscurecimiento automático
- ▶ Perilla para ajuste de sensibilidad



105811

105812

105813

105814

105815



ESPECIFICACIONES TÉCNICAS

Rango de oscurecimiento	9 - 13
Velocidad de oscurecimiento	0.04 msegundos
Cartucho	110 x 90 x 9 mm
Fuente de energía	Solar y 1 batería
Temperatura de operación	-20°C + 65°C
Tiempo de retardo	0.15 - 1 s
Protección UV/IR	DIN 16

CÓDIGO	CAJA	BOLSA	DISTRIB.	MAYOREO	LISTA
105811	20		\$255.00	\$365.00	\$450.00
105812	20		\$285.00	\$405.00	\$505.00
105813	20		\$285.00	\$405.00	\$505.00
105814	20		\$285.00	\$405.00	\$505.00
105815	20		\$285.00	\$405.00	\$505.00

Careta electrónica para soldar

CAJA

- ▶ Oscurecimiento automático
- ▶ Perilla para ajuste de sensibilidad
- ▶ Lente con filtro que protege contra rayos UV & IR



ESPECIFICACIONES TÉCNICAS

Rango de oscurecimiento	9 - 13
Velocidad de oscurecimiento	1/15000 segundos
Protección UV/ IR	DIN 16
Cartucho	110 x 90 x 9 mm
Fuente de energía	Solar y 1 batería
Temperatura de operación	-20°C + 65°C
Tiempo de retardo	0.15 - 1s (ajustable)
Protección UV/IR	DIN 13

CÓDIGO	CAJA	DISTRIB.	MAYOREO	LISTA
306651	20	\$205.00	\$295.00	\$360.00

Mascarilla para polvo

CAJA Y BOLSA

- ▶ Ideal para polvo y sustancias no tóxicas
- ▶ Pieza nasal ajustable, ligera y cómoda
- ▶ No dificulta la respiración ni el habla
- ▶ No afecta el campo visual



PRECIO POR PIEZA

CÓDIGO	CAJA	BOLSA	DISTRIB.	MAYOREO	LISTA
107901	Caja c/50 pzas	10 cajas	\$3.00	\$4.30	\$5.30
107918	6 Bolsa c/10 pzas	36 Bolsas	\$30.00	\$43.00	\$53.00

Mascarilla para polvo y vapores orgánicos

BOLSA

- ▶ Ideal para polvo y vapores orgánicos
- ▶ Pieza nasal ajustable, ligera y cómoda
- ▶ No dificulta la respiración ni el habla
- ▶ No afecta el campo visual



BOLSA CON 2 PIEZAS

CÓDIGO	CAJA	BOLSA	DISTRIB.	MAYOREO	LISTA
107904	6 Bolsas c/2 pzas	36 Bolsas	\$33.00	\$47.00	\$58.00

Mascarilla plástica con filtro y repuesto (para polvo)

CAJA Y CABALLETE

- ▶ Ideal para polvo y vapores orgánicos
- ▶ Ligera y cómoda
- ▶ Ideal para la industria, construcción y hogar



PRECIO POR PIEZA

CÓDIGO	PRESENTACIÓN	CAJA	BOLSA	DISTRIB.	MAYOREO	LISTA
306001	Caja	12 pzas	72 pzas	\$18.00	\$26.00	\$32.00
306002	Caballote	6 pzas	72 pzas	\$20.00	\$29.00	\$35.00

Cemento gris

BOLSA

- ▶ Bolsas de 1,5 kg
- ▶ Ideal para construcción de elementos o estructuras de concreto simple o armado
- ▶ Uso residencial y comercial
- ▶ Óptima durabilidad
- ▶ Puede adicionarse arena y grava para obtener la trabajabilidad deseada
- ▶ Tiempo de fraguado: 7 días



CÓDIGO	CONTENIDO	DISTRIB.	MAYOREO	LISTA
119801	4 1,5 kg	\$25.00	\$36.00	\$44.00

Cemento blanco

BOLSA

- ▶ Bolsas de 1,5 kg
- ▶ Ideal para acabados finos en pisos y muros
- ▶ Para emboquillado, juntas, tirol o base para cementos de color
- ▶ Para uso estructural y arquitectónico
- ▶ Fácil aplicación
- ▶ Tiempo de fraguado: inicial 3 hrs - final 7 hrs



CÓDIGO	CONTENIDO	DISTRIB.	MAYOREO	LISTA
119802	4 1,5 kg	\$32.00	\$46.00	\$56.00

Yeso

BOLSA

- ▶ Bolsa de 1,5 kg
- ▶ Ideal para acabado fino, enlucido de muros y losas
- ▶ Excelente para manualidades
- ▶ Fácil aplicación
- ▶ Tiempo de fraguado: 60 min



CÓDIGO	CONTENIDO	DISTRIB.	MAYOREO	LISTA
119804	4 1,5 kg	\$20.00	\$29.00	\$35.00

Cal

BOLSA

- ▶ Presentación en bolsa de 1,5 kg
- ▶ Para enclavado y combate de plagas
- ▶ Desinfección de abonos orgánicos
- ▶ Estabilización de suelos agrícolas, tratamiento de pozos sépticos y alcantarillas
- ▶ Fácil aplicación



CÓDIGO	CONTENIDO	DISTRIB.	MAYOREO	LISTA
119805	4 1,5 kg	\$22.00	\$31.00	\$39.00

Cadena galvanizada

CUBETA

- ▶ Fabricada en acero al carbono templado
- ▶ Eslabones electrosoldados
- ▶ Cadena grado 30, formada en frío
- ▶ Mínima elongación

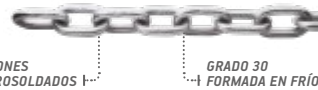

CÓDIGO	Ø DE ESLABÓN	CARGA TRABAJO	CARGA RUPTURA	PESO	DISTRIB.	MAYOREO	LISTA
113801	1/8" (3.1 mm)	180 kg	726 kg	25 kg	\$2,100.00	\$3,000.00	\$3,705.00
113802	3/16" (4.7 mm)	365 kg	1 451 kg	25 kg	\$1,900.00	\$2,715.00	\$3,350.00
113803	1/4" (6.3 mm)	580 kg	2 358 kg	25 kg	\$1,850.00	\$2,645.00	\$3,265.00
113804	5/16" (7.9 mm)	860 kg	3 440 kg	25 kg	\$1,850.00	\$2,645.00	\$3,265.00
113805	3/8" (9.5 mm)	1 200 kg	4 808 kg	25 kg	\$1,850.00	\$2,645.00	\$3,265.00
113806	1/2" (12.7 mm)	2 030 kg	8 164 kg	25 kg	\$1,850.00	\$2,645.00	\$3,265.00
113807	5/16" (7.9 mm)	860 kg	3 440 kg	50 kg	\$3,650.00	\$5,215.00	\$6,440.00
113808	3/8" (9.5 mm)	1 200 kg	4 808 kg	50 kg	\$3,650.00	\$5,215.00	\$6,440.00
113809	1/2" (12.7 mm)	2 030 kg	8 164 kg	50 kg	\$3,650.00	\$5,215.00	\$6,440.00

Cadena de plástico

PROX.

CARRETE

- ▶ Fabricada en polietileno
- ▶ Resistente a la intemperie
- ▶ Ligera y lavable



POLIETILENO
RESISTENTE A INTEMPERIE



Carrete de
25m



CÓDIGO	TAMAÑO	COLOR	DISTRIB.	MAYOREO	LISTA	CÓDIGO	TAMAÑO	COLOR	DISTRIB.	MAYOREO	LISTA
131401	3 mm	Blanco	\$465.00	\$665.00	\$820.00	131415	5 mm	Rojo	\$325.00	\$465.00	\$575.00
131402	3 mm	Amarillo	\$465.00	\$665.00	\$820.00	131416	5 mm	Azul	\$325.00	\$465.00	\$575.00
131403	3 mm	Verde	\$465.00	\$665.00	\$820.00	131417	5 mm	Negro	\$325.00	\$465.00	\$575.00
131404	3 mm	Naranja	\$465.00	\$665.00	\$820.00	131421	8 mm	Blanco	\$465.00	\$665.00	\$820.00
131405	3 mm	Rojo	\$465.00	\$665.00	\$820.00	131422	8 mm	Amarillo	\$465.00	\$665.00	\$820.00
131406	3 mm	Azul	\$465.00	\$665.00	\$820.00	131423	8 mm	Verde	\$465.00	\$665.00	\$820.00
131407	3 mm	Negro	\$465.00	\$665.00	\$820.00	131424	8 mm	Naranja	\$465.00	\$665.00	\$820.00
131411	5 mm	Blanco	\$325.00	\$465.00	\$575.00	131425	8 mm	Rojo	\$465.00	\$665.00	\$820.00
131412	5 mm	Amarillo	\$325.00	\$465.00	\$575.00	131426	8 mm	Azul	\$465.00	\$665.00	\$820.00
131413	5 mm	Verde	\$325.00	\$465.00	\$575.00	131427	8 mm	Negro	\$465.00	\$665.00	\$820.00
131414	5 mm	Naranja	\$325.00	\$465.00	\$575.00						

Cemento para PVC condiciones húmedas y secas, viscosidad regular

TUBO

- ▶ Secado rápido
- ▶ Adecuado para condiciones húmedas y secas
- ▶ Adecuado para uso en cédulas 40 y 80, tubos y conexiones de PVC de hasta (15 cm) 6"



CÓDIGO	CONTENIDO		DISTRIB.	MAYOREO	LISTA
109921	50 g	50	\$23.00	\$33.00	\$41.00

Cemento para PVC condiciones secas, viscosidad media

TUBO

- ▶ Secado rápido
- ▶ Adecuado para condiciones secas
- ▶ Para tuberías, acoples y caños de PVC cédula 40 de hasta (10 cm) 4" y de cédula 80 de hasta (51 mm) 2"



CÓDIGO	CONTENIDO		DISTRIB.	MAYOREO	LISTA
109901	50 g	50	\$22.00	\$31.00	\$39.00

Cemento para CPVC altas temperaturas, viscosidad alta

TUBO

- ▶ Secado rápido
- ▶ Adecuado para altas temperaturas
- ▶ Adecuado para su uso en cédulas 40 y 80, tuberías, caños, acoples de hasta (15 cm) 6"



CÓDIGO	CONTENIDO		DISTRIB.	MAYOREO	LISTA
109911	50 g	50	\$26.00	\$37.00	\$46.00

Cemento para PVC condiciones húmedas y secas, viscosidad regular

LATA

- ▶ Secado rápido
- ▶ Adecuado para uso en cédulas 40 y 80, tubos y conexiones de PVC de hasta (15 cm) 6"



CÓDIGO	CONTENIDO		DISTRIB.	MAYOREO	LISTA
109922	90 ml	50	\$35.00	\$50.00	\$62.00
109923	145 ml	24	\$47.00	\$67.00	\$83.00
109924	250 ml	24	\$66.00	\$94.00	\$116.00
109925	500 ml	12	\$115.00	\$165.00	\$205.00

Cemento para PVC condiciones secas, viscosidad media

LATA

- ▶ Secado rápido
- ▶ Ideal para tuberías, acoples y caños de PVC cédula 40 de hasta (10 cm) 4" y de cédula 80 de hasta (51 mm) 2"



CÓDIGO	CONTENIDO		DISTRIB.	MAYOREO	LISTA
109902	90 ml	50	\$34.00	\$49.00	\$60.00
109903	145 ml	24	\$44.00	\$63.00	\$78.00
109904	250 ml	24	\$64.00	\$91.00	\$113.00
109905	500 ml	12	\$115.00	\$165.00	\$205.00

Cemento para CPVC altas temperaturas, viscosidad alta

LATA

- ▶ Secado rápido
- ▶ Adecuado para altas temperaturas
- ▶ Adecuado para uso en cédulas 40 y 80, tuberías, caños, acoples de hasta (15 cm) 6"



CÓDIGO	CONTENIDO		DISTRIB.	MAYOREO	LISTA
109912	90 ml	50	\$41.00	\$59.00	\$72.00
109913	145 ml	24	\$54.00	\$77.00	\$95.00
109914	250 ml	24	\$81.00	\$116.00	\$143.00
109915	500 ml	12	\$135.00	\$195.00	\$240.00

Pegamento de contacto 5100

TUBO

- ▶ Gran fuerza de pegado en diversos materiales
- ▶ Resistente a la humedad y altas temperaturas
- ▶ Pegado flexible que acompaña la tensión del material
- ▶ Ideal para pegar linoleum, madera, cuero, plástico, metal, lona, alfombra, zoclos, etc.



CÓDIGO	CONTENIDO		DISTRIB.	MAYOREO	LISTA
109931	30 ml	24	\$24.00	\$34.00	\$42.00

Pegamento de contacto 5100

LATA

- ▶ Gran fuerza de pegado en diversos materiales
- ▶ Resistente a la humedad y altas temperaturas
- ▶ Pegado flexible que acompaña la tensión del material
- ▶ Ideal para pegar linoleum, madera, cuero, plástico, metal, lona, alfombra, zoclos, etc.



109932

109933

109935



CÓDIGO	CONTENIDO		DISTRIB.	MAYOREO	LISTA
109932	125 ml	12	\$52.00	\$74.00	\$92.00
109933	250 ml	12	\$76.00	\$109.00	\$134.00
109934	500 ml	12	\$140.00	\$200.00	\$245.00
109935	1 L	8	\$240.00	\$345.00	\$425.00

Clavo negro para concreto

BOLSA

- ▶ Clavo con tratamiento térmico para aumentar su dureza
- ▶ Fabricado con acero templado, lo que le da resistencia para usarse en concreto
- ▶ Bolsa de 1 kg



CÓDIGO	CALIBRE	LARGO			DISTRIB.	MAYOREO	LISTA
117130	9	3/4"	1 bolsa (1 kg)	10 bolsas (10 kg)	\$55.00	\$79.00	\$97.00
117131	9	1"	1 bolsa (1 kg)	10 bolsas (10 kg)	\$55.00	\$79.00	\$97.00
117132	9	1 1/2"	1 bolsa (1 kg)	10 bolsas (10 kg)	\$55.00	\$79.00	\$97.00
117133	9	2"	1 bolsa (1 kg)	10 bolsas (10 kg)	\$55.00	\$79.00	\$97.00
117134	9	2 1/2"	1 bolsa (1 kg)	10 bolsas (10 kg)	\$55.00	\$79.00	\$97.00
117135	9	3"	1 bolsa (1 kg)	10 bolsas (10 kg)	\$55.00	\$79.00	\$97.00
117136	8	3 1/2"	1 bolsa (1 kg)	10 bolsas (10 kg)	\$55.00	\$79.00	\$97.00
117137	7	4"	1 bolsa (1 kg)	10 bolsas (10 kg)	\$55.00	\$79.00	\$97.00

Mínimo a surtir 1 bolsa de 1 kilo

Clavo galvanizado para concreto

BOLSA

- ▶ Clavo con tratamiento térmico para aumentar su dureza
- ▶ Fabricado con acero templado, lo que le da resistencia para usarse en concreto
- ▶ Bolsa de 1 kg



CÓDIGO	CALIBRE	LARGO			DISTRIB.	MAYOREO	LISTA
117120	9	3/4"	1 bolsa (1 kg)	10 bolsas (10 kg)	\$60.00	\$86.00	\$106.00
117121	9	1"	1 bolsa (1 kg)	10 bolsas (10 kg)	\$60.00	\$86.00	\$106.00
117122	9	1 1/2"	1 bolsa (1 kg)	10 bolsas (10 kg)	\$60.00	\$86.00	\$106.00
117123	9	2"	1 bolsa (1 kg)	10 bolsas (10 kg)	\$60.00	\$86.00	\$106.00
117124	9	2 1/2"	1 bolsa (1 kg)	10 bolsas (10 kg)	\$60.00	\$86.00	\$106.00
117125	9	3"	1 bolsa (1 kg)	10 bolsas (10 kg)	\$60.00	\$86.00	\$106.00
117126	8	3 1/2"	1 bolsa (1 kg)	10 bolsas (10 kg)	\$60.00	\$86.00	\$106.00
117127	7	4"	1 bolsa (1 kg)	10 bolsas (10 kg)	\$60.00	\$86.00	\$106.00

Mínimo a surtir 1 bolsa de 1 kilo

Clavo estándar con cabeza

BOLSA

- ▶ Clavo pulido sin rebabas
- ▶ Fabricado con alambre trefilado
- ▶ Empacado en bolsa de 1 kg



CÓDIGO	CALIBRE	LARGO	KILOS x BOLSA			DISTRIB.	MAYOREO	LISTA
117101	14.5	1"	1 kg	1 bolsa (1 kg)	20 bolsas (20 kg)	\$55.00	\$79.00	\$97.00
117102	14.5	1 1/4"	1 kg	1 bolsa (1 kg)	20 bolsas (20 kg)	\$55.00	\$79.00	\$97.00
117103	14.5	1 1/2"	1 kg	1 bolsa (1 kg)	20 bolsas (20 kg)	\$55.00	\$79.00	\$97.00
117104	12.5	2"	1 kg	1 bolsa (1 kg)	20 bolsas (20 kg)	\$45.00	\$64.00	\$79.00
117105	11	2 1/2"	1 kg	1 bolsa (1 kg)	20 bolsas (20 kg)	\$45.00	\$64.00	\$79.00
117106	10	3"	1 kg	1 bolsa (1 kg)	20 bolsas (20 kg)	\$45.00	\$64.00	\$79.00
117107	8	3 1/2"	1 kg	1 bolsa (1 kg)	20 bolsas (20 kg)	\$45.00	\$64.00	\$79.00
117108	7	4"	1 kg	1 bolsa (1 kg)	20 bolsas (20 kg)	\$45.00	\$64.00	\$79.00
117109	6	5"	1 kg	1 bolsa (1 kg)	20 bolsas (20 kg)	\$45.00	\$64.00	\$79.00

Mínimo a surtir 1 bolsa de 1 kilo

Clavo galvanizado para lámina

BOLSA

- ▶ Fabricado en acero al carbono
- ▶ Galvanizado
- ▶ Cuerpo estriado para ofrecer mayor resistencia
- ▶ Ideal para fijar lámina metálica o de cartón sobre estructuras de madera
- ▶ Empacado en bolsa de 1 kg



CÓDIGO	LARGO	Ø	KILOS x BOLSA		DISTRIB.	MAYOREO	LISTA
117151	2 1/2"	5/32"	1 kg	25 bolsas (1 kg)	\$45.00	\$64.00	\$79.00

Mínimo a surtir 1 bolsa de 1 kilo

Cepillo limpiador de terminales de batería 4 en 1

BLÍSTER

- ▶ Limpia las terminales y postes de baterías
- ▶ Para limpieza de tubería de 1/2" y 3/4"
- ▶ Cerdas de acero

TUBERÍA DE 1/2" Y 3/4"



CÓDIGO			DISTRIB.	MAYOREO	LISTA
128401	12	144	\$48.00	\$69.00	\$85.00

Cepillo curvo, alambre ondulado

NUEVO

GRANEL

- ▶ Cepillo de acero latonado
- ▶ Para aplicaciones de reducción de estática
- ▶ Ideal para trabajos en cobre, plástico, plomo, aluminio y acero
- Medida: largo 24 cm x ancho 2 cm
- Carda: 3.2 cm, calibre 0.26 mm



CÓDIGO			DISTRIB.	MAYOREO	LISTA
109808	6	36	\$18.00	\$26.00	\$32.00

Cepillo de alambre con espátula 3 x 17 pinceles, mango recto

GRANEL

- ▶ Útil espátula, ideal para eliminar los excesos de pintura sin afectar el resto de la superficie
- ▶ Alambre de acero alto carbono diámetro 0,33 mm
- ▶ Elimina soldadura, óxido, pintura, adherencias en general
- ▶ Cómodo mango de polipropileno



CÓDIGO	LARGO	ANCHO			DISTRIB.	MAYOREO	LISTA
109803	33 cm	2,5 cm	6	36	\$25.00	\$36.00	\$44.00

Cepillo de alambre 3 x 17 pinceles, mango recto

GRANEL

- ▶ Alambre de acero alto carbono diámetro 0,33 mm
- ▶ Para limpieza y pulido de superficies metálicas, elimina soldadura, óxido, pintura, adherencias en general
- ▶ Cómodo mango de polipropileno



CÓDIGO	LARGO	ANCHO			DISTRIB.	MAYOREO	LISTA
109802	33 cm	2,5 cm	6	36	\$23.00	\$33.00	\$41.00

Cepillo de alambre 4 x 16 pinceles, mango curvo

GRANEL

- ▶ Alambre de acero alto carbono diámetro 0,33 mm
- ▶ Para limpieza y pulido de superficies metálicas, elimina soldadura, óxido, pintura, adherencias en general
- ▶ Cómodo mango de polipropileno



CÓDIGO	LARGO	ANCHO			DISTRIB.	MAYOREO	LISTA
109801	27 cm	3,1 cm	6	36	\$23.00	\$33.00	\$41.00

Cepillo de alambre 9 x 20 y 6 x 19 pinceles

GRANEL

- ▶ Alambre de acero alto carbono diámetro 0,33 mm
- ▶ Ideal para cardado en superficies planas
- ▶ Diseño de bloque útil para aplicar mayor presión y limpiar adherencias difíciles de quitar

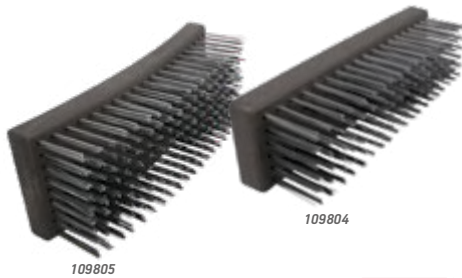

CÓDIGO	LARGO	ANCHO			DISTRIB.	MAYOREO	LISTA
109805	18,2 cm	7 cm	6	36	\$45.00	\$64.00	\$79.00
109804	18 cm	5 cm	6	36	\$30.00	\$43.00	\$53.00

Cepillo para impermeabilizar de 7 x 19 pinceles

GRANEL

- ▶ Cerdas 100% fibra natural
- ▶ Cabeza plástica super durable
- ▶ Disponible con mango de madera pulida o cabeza sola



CÓDIGO	MODELO		DISTRIB.	MAYOREO	LISTA
109811	Sin mango	32	\$62.00	\$89.00	\$109.00
109812	Con mango	12	\$82.00	\$117.00	\$145.00
109308	Mango	12	\$22.00	\$31.00	\$39.00

Cepillo para pintar semi-rígido de 7 x 14 pinceles

GRANEL

- ▶ Cerdas: 50% ixtle natural y 50% fibra sintética
- ▶ Mango ergonómico de diseño reforzado
- ▶ Se puede utilizar con extensión
- ▶ Ideal para pintar sobre superficies extra rugosas



CÓDIGO	CERDAS			DISTRIB.	MAYOREO	LISTA
109806	4,9 cm	6	36	\$55.00	\$79.00	\$97.00

Cepillo para pintar suave de 7 x 14 pinceles

GRANEL

- ▶ Cerdas: 60% cola caballo y 40% ixtle
- ▶ Mango ergonómico de diseño reforzado
- ▶ Se puede utilizar con extensión
- ▶ Ideal para pintar sobre superficies lisas y rugosas



CÓDIGO	CERDAS			DISTRIB.	MAYOREO	LISTA
109807	3,7 cm	6	36	\$60.00	\$86.00	\$106.00

Charola con rodillo para pintura profesional

CABALLETE

- ▶ Charola fabricada en polipropileno de alta resistencia
- ▶ Base reforzada y gran resistencia a toda clase de solventes
- ▶ Rodillo para superficies finas lisas que ahorra hasta un 10% de pintura



CÓDIGO	LARGO		DISTRIB.	MAYOREO	LISTA
106909	9"	14	\$60.00	\$86.00	\$106.00

Charola con rodillo para pintura

BOLSA Y GRANEL

- ▶ Rodillo para superficies lisas: Ahorra hasta un 10%
- ▶ Charola de de plástico negro



CÓDIGO	TAMAÑO		DISTRIB.	MAYOREO	LISTA
301511	9"	24	\$52.00	\$74.00	\$92.00

Charola para pintura profesional

GRANEL

- ▶ Charola fabricada en polipropileno de alta resistencia
- ▶ Base reforzada y gran resistencia a toda clase de solventes
- ▶ Amplios canales para desalojar exceso de pintura



CÓDIGO	LARGO		DISTRIB.	MAYOREO	LISTA
106908	9"	24	\$27.00	\$39.00	\$48.00

Charola para pintura

GRANEL

- ▶ Charola de plástico negro para uso con rodillo
- ▶ Mejora el aprovechamiento de la pintura



CÓDIGO	TAMAÑO		DISTRIB.	MAYOREO	LISTA
301512	9"	24	\$19.00	\$27.00	\$34.00

Cinzel

GRANEL

- ▶ Cuerpo hexagonal fabricado en Acero al Cromo Vanadio
- ▶ Laqueado para mayor resistencia a la corrosión
- ▶ Punta templada para mejorar su desempeño
- ▶ Cabeza ancha para facilitar el golpeo

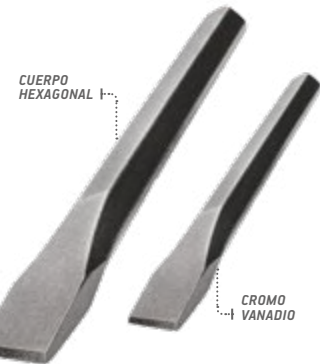

Cinzel SDS para rotomartillo

GRANEL

- ▶ Zanco 9/16" SDS
- ▶ Fabricados en Acero al Cromo



CÓDIGO	DESC.	ANCHO	LARGO		DISTRIB.	MAYOREO	LISTA	
100201	Punta	---	10"	6	48	\$48.00	\$69.00	\$85.00
100202	Plano delgado	3/4"	10"	6	48	\$48.00	\$69.00	\$85.00
100203	Plano grueso	1 1/2"	10"	6	48	\$62.00	\$89.00	\$109.00
100204	Azulejo	1 1/2"	10 1/2"	6	36	\$110.00	\$155.00	\$195.00
100205	Acanalado	3/4"	10"	6	48	\$76.00	\$109.00	\$134.00

Brocas y cinceles X2 SDS, juego de 15 piezas

NUEVO

CAJA

- ▶ 12 Brocas incluidas
- ▶ 3 Cinceles incluidos
- ▶ Estuche metálico



! Mas info pág. 47

CÓDIGO		DISTRIB.	MAYOREO	LISTA
100491	5	\$640.00	\$915.00	\$1,130.00



CÓDIGO	MEDIDA			DISTRIB.	MAYOREO	LISTA
101501	1/2" x 6"	8	40	\$32.00	\$46.00	\$56.00
101502	5/8" x 6"	8	40	\$33.00	\$47.00	\$58.00
101503	3/4" x 6"	8	32	\$45.00	\$64.00	\$79.00
101504	1/2" x 8"	8	40	\$38.00	\$54.00	\$67.00
101505	5/8" x 8"	8	40	\$43.00	\$61.00	\$76.00
101506	3/4" x 8"	8	32	\$50.00	\$71.00	\$88.00
101507	7/8" x 8"	6	24	\$72.00	\$103.00	\$127.00
101508	1" x 8"	6	24	\$85.00	\$121.00	\$150.00
101509	1/2" x 10"	8	40	\$43.00	\$61.00	\$76.00
101510	5/8" x 10"	8	40	\$48.00	\$69.00	\$85.00
101511	3/4" x 10"	8	32	\$59.00	\$84.00	\$104.00
101512	7/8" x 10"	6	24	\$80.00	\$114.00	\$141.00
101513	1" x 10"	6	24	\$95.00	\$136.00	\$170.00
101514	1/2" x 12"	8	40	\$50.00	\$71.00	\$88.00
101515	5/8" x 12"	8	40	\$55.00	\$79.00	\$97.00
101516	3/4" x 12"	8	32	\$65.00	\$93.00	\$115.00
101517	7/8" x 12"	6	24	\$95.00	\$136.00	\$170.00
101518	1" x 12"	6	24	\$110.00	\$155.00	\$195.00

Cincho de plástico color blanco

CABALLETE

- ▶ Seguro más resistente



PRECIO POR BOLSA



CÓDIGO	MEDIDA	TENSIÓN	PZAS X BOLSA			DISTRIB.	MAYOREO	LISTA
103001	10 cm x 2,5 mm	18 lbs.	100 pzas.	200 bolsas	400 Bolsas	\$10.00	\$14.30	\$17.60
103002	15 cm x 3,6 mm	40 lbs.	100 pzas.	100 bolsas	200 Bolsas	\$25.00	\$36.00	\$44.00
103020	15 cm x 3,6 mm	40 lbs.	50 pzas.	100 bolsas	200 Bolsas	\$13.00	\$18.60	\$22.90
103003	16,5 cm x 2,5 mm	18 lbs.	50 pzas.	200 bolsas	400 Bolsas	\$13.00	\$18.60	\$22.90
103021	16,5 cm x 2,5 mm	18 lbs.	100 pzas.	200 bolsas	400 Bolsas	\$19.00	\$27.00	\$34.00
103004	20 cm x 4,6 mm	50 lbs.	50 pzas.	50 bolsas	100 Bolsas	\$21.00	\$30.00	\$37.00
103005	20 cm x 3,6 mm	40 lbs.	50 pzas.	100 bolsas	200 Bolsas	\$17.00	\$24.30	\$30.00
103006	30 cm x 4,6 mm	50 lbs.	50 pzas.	100 bolsas	200 Bolsas	\$34.00	\$49.00	\$60.00
103007	37 cm x 4,6 mm	50 lbs.	25 pzas.	100 bolsas	200 Bolsas	\$22.00	\$31.00	\$39.00
103008	45 cm x 4,8 mm	50 lbs.	25 pzas.	100 bolsas	200 Bolsas	\$29.00	\$41.00	\$51.00
103009	50 cm x 4,8 mm	50 lbs.	25 pzas.	100 bolsas	200 Bolsas	\$31.00	\$44.00	\$55.00

Cincho de plástico color negro

CABALLETE

- ▶ Seguro más resistente



PRECIO POR BOLSA



CÓDIGO	MEDIDA	TENSIÓN	PZAS X BOLSA			DISTRIB.	MAYOREO	LISTA
103010	10 cm x 2,5 mm	18 lbs.	100 pzas.	200 bolsas	400 Bolsas	\$10.00	\$14.30	\$17.60
103011	15 cm x 3,6 mm	40 lbs.	100 pzas.	100 bolsas	200 Bolsas	\$25.00	\$36.00	\$44.00
103022	15 cm x 3,6 mm	40 lbs.	50 pzas.	100 bolsas	200 Bolsas	\$13.00	\$18.60	\$22.90
103012	16,5 cm x 2,5 mm	18 lbs.	50 pzas.	200 bolsas	400 Bolsas	\$13.00	\$18.60	\$22.90
103023	16,5 cm x 2,5 mm	18 lbs.	100 pzas.	200 bolsas	400 Bolsas	\$19.00	\$27.00	\$34.00
103013	20 cm x 4,6 mm	50 lbs.	50 pzas.	50 bolsas	100 Bolsas	\$21.00	\$30.00	\$37.00
103014	20 cm x 3,6 mm	40 lbs.	50 pzas.	100 bolsas	200 Bolsas	\$17.00	\$24.30	\$30.00
103015	30 cm x 4,6 mm	50 lbs.	50 pzas.	100 bolsas	200 Bolsas	\$34.00	\$49.00	\$60.00
103016	37 cm x 4,6 mm	50 lbs.	25 pzas.	100 bolsas	200 Bolsas	\$22.00	\$31.00	\$39.00
103017	45 cm x 4,8 mm	50 lbs.	25 pzas.	100 bolsas	200 Bolsas	\$29.00	\$41.00	\$51.00
103018	50 cm x 4,8 mm	50 lbs.	25 pzas.	100 bolsas	200 Bolsas	\$31.00	\$44.00	\$55.00

Cinta de amarre

TARJETA

- ▶ Cuerpo de acero recubierto de plástico que la hace más resistente
- ▶ Útil para sujetar objetos
- ▶ Optimiza espacios
- ▶ Práctico cortador



CORTADOR INCLUIDO

10 años GARANTÍA



CÓDIGO	LONGITUD			DISTRIB.	MAYOREO	LISTA
103019	30 m	12	48	\$20.00	\$29.00	\$35.00

Cinchos de plástico bote de 650 piezas

BOTE

- ▶ Seguro resistente
- ▶ Variedad de colores y tamaños
- ▶ Contiene: 650 piezas



Colores disponibles y medidas

2,5mmx100mm	3,6mmx150mm	3,6mmx200mm	4,8mmx200mm
Amarillo	Natural	Negro	Natural
Rojo	Rojo		
Azul			
Verde			



CÓDIGO	MEDIDA			DISTRIB.	MAYOREO	LISTA
306901	VARIAS	6	36	\$125.00	\$180.00	\$220.00

Cinta larga de fibra de vidrio

BLÍSTER

- ▶ Cinta que se adapta a cualquier superficie
- ▶ Alta resistencia al medio ambiente, humedad, polvo y sol



10 años GARANTÍA



CÓDIGO	LONGITUD			DISTRIB.	MAYOREO	LISTA
102801	20 m	6	24	\$140.00	\$200.00	\$245.00
102802	30 m	6	24	\$195.00	\$280.00	\$345.00
102803	50 m	6	24	\$265.00	\$380.00	\$465.00

Cinta larga de fibra de vidrio tipo cruceta

CAJA

- ▶ Mango antiderrapante
- ▶ Cuerpo plástico ligero y fácil de transportar
- ▶ Máxima resistencia



10 años GARANTÍA



CÓDIGO	LONGITUD		DISTRIB.	MAYOREO	LISTA
102811	30 m	24	\$170.00	\$245.00	\$300.00
102812	50 m	24	\$215.00	\$305.00	\$380.00
102813	100 m	12	\$425.00	\$605.00	\$750.00

Cinta de advertencia 90 m

GRANEL

- ▶ Fabricadas en polietileno de baja densidad
- ▶ Alta resistencia a la fricción



CÓDIGO	DESCRIPCIÓN	LARGO			DISTRIB.	MAYOREO	LISTA
112911	Precaución	90 m	3	12	\$48.00	\$69.00	\$85.00
112912	Peligro	90 m	3	12	\$48.00	\$69.00	\$85.00

Cinta de advertencia 300 m

GRANEL

- ▶ Fabricadas en polietileno de baja densidad
- ▶ Alta resistencia a la fricción



CÓDIGO	DESCRIPCIÓN	LARGO			DISTRIB.	MAYOREO	LISTA
112901	Precaución	300 m	3	12	\$95.00	\$136.00	\$170.00
112902	Peligro	300 m	3	12	\$95.00	\$136.00	\$170.00
112903	Prohibido	300 m	3	12	\$95.00	\$136.00	\$170.00

Cinta masking tape

GRANEL

- ▶ Fabricada en papel crepado con adhesivo de hule resina de alta adhesión
- ▶ Se despega sin dejar residuos y es resistente a la tensión y a la humedad

ADHESIVO DE HULE - RESINA



AKSI

CÓDIGO	ANCHO	LONGITUD			DISTRIB.	MAYOREO	LISTA
109101	1/2" - 13 mm	50 m	6	144	\$11.00	\$15.70	\$19.40
109102	3/4" - 19 mm	50 m	6	96	\$15.00	\$21.40	\$26.00
109103	1" - 25 mm	50 m	6	72	\$20.00	\$29.00	\$35.00
109104	1 1/2" - 38 mm	50 m	6	48	\$30.00	\$43.00	\$53.00
109105	2" - 50 mm	50 m	6	36	\$40.00	\$57.00	\$71.00

Cinta masking tape azul

GRANEL

- ▶ Fabricada en papel crepado con adhesivo de emulsión acrílica de adhesión media
- ▶ Se despega sin dejar residuos, es resistente a la tensión y humedad
- ▶ Puede ser expuesta a luz solar hasta 12 días

ADHESIVO ACRÍLICO



AKSI

CÓDIGO	ANCHO	LONGITUD			DISTRIB.	MAYOREO	LISTA
109111	12 mm	50 m	6	144	\$19.00	\$27.00	\$34.00
109112	18 mm	50 m	6	96	\$30.00	\$43.00	\$53.00
109113	24 mm	50 m	6	72	\$37.00	\$53.00	\$65.00
109114	36 mm	50 m	6	48	\$58.00	\$83.00	\$102.00
109115	48 mm	50 m	6	36	\$75.00	\$107.00	\$132.00

Cinta de empaque canela

GRANEL

- ▶ Adhesivo acrílico que mejora el anclaje
- ▶ Fabricada en película de polipropileno de gran resistencia en color canela
- ▶ Espesor de plástico 0.025 mm



PRECIO POR PIEZA

AKSI

CÓDIGO	ANCHO	LONGITUD	PZAS. POR PAQUETE			DISTRIB.	MAYOREO	LISTA
109001	48 mm	40 m	6	12	\$12.00	\$17.10	\$21.20	
109002	48 mm	50 m	6	12	\$15.00	\$21.40	\$26.00	
109003	48 mm	150 m	6	6	\$35.00	\$50.00	\$62.00	

Mínimo a surtir 6 piezas

Cinta para ductos, 0.24 mm

GRANEL

- ▶ Cinta de polietileno reforzado con malla textil
- ▶ Ideal para sellar ductos de aire, tuberías, mangueras y trabajos generales de mantenimiento
- ▶ Espesor 0.24 mm

POLIETILENO REFORZADO CON MALLA TEXTIL



AKSI

CÓDIGO	LONGITUD			DISTRIB.	MAYOREO	LISTA
109051	10 m	10	40	\$20.00	\$29.00	\$35.00
109052	30 m	10	40	\$50.00	\$71.00	\$88.00
109053	50 m	10	40	\$85.00	\$121.00	\$150.00

Cinta para ductos, 0.16 mm

GRANEL

- ▶ Cinta de polietileno reforzado
- ▶ Para usos generales de mantenimiento
- ▶ Cubre, sella y repara
- ▶ Espesor 0.16 mm

POLIETILENO REFORZADO CON MALLA TEXTIL



ITIMAXTOOL

CÓDIGO	LONGITUD			DISTRIB.	MAYOREO	LISTA
305911	10 m	10	40	\$15.00	\$21.40	\$26.00
305912	30 m	10	40	\$40.00	\$57.00	\$71.00
305913	50 m	10	40	\$60.00	\$86.00	\$106.00

Cinta de empaque transparente

GRANEL

- ▶ Adhesivo acrílico que mejora el anclaje
- ▶ Fabricada en película de polipropileno transparente de gran resistencia
- ▶ Espesor de plástico 0.025 mm



PRECIO POR PIEZA

AKSI

CÓDIGO	ANCHO	LONGITUD	PZAS. POR PAQUETE			DISTRIB.	MAYOREO	LISTA
109004	48 mm	40 m	6	12	\$12.00	\$17.10	\$21.20	
109005	48 mm	50 m	6	12	\$15.00	\$21.40	\$26.00	
109006	48 mm	150 m	6	6	\$35.00	\$50.00	\$62.00	

Mínimo a surtir 6 piezas

Cinta de aluminio

PROX.

GRANEL

- ▶ Fabricada en aluminio con adhesivo hot melt de alta adherencia
- ▶ Uso en interior y exterior
- ▶ Para reparaciones temporales en superficies de metal, aparatos de calefacción y refrigeración



AKSI

CÓDIGO	LONGITUD			DISTRIB.	MAYOREO	LISTA
109061	10 m	6	36	\$40.00	\$57.00	\$71.00
109062	30 m	6	36	\$95.00	\$136.00	\$170.00

Cinta de empaque transparente con despachador

PROX.

GRANEL

- ▶ Adhesivo acrílico que mejora el anclaje
- ▶ Fabricada en película de polipropileno transparente de gran resistencia



AKSI

CÓDIGO	ANCHO	LONGITUD			DISTRIB.	MAYOREO	LISTA
109091	48 mm	50 m	10	30	\$35.00	\$50.00	\$62.00

Cinta de aislar multicolores 18 m

GRANEL

- ▶ Fabricadas en PVC con base de adhesivo acrílico de alto anclaje, espesor de 0.18 mm
- ▶ Cumple con la prueba de ignición
- ▶ Elongación del 200%



CÓDIGO	LONGITUD	COLOR			DISTRIB.	MAYOREO	LISTA
105103	19 mm x 18 m	Blanca	12	144	\$11.00	\$15.70	\$19.40
105104	19 mm x 18 m	Roja	12	144	\$11.00	\$15.70	\$19.40
105105	19 mm x 18 m	Azul	12	144	\$11.00	\$15.70	\$19.40
105106	19 mm x 18 m	Verde	12	144	\$11.00	\$15.70	\$19.40
105107	19 mm x 18 m	Amarilla	12	144	\$11.00	\$15.70	\$19.40

Cinta de aislar negra 9 m y 18 m

GRANEL

- ▶ Fabricadas en PVC con base de adhesivo acrílico de alto anclaje
- ▶ Cumple con la prueba de ignición
- ▶ Espesor de 0.18 mm
- ▶ Elongación del 200%



CÓDIGO	LONGITUD	COLOR			DISTRIB.	MAYOREO	LISTA
105101	19 mm x 9 m	Negra	12	288	\$6.00	\$8.60	\$10.60
105102	19 mm x 18 m	Negra	12	144	\$11.00	\$15.70	\$19.40

Cinta de montaje 1.5 m y 5 m

TARJETA

- ▶ Cinta de espuma con pegamento en ambos lados
- ▶ Alta resistencia
- ▶ Adherencia permanente en la mayoría de las superficies



CÓDIGO	LONGITUD			DISTRIB.	MAYOREO	LISTA
109014	1.5 m	12	144	\$9.00	\$12.90	\$15.90
109015	5 m	12	144	\$18.00	\$26.00	\$32.00

Cinta de aislar multicolor de 15 m

GRANEL

- ▶ Fabricadas en PVC con adhesivo acrílico
- ▶ Espesor de 0.13 mm
- ▶ Elongación del 200%



CÓDIGO	LONGITUD	COLOR			DISTRIB.	MAYOREO	LISTA
305005	18 mm x 15 m	Blanca	12	192	\$7.00	\$10.00	\$12.30
305006	18 mm x 15 m	Roja	12	192	\$7.00	\$10.00	\$12.30
305007	18 mm x 15 m	Azul	12	192	\$7.00	\$10.00	\$12.30
305008	18 mm x 15 m	Verde	12	192	\$7.00	\$10.00	\$12.30
305009	18 mm x 15 m	Amarilla	12	192	\$7.00	\$10.00	\$12.30

Cinta de aislar negra 15 m

GRANEL, BLÍSTER Y CABALLETE

- ▶ Fabricadas en PVC con adhesivo acrílico
- ▶ Espesor de 0.13 mm
- ▶ Elongación del 100%



CÓDIGO	MEDIDA	PRESENTACIÓN			DISTRIB.	MAYOREO	LISTA
305002	18 mm x 15 m	Granel	12	192	\$7.00	\$10.00	\$12.30
305004	18 mm x 15 m	Blister	12	144	\$12.00	\$17.10	\$21.20
305031	18 mm x 15 m	Caballote 2 Pack	20 sets	80 sets	\$16.00	\$22.90	\$28.00
305032	18 mm x 15 m	Caballote 3 Pack	20 sets	80 sets	\$23.00	\$33.00	\$41.00

Cinta de aislar multicolor de 7 m

GRANEL

- ▶ Fabricadas en PVC con adhesivo acrílico
- ▶ Espesor de 0.13 mm
- ▶ Elongación del 200%



CÓDIGO	LONGITUD	COLOR			DISTRIB.	MAYOREO	LISTA
305010	18 mm x 7 m	Blanca	12	480	\$4.00	\$5.70	\$7.10
305011	18 mm x 7 m	Roja	12	480	\$4.00	\$5.70	\$7.10
305012	18 mm x 7 m	Azul	12	480	\$4.00	\$5.70	\$7.10
305013	18 mm x 7 m	Verde	12	480	\$4.00	\$5.70	\$7.10
305014	18 mm x 7 m	Amarilla	12	480	\$4.00	\$5.70	\$7.10

Cinta de aislar negra 7 m

GRANEL Y CABALLETE

- ▶ Fabricadas en PVC con adhesivo acrílico
- ▶ Espesor de 0.13 mm
- ▶ Elongación del 100%



CÓDIGO	MEDIDA	PRESENTACIÓN			DISTRIB.	MAYOREO	LISTA
305001	18 mm x 7 m	Granel	12	480	\$4.00	\$5.70	\$7.10
305021	18 mm x 7 m	Caballote 2 Pack	20 sets	80 sets	\$10.00	\$14.30	\$17.60
305022	18 mm x 7 m	Caballote 4 Pack	20 sets	80 sets	\$17.00	\$24.30	\$30.00

Cinta teflón sella roscas, uso industrial



CAJA

- ▶ Teflón de alta densidad
- ▶ Mayor resistencia, hasta x3 sobre las cintas regulares
- ▶ Resistencia a temperaturas extremas -100°C a 250°C
- ▶ Resistencia a agentes químicos y corrosivos



AKSI

PRECIO POR PIEZA

CÓDIGO	ANCHO	LONGITUD	PZAS. POR PAQUETE		DISTRIB.	MAYOREO	LISTA
106021	1/2"	7 m	10	50	\$7.00	\$10.00	\$12.30
106031	1/2"	13 m	10	50	\$11.00	\$15.70	\$19.40
106032	3/4"	13 m	10	50	\$16.00	\$22.90	\$28.00
106033	1"	13 m	10	50	\$22.00	\$31.00	\$39.00

Mínimo a surtir 1 caja con 10 piezas

Cinta teflón sella roscas, 7 y 13 m

CAJA / BLÍSTER

- ▶ Puede usarse en tuberías de cualquier material
- ▶ Resistentes a todo tipo de temperaturas, solventes, ácidos y químicos corrosivos
- ▶ Alto rendimiento



AKSI

PRECIO POR PIEZA

CÓDIGO	ANCHO	LONGITUD	EMPAQUE	PZAS. x PAQUETE		DISTRIB.	MAYOREO	LISTA
106001	1/2"	7 m	Caja	10	50	\$3.00	\$4.30	\$5.30
106006	1/2"	7 m	Blister	2	25	\$8.00	\$11.40	\$14.10
106002	3/4"	7 m	Caja	10	50	\$4.00	\$5.70	\$7.10
106003	1"	7 m	Caja	10	50	\$5.00	\$7.10	\$8.80
106011	1/2"	13 m	Caja	10	50	\$4.00	\$5.70	\$7.10
106012	3/4"	13 m	Caja	10	50	\$5.00	\$7.10	\$8.80
106013	1"	13 m	Caja	10	50	\$6.60	\$9.40	\$11.60

Mínimo a surtir 1 caja con 10 piezas

Cinta teflón sella roscas, eco

TERMOENCOGIBLE

- ▶ Puede usarse en tuberías de cualquier material
- ▶ Resistentes a solventes, ácidos y químicos corrosivos



ITI MAXTOOL

PRECIO POR PIEZA

CÓDIGO	ANCHO	LONGITUD	PZAS. POR PAQUETE		DISTRIB.	MAYOREO	LISTA
300701	1/2"	7 m	10	100	\$2.00	\$2.90	\$3.50
300702	3/4"	7 m	10	100	\$3.00	\$4.30	\$5.30

Mínimo a surtir 1 caja con 10 piezas

Cinta antiderrapante

CAJA A COLOR

- ▶ Excelente adherencia
- ▶ Brinda seguridad en: bañeras, duchas, albercas, baños
- ▶ Para uso en superficies no texturizadas
- ▶ Cinta de 50 mm de ancho



AKSI

CÓDIGO	ESPECIFICACIONES	LONGITUD			DISTRIB.	MAYOREO	LISTA
109021	1 Rollo, negro	5 m	6	36	\$90.00	\$129.00	\$160.00

Figuras antiderrapantes

CABALLETE

- ▶ Seguridad para los más pequeños
- ▶ Excelente adherencia
- ▶ Para uso en superficies húmedas



109035

109036

109037

109038

109039

AKSI

CÓDIGO	FIGURA	PZAS X BOLSA	MEDIDA			DISTRIB.	MAYOREO	LISTA
109035	Pato	5 Figuras	10 x 10 cm	6	36	\$40.00	\$57.00	\$71.00
109036	Pez	5 Figuras	10 x 11 cm	6	36	\$40.00	\$57.00	\$71.00
109037	Rana	5 Figuras	10 x 11 cm	6	36	\$40.00	\$57.00	\$71.00
109038	Balón	5 Figuras	10 x 10 cm	6	36	\$40.00	\$57.00	\$71.00
109039	Flor	5 Figuras	10 x 10 cm	6	36	\$40.00	\$57.00	\$71.00

Conector de plástico macho y hembra

TARJETA

- ▶ Construidos en resistente plástico ABS
- ▶ Conexión que une o extiende mangueras de 1/2", 3/4" y 5/8"
- ▶ Cuerda estándar



102415
102420

102412
102414



CÓDIGO	TIPO	Ø	📦	📦	DISTRIB.	MAYOREO	LISTA
102412	Macho	1/2"	12	72	\$9.00	\$12.90	\$15.90
102414	Macho	5/8" - 3/4"	12	72	\$11.00	\$15.70	\$19.40
102415	Hembra	5/8" - 3/4"	12	72	\$11.00	\$15.70	\$19.40
102420	Hembra	1/2"	12	72	\$9.00	\$12.90	\$15.90

Reparador para manguera

TARJETA

- ▶ Construidos en resistente plástico ABS
- ▶ Conexión que une, repara o extiende mangueras de 1/2", 3/4" y 5/8"



CÓDIGO	Ø	📦	📦	DISTRIB.	MAYOREO	LISTA
102413	1/2"	12	72	\$12.00	\$17.10	\$21.20
102419	5/8" - 3/4"	12	72	\$13.00	\$18.60	\$22.90

Conectores para riego juego de 4 piezas

TARJETA

- ▶ Ideal para intercambiar al instante mangueras y accesorios de riego con conectores click
- ▶ Interrumpe el flujo de agua al desconectarse
- ▶ Cuerda estándar de 3/4" NPT
- ▶ Incluye empaque



CÓDIGO	ROSCA	TIPO	📦	📦	DISTRIB.	MAYOREO	LISTA
102411	3/4"	Macho/Hembra	12	72	\$45.00	\$64.00	\$79.00

Empaque de hule para manguera

BOLSA

- ▶ Medida estándar para colocarse en cualquier tipo de conexión con cuerda de 3/4"
- ▶ Práctico sistema para despachar por piezas



PRECIO POR BOLSA

CÓDIGO	Ø	📦	📦	DISTRIB.	MAYOREO	LISTA
102418	3/4"	100 pzas x bolsa	10 bolsas	\$45.00	\$64.00	\$79.00

Empacado en bolsa con 100 piezas

Conexión sencilla de latón maquinado

BLÍSTER

- ▶ Cuerda estándar de 3/4" NPT
- ▶ Conexión incluye empaque de hule
- ▶ Para mangueras de 1/2"



102401 MACHO



102402 HEMBRA



CÓDIGO	TIPO	Ø	📦	📦	DISTRIB.	MAYOREO	LISTA
102401	Macho	1/2"	12	60	\$25.00	\$36.00	\$44.00
102402	Hembra	1/2"	12	60	\$25.00	\$36.00	\$44.00

Conexión sencilla hembra de latón

GRANEL Y CABALLETE

- ▶ Conexiones de resistente latón maquinado
- ▶ Cuerda estándar de 3/4" NPT
- ▶ Conexión circular estriada
- ▶ Incluye empaque



302312



CÓDIGO	PRES.	Ø	📦	📦	DISTRIB.	MAY.	LISTA
302302	Granel	1/2"	Bolsa c/12 pzas	20 Bolsas	\$14.00	\$20.00	\$24.70
302304	Granel	5/8"	Bolsa c/12 pzas	20 Bolsas	\$14.00	\$20.00	\$24.70
302306	Granel	3/4"	Bolsa c/12 pzas	20 Bolsas	\$14.00	\$20.00	\$24.70
302312	Caballote	1/2"	12	240	\$15.00	\$21.40	\$26.00

Chiflón de latón para manguera

BLÍSTER

- ▶ Cuerpo 100% de latón de alta resistencia
- ▶ Ajustable para riego a chorro y fino rocío
- ▶ Incluye empaque



104001

CÓDIGO	TAMAÑO	📦	📦	DISTRIB.	MAYOREO	LISTA
104001	3"	6	60	\$48.00	\$69.00	\$85.00
104002	3 1/2"	6	60	\$57.00	\$81.00	\$101.00



Juego de conexión macho/ hembra de latón para manguera

BLÍSTER

- ▶ Su construcción las hace extra resistentes
- ▶ Cuerda estándar de 3/4" NPT
- ▶ Incluye conexión macho y hembra



102403



CÓDIGO	TIPO	Ø	📦	📦	DISTRIB.	MAYOREO	LISTA
102403	Macho/Hembra	1/2"	12	60	\$43.00	\$61.00	\$76.00
102404	Macho/Hembra	5/8"	12	60	\$45.00	\$64.00	\$79.00
102405	Macho/Hembra	3/4"	12	60	\$45.00	\$64.00	\$79.00

Conexión sencilla macho de latón

GRANEL Y CABALLETE

- ▶ Conexiones de resistente latón maquinado
- ▶ Cuerda estándar de 3/4" NPT
- ▶ Conexión circular estriada



302313



CÓDIGO	PRES.	Ø	📦	📦	DISTRIB.	MAY.	LISTA
302303	Granel	1/2"	Bolsa c/12 pzas	20 Bolsas	\$11.00	\$15.70	\$19.40
302305	Granel	5/8"	Bolsa c/12 pzas	20 Bolsas	\$12.00	\$17.10	\$21.20
302307	Granel	3/4"	Bolsa c/12 pzas	20 Bolsas	\$12.00	\$17.10	\$21.20
302313	Caballote	1/2"	12	240	\$13.00	\$18.60	\$22.90

Chiflón plástico para manguera

TARJETA

- ▶ Resistente cuerpo de polipropileno
- ▶ Casquillo de ABS
- ▶ Incluye empaque



CÓDIGO	Ø	📦	📦	DISTRIB.	MAYOREO	LISTA
300601	4"	48	288	\$12.00	\$17.10	\$21.20



Cortador de azulejo profesional con baleros

CAJA

- ▶ Correderas y palanca que se deslizan sobre baleros
- ▶ Cuerpo robusto de lámina de acero al carbono
- ▶ Área de corte protegida con acolchonamiento
- ▶ Incluye cuchilla de carburo de tungsteno recubierta con titanio
- ▶ Incluye escuadra



10

años

GARANTÍA

AKSI

CÓDIGO	CAP. DE CORTE		DISTRIB.	MAYOREO	LISTA
104331	40 cm	3	\$800.00	\$1,145.00	\$1,410.00
104332	60 cm	3	\$900.00	\$1,285.00	\$1,590.00

Cortador de azulejo profesional

CAJA

- ▶ Cuerpo robusto de lámina de acero al carbono
- ▶ Área de corte protegida con acolchonamiento
- ▶ Incluye escuadra y cuchilla de carburo de tungsteno



10

años

GARANTÍA

AKSI

CÓDIGO	CAP. DE CORTE		DISTRIB.	MAYOREO	LISTA
104321	40 cm	4	\$475.00	\$680.00	\$840.00

Compatible con los cortadores de azulejo AKSI®



Cuchilla de carburo de tungsteno recubierto de titanio

- ▶ Se recomienda usar con los cortadores de azulejo AKSI® (códigos: 104331 y 104332)

CÓDIGO	Ø	ESPESOR			DISTRIB.	MAYOREO	LISTA
104393	22 mm	2 mm	12	120	\$75.00	\$107.00	\$132.00

AKSI

Compatible con los cortadores de azulejo AKSI®



Cuchilla de carburo de tungsteno

- ▶ Se recomienda usar con los cortadores de azulejo AKSI® (código: 104321)

CÓDIGO	Ø	ESPESOR			DISTRIB.	MAYOREO	LISTA
104392	16 mm	1.5 mm	12	120	\$65.00	\$93.00	\$115.00

AKSI

Cortador de azulejo 4 en 1

CAJA

- ▶ 4 en 1:
 1. Corte recto
 2. Corte angular
 3. Corte circular
 4. Escuadra ajustable (derecha - izquierda)
- ▶ Cuchilla angular para cortes circulares
- ▶ Cuchillas de carburo de tungsteno
- ▶ Barras recubiertas de cromo para evitar desgaste
- ▶ Bujes de alta precisión
- ▶ Con base y manivela de acero
- ▶ Para cortes de 0° a 45°



18

meses

GARANTÍA

IT MAXTOOL

CÓDIGO	CAP. DE CORTE		DISTRIB.	MAYOREO	LISTA
300911	40 cm	4	\$600.00	\$855.00	\$1,060.00
300912	60 cm	4	\$700.00	\$1,000.00	\$1,235.00

Cortador de azulejo

CAJA

- ▶ Herramienta para cortar loseta o azulejo
- ▶ Base metálica graduada
- ▶ Cuchilla circular de carburo de tungsteno



18

meses

GARANTÍA

IT MAXTOOL

CÓDIGO	CAP. DE CORTE		DISTRIB.	MAYOREO	LISTA
300901	40 cm	6	\$215.00	\$305.00	\$380.00
300903	60 cm	4	\$450.00	\$645.00	\$795.00

Compatible con los cortadores de azulejo Maxtool®

Cuchilla de carburo de tungsteno



TARJETA

- ▶ Para un mayor rendimiento se recomienda usar con los cortadores de azulejo Maxtool®



IT MAXTOOL

CÓDIGO	Ø	ESPESOR			DISTRIB.	MAYOREO	LISTA
300902	16 mm	1.5 mm	12	120	\$40.00	\$57.00	\$71.00

Cortador de vidrio

BLÍSTER

- ▶ Cuchilla de carburo de tungsteno de 5.3 mm de diámetro
- ▶ Ranuras de diferente calibre y bola para ruptura de vidrio
- ▶ Fabricado en aluminio con diseño de bola en el extremo
- ▶ Acabado en pintura electrostática



CÓDIGO			DISTRIB.	MAYOREO	LISTA
107401	12	96	\$35.00	\$50.00	\$62.00

Cortador de vidrio tipo alemán

BLÍSTER

- ▶ Cabeza con 6 cuchillas intercambiables de carburo de tungsteno de 4.3 mm de diámetro
- ▶ Ranuras de diferente calibre para ruptura de vidrio
- ▶ Cómodo mango de madera perfileada



ACABADO CROMO SATINADO 1...

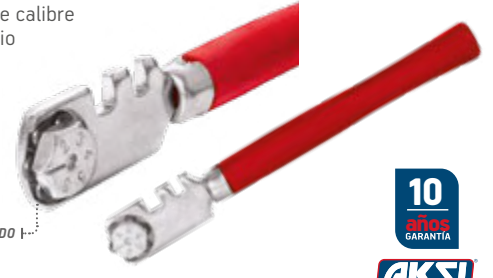

CÓDIGO			DISTRIB.	MAYOREO	LISTA
107402	12	96	\$37.00	\$53.00	\$65.00

Cortador de tubo 1 1/8"

BLÍSTER

- ▶ Útil para cortar tubos de cobre, aluminio y latón
- ▶ Aditamento retráctil, para quitar rebabas



Repuestos para cortador de tubo

112102



CÓDIGO			DISTRIB.	MAYOREO	LISTA
112101	6	72	\$120.00	\$170.00	\$210.00
112102	12	72	\$28.00	\$40.00	\$49.00

Cortador de tubo 1 1/8"

BLÍSTER

- ▶ Útil para cortar tubos de cobre, aluminio y latón
- ▶ Aditamento retráctil, para quitar rebabas



Repuestos cortador de tubo

305802



CÓDIGO			DISTRIB.	MAYOREO	LISTA
305801	6	36	\$82.00	\$117.00	\$145.00
305802	24	144	\$27.00	\$39.00	\$48.00

Cortador de tubo 1 1/8"

BLÍSTER

- ▶ Útil para cortar tubos de cobre, aluminio y latón
- ▶ Cuchillas de acero
- ▶ Para cortes de difícil acceso



CÓDIGO	DIÁMETRO DE CORTE			DISTRIB.	MAYOREO	LISTA
112103	30 mm - 1 1/8"	6	36	\$105.00	\$150.00	\$185.00

Cortador de tubo plástico

BLÍSTER

- ▶ Cuerpo de aluminio
- ▶ Cuchilla fabricada en acero inoxidable de alta resistencia
- ▶ Ideal para cortar tubos de PVC, CPVC, PP-R, PEX, POLY, PE y mangueras de goma



APERTURA AUTOMÁTICA 1...



CÓDIGO	DIÁMETRO DE CORTE			DISTRIB.	MAYOREO	LISTA
112110	42 mm - 1 5/8"	6	24	\$100.00	\$143.00	\$175.00

Avellanador

BLÍSTER

- ▶ Para tubos de \varnothing 3/16" - 5/8"



CÓDIGO	DIÁMETRO			DISTRIB.	MAYOREO	LISTA
112120	3/16"- 5/8"	6	24	\$200.00	\$285.00	\$355.00

Juego de avellanador y cortador de tubo

BLÍSTER

- ▶ Para tubos de \varnothing 3/16" - 5/8"
- ▶ Corta tubos de cobre, aluminio y latón



CÓDIGO	DIÁMETRO			DISTRIB.	MAYOREO	LISTA
112122	3/16"	6	12	\$310.00	\$445.00	\$545.00

Corta círculo, juego de 3 piezas

BLÍSTER

- ▶ Útiles en cualquier tipo de madera
- ▶ Facilitan la instalación de cerraduras

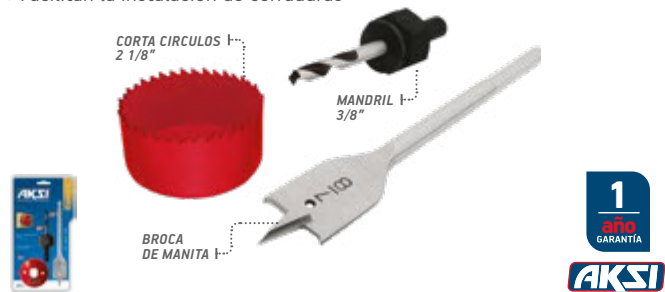

CÓDIGO			DISTRIB.	MAYOREO	LISTA
109501	6	60	\$50.00	\$71.00	\$88.00

Corta círculo, juego de 5 piezas

BLÍSTER

- ▶ Útiles en cualquier tipo de madera
- ▶ Facilitan la instalación de cerraduras
- ▶ 4 medidas distintas para diversos usos



CÓDIGO			DISTRIB.	MAYOREO	LISTA
109502	6	60	\$55.00	\$79.00	\$97.00

Cortapernos profesional

CAJA

- ▶ Cuchillas de acero al cromo molibdeno
- ▶ Mango antiderrapante
- ▶ Mayor palanca, menor esfuerzo
- ▶ No utilice el producto para cortar una medida mayor a la especificada

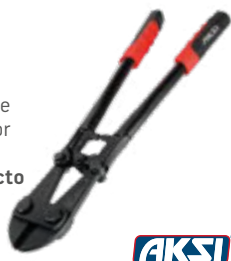

CÓDIGO	CAPACIDAD DE CORTE	LONG.			DISTRIB.	MAYOREO	LISTA
101101	5 mm	12"	4	16	\$200.00	\$285.00	\$355.00
101102	6 mm	14"	4	16	\$220.00	\$315.00	\$390.00
101103	8 mm	18"	2	8	\$285.00	\$405.00	\$505.00
101104	10 mm	24"	2	6	\$370.00	\$530.00	\$655.00
101105	12 mm	30"	2	4	\$540.00	\$770.00	\$955.00
101106	14 mm	36"	2	4	\$690.00	\$985.00	\$1,215.00

Cuchilla para cortapernos

CAJA

- ▶ Cuchillas de acero al cromo molibdeno



CÓDIGO	USO EN CORTAPEROS DE			DISTRIB.	MAYOREO	LISTA
101111	12"	4	12	\$95.00	\$136.00	\$170.00
101112	14"	4	12	\$105.00	\$150.00	\$185.00
101113	18"	2	12	\$135.00	\$195.00	\$240.00
101114	24"	2	12	\$180.00	\$255.00	\$320.00
101115	30"	2	12	\$245.00	\$350.00	\$430.00
101116	36"	1	8	\$320.00	\$455.00	\$565.00

Cortapernos

CAJA

- ▶ No utilice el producto para cortar una medida mayor a la especificada



CÓDIGO	CAPACIDAD DE CORTE	LONG.			DISTRIB.	MAYOREO	LISTA
306501	5 mm	12"	4	16	\$160.00	\$230.00	\$280.00
306502	6 mm	14"	4	16	\$180.00	\$255.00	\$320.00
306503	8 mm	18"	2	8	\$220.00	\$315.00	\$390.00
306504	10 mm	24"	2	6	\$325.00	\$465.00	\$575.00
306505	12 mm	30"	2	4	\$445.00	\$635.00	\$785.00
306506	14 mm	36"	2	4	\$570.00	\$815.00	\$1,005.00

Cutter alma metálica de 5"

BLÍSTER / BOLSA

- ▶ Cuerpo metálico que brinda mayor presión logrando cortes más exactos
- ▶ Navaja de acero SK5 dos veces más resistente y durable
- ▶ Práctico compartimento para repuestos
- ▶ Incluye 3 cuchillas



BLÍSTER

CÓDIGO	TAMAÑO			DISTRIB.	MAYOREO	LISTA
102102	127 mm - 5"	12	144	\$21.00	\$30.00	\$37.00

BOLSA

CÓDIGO	TAMAÑO			DISTRIB.	MAYOREO	LISTA
102101	127 mm - 5"	12	144	\$16.00	\$22.90	\$28.00

Cutter alma metálica de 6"

BLÍSTER

- ▶ Cuerpo metálico que brinda mayor presión logrando cortes más exactos
- ▶ Navaja de acero SK5 dos veces más resistente y durable
- ▶ Práctico compartimento para repuestos
- ▶ Ideal para uso rudo
- ▶ Incluye 3 cuchillas



CÓDIGO	TAMAÑO			DISTRIB.	MAYOREO	LISTA
102104	152 mm - 6"	12	72	\$23.00	\$33.00	\$41.00

Cutter plástico de 6"

BLÍSTER

- ▶ Navaja SK5 dos veces más resistente y durable
- ▶ Útil para uso en el hogar, escuela y oficina



CÓDIGO	TAMAÑO			DISTRIB.	MAYOREO	LISTA
102103	152 mm - 6"	12	72	\$21.00	\$30.00	\$37.00

Cutter para acrílico

BLÍSTER

- ▶ Fabricado con plástico ABS y cuerpo metálico
- ▶ Para trabajos de oficina y hogar
- ▶ Incluye 1 cuchilla curva y 1 cuchilla recta



PORTACUCHILLAS



CÓDIGO	TAMAÑO			DISTRIB.	MAYOREO	LISTA
304011	127 mm - 5"	12	240	\$35.00	\$50.00	\$62.00

Cutter plástico de 5"

BOLSA

- ▶ Fabricado con plástico ABS
- ▶ Para trabajos de oficina y hogar



CÓDIGO	TAMAÑO			DISTRIB.	MAYOREO	LISTA
304003	127 mm - 5"	12	144	\$5.40	\$7.70	\$9.50

Cutter plástico de 6"

BOLSA

- ▶ Fabricado con plástico ABS
- ▶ Para trabajos de oficina y hogar

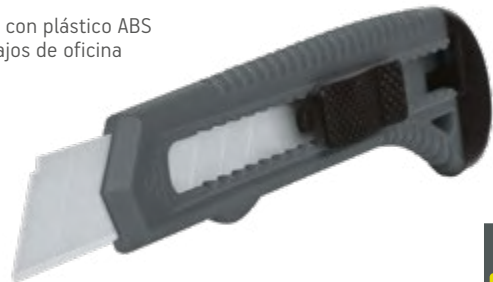

CÓDIGO	TAMAÑO			DISTRIB.	MAYOREO	LISTA
304004	152 mm - 6"	12	72	\$10.00	\$14.30	\$17.60

Navaja abatible

BLÍSTER

- ▶ Ranura para corte de hilos
- ▶ Clip porta navaja de acero inoxidable
- ▶ Mango de aluminio endurecido, forrado con goma termoplástica
- ▶ Sistema de bloqueo seguro

INCLUYE:

- ▶ 6 Cuchillas de 19 mm de acero SK6



10 años GARANTÍA

AKSI

CÓDIGO	CUCHILLA			DISTRIB.	MAYOREO	LISTA
102108	19 mm - 3/4"	6	36	\$135.00	\$195.00	\$240.00

Juego de 10 cuchillas 5" y 6" repuesto para cutter

TARJETA

- ▶ Cuchillas fabricadas en acero SK5 dos veces más resistente y durables
- ▶ Ideal para cortes de alta precisión
- ▶ Compatibles con cutters de 5" ó 6"
- ▶ Incluye práctico estuche plástico
- ▶ Estuche con 10 cuchillas



AKSI

PRECIO POR ESTUCHE

CÓDIGO	TAMAÑO			DISTRIB.	MAYOREO	LISTA
102105	84 mm - 5"	12	144	\$13.00	\$18.60	\$22.90
102106	152 mm - 6"	12	144	\$18.00	\$26.00	\$32.00

Raspador con navaja 1 1/2"

BLÍSTER

- ▶ Cuerpo fabricado en acero
- ▶ Mango ergonómico
- ▶ Seguro que permite mejor fijación de la hoja
- ▶ Ideal para limpiar pegamento, pintura, silicón y cemento de superficies lisas como vidrio, azulejo, paredes y metal

INCLUYE:

- ▶ Navaja de acero SK5 2X



10 años GARANTÍA

AKSI

CÓDIGO	TAMAÑO			DISTRIB.	MAYOREO	LISTA
102121	40 mm - 1 1/2"	12	96	\$55.00	\$79.00	\$97.00

Navaja multiusos de aluminio

BLÍSTER

- ▶ Mango ergonómico antiderrapante
- ▶ Compartimento en el cuerpo de la navaja para guardar los repuestos

INCLUYE:

- ▶ 1 Cuchilla para corte de acrílico
- ▶ 5 Cuchillas de repuesto fabricadas en acero SK5



10 años GARANTÍA

AKSI

CÓDIGO			DISTRIB.	MAYOREO	LISTA
102107	6	72	\$81.00	\$116.00	\$143.00

Cuchilla para navaja

TARJETA

- ▶ Cuchillas fabricadas en acero SK5
- ▶ Ideal para cortes de alta precisión
- ▶ Repuestos para navaja Cód. 102107 y 102108 AKSI®



AKSI

PRECIO POR ESTUCHE

CÓDIGO	ESTUCHE			DISTRIB.	MAYOREO	LISTA
102109	5 navajas	12	144	\$13.50	\$19.30	\$23.80
102110	10 navajas	12	144	\$16.00	\$22.90	\$28.00

Raspador mini con navaja 1 1/2"

BLÍSTER

- ▶ Navaja fabricada en acero al alto carbono
- ▶ Ideal para limpiar pegamento, pintura, silicón y cemento de superficies lisas como vidrio, azulejo, paredes y metal



10 años GARANTÍA

AKSI

CÓDIGO	TAMAÑO			DISTRIB.	MAYOREO	LISTA
102122	40 mm - 1 1/2"	12	180	\$8.00	\$11.40	\$14.10

Cuchillo para linóleo

GRANEL

- ▶ Mango ergonómico fabricado en resistente madera tratada y perfilada
- ▶ Cuchilla fabricada en acero inoxidable



HOJA RECTIFICADA A LO LARGO DE TODO EL MANGO



CÓDIGO	TAMAÑO			DISTRIB.	MAYOREO	LISTA
105402	152 mm - 6"	12	60	\$35.00	\$50.00	\$62.00

Cuchillo para electricista

GRANEL

- ▶ Mango ergonómico fabricado en resistente madera tratada y perfilada
- ▶ Cuchilla fabricada en acero inoxidable



HOJA RECTIFICADA A LO LARGO DE TODO EL MANGO



CÓDIGO	TAMAÑO			DISTRIB.	MAYOREO	LISTA
105403	152 mm - 6"	12	60	\$35.00	\$50.00	\$62.00

Cuñas con mango de plástico, juego de 4 piezas

CABALLETE

- ▶ Medidas: 50 mm, 80 mm, 100 mm y 120 mm
- ▶ Ideal para raspar, resanar, etc.

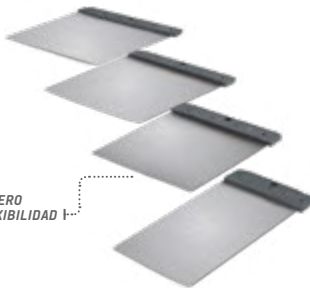

HOJAS DE ACERO DE ALTA FLEXIBILIDAD



CÓDIGO			DISTRIB.	MAYOREO	LISTA
300131	12	96	\$19.00	\$27.00	\$34.00

Cuchara de albañil tipo Filadelfia

GRANEL

- ▶ Templada en acero alto carbono
- ▶ Hoja pulida y laqueada
- ▶ Mango de madera, pulido y laqueado con casquillo metálico
- ▶ Unión perfecta en soldadura del puente del zanco y la hoja



CÓDIGO	TAMAÑO			DISTRIB.	MAYOREO	LISTA
304301	6"	12	60	\$35.00	\$50.00	\$62.00
304302	7"	12	60	\$37.00	\$53.00	\$65.00
304303	8"	12	60	\$43.00	\$61.00	\$76.00
304304	9"	12	60	\$48.00	\$69.00	\$85.00
304305	10"	12	60	\$50.00	\$71.00	\$88.00
304306	11"	12	60	\$57.00	\$81.00	\$101.00

Cuchara de albañil tipo Mérida

GRANEL

- ▶ Templada en acero alto carbono
- ▶ Hoja pulida y laqueada
- ▶ Mango de madera pulido y laqueado con casquillo metálico
- ▶ Unión perfecta en soldadura del puente del zanco y la hoja



CÓDIGO	TAMAÑO			DISTRIB.	MAYOREO	LISTA
304308	7"	12	60	\$42.00	\$60.00	\$74.00
304309	8"	12	60	\$45.00	\$64.00	\$79.00
304310	9"	12	60	\$50.00	\$71.00	\$88.00

Cuchara de albañil tipo Guadalajara

GRANEL

- ▶ Templada en acero alto carbono
- ▶ Hoja pulida y laqueada
- ▶ Mango de madera pulido y laqueado con casquillo metálico
- ▶ Unión perfecta en soldadura entre el puente del zanco y la hoja



CÓDIGO	TAMAÑO			DISTRIB.	MAYOREO	LISTA
304307	9"	12	60	\$57.00	\$81.00	\$101.00

Desarmador Comfort Grip: punta de cruz, punta cabinet, punta plana



TARJETA PLÁSTICA

- ▶ Mango Comfort Grip de alta resistencia
- ▶ Barra fabricada en acero al cromo vanadio
- ▶ Espiga insertada hasta 30% del mango
- ▶ Punta imantada



ACERO AL CROMO VANADIO

MANGO COMFORT GRIP



CRUZ



CABINET



PLANA



CÓDIGO	DIÁMETRO			DISTRIB.	MAYOREO	LISTA
104941	1/8 x 2 1/2"	6	96	\$16.00	\$22.90	\$28.00
104942	1/8" x 4"	6	96	\$16.00	\$22.90	\$28.00
104943	1/8" x 6"	6	96	\$17.00	\$24.30	\$30.00
104944	1/8" x 8"	6	96	\$19.00	\$27.00	\$34.00
104945	3/16" x 3"	6	96	\$20.00	\$29.00	\$35.00
104946	3/16" x 6"	6	96	\$25.00	\$36.00	\$44.00
104947	3/16" x 8"	6	96	\$25.00	\$36.00	\$44.00
104948	1/4" x 1 1/2"	6	96	\$20.00	\$29.00	\$35.00
104949	1/4" x 4"	6	96	\$25.00	\$36.00	\$44.00
104950	1/4" x 6"	6	96	\$26.00	\$37.00	\$46.00
104951	1/4" x 8"	6	96	\$29.00	\$41.00	\$51.00
104952	5/16" x 6"	6	96	\$37.00	\$53.00	\$65.00

CÓDIGO	DIÁMETRO			DISTRIB.	MAYOREO	LISTA
104971	1/8 x 2 1/2"	6	96	\$17.00	\$24.30	\$30.00
104972	1/8" x 3"	6	96	\$17.00	\$24.30	\$30.00
104973	1/8" x 4"	6	96	\$17.00	\$24.30	\$30.00
104974	1/8" x 6"	6	96	\$18.00	\$26.00	\$32.00
104975	1/8" x 8"	6	96	\$19.00	\$27.00	\$34.00
104976	3/16" x 3"	6	96	\$19.00	\$27.00	\$34.00
104977	3/16" x 4"	6	96	\$19.00	\$27.00	\$34.00
104978	3/16" x 6"	6	96	\$23.00	\$33.00	\$41.00
104979	3/16" x 8"	6	96	\$25.00	\$36.00	\$44.00
104980	1/4" x 10"	6	96	\$35.00	\$50.00	\$62.00

CÓDIGO	DIÁMETRO			DISTRIB.	MAYOREO	LISTA
104961	3/16 x 4"	6	96	\$25.00	\$36.00	\$44.00
104962	1/4" x 1 1/2"	6	96	\$20.00	\$29.00	\$35.00
104963	1/4" x 4"	6	96	\$25.00	\$36.00	\$44.00
104964	1/4" x 6"	6	96	\$26.00	\$37.00	\$46.00
104965	5/16" x 6"	6	96	\$36.00	\$51.00	\$64.00
104966	5/16" x 10"	6	96	\$43.00	\$61.00	\$76.00

Desarmador PVC: punta de cruz, punta cabinet, punta plana



TARJETA PLÁSTICA

- ▶ Mango ergonómico de PVC de alta resistencia
- ▶ Barra fabricada en acero al cromo vanadio
- ▶ Espiga insertada hasta 50% del mango
- ▶ Punta imantada



ACERO AL CROMO VANADIO

MANGO PVC CON ESPIGA INSERTADA AL 50%



CRUZ



CABINET



PLANA

NUEVO*
NUEVA MEDIDA DISPONIBLE



CÓDIGO	DIÁMETRO			DISTRIB.	MAYOREO	LISTA
104901	1/8" x 2 1/2"	6	36	\$17.00	\$24.30	\$30.00
104902	1/8" x 4"	6	36	\$19.00	\$27.00	\$34.00
104903	1/8" x 6"	6	36	\$20.00	\$29.00	\$35.00
104904	1/8" x 8"	6	36	\$22.00	\$31.00	\$39.00
104905	3/16" x 3"	6	36	\$23.00	\$33.00	\$41.00
104906	3/16" x 6"	6	36	\$25.00	\$36.00	\$44.00
104907	3/16" x 8"	6	36	\$26.00	\$37.00	\$46.00
104908	1/4" x 1 1/2"	6	36	\$23.00	\$33.00	\$41.00
104909	1/4" x 4"	6	36	\$26.00	\$37.00	\$46.00
104910	1/4" x 6"	6	36	\$27.00	\$39.00	\$48.00
104911	1/4" x 8"	6	36	\$32.00	\$46.00	\$56.00
104912	5/16" x 6"	6	36	\$42.00	\$60.00	\$74.00
104913	3/8" x 8"	6	36	\$50.00	\$71.00	\$88.00

CÓDIGO	DIÁMETRO			DISTRIB.	MAYOREO	LISTA
104921	1/8" x 2 1/2"	6	36	\$17.00	\$24.30	\$30.00
104922	1/8" x 3"	6	36	\$17.00	\$24.30	\$30.00
104923	1/8" x 4"	6	36	\$17.00	\$24.30	\$30.00
104924	1/8" x 6"	6	36	\$19.00	\$27.00	\$34.00
104925	1/8" x 8"	6	36	\$21.00	\$30.00	\$37.00
104926	3/16" x 3"	6	36	\$24.00	\$34.00	\$42.00
104927	3/16" x 4"	6	36	\$25.00	\$36.00	\$44.00
104928	3/16" x 6"	6	36	\$25.00	\$36.00	\$44.00
104929	3/16" x 8"	6	36	\$29.00	\$41.00	\$51.00
104930	1/4" x 10"	6	36	\$35.00	\$50.00	\$62.00

CÓDIGO	DIÁMETRO			DISTRIB.	MAYOREO	LISTA
104914	3/16" x 4"	6	36	\$25.00	\$36.00	\$44.00
104915	1/4" x 1 1/2"	6	36	\$23.00	\$33.00	\$41.00
104916	1/4" x 4"	6	36	\$26.00	\$37.00	\$46.00
104917	1/4" x 6"	6	36	\$28.00	\$40.00	\$49.00
104918	5/16" x 6"	6	36	\$41.00	\$59.00	\$72.00
104919	5/16" x 10"	6	36	\$48.00	\$69.00	\$85.00
104920	3/8" x 8"	6	36	\$50.00	\$71.00	\$88.00
*104932	1/4" x 10"	6	36	\$35.00	\$50.00	\$62.00

Desarmador básico: punta de cruz, punta cabinet, punta plana



TARJETA PLÁSTICA

- ▶ Mango ergonómico
- ▶ Barra fabricada en acero al cromo vanadio
- ▶ Espiga insertada hasta 30% del mango
- ▶ Punta imantada



CRUZ



CABINET



PLANA



CÓDIGO	DIÁMETRO			DISTRIB.	MAYOREO	LISTA
300216	1/8" x 4"	12	96	\$10.00	\$14.30	\$17.60
300217	1/8" x 6"	12	96	\$11.50	\$16.40	\$20.30
300218	1/8" x 8"	12	96	\$13.00	\$18.60	\$22.90
300201	3/16" x 3"	12	96	\$12.50	\$17.90	\$22.00
300202	3/16" x 6"	12	96	\$13.00	\$18.60	\$22.90
300203	3/16" x 8"	12	96	\$14.00	\$20.00	\$24.70
300219	1/4" x 1 1/2"	12	144	\$11.00	\$15.70	\$19.40
300204	1/4" x 4"	12	96	\$15.00	\$21.40	\$26.00
300205	1/4" x 6"	12	96	\$17.00	\$24.30	\$30.00
300206	1/4" x 8"	12	96	\$19.00	\$27.00	\$34.00

CÓDIGO	DIÁMETRO			DISTRIB.	MAYOREO	LISTA
300210	1/8" x 4"	12	96	\$11.00	\$15.70	\$19.40
300211	1/8" x 6"	12	96	\$11.50	\$16.40	\$20.30
300212	1/8" x 8"	12	96	\$12.00	\$17.10	\$21.20
300213	3/16" x 4"	12	96	\$13.00	\$18.60	\$22.90
300214	3/16" x 6"	12	96	\$14.00	\$20.00	\$24.70
300215	3/16" x 8"	12	96	\$15.00	\$21.40	\$26.00

CÓDIGO	DIÁMETRO			DISTRIB.	MAYOREO	LISTA
300207	3/16" x 4"	12	96	\$13.00	\$18.60	\$22.90
300221	3/16" x 6"	12	96	\$14.00	\$20.00	\$24.70
300220	1/4" x 1 1/2"	12	144	\$11.00	\$15.70	\$19.40
300208	1/4" x 4"	12	96	\$15.00	\$21.40	\$26.00
300209	1/4" x 6"	12	96	\$17.00	\$24.30	\$30.00

Desarmadores de 6" Juego de 2: punta plana y cruz

BLÍSTER

- ▶ Barra de 6"
- ▶ Barra forjada en acero al carbono
- ▶ Mango de PVC de alta resistencia
- ▶ Espiga insertada hasta 30% del mango
- ▶ Punta imantada

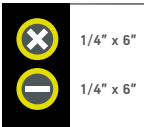

1/4" x 6"

1/4" x 6"



CÓDIGO			DISTRIB.	MAYOREO	LISTA
304706	6	72	\$31.00	\$44.00	\$55.00

Desarmadores de 4" Juego de 2: punta plana y cruz

BLÍSTER

- ▶ Barra de 4"
- ▶ Barra forjada en acero al carbono
- ▶ Mango de PVC de alta resistencia
- ▶ Espiga insertada hasta 30% del mango
- ▶ Punta imantada

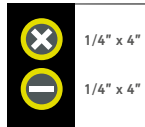

1/4" x 4"

1/4" x 4"





CÓDIGO			DISTRIB.	MAYOREO	LISTA
304701	6	72	\$30.00	\$43.00	\$53.00



Desarmadores con mango gris, juego de 6

BLÍSTER

- ▶ Práctico estuche organizador de pared
- ▶ Mango de PVC de alta resistencia
- ▶ Barra forjada en acero al carbono
- ▶ Espiga insertada hasta 50% del mango
- ▶ Puntas imantadas

	
4 Desarmadores punta plana	2 Desarmadores punta de cruz
3/16" x 3" 3/16" x 6" 1/4" x 6" 1/4" x 4"	3/16" x 4" 1/4" x 4"





CÓDIGO			DISTRIB.	MAYOREO	LISTA
304703	6	24	\$70.00	\$100.00	\$123.00



Desarmadores con mango transparente, juego de 6

BLÍSTER

- ▶ Práctico estuche organizador de pared
- ▶ Mango de PVC de alta resistencia
- ▶ Barra forjada en acero al carbono
- ▶ Espiga insertada hasta 50% del mango
- ▶ Puntas imantadas

	
4 Desarmadores punta plana	2 Desarmadores punta de cruz
3/16" x 3" 3/16" x 6" 1/4" x 6" 1/4" x 4"	3/16" x 4" 1/4" x 4"





CÓDIGO			DISTRIB.	MAYOREO	LISTA
304704	6	24	\$75.00	\$107.00	\$132.00

Desarmadores con mango gris, juego de 4

BLÍSTER

- ▶ Barra forjada en acero al carbono
- ▶ Mango de PVC de alta resistencia
- ▶ Espiga insertada hasta 30% del mango
- ▶ Puntas imantadas

	
2 Desarmadores punta plana	2 Desarmadores punta de cruz
1/4" x 4" 3/16" x 4"	1/4" x 4" 3/16" x 4"





CÓDIGO			DISTRIB.	MAYOREO	LISTA
304702	6	24	\$55.00	\$79.00	\$97.00

Desarmadores de impacto, juego de 7

BLÍSTER

- ▶ Barra cuadrada para uso con llaves, mayor fuerza al torque
- ▶ Barra cuadrada de acero al carbono que atraviesa por completo el mango
- ▶ Mayor resistencia a los impactos
- ▶ Mango de PVC de alta resistencia
- ▶ Puntas imantadas

	
4 Desarmadores punta plana	3 Desarmadores punta de cruz
3/16" x 3" 1/4" x 4" 1/4" x 6" 5/16" x 8"	3/16" x 3" 1/4" x 4" 5/16" x 6"



CÓDIGO			DISTRIB.	MAYOREO	LISTA
304705	6	24	\$115.00	\$165.00	\$205.00

Desarmadores dieléctricos con probador de corriente, juego de 7 piezas



CAJA PLÁSTICA CON ETIQUETA

- ▶ Probador con clip tipo pluma 140 mm (14 cm)
- ▶ Circuitos de 100-250 V
- ▶ Barra fabricada en acero al cromo vanadio
- ▶ Norma que aplica: VDE/ GS
- ▶ Protección de aislamiento hasta 1000 V

NOM

		
4 Desarmadores punta cabinet	3 Desarmadores punta de cruz	Probador eléctrico
3 x 75 mm 4 x 100 mm 5.5 x 125 mm 6.5 x 150 mm	PH0 x 75 mm PH1 x 80 mm PH2 x 100 mm	140 mm Mango ABS Indicador de luz



CÓDIGO	TIPO			DISTRIB.	MAYOREO	LISTA
114111	Dieléctrico	1	10	\$280.00	\$400.00	\$495.00

Desarmador para joyero 30 puntas y extensión

BLÍSTER

- ▶ Para uso en trabajos de precisión
- ▶ Cabeza giratoria



- 1 mm - 4 mm
- No.000 - No.1
- T6 - T20
- PZ0 y PZ1
- 0.7 mm - 4 mm



CÓDIGO			DISTRIB.	MAYOREO	LISTA
114101	6	36	\$89.00	\$127.00	\$155.00

Desarmadores para relojero, estuche de 6

BLÍSTER

- ▶ Para uso en trabajos de precisión
- ▶ Mango ergonómico
- ▶ Cabeza giratoria



- 1.4 mm - 2 mm
- 2.4 mm - 3 mm
- No.0 - No.1



CÓDIGO			DISTRIB.	MAYOREO	LISTA
307501	6	36	\$50.00	\$71.00	\$88.00

Desarmadores de precisión estuche de 6

BLÍSTER

- ▶ Para uso en trabajos de precisión
- ▶ Mango metálico
- ▶ Cabeza giratoria



- 1.4 mm - 2 mm
- 2.4 mm - 3 mm
- PH1 y PH0



CÓDIGO			DISTRIB.	MAYOREO	LISTA
307502	6	96	\$22.00	\$31.00	\$39.00

Juego de 7 puntas Torx® 1"

BLÍSTER

- ▶ Pueden usarse en taladro y desarmador eléctrico o manual



- T9 T25
- T10 T27
- T15 T30
- T20



CÓDIGO	LARGO			DISTRIB.	MAYOREO	LISTA
114004	1" - 25 mm	6	72	\$18.00	\$26.00	\$32.00

Juego de 7 puntas Torx® 2"

BLÍSTER

- ▶ Pueden usarse en taladro y desarmador eléctrico o manual



- T10 T27
- T15 T30
- T20 T40
- T25



CÓDIGO	LARGO			DISTRIB.	MAYOREO	LISTA
114005	2" - 50 mm	6	72	\$25.00	\$36.00	\$44.00

Juego de 9 puntas

BLÍSTER

- ▶ Fabricadas en acero al cromo vanadio
- ▶ Pueden usarse en taladro y desarmador eléctrico o manual



- 1 de 3/16"
- 2 de 1/4"
- 1 de 5/16"
- 1 de No.1
- 3 de No.2
- 1 de No.3



CÓDIGO	LARGO			DISTRIB.	MAYOREO	LISTA
307401	2" - 50 mm	6	48	\$33.00	\$47.00	\$58.00

Juego de 5 puntas 1"

BLÍSTER

- ▶ Fabricadas en Acero al Cromo vanadio
- ▶ Para uso industrial



- No.2



CÓDIGO	LARGO			DISTRIB.	MAYOREO	LISTA
114003	1" - 25 mm	12	72	\$15.00	\$21.40	\$26.00

Juego de 5 puntas 2"

BLÍSTER

- ▶ Fabricadas en Acero al cromo vanadio
- ▶ Para uso industrial



- No.2



CÓDIGO	LARGO			DISTRIB.	MAYOREO	LISTA
114002	2" - 50 mm	12	72	\$22.00	\$31.00	\$39.00

Juego de 4 puntas 2"

BLÍSTER

- ▶ Fabricadas en Acero al cromo vanadio
- ▶ Para uso industrial



- 1/4" 5/16"
- No.1 No.2



CÓDIGO	LARGO			DISTRIB.	MAYOREO	LISTA
114001	2" - 50 mm	12	72	\$22.00	\$31.00	\$39.00

Desarmador con 6 puntas

BLÍSTER

- ▶ Puntas forjadas en acero al cromo vanadio
- ▶ Barra con socket imantado que asegura mejor las puntas
- ▶ Mango ergonómico con compartimento para guardar puntas



IT MAXTOOL

CÓDIGO			DISTRIB.	MAYOREO	LISTA
304707	6	60	\$40.00	\$57.00	\$71.00

Desarmador con 6 puntas y 7 dados

BLÍSTER

- ▶ Puntas forjadas en acero al cromo vanadio
- ▶ Barra con socket imantado que asegura mejor las puntas y dados
- ▶ Mango ergonómico antiderrapante



IT MAXTOOL

CÓDIGO			DISTRIB.	MAYOREO	LISTA
304708	6	24	\$65.00	\$93.00	\$115.00

Desarmador tipo matraca con 16 puntas y 12 dados

BLÍSTER

- ▶ Puntas forjadas en acero al cromo vanadio
- ▶ Mango ergonómico antiderrapante
- ▶ Espiga insertada hasta 50% del mango
- ▶ Socket imantado



DADOS ESTÁNDAR
1/4", 5/16", 11/32", 3/8", 7/16", 1/2"

DADOS MILIMÉTRICOS
5 mm, 6 mm, 7 mm, 8 mm, 9 mm, 10 mm

	3/16", 1/4" y 9/32"
	PH1, PH2 (5 piezas), PH3
	T15, T20 y T25
	1/8" y 3/16"



IT MAXTOOL

CÓDIGO			DISTRIB.	MAYOREO	LISTA
304709	6	24	\$125.00	\$180.00	\$220.00

Imán extensible

BLÍSTER

- ▶ Imán de acero inoxidable
- ▶ Ajarre hasta 1.5 kg



CLIP TIPO BOLÍGRAFO



AKSI

CÓDIGO			DISTRIB.	MAYOREO	LISTA
128411	12	72	\$40.00	\$57.00	\$71.00

Autoclé 52 piezas

FAJILLA DE CARTÓN

- ▶ Dados estándar y milimétricos
- ▶ Matraca fabricada en acero al carbono



CONTENIDO

2 Matracas cuadro 3/8" (9,5 mm) y 1/2" (12,7 mm)	6 Dados milimétricos de 6 puntos, cuadro 1/4" (6,3 mm) (Tipo I)
1 Desarmador cuadro 1/4" (6,3 mm)	3 Dados estándar de 8 puntos, cuadro 1/4" (6,3 mm) (Tipo II)
1 Extensión cuadro 3/8" (9,5 mm)	3 Dados estándar de 6 puntos, cuadro 3/8" (9,5 mm) (Tipo II)
1 Reductor 3/8" (9,5 mm) a 1/4" (6,3 mm)	3 Dados milimétricos de 6 puntos, cuadro 3/8" (9,5 mm) (Tipo II)
1 Adaptador para puntas 1/4" (6,3 mm)	4 Dados estándar de 6 puntos, cuadro 1/2" (12,7 mm) (Tipo II)
1 Disco para matraca cuadro 3/8" (9,5 mm)	1 Dado para bujía de 5/8" (15,8 mm), cuadro 3/8" (9,5 mm)
8 Dados estándar de 6 puntos, cuadro 1/4" (6,3 mm) (Tipo II)	3 Puntas phillips PH1 - PH2 - PH3
7 Dados milimétricos de 6 puntos, cuadro 1/4" (6,3 mm) (Tipo II)	2 Puntas planas 9/32" - 3/16"
4 Dados estándar de 6 puntos, cuadro 1/4" (6,3 mm) (Tipo I)	1 Estuche plástico

18 meses GARANTÍA

IT MAXTOOL

CÓDIGO	TIPO	MANDO		DISTRIB.	MAYOREO	LISTA
308702	Estándar y milimétrico	1/4" Y 3/8"	6	\$260.00	\$370.00	\$460.00

Autoclé 40 piezas

FAJILLA DE CARTÓN

- ▶ Matraca fabricada en acero al carbono



CONTENIDO

1 Matraca reversible 20 cm - 8"
1 Barra de extensión de 79 mm - 3"
1 Adaptador de 9,5 mm - 3/8" a 6,4 mm - 1/4"
1 Dado largo de 15,8 mm - 5/8"
1 Disco de plástico de 9,5 mm - 3/8"
1 Desarmador para dado de 6,4 mm - 1/4"
3 Dados de 8 puntos std mando de 6,4 mm - 1/4"
12 Dados de 6 puntos std mando de 6,4 mm - 1/4"
3 Dados de 6 puntos std mando 9,5 mm - 3/8"
3 Dados de 6 puntos mm mando 9,5 mm - 3/8"
12 Dados de 6 puntos mm mando de 6,4 mm - 1/4"
1 Estuche plástico

18 meses GARANTÍA

IT MAXTOOL

CÓDIGO	TIPO	MANDO		DISTRIB.	MAYOREO	LISTA
308701	Estándar y milimétrico	1/4" Y 3/8"	10	\$150.00	\$215.00	\$265.00

Dado para bujía con 6 puntas

1/2"

TARJETA PLÁSTICA

- ▶ Fabricados en acero al cromo vanadio
- ▶ Resistentes a oxidación
- ▶ Cuadro de 1/2"



EXTREMO HEXAGONAL

AKSI

CÓDIGO	DADOS			DISTRIB.	MAYOREO	LISTA
127623	13/16"	6	36	\$42.00	\$60.00	\$74.00

Dado para bujía con 6 puntas

3/8"

TARJETA PLÁSTICA

- ▶ Fabricados en acero al cromo vanadio
- ▶ Resistentes a oxidación
- ▶ Cuadro de 3/8"



EXTREMO HEXAGONAL

AKSI

CÓDIGO	DADOS			DISTRIB.	MAYOREO	LISTA
127621	5/8"	6	36	\$30.00	\$43.00	\$53.00
127622	13/16"	6	36	\$38.00	\$54.00	\$67.00

Nudo universal para dados

1/2"

3/8"

TARJETA PLÁSTICA

- ▶ Fabricados en acero al cromo vanadio
- ▶ Resistentes a oxidación
- ▶ Cuadro de 1/2" ó 3/8"



AKSI

CÓDIGO	CUADRO			DISTRIB.	MAYOREO	LISTA
127652	1/2"	6	36	\$65.00	\$93.00	\$115.00
127651	3/8"	6	36	\$45.00	\$64.00	\$79.00

Matraca cabeza de pera, de liberación rápida

PROX.

TARJETA PLÁSTICA

- ▶ Acero al cromo vanadio, más resistente al desgaste
- ▶ Acabado cromado pulido
- ▶ Engrane de 45 dientes
- ▶ Sistema reversible con selector de cambio de giro y botón de liberación rápida



MANGO MOLETEADO

AKSI

CÓDIGO	CUADRO			DISTRIB.	MAYOREO	LISTA
131001	3/8"	6	24	\$250.00	\$355.00	\$440.00
131002	1/2"	6	24	\$300.00	\$430.00	\$530.00

Kit de reparación para matraca

PROX.

CABALLETE

CONTENIDO:

- ▶ 1 Engrane de cuadro
- ▶ 2 Seguros
- ▶ 2 Resortes para seguros
- ▶ 1 Émbolo de cambio
- ▶ 1 Palanca de cambio
- ▶ 1 Tapa
- ▶ 2 Tornillos para tapa



AKSI

CÓDIGO	CUADRO			DISTRIB.	MAYOREO	LISTA
131011	3/8"	50	200	\$130.00	\$185.00	\$230.00
131012	1/2"	50	200	\$145.00	\$205.00	\$255.00

Matraca cabeza de pera

BLÍSTER

- ▶ Acero al carbono
- ▶ Sistema de engrane de 24 dientes



MANGO MOLETEADO

12 meses GARANTÍA

IT MAX TOOL

CÓDIGO	MODELO	CUADRO			DISTRIB.	MAYOREO	LISTA
307002	Pera	3/8"	6	24	\$135.00	\$195.00	\$240.00
307004	Pera	1/2"	6	24	\$150.00	\$215.00	\$265.00

Matraca cabeza redonda

BLÍSTER

- ▶ Acero al carbono
- ▶ Sistema de engrane de 39 dientes en 3/8" y 45 dientes en 1/2"



MANGO MOLETEADO

12 meses GARANTÍA

IT MAX TOOL

CÓDIGO	MODELO	CUADRO			DISTRIB.	MAYOREO	LISTA
307001	Redonda	3/8"	6	24	\$60.00	\$86.00	\$106.00
307003	Redonda	1/2"	6	24	\$85.00	\$121.00	\$150.00

Extensión para matraca

TARJETA PLÁSTICA

- ▶ Cuadro de 3/8" ó 1/2"
- ▶ Fabricados en acero al cromo vanadio
- ▶ Resistentes a oxidación



3/8"

1/2"

AKSI

CÓDIGO	LONGITUD	CUADRO			DISTRIB.	MAYOREO	LISTA
127642	8"	1/2"	6	36	\$85.00	\$121.00	\$150.00
127643	10"	1/2"	6	36	\$90.00	\$129.00	\$160.00
127646	6"	3/8"	6	36	\$45.00	\$64.00	\$79.00
127647	8"	3/8"	6	36	\$51.00	\$73.00	\$90.00
127648	10"	3/8"	6	36	\$75.00	\$107.00	\$132.00

Adaptador para matraca

TARJETA PLÁSTICA

- ▶ Fabricados en acero al cromo vanadio
- ▶ Resistentes a oxidación



AKSI

CÓDIGO	LONGITUD				DISTRIB.	MAYOREO	LISTA
	Hembra	Macho					
127661	3/8"	1/2"	6	36	\$27.00	\$39.00	\$48.00
127662	3/8"	1/4"	6	36	\$20.00	\$29.00	\$35.00
127663	1/2"	3/8"	6	36	\$27.00	\$39.00	\$48.00

Dado corto

3/8"

TARJETA PLÁSTICA

- ▶ Fabricados en acero al cromo vanadio
- ▶ Resistentes a oxidación
- ▶ Cuadro de 3/8"



CÓDIGO	MEDIDA			DISTRIB.	MAYOREO	LISTA
Estándar						
131101	1/4"	6	36	\$16.00	\$22.90	\$28.00
131102	5/16"	6	36	\$16.00	\$22.90	\$28.00
131103	3/8"	6	36	\$16.00	\$22.90	\$28.00
131104	7/16"	6	36	\$16.00	\$22.90	\$28.00
131105	1/2"	6	36	\$16.00	\$22.90	\$28.00
131106	9/16"	6	36	\$17.00	\$24.30	\$30.00
131107	5/8"	6	36	\$17.00	\$24.30	\$30.00
131108	11/16"	6	36	\$22.00	\$31.00	\$39.00
131109	3/4"	6	36	\$22.00	\$31.00	\$39.00
131110	13/16"	6	36	\$26.00	\$37.00	\$46.00
131111	7/8"	6	36	\$32.00	\$46.00	\$56.00
131112	15/16"	6	36	\$33.00	\$47.00	\$58.00
131113	1"	6	36	\$35.00	\$50.00	\$62.00
Milimétrico						
131121	6 mm	6	36	\$16.00	\$22.90	\$28.00
131122	7 mm	6	36	\$16.00	\$22.90	\$28.00
131123	8 mm	6	36	\$16.00	\$22.90	\$28.00
131124	9 mm	6	36	\$16.00	\$22.90	\$28.00
131125	10 mm	6	36	\$16.00	\$22.90	\$28.00
131126	11 mm	6	36	\$16.00	\$22.90	\$28.00
131127	12 mm	6	36	\$19.00	\$27.00	\$34.00
131128	13 mm	6	36	\$19.00	\$27.00	\$34.00
131129	14 mm	6	36	\$19.00	\$27.00	\$34.00
131130	15 mm	6	36	\$19.00	\$27.00	\$34.00
131131	16 mm	6	36	\$22.00	\$31.00	\$39.00
131132	17 mm	6	36	\$22.00	\$31.00	\$39.00
131133	18 mm	6	36	\$22.00	\$31.00	\$39.00
131141	19 mm	6	36	\$22.00	\$31.00	\$39.00
131142	20 mm	6	36	\$27.00	\$39.00	\$48.00
131143	21 mm	6	36	\$27.00	\$39.00	\$48.00
131144	22 mm	6	36	\$32.00	\$46.00	\$56.00

Dado largo hexagonal

3/8"

TARJETA PLÁSTICA

- ▶ Fabricados en acero al cromo vanadio
- ▶ Resistentes a oxidación
- ▶ Cuadro de 3/8"



CÓDIGO	MEDIDA			DISTRIB.	MAYOREO	LISTA
Estándar						
131151	3/8"	6	36	\$27.00	\$39.00	\$48.00
131152	7/16"	6	36	\$27.00	\$39.00	\$48.00
131153	1/2"	6	36	\$27.00	\$39.00	\$48.00
131154	9/16"	6	36	\$30.00	\$43.00	\$53.00
131155	5/8"	6	36	\$33.00	\$47.00	\$58.00
131156	11/16"	6	36	\$39.00	\$56.00	\$69.00
131157	3/4"	6	36	\$41.00	\$59.00	\$72.00
131158	13/16"	6	36	\$46.00	\$66.00	\$81.00
131159	7/8"	6	36	\$49.00	\$70.00	\$86.00
Milimétrico						
131171	10 mm	6	36	\$27.00	\$39.00	\$48.00
131172	11 mm	6	36	\$27.00	\$39.00	\$48.00
131173	12 mm	6	36	\$27.00	\$39.00	\$48.00
131174	13 mm	6	36	\$27.00	\$39.00	\$48.00
131175	14 mm	6	36	\$30.00	\$43.00	\$53.00
131176	15 mm	6	36	\$33.00	\$47.00	\$58.00
131177	16 mm	6	36	\$33.00	\$47.00	\$58.00
131178	17 mm	6	36	\$39.00	\$56.00	\$69.00
131179	18 mm	6	36	\$40.00	\$57.00	\$71.00
131180	19 mm	6	36	\$40.00	\$57.00	\$71.00

Dados cortos, juego de 9 piezas

3/8"

ESTUCHE PLÁSTICO

- ▶ Fabricados en acero al cromo vanadio
- ▶ Resistentes a oxidación
- ▶ Cuadro de 3/8"



ESTÁNDAR	MILIMÉTRICOS
3/8", 7/16", 1/2", 9/16", 5/8" 11/16", 3/4", 13/16", 7/8"	10, 11, 12, 13, 14 15, 16, 17, 18 mm



CÓDIGO	DADOS			DISTRIB.	MAYOREO	LISTA
127601	Estándar	12 Juegos	36 Juegos	\$165.00	\$235.00	\$290.00
127602	Milimétricos	12 Juegos	36 Juegos	\$160.00	\$230.00	\$280.00

Dados largos , juego de 9 piezas

3/8"

ESTUCHE PLÁSTICO

- ▶ Fabricados en acero al cromo vanadio
- ▶ Resistentes a oxidación
- ▶ Cuadro de 3/8"



ESTÁNDAR	MILIMÉTRICOS
3/8", 7/16", 1/2", 9/16", 5/8" 11/16", 3/4", 13/16", 7/8"	10, 11, 12, 13, 14 15, 16, 17, 18 mm



CÓDIGO	DADOS			DISTRIB.	MAYOREO	LISTA
127611	Estándar	6 Juegos	18 Juegos	\$260.00	\$370.00	\$460.00
127612	Milimétricos	6 Juegos	18 Juegos	\$250.00	\$355.00	\$440.00

Dado corto

1/2"

TARJETA PLÁSTICA

- ▶ Fabricados en acero al cromo vanadio
- ▶ Resistentes a oxidación
- ▶ Cuadro de 1/2"



AKSI

CÓDIGO	MEDIDA			DISTRIB.	MAYOREO	LISTA
Estándar						
131201	3/8"	6	36	\$24.00	\$34.00	\$42.00
131202	7/16"	6	36	\$24.00	\$34.00	\$42.00
131203	1/2"	6	36	\$24.00	\$34.00	\$42.00
131204	9/16"	6	36	\$24.00	\$34.00	\$42.00
131205	5/8"	6	36	\$24.00	\$34.00	\$42.00
131206	11/16"	6	36	\$24.00	\$34.00	\$42.00
131207	3/4"	6	36	\$29.00	\$41.00	\$51.00
131208	13/16"	6	36	\$29.00	\$41.00	\$51.00
131209	7/8"	6	36	\$35.00	\$50.00	\$62.00
131210	15/16"	6	36	\$38.00	\$54.00	\$67.00
131211	1"	6	36	\$46.00	\$66.00	\$81.00
131212	1 1/16"	6	36	\$55.00	\$79.00	\$97.00
131213	1 1/8"	6	36	\$58.00	\$83.00	\$102.00
131214	1 3/16"	6	36	\$64.00	\$91.00	\$113.00
131215	1 1/4"	6	36	\$67.00	\$96.00	\$118.00
Milimétrico						
131221	10 mm	6	36	\$24.00	\$34.00	\$42.00
131222	11 mm	6	36	\$24.00	\$34.00	\$42.00
131223	12 mm	6	36	\$24.00	\$34.00	\$42.00
131224	13 mm	6	36	\$24.00	\$34.00	\$42.00
131225	14 mm	6	36	\$24.00	\$34.00	\$42.00
131226	15 mm	6	36	\$24.00	\$34.00	\$42.00
131227	16 mm	6	36	\$24.00	\$34.00	\$42.00
131228	17 mm	6	36	\$24.00	\$34.00	\$42.00
131229	18 mm	6	36	\$28.00	\$40.00	\$49.00
131230	19 mm	6	36	\$28.00	\$40.00	\$49.00
131231	20 mm	6	36	\$28.00	\$40.00	\$49.00
131232	21 mm	6	36	\$28.00	\$40.00	\$49.00
131233	22 mm	6	36	\$31.00	\$44.00	\$55.00
131234	23 mm	6	36	\$37.00	\$53.00	\$65.00
131235	24 mm	6	36	\$37.00	\$53.00	\$65.00
131236	25 mm	6	36	\$39.00	\$56.00	\$69.00

Dado largo

1/2"

TARJETA PLÁSTICA

- ▶ Fabricados en acero al cromo vanadio
- ▶ Resistentes a oxidación
- ▶ Cuadro de 1/2"



AKSI

CÓDIGO	MEDIDA			DISTRIB.	MAYOREO	LISTA
Estándar						
131241	3/8"	6	36	\$44.00	\$63.00	\$78.00
131242	7/16"	6	36	\$44.00	\$63.00	\$78.00
131243	1/2"	6	36	\$44.00	\$63.00	\$78.00
131244	9/16"	6	36	\$44.00	\$63.00	\$78.00
131245	5/8"	6	36	\$44.00	\$63.00	\$78.00
131246	11/16"	6	36	\$44.00	\$63.00	\$78.00
131247	3/4"	6	36	\$48.00	\$69.00	\$85.00
Milimétrico						
131261	10 mm	6	36	\$44.00	\$63.00	\$78.00
131262	11 mm	6	36	\$44.00	\$63.00	\$78.00
131263	12 mm	6	36	\$44.00	\$63.00	\$78.00
131264	13 mm	6	36	\$44.00	\$63.00	\$78.00
131265	14 mm	6	36	\$44.00	\$63.00	\$78.00
131266	15 mm	6	36	\$44.00	\$63.00	\$78.00
131267	16 mm	6	36	\$44.00	\$63.00	\$78.00
131268	17 mm	6	36	\$44.00	\$63.00	\$78.00
131269	18 mm	6	36	\$46.00	\$66.00	\$81.00
131270	19 mm	6	36	\$46.00	\$66.00	\$81.00

Dados largos , juego de 6 piezas

1/2"

ESTUCHE PLÁSTICO

- ▶ Fabricados en acero al cromo vanadio
- ▶ Resistentes a oxidación
- ▶ Cuadro de 1/2"



AKSI

ESTÁNDAR	MILIMÉTRICOS	CÓDIGO	DADOS			DISTRIB.	MAYOREO	LISTA
3/4", 5/8", 7/8", 9/16", 11/16", 13/16"	13, 14, 15, 16, 17, 18 mm	127631	Estándar	4 Juegos	24 Juegos	\$270.00	\$385.00	\$475.00
		127632	Milimétricos	4 Juegos	24 Juegos	\$240.00	\$345.00	\$425.00

DISCÓMETRO

LAS MEJORES LÍNEAS EN DISCOS

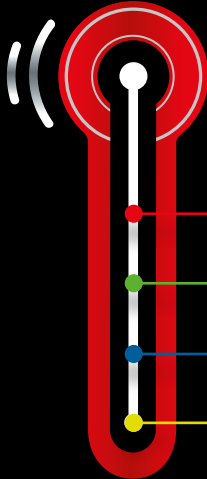

Checa nuestro discómetro y elige la línea que mejor se acople a tu proyecto.

SUPER PREM

Máximo rendimiento + super calidad + costo

IND

Alto rendimiento + alta calidad + costo

CLASS

Alta calidad + costo

BASIC

Seguridad + costo

Disco para corte de metal

BLÍSTER

- ▶ Corte de metal y acero inoxidable
- ▶ Barreno 7/8"
- ▶ Granos de óxido de aluminio
- ▶ Alto rendimiento, 25% más que los discos industriales
- ▶ Cortes precisos

HECHO EN ISRAEL



super PREM
HECHO EN ISRAEL



CERTIFICACIONES EUROPEAS



CÓDIGO	GRANO	GROSOR	Ø	rpm		DISTRIB.	MAYOREO	LISTA
114605	Óxido aluminio	3/64" - 1.2 mm	4 1/2"	13,300	25	\$24.00	\$34.00	\$42.00
114606	Óxido aluminio	1/16" - 1.6 mm	4 1/2"	13,300	25	\$26.00	\$37.00	\$46.00



¡CONOCIENDO DE DISCOS!

Discos para corte de metal alto rendimiento, industrial



GRANEL

- ▶ Para metales ferrosos (hierro, acero, soldadura, etc.)
- ▶ Granos de óxido de aluminio
- ▶ Barreno de 7/8"



HECHO EN ISRAEL



CÓDIGO	GROSOR	Ø	rpm		DISTRIB.	MAYOREO	LISTA
114602	3/64" - 1 mm	4 1/2"	13,300	25	\$21.00	\$30.00	\$37.00
114603	1/16" - 1.6 mm	4 1/2"	13,300	25	\$23.00	\$33.00	\$41.00

Discos para corte de metal alto rendimiento, industrial



GRANEL

- ▶ Para metales ferrosos (hierro, soldadura, etc.)
- ▶ Granos de óxido de aluminio
- ▶ Barreno de 7/8"



HECHO EN ISRAEL



CÓDIGO	GROSOR	Ø	rpm		DISTRIB.	MAYOREO	LISTA
114630	1/8" - 3 mm	4 1/2"	13,300	25	\$24.00	\$34.00	\$42.00
114633	5/32" - 4 mm	7"	8,500	25	\$62.00	\$89.00	\$109.00
114635	1/16" - 1.6 mm	7"	8,500	25	\$70.00	\$100.00	\$123.00

Discos para desbaste de metal alto rendimiento, industrial



GRANEL

- ▶ Para uso industrial en donde se requiere trabajar en grandes superficies
- ▶ Granos de óxido de aluminio
- ▶ Barreno de 7/8"



HECHO EN ISRAEL



CÓDIGO	GROSOR	Ø	rpm		DISTRIB.	MAYOREO	LISTA
114632	1/4" - 6 mm	4 1/2"	13,300	25	\$42.00	\$60.00	\$74.00
114634	1/4" - 6 mm	7"	8,500	25	\$86.00	\$123.00	\$150.00

Disco para corte de acero inoxidable alto rendimiento, industrial



GRANEL

- ▶ Para acero inoxidable
- ▶ Granos de óxido de aluminio
- ▶ Barreno de 7/8"



HECHO EN ISRAEL



CÓDIGO	GROSOR	Ø	rpm		DISTRIB.	MAYOREO	LISTA
114604	3/64" - 1 mm	4 1/2"	13,300	25	\$23.00	\$33.00	\$41.00

Disco para corte de piedra alto rendimiento, industrial



GRANEL

- ▶ Excelente velocidad de corte en piedra, concreto y ladrillo
- ▶ Granos de carburo de silicio
- ▶ Barreno de 7/8"



HECHO EN ISRAEL



CÓDIGO	GROSOR	Ø	rpm		DISTRIB.	MAYOREO	LISTA
114631	1/8" - 3 mm	4 1/2"	13,300	25	\$24.00	\$34.00	\$42.00

Discos laminados - larga duración



GRANEL

- ▶ Para pulido y desbaste de acero inoxidable, aceros duros y soldadura
- ▶ Para limpiar superficies oxidadas o pintadas
- ▶ Grano de Zirconia de alto rendimiento
- ▶ Barreno de 7/8"



HECHO EN CHINA

CÓDIGO	GRANO	Ø	rpm			DISTRIB.	MAYOREO	LISTA
115701	40	4 1/2"	13,300	10	120	\$40.00	\$57.00	\$71.00
115702	60	4 1/2"	13,300	10	120	\$40.00	\$57.00	\$71.00
115704	80	4 1/2"	13,300	10	120	\$40.00	\$57.00	\$71.00
115703	120	4 1/2"	13,300	10	120	\$40.00	\$57.00	\$71.00

Disco para corte de metal



GRANEL

- ▶ Para metales ferrosos (hierro, acero, soldadura, etc.)
- ▶ Granos de óxido de aluminio
- ▶ Barreno de 1"



HECHO EN CHINA

CÓDIGO	GROSOR	ø	rpm			DISTRIB.	MAYOREO	LISTA
114651	7/64" - 2.8 mm	14"	4,400	N/A	25	\$55.00	\$79.00	\$97.00

Disco para corte de metal



GRANEL

- ▶ Para metales ferrosos (hierro, soldadura, etc.)
- ▶ Granos de óxido de aluminio
- ▶ Barreno de 7/8"



HECHO EN CHINA

CÓDIGO	GROSOR	ø	rpm			DISTRIB.	MAYOREO	LISTA
114652	3/64" - 1 mm	4 1/2"	13,300	25	600	\$9.00	\$12.90	\$15.90
114653	1/16" - 1.6 mm	4 1/2"	13,300	25	600	\$9.00	\$12.90	\$15.90

Disco para corte de metal y acero inoxidable



GRANEL

- ▶ Para acero inoxidable
- ▶ Granos de óxido de aluminio
- ▶ Barreno de 7/8"



HECHO EN CHINA

CÓDIGO	GROSOR	ø	rpm			DISTRIB.	MAYOREO	LISTA
114654	3/64" - 1 mm	4 1/2"	13,300	25	600	\$9.00	\$12.90	\$15.90

Disco para corte de metal



GRANEL

- ▶ Para metales ferrosos (hierro, soldadura, etc.)
- ▶ Granos de óxido de aluminio
- ▶ Barreno de 7/8"



HECHO EN CHINA

CÓDIGO	GROSOR	ø	rpm			DISTRIB.	MAYOREO	LISTA
114680	1/8" - 3 mm	4 1/2"	13,300	25	200	\$11.00	\$15.70	\$19.40
114685	1/16" - 1.6 mm	7"	8,500	25	100	\$19.00	\$27.00	\$34.00

Disco para corte de piedra



GRANEL

- ▶ Excelente velocidad de corte en piedra, concreto y ladrillo
- ▶ Granos de carburo de silicio
- ▶ Barreno de 7/8"



HECHO EN CHINA

CÓDIGO	GROSOR	ø	rpm			DISTRIB.	MAYOREO	LISTA
114681	1/8" - 3 mm	4 1/2"	13,300	25	200	\$11.00	\$15.70	\$19.40

Disco para desbaste de metal



GRANEL

- ▶ Para donde se requiere trabajar en grandes superficies
- ▶ Granos de óxido de aluminio
- ▶ Barreno de 7/8"



HECHO EN CHINA

CÓDIGO	GROSOR	ø	rpm			DISTRIB.	MAYOREO	LISTA
114682	1/4" - 6 mm	4 1/2"	13,300	25	100	\$17.00	\$24.30	\$30.00
114684	1/4" - 6 mm	7"	8,500	25	50	\$39.00	\$56.00	\$69.00

Discos para corte de metal alto rendimiento

HECHO EN CHINA
BASSIC

GRANEL

- ▶ Para metales ferrosos (hierro, soldadura, etc.)
- ▶ Granos de óxido de aluminio
- ▶ Barreno de 7/8"



Tipo 1



Esmeriladora angular y mini-esmeriladora

HECHO EN CHINA
MAXTOOL

HECHO EN CHINA

CÓDIGO	GROSOR	Ø	rpm			DISTRIB.	MAY.	LISTA
307802	3/64"-1 mm	4 1/2"	13,300	25	600	\$5.00	\$7.10	\$8.80
307803	1/16"-1.6 mm	4 1/2"	13,300	25	600	\$7.00	\$10.00	\$12.30

Discos para corte de metal alto rendimiento

HECHO EN CHINA
BASSIC

GRANEL

- ▶ Para metales ferrosos (hierro, soldadura, etc.)
- ▶ Granos de óxido de aluminio
- ▶ Barreno de 7/8"



Tipo 27



Esmeriladora angular y mini-esmeriladora

HECHO EN CHINA
MAXTOOL

HECHO EN CHINA

CÓDIGO	GROSOR	Ø	rpm			DISTRIB.	MAY.	LISTA
307805	1/8"-3 mm	4 1/2"	13,300	25	200	\$9.00	\$12.90	\$15.90
307808	5/32"-4 mm	7"	8,500	25	50	\$20.00	\$29.00	\$35.00

Discos para desbaste de metal alto rendimiento

HECHO EN CHINA
BASSIC

GRANEL

- ▶ Para grandes superficies
- ▶ Granos de óxido de aluminio
- ▶ Barreno de 7/8"



Tipo 27



Esmeriladora angular

HECHO EN CHINA
MAXTOOL

HECHO EN CHINA

CÓDIGO	GROSOR	rpm	Ø			DISTRIB.	MAY.	LISTA
307807	1/4"-6 mm	13,300	4 1/2"	25	100	\$14.00	\$20.00	\$24.70
307809	1/4"-6 mm	8,500	7"	25	50	\$30.00	\$43.00	\$53.00

Disco para corte de acero inoxidable alto rendimiento

HECHO EN CHINA
BASSIC

GRANEL

- ▶ Para acero inoxidable
- ▶ Granos de óxido de aluminio
- ▶ Barreno de 7/8"



Tipo 1



Esmeriladora angular y mini-esmeriladora

HECHO EN CHINA
MAXTOOL

HECHO EN CHINA

CÓDIGO	GROSOR	Ø	rpm			DISTRIB.	MAYOREO	LISTA
307804	3/64" - 1 mm	4 1/2"	13,300	25	600	\$7.00	\$10.00	\$12.30

Disco para corte de piedra alto rendimiento

HECHO EN CHINA
BASSIC

GRANEL

- ▶ Excelente velocidad de corte en piedra, concreto y ladrillo
- ▶ Granos de carburo de silicio
- ▶ Barreno de 7/8"



Tipo 27



Esmeriladora angular y mini-esmeriladora

HECHO EN CHINA
MAXTOOL

HECHO EN CHINA

CÓDIGO	GROSOR	rpm	Ø			DISTRIB.	MAYOREO	LISTA
307806	1/8" - 3 mm	13,300	4 1/2"	25	200	\$10.00	\$14.30	\$17.60

Disco laminado

HECHO EN CHINA
BASSIC

GRANEL

- ▶ Para pulido y desbaste de acero inoxidable, aceros duros y soldadura
- ▶ Para limpiar superficies oxidadas o pintadas
- ▶ Grano de Zirconia de alto rendimiento
- ▶ Barreno de 7/8"



Tipo 29



Esmeriladora angular y mini-esmeriladora

HECHO EN CHINA
MAXTOOL

HECHO EN CHINA

CÓDIGO	GRANO	GROSOR	Ø	rpm			DISTRIB.	MAYOREO	LISTA
307821	40	7/8" - 22.23 mm	4 1/2"	13,300	10	120	\$20.00	\$29.00	\$35.00
307822	60	7/8" - 22.23 mm	4 1/2"	13,300	10	120	\$20.00	\$29.00	\$35.00
307824	80	7/8" - 22.23 mm	4 1/2"	13,300	10	120	\$20.00	\$29.00	\$35.00
307823	120	7/8" - 22.23 mm	4 1/2"	13,300	10	120	\$20.00	\$29.00	\$35.00

Disco para corte de metal alto rendimiento

HECHO EN CHINA
BASSIC

GRANEL

- ▶ Para metales ferrosos (hierro, acero, soldadura, etc.)
- ▶ Granos de óxido de aluminio
- ▶ Barreno de 1"



Tipo 1



Cortadora de metales (CHOP SAW)

HECHO EN CHINA
MAXTOOL

HECHO EN CHINA

CÓDIGO	GROSOR	Ø	rpm		DISTRIB.	MAYOREO	LISTA
307801	1/8" - 3 mm	14"	4,400	25	\$50.00	\$71.00	\$88.00

Discos diamantados HECHO EN CHINA **PREM**
rin continuo

BLÍSTER

- ▶ Incluyen reductores (16 y 20 mm)
- ▶ Ideal para cortes finos y limpios
- ▶ Para uso en loseta y azulejo, no despostilla
- ▶ No recomendado para materiales duros
- ▶ Barreno de 7/8"

HECHO EN CHINA



CÓDIGO	ESPESOR	SECCIÓN DIAMANTADA	Ø	rpm	DISTRIB.	MAY.	LISTA
115604	2 mm	5 mm	4 1/2"	13,200	6 24	\$70.00	\$100.00 \$123.00
115605	2.4 mm	5 mm	7"	8,500	6 24	\$170.00	\$245.00 \$300.00
115606	2.7 mm	5 mm	9"	6,600	6 24	\$235.00	\$335.00 \$415.00

Discos diamantados HECHO EN CHINA **PREM**
rin segmentado

BLÍSTER

- ▶ Incluyen reductores (16 y 20 mm)
- ▶ Ideal para cortes rápidos
- ▶ Para uso en piedra, concreto y ladrillo
- ▶ No recomendado para mármol y loseta
- ▶ Barreno de 7/8"

HECHO EN CHINA



CÓDIGO	ESPESOR	SECCIÓN DIAMANTADA	Ø	rpm	DISTRIB.	MAY.	LISTA
115601	2 mm	7 mm	4 1/2"	13,200	6 24	\$70.00	\$100.00 \$123.00
115602	2.4 mm	7 mm	7"	8,500	6 24	\$170.00	\$245.00 \$300.00
115603	2.7 mm	7 mm	9"	6,600	6 24	\$235.00	\$335.00 \$415.00

Discos diamantados HECHO EN CHINA **PREM**
rin turbo

BLÍSTER

- ▶ Incluyen reductores (16 y 20 mm)
- ▶ Ideal para usos generales
- ▶ Mezcla de rin continuo y rin segmentado
- ▶ No recomendado para materiales duros
- ▶ Barreno de 7/8"

HECHO EN CHINA



CÓDIGO	ESPESOR	SECCIÓN DIAMANTADA	Ø	rpm	DISTRIB.	MAY.	LISTA
115607	2 mm	7.1 mm	4 1/2"	13,200	6 24	\$70.00	\$100.00 \$123.00
115608	2.4 mm	7.1 mm	7"	8,500	6 24	\$170.00	\$245.00 \$300.00
115609	2.7 mm	7.1 mm	9"	6,600	6 24	\$235.00	\$335.00 \$415.00

Discos HECHO EN CHINA **BASSIC**
rin continuo

BLÍSTER

- ▶ **RIN CONTINUO:** Ideal para cortes con acabados finos y limpios. Para uso en loseta y azulejo

HECHO EN CHINA



CÓDIGO	ESPESOR	SECCIÓN DIAMANTADA	Ø	rpm	DISTRIB.	MAY.	LISTA
308522	2.8 mm	7 mm	9"	6,600	6 24	\$150.00	\$215.00 \$265.00
308512	2.6 mm	7 mm	7"	8,500	6 24	\$110.00	\$155.00 \$195.00
308502	2 mm	7 mm	4 1/2"	13,200	6 24	\$50.00	\$71.00 \$88.00

Discos HECHO EN CHINA **BASSIC**
rin segmentado

BLÍSTER

- ▶ **RIN SEGMENTADO:** Ideal para cortes rápidos. Para uso en piedra, concreto y ladrillo

HECHO EN CHINA



CÓDIGO	ESPESOR	SECCIÓN DIAMANTADA	Ø	rpm	DISTRIB.	MAY.	LISTA
308521	2.8 mm	7 mm	9"	6,600	6 24	\$150.00	\$215.00 \$265.00
308511	2.6 mm	7 mm	7"	8,500	6 24	\$110.00	\$155.00 \$195.00
308501	2 mm	7 mm	4 1/2"	13,200	6 24	\$50.00	\$71.00 \$88.00

Discos HECHO EN CHINA **BASSIC**
rin turbo

BLÍSTER

- ▶ **RIN TURBO:** Ideal para usos generales
- ▶ Mezcla de rin continuo y rin segmentado

HECHO EN CHINA



CÓDIGO	ESPESOR	SECCIÓN DIAMANTADA	Ø	rpm	DISTRIB.	MAY.	LISTA
308523	2.8 mm	7 mm	9"	6,600	6 24	\$150.00	\$215.00 \$265.00
308513	2.6 mm	7 mm	7"	8,500	6 24	\$110.00	\$155.00 \$195.00
308503	2 mm	7 mm	4 1/2"	13,200	6 24	\$50.00	\$71.00 \$88.00

Sierra para plásticos, aglomerados y contrachapados, centro 5/8"

BLÍSTER

- ▶ Dientes de carburo de tungsteno
- ▶ Alta frecuencia en soldadura lo que permite un 50% más resistencia al desprendimiento
- ▶ Reduce astillado o viruta
- ▶ Perfecta para sierra circular de 7 1/4"



DIENTES ALTERNADOS
IZQUIERDA-DERECHA,
CORTES MÁS SUAVES



CÓDIGO	Ø	DIENTES			DISTRIB.	MAYOREO	LISTA
118551	7 1/4"	48	3	12	\$140.00	\$200.00	\$245.00

Sierras para aluminio, centro 5/8"

BLÍSTER

- ▶ Dientes de carburo de tungsteno
- ▶ Alta frecuencia en soldadura lo que permite un 50% más resistencia al desprendimiento
- ▶ Realiza un corte largo y estrecho gracias a sus dientes trapezoidales
- ▶ Perfecta para sierra de mesa y sierra de inglete



CÓDIGO	Ø	DIENTES			DISTRIB.	MAYOREO	LISTA
118531	10"	80	3	12	\$300.00	\$430.00	\$530.00
118532	10"	100	3	12	\$330.00	\$470.00	\$580.00
118541	12"	80	3	12	\$400.00	\$570.00	\$705.00
118542	12"	100	3	12	\$430.00	\$615.00	\$760.00

Sierras para madera, centro 5/8"

BLÍSTER

- ▶ Dientes de carburo de tungsteno
- ▶ Alta frecuencia en soldadura lo que permite un 50% más resistencia al desprendimiento
- ▶ Sierra 7 1/4" es perfecta para sierra circular
- ▶ Sierra 10" es perfecta para sierra de inglete



DIENTES ALTERNADOS
IZQUIERDA-DERECHA,
CORTES MÁS SUAVES



CÓDIGO	Ø	DIENTES			DISTRIB.	MAYOREO	LISTA
118501	7 1/4"	16	3	12	\$85.00	\$121.00	\$150.00
118502	7 1/4"	24	3	12	\$95.00	\$136.00	\$170.00
118503	7 1/4"	40	3	12	\$125.00	\$180.00	\$220.00
118504	7 1/4"	60	3	12	\$135.00	\$195.00	\$240.00
118511	10"	40	3	12	\$205.00	\$295.00	\$360.00
118512	10"	60	3	12	\$230.00	\$330.00	\$405.00
118513	10"	80	3	12	\$250.00	\$355.00	\$440.00

Sierras para madera, centro 1"

BLÍSTER

- ▶ Dientes de carburo de tungsteno
- ▶ Alta frecuencia en soldadura lo que permite un 50% más resistencia al desprendimiento
- ▶ Perfecta para sierra de mesa y sierra de inglete



CÓDIGO	Ø	DIENTES			DISTRIB.	MAYOREO	LISTA
118516	10"	40	3	12	\$200.00	\$285.00	\$355.00
118517	10"	60	3	12	\$230.00	\$330.00	\$405.00
118518	10"	80	3	12	\$310.00	\$445.00	\$545.00
118521	12"	40	3	12	\$310.00	\$445.00	\$545.00
118522	12"	60	3	12	\$340.00	\$485.00	\$600.00
118523	12"	80	3	12	\$390.00	\$555.00	\$690.00
118524	12"	100	3	12	\$400.00	\$570.00	\$705.00

Dispensador de agua para garrafón

CAJA

- ▶ Recarga mediante USB
- ▶ Fácil de instalar
- ▶ Práctico y sin esfuerzo



125401

125402

CARACTERÍSTICAS
Consumo 4 W
Voltaje DC - 5 V
Batería 1 200 mA

NOM



CÓDIGO	Color			DISTRIB.	MAYOREO	LISTA
125401	Negro	6	48	\$80.00	\$114.00	\$141.00
125402	Blanco	6	48	\$80.00	\$114.00	\$141.00



¿QUÉ TUNGSTENO DEBO UTILIZAR?

COLOR	CORRIENTE	MATERIAL A SOLDAR
VERDE	AC	Aluminio, Magnesio
AMARILLO	DC	Acero, Niquel, Titanio, Cobre
ROJO	DC	Acero, Niquel, Titanio, Cobre
MORADO	DC	Acero, Niquel, Titanio, Cobre
NARANJA	DC	Acero, Niquel, Titanio, Cobre
BLANCO	AC	Aluminio, Magnesio
NEGRO	AC/DC	Acero, Niquel, Titanio, Cobre, Aluminio
AZUL	AC/DC	Acero, Niquel, Titanio, Cobre, Aluminio
GRIS	AC/DC	Acero, Niquel, Titanio, Cobre, Aluminio
TURQUEZA	AC/DC	Acero, Niquel, Titanio, Cobre, Aluminio

NOMENCLATURA DE ELECTRODOS

Cómo saber que electrodo debo utilizar (E-6011, E-6013, E7018)

Este ejercicio esta realizado con el electrodo

E - 60 1 3

E	Electrodo
60	Resistencia mínima a la tracción Ksi (kilolibras/pulgada²) 1 Ksi = 1 000 psi En este ejemplo son 60 000 psi, representado con el 60
1	Posición para soldar 1: Todas las posiciones 2: Posición plana y horizontal 4: Todas, especialmente vertical con progresión descendente.
3	Tipo de revestimiento 0-1 Tipo celusico. 3-4 Tipo rutilico 5-6-8 Tipo básico o bajo Hidrógeno

Electrodos para soldadura SMAW, estructuras ligeras - 6013

NUEVO

BOLSA

- ▶ Corriente CA/CD
- ▶ Inicio de arco rápido y estable
- ▶ Acero suave de fácil fundición
- ▶ De baja escoria
- ▶ No genera porosidad



Ideal para láminas metálicas delgadas, soldadura y herrería en general

CÓDIGO	MEDIDA			DISTRIB.	MAYOREO	LISTA
130301	3/32"	5	20	\$55.00	\$79.00	\$97.00
130302	1/8"	5	20	\$55.00	\$79.00	\$97.00
130303	5/32"	5	20	\$55.00	\$79.00	\$97.00

Electrodos para soldadura SMAW, estructuras pesadas - 7018

NUEVO

BOLSA

- ▶ Corriente CA/CD
- ▶ Inicio de arco rápido y estable
- ▶ Acero suave de fácil fundición
- ▶ De baja escoria
- ▶ No genera porosidad



Para estructuras en edificios, puentes y construcción de recipientes sometidos a presión

CÓDIGO	MEDIDA			DISTRIB.	MAYOREO	LISTA
130311	3/32"	5	20	\$60.00	\$86.00	\$106.00
130312	1/8"	5	20	\$60.00	\$86.00	\$106.00
130313	5/32"	5	20	\$60.00	\$86.00	\$106.00

Electrodos para soldadura SMAW, alta penetración - 6011

NUEVO

BOLSA

- ▶ Corriente CA/CD
- ▶ Inicio de arco rápido y estable
- ▶ Acero suave de fácil fundición
- ▶ De baja escoria
- ▶ No genera porosidad



Para acero al carbono, industria metal-mecánica y herrería ligera

CÓDIGO	MEDIDA			DISTRIB.	MAYOREO	LISTA
130321	3/32"	5	20	\$60.00	\$86.00	\$106.00
130322	1/8"	5	20	\$60.00	\$86.00	\$106.00
130323	5/32"	5	20	\$60.00	\$86.00	\$106.00

Engrapadora tipo pistola con regulador de presión SERIE 50

BLÍSTER

- ▶ Regulador de presión ajustable
- ▶ Fija las grapas sin contragolpe
- ▶ Riel de acción rápida para grapas
- ▶ Incluye una caja con 400 grapas de 5/16" y 5/32" y 200 clavos de 5/6"



CLAVO CON CABEZA
Ancho de punta: 1.2 mm
Largo: 8 mm - 12 mm
(5/16" - 15/32")

GRAPA
Ancho de punta: 1.2 mm
Ancho de grapa: 11 mm
Largo: 4 mm - 14 mm
(5/32" - 9/16")

GRAPA PARA CABLE
Ancho de punta: 1.2 mm
Ancho de grapa: 6.3 mm
Largo: 8 mm - 14 mm
(5/16" - 9/16")



CÓDIGO	MEDIDAS DE GRAPA			DISTRIB.	MAYOREO	LISTA
109201	1/4", 5/16", 3/8", 1/2", 9/16"	4	24	\$195.00	\$280.00	\$345.00

Engrapadora tipo pistola con regulador de presión SERIE 21

BLÍSTER

- ▶ Regulador de presión ajustable
- ▶ Fija las grapas sin contragolpe
- ▶ Riel de acción rápida para grapas
- ▶ Incluye una caja con 200 grapas de 5/16"



CÓDIGO	MEDIDAS DE GRAPA			DISTRIB.	MAYOREO	LISTA
109202	1/4" y 5/16"	6	24	\$180.00	\$255.00	\$320.00

Engrapadora tipo pistola SERIE 19

BLÍSTER

- ▶ Fija las grapas sin contragolpe
- ▶ Riel de acción rápida para grapas
- ▶ Incluye una caja con 200 grapas de 5/16"



CÓDIGO	MEDIDAS DE GRAPA			DISTRIB.	MAYOREO	LISTA
109203	1/4" y 5/16"	6	24	\$140.00	\$200.00	\$245.00

GRAPA PARA ENGRAPADORA SERIE 50



CÓDIGO	LARGO DE GRAPA			DISTRIB.	MAYOREO	LISTA
109204	1/4" - 6.4 mm	10	40	\$12.00	\$17.10	\$21.20
109205	5/16" - 7.9 mm	10	40	\$14.00	\$20.00	\$24.70
109206	3/8" - 9.5 mm	10	40	\$16.00	\$22.90	\$28.00
109207	1/2" - 12.7 mm	10	40	\$19.00	\$27.00	\$34.00
109208	9/16" - 14.3 mm	10	40	\$20.00	\$29.00	\$35.00

GRAPA PARA ENGRAPADORA SERIE 21 y 19



CÓDIGO	LARGO DE GRAPA			DISTRIB.	MAYOREO	LISTA
109209	6.4 mm - 1/4"	10	40	\$12.00	\$17.10	\$21.20
109210	7.9 mm - 5/16"	10	40	\$13.00	\$18.60	\$22.90

Extensión de acero para rodillo

GRANEL

- ▶ Prácticas puntas con y sin cuerda para adaptar todo tipo de rodillos
- ▶ Máxima extensión de 1 m a 2 m



CÓDIGO	LARGO			DISTRIB.	MAYOREO	LISTA
106911	2 m	5	25	\$50.00	\$71.00	\$88.00

Extensión de acero para rodillo

GRANEL

- ▶ Prácticas puntas con cuerda para adaptar todo tipo de rodillos



CÓDIGO	LARGO			DISTRIB.	MAYOREO	LISTA
106912	1.2 m	30		\$28.00	\$40.00	\$49.00

Espátula 5 funciones mango de madera

GRANEL

- ▶ Hoja fabricada en acero al carbono
- ▶ Resistente a oxidación
- ▶ Multifuncional:

- 1 Limpieza de rodillos y tubos
- 2 Aplicación de mastique
- 3 Raspado
- 4 Emplastado
- 5 Ranurado



CÓDIGO	MEDIDA			DISTRIB.	MAYOREO	LISTA
100121	2 1/2"	12	120	\$39.00	\$56.00	\$69.00

Espátula flexible y rígida mango de madera

GRANEL

- ▶ Hojas fabricadas en acero templado y pulido tipo espejo
- ▶ Mangos de madera estufada, pulida y laqueada
- ▶ Hojas ensambladas a todo lo largo del mango: garantiza firmeza y duración



HOJA FLEXIBLE

CÓDIGO	MEDIDA			DISTRIB.	MAYOREO	LISTA
100101	1"	12	120	\$26.00	\$37.00	\$46.00
100102	2"	12	120	\$29.00	\$41.00	\$51.00
100103	3"	12	120	\$30.00	\$43.00	\$53.00
100104	4"	12	120	\$32.00	\$46.00	\$56.00
100105	5"	12	120	\$40.00	\$57.00	\$71.00
100106	6"	12	120	\$48.00	\$69.00	\$85.00

HOJA RÍGIDA

CÓDIGO	MEDIDA			DISTRIB.	MAYOREO	LISTA
100107	1"	12	120	\$26.00	\$37.00	\$46.00
100108	2"	12	120	\$29.00	\$41.00	\$51.00
100109	3"	12	120	\$30.00	\$43.00	\$53.00

Espátula flexible y rígida mango de plástico

GRANEL

- ▶ Hojas fabricadas en acero templado y pulidas
- ▶ Hojas ensambladas a todo lo largo del mango: garantizan firmeza y duración



HOJA FLEXIBLE

CÓDIGO	MEDIDA			DISTRIB.	MAYOREO	LISTA
300101	1"	12	120	\$14.00	\$20.00	\$24.70
300102	2"	12	120	\$15.00	\$21.40	\$26.00
300103	3"	12	120	\$16.00	\$22.90	\$28.00
300104	4"	12	120	\$17.00	\$24.30	\$30.00
300105	5"	12	120	\$20.00	\$29.00	\$35.00

HOJA RÍGIDA

CÓDIGO	MEDIDA			DISTRIB.	MAYOREO	LISTA
300106	2"	12	120	\$16.00	\$22.90	\$28.00
300107	3"	12	120	\$17.00	\$24.30	\$30.00

Juego de 4 cuñas con mango de plástico

CABALLETE

- ▶ Medidas: 50 mm, 80 mm, 100 mm y 120 mm
- ▶ Ideal para raspar, resanar, etc.



CÓDIGO			DISTRIB.	MAYOREO	LISTA
300131	12	96	\$19.00	\$27.00	\$34.00

Raspador con navaja 1 1/2"

BLÍSTER

- ▶ Cuerpo fabricado en acero
- ▶ Mango ergonómico
- ▶ Seguro que permite mejor fijación de la hoja
- ▶ Ideal para limpiar pegamento, pintura, silicón y cemento de superficies lisas como vidrio, azulejo, paredes y metal



INCLUYE:

- ▶ Navaja de acero SK5 2X

CÓDIGO	TAMAÑO			DISTRIB.	MAYOREO	LISTA
102121	40 mm - 1 1/2"	12	96	\$55.00	\$79.00	\$97.00

Raspador mini con navaja 1 1/2"

BLÍSTER

- ▶ Navaja fabricada en acero al alto carbono
- ▶ Ideal para limpiar pegamento, pintura, silicón y cemento de superficies lisas como vidrio, azulejo, paredes y metal



CÓDIGO	TAMAÑO			DISTRIB.	MAYOREO	LISTA
102122	40 mm - 1 1/2"	12	180	\$8.00	\$11.40	\$14.10

Complementos

Escuadra esquinera

BOLSA

- ▶ Fabricadas de acero galvanizado
- ▶ Con refuerzo angular
- ▶ Ideales para sostener objetos o reforzar esquineros

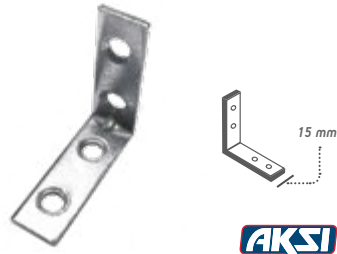

AKSI

CÓDIGO	MEDIDA	PZAS X BOLSA			DISTRIB.	MAYOREO	LISTA
106601	25 x 15 mm	50	6	24	\$48.00	\$69.00	\$85.00
106602	30 x 15 mm	50	6	24	\$65.00	\$93.00	\$115.00
106603	50 x 15 mm	50	3	12	\$90.00	\$129.00	\$160.00
106604	60 x 15 mm	25	6	24	\$60.00	\$86.00	\$106.00
106605	75 x 15 mm	24	3	18	\$80.00	\$114.00	\$141.00
106606	80 x 15 mm	24	3	18	\$105.00	\$150.00	\$185.00
106607	100 x 15 mm	24	3	12	\$130.00	\$185.00	\$230.00

Mínimo a surtir 1 bolsa

Escuadra esquinera con tornillos

BLÍSTER

- ▶ Set de 4 escuadras con 16 tornillos
- ▶ Fabricadas de acero galvanizado
- ▶ Con refuerzo angular



AKSI

PRECIO POR SET

CÓDIGO	MEDIDA			DISTRIB.	MAYOREO	LISTA
106611	25 x 15 mm	12	144	\$16.00	\$22.90	\$28.00
106612	30 x 15 mm	12	144	\$17.00	\$24.30	\$30.00
106613	50 x 15 mm	12	144	\$21.00	\$30.00	\$37.00
106614	60 x 15 mm	12	72	\$23.00	\$33.00	\$41.00
106615	75 x 15 mm	12	72	\$32.00	\$46.00	\$56.00
106617	100 x 15 mm	12	72	\$50.00	\$71.00	\$88.00

Escuadra para carpintero

GRANEL

- ▶ Fabricadas en acero inoxidable, graduada en centímetros y pulgadas
- ▶ Marcado en bajo relieve
- ▶ Mango de aluminio para mayor exactitud y resistencia



MANGO DE ALUMINIO para mayor exactitud

AKSI

CÓDIGO	MEDIDA			DISTRIB.	MAYOREO	LISTA
100703	15 cm - 6"	6	36	\$60.00	\$86.00	\$106.00
100704	20 cm - 8"	6	36	\$65.00	\$93.00	\$115.00
100701	25 cm - 10"	6	36	\$75.00	\$107.00	\$132.00
100702	30 cm - 12"	6	36	\$85.00	\$121.00	\$150.00

Escuadra falsa

BLÍSTER

- ▶ Regla de acero inoxidable
- ▶ Mango de plástico ABS resistente a fuertes impactos
- ▶ Regla de 8" de longitud
- ▶ Corte de regla en ángulo de 45°



REGLA DE ACERO INOXIDABLE

ÁNGULO ajustable

10 años GARANTÍA

AKSI

CÓDIGO	MEDIDA			DISTRIB.	MAYOREO	LISTA
100706	20 cm - 8"	10	30	\$60.00	\$86.00	\$106.00

Escuadra de combinación

TARJETA

- ▶ Cabeza maquinada con caras rectificadas para ángulos de 45° y 90°
- ▶ Graduación estampada en acero



REGLA DE ACERO INOXIDABLE

GOTA PARA NIVELAR

PUNTA PARA MARCAR

10 años GARANTÍA

AKSI

CÓDIGO	MEDIDA			DISTRIB.	MAYOREO	LISTA
100707	30 cm - 12"	6	36	\$130.00	\$185.00	\$230.00

Escuadra cantero

NUEVO

GRANEL

- ▶ Fabricada en Acero al Carbono
- ▶ Graduación en sistema métrico y standard
- ▶ Ideal en la comprobación de ángulos rectos
- ▶ Con agujero para colgar



AKSI

CÓDIGO	MEDIDA			DISTRIB.	MAY.	LISTA
100711	8" x 12"	6	36	\$50.00	\$71.00	\$88.00
100712	16" x 24"	6	36	\$125.00	\$180.00	\$220.00

Escuadra magnética

NUEVO

BLÍSTER

- ▶ Ideal en trabajos de soldadura
- ▶ Permite alinear, marcar y ensamblar fácilmente



AKSI

CÓDIGO	MEDIDA	CAPACIDAD		DISTRIB.	MAY.	LISTA
130401	3" (7.5 cm)	25 lb - 11 kg	4	\$40.00	\$57.00	\$71.00
130402	4" (10 cm)	50 lb - 22 kg	4	\$65.00	\$93.00	\$115.00
130403	5" (12.5 cm)	75 lb - 34 kg	4	\$120.00	\$170.00	\$210.00

Encendedor tipo cazuela y repuestos

CABALLETE Y BOLSA PLÁSTICA (REPUESTOS)

- ▶ Ideal para soldadura de gas
- ▶ Piedra de chispeo intercambiable
- ▶ Cazuela niquelada y mango cromado



REPUESTO 124109 CONTIENE 5 PIEZAS

124101

CÓDIGO			DISTRIB.	MAYOREO	LISTA
124101	6	36	\$22.00	\$31.00	\$39.00
124109	N/A	300	\$14.00	\$20.00	\$24.70

Encendedor tipo antorcha

BLÍSTER

- ▶ Botón de ignición
- ▶ Botón de seguridad
- ▶ Flama ajustable
- ▶ Mecanismo de recarga
- ▶ Monitoreo de combustible a través de una ventana
- ▶ Encendido electrónico
- ▶ Variedad de colores



CÓDIGO			DISTRIB.	MAYOREO	LISTA
310301	12	144	\$22.00	\$31.00	\$39.00

Encendedor tipo antorcha con cartucho de repuesto

BLÍSTER

- ▶ Incluye cartucho de repuesto
- ▶ Botón de ignición
- ▶ Botón de seguridad
- ▶ Flama ajustable
- ▶ Mecanismo de recarga
- ▶ Monitoreo de combustible a través de una ventana
- ▶ Encendido electrónico
- ▶ Variedad de colores



CÓDIGO			DISTRIB.	MAYOREO	LISTA
310302	12	120	\$30.00	\$43.00	\$53.00

Escoba metálica para jardín 22 dientes

GRANEL

- ▶ Fabricadas en acero alto carbono SAE 1050 gran resistencia al desgaste
- ▶ Uso rudo en hierba húmeda
- ▶ Acabado en pintura electrostática
- ▶ Mango de madera perfilada
- ▶ Diseño curvo



CÓDIGO	PRESENTACIÓN		DISTRIB.	MAYOREO	LISTA
100602	Con mango	50	\$75.00	\$107.00	\$132.00
100605	Sin mango	25	\$60.00	\$86.00	\$106.00

Escoba metálica para jardín de 22 dientes

GRANEL

- ▶ Fabricada en acero al carbono
- ▶ Mango de madera perfilada
- ▶ Para uso en hierba húmeda
- ▶ Acabado en pintura electrostática
- ▶ Diseño curvo



CÓDIGO	PRESENTACIÓN		DISTRIB.	MAYOREO	LISTA
302502	Con mango	25	\$70.00	\$100.00	\$123.00
302504	Sin mango	25	\$55.00	\$79.00	\$97.00

Escoba plástica para jardín de 22 dientes

GRANEL

- ▶ Fabricadas en polipropileno, gran flexibilidad en los dientes ya que no se deforman
- ▶ Para uso en hierba seca
- ▶ Mango de madera pulido



CÓDIGO	PRESENTACIÓN			DISTRIB.	MAYOREO	LISTA
302503	Con mango	N/A	36	\$65.00	\$93.00	\$115.00
302505	Sin mango	6	24	\$45.00	\$64.00	\$79.00

Rastrillo jardinero

NUEVO

GRANEL

- ▶ Cabeza de acero con 14 dientes
- ▶ Mango de madera



CARACTERÍSTICAS	
Cabeza	14.5" (37 cm)
Mango	49" (125 cm)
Espesor de peine	5/32" (4 mm)

CÓDIGO	DISTRIB.	MAYOREO	LISTA
111231	\$135.00	\$195.00	\$240.00

Rastrillo recto

NUEVO

GRANEL

- ▶ Cabeza de acero con 16 dientes
- ▶ Mango de madera



CARACTERÍSTICAS	
Cabeza	16 1/2" (42 cm)
Mango	60" (152 cm)
Espesor de peine	3/16" (4.8 mm)

CÓDIGO		DISTRIB.	MAYOREO	LISTA
111232	6	\$175.00	\$250.00	\$310.00

Escalera telescópica

GRANEL

- ▶ Escalera multiusos retráctil, fácil de guardar y transportar
- ▶ Escalera de aluminio
- ▶ Botones de seguridad con mecanismo de resorte
- ▶ Estructura tubular con bloqueo automático de escalones
- ▶ Capacidad de carga de **150 kg**

AHORRA ESPACIO EN ALMACENAMIENTO



116971



116972



Correa de seguridad

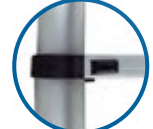

Mecanismo de bloqueo



Tapa inferior antideslizante



CÓDIGO	ESCALONES	ALTURA TOTAL (m)	PESO (kg)	DISTRIB.	MAYOREO	LISTA
116971	9	2.6 m	6,75	\$1,900.00	\$2,715.00	\$3,350.00
116972	11	3.2 m	8,25	\$2,300.00	\$3,285.00	\$4,055.00

Escalera de extensión - Tipo III

GRANEL

- ▶ Escalones en forma D con superficie antiderrapante
- ▶ Mecanismo de trampa con candado que asegura las dos secciones de la escalera
- ▶ Sistema de polea y cuerda
- ▶ Tacones móviles con suela antiderrapante
- ▶ Capacidad de carga de **90 kg**

116951



116952



116953



Trampa con candado



Sistema de polea y cuerda



Tacones móviles con suela antiderrapante



CÓDIGO	ESCALONES	ALTURA TOTAL (m)	PESO (kg)	DISTRIB.	MAYOREO	LISTA
116951	16	3.96	8.2	\$2,800.00	\$4,000.00	\$4,940.00
116952	20	5.23	11.1	\$3,300.00	\$4,715.00	\$5,820.00
116953	24	6.40	14.5	\$4,350.00	\$6,215.00	\$7,675.00

Escalera de tijera - Tipo III

GRANEL

- ▶ Ancho de larguero de 3"
- ▶ Escalones con superficie antiderrapante
- ▶ Tapa con ranuras porta herramientas
- ▶ Porta cubetas plástico automático
- ▶ Tacones con suela antiderrapante
- ▶ Capacidad de carga de **90 kg**
- ▶ Sistema antipellizcos



Porta cubetas automático.



Tapa plástica con ranuras porta herramientas



CÓDIGO	ESCALONES	ALTURA (m)	APERTURA LATERAL (m)	PESO (kg)	DISTRIB.	MAYOREO	LISTA
116902	3	1.22	0.60	4.0	\$1,100.00	\$1,570.00	\$1,940.00
116903	4	1.52	0.75	4.7	\$1,300.00	\$1,855.00	\$2,295.00
116904	5	1.83	0.91	5.4	\$1,500.00	\$2,145.00	\$2,645.00
116905	6	2.13	1.07	6.0	\$1,750.00	\$2,500.00	\$3,085.00

Escalera de tijera - Tipo III

GRANEL

- ▶ Ancho de larguero de 2.3"
- ▶ Escalones con superficie antiderrapante
- ▶ Tapa con ranuras porta herramientas
- ▶ Porta cubetas plástico automático
- ▶ Tacones con suela antiderrapante
- ▶ Capacidad de carga de **90 kg**
- ▶ Sistema antipellizcos



Porta cubetas automático.



Tapa plástica con ranuras porta herramientas



CÓDIGO	ESCALONES	ALTURA (m)	APERTURA LATERAL (m)	PESO (kg)	DISTRIB.	MAYOREO	LISTA
308902	3	1.22	0.60	3.4	\$950.00	\$1,355.00	\$1,675.00
308903	4	1.52	0.75	3.9	\$1,100.00	\$1,570.00	\$1,940.00
308904	5	1.83	0.91	4.5	\$1,250.00	\$1,785.00	\$2,205.00

Taburete plegable

GRANEL

- ▶ Refuerzos metálicos laterales
- ▶ Refuerzos plásticos superiores
- ▶ Fabricado en aluminio
- ▶ Superficie antiderrapante
- ▶ Capacidad de carga: **90 kg**



ALTURA : 30 cm



Refuerzos metálicos laterales



Refuerzos plásticos superiores



CÓDIGO	ESCALÓN	DISTRIB.	MAYOREO	LISTA
308911	1	\$285.00	\$405.00	\$505.00

Calidad superior a las extensiones económicas ¡NO TE ARRIESGUES!

Extensión triple de uso rudo calibre 16

FAJILLA

- ▶ Clavija polarizada
- ▶ Cable 2x16 AWG
- ▶ Doble recubrimiento de PVC
- ▶ 3 contactos
- ▶ Material autoextinguible



CARACTERÍSTICAS

Tensión: 127 V~
Frecuencia: 60 Hz
Corriente: 10 A / 13 A



CÓDIGO	LARGO	DISTRIB.	MAYOREO	LISTA	
110315	2 m	6	\$33.00	\$47.00	\$58.00
110316	4 m	6	\$53.00	\$76.00	\$93.00
110317	6 m	6	\$73.00	\$104.00	\$129.00
110318	8 m	6	\$94.00	\$134.00	\$165.00
110319	10 m	5	\$110.00	\$155.00	\$195.00
110320	12 m	5	\$135.00	\$195.00	\$240.00
110321	15 m	4	\$160.00	\$230.00	\$280.00
110322	20 m	3	\$225.00	\$320.00	\$395.00
110323	25 m	2	\$285.00	\$405.00	\$505.00
110324	30 m	2	\$340.00	\$485.00	\$600.00

Extensión doméstica calibre 16 blanca

FAJILLA

- ▶ Clavija polarizada
- ▶ Recubrimiento de PVC
- ▶ Material autoextinguible



CARACTERÍSTICAS

Tensión: 127 V~
Frecuencia: 60 Hz
Corriente: 13 A



CÓDIGO	LARGO	DISTRIB.	MAYOREO	LISTA	
110301	2 m	12	\$21.00	\$30.00	\$37.00
110302	3 m	12	\$27.00	\$39.00	\$48.00
110303	4 m	12	\$33.00	\$47.00	\$58.00
110304	5 m	12	\$40.00	\$57.00	\$71.00
110305	6 m	12	\$45.00	\$64.00	\$79.00
110306	8 m	12	\$55.00	\$79.00	\$97.00
110307	10 m	12	\$68.00	\$97.00	\$120.00

Extensión doméstica calibre 16 café

FAJILLA

- ▶ Clavija polarizada
- ▶ Recubrimiento de PVC
- ▶ Material autoextinguible



CARACTERÍSTICAS

Tensión: 127 V~
Frecuencia: 60 Hz
Corriente: 13 A



CÓDIGO	LARGO	DISTRIB.	MAYOREO	LISTA	
110334	2 m	72	\$23.00	\$33.00	\$41.00
110335	3 m	72	\$30.00	\$43.00	\$53.00
110336	4 m	72	\$36.00	\$51.00	\$64.00
110337	5 m	72	\$43.00	\$61.00	\$76.00
110338	6 m	72	\$50.00	\$71.00	\$88.00
110339	8 m	48	\$62.00	\$89.00	\$109.00
110340	10 m	48	\$75.00	\$107.00	\$132.00

Portalámpara con cable de alimentación

FAJILLA

- ▶ Extensión con recubrimiento de PVC, autoextinguible
- ▶ Portalámpara de baquelita
- ▶ Cable calibre 18



Tensión: 127 V~
Frecuencia: 60 Hz
Corriente: 10 A
Calibre: 18 AWG



CÓDIGO	LARGO	DISTRIB.	MAYOREO	LISTA	
117591	4 m	30	\$45.00	\$64.00	\$79.00
117592	6 m	25	\$55.00	\$79.00	\$97.00
117593	8 m	20	\$70.00	\$100.00	\$123.00

Lámpara de taller

FAJILLA

- ▶ Clavija polarizada
- ▶ Cable 2x16 AWG
- ▶ Doble recubrimiento de PVC
- ▶ Interruptor de encendido



CARACTERÍSTICAS

Tensión: 127 V~
Frecuencia: 60 Hz
Corriente: 10 A
Calibre: 2 x16 AWG



CÓDIGO	LARGO	DISTRIB.	MAYOREO	LISTA	
113701	15 m	3	\$295.00	\$420.00	\$520.00

Flota de esponja

GRANEL

- ▶ Gran capacidad de retención de agua
- ▶ Especiales para acabado con cemento o pastas



MANGO DE MADERA



CÓDIGO	TAMAÑO	DISTRIB.	MAYOREO	LISTA	
300401	9 1/2" x 4" x 3/4"	6	\$70.00	\$100.00	\$123.00

Flota de esponja profesional

GRANEL

- ▶ Gran capacidad de retención de agua
- ▶ Especiales para acabados con cemento o pastas



MANGO DE MADERA



CÓDIGO	TAMAÑO	DISTRIB.	MAYOREO	LISTA	
101207	9 1/2" x 4" x 3/4"	6	\$80.00	\$114.00	\$141.00

Flota acabado fino

GRANEL

- ▶ Para colocación de boquilla en pisos y acabados finos de cemento en repellados



MANGO DE MADERA

5/8"
101209

7/16"
101208



CÓDIGO	TAMAÑO	DISTRIB.	MAYOREO	LISTA	
101209	9 1/2" x 4" x 5/8"	6	\$80.00	\$114.00	\$141.00
101208	9 1/2" x 4" x 7/16"	6	\$50.00	\$71.00	\$88.00

Flexómetro



BLÍSTER

- ▶ Cinta impresa por ambos lados
- ▶ Compacto y ergonómico



CÓDIGO	LARGO	MODELO			DISTRIB.	MAYOREO	LISTA
103121	3 m	FLEX-3DC-AK	6	120	\$40.00	\$57.00	\$71.00
103122	5 m	FLEX-5DC-AK	6	120	\$65.00	\$93.00	\$115.00
103123	8 m	FLEX-8DC-AK	6	60	\$100.00	\$143.00	\$175.00

Flexómetro anti impacto



BLÍSTER

- ▶ Cinta impresa por ambos lados
- ▶ Cuerpo ABS
- ▶ Cubierta anti impacto



CÓDIGO	MODELO	LARGO			DISTRIB.	MAYOREO	LISTA
103111	FLEX-3LX-AK	3 m	6	120	\$50.00	\$71.00	\$88.00
103112	FLEX-5LX-AK	5 m	6	120	\$75.00	\$107.00	\$132.00
103113	FLEX-8LX-AK	8 m	6	60	\$130.00	\$185.00	\$230.00

Flexómetro anti impacto



GRANEL, BLÍSTER y TARJETA

- ▶ Cubierta protegida con plástico anti impactos
- ▶ Cinta antirreflejante blanca que facilita la lectura
- ▶ Cuenta con tres sistemas de frenado:
 - Botón deslizable
 - Botón inferior de frenado rápido
 - Botón lateral de frenado rápido



Presentación: GRANEL



Presentación: BLÍSTER



Presentación: TARJETA



GRANEL

CÓDIGO	LARGO	MODELO			DISTRIB.	MAYOREO	LISTA
301631	3 m	FLEX-3A-MX	12	120	\$35.00	\$50.00	\$62.00
301632	5 m	FLEX-5A-MX	6	120	\$55.00	\$79.00	\$97.00
301633	8 m	FLEX-8A-MX	6	60	\$95.00	\$136.00	\$170.00

BLÍSTER

CÓDIGO	LARGO	MODELO			DISTRIB.	MAYOREO	LISTA
301640	3 m	FLEX-3A-MX	12	120	\$37.00	\$53.00	\$65.00
301641	5 m	FLEX-5A-MX	6	120	\$57.00	\$81.00	\$101.00
301642	8 m	FLEX-8A-MX	6	60	\$100.00	\$143.00	\$175.00

TARJETA EXHIBIDORA

CÓDIGO	LARGO	PIEZAS POR TARJETA		DISTRIB.	MAYOREO	LISTA
301643	3 m	12	10	\$415.00	\$595.00	\$730.00
301644	5 m	6	20	\$325.00	\$465.00	\$575.00
301645	8 m	6	10	\$570.00	\$815.00	\$1,005.00

Flexómetro cinta blanca



GRANEL, BLÍSTER y TARJETA

- ▶ Cuerpo fabricado en ABS de alto impacto
- ▶ Cinta en color blanco antirreflejante que facilita la lectura
- ▶ Flexómetros en colores diferentes



Presentación: GRANEL



Presentación: BLÍSTER



Presentación: TARJETA



GRANEL

CÓDIGO	LARGO	MODELO	COLOR			DISTRIB.	MAY.	LISTA
301611	3 m	FLEX-3M-MX	Amarillo	12	120	\$23.00	\$33.00	\$41.00
301612	3 m	FLEX-3M-R-MX	Rojo	12	120	\$23.00	\$33.00	\$41.00
301613	3 m	FLEX-3M-A-MX	Azul	12	120	\$23.00	\$33.00	\$41.00
301614	5 m	FLEX-5M-MX	Amarillo	6	120	\$35.00	\$50.00	\$62.00
301615	5 m	FLEX-5M-R-MX	Rojo	6	120	\$35.00	\$50.00	\$62.00
301616	5 m	FLEX-5M-A-MX	Azul	6	120	\$35.00	\$50.00	\$62.00
301617	8 m	FLEX-8M-MX	Amarillo	6	60	\$65.00	\$93.00	\$115.00
301618	8 m	FLEX-8M-R-MX	Rojo	6	60	\$65.00	\$93.00	\$115.00
301619	8 m	FLEX-8M-A-MX	Azul	6	60	\$65.00	\$93.00	\$115.00

BLÍSTER

CÓDIGO	LARGO	MODELO			DISTRIB.	MAYOREO	LISTA
301620	3 m	FLEX-3M-MX	6	60	\$24.00	\$34.00	\$42.00
301621	5 m	FLEX-5M-MX	4	60	\$38.00	\$54.00	\$67.00
301622	8 m	FLEX-8M-MX	4	60	\$72.00	\$103.00	\$127.00

TARJETA EXHIBIDORA

CÓDIGO	LARGO	PIEZAS POR TARJETA		DISTRIB.	MAYOREO	LISTA
301623	3 m	12	10	\$275.00	\$395.00	\$485.00
301624	5 m	6	20	\$225.00	\$320.00	\$395.00
301625	8 m	6	10	\$390.00	\$555.00	\$690.00

Fumigador 1 litro

BOLSA

- ▶ Boquilla regulable que logra desde un rocío fino hasta un chorro uniforme
- ▶ Pistón y gatillo de suave acción
- ▶ Para uso en interiores y exteriores
- ▶ Útil para riego, control de plagas, limpieza general, etc.



CÓDIGO	CAPACIDAD	ICONO	DISTRIB.	MAYOREO	LISTA
103503	1 L	4 16	\$75.00	\$107.00	\$132.00

Fumigador 2 litros

CAJA

- ▶ Boquilla de latón regulable que logra desde un rocío fino hasta chorro uniforme
- ▶ Pistón y gatillo de suave acción
- ▶ Para uso en interiores y exteriores
- ▶ Útil para riego, control de plagas, limpieza general, etc.



CÓDIGO	CAPACIDAD	ICONO	DISTRIB.	MAYOREO	LISTA
103504	2L	4 16	\$95.00	\$136.00	\$170.00

Fumigador 15 litros tipo mochila

CAJA

- ▶ Pipeta y boquilla de polipropileno
- ▶ Tanque translúcido que permite ver el nivel del líquido
- ▶ Manguera de PVC



USO AGRÍCOLA
No causa I.V.A.

CÓDIGO	CAPACIDAD	ICONO	DISTRIB.	MAYOREO	LISTA
103515	15 L	1	\$650.00	\$930.00	\$1,330.00

Fumigador 5 litros

CAJA

- ▶ Práctico y ligero para el control de plagas
- ▶ Boquilla de aspersión más grande, que brinda mayor área de rocío
- ▶ Correa de tejido de Nylon® ligera y resistente para portar al hombro



USO AGRÍCOLA
No causa I.V.A.

CÓDIGO	CAPACIDAD	ICONO	DISTRIB.	MAYOREO	LISTA
301101	5 L	6	\$180.00	\$255.00	\$370.00

PRÓX.

FUMIGADOR A GASOLINA
25 L - 1 Hp

CAJA

- ▶ Motor a 2 tiempos, mezcla de aceite y gasolina 50:1
- ▶ Arranque manual (cuerda retráctil)
- ▶ Lanzas y boquillas de acero inoxidable
- ▶ Doble lanza de 60 cm
- ▶ Presión regulable
- ▶ Doble manguera de pulverizado
- ▶ Tanque de polietileno
- ▶ Mangos con válvula



USO AGRÍCOLA
No causa I.V.A.



191031

Capacidad	25 L (6.6 gal)
Presión máxima de trabajo	362 psi
Potencia	750 W (1 Hp)
Cilindrada del motor	25 cc
Peso	9 kg

CÓDIGO	CAPACIDAD	DISTRIB.	MAYOREO	LISTA
191031	25 L	\$2,700.00	\$3,855.00	\$5,525.00

Repuestos para fumigador (103515)

GRANEL

Pistón



103521

Juego de boquillas



103520

Juego de empaques



103519

Tubo rociador



103518

Pistola



103517

Manguera



103516



CÓDIGO	DESCRIPCIÓN	ICONO	DISTRIB.	MAYOREO	LISTA
103521	Pistón		\$100.00	\$143.00	\$175.00
103520	Juego de boquillas		\$23.00	\$33.00	\$41.00
103519	Juego de empaques		\$60.00	\$86.00	\$106.00
103518	Tubo rociador		\$130.00	\$185.00	\$230.00
103517	Pistola		\$100.00	\$143.00	\$175.00
103516	Manguera		\$65.00	\$93.00	\$115.00

Faja con tirantes ajustables

BLÍSTER

- ▶ Cómodo diseño anatómico que permite reducir la fuerza sobre la columna, aumenta la presión intraabdominal y reduce el esfuerzo durante el levantamiento
- ▶ Laterales elásticos ajustables que brindan mayor seguridad
- ▶ Ajuste de cerrado con Velcro®

*Velcro® es una marca registrada



CINTURÓN AJUSTABLE

CIERRE CON VELCRO



CÓDIGO	TALLA	HECHO EN MÉXICO	DISTRIB.	MAYOREO	LISTA
107705	Grande	4	16	\$130.00	\$185.00 \$230.00
107706	Mediana	4	16	\$130.00	\$185.00 \$230.00

Chaleco brigadista con cinta reflejante

CABALLETE

- ▶ Fabricado en 100% poliéster
- ▶ Cintas reflejantes de 2" en frente y espalda
- ▶ Cierre frontal
- ▶ Broches laterales ajustables
- ▶ 4 Bolsas con cierre
- ▶ Para uso de día y de noche
- ▶ Unitalla

108111



CÓDIGO	COLOR	HECHO EN MÉXICO	DISTRIB.	MAYOREO	LISTA
108111	Amarillo	3	60	\$190.00	\$270.00 \$335.00
108112	Azul marino	3	60	\$190.00	\$270.00 \$335.00
108113	Azul rey	3	60	\$190.00	\$270.00 \$335.00
108114	Beige	3	60	\$190.00	\$270.00 \$335.00
108115	Gris	3	60	\$190.00	\$270.00 \$335.00
108116	Naranja	3	60	\$190.00	\$270.00 \$335.00
108117	Negro	3	60	\$190.00	\$270.00 \$335.00
108118	Rojo	3	60	\$190.00	\$270.00 \$335.00
108119	Rosa	3	60	\$190.00	\$270.00 \$335.00
108120	Verde	3	60	\$190.00	\$270.00 \$335.00
108121	Vino	3	60	\$190.00	\$270.00 \$335.00

Cascos de seguridad, 6 clips

BOLSA

- ▶ Casco Tipo 1 clase E
- ▶ Diseño reforzado
- ▶ Fabricado con polipropileno de alto impacto resistente a voltajes de hasta 20 000 V
- ▶ Suspensión plástica



108201



CÓDIGO	COLOR	HECHO EN MÉXICO	DISTRIB.	MAYOREO	LISTA
108201	Amarillo	40	\$95.00	\$136.00	\$170.00
108202	Azul	40	\$95.00	\$136.00	\$170.00
108203	Verde	40	\$95.00	\$136.00	\$170.00
108204	Blanco	40	\$95.00	\$136.00	\$170.00
108205	Naranja	40	\$95.00	\$136.00	\$170.00

Cascos de seguridad, 4 clips

PROX. ●

BOLSA

- ▶ Casco Tipo 1 clase E
- ▶ Fabricado con polipropileno de alto impacto resistente a voltajes de hasta 20 000 V
- ▶ Suspensión plástica



309301



CÓDIGO	COLOR	HECHO EN MÉXICO	DISTRIB.	MAYOREO	LISTA
309301	Amarillo	40	\$72.00	\$103.00	\$127.00
309302	Blanco	40	\$72.00	\$103.00	\$127.00
309303	Azul	40	\$72.00	\$103.00	\$127.00
309304	Naranja	40	\$72.00	\$103.00	\$127.00



ASEGURAMOS tu trabajo diario



Gafas para soldar y repuestos

CABALLETE

- ▶ Marco facial con cinta elástica
- ▶ Sombra No. 6
- ▶ Ideal para soldar y para uso en oxicator
- ▶ Repuestos de policarbonato



105802



105832



105831



CÓDIGO	ACABADO	HECHO EN MÉXICO	DISTRIB.	MAYOREO	LISTA	
105802	Gafas	6	36	\$70.00	\$100.00	\$123.00
105831	Cristal transparente	20	120	\$8.00	\$11.40	\$14.10
105832	Filtro 6 sombras	20	120	\$8.00	\$11.40	\$14.10

Gis azul para tiralíneas

BOTE

- ▶ Gis de alta visibilidad
- ▶ Práctico dosificador para un fácil llenado
- ▶ Se recomienda el uso en el tiralíneas AKSI® o similares



CÓDIGO	HECHO EN MÉXICO	DISTRIB.	MAYOREO	LISTA	
119415	6	36	\$20.00	\$29.00	\$35.00

Grasa multiuso 450 g

BOTE DE PLÁSTICO

- ▶ Gran adhesividad y estabilidad mecánica
- ▶ Para chasis, baleros, equipo agrícola, industrial y de construcción



CÓDIGO	CONTENIDO	HECHO EN MÉXICO	DISTRIB.	MAYOREO	LISTA
119591	450 g	12	\$80.00	\$114.00	\$141.00

Goggles de seguridad

CABALLETE

- ▶ Protege los ojos contra impactos, polvos, chispas, astilladuras y salpicaduras
- ▶ Ventilación directa, antiempañante
- ▶ Mica fabricada en policarbonato



18 meses GARANTÍA



CÓDIGO	HECHO EN MÉXICO	DISTRIB.	MAYOREO	LISTA	
306601	6	60	\$25.00	\$36.00	\$44.00

Grapas blancas rectas para cable

BOLSA

- ▶ Material de polietileno
- ▶ Para fijar cable plano
- ▶ Con clavo galvanizado para concreto



116161

116162

116163



CÓDIGO	ANCHO	PZAS. X BOLSA	HECHO EN MÉXICO	DISTRIB.	MAY.	LISTA
116161	5 mm	20	20 bolsas 120 bolsas	\$4.00	\$5.70	\$7.10
116162	8 mm	20	20 bolsas 120 bolsas	\$5.00	\$7.10	\$8.80
116163	10 mm	20	20 bolsas 120 bolsas	\$5.40	\$7.70	\$9.50

Mínimo a surtir 1 bolsa

Grapas curvas para cable coaxial

BOLSA

- ▶ Material de polietileno
- ▶ Para fijar cable coaxial
- ▶ Con clavo galvanizado para concreto



GRAPA BLANCA

CÓDIGO	ANCHO	PZAS. X BOLSA	HECHO EN MÉXICO	DISTRIB.	MAYOREO	LISTA
116151	5 mm	20	20 bolsas 120 bolsas	\$4.10	\$5.90	\$7.20
116152	6 mm	20	20 bolsas 120 bolsas	\$4.70	\$6.70	\$8.30
116153	8 mm	20	20 bolsas 120 bolsas	\$5.00	\$7.10	\$8.80
116154	10 mm	20	20 bolsas 120 bolsas	\$6.00	\$8.60	\$10.60
116155	12 mm	20	20 bolsas 120 bolsas	\$6.60	\$9.40	\$11.60
116156	16 mm	20	20 bolsas 120 bolsas	\$11.00	\$15.70	\$19.40

GRAPA NEGRA

116150	6 mm	20	20 bolsas 120 bolsas	\$4.70	\$6.70	\$8.30
--------	------	----	----------------------	--------	--------	--------

Mínimo a surtir 1 bolsa

Grapas para alambre de púas

GRANEL

- ▶ Elemento de sujeción para los postes de madera con los alambres de púas
- ▶ Fabricadas en acero
- ▶ Muecas para un mejor agarre



PRECIO POR KILO



CÓDIGO	TIPO	MEDIDA	CALIBRE	HECHO EN MÉXICO	DISTRIB.	MAYOREO	LISTA	
117061	Negra	1"	8	1 kg	25 kg	\$42.00	\$60.00	\$74.00
117062	Negra	1 1/4"	8	1 kg	25 kg	\$42.00	\$60.00	\$74.00
117063	Galvanizada	1"	9	1 kg	25 kg	\$47.00	\$67.00	\$83.00
117064	Galvanizada	1 1/4"	9	1 kg	25 kg	\$47.00	\$67.00	\$83.00

Mínimo a surtir 1 bolsa de 1 kilo

Grapa

CAJA

- ▶ Compatibles con sus similares en el mercado
- ▶ Ideales para tapicería, pósters, malla, mosquiteros, marcos, anuncios, etc.
- ▶ Cada caja contiene 1,000 grapas

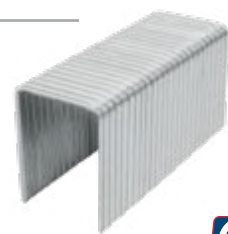

PARA ENGRAPADORAS SERIE 50

CÓDIGO	LARGO DE GRAPA	HECHO EN MÉXICO	DISTRIB.	MAYOREO	LISTA	
109204	1/4" - 6.4 mm	10	40	\$12.00	\$17.10	\$21.20
109205	5/16" - 7.9 mm	10	40	\$14.00	\$20.00	\$24.70
109206	3/8" - 9.5 mm	10	40	\$16.00	\$22.90	\$28.00
109207	1/2" - 12.7 mm	10	40	\$19.00	\$27.00	\$34.00
109208	9/16" - 14.3 mm	10	40	\$20.00	\$29.00	\$35.00

PARA ENGRAPADORAS SERIE 19 Y 21

109209	6.4 mm - 1/4"	10	40	\$12.00	\$17.10	\$21.20
109210	7.9 mm - 5/16"	10	40	\$13.00	\$18.60	\$22.90

Guantes de carnaza para soldador (uso rudo, unitalla)

TARJETA

- ▶ Forro de algodón, uniones protegidas con carnaza y costuras de hilo kevlar®
- ▶ Máxima protección contra chispas y calor

Kevlar® es una marca registrada



PUÑO DE SEGURIDAD



CÓDIGO	COMPOSICIÓN			DISTRIB.	MAYOREO	LISTA
103718	Carnaza	6	36	\$120.00	\$170.00	\$210.00

Guantes de carnaza largo o corto (uso rudo, unitalla)

TARJETA

- ▶ Diseño largo y palma reforzada
- ▶ Resistente y ligero
- ▶ Ideal para soldar



CÓDIGO	COMPOSICIÓN	TIPO			DISTRIB.	MAYOREO	LISTA
103710	Carnaza	Largo	6	60	\$85.00	\$121.00	\$150.00
103711	Carnaza	Corto	6	60	\$65.00	\$93.00	\$115.00

Guantes de carnaza con doble refuerzo, unitalla

TARJETA

- ▶ Doble refuerzo en palmas
- ▶ Forro suave de tela
- ▶ Ideal para uso rudo



PUÑO DE SEGURIDAD



CÓDIGO	COMPOSICIÓN			DISTRIB.	MAYOREO	LISTA
103701	Carnaza y algodón	6	60	\$65.00	\$93.00	\$115.00

Guantes de carnaza corto con banda ajustable, unitalla

TARJETA

- ▶ Muñeca con tejido elástico
- ▶ Diseño corto
- ▶ Ideal para usos ligeros



PUÑO AJUSTADO



CÓDIGO	COMPOSICIÓN			DISTRIB.	MAYOREO	LISTA
103703	Carnaza	6	60	\$65.00	\$93.00	\$115.00

Guantes de carnaza y loneta, unitalla

TARJETA

- ▶ Palma de una sola pieza
- ▶ Forro suave de tela
- ▶ Ideal para usos generales



PUÑO DE SEGURIDAD



CÓDIGO	COMPOSICIÓN			DISTRIB.	MAYOREO	LISTA
103702	Carnaza y loneta	6	60	\$55.00	\$79.00	\$97.00

Guantes de carnaza y tela (tipo payaso, unitalla)

TARJETA

- ▶ Carnaza ligera y loneta
- ▶ Puño tejido para protección en la muñeca
- ▶ Ideal para construcción y manejo de herramientas



PUÑO TEJIDO



CÓDIGO	COMPOSICIÓN			DISTRIB.	MAYOREO	LISTA
103704	Tela y carnaza	12	120	\$45.00	\$64.00	\$79.00

Guantes de loneta, unitalla

TARJETA

- ▶ Loneta de gran resistencia
- ▶ Muñeca con tejido elástico
- ▶ Ideal para usos generales



PUÑO TEJIDO



CÓDIGO	COMPOSICIÓN			DISTRIB.	MAYOREO	LISTA
103707	Loneta	12	120	\$25.00	\$36.00	\$44.00

Guantes de loneta con puntos de PVC, unitalla

TARJETA

- ▶ Muñeca con tejido elástico
- ▶ Puntos de PVC
- ▶ Ideal para manipular vidrios



PUÑO TEJIDO



CÓDIGO	COMPOSICIÓN			DISTRIB.	MAYOREO	LISTA
103706	Algodón, poliéster y PVC	12	120	\$24.00	\$34.00	\$42.00

Guantes de algodón (tipo japonés, unitalla)

TARJETA

- ▶ Diseño ajustable y sin costuras
- ▶ Algodón 100%
- ▶ Tejido elástico en muñeca
- ▶ Ideal para usos ligeros



PUÑO AJUSTADO



CÓDIGO	COMPOSICIÓN			DISTRIB.	MAYOREO	LISTA
103712	Algodón	6	60	\$15.00	\$21.40	\$26.00

Guantes de algodón con puntos PVC, unitalla

TARJETA

- ▶ Muñeca con tejido elástico, palma y dorso con puntos de PVC
- ▶ Ideal para manipular tablaroca
- ▶ Ambidiestro



PUÑO TEJIDO



AKSI

CÓDIGO	COMPOSICIÓN	6	60	DISTRIB.	MAYOREO	LISTA
103705	Algodón, poliéster y PVC			\$18.00	\$26.00	\$32.00

Guantes de algodón recubiertos con hule, unitalla

TARJETA

- ▶ Palma antiderrapante
- ▶ Ideal para manipular materiales en carga y descarga



PUÑO TEJIDO



AKSI

CÓDIGO	COMPOSICIÓN	6	60	DISTRIB.	MAYOREO	LISTA
103713	Hule y algodón			\$35.00	\$50.00	\$62.00

Guantes elásticos recubiertos de látex, unitalla

TARJETA

- ▶ Guantes recubiertos de látex
- ▶ Guante de poliéster
- ▶ Ideal para uso ligero



PUÑO TEJIDO



MAXTOOL

CÓDIGO	TAMAÑO	12	120	DISTRIB.	MAYOREO	LISTA
307901	Unitalla			\$35.00	\$50.00	\$62.00

Guantes elásticos recubiertos con Nitrilo

TARJETA

- ▶ Guantes recubiertos con nitrilo
- ▶ Ideal para superficies aceitosas, húmedas y secas
- ▶ Guante de Nylon®



PUÑO TEJIDO



AKSI

CÓDIGO	TAMAÑO	12	120	DISTRIB.	MAYOREO	LISTA
103714	Chica			\$23.00	\$33.00	\$41.00
103715	Mediana			\$23.00	\$33.00	\$41.00
103716	Grande			\$23.00	\$33.00	\$41.00

Guantes de látex (uso industrial)

BOLSA

- ▶ Ideal para trabajos generales y uso rudo
- ▶ Guantes con mayor resistencia y máxima flexibilidad
- ▶ Orilla con refuerzo ribeteado para mayor resistencia al uso
- ▶ Textura antiderrapante para mejorar la sujeción
- ▶ Forro afelpado



HECHO EN MÉXICO



AKSI

CÓDIGO	TAMAÑO	10	100	DISTRIB.	MAYOREO	LISTA
108613	Mediano			\$50.00	\$71.00	\$88.00
108614	Grande			\$50.00	\$71.00	\$88.00

Guantes de textil y puño de seguridad recubiertos con Nitrilo, unitalla

TARJETA

- ▶ Uso para manipulación de tuberías engrasadas
- ▶ Resistente a contacto directo con grasa, aceite y solvente
- ▶ Puño de seguridad



AKSI

CÓDIGO	COMPOSICIÓN	12	120	DISTRIB.	MAYOREO	LISTA
103719	Algodón			\$45.00	\$64.00	\$79.00

Guantes de textil y puño tejido recubiertos con Nitrilo, unitalla

TARJETA

- ▶ Usos en procesos húmedos o secos
- ▶ Resistente a contacto directo con grasa, aceite y solvente



PUÑO TEJIDO



AKSI

CÓDIGO	COMPOSICIÓN	12	120	DISTRIB.	MAYOREO	LISTA
103720	Algodón			\$40.00	\$57.00	\$71.00

Guantes de látex extra largos (uso industrial)

BOLSA

- ▶ Resistente a los ácidos
- ▶ Inerte a los álcalis (sustancias cáusticas)
- ▶ Guantes con mayor resistencia y flexibilidad
- ▶ Textura antiderrapante para mejorar la sujeción
- ▶ Diseño anatómico
- ▶ Mayor duración



HECHO EN MÉXICO



AKSI

CÓDIGO	TAMAÑO	6	36	DISTRIB.	MAYOREO	LISTA
108617	Mediano			\$85.00	\$121.00	\$150.00
108618	Grande			\$85.00	\$121.00	\$150.00

Guante de microfibra

FAJILLA

- ▶ Alta capacidad de absorción
- ▶ Ideal para detallar tu auto o para uso en el hogar en superficies sensibles
- ▶ No deja rayones ni pelusa
- ▶ Fácil de lavar



AKSI

CÓDIGO	TAMAÑO	24	DISTRIB.	MAYOREO	LISTA
125307	21 x 27 cm		\$60.00	\$86.00	\$106.00

Gato hidráulico de patín diseño compacto, 2 toneladas

CAJA

- ▶ Capacidad de carga 2 toneladas
- ▶ Uso en Pick Up y SUV, no apto en autos compactos
- ▶ Tornillo de aproximación que ayuda a llegar rápidamente al chasis
- ▶ Fabricado en acero
- ▶ Rango de levantamiento de 19 cm a 50 cm



ESPECIFICACIONES	
Peso neto:	10.5 kg
Longitud:	355 mm
Altura máxima:	499 mm
Altura mínima:	191 mm



CÓDIGO	CARGA	CAJA	DISTRIB.	MAYOREO	LISTA
118801	2 Toneladas	1	\$1,000.00	\$1,430.00	\$1,765.00

Gato patín de 40 movimientos, 2.5 toneladas

PROX.

MALETÍN

- ▶ Capacidad de carga 2.5 toneladas
- ▶ Uso en Pick Up, SUV y autos compactos
- ▶ Fabricado en acero
- ▶ Rango de levantamiento de 13 cm a 37 cm



ESPECIFICACIONES	
Peso neto:	10.5 kg
Longitud:	490 mm
Altura máxima:	355 mm
Altura mínima:	125 mm



CÓDIGO	CARGA	CAJA	DISTRIB.	MAYOREO	LISTA
118802	2 Toneladas	1	\$870.00	\$1,245.00	\$1,535.00

Gato hidráulico de patín, 1.5 toneladas

CAJA

- ▶ Capacidad de carga 1.5 toneladas
- ▶ Uso en autos compactos



ESPECIFICACIONES	
Peso neto:	6.366 Kg
Longitud:	415 mm
Altura máxima:	316.28 mm
Altura mínima:	131.64 mm



CÓDIGO	CARGA	CAJA	DISTRIB.	MAYOREO	LISTA
306201	1.5 Toneladas	1	\$550.00	\$785.00	\$970.00

Guía de nylon para cable

PROX.

BOLSA

- ▶ Guía fabricada en Nylon® y cable de acero galvanizado
- ▶ Puntas tiradora y buscadora de latón
- ▶ Para jalar cables en ductos de instalación



CÓDIGO	LONGITUD	CAJA	DISTRIB.	MAYOREO	LISTA
128811	10 m	3 24	\$41.00	\$59.00	\$72.00
128812	15 m	3 24	\$48.00	\$69.00	\$85.00
128813	20 m	2 24	\$60.00	\$86.00	\$106.00
128814	30 m	2 24	\$76.00	\$109.00	\$134.00

*Nylon® es una marca registrada

Guía de acero para cable

TARJETA

- ▶ Fabricada en acero al alto carbono
- ▶ Cuerpo de polipropileno, resistente al impacto
- ▶ Mango ergonómico
- ▶ Para jalar cables eléctricos en ductos de instalación



CÓDIGO	LONGITUD	CAJA	DISTRIB.	MAYOREO	LISTA
128801	15 m	3 6	\$225.00	\$320.00	\$395.00
128802	30 m	3 6	\$335.00	\$480.00	\$590.00

Hacha cazadora

GRANEL

- ▶ Cabeza forjada en acero 1045 con doble tratamiento térmico
- ▶ Mango de madera



* 109304 MANGO

CÓDIGO	PESO	CAJA	DISTRIB.	MAYOREO	LISTA
113113	1 1/4 Lbs	4 24	\$135.00	\$195.00	\$240.00
109304	N/A	1	\$78.00	\$111.00	\$138.00

Hilo tipo cruceta para desbrozadora



BLÍSTER

- ▶ Diseño tipo cruceta con 8 aristas para un corte fino y suave
- ▶ Alto desempeño



107311 107312 107313 107314 107315 107316



CÓDIGO	DIÁMETRO	LARGO	CAJA	DISTRIB.	MAYOREO	LISTA
107311	1.6 mm / 0,062"	15 m	12 72	\$16.00	\$22.90	\$28.00
107312	2 mm / 0,080"	15 m	12 72	\$19.00	\$27.00	\$34.00
107313	2.4 mm / 0,095"	12 m	12 72	\$20.00	\$29.00	\$35.00
107314	2.7 mm / 0,105"	12 m	12 72	\$23.00	\$33.00	\$41.00
107315	3.3 mm / 0,130"	12 m	12 72	\$25.00	\$36.00	\$44.00
107316	3.7 mm / 0,145"	12 m	12 72	\$28.00	\$40.00	\$49.00

Hilo redondo para desbrozadora



BLÍSTER

- ▶ Alta resistencia al impacto en superficies duras
- ▶ Para todo tipo de desbrozadoras que utilicen hilo de Nylon®



107301 107302 107303 107304

*Nylon® es una marca registrada

CÓDIGO	DIÁMETRO	LARGO	CAJA	DISTRIB.	MAYOREO	LISTA
107301	1.6 mm / 0,062"	15 m	12 72	\$11.00	\$15.70	\$19.40
107302	2 mm / 0,080"	15 m	12 72	\$13.00	\$18.60	\$22.90
107303	2.4 mm / 0,095"	12 m	12 72	\$14.00	\$20.00	\$24.70
107304	2.7 mm / 0,105"	12 m	12 72	\$17.00	\$24.30	\$30.00

Hilo para albañil

GRANEL

- ▶ 100% polipropileno
- ▶ Resiste más de 13 kg de tensión
- ▶ No se oxida ni se pudre como los hilos comunes de algodón
- ▶ Calibre 18



CÓDIGO	LARGO			DISTRIB.	MAYOREO	LISTA
105701	165 m	12	72	\$17.00	\$24.30	\$30.00
105702	65 m	12	72	\$9.00	\$12.90	\$15.90

Hilo para albañil

GRANEL

- ▶ 100% polipropileno
- ▶ Resiste más de 13 kg de tensión
- ▶ No se oxida ni se pudre como los hilos comunes de algodón
- ▶ Calibre 18



CÓDIGO	LARGO	COLORES		DISTRIB.	MAYOREO	LISTA
304401	165 m	Blanco	189	\$17.00	\$24.30	\$30.00
304402	65 m	Blanco	336	\$9.00	\$12.90	\$15.90
304421	65 m	Amarillo	336	\$9.00	\$12.90	\$15.90
304422	65 m	Rojo	336	\$9.00	\$12.90	\$15.90
304423	65 m	Azul	336	\$9.00	\$12.90	\$15.90
304424	65 m	Verde	336	\$9.00	\$12.90	\$15.90

Impermeabilizante acrílico fibratado blanco

CUBETA

- ▶ Adherencia a materiales para construcción con excelente anclaje
- ▶ Formulados con resinas acrílicas estirenadas base agua y alto contenido de fibras que forman una capa protectora
- ▶ Rendimiento x capa: 0.5 - 0.75 L x m²



CÓDIGO	COLOR	PRESENTACIÓN	GARANTÍA		DISTRIB.	MAYOREO	LISTA
118406	Blanco	Galón 3.8 L	5 Años	4	\$270.00	\$385.00	\$475.00
118407	Blanco	Cubeta 19 L	5 Años	N/A	\$990.00	\$1,415.00	\$1,745.00

*El rendimiento puede variar dependiendo de la rugosidad de la superficie.

Impermeabilizante acrílico fibratado rojo

CUBETA

- ▶ Adherencia a materiales para construcción con excelente anclaje
- ▶ Formulados con resinas acrílicas estirenadas base agua y alto contenido de fibras que forman una capa protectora
- ▶ Rendimiento x capa: 0.5 - 0.75 L x m²



CÓDIGO	COLOR	PRESENTACIÓN	GARANTÍA		DISTRIB.	MAYOREO	LISTA
118416	Rojo	Galón 3.8 L	5 Años	4	\$270.00	\$385.00	\$475.00
118417	Rojo	Cubeta 19 L	5 Años	N/A	\$990.00	\$1,415.00	\$1,745.00

*El rendimiento puede variar dependiendo de la rugosidad de la superficie.

Impermeabilizante de llanta, rojo

CUBETA

- ▶ Elaborado con resinas acrílicas, reforzado con partículas de caucho vulcanizado reciclado
- ▶ Gran capacidad impermeable y resistencia al intemperismo
- ▶ Ideal sobre losas de concreto y superficies porosas
- ▶ Rendimiento x capa: 0.5 - 0.75 L x m²



CÓDIGO	CONT.	GARANTÍA	DISTRIB.	MAYOREO	LISTA
118461	19 L	5 Años	\$1,500.00	\$2,145.00	\$2,645.00

AKSIBOND Adhesivo acrílico

LATA

- ▶ Adhesivo concentrado fabricado para unir concreto nuevo a viejo no estructural por contacto de las superficies
- ▶ Proporciona máxima resistencia y adherencia



CÓDIGO	CONTENIDO		DISTRIB.	MAYOREO	LISTA
118471	1 L	18	\$160.00	\$230.00	\$280.00

Tapa goteras

GALÓN

- ▶ Sellador asfáltico que se adhiere sobre superficies de concreto húmedas para reparaciones urgentes



CÓDIGO	CONTENIDO		DISTRIB.	MAYOREO	LISTA
118472	4 L	4	\$360.00	\$515.00	\$635.00

Malla de refuerzo sencilla o reforzada

BOLSA

- ▶ Membrana no tejida de filamentos sintéticos
- ▶ Ideal para reforzar el desempeño en áreas críticas en el sistema de impermeabilización acrílico tradicional



CÓDIGO	MALLA	PRESENTACIÓN	DISTRIB.	MAYOREO	LISTA
118441	Sencilla	Rollo 100 m x 1.10 m	\$560.00	\$800.00	\$990.00
118442	Sencilla	Bolsa 20 m x 1.10 m	\$150.00	\$215.00	\$265.00
118451	Reforzada	Rollo 100 m x 1.10 m	\$1,585.00	\$2,265.00	\$2,795.00
118452	Reforzada	Bolsa 10 m x 1.10 m	\$195.00	\$280.00	\$345.00

Cepillo para impermeabilizar de 7 x 19 pinceles

GRANEL

- ▶ Cerdas 100% fibra natural
- ▶ Cabeza plástica súper durable
- ▶ Disponible con mango de madera pulida o cabeza sola



CÓDIGO	MODELO		DISTRIB.	MAYOREO	LISTA
109811	Sin mango	32	\$62.00	\$89.00	\$109.00
109812	Con mango	12	\$82.00	\$117.00	\$145.00
109308	Mango	12	\$22.00	\$31.00	\$39.00

Cal

BOLSA

- ▶ Presentación en bolsa de 1.5 kg
- ▶ Para encalado y combate de plagas
- ▶ Desinfección de abonos orgánicos
- ▶ Estabilización de suelos agrícolas, tratamiento de pozos sépticos y alcantarillas
- ▶ Fácil aplicación



CÓDIGO		CONTENIDO	DISTRIB.	MAYOREO	LISTA
119805	4	1.5 kg	\$22.00	\$31.00	\$39.00

Cemento gris

BOLSA

- ▶ Presentación en bolsas de 1.5 kg
- ▶ Ideal para construcción de elementos o estructuras de concreto simple o armado
- ▶ Para uso residencial y comercial
- ▶ Óptima durabilidad
- ▶ Puede adicionarse arena y grava para obtener la trabajabilidad deseada
- ▶ Tiempo de curado: 7 días



CÓDIGO		CONTENIDO	DISTRIB.	MAYOREO	LISTA
119801	4	1.5 kg	\$25.00	\$36.00	\$44.00

Cemento blanco

BOLSA

- ▶ Presentación en bolsas de 1.5 kg
- ▶ Ideal para acabados finos en pisos y muros
- ▶ Excelente para emboquillados y juntas de azulejo, aplicación de tirol o base para cementos de color
- ▶ Para uso estructural y arquitectónico



CÓDIGO		CONTENIDO	DISTRIB.	MAYOREO	LISTA
119802	4	1.5 kg	\$32.00	\$46.00	\$56.00

Yeso

BOLSA

- ▶ Presentación en bolsa de 1.5 kg
- ▶ Ideal para dar acabado fino y enlucido de muros y losas
- ▶ Para acabados lisos y firmes
- ▶ Excelente para manualidades
- ▶ Fácil aplicación
- ▶ Tiempo de fraguado: 60 min.



CÓDIGO		CONTENIDO	DISTRIB.	MAYOREO	LISTA
119804	4	1.5 kg	\$20.00	\$29.00	\$35.00

Inyectores de grasa, 14 oz

PROX.

CAJA

- ▶ Cilindro de acero con cabeza de aluminio
- ▶ Mango con cubierta antiderrapante para un mejor agarre
- ▶ Palanca de recorrido corto, facilita el uso en espacios estrechos
- ▶ Para lubricación de maquinaria industrial y automotriz



8 000 psi

CÓDIGO			DISTRIB.	MAYOREO	LISTA
131602	2	16	\$200.00	\$285.00	\$355.00

10 000 psi

CÓDIGO			DISTRIB.	MAYOREO	LISTA
131603	2	16	\$240.00	\$345.00	\$425.00

AKSI

Inyector de grasa mini, 3 oz

PROX.

BLÍSTER

- ▶ Cilindro de acero
- ▶ Extensión rígida
- ▶ Sistemas de carga con cartucho y granel
- ▶ Posiciones de salida frontal y superior

INCLUYE CARTUCHO DE GRASA DE 85g



CÓDIGO			DISTRIB.	MAYOREO	LISTA
131601	4	16	\$180.00	\$255.00	\$320.00

AKSI

Boquilla flexible con válvula check para inyectores de grasa

PROX.

BLÍSTER

- ▶ Manguera de 3 capas: nylon, poliéster y poliuretano
- ▶ Largo: 2"
- ▶ 10 000 psi
- ▶ 1/8"-27 NPT



CÓDIGO			DISTRIB.	MAYOREO	LISTA
131621	6	72	\$45.00	\$64.00	\$79.00

AKSI

Válvula check para inyectores de grasa

PROX.

BLÍSTER

- ▶ Cuerpo fabricado en acero



CÓDIGO			DISTRIB.	MAYOREO	LISTA
131622	10	80	\$23.00	\$33.00	\$41.00

AKSI

Tuercas para inyectores de grasa

PROX.

BLÍSTER

- ▶ Cuerpo de latón
- ▶ Juego de 2 piezas



CÓDIGO			DISTRIB.	MAYOREO	LISTA
131623	20	80	\$13.00	\$18.60	\$22.90

AKSI

Aceite mineral para motor de 2 tiempos

BOTE DE PLÁSTICO

- ▶ Alta resistencia a la oxidación
- ▶ Alarga hasta el 80% la vida del motor
- ▶ Ideal para podadoras, desbrozadoras, motocicletas, motosierras



AKSI

CÓDIGO	CONTENIDO		DISTRIB.	MAYOREO	LISTA
119581	120 ml	24	\$21.00	\$30.00	\$37.00
119583	250 ml	24	\$33.00	\$47.00	\$58.00



Grasa multiuso 450 g

BOTE DE PLÁSTICO

- ▶ Gran adhesividad y estabilidad mecánica
- ▶ Para chasis, baleros, equipo agrícola, industrial y de construcción



AKSI

CÓDIGO	CONTENIDO		DISTRIB.	MAYOREO	LISTA
119591	450 g	12	\$80.00	\$114.00	\$141.00

Complementos



HERRAMIENTA PROFESIONAL



nuevas formas
de ILUMINACIÓN



LABORATORIO
360°



FOCO AHORRADOR

CLASSIC LINE



CLASSIC LINE



CLASSIC LINE



2



Años de garantía Base E27

2



Años de garantía Base E27

2



Años de garantía Base E27

BARRA 2U

CONSUME 9 W

ILUMINA 35 W



127 V~



T3 Tubo



4 x 15.5 cm



Caja

430 LUMENS

BLANCA | 6 500 K

CÓDIGO			DISTRIB.	MAYOREO	LISTA
110460	25	50	\$21.00	\$30.00	\$37.00

CONSUME 15 W

ILUMINA 65 W



127 V~



T4 Tubo



4 x 17 cm



Caja

850 LUMENS

BLANCA | 6 500 K

CÓDIGO			DISTRIB.	MAYOREO	LISTA
110606	6	36	\$23.00	\$33.00	\$41.00

CUMPLE CON LOS PARÁMETROS DE LA NOM-017-ENER/SCFI-2012 **NOM**

BARRA 3U

CONSUME 20 W

ILUMINA 75 W



127 V~



T3 Tubo



4.4 x 15cm



Caja

1150 LUMENS

BLANCA | 6 500 K

CÓDIGO			DISTRIB.	MAYOREO	LISTA
110616	6	36	\$29.00	\$41.00	\$51.00

CUMPLE CON LOS PARÁMETROS DE LA NOM-017-ENER/SCFI-2012 **NOM**

BARRA 4U

CONSUME 28 W

ILUMINA 110 W



127 V~



T4 Tubo



5.7 x 18 cm



Caja

1800 LUMENS

BLANCA | 6 500 K

CÓDIGO			DISTRIB.	MAYOREO	LISTA
110622	6	36	\$43.00	\$61.00	\$76.00

CUMPLE CON LOS PARÁMETROS DE LA NOM-017-ENER/SCFI-2012 **NOM**



CLASSIC LINE



2

Años de garantía



BASE E27

CLASSIC LINE



2

Años de garantía



BASE E27

CLASSIC LINE



2

Años de garantía



BASE E27

ESPIRAL

CONSUME **23 W**

ILUMINA **100 W**



127 V ~

T2

Tubo



6 x 10.8 cm



Caja

1540
LUMENS

BLANCA | 6 500 K

CÓDIGO	16	64	DISTRIB.	MAYOREO	LISTA
110647			\$35.00	\$50.00	\$62.00

CUMPLE CON LOS PARÁMETROS DE LA NOM-017-ENER/SCFI-2012



ESPIRAL, individual ó 3 pack

CONSUME **23 W**

ILUMINA **90 W**



127 V ~

T3

Tubo



5.5 x 13.5 cm



Caja

1380
LUMENS

BLANCA | 6 500 K

Individual

CÓDIGO	10	50	DISTRIB.	MAYOREO	LISTA
110464			\$30.00	\$43.00	\$53.00

3 Pack

CÓDIGO	12 packs	DISTRIB.	MAYOREO	LISTA
110983		\$85.00	\$121.00	\$150.00

CUMPLE CON LOS PARÁMETROS DE LA NOM-017-ENER/SCFI-2012



ESPIRAL

CONSUME **30 W**

ILUMINA **110 W**



127 V ~

T3

Tubo



6 x 15 cm



Caja

1800
LUMENS

BLANCA | 6 500 K

CÓDIGO	10	50	DISTRIB.	MAYOREO	LISTA
110466			\$40.00	\$57.00	\$71.00

CUMPLE CON LOS PARÁMETROS DE LA NOM-017-ENER/SCFI-2012





CLASSIC LINE

CLASSIC LINE

CLASSIC LINE



2



Años de garantía

BASE E27

2



Años de garantía

BASE E27

2



Años de garantía

BASE E27

MINI ESPIRAL

MINI ESPIRAL

MINI ESPIRAL

CONSUME 9 W

ILUMINA 45 W

CONSUME 13 W

ILUMINA 60 W

CONSUME 15 W

ILUMINA 60 W



127 V ~



T2
Tubo



4.5 x 8.8 cm



Caja



127 V ~



T2
Tubo



5 x 9.4 cm



Caja



127 V ~



T3
Tubo



4.5 x 12.2 cm



Caja

550 LUMENS

BLANCA | 6 500 K

830 LUMENS

BLANCA | 6 500 K

800 LUMENS

BLANCA | 6 500 K

CÓDIGO			DISTRIB.	MAYOREO	LISTA
110635	20	100	\$28.00	\$40.00	\$49.00

CÓDIGO			DISTRIB.	MAYOREO	LISTA
110639	20	100	\$30.00	\$43.00	\$53.00

CÓDIGO			DISTRIB.	MAYOREO	LISTA
110462	25	50	\$25.00	\$36.00	\$44.00

CUMPLE CON LOS PARÁMETROS DE LA NOM-017-ENER/SCFI-2012 **NOM**

CUMPLE CON LOS PARÁMETROS DE LA NOM-017-ENER/SCFI-2012 **NOM**

CUMPLE CON LOS PARÁMETROS DE LA NOM-017-ENER/SCFI-2012 **NOM**



CLASSIC LINE

SUPER COMPACT



2



Años de garantía

BASE E27

2



Años de garantía

BASE E27

ESPIRAL Alta Potencia

ESPIRAL Alta Potencia

CONSUME 30 W

ILUMINA 120 W

CONSUME 45 W

ILUMINA 180 W



127 V ~

T4

Tubo



5.3 x 15.7 cm



Caja



127 V ~

T4

Tubo



6.5 x 16.6 cm



Caja

1950 LUMENS

BLANCA | 6 500 K

2800 LUMENS

BLANCA | 6 500 K

CÓDIGO



DISTRIB.

MAYOREO

LISTA

110685

16

64

\$42.00

\$60.00

\$74.00

CÓDIGO



DISTRIB.

MAYOREO

LISTA

110687

2

12

\$70.00

\$100.00

\$123.00

CUMPLE CON LOS PARÁMETROS DE LA NOM-017-ENER/SCFI-2012



CUMPLE CON LOS PARÁMETROS DE LA NOM-017-ENER/SCFI-2012





NAVES INDUSTRIALES



2

Años de garantía



BASE E27

NAVES INDUSTRIALES



2

Años de garantía



BASE E27



BASE E39

ESPIRAL Alta Potencia

CONSUME 65 W

ILUMINA 250 W



127V~

T4

Tubo



7 x 20.6 cm



Caja

4000 LUMENS

BLANCA | 6 500 K

CÓDIGO			DISTRIB.	MAYOREO	LISTA
110691	2	12	\$90.00	\$129.00	\$160.00

CUMPLE CON LOS PARÁMETROS DE LA NOM-017-ENER/SCFI-2012



ESPIRAL Alta Potencia

CONSUME 85 W

ILUMINA 300 W



127V~ 220V~

T5

Tubo



7.5 x 27.5 cm - cód. 110693
7.5 x 28 cm - cód. 110694



Caja

4700 LUMENS

BLANCA | 6 500 K

CÓDIGO	BASE			DISTRIB.	MAYOREO	LISTA
110693	E27	2	6	\$140.00	\$200.00	\$245.00

CÓDIGO	BASE			DISTRIB.	MAYOREO	LISTA
110694	E39	2	6	\$145.00	\$205.00	\$255.00

CUMPLE CON LOS PARÁMETROS DE LA NOM-017-ENER/SCFI-2012





FLUORESCENTE



1
Año de garantía

BASE E27

INCLUYE FOTOCELDA

LED



1
Año de garantía

BASE E27

INCLUYE FOTOCELDA

110691
Pág. 136

116421
Pág. 156

116401
Pág. 158

116402
Pág. 158

LUMINARIO SUBURBANO IP65



BLANCA | 6 500 K

117801 - No incluye foco

Ideal para focos:

LUMINARIO SIN FOCO 45 W, 65 W, 85 W

117803 - Incluye foco ahorrador de 65 W

CONSUME 65 W ILUMINA 250 W
4000 LUMENS 7 x 20.6 cm

- Difusor de policarbonato, más resistente a la intemperie
- Soporta una corriente de hasta 1300 mA

CÓDIGO	CARACTERÍSTICAS	DISTRIB.	MAYOREO	LISTA
117801	Sin foco	1	\$540.00	\$770.00 \$955.00
117803	Foco de 65 W	1	\$590.00	\$845.00 \$1,040.00

CUMPLE CON LOS PARÁMETROS DE LA NOM-003-SCFI-2014 (luminario suburbano) CUMPLE CON LOS PARÁMETROS DE LA NOM-017-ENER/SCFI-2012 (foco incluido) **NOM**

LUMINARIO SUBURBANO IP65



BLANCA | 6 500 K

117801 - No incluye foco

Ideal para focos:

LUMINARIO SIN FOCO 20 W, 35 W, 45 W

117821 - Incluye foco tipo T de 20 W

CONSUME 20 W ILUMINA 125 W
1800 LUMENS 8 x 1.5 cm

117811 - Incluye foco de 35 W

CONSUME 35 W ILUMINA 200 W
2900 LUMENS 12.7 x 22.5 cm

117812 - Incluye foco de 45 W

CONSUME 45 W ILUMINA 225 W
3500 LUMENS 12.7 x 25 cm

- Difusor de policarbonato, más resistente a la intemperie
- Soporta una corriente de hasta 1300 mA

CÓDIGO	CARACTERÍSTICAS	DISTRIB.	MAYOREO	LISTA
117821	Foco LED 20 W	1	\$560.00	\$800.00 \$990.00
117811	Foco LED 35 W	1	\$760.00	\$1,085.00 \$1,340.00
117812	Foco LED 45 W	1	\$800.00	\$1,145.00 \$1,410.00

CUMPLE CON LOS PARÁMETROS DE LA NOM-003-SCFI-2014 (luminario suburbano) CUMPLE CON LOS PARÁMETROS DE LA NOM-030-ENER-2016 (foco incluido) **NOM**

LED



16.6 cm

5

Años de garantía



INCLUYE FOTOCELDA

LED



5

Años de garantía

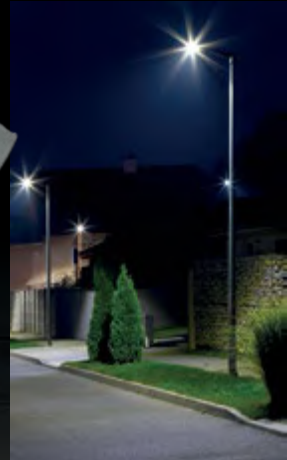

LUMINARIO SUBURBANO IP65



CONSUME 35 W Medida máxima A 27 cm
3850 LUMENS

- Luminario fabricado en aluminio para mayor enfriamiento y mayor tiempo de vida
- Driver integrado
- Ángulo de detección de 120°

BLANCA | 6 500 K

CÓDIGO	CARACTERÍSTICAS	DISTRIB.	MAYOREO	LISTA	
117831	LED Incluido	1	\$900.00	\$1,285.00	\$1,590.00

CUMPLE CON LOS PARÁMETROS DE LA NOM-031-ENER-2012 **NOM**

NUEVO
LUMINARIO SUBURBANO PLANO IP65

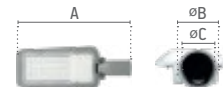

CONSUME 50 W A 40 cm øB 5.9 cm øC 5.0 cm
5000 LUMENS

CONSUME 100 W A 50 cm øB 6.9 cm øC 6.0 cm
10 000 LUMENS

BLANCA | 6 500 K

CÓDIGO	CARACTERÍSTICAS	DISTRIB.	MAYOREO	LISTA	
117841	50 W	12	\$350.00	\$500.00	\$615.00
117842	100 W	8	\$600.00	\$855.00	\$1,060.00

CUMPLE CON LOS PARÁMETROS DE LA NOM-031-ENER-2012 **NOM**

ILUMINACIÓN LED





Lighting



PACKS DE 2, 3, 4, 6 Y 10 FOCOS

MultiPack

2 PACK

3 PACK

6 PACK

10 PACK



3



Años de garantía BASE E27

MultiPack

3 PACK

6 PACK

10 PACK



3



Años de garantía BASE E27

ECO A19 LED

CONSUME 5 W ILUMINA 40 W

Comparación vs lámparas incandescentes



410 LUMENS BLANCA | 6 500 K

CÓDIGO	PACK DE:	DISTRIB.	MAYOREO	LISTA
129001	2	12	\$17.00	\$24.30
129002	3	12	\$24.00	\$34.00
129004	6	6	\$45.00	\$64.00
129006	10	6	\$70.00	\$100.00

ECO A19 LED

CONSUME 7 W ILUMINA 40 W

Comparación vs lámparas incandescentes



500 LUMENS BLANCA | 6 500 K

CÓDIGO	PACK DE:	DISTRIB.	MAYOREO	LISTA
129012	3	12	\$30.00	\$43.00
129014	6	6	\$50.00	\$71.00
129016	10	6	\$80.00	\$114.00

CUMPLE CON LOS PARÁMETROS DE LA NOM-030-ENER-2016 **NOM**

CUMPLE CON LOS PARÁMETROS DE LA NOM-030-ENER-2016 **NOM**



3
Años de garantía
BASE E27

3
Años de garantía
BASE E27

3
Años de garantía
BASE E27

ECO A19 LED

ECO A19 LED

ECO A19 LED

CONSUME 9 W **ILUMINA 60 W**

Comparación vs lámparas incandescentes



CONSUME 12 W **ILUMINA 75 W**

Comparación vs lámparas incandescentes



CONSUME 15 W **ILUMINA 100 W**

Comparación vs lámparas incandescentes



730 LUMENS **BLANCA | 6 500 K**

930 LUMENS **BLANCA | 6 500 K**

1330 LUMENS **BLANCA | 6 500 K**

CÓDIGO	PACK DE:	DISTRIB.	MAYOREO	LISTA	
129021	2	18	\$20.00	\$29.00	\$35.00
129023	4	12	\$35.00	\$50.00	\$62.00
129024	6	6	\$55.00	\$79.00	\$97.00
129026	10	10	\$85.00	\$121.00	\$150.00

CÓDIGO	PACK DE:	DISTRIB.	MAYOREO	LISTA	
129032	3	12	\$35.00	\$50.00	\$62.00
129034	6	6	\$65.00	\$93.00	\$115.00

CÓDIGO	PACK DE:	DISTRIB.	MAYOREO	LISTA	
129041	2	12	\$30.00	\$43.00	\$53.00
129043	4	9	\$55.00	\$79.00	\$97.00
129044	6	6	\$80.00	\$114.00	\$141.00

CUMPLE CON LOS PARÁMETROS DE LA NOM-030-ENER-2016 **NOM**

CUMPLE CON LOS PARÁMETROS DE LA NOM-030-ENER-2016 **NOM**

CUMPLE CON LOS PARÁMETROS DE LA NOM-030-ENER-2016 **NOM**



CLASSIC LINE



3

Años de garantía



BASE E27

CLASSIC LINE



3

Años de garantía



BASE E27

CLASSIC LINE



3

Años de garantía



BASE E27

A15 LED

CONSUME 4 W

ILUMINA 25 W

Comparación vs lámparas incandescentes



325 LUMENS

BLANCA | 6 500 K

CÓDIGO	10	60	DISTRIB.	MAYOREO	LISTA
120001			\$9.00	\$12.90	\$15.90

310 LUMENS

CÁLIDA | 3 000 K

CÓDIGO	10	60	DISTRIB.	MAYOREO	LISTA
120061			\$9.00	\$12.90	\$15.90

CUMPLE CON LOS PARÁMETROS DE LA NOM-030-ENER-2016



A19 LED

CONSUME 5 W

ILUMINA 40 W

Comparación vs lámparas incandescentes



550 LUMENS

BLANCA | 6 500 K

CÓDIGO	10	40	DISTRIB.	MAYOREO	LISTA
120021			\$10.00	\$14.30	\$17.60

500 LUMENS

CÁLIDA | 3 000 K

CÓDIGO	10	40	DISTRIB.	MAYOREO	LISTA
120071			\$10.00	\$14.30	\$17.60

CUMPLE CON LOS PARÁMETROS DE LA NOM-030-ENER-2016



A19 LED

CONSUME 7 W

ILUMINA 40 W

Comparación vs lámparas incandescentes



700 LUMENS

BLANCA | 6 500 K

CÓDIGO	10	40	DISTRIB.	MAYOREO	LISTA
120023			\$11.00	\$15.70	\$19.40

650 LUMENS

CÁLIDA | 3 000 K

CÓDIGO	10	40	DISTRIB.	MAYOREO	LISTA
120073			\$11.00	\$15.70	\$19.40

CUMPLE CON LOS PARÁMETROS DE LA NOM-030-ENER-2016





CLASSIC LINE



3

Años de garantía



BASE E27

CLASSIC LINE



3

Años de garantía



BASE E27

A19 LED

CONSUME 9 W	ILUMINA 60 W
--------------------	---------------------

Comparación vs lámparas incandescentes

127 V ~	240° omnidireccional	15 000 h de vida	6 x 11 cm	Caja
---------	----------------------	------------------	-----------	------

800 LUMENS	BLANCA 6 500 K
-------------------	-------------------------

CÓDIGO			DISTRIB.	MAYOREO	LISTA
120025	10	40	\$12.00	\$17.10	\$21.20

750 LUMENS	CÁLIDA 3 000 K
-------------------	-------------------------

CÓDIGO			DISTRIB.	MAYOREO	LISTA
120075	10	40	\$12.00	\$17.10	\$21.20

CUMPLE CON LOS PARÁMETROS DE LA NOM-030-ENER-2016 **NOM**

3 PACK A19 LED

CONSUME 9 W	ILUMINA 60 W
--------------------	---------------------

Comparación vs lámparas incandescentes

127 V ~	240° omnidireccional	15 000 h de vida	6 x 11 cm	Caja
---------	----------------------	------------------	-----------	------

800 LUMENS	BLANCA 6 500 K
-------------------	-------------------------

CÓDIGO		DISTRIB.	MAYOREO	LISTA
123001	12	\$30.00	\$43.00	\$53.00

750 LUMENS	CÁLIDA 3 000 K
-------------------	-------------------------

CÓDIGO		DISTRIB.	MAYOREO	LISTA
123002	12	\$30.00	\$43.00	\$53.00

CUMPLE CON LOS PARÁMETROS DE LA NOM-030-ENER-2016 **NOM**



CLASSIC LINE



CLASSIC LINE



CLASSIC LINE



3



Años de garantía

BASE E27

3



Años de garantía

BASE E27

3



Años de garantía

BASE E27

A19 LED

CONSUME 12 W

ILUMINA 75 W

Comparación vs lámparas incandescentes



1100 LUMENS

BLANCA | 6 500 K

CÓDIGO	10	40	DISTRIB.	MAYOREO	LISTA
120027			\$14.00	\$20.00	\$24.70

1050 LUMENS

CÁLIDA | 3 000 K

CÓDIGO	10	40	DISTRIB.	MAYOREO	LISTA
120077			\$14.00	\$20.00	\$24.70

CUMPLE CON LOS PARÁMETROS DE LA NOM-030-ENER-2016



A19 LED

CONSUME 15 W

ILUMINA 100 W

Comparación vs lámparas incandescentes



1550 LUMENS

BLANCA | 6 500 K

CÓDIGO	10	40	DISTRIB.	MAYOREO	LISTA
120029			\$17.00	\$24.30	\$30.00

1500 LUMENS

CÁLIDA | 3 000 K

CÓDIGO	10	40	DISTRIB.	MAYOREO	LISTA
120079			\$17.00	\$24.30	\$30.00

CUMPLE CON LOS PARÁMETROS DE LA NOM-030-ENER-2016



A20 LED

CONSUME 20 W

ILUMINA 125 W

Comparación vs lámparas incandescentes



1850 LUMENS

BLANCA | 6 500 K

CÓDIGO	6	24	DISTRIB.	MAYOREO	LISTA
120031			\$25.00	\$36.00	\$44.00

1800 LUMENS

CÁLIDA | 3 000 K

CÓDIGO	6	24	DISTRIB.	MAYOREO	LISTA
120081			\$25.00	\$36.00	\$44.00

CUMPLE CON LOS PARÁMETROS DE LA NOM-030-ENER-2016





DIAMOND LINE



3



Años de garantía

BASE E27

DIAMOND LINE



3



Años de garantía

BASE E27

DIAMOND LINE



3



Años de garantía

BASE E27

A19 LED filamentos

CONSUME 4 W

ILUMINA 40 W

Comparación vs lámparas incandescentes



455 LUMENS

BLANCA | 6 500 K

CÓDIGO	6	24	DISTRIB.	MAYOREO	LISTA
115591			\$22.00	\$31.00	\$39.00

420 LUMENS

CÁLIDA | 2 700 K

CÓDIGO	6	24	DISTRIB.	MAYOREO	LISTA
115592			\$22.00	\$31.00	\$39.00

CUMPLE CON LOS PARÁMETROS DE LA NOM-030-ENER-2016



A19 LED filamentos

CONSUME 6 W

ILUMINA 40 W

Comparación vs lámparas incandescentes



680 LUMENS

BLANCA | 6 500 K

CÓDIGO	6	24	DISTRIB.	MAYOREO	LISTA
115593			\$24.00	\$34.00	\$42.00

650 LUMENS

CÁLIDA | 2 700 K

CÓDIGO	6	24	DISTRIB.	MAYOREO	LISTA
115594			\$24.00	\$34.00	\$42.00

CUMPLE CON LOS PARÁMETROS DE LA NOM-030-ENER-2016



A19 LED filamentos

CONSUME 8 W

ILUMINA 60 W

Comparación vs lámparas incandescentes



800 LUMENS

BLANCA | 6 500 K

CÓDIGO	6	24	DISTRIB.	MAYOREO	LISTA
115595			\$26.00	\$37.00	\$46.00

770 LUMENS

CÁLIDA | 2 700 K

CÓDIGO	6	24	DISTRIB.	MAYOREO	LISTA
115596			\$26.00	\$37.00	\$46.00

CUMPLE CON LOS PARÁMETROS DE LA NOM-030-ENER-2016





DIAMOND LINE



3



Años de garantía

BASE E27

DIAMOND LINE



3



Años de garantía

BASE E27

PROX. ● A19 LED filamentos

CONSUME 12 W

ILUMINA 75 W

Comparación vs lámparas incandescentes



127 V ~



360° omnidireccional



15 000 h de vida



6 x 11.5 cm



Caja

1100 LUMENS

BLANCA | 6 500 K

CÓDIGO			DISTRIB.	MAYOREO	LISTA
115597	6	24	\$35.00	\$50.00	\$62.00

1100 LUMENS

CÁLIDA | 2 700 K

CÓDIGO			DISTRIB.	MAYOREO	LISTA
115598	6	24	\$35.00	\$50.00	\$62.00

CUMPLE CON LOS PARÁMETROS DE LA NOM-030-ENER-2016



PROX. ● A19 LED filamentos

CONSUME 15 W

ILUMINA 100 W

Comparación vs lámparas incandescentes



127 V ~



360° omnidireccional



15 000 h de vida



6 x 12.1 cm



Caja

1550 LUMENS

BLANCA | 6 500 K

CÓDIGO			DISTRIB.	MAYOREO	LISTA
115599	6	24	\$40.00	\$57.00	\$71.00

1550 LUMENS

CÁLIDA | 2 700 K

CÓDIGO			DISTRIB.	MAYOREO	LISTA
115600	6	24	\$40.00	\$57.00	\$71.00

CUMPLE CON LOS PARÁMETROS DE LA NOM-030-ENER-2016





BASE PARA SPOT MR16

- Fabricados en acero
- Clips de instalación
- Ideales para lámpara LED AKSI MR16

1
AÑO DE GARANTÍA
+ INFO PÁG. 203



CLASSIC LINE

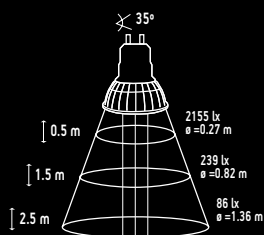

3

Años de garantía



BASE GU5.3

CLASSIC LINE

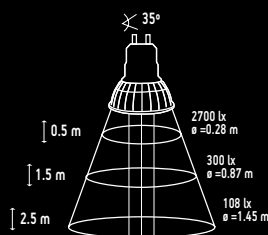

3

Años de garantía



BASE GU5.3

CLASSIC LINE

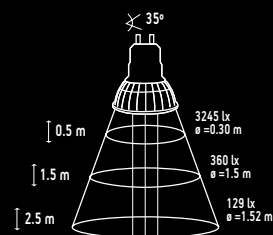

3

Años de garantía



BASE GU5.3

MR16

CONSUME **3 W**

ILUMINA **30 W**

Comparación vs 1 halógeno



NO INCLUYE ADAPTADOR

300
LUMENS

BLANCA | 6 500 K

CÓDIGO	10	60	DISTRIB.	MAYOREO	LISTA
121003			\$14.00	\$20.00	\$24.70

280
LUMENS

CÁLIDA | 3 000 K

CÓDIGO	10	60	DISTRIB.	MAYOREO	LISTA
121033			\$14.00	\$20.00	\$24.70

MR16

CONSUME **5 W**

ILUMINA **40 W**

Comparación vs 1 halógeno



NO INCLUYE ADAPTADOR

450
LUMENS

BLANCA | 6 500 K

CÓDIGO	10	60	DISTRIB.	MAYOREO	LISTA
121013			\$15.00	\$21.40	\$26.00

430
LUMENS

CÁLIDA | 3 000 K

CÓDIGO	10	60	DISTRIB.	MAYOREO	LISTA
121043			\$15.00	\$21.40	\$26.00

MR16

CONSUME **7 W**

ILUMINA **55 W**

Comparación vs 1 halógeno



NO INCLUYE ADAPTADOR

550
LUMENS

BLANCA | 6 500 K

CÓDIGO	10	60	DISTRIB.	MAYOREO	LISTA
121023			\$16.00	\$22.90	\$28.00

530
LUMENS

CÁLIDA | 3 000 K

CÓDIGO	10	60	DISTRIB.	MAYOREO	LISTA
121053			\$16.00	\$22.90	\$28.00

CUMPLE CON LOS PARÁMETROS DE LA NOM-030-ENER-2016



CUMPLE CON LOS PARÁMETROS DE LA NOM-030-ENER-2016



CUMPLE CON LOS PARÁMETROS DE LA NOM-030-ENER-2016





CLASSIC LINE

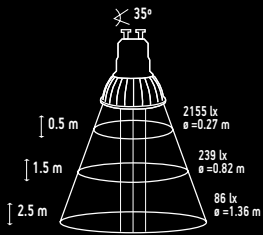

3

Años de garantía



BASE GU10

CLASSIC LINE

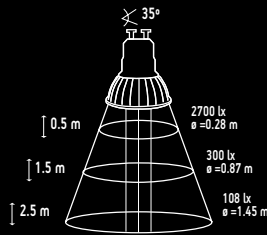

3

Años de garantía



BASE GU10

CLASSIC LINE

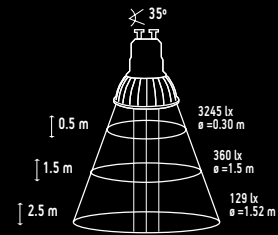

3

Años de garantía



BASE GU10

MR16

CONSUME 3 W

ILUMINA 30 W

Comparación vs 1 halógeno



NO INCLUYE ADAPTADOR

300 LUMENS

BLANCA | 6 500 K

CÓDIGO	10	60	DISTRIB.	MAYOREO	LISTA
121001			\$14.00	\$20.00	\$24.70

280 LUMENS

CÁLIDA | 3 000 K

CÓDIGO	10	60	DISTRIB.	MAYOREO	LISTA
121031			\$14.00	\$20.00	\$24.70

MR16

CONSUME 5 W

ILUMINA 40 W

Comparación vs 1 halógeno



NO INCLUYE ADAPTADOR

450 LUMENS

BLANCA | 6 500 K

CÓDIGO	10	60	DISTRIB.	MAYOREO	LISTA
121011			\$15.00	\$21.40	\$26.00

430 LUMENS

CÁLIDA | 3 000 K

CÓDIGO	10	60	DISTRIB.	MAYOREO	LISTA
121041			\$15.00	\$21.40	\$26.00

MR16

CONSUME 7 W

ILUMINA 55 W

Comparación vs 1 halógeno



NO INCLUYE ADAPTADOR

550 LUMENS

BLANCA | 6 500 K

CÓDIGO	10	60	DISTRIB.	MAYOREO	LISTA
121021			\$16.00	\$22.90	\$28.00

530 LUMENS

CÁLIDA | 3 000 K

CÓDIGO	10	60	DISTRIB.	MAYOREO	LISTA
121051			\$16.00	\$22.90	\$28.00

CUMPLE CON LOS PARÁMETROS DE LA NOM-030-ENER-2016



CUMPLE CON LOS PARÁMETROS DE LA NOM-030-ENER-2016



CUMPLE CON LOS PARÁMETROS DE LA NOM-030-ENER-2016







BASE PARA SPOT MR16

- Fabricados en acero
- Clips de instalación
- Ideales para lámpara LED AKSI MR16

1
AÑOS DE GARANTÍA

+ INFO PÁG. 203

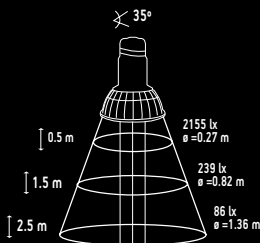
CLASSIC LINE



3

Años de garantía



BASE E27

CLASSIC LINE

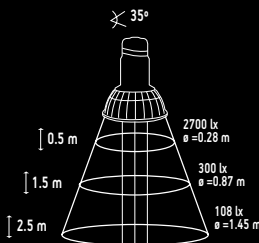

3

Años de garantía



BASE E27

CLASSIC LINE

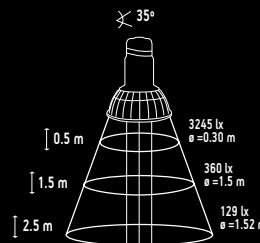

3

Años de garantía



BASE E27

MR16 LED Dicroico

CONSUME 3 W

ILUMINA 30 W

Comparación vs 1 halógeno

127 V ~ 35° direccional 15 000 h de vida 5.6 x 5 cm Caja

300 LUMENS

BLANCA | 6 500 K

CÓDIGO	10	60	DISTRIB.	MAYOREO	LISTA
121005			\$14.00	\$20.00	\$24.70

280 LUMENS

CÁLIDA | 3 000 K

CÓDIGO	10	60	DISTRIB.	MAYOREO	LISTA
121035			\$14.00	\$20.00	\$24.70

CUMPLE CON LOS PARÁMETROS DE LA NOM-030-ENER-2016



MR16 LED Dicroico

CONSUME 5 W

ILUMINA 40 W

Comparación vs 1 halógeno

127 V ~ 35° direccional 15 000 h de vida 5.6 x 5 cm Caja

450 LUMENS

BLANCA | 6 500 K

CÓDIGO	10	60	DISTRIB.	MAYOREO	LISTA
121015			\$15.00	\$21.40	\$26.00

430 LUMENS

CÁLIDA | 3 000 K

CÓDIGO	10	60	DISTRIB.	MAYOREO	LISTA
121045			\$15.00	\$21.40	\$26.00

CUMPLE CON LOS PARÁMETROS DE LA NOM-030-ENER-2016



MR16 LED Dicroico

CONSUME 7 W

ILUMINA 55 W

Comparación vs 1 halógeno

127 V ~ 35° direccional 15 000 h de vida 5.6 x 5 cm Caja

550 LUMENS

BLANCA | 6 500 K

CÓDIGO	10	60	DISTRIB.	MAYOREO	LISTA
121025			\$16.00	\$22.90	\$28.00

530 LUMENS

CÁLIDA | 3 000 K

CÓDIGO	10	60	DISTRIB.	MAYOREO	LISTA
121055			\$16.00	\$22.90	\$28.00

CUMPLE CON LOS PARÁMETROS DE LA NOM-030-ENER-2016





CLASSIC LINE



1

Año de garantía

CLASSIC LINE



1

Año de garantía

Luminario Spot circular LED

127 V ~ 60 Hz

40° direccional

25 000 h de vida

Caja

Potencia: 3 W	Blanca: 230 lm Cálida: 200 lm	A 7.5 cm B 5.0 cm C 3.0 cm
Potencia: 5 W	Blanca: 370 lm Cálida: 330 lm	A 8.9 cm B 6.8 cm C 3.0 cm
Potencia: 7 W	Blanca: 500 lm Cálida: 480 lm	A 8.9 cm B 6.8 cm C 4.2 cm
Potencia: 12 W	Blanca: 1000 lm Cálida: 950 lm	A 14 cm B 11.3 cm C 4.5 cm

Luminario Spot cuadrado LED

127 V ~ 60 Hz

40° direccional

25 000 h de vida

Caja

Potencia: 3 W	Blanca: 230 lm Cálida: 200 lm	A 7.5 cm B 5.0 cm C 3.9 cm
Potencia: 5 W	Blanca: 370 lm Cálida: 330 lm	A 8.9 cm B 7.0 cm C 4.1 cm
Potencia: 7 W	Blanca: 500 lm Cálida: 480 lm	A 8.9 cm B 7.0 cm C 4.7 cm
Potencia: 12 W	Blanca: 1000 lm Cálida: 950 lm	A 14 cm B 11.0 cm C 4.5 cm

BLANCA | 6 500 K

CÓDIGO	POTENCIA	⊞	⊞	DISTRIB.	MAYOREO	LISTA
121121	3 W	6	36	\$35.00	\$50.00	\$62.00
121122	5 W	6	36	\$40.00	\$57.00	\$71.00
121123	7 W	6	36	\$45.00	\$64.00	\$79.00
121124	12 W	6	36	\$75.00	\$107.00	\$132.00

CÁLIDA | 3 000 K

CÓDIGO	POTENCIA	⊞	⊞	DISTRIB.	MAYOREO	LISTA
121131	3 W	6	36	\$35.00	\$50.00	\$62.00
121132	5 W	6	36	\$40.00	\$57.00	\$71.00
121133	7 W	6	36	\$45.00	\$64.00	\$79.00
121134	12 W	6	36	\$75.00	\$107.00	\$132.00

BLANCA | 6 500 K

CÓDIGO	POTENCIA	⊞	⊞	DISTRIB.	MAYOREO	LISTA
121101	3 W	6	36	\$40.00	\$57.00	\$71.00
121102	5 W	6	36	\$45.00	\$64.00	\$79.00
121103	7 W	6	36	\$49.00	\$70.00	\$86.00
121104	12 W	6	36	\$99.00	\$141.00	\$175.00

CÁLIDA | 3 000 K

CÓDIGO	POTENCIA	⊞	⊞	DISTRIB.	MAYOREO	LISTA
121111	3 W	6	36	\$40.00	\$57.00	\$71.00
121112	5 W	6	36	\$45.00	\$64.00	\$79.00
121113	7 W	6	36	\$49.00	\$70.00	\$86.00
121114	12 W	6	36	\$99.00	\$141.00	\$175.00

CUMPLE CON LOS PARÁMETROS DE LA NOM-003-SCFI-2014



CUMPLE CON LOS PARÁMETROS DE LA NOM-003-SCFI-2014





CLASSIC LINE

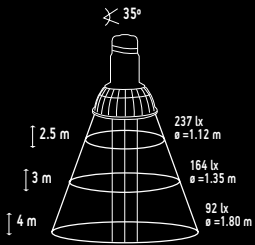

3

Años de garantía



BASE E27

CLASSIC LINE

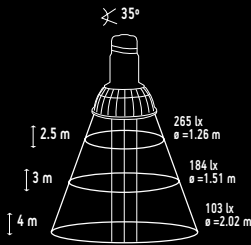

3

Años de garantía



BASE E27

CLASSIC LINE

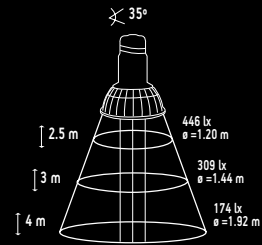

3

Años de garantía



BASE E27

PAR 20 LED

CONSUME 6 W

ILUMINA 55 W

Comparación vs 1 halógeno



490 LUMENS

BLANCA | 6 500 K

CÓDIGO	6	12	DISTRIB.	MAYOREO	LISTA
115543			\$30.00	\$43.00	\$53.00

460 LUMENS

CÁLIDA | 3 000 K

CÓDIGO	6	12	DISTRIB.	MAYOREO	LISTA
115544			\$30.00	\$43.00	\$53.00

CUMPLE CON LOS PARÁMETROS DE LA NOM-030-ENER-2016



PAR 30 LED

CONSUME 12 W

ILUMINA 95 W

Comparación vs 1 halógeno



900 LUMENS

BLANCA | 6 500 K

CÓDIGO	6	12	DISTRIB.	MAYOREO	LISTA
115565			\$49.00	\$70.00	\$86.00

880 LUMENS

CÁLIDA | 3 000 K

CÓDIGO	6	12	DISTRIB.	MAYOREO	LISTA
115566			\$49.00	\$70.00	\$86.00

CUMPLE CON LOS PARÁMETROS DE LA NOM-030-ENER-2016



PAR 38 LED

CONSUME 20 W

ILUMINA 180 W

Comparación vs 1 halógeno



1400 LUMENS

BLANCA | 6 500 K

CÓDIGO	6	12	DISTRIB.	MAYOREO	LISTA
115585			\$68.00	\$97.00	\$120.00

1370 LUMENS

CÁLIDA | 3 000 K

CÓDIGO	6	12	DISTRIB.	MAYOREO	LISTA
115586			\$68.00	\$97.00	\$120.00

CUMPLE CON LOS PARÁMETROS DE LA NOM-030-ENER-2016





CLASSIC LINE

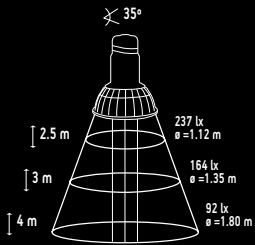

CLASSIC LINE

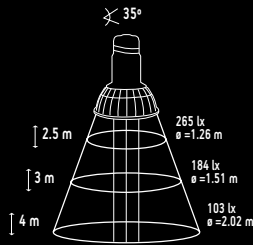

CLASSIC LINE

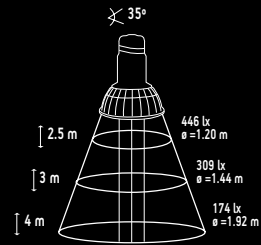

3

Años de garantía



BASE E27

3

Años de garantía



BASE E27

3

Años de garantía



BASE E27

PAR 20 LED IP65

CONSUME 6 W

ILUMINA 55 W

Comparación vs 1 halógeno



490 LUMENS

BLANCA | 6 500 K

CÓDIGO	6	12	DISTRIB.	MAYOREO	LISTA
121501	6	12	\$40.00	\$57.00	\$71.00

460 LUMENS

CÁLIDA | 3 000 K

CÓDIGO	6	12	DISTRIB.	MAYOREO	LISTA
121502	6	12	\$40.00	\$57.00	\$71.00

CUMPLE CON LOS PARÁMETROS DE LA NOM-030-ENER-2016



PAR 30 LED IP65

CONSUME 12 W

ILUMINA 95 W

Comparación vs 1 halógeno



900 LUMENS

BLANCA | 6 500 K

CÓDIGO	6	12	DISTRIB.	MAYOREO	LISTA
121511	6	12	\$60.00	\$86.00	\$106.00

880 LUMENS

CÁLIDA | 3 000 K

CÓDIGO	6	12	DISTRIB.	MAYOREO	LISTA
121512	6	12	\$60.00	\$86.00	\$106.00

CUMPLE CON LOS PARÁMETROS DE LA NOM-030-ENER-2016



PAR 38 LED IP65

CONSUME 20 W

ILUMINA 180 W

Comparación vs 1 halógeno



1400 LUMENS

BLANCA | 6 500 K

CÓDIGO	6	12	DISTRIB.	MAYOREO	LISTA
121521	6	12	\$90.00	\$129.00	\$160.00

1370 LUMENS

CÁLIDA | 3 000 K

CÓDIGO	6	12	DISTRIB.	MAYOREO	LISTA
121522	6	12	\$90.00	\$129.00	\$160.00

CUMPLE CON LOS PARÁMETROS DE LA NOM-030-ENER-2016



CÓDIGO	COLOR	6	12	DISTRIB.	MAYOREO	LISTA
122241	Azul	6	12	\$75.00	\$107.00	\$132.00
122242	Rojo	6	12	\$75.00	\$107.00	\$132.00
122243	Verde	6	12	\$75.00	\$107.00	\$132.00
122244	Amarillo	6	12	\$75.00	\$107.00	\$132.00



CLASSIC LINE



3
Años de garantía

BASE E27 BASE E12

3
Años de garantía

BASE E27 BASE E12

3
Años de garantía

BASE E27 BASE E12

VELA OPALINA LED

VELA LED

FLAMA LED

CONSUME **5 W** ILUMINA **25 W**

CONSUME **4 W** ILUMINA **25 W**

CONSUME **4 W** ILUMINA **25 W**

127 V ~ 260° omnidireccional 15 000 h de vida E27 - 3.6 x 10 cm / E12 - 3.6 x 9.8 cm Caja

127 V ~ 260° omnidireccional 15 000 h de vida E27 - 3.7 x 10.8 cm / E12 - 3.7 x 10.2 cm Caja

127 V ~ 260° omnidireccional 15 000 h de vida E27 - 3.7 x 11.3 cm / E12 - 3.7 x 10.8 cm Caja

350 LUMENS BLANCA | 6 500 K

CÓDIGO	BASE	6	60	DISTRIB.	MAYOREO	LISTA
122044	E27	6	60	\$15.00	\$21.40	\$26.00
122043	E12	6	60	\$15.00	\$21.40	\$26.00

280 LUMENS BLANCA | 6 500 K

CÓDIGO	BASE	10	60	DISTRIB.	MAYOREO	LISTA
122014	E27	10	60	\$25.00	\$36.00	\$44.00
122012	E12	10	60	\$25.00	\$36.00	\$44.00

280 LUMENS BLANCA | 6 500 K

CÓDIGO	BASE	10	60	DISTRIB.	MAYOREO	LISTA
122034	E27	10	60	\$25.00	\$36.00	\$44.00
122032	E12	10	60	\$25.00	\$36.00	\$44.00

350 LUMENS CÁLIDA | 3 000 K

CÓDIGO	BASE	6	60	DISTRIB.	MAYOREO	LISTA
122042	E27	6	60	\$15.00	\$21.40	\$26.00
122041	E12	6	60	\$15.00	\$21.40	\$26.00

280 LUMENS CÁLIDA | 3 000 K

CÓDIGO	BASE	10	60	DISTRIB.	MAYOREO	LISTA
122003	E27	10	60	\$25.00	\$36.00	\$44.00
122001	E12	10	60	\$25.00	\$36.00	\$44.00

280 LUMENS CÁLIDA | 3 000 K

CÓDIGO	BASE	10	60	DISTRIB.	MAYOREO	LISTA
122023	E27	10	60	\$25.00	\$36.00	\$44.00
122021	E12	10	60	\$25.00	\$36.00	\$44.00

CUMPLE CON LOS PARÁMETROS DE LA NOM-030-ENER-2016 **NOM**

CUMPLE CON LOS PARÁMETROS DE LA NOM-030-ENER-2016 **NOM**

CUMPLE CON LOS PARÁMETROS DE LA NOM-030-ENER-2016 **NOM**



DIAMOND LINE

DIAMOND LINE



¡TIPS DE USO!



3

Años de garantía



BASE E27



BASE E12

3

Años de garantía



BASE E27



BASE E12

VELA LED filamentos

CONSUME 2 W

ILUMINA 25 W



127 V ~



360° omnidireccional



15 000 h de vida



3.5 x 9.3 cm cód. 115534



3.5 x 9.7 cm cód. 115533



Caja

220

LUMENS

CÁLIDA | 2 700 K

CÓDIGO
115534
115533

BASE
E27
E12

6
6

24
24

DISTRIB.
\$25.00
\$25.00

MAYOREO
\$36.00
\$36.00

LISTA
\$44.00
\$44.00

VELA LED filamentos

CONSUME 4W

ILUMINA 25 W



127 V ~



360° omnidireccional



15 000 h de vida



3.5 x 9.3 cm cód. 115536



3.5 x 9.7 cm cód. 115535



Caja

330

LUMENS

CÁLIDA | 2 700 K

CÓDIGO
115536
115535

BASE
E27
E12

6
6

24
24

DISTRIB.
\$29.00
\$29.00

MAYOREO
\$41.00
\$41.00

LISTA
\$51.00
\$51.00

CUMPLE CON LOS PARÁMETROS DE LA NOM-030-ENER-2016



CUMPLE CON LOS PARÁMETROS DE LA NOM-030-ENER-2016





AKSI
HERRAMIENTA PROFESIONAL

DIAMOND LINE

DIAMOND LINE



3



Años de garantía

BASE E27

3



Años de garantía

BASE E27

Dimeable A19 LED

CONSUME **9 W**

ILUMINA **60 W**

Comparación vs lámparas incandescentes



Dimeable A19 LED

CONSUME **12 W**

ILUMINA **75 W**

Comparación vs lámparas incandescentes



750
LUMENS

CÁLIDA | 3 000 K

CÓDIGO	6	48	DISTRIB.	MAYOREO	LISTA
123113			\$32.00	\$46.00	\$56.00

1050
LUMENS

CÁLIDA | 3 000 K

CÓDIGO	6	48	DISTRIB.	MAYOREO	LISTA
123114			\$35.00	\$50.00	\$62.00

CUMPLE CON LOS PARÁMETROS DE LA NOM-030-ENER-2016 **NOM**

CUMPLE CON LOS PARÁMETROS DE LA NOM-030-ENER-2016 **NOM**

REGULA LA
ILUMINACIÓN
DE TUS ESPACIOS



DIAMOND LINE

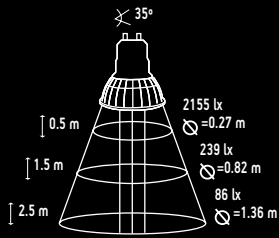

DIAMOND LINE

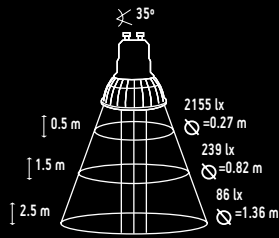

DIAMOND LINE



3



Años de garantía BASE GU4

3



Años de garantía BASE GU10 BASE GU5.3

3



Años de garantía BASE E27 BASE E12

Dimeable MR16 LED

CONSUME 3 W

ILUMINA 25 W

Comparación vs 1 halógeno



NO INCLUYE ADAPTADOR

170 LUMENS

CÁLIDA | 3 000 K

CÓDIGO	6	48	DISTRIB.	MAYOREO	LISTA
123228			\$32.00	\$46.00	\$56.00

CUMPLE CON LOS PARÁMETROS DE LA NOM-030-ENER-2016



Dimeable MR16 LED

CONSUME 7 W

ILUMINA 55 W

Comparación vs 1 halógeno



NO INCLUYE ADAPTADOR

480 LUMENS

CÁLIDA | 3 000 K

CÓDIGO	6	48	DISTRIB.	MAYOREO	LISTA
123221			\$32.00	\$46.00	\$56.00

BASE GU5.3

CÓDIGO	6	48	DISTRIB.	MAYOREO	LISTA
123223			\$32.00	\$46.00	\$56.00

CUMPLE CON LOS PARÁMETROS DE LA NOM-030-ENER-2016



Dimeable VELA LED

CONSUME 4 W

ILUMINA 25 W

Comparación vs lámparas incandescentes



280 LUMENS

CÁLIDA | 3 000 K

CÓDIGO	BASE	6	48	DISTRIB.	MAYOREO	LISTA
123301	E12			\$45.00	\$64.00	\$79.00
123302	E27			\$45.00	\$64.00	\$79.00

CUMPLE CON LOS PARÁMETROS DE LA NOM-030-ENER-2016





CLASIC LINE

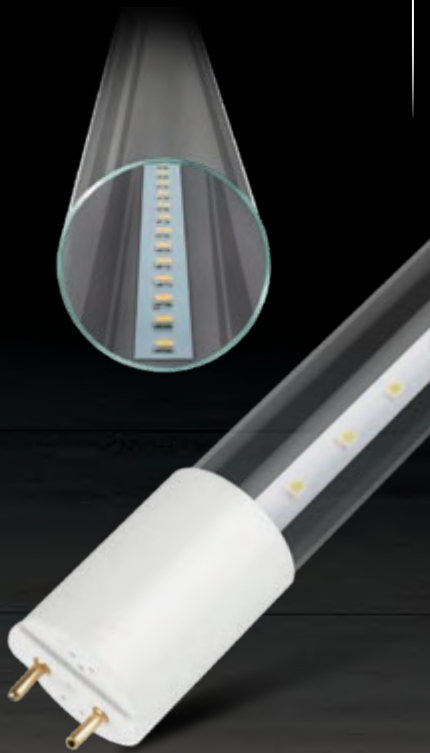

CLASSIC LINE



CLASSIC LINE



1
Año de garantía
BASE G13



Te sugerimos el uso de la Portalámpara BASE G13 Compatible con otros modelos AKSI®

CÓDIGO	DISTRIB.	MAY.	LISTA
117583	10	100	\$12.00 \$17.10 \$21.20

1
Año de garantía
BASE G5



Te sugerimos el uso de la Portalámpara BASE G5 Compatible con otros modelos AKSI®

CÓDIGO	DISTRIB.	MAY.	LISTA
117582	10	100	\$11.00 \$15.70 \$19.40

Lámpara de vidrio
TUBULAR, 120 cm LED

CONSUME **15 W**

100 V ~ 240 V ~	T8 Tubo	85 lm/W	15 000 h de vida	2.6 x 120 cm	Tubo pack
--------------------	------------	------------	---------------------	--------------	--------------

1600
LUMENS | BLANCA | 6 500 K

CÓDIGO	DISTRIB.	MAYOREO	LISTA
115284	10 30	\$40.00	\$57.00 \$71.00

CUMPLE CON LOS PARÁMETROS DE LA NOM-003-SCFI-2014



Lámpara plástica
TUBULAR, 120 cm LED

CONSUME **18 W**

100 V ~ 240 V ~	T8 Tubo	95 lm/W	30 000 h de vida	2.6 x 120 cm	Tubo pack
--------------------	------------	------------	---------------------	--------------	--------------

1600
LUMENS | BLANCA | 6 500 K

CÓDIGO	DISTRIB.	MAYOREO	LISTA
115274	25	\$65.00	\$93.00 \$115.00

CUMPLE CON LOS PARÁMETROS DE LA NOM-003-SCFI-2014



Lámpara de vidrio
con recubrimiento plástico
TUBULAR, 116 cm LED

CONSUME **25 W**

100 V ~ 277 V ~	T5 Tubo	30 000 h de vida	1.9 x 116 cm	Caja
--------------------	------------	---------------------	--------------	------

4200
LUMENS | BLANCA | 6 500 K

CÓDIGO	DISTRIB.	MAYOREO	LISTA
115221	12 48	\$160.00	\$230.00 \$280.00

CUMPLE CON LOS PARÁMETROS DE LA NOM-003-SCFI-2014





nuevas formas
DE ILUMINACIÓN
en tus espacios

CLASSIC LINE



118082



118081

1

Año de garantía



BASE G13

LED LINE



1

Año de garantía

Luminario para tubo LED de 120 cm

Se recomienda para tubos AKSI® de 120 cm: código 115284 y 115274

Cód. 118081

Para 1 tubo LED de 1.2 m de largo

Cód. 118082

Para 2 tubos LED de 1.2 m de largo

CÓDIGO	TUBOS	📦	DISTRIB.	MAYOREO	LISTA
118081	1	60	\$38.00	\$54.00	\$67.00
118082	2	35	\$55.00	\$79.00	\$97.00

CUMPLE CON LOS PARÁMETROS DE LA NOM-003-SCFI-2014



GABINETE Hermético Para tubo T8



180°



IP65



Caja



Para tubo de 120 cm

118032 - No incluye tubo

Gabinete Sin Tubo

Ideal para **Tubo LED**

Medida total de luminario

126 cm

118039 - Incluye 2 tubos LED de 15 W

CONSUME 2 de 15 W

3200 LUMENS

126 cm

118038 - Incluye 2 tubos LED de 18 W

CONSUME 2 de 18 W

3200 LUMENS

126 cm

- Gabinete resistente al agua
- Fabricado en policarbonato con empaque de silicona en cable de alimentación
- Incluye herrajes de sujeción · Diseño compacto

GABINETE SIN TUBO

CÓDIGO	TAMAÑO	📦	DISTRIB.	MAYOREO	LISTA
118032	126 cm	10	\$240.00	\$345.00	\$425.00

BLANCA | 6 500 K

CÓDIGO	TAMAÑO	📦	DISTRIB.	MAYOREO	LISTA
118038	126 cm	10	\$350.00	\$500.00	\$615.00
118039	126 cm	10	\$300.00	\$430.00	\$530.00

CUMPLE CON LOS PARÁMETROS DE LA NOM-003-SCFI-2014





CLASSIC LINE



1
Año de garantía

LED LINE



1
Año de garantía

LED LINE



1
Año de garantía

Luminario para gabinete

20 000 h de vida

Puente flexible para unir 2 luminarios

Potencia: 4 W	450 LUMENS	2.4 x 30 cm
Potencia: 9 W	900 LUMENS	2.4 x 60 cm
Potencia: 14 W	1400 LUMENS	2.4 x 90 cm
Potencia: 18 W	1800 LUMENS	2.4 x 120 cm

BLANCA | 6 500 K

CÓDIGO	POTENCIA	📦	📦	DISTRIB.	MAYOREO	LISTA
118001	4 W	6	36	\$75.00	\$107.00	\$132.00
118002	9 W	6	36	\$95.00	\$136.00	\$170.00
118003	14 W	6	36	\$115.00	\$165.00	\$205.00
118004	18 W	6	36	\$140.00	\$200.00	\$245.00

CUMPLE CON LOS PARÁMETROS DE LA NOM-003-SCFI-2014



LUMINARIO DE Sobreponer

100 V ~ 240 V ~

180°

20 000 h de vida

Caja

Potencia: 18 W	1700 LUMENS	60 cm
Potencia: 36 W	3300 LUMENS	120 cm

- Diseño compacto y discreto, ideal para uso en interior
- Fabricado en policarbonato
- Incluye herrajes de sujeción

BLANCA | 6 500 K

CÓDIGO	POTENCIA	TAMAÑO	📦	📦	DISTRIB.	MAYOREO	LISTA
118011	18 W	60 cm	4	24	\$90.00	\$129.00	\$160.00
118012	36 W	120 cm	4	24	\$140.00	\$200.00	\$245.00

CUMPLE CON LOS PARÁMETROS DE LA NOM-003-SCFI-2014



LUMINARIO DE Sobreponer

100 V ~ 240 V ~

180°

20 000 h de vida

IP65

Caja

Potencia: 18 W	1700 LUMENS	60 cm
Potencia: 36 W	3300 LUMENS	120 cm

- Luminario resistente al agua
- Fabricado en policarbonato con empaque de silicón en cable de alimentación
- Incluye herrajes de sujeción
- Diseño compacto y discreto

BLANCA | 6 500 K

CÓDIGO	POTENCIA	TAMAÑO	📦	📦	DISTRIB.	MAYOREO	LISTA
118021	18 W	60 cm	4	24	\$110.00	\$155.00	\$195.00
118022	36 W	120 cm	4	24	\$170.00	\$245.00	\$300.00

CUMPLE CON LOS PARÁMETROS DE LA NOM-003-SCFI-2014





CLASSIC LINE

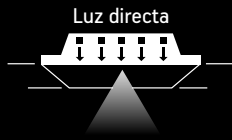
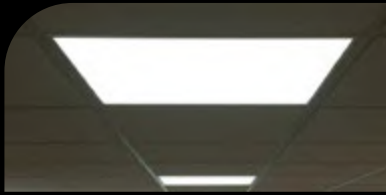

Luz directa



1

Año de garantía

CLASSIC LINE



Marco de aluminio



Incluye tirantes (1 m)

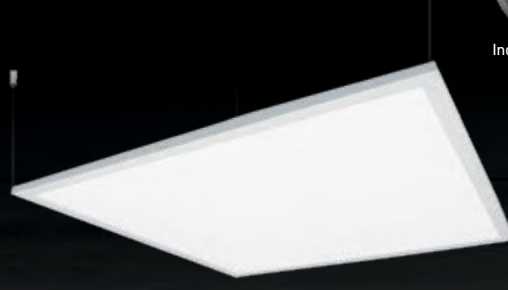

1

Año de garantía

Panel LED luz directa

100V~ 250V~	25 000 h de vida	180°	Caja
-------------	------------------	------	------

CONSUME 40 W	4 000 LUMENS	60 x 60 cm PROF. 3.6 cm
---------------------	---------------------	-------------------------

- Ideal para instalar en falso plafón
- Transformador multi voltaje 100 V~ - 240 V~

BLANCA 6 500 K				
CÓDIGO		DISTRIB.	MAYOREO	LISTA
117954	4	\$400.00	\$570.00	\$705.00

CUMPLE CON LOS PARÁMETROS DE LA NOM-003-SCFI-2014 **NOM**

Panel colgante LED

100V~ 250V~	35 000 h de vida	180°	Caja
-------------	------------------	------	------

CONSUME 45 W	3 600 LUMENS	60 x 60 cm
CONSUME 45 W	3 600 LUMENS	30 x 120 cm
CONSUME 80 W	6 100 LUMENS	60 x 120 cm

- Ideal para instalar en plafones
- Transformador multi voltaje 100 V~ - 240 V~

BLANCA 6 500 K				
CÓDIGO		DISTRIB.	MAYOREO	LISTA
117951	4	\$500.00	\$715.00	\$880.00
117952	4	\$550.00	\$785.00	\$970.00
117953	2	\$1,350.00	\$1,930.00	\$2,380.00

CUMPLE CON LOS PARÁMETROS DE LA NOM-003-SCFI-2014 **NOM**

¡TIPS DE USO EN PANELES!





CLASSIC LINE



CLASSIC LINE



3



Años de garantía BASE E27

1

Año de garantía

UFO LÁMPARA LED

127V~ - 240V~ |
 240° omnidireccional |
 15 000 h de vida |
 Caja

CONSUME 12 W | **ILUMINA 75 W** | **1100 LUMENS**

A 7.5 x Ø 12.5 cm

CONSUME 18 W | **ILUMINA 100 W** | **1700 LUMENS**

A 8.1 x Ø 15 cm

BLANCA 6 500 K					
CÓDIGO			DISTRIB.	MAYOREO	LISTA
121531	4	24	\$70.00	\$100.00	\$123.00
121533	4	24	\$105.00	\$150.00	\$185.00

CUMPLE CON LOS PARÁMETROS DE LA NOM-030-ENER-2016



Luminario LED de sobreponer Tipo Plafón

100V~ - 240V~ |
 15 000 h de vida |
 180° |
 CAJA

CONSUME 12 W | **900 LUMENS**

ø 25 cm PROF. 5.5 cm

CONSUME 18 W | **1350 LUMENS**

ø 32 cm PROF. 6 cm

CONSUME 24 W | **1800 LUMENS**

ø 37 cm PROF. 7 cm

- Ideal para instalar en cualquier superficie
- Transformador multi voltaje 100 V~ - 240 V~

BLANCA 6 500 K					
CÓDIGO	POTENCIA		DISTRIB.	MAYOREO	LISTA
122301	12 W	10	\$140.00	\$200.00	\$245.00
122302	18 W	10	\$160.00	\$230.00	\$280.00
122303	24 W	10	\$215.00	\$305.00	\$380.00

CUMPLE CON LOS PARÁMETROS DE LA NOM-003-SCFI-2014





CLASSIC LINE



DELGADO



1

Año de garantía

CLASSIC LINE



ULTRA DELGADO



1

Año de garantía

Luminario de sobreponer

100V~240V~

180°

20 000 h de vida

Caja

· Ideal para instalar en plafones
· Transformador multi voltaje
100 V~ - 240 V~

		CUADRADO	CIRCULAR
CONSUME 6 W	400 LUMENS	11 cm PROF. 2.8 cm	Ø 11 cm PROF. 2.8 cm
CONSUME 12 W	800 LUMENS	16 cm PROF. 2.8 cm	Ø 16 cm PROF. 2.8 cm
CONSUME 18 W	1200 LUMENS	21 cm PROF. 2.8 cm	Ø 21 cm PROF. 2.8 cm
CONSUME 24 W	1600 LUMENS	28 cm PROF. 2.8 cm	Ø 28 cm PROF. 2.8 cm

BLANCA 6 500 K							
CÓDIGO	POTENCIA	📦	📦	DISTRIB.	MAYOREO	LISTA	
LUMINARIO CUADRADO							
117972	6 W	6	36	\$55.00	\$79.00	\$97.00	
117974	12 W	6	36	\$75.00	\$107.00	\$132.00	
117976	18 W	6	24	\$95.00	\$136.00	\$170.00	
117978	24 W	6	12	\$150.00	\$215.00	\$265.00	
LUMINARIO CIRCULAR							
117962	6 W	6	36	\$50.00	\$71.00	\$88.00	
117964	12 W	6	36	\$70.00	\$100.00	\$123.00	
117966	18 W	6	24	\$90.00	\$129.00	\$160.00	
117968	24 W	6	12	\$130.00	\$185.00	\$230.00	

CUMPLE CON LOS PARÁMETROS DE LA NOM-003-SCFI-2014



Luminario empotrable, ultra delgado

100V~240V~

180°

20 000 h de vida

Caja

· Ideal para instalar en plafones
· Transformador multi voltaje
100 V~ - 240 V~

		CUADRADO	CIRCULAR
CONSUME 6 W	400 LUMENS	INT. 10 cm EXT. 12 cm	INT. 10.7 cm EXT. 12 cm
CONSUME 12 W	800 LUMENS	INT. 15 cm EXT. 17 cm	INT. 16.3 cm EXT. 17 cm
CONSUME 18 W	1200 LUMENS	INT. 20 cm EXT. 22 cm	INT. 20.3 cm EXT. 22 cm

BLANCA 6 500 K							
CÓDIGO	POTENCIA	📦	📦	DISTRIB.	MAYOREO	LISTA	
LUMINARIO CUADRADO							
117934	6 W	6	36	\$55.00	\$79.00	\$97.00	
117936	12 W	6	36	\$75.00	\$107.00	\$132.00	
117938	18 W	6	24	\$95.00	\$136.00	\$170.00	
LUMINARIO CIRCULAR							
117914	6 W	6	36	\$45.00	\$64.00	\$79.00	
117916	12 W	6	36	\$65.00	\$93.00	\$115.00	
117918	18 W	6	24	\$80.00	\$114.00	\$141.00	

CÁLIDA 2 700 K							
CÓDIGO	POTENCIA	📦	📦	DISTRIB.	MAYOREO	LISTA	
LUMINARIO CUADRADO							
117933	6 W	6	36	\$55.00	\$79.00	\$97.00	
117935	12 W	6	36	\$75.00	\$107.00	\$132.00	
117937	18 W	6	24	\$95.00	\$136.00	\$170.00	
LUMINARIO CIRCULAR							
117913	6 W	6	36	\$45.00	\$64.00	\$79.00	
117915	12 W	6	36	\$65.00	\$93.00	\$115.00	
117917	18 W	6	24	\$80.00	\$114.00	\$141.00	

CUMPLE CON LOS PARÁMETROS DE LA NOM-003-SCFI-2014





CLASSIC LINE



ULTRA DELGADO

1

Año de garantía

AJUSTABLE
en modo empotrable



Desplaza los clips para ajustar al tamaño del bote integral.

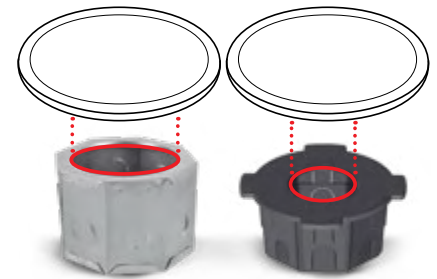

Se puede utilizar en botes compatibles con la apertura del luminario.



PROX. **Luminario empotrable, ajustable**



		CUADRADO		CIRCULAR	
CONSUME	LUMENS	LUMINARIO (cm)	APERTURA (cm) mínima [A] / máxima [B]	LUMINARIO (cm)	APERTURA (cm) MÍNIMA [A] / MÁXIMA [B]
6 W	360	10x10 PROF. 1.0	5.25 / 7.15	ø 10 PROF. 1.0	5.25 / 7.15
8 W	500	1.8x1.8 PROF. 1.0	5.25 / 8.96	ø 1.8 PROF. 1.0	5.25 / 8.96
15 W	1050	17.5x17.5 PROF. 1.0	5.25 / 13.45	ø 17.5 PROF. 1.0	5.25 / 13.45
20 W	1200	23x23 PROF. 1.0	5.25 / 18.75	ø 23 PROF. 1.0	5.25 / 18.75

BLANCA 6 500 K						
CÓDIGO	POTENCIA	DIAM.	PROF.	DISTRIB.	MAYOREO	LISTA
LUMINARIO CUADRADO - luz blanca						
122412	6 W	6	36	\$38.00	\$54.00	\$67.00
122414	8 W	6	36	\$45.00	\$64.00	\$79.00
122416	15 W	6	36	\$65.00	\$93.00	\$115.00
122418	20 W	6	24	\$90.00	\$129.00	\$160.00
LUMINARIO CIRCULAR - luz blanca						
122402	6 W	6	36	\$35.00	\$50.00	\$62.00
122404	8 W	6	36	\$40.00	\$57.00	\$71.00
122406	15 W	6	36	\$55.00	\$79.00	\$97.00
122408	20 W	6	24	\$75.00	\$107.00	\$132.00

CÁLIDA 2 700 K						
CÓDIGO	POTENCIA	DIAM.	PROF.	DISTRIB.	MAYOREO	LISTA
LUMINARIO CUADRADO - luz cálida						
122411	6 W	6	36	\$38.00	\$54.00	\$67.00
122413	8 W	6	36	\$45.00	\$64.00	\$79.00
122415	15 W	6	36	\$65.00	\$93.00	\$115.00
122417	20 W	6	24	\$90.00	\$129.00	\$160.00
LUMINARIO CIRCULAR - luz cálida						
122401	6 W	6	36	\$35.00	\$50.00	\$62.00
122403	8 W	6	36	\$40.00	\$57.00	\$71.00
122405	15 W	6	36	\$55.00	\$79.00	\$97.00
122407	20 W	6	24	\$75.00	\$107.00	\$132.00

CUMPLE CON LOS PARÁMETROS DE LA NOM-003-SCFI-2014





TECNOLOGÍA LED

¿CÓMO INSTALAR TU LUMINARIO?

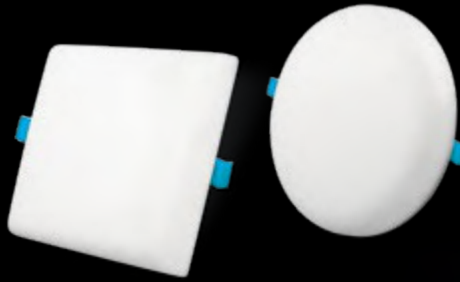

1

Año de garantía

sugerencia de uso

EMPOTRABLE



SOBREPONER

Modo 1 AJUSTABLE en modo empotrable

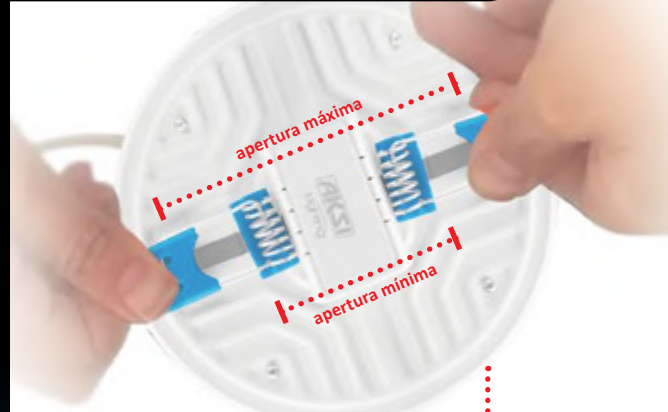

Desplaza los clips para ajustar al tamaño del bote integral.

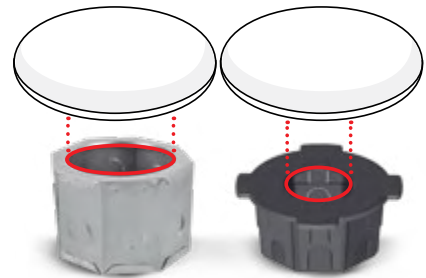

Se puede utilizar en botes compatibles con la apertura del luminario.

Luminario 2 en 1: empotrable ajustable o de sobreponer



CUADRADO		APERTURA (cm)		CIRCULAR	
LUMINARIO (cm)	APERTURA (cm)	MÍNIMA (A)	MÁXIMA (B)	LUMINARIO (cm)	APERTURA (cm)
CONSUME 10 W 900 LUMENS	10 x 10 PROF. 1.9	5.25	7.15	ø 10 PROF. 1.9	5.25 7.15
CONSUME 15 W 1350 LUMENS	12 x 12 PROF. 1.9	5.25	8.96	ø 12 PROF. 1.9	5.25 8.96
CONSUME 22 W 1980 LUMENS	17 x 17 PROF. 1.9	5.25	13.45	ø 17 PROF. 1.9	5.25 13.45
CONSUME 32 W 2880 LUMENS	22 x 22 PROF. 1.9	5.25	18.75	ø 22 PROF. 1.9	5.25 18.75

BLANCA | 6 500 K

CÓDIGO	POTENCIA	6	36	DISTRIB.	MAYOREO	LISTA
LUMINARIO CUADRADO - luz blanca						
117992	10 W	6	36	\$75.00	\$107.00	\$132.00
117994	15 W	6	36	\$105.00	\$150.00	\$185.00
117996	22 W	6	36	\$140.00	\$200.00	\$245.00
117998	32 W	6	24	\$215.00	\$305.00	\$380.00
LUMINARIO CIRCULAR - luz blanca						
117982	10 W	6	36	\$70.00	\$100.00	\$123.00
117984	15 W	6	36	\$100.00	\$143.00	\$175.00
117986	22 W	6	36	\$130.00	\$185.00	\$230.00
117988	32 W	6	24	\$200.00	\$285.00	\$355.00

CÁLIDA | 3 000 K

CÓDIGO	POTENCIA	6	36	DISTRIB.	MAYOREO	LISTA
LUMINARIO CUADRADO - luz cálida						
117991	10 W	6	36	\$75.00	\$107.00	\$132.00
117993	15 W	6	36	\$105.00	\$150.00	\$185.00
117995	22 W	6	36	\$140.00	\$200.00	\$245.00
117997	32 W	6	24	\$215.00	\$305.00	\$380.00
LUMINARIO CIRCULAR - luz cálida						
117981	10 W	6	36	\$70.00	\$100.00	\$123.00
117983	15 W	6	36	\$100.00	\$143.00	\$175.00
117985	22 W	6	36	\$130.00	\$185.00	\$230.00
117987	32 W	6	24	\$200.00	\$285.00	\$355.00

CUMPLE CON LOS PARÁMETROS DE LA NOM-003-SCFI-2014



Modo 2 SOBREPONER

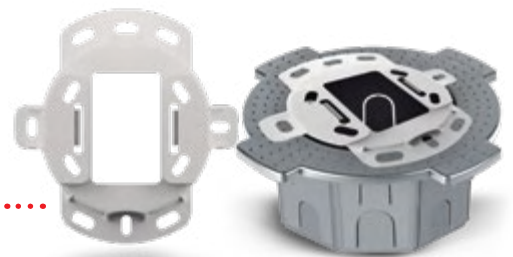

Incluye una base de 10 cm para colocar el luminario en modo de sobreponer.



CLASSIC LINE

CLASSIC LINE

CLASSIC LINE



Discreto sensor de luz y movimiento



5



BASE E27



Sensor de movimiento

Años de garantía

5



Años de garantía

Sensor de movimiento

Extra plano

Ultra delgado

5



Años de garantía

Sensor de movimiento

PROX. **Luminario con sensor de movimiento**

Reflector con sensor de movimiento

PROX. **Reflector solar con sensor de movimiento**

- 120V~
- 180° direccional
- 15 000 h de vida
- IP44
- Caja
- 8m Distancia máxima de detección
- Soporte ajustable

- 100V~ 240V~
- 120° direccional
- 15 000 h de vida
- IP65
- Caja
- 8m Distancia máxima de detección
- Soporte ajustable

- 120° direccional
- 15 000 h de vida
- IP65
- Caja
- 8m Distancia máxima de detección
- Soporte ajustable

CONSUME 150 W

- Cuerpo de policarbonato
- Ajuste de sensibilidad de luz
- Cabezas giratorias
- Ideales para iluminar jardines y patios
- No incluye foco
- 3 Modos ajustables:
 1. Tiempo
 2. Sensibilidad de luz
 3. Detección de movimiento

CONSUME 20 W	1 400 LUMENS	12 x 9.6 cm PROF. 2.5 cm
CONSUME 30 W	2 100 LUMENS	16 x 12 cm PROF. 2.7 cm
CONSUME 50 W	3 500 LUMENS	20.4 x 16 cm PROF. 3.1 cm

- Discreto sensor de luz y movimiento
- Distancia máxima de detección de movimiento 8 m
- Vidrio templado
- Diseño extra plano

800 LUMENS

- Discreto sensor de luz movimiento
- Distancia máxima de detección de movimiento 8 m
- Vidrio templado
- Cuerpo de aluminio
- Diseño extra plano
- Incluye batería

BLANCA 6 500 K				
CÓDIGO	DIAM.	DISTRIB.	MAYOREO	LISTA
124924	24	\$180.00	\$255.00	\$320.00
124925	24	\$180.00	\$255.00	\$320.00

BLANCA 6 500 K						
CÓDIGO	POTENCIA	DIAM.	PROF.	DISTRIB.	MAYOREO	LISTA
116562	20 W	4	20	\$210.00	\$300.00	\$370.00
116563	30 W	2	10	\$245.00	\$350.00	\$430.00
116564	50 W	N/A	10	\$350.00	\$500.00	\$615.00

BLANCA 6 500 K					
CÓDIGO	DIAM.	PROF.	DISTRIB.	MAYOREO	LISTA
116571	4	20	\$235.00	\$335.00	\$415.00

CUMPLE CON LOS PARÁMETROS DE LA NOM-003-SCFI-2014 **NOM**

CUMPLE CON LOS PARÁMETROS DE LA NOM-003-SCFI-2014 **NOM**

CUMPLE CON LOS PARÁMETROS DE LA NOM-003-SCFI-2014 **NOM**



CLASSIC LINE

SMD
TECNOLOGÍA

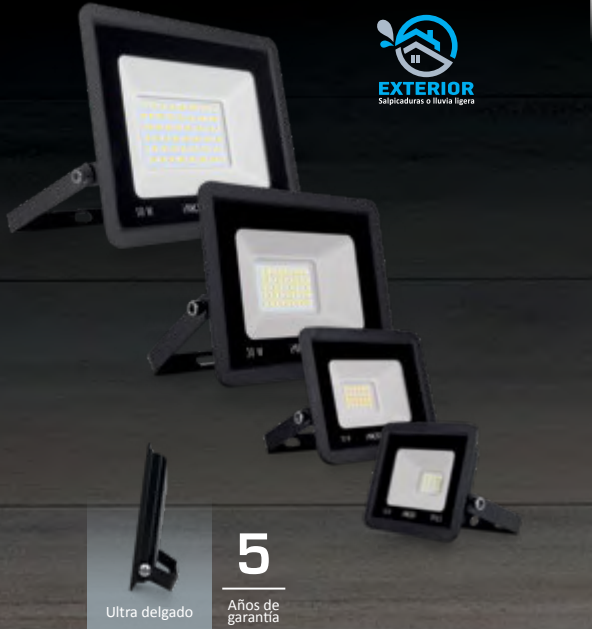

5

Años de garantía

Ultra delgado

CLASSIC LINE

SMD
TECNOLOGÍA



5

Años de garantía

Ultra delgado



Ficha TÉCNICA

NUEVO *Reflector SMD



CONSUME	10 W	700 LUMENS	10.5 x 8.5 cm PROF. 2.3 cm
CONSUME	20 W	1400 LUMENS	12 x 9.6 cm PROF. 2.5 cm
CONSUME	30 W	2100 LUMENS	16 x 12 cm PROF. 2.7 cm
CONSUME	50 W	3 500 LUMENS	20.4 x 16 cm PROF. 3.1 cm

- Fabricado en aluminio
- Ideal para instalar en cualquier superficie

BLANCA | 6 500 K

CÓDIGO	POTENCIA	📦	📦	DISTRIB.	MAYOREO	LISTA
116541	10 W	4	24	\$70.00	\$100.00	\$123.00
116542	20 W	4	20	\$110.00	\$155.00	\$195.00
116543	30 W	2	10	\$150.00	\$215.00	\$265.00
116544	50 W	N/A	10	\$185.00	\$265.00	\$325.00

NUEVO * **CÁLIDA | 3 000 K**

CÓDIGO	POTENCIA	📦	📦	DISTRIB.	MAYOREO	LISTA
116551	10 W	4	24	\$70.00	\$100.00	\$123.00
116552	20 W	4	20	\$110.00	\$155.00	\$195.00
116553	30 W	2	10	\$150.00	\$215.00	\$265.00
116554	50 W	N/A	10	\$185.00	\$265.00	\$325.00

CUMPLE CON LOS PARÁMETROS DE LA NOM-003-SCFI-2014



Ficha TÉCNICA

Reflector SMD



CONSUME	100 W	7 000 LUMENS	27 x 21 cm PROF. 3.3 cm
CONSUME	150 W	10 500 LUMENS	32 x 23 cm PROF. 3.6 cm
CONSUME	200 W	14 000 LUMENS	38 x 28 cm PROF. 3.8 cm

- Fabricado en aluminio
- Ideal para instalar en cualquier superficie

BLANCA | 6 500 K

CÓDIGO	POTENCIA	📦	DISTRIB.	MAYOREO	LISTA
116545	100 W	10	\$325.00	\$465.00	\$575.00
116546	150 W	5	\$530.00	\$755.00	\$935.00
116547	200 W	5	\$680.00	\$970.00	\$1,200.00

CUMPLE CON LOS PARÁMETROS DE LA NOM-003-SCFI-2014





CLASSIC LINE



ALTA
POTENCIA



3

Años de garantía



BASE E27

Alta potencia LED

CONSUME **20 W**

ILUMINA **135 W**

100V ~ 240V ~	240° omnidireccional	15 000 h de vida	8 x 13.5 cm	Caja
---------------	----------------------	------------------	-------------	------

2000 LUMENS

BLANCA | 6 500 K

CÓDIGO		DISTRIB.	MAYOREO	LISTA
116421	4	\$30.00	\$43.00	\$53.00

CUMPLE CON LOS PARÁMETROS DE LA NOM-030-ENER-2016





CLASSIC LINE



CLASSIC LINE



CLASSIC LINE



3



Años de garantía

BASE E27

3



Años de garantía

BASE E27

3



Años de garantía

BASE E27

Alta potencia LED

Alta potencia LED

Alta potencia LED

CONSUME 30 W

ILUMINA 190 W

CONSUME 40 W

ILUMINA 250 W

CONSUME 50 W

ILUMINA 310 W

100V~ 240V~	240° omnidireccional	15 000 h de vida	10 x 16.7 cm	Caja

100V~ 240V~	240° omnidireccional	15 000 h de vida	11.5 x 18.8 cm	Caja

100V~ 240V~	240° omnidireccional	15 000 h de vida	13.5 x 21.8 cm	Caja

3000 LUMENS

BLANCA | 6 500 K

4000 LUMENS

BLANCA | 6 500 K

5000 LUMENS

BLANCA | 6 500 K

CÓDIGO		DISTRIB.	MAYOREO	LISTA
116422	4	\$50.00	\$71.00	\$88.00

CÓDIGO		DISTRIB.	MAYOREO	LISTA
116423	4	\$69.00	\$99.00	\$122.00

CÓDIGO		DISTRIB.	MAYOREO	LISTA
116424	4	\$93.00	\$133.00	\$165.00

CUMPLE CON LOS PARÁMETROS DE LA NOM-030-ENER-2016



CUMPLE CON LOS PARÁMETROS DE LA NOM-030-ENER-2016



CUMPLE CON LOS PARÁMETROS DE LA NOM-030-ENER-2016





CLASSIC LINE

Encendido al detectar movimiento, durante la oscuridad

DETECCIÓN LUZ Y MOVIMIENTO
MÁXIMO: 3 a 5 m



CLASSIC LINE

Encendido al detectar baja intensidad de luz

DETECCIÓN DE LUZ



CLASSIC LINE

Encendido al detectar movimiento

DETECCIÓN DE MOVIMIENTO
MÁXIMO: 3 a 5 m



3



BASE E27



Sensor de movimiento



Sensor de luz

3



BASE E27



Sensor de luz

3



BASE E27



Sensor de movimiento

NUEVO

Alta potencia LED con sensor de luz y movimiento



CONSUME 20 W	LUMENS 2 000	ILUMINA 135 W	8 x 13.5 cm
CONSUME 30 W	LUMENS 3 000	ILUMINA 190 W	10 x 16.7 cm
CONSUME 40 W	LUMENS 4 000	ILUMINA 250 W	11.5 x 18.8 cm
CONSUME 50 W	LUMENS 5 000	ILUMINA 310 W	13.5 x 21.8 cm

BLANCA | 6 500 K

CÓDIGO	DISTRIB.	MAYOREO	LISTA
116426	4	\$125.00	\$180.00 \$220.00
116427	4	\$170.00	\$245.00 \$300.00
116428	4	\$190.00	\$270.00 \$335.00
116429	4	\$260.00	\$370.00 \$460.00

CUMPLE CON LOS PARÁMETROS DE LA NOM-030-ENER-2016



PROX.

Alta potencia LED con sensor de luz (fotocelda)



CONSUME 20 W	LUMENS 2 000	ILUMINA 135 W	8 x 13.5 cm
CONSUME 30 W	LUMENS 3 000	ILUMINA 190 W	10 x 16.7 cm
CONSUME 40 W	LUMENS 4 000	ILUMINA 250 W	11.5 x 18.8 cm
CONSUME 50 W	LUMENS 5 000	ILUMINA 310 W	13.5 x 21.8 cm

BLANCA | 6 500 K

CÓDIGO	DISTRIB.	MAYOREO	LISTA
116451	4	\$125.00	\$180.00 \$220.00
116452	4	\$170.00	\$245.00 \$300.00
116453	4	\$190.00	\$270.00 \$335.00
116454	4	\$260.00	\$370.00 \$460.00

CUMPLE CON LOS PARÁMETROS DE LA NOM-030-ENER-2016



PROX.

Alta potencia LED con sensor de movimiento



CONSUME 20 W	LUMENS 2 000	ILUMINA 135 W	8 x 13.5 cm
CONSUME 30 W	LUMENS 3 000	ILUMINA 190 W	10 x 16.7 cm
CONSUME 40 W	LUMENS 4 000	ILUMINA 250 W	11.5 x 18.8 cm
CONSUME 50 W	LUMENS 5 000	ILUMINA 310 W	13.5 x 21.8 cm

BLANCA | 6 500 K

CÓDIGO	DISTRIB.	MAYOREO	LISTA
116456	4	\$125.00	\$180.00 \$220.00
116457	4	\$170.00	\$245.00 \$300.00
116458	4	\$190.00	\$270.00 \$335.00
116459	4	\$260.00	\$370.00 \$460.00

CUMPLE CON LOS PARÁMETROS DE LA NOM-030-ENER-2016



Los productos de alta rotación se encuentran distinguidos por el color rojo en su código. La apariencia del producto puede llegar a variar • Ventas y atención a clientes 55-5383-4412



CLASSIC LINE



CLASSIC LINE



CLASSIC LINE



3

Años de garantía



BASE E27

3

Años de garantía



BASE E27

3

Años de garantía



BASE E27

Alta potencia LED IP65

Alta potencia LED IP65

Alta potencia LED IP65

CONSUME 35 W

ILUMINA 200 W

Comparación vs lámparas incandescentes

CONSUME 45 W

ILUMINA 225 W

Comparación vs lámparas incandescentes

CONSUME 55 W

ILUMINA 310 W

Comparación vs lámparas incandescentes

110V ~ 220V ~	240° omnidireccional	25 000 h de vida	12,7 x 22,5 cm	Caja
---------------	----------------------	------------------	----------------	------

110V ~ 220V ~	240° omnidireccional	25 000 h de vida	12,7 x 25 cm	Caja
---------------	----------------------	------------------	--------------	------

110V ~ 220V ~	240° omnidireccional	25 000 h de vida	15 x 24,5 cm	Caja
---------------	----------------------	------------------	--------------	------

2 900 LUMENS

BLANCA | 6 500 K

3 500 LUMENS

BLANCA | 6 500 K

4 850 LUMENS

BLANCA | 6 500 K

CÓDIGO	DISTRIB.	MAYOREO	LISTA
116401	4	\$270.00	\$385.00 \$475.00

CÓDIGO	DISTRIB.	MAYOREO	LISTA
116402	4	\$350.00	\$500.00 \$615.00

CÓDIGO	DISTRIB.	MAYOREO	LISTA
116403	4	\$430.00	\$615.00 \$760.00

CUMPLE CON LOS PARÁMETROS DE LA NOM-030-ENER-2016



CUMPLE CON LOS PARÁMETROS DE LA NOM-030-ENER-2016



CUMPLE CON LOS PARÁMETROS DE LA NOM-030-ENER-2016





CLASSIC LINE

CLASSIC LINE



3

Años de garantía

BASE E27

3

Años de garantía

BASE E27

Alta potencia E39 LED IP65

Alta potencia E39 LED IP65

CONSUME 100 W	ILUMINA 570 W
----------------------	----------------------

Comparación vs lámparas incandescentes

CONSUME 150 W	ILUMINA 850 W
----------------------	----------------------

Comparación vs lámparas incandescentes

90V~ 260V~	240° omnidireccional	25 000 h de vida	20.8 x 28.1 cm	Caja
------------	----------------------	------------------	----------------	------

90V~ 260V~	240° omnidireccional	25 000 h de vida	20.9 x 29.9 cm	Caja
------------	----------------------	------------------	----------------	------

9 000 LUMENS	BLANCA 6 500 K
--------------	------------------

13 500 LUMENS	BLANCA 6 500 K
---------------	------------------

CÓDIGO	DISTRIB.	MAYOREO	LISTA
116405	4	\$870.00	\$1,535.00

CÓDIGO	DISTRIB.	MAYOREO	LISTA
116406	4	\$1,100.00	\$1,940.00

CUMPLE CON LOS PARÁMETROS DE LA NOM-030-ENER-2016



CUMPLE CON LOS PARÁMETROS DE LA NOM-030-ENER-2016



El luminario te ofrece multiples aplicaciones, una de ellas es tipo colgante.

Te sugerimos sujetarlo con cadena AKSI® galvanizada ajustando la altura según el espacio a iluminar.



INDUSTRIAL LINE

SMD
TECNOLOGÍA



SOPORTE PARA TECHO
(ANILLO)



SOPORTE PARA PARED



1

Año de garantía

Luminario colgante industrial High bay



CONSUME	100 W	10 000 LUMENS	∅ 27 cm PROF. CON ANILLO 70 mm PROF. SIN ANILLO 32 mm
CONSUME	150 W	15 000 LUMENS	∅ 31 cm PROF. CON ANILLO 77 mm PROF. SIN ANILLO 39 mm
CONSUME	200 W	21 000 LUMENS	∅ 38 cm PROF. CON ANILLO 78 mm PROF. SIN ANILLO 40 mm

· Para uso interior

BLANCA | 6 500 K

CÓDIGO	POTENCIA	W	DISTRIB.	MAYOREO	LISTA
116436	100 W	8	\$570.00	\$815.00	\$1,005.00
116437	150 W	4	\$800.00	\$1,145.00	\$1,410.00
116438	200 W	4	\$950.00	\$1,355.00	\$1,675.00

CUMPLE CON LOS PARÁMETROS DE LA NOM-003-SCFI-2014

NOM

SENSOR LED



MI HOGAR **SEGURO**





CLASSIC LINE



De día la lámpara se mantiene apagada aun con movimiento

De noche la lámpara se enciende automáticamente cuando detecta movimiento



3 Años de garantía, BASE E27, Sensor de movimiento

CLASSIC LINE



Uso en camping, Uso como linterna



3 Años de garantía, BASE E27

CLASSIC LINE



3 Años de garantía, BASE E27, Sensor de movimiento

A19 LED con sensor de movimiento



CONSUME 9 W, ILUMINA 60 W

Table with columns: CÓDIGO, DISTRIB., MAYOREO, LISTA. Values: 120901, 10, 40, \$50.00, \$71.00, \$88.00

CUMPLE CON LOS PARÁMETROS DE LA NOM-030-ENER-2016 NOM

PROX. A19 de emergencia LED recargable



CONSUME 9 W, ILUMINA 60 W

- 1. Uso como foco de emergencia... 2. Uso con gancho... 3. Tocando el botón...

Table with columns: CÓDIGO, DISTRIB., MAYOREO, LISTA. Values: 120911, 10, 40, \$90.00, \$129.00, \$160.00

PROX. Luminario con sensor de movimiento



CONSUME 150 W

- Cuerpo de policarbonato, Ajuste de sensibilidad de luz, Cabezal giratorio, Ideales para iluminar jardines y patios, No incluye foco, 3 Modos ajustables: 1. Tiempo, 2. Sensibilidad de luz, 3. Detección de movimiento

Table with columns: CÓDIGO, DISTRIB., MAYOREO, LISTA. Values: 124924, 24, \$180.00, \$255.00, \$320.00; 124925, 24, \$180.00, \$255.00, \$320.00

CUMPLE CON LOS PARÁMETROS DE LA NOM-003-SCFI-2014 NOM



CLASSIC LINE

SMD
TECNOLOGÍA



CON SENSOR DE MOVIMIENTO



Extra plano

5 «»

Años de garantía Sensor de movimiento

CLASSIC LINE

SMD
TECNOLOGÍA



Extra plano

5 «»

Años de garantía Sensor de movimiento

Reflector con sensor de movimiento

100V~ 240V~	120° direccional	15 000 h de vida	IP65	Caja
8m Distancia máxima de detección	Soporte ajustable			
CONSUME 20 W	1 400 LUMENS	12 x 9 cm PROF. 2.7 cm		
CONSUME 30 W	2 100 LUMENS	16 x 12 cm PROF. 2.7 cm		
CONSUME 50 W	3 500 LUMENS	18 x 14 cm PROF. 2.7 cm		

- Discreto sensor de luz y movimiento
- Distancia máxima de detección de movimiento **8 m**
- Vidrio templado
- Diseño extra plano

BLANCA | 6 500 K

CÓDIGO	POTENCIA			DISTRIB.	MAYOREO	LISTA
116562	20 W	4	20	\$210.00	\$300.00	\$370.00
116563	30 W	2	10	\$245.00	\$350.00	\$430.00
116564	50 W	N/A	10	\$350.00	\$500.00	\$615.00

CUMPLE CON LOS PARÁMETROS DE LA NOM-003-SCFI-2014



PROX. Reflector solar con sensor de movimiento

120° direccional	15 000 h de vida	IP65	Caja
8m Distancia máxima de detección	Soporte ajustable		
800 LUMENS			

- Discreto sensor de luz movimiento
- Distancia máxima de detección de movimiento **8 m**
- Vidrio templado
- Cuerpo de aluminio
- Diseño extra plano
- Incluye batería

BLANCA | 6 500 K

CÓDIGO			DISTRIB.	MAYOREO	LISTA
116571	4	20	\$235.00	\$335.00	\$415.00

CUMPLE CON LOS PARÁMETROS DE LA NOM-003-SCFI-2014





CLASSIC LINE

Encendido al detectar movimiento, durante la oscuridad

DETECCIÓN LUZ Y MOVIMIENTO
MÁXIMO: 3 a 5 m



CLASSIC LINE

Encendido al detectar baja intensidad de luz

DETECCIÓN DE LUZ



CLASSIC LINE

Enciende al detectar movimiento

DETECCIÓN DE MOVIMIENTO
MÁXIMO: 3 a 5 m



3



BASE E27



Sensor de movimiento



Sensor de luz

Años de garantía

3



BASE E27



Sensor de luz

Años de garantía

3



BASE E27



Sensor de movimiento

Años de garantía

NUEVO

Alta potencia LED con sensor de luz y movimiento



CONSUME 20 W	LUMENS 2 000	ILUMINA 135 W	8 x 13.5 cm
CONSUME 30 W	LUMENS 3 000	ILUMINA 190 W	10 x 16.7 cm
CONSUME 40 W	LUMENS 4 000	ILUMINA 250 W	11.5 x 18.8 cm
CONSUME 50 W	LUMENS 5 000	ILUMINA 310 W	13.5 x 21.8 cm

BLANCA | 6 500 K

CÓDIGO	DISTRIB.	MAYOREO	LISTA
116426	4	\$125.00	\$180.00 \$220.00
116427	4	\$170.00	\$245.00 \$300.00
116428	4	\$190.00	\$270.00 \$335.00
116429	4	\$260.00	\$370.00 \$460.00

CUMPLE CON LOS PARÁMETROS DE LA NOM-030-ENER-2016



PROX.

Alta potencia LED con sensor de luz (fotocelda)



CONSUME 20 W	LUMENS 2 000	ILUMINA 135 W	8 x 13.5 cm
CONSUME 30 W	LUMENS 3 000	ILUMINA 190 W	10 x 16.7 cm
CONSUME 40 W	LUMENS 4 000	ILUMINA 250 W	11.5 x 18.8 cm
CONSUME 50 W	LUMENS 5 000	ILUMINA 310 W	13.5 x 21.8 cm

BLANCA | 6 500 K

CÓDIGO	DISTRIB.	MAYOREO	LISTA
116451	4	\$125.00	\$180.00 \$220.00
116452	4	\$170.00	\$245.00 \$300.00
116453	4	\$190.00	\$270.00 \$335.00
116454	4	\$260.00	\$370.00 \$460.00

CUMPLE CON LOS PARÁMETROS DE LA NOM-030-ENER-2016



PROX.

Alta potencia LED con sensor de movimiento



CONSUME 20 W	LUMENS 2 000	ILUMINA 135 W	8 x 13.5 cm
CONSUME 30 W	LUMENS 3 000	ILUMINA 190 W	10 x 16.7 cm
CONSUME 40 W	LUMENS 4 000	ILUMINA 250 W	11.5 x 18.8 cm
CONSUME 50 W	LUMENS 5 000	ILUMINA 310 W	13.5 x 21.8 cm

BLANCA | 6 500 K

CÓDIGO	DISTRIB.	MAYOREO	LISTA
116456	4	\$125.00	\$180.00 \$220.00
116457	4	\$170.00	\$245.00 \$300.00
116458	4	\$190.00	\$270.00 \$335.00
116459	4	\$260.00	\$370.00 \$460.00

CUMPLE CON LOS PARÁMETROS DE LA NOM-030-ENER-2016



VINTAGE LED



¡TIPS DE USO!



BOMBILLA AHUMADA



BOMBILLA APAGADA



1



Año de garantía BASE E27 BASE LED Bombilla AHUMADA

1



Año de garantía BASE E27 BASE LED Bombilla TEXTURA

1



Año de garantía BASE E27 Bombilla ÁMBAR



LED Globo Black & white

Ficha TÉCNICA



LED Globo Reventado

Ficha TÉCNICA



LED Vintage Leopardo

Ficha TÉCNICA



CÁLIDA | 2 700 K

CÓDIGO	DISTRIB.	MAYOREO	LISTA
122171	8	\$280.00	\$495.00

CÁLIDA | 2 700 K

CÓDIGO	DISTRIB.	MAYOREO	LISTA
122172	8	\$265.00	\$465.00

CÁLIDA | 2 200 K

CÓDIGO	DISTRIB.	MAYOREO	LISTA
122131	8	\$115.00	\$205.00



37 cm



1
Año de garantía

BASE E27

Bombilla TEXTURA

1
Año de garantía

BASE E27

Bombilla TEXTURA

1
Año de garantía

BASE E27

Bombilla ÁMBAR

LED Globo Júpiter

Ficha TÉCNICA

CONSUME 4 W

127 V ~ | 360° omnidireccional | 15 000 h de vida | 12 x 17 cm | Caja

CÁLIDA 2 200 K				
CÓDIGO	DISTRIB.	MAYOREO	LISTA	
122173	8	\$225.00	\$320.00	\$395.00

LED Globo Capricho

Ficha TÉCNICA

CONSUME 4 W

127 V ~ | 360° omnidireccional | 15 000 h de vida | 12 x 17 cm | Caja

CÁLIDA 2 200 K				
CÓDIGO	DISTRIB.	MAYOREO	LISTA	
122174	8	\$225.00	\$320.00	\$395.00

LED Globo Zepellin

Ficha TÉCNICA

CONSUME 8 W

127 V ~ | 360° omnidireccional | 15 000 h de vida | 17.5 x 37 cm | Caja

CÁLIDA 2 200 K				
CÓDIGO	DISTRIB.	MAYOREO	LISTA	
122135	4	\$540.00	\$770.00	\$955.00



LED Vintage Pumpkin

Ficha TÉCNICA



LED Vintage Telaraña

Ficha TÉCNICA



LED Vintage Espejo

Ficha TÉCNICA



CÁLIDA 2 200 K				
CÓDIGO	DI	DISTRIB.	MAYOREO	LISTA
122133	8	\$170.00	\$245.00	\$300.00

CÁLIDA 2 200 K				
CÓDIGO	DI	DISTRIB.	MAYOREO	LISTA
122132	8	\$155.00	\$220.00	\$275.00

CÁLIDA 2 700 K				
CÓDIGO	DI	DISTRIB.	MAYOREO	LISTA
122115	8	\$95.00	\$136.00	\$170.00



1
Año de garantía
BASE E27
Bombilla ÁMBAR

1
Año de garantía
BASE E27
Bombilla ÁMBAR

1
Año de garantía
BASE E27
Bombilla ÁMBAR

LED Vintage Infiniti

Ficha TÉCNICA



127 V ~ 360° omnidireccional 15 000 h de vida 12,5 x 17,5 cm Caja

CÁLIDA | 2 200 K
CÓDIGO 122114
DISTRIB. 8
MAYOREO \$125.00 \$180.00
LISTA \$220.00

LED Vintage Pirámide

Ficha TÉCNICA



127 V ~ 360° omnidireccional 15 000 h de vida 12,5 x 17,5 cm Caja

CÁLIDA | 2 200 K
CÓDIGO 122111
DISTRIB. 8
MAYOREO \$75.00 \$107.00
LISTA \$132.00

LED Vintage ADN

Ficha TÉCNICA



127 V ~ 360° omnidireccional 15 000 h de vida 12,5 x 17,5 cm Caja

CÁLIDA | 2 200 K
CÓDIGO 122112
DISTRIB. 8
MAYOREO \$125.00 \$180.00
LISTA \$220.00



1



Año de garantía

BASE E27

Bombilla ÁMBAR

1



Año de garantía

BASE E27

Bombilla ÁMBAR

1



Año de garantía

BASE E27

Bombilla ÁMBAR



LED Vintage XO espiral

Ficha TÉCNICA



127 V ~

360° omnidireccional

15 000 h de vida

12,5 x 17,5 cm

Caja

CÁLIDA | 2 200 K

CÓDIGO
122113

DISTRIB.
8

MAYOREO
\$125.00

LISTA
\$180.00

\$220.00



LED Vintage Botella constelación

Ficha TÉCNICA



127 V ~

360° omnidireccional

15 000 h de vida

8 x 22,5 cm

Caja

CÁLIDA | 2 200 K

CÓDIGO
122141

DISTRIB.
8

MAYOREO
\$180.00

LISTA
\$255.00

\$320.00



LED Vintage Botella Miami

Ficha TÉCNICA



127 V ~

360° omnidireccional

15 000 h de vida

8 x 22 cm

Caja

CÁLIDA | 2 200 K

CÓDIGO
122142

DISTRIB.
8

MAYOREO
\$200.00

LISTA
\$285.00

\$355.00



1
Año de garantía

BASE E27

Bombilla AHUMADA

1
Año de garantía

BASE E27

Bombilla ÁMBAR

1
Año de garantía

BASE E27

Bombilla AHUMADA

LED Smoke Mazorca

Ficha TÉCNICA

CONSUME 5 W

127 V ~ 360° omnidireccional 15 000 h de vida 6.4 x 14 cm Caja

CÁLIDA | 2 200 K

CÓDIGO	4	24	DISTRIB.	MAYOREO	LISTA
122105			\$50.00	\$71.00	\$88.00

LED Vintage Mazorca

Ficha TÉCNICA

CONSUME 5 W

127 V ~ 360° omnidireccional 15 000 h de vida 6.4 x 14 cm Caja

CÁLIDA | 2 200 K

CÓDIGO	4	24	DISTRIB.	MAYOREO	LISTA
122101			\$45.00	\$64.00	\$79.00

LED Smoke Globo

Ficha TÉCNICA

CONSUME 4 W

127 V ~ 360° omnidireccional 15 000 h de vida 8 x 11.7 cm Caja

CÁLIDA | 2 200 K

CÓDIGO	4	24	DISTRIB.	MAYOREO	LISTA
122106			\$50.00	\$71.00	\$88.00

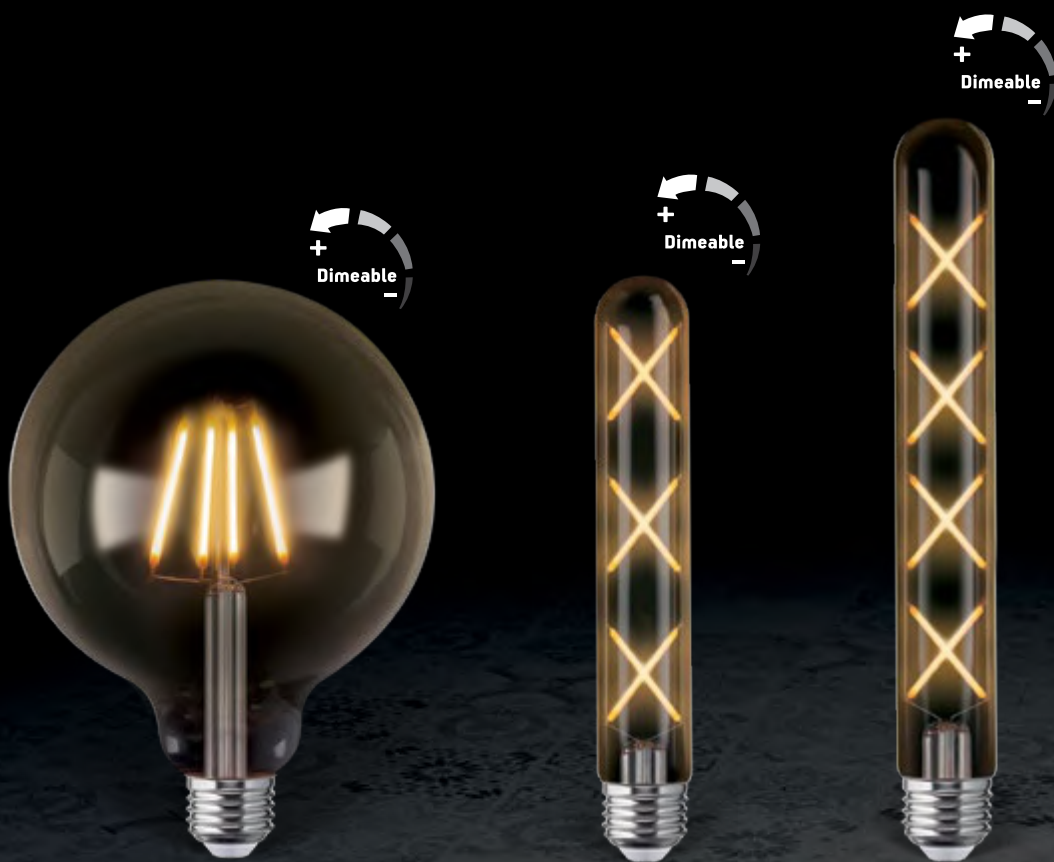

1



Año de garantía

BASE E27

Bombilla ÁMBAR

1



Año de garantía

BASE E27

Bombilla ÁMBAR

1



Año de garantía

BASE E27

Bombilla ÁMBAR



LED Vintage Globo

Ficha TÉCNICA



LED Vintage Ampolleta X3

Ficha TÉCNICA



LED Vintage Ampolleta X4

Ficha TÉCNICA



CÁLIDA | 2 200 K

CÁLIDA | 2 200 K

CÁLIDA | 2 200 K

CÓDIGO	4	24	DISTRIB.	MAYOREO	LISTA
122102			\$45.00	\$64.00	\$79.00

CÓDIGO	6	60	DISTRIB.	MAYOREO	LISTA
122122			\$115.00	\$165.00	\$205.00

CÓDIGO	6	60	DISTRIB.	MAYOREO	LISTA
122121			\$130.00	\$185.00	\$230.00

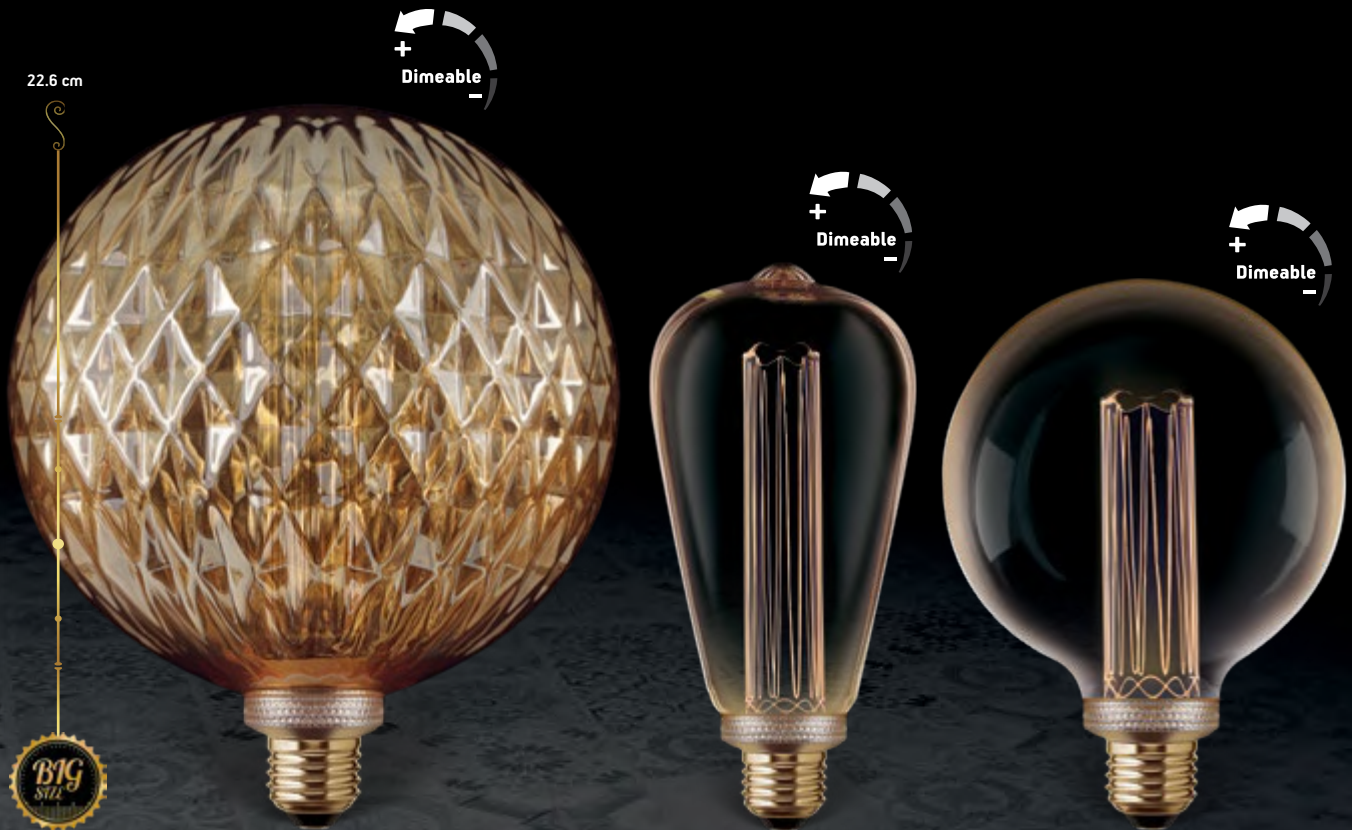

1
Año de garantía
BASE E27
Bombilla ÁMBAR

1
Año de garantía
BASE E27
Bombilla ÁMBAR

1
Año de garantía
BASE E27
Bombilla ÁMBAR

LED Vintage
Globo panel

Ficha TÉCNICA

CONSUME **3.5 W**

127 V ~ 360° omnidireccional 15 000 h de vida 18.3 x 22.6 cm Caja

CÁLIDA 1 800 K				
CÓDIGO	DISTRIB.	MAYOREO	LISTA	
122163	4	\$375.00	\$535.00	\$660.00

LED Vintage
Mazorca tornado

Ficha TÉCNICA

CONSUME **4 W**

127 V ~ 360° omnidireccional 15 000 h de vida 6.3 x 14.3 cm Caja

CÁLIDA 1 800 K				
CÓDIGO	DISTRIB.	MAYOREO	LISTA	
122151	6 36	\$160.00	\$230.00	\$280.00

LED Vintage
Globo tornado

Ficha TÉCNICA

CONSUME **4 W**

127 V ~ 360° omnidireccional 15 000 h de vida 9.4 x 14.3 cm Caja

CÁLIDA 2 200 K				
CÓDIGO	DISTRIB.	MAYOREO	LISTA	
122152	6 36	\$175.00	\$250.00	\$310.00

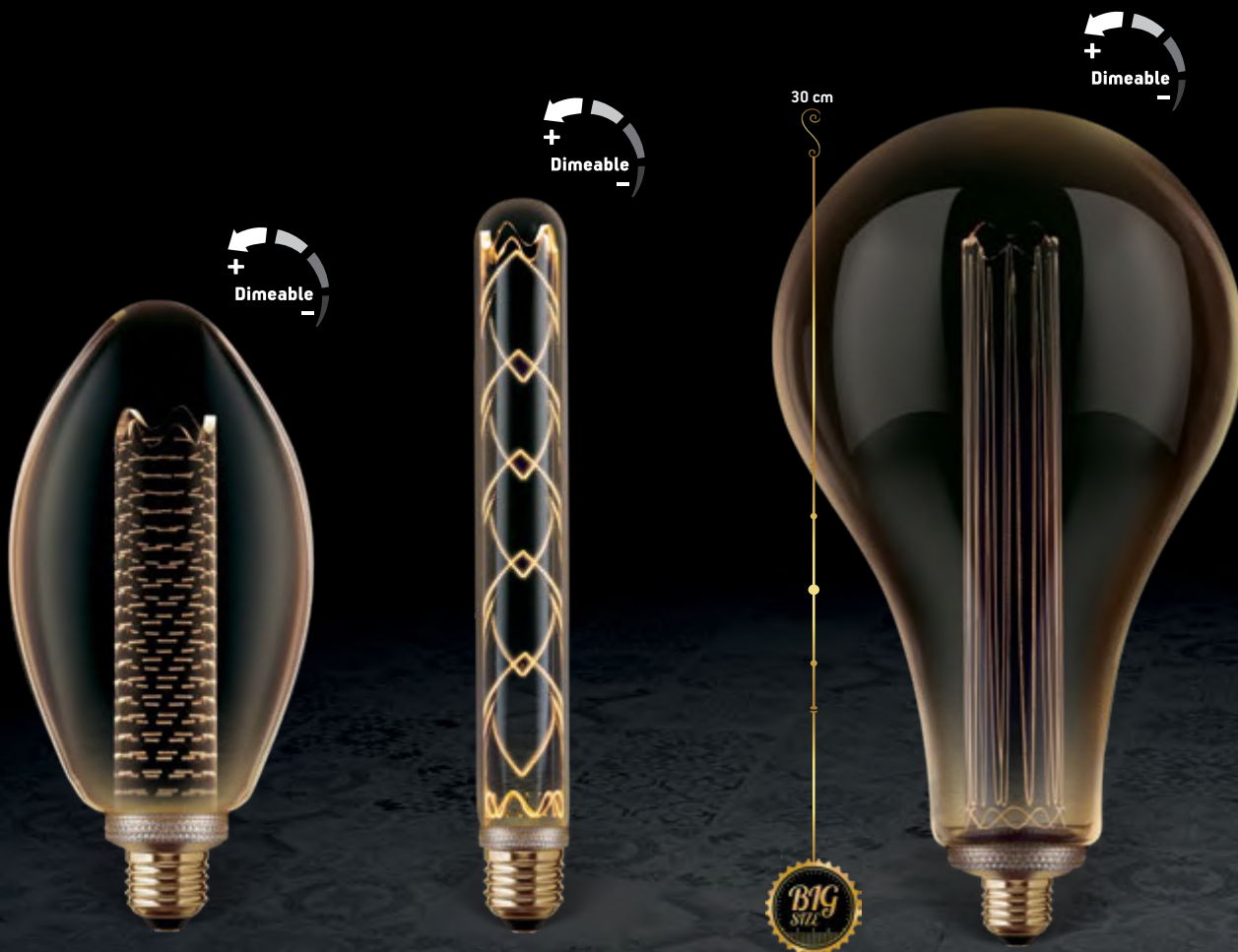

1
Año de garantía

BASE E27

Bombilla ÁMBAR

1
Año de garantía

BASE E27

Bombilla ÁMBAR

1
Año de garantía

BASE E27

Bombilla ÁMBAR



LED Vintage Vela tornado

Ficha TÉCNICA

CONSUME 4 W

127 V ~ | 360° omnidireccional | 15 000 h de vida | 7.5 x 16.3 cm | Caja



LED Vintage Ampolleta

Ficha TÉCNICA

CONSUME 2.3 W

127 V ~ | 360° omnidireccional | 15 000 h de vida | 3 x 18.4 cm | Caja



LED Vintage Lava

Ficha TÉCNICA

CONSUME 3.5 W

127 V ~ | 360° omnidireccional | 15 000 h de vida | 16.2 x 30 cm | Caja

CÁLIDA | 1 800 K

CÓDIGO	6	36	DISTRIB.	MAYOREO	LISTA
122164			\$150.00	\$215.00	\$265.00

CÁLIDA | 1 800 K

CÓDIGO	8	80	DISTRIB.	MAYOREO	LISTA
122161			\$160.00	\$230.00	\$280.00

CÁLIDA | 1 800 K

CÓDIGO	4	DISTRIB.	MAYOREO	LISTA
122162		\$390.00	\$555.00	\$690.00

COLOR LED



CLASSIC LINE

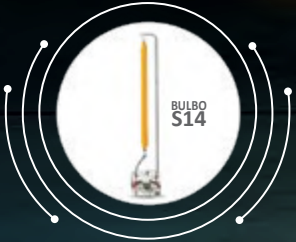

1



Año de garantía BASE E27

CLASSIC LINE

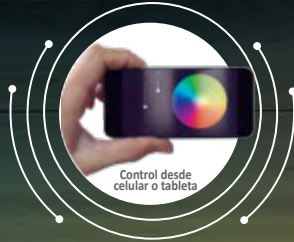

1



Descarga alguna de las dos Apps

Portalámpara en serie con 12 ó 24 lámparas S14 cálidas

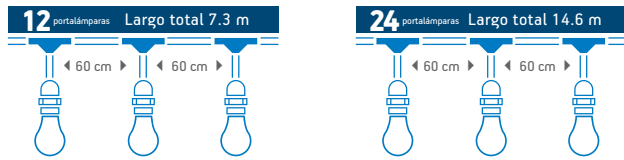

CÁLIDA 2 700 K						
CÓDIGO	LÁMPARAS	POTENCIA		DISTRIB.	MAYOREO	LISTA
118271	12	12 W	4	\$500.00	\$715.00	\$880.00
118273	24	11 W	4	\$900.00	\$1,285.00	\$1,590.00

Portalámpara en serie para 12 ó 24 lámparas (NO incluidas)



CÓDIGO	PORTALÁMPARAS		DISTRIB.	MAYOREO	LISTA
118272	12	8	\$415.00	\$595.00	\$730.00
118274	24	4	\$700.00	\$1,000.00	\$1,235.00

CUMPLE CON LOS PARÁMETROS DE LA NOM-003-SCFI-2014



Serie inteligente LED RGB 12 lámparas



- Las lámparas LED no son reemplazables. No incluye control.
- Descarga la aplicación *Tuya Smart* o *Smart Life* a tu celular o tableta electrónica y controla tu serie inteligente sin mayor esfuerzo (encendido, apagado, intensidad, color, etc).
- Compatible con asistentes de voz:



RGB Tecnología inteligente LED						
CÓDIGO	PORTALÁMPARAS	POTENCIA		DISTRIB.	MAYOREO	LISTA
118275	12	11 W	4	\$1,750.00	\$2,500.00	\$3,085.00

CUMPLE CON LOS PARÁMETROS DE LA NOM-003-SCFI-2014





1
Año de garantía

E27
BASE E27

Bombilla TRASLÚCIDA

1
Año de garantía

E27
BASE E27

Bombilla de color TRASLÚCIDA

FILAMENTOS LED colores

CONSUME **4 W**

127 V ~
 360° omnidireccional
 15 000 h de vida
 6 x 10.5 cm
 Caja

COLORES						
CÓDIGO	COLOR	10	36	DISTRIB.	MAYOREO	LISTA
122222	Azul	6	36	\$30.00	\$43.00	\$53.00
122223	Rojo	6	36	\$30.00	\$43.00	\$53.00
122224	Verde	6	36	\$30.00	\$43.00	\$53.00
122225	Amarillo	6	36	\$30.00	\$43.00	\$53.00
122226	Morado	6	36	\$30.00	\$43.00	\$53.00

S14 LED colores

CONSUME **1 W**

127 V ~
 360° omnidireccional
 15 000 h de vida
 4.5 x 8.4 cm
 Caja

Ideales para la portalámpara en serie LED 118272 y 118274

CÁLIDA 3 000 K						COLORES						
CÓDIGO	10	100	DISTRIB.	MAYOREO	LISTA	CÓDIGO	COLOR	10	100	DISTRIB.	MAYOREO	LISTA
122212	10	100	\$12.00	\$17.10	\$21.20	122213	Azul	10	100	\$12.00	\$17.10	\$21.20
						122214	Rojo	10	100	\$12.00	\$17.10	\$21.20
						122215	Verde	10	100	\$12.00	\$17.10	\$21.20
						122216	Amarillo	10	100	\$12.00	\$17.10	\$21.20
						122217	Lila	10	100	\$12.00	\$17.10	\$21.20
						122218	Naranja	10	100	\$12.00	\$17.10	\$21.20

Los productos de alta rotación se encuentran distinguidos por el color rojo en su código. La apariencia del producto puede llegar a variar • Ventas y atención a clientes 55-5383-4412



Caja con 50 focos.



Caja con 50 focos
Incluye 10 focos de cada color.

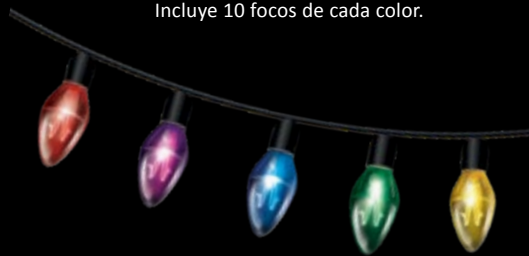

1

Año de garantía



BASE E12



Bombilla TRASLÚCIDA

1

Año de garantía



BASE E12



Bombilla de color TRASLÚCIDA

VELA 50 pack INCANDESCENTE Bombilla traslúcida

· Presentación en caja con 50 focos.

CONSUME 7 W



CÁLIDA | 2 700 K

CÓDIGO	DISTRIB.	MAYOREO	LISTA
122271	10 packs	\$110.00	\$195.00

VELA 50 pack INCANDESCENTE Bombilla de colores traslúcidos

· Presentación en caja con 50 focos.

CONSUME 7 W



COLORES

CÓDIGO	DISTRIB.	MAYOREO	LISTA
122272	10 packs	\$110.00	\$195.00



122251
Opaco

122261
Traslúcido



122252

122253



122262

122263



122254

122255

122256



122264

122265

122266

3



Año de garantía BASE E12

1



Año de garantía BASE E12 Bombilla de color OPACA

1



Año de garantía BASE E12 Bombilla de color TRASLÚCIDA

VELA 2 pack Bombilla opaca o traslúcida

· Presentación en caja con 2 focos.

CONSUME 0.5 W

ILUMINA 25 W



CÁLIDA | 2 700 K

CÓDIGO	COLOR	12 packs	144 packs	DISTRIB.	MAYOREO	LISTA
122251	Opaco	12 packs	144 packs	\$19.00	\$27.00	\$34.00
122261	Traslúcido	12 packs	144 packs	\$19.00	\$27.00	\$34.00

BLANCA | 6 500 K

CÓDIGO	COLOR	12 packs	144 packs	DISTRIB.	MAYOREO	LISTA
122257	Opaco	12 packs	144 packs	\$19.00	\$27.00	\$34.00
122267	Traslúcido	12 packs	144 packs	\$19.00	\$27.00	\$34.00

CUMPLE CON LOS PARÁMETROS DE LA NOM-030-ENER-2016 **NOM**

VELA 2 pack LED Bombilla de colores solidos

· Presentación en caja con 2 focos.

CONSUME 0.5 W



COLORES

CÓDIGO	COLOR	12 packs	144 packs	DISTRIB.	MAYOREO	LISTA
122252	Azul	12 packs	144 packs	\$19.00	\$27.00	\$34.00
122253	Rojo	12 packs	144 packs	\$19.00	\$27.00	\$34.00
122254	Verde	12 packs	144 packs	\$19.00	\$27.00	\$34.00
122255	Amarillo	12 packs	144 packs	\$19.00	\$27.00	\$34.00
122256	Lila	12 packs	144 packs	\$19.00	\$27.00	\$34.00

VELA 2 pack LED Bombilla de colores traslúcida

· Presentación en caja con 2 focos.

CONSUME 0.5 W



COLORES

CÓDIGO	COLOR	12 packs	144 packs	DISTRIB.	MAYOREO	LISTA
122262	Azul	12 packs	144 packs	\$19.00	\$27.00	\$34.00
122263	Rojo	12 packs	144 packs	\$19.00	\$27.00	\$34.00
122264	Verde	12 packs	144 packs	\$19.00	\$27.00	\$34.00
122265	Amarillo	12 packs	144 packs	\$19.00	\$27.00	\$34.00
122266	Lila	12 packs	144 packs	\$19.00	\$27.00	\$34.00

Los productos de alta rotación se encuentran distinguidos por el color rojo en su código.
La apariencia del producto puede llegar a variar · Ventas y atención a clientes 55-5383-4412



ILUMINACIÓN DECORATIVA



¡UN VISTAZO AL FOCO ENCENDIDO!



122293 122294 122298 122296 122297



122283 122285 122286 122284 122286 122287

1
Año de garantía
BASE E27
Bombilla TRASLÚCIDA

1
Año de garantía
BASE E27
Bombilla TRASLÚCIDA

PROX. ● Estela de luz A19 LED

Foco decorativo con efecto visual de una estela.

CONSUME 1 W



 127 V ~ |
  360° omnidireccional |
  15 000 h de vida |
  6 x 10,4 cm |
  Caja |
 Ideales para la portalámpara en serie LED 118272 y 118274

Estela de luz S14 LED

Foco decorativo con efecto visual de una estela. ¡Echa un vistazo al video!

CONSUME 1 W



 127 V ~ |
  360° omnidireccional |
  15 000 h de vida |
  4,5 x 8,4 cm |
  Caja |
 Ideales para la portalámpara en serie LED 118272 y 118274

CÁLIDA 3 000 K					COLORES							
CÓDIGO	📦	📦	DISTRIB.	MAYOREO	LISTA	CÓDIGO	COLOR	📦	📦	DISTRIB.	MAYOREO	LISTA
122292	10	100	\$40.00	\$57.00	\$71.00	122293	Azul	10	100	\$40.00	\$57.00	\$71.00
						122294	Rojo	10	100	\$40.00	\$57.00	\$71.00
						122295	Verde	10	100	\$40.00	\$57.00	\$71.00
						122296	Amarillo	10	100	\$40.00	\$57.00	\$71.00
						122297	Lila	10	100	\$40.00	\$57.00	\$71.00
						122298	Naranja	10	100	\$40.00	\$57.00	\$71.00

BLANCA 6 500 K					
CÓDIGO	📦	📦	DISTRIB.	MAYOREO	LISTA
122291	10	100	\$40.00	\$57.00	\$71.00

CÁLIDA 3 000 K					COLORES							
CÓDIGO	📦	📦	DISTRIB.	MAYOREO	LISTA	CÓDIGO	COLOR	📦	📦	DISTRIB.	MAYOREO	LISTA
122282	10	100	\$30.00	\$43.00	\$53.00	122283	Azul	10	100	\$30.00	\$43.00	\$53.00
						122284	Rojo	10	100	\$30.00	\$43.00	\$53.00
						122285	Verde	10	100	\$30.00	\$43.00	\$53.00
						122286	Amarillo	10	100	\$30.00	\$43.00	\$53.00
						122287	Lila	10	100	\$30.00	\$43.00	\$53.00
						122288	Naranja	10	100	\$30.00	\$43.00	\$53.00

BLANCA 6 500 K					
CÓDIGO	📦	📦	DISTRIB.	MAYOREO	LISTA
122281	10	100	\$30.00	\$43.00	\$53.00



122242

122243

122244



122241



APAGADO

ENCENDIDO

1



Año de garantía

BASE E27

1



Año de garantía

BASE E27

PAR 38 LED IP65 colores

CONSUME 12 W



CÓDIGO	COLOR	6	12	DISTRIB.	MAYOREO	LISTA
122241	Azul	6	12	\$75.00	\$107.00	\$132.00
122242	Rojo	6	12	\$75.00	\$107.00	\$132.00
122243	Verde	6	12	\$75.00	\$107.00	\$132.00
122244	Amarillo	6	12	\$75.00	\$107.00	\$132.00

3D LED Mazorca

Ilumina en tono blanco - menta lo que genera un efecto de profundidad a las figuras de estrella.

CONSUME 3.5 W



CÓDIGO	6	24	DISTRIB.	MAYOREO	LISTA
122231	6	24	\$99.00	\$141.00	\$175.00



1

Año de garantía



BASE E27

1

Año de garantía



BASE E27

Incandescente Para horno y refrigerador

CONSUME **40 W**

127 V ~	360° omnidireccional	15 000 h de vida	4.5 x 6.9 cm	Caja
---------	-------------------------	---------------------	--------------	------

CÓDIGO			DISTRIB.	MAYOREO	LISTA
123911	10	100	\$6.00	\$8.60	\$10.60

Lámpara INCANDESCENTE Para mantener calientes los alimentos, tipo BR40

CONSUME **250 W**

127 V ~	35° direccional	2 000 h de vida	12.4 x 16.5 cm	Caja
---------	--------------------	--------------------	----------------	------

CÁLIDA 2 700 K					
CÓDIGO			DISTRIB.	MAYOREO	LISTA
123921	4	24	\$50.00	\$71.00	\$88.00



BOMBILLA APAGADA

1

Año de garantía



BASE E27

Repelente DE INSECTOS

CONSUME 7 W



El foco repelente de mosquitos emite una longitud de onda superior a los 550 nm, prácticamente invisible al ojo humano pero haciendo difícil la visión del insecto, lo cual provoca que estos se alejen de la zona.

CÁLIDA | 1 800 K

CÓDIGO			DISTRIB.	MAYOREO	LISTA
123901	4	32	\$40.00	\$57.00	\$71.00

CUMPLE CON LOS PARÁMETROS DE LA NOM-030-ENER-2016



Los productos de alta rotación se encuentran distinguidos por el color rojo en su código. La apariencia del producto puede llegar a variar • Ventas y atención a clientes 55-5383-4412



AMBIENTES vibrantes

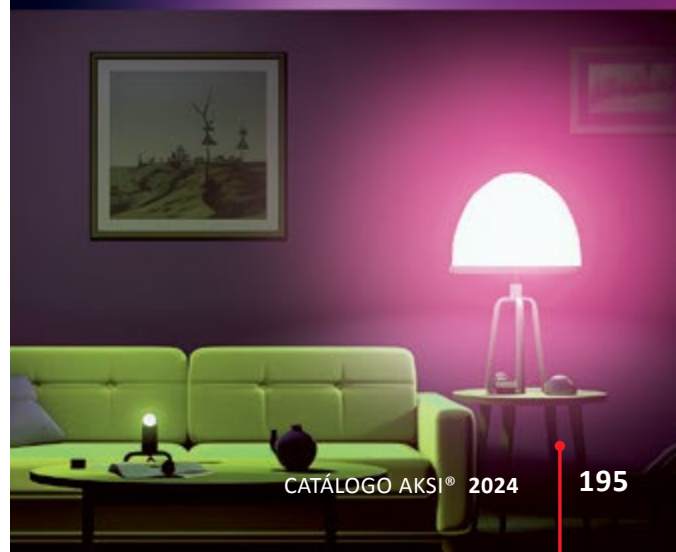

TIRA LED

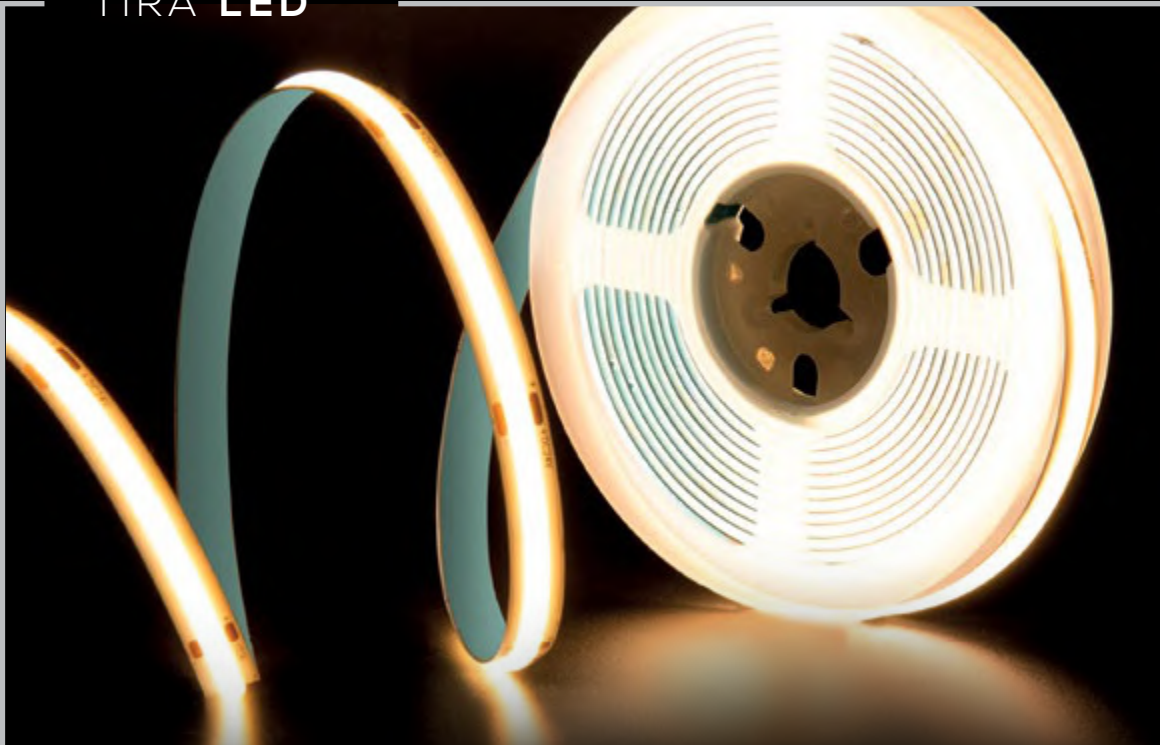

Cómo elegir una tira LED?

CANTIDAD DE LED (LED/m)

Las tiras más comunes se encuentran en presentaciones de 30, 60 y 120 LEDs por cada metro



TIPO DE CHIP

Los más comunes son:

SMD 2835: Chip pequeño y de luminosidad baja, 1 núcleo

SMD 5050: Uno de los más comunes, alta luminosidad, multinúcleo



SMD 2835

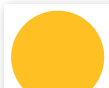

SMD 5050

GENERACIÓN DE COLOR

Monocromáticas - generan un solo color

RGB - generan múltiples colores

Híbridas - integran chips que generan múltiples tonalidades + blanco

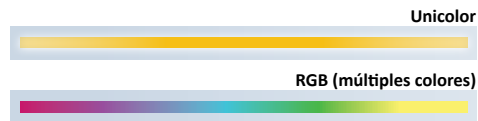

POR GRADO DE PROTECCIÓN

Para proteger las tiras les colocan distintos tipos de aislamiento según la aplicación, generalmente se basa en un recubrimiento plástico a lo largo de la tira envolviendo completamente los diodos LED y su electrónica complementaria



SMD 2835 - interiores

SMD 2835 - siliconizada



TIRAS LED SMD CLASSIC



Imperceptible disminución de luz de inicio a fin

- Cinta sencilla
- Bajo costo



1
Año de garantía

SMD 2835 - interiores



1
Año de garantía

SMD 2835 - siliconizada

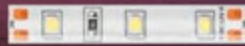

1
Año de garantía

SMD 2835 RGB - siliconizada



Tira LED PARA INTERIOR Unicolor 5m

100V~ 240V~ |
 12V DC |
 5 000 h de vida |
 SMD 2835 |
 60 LEDs x m |
 5 m |
 Caja

- Flexible y fácil de instalar
- Para uso en interiores
- Puede cortarse cada 5 cm
- Incluye adaptador de 100 V~ - 240 V~

BLANCA 6 500 K						
CÓDIGO	POTENCIA			DISTRIB.	MAYOREO	LISTA
128611	6.5 W	12	48	\$135.00	\$195.00	\$240.00

CÁLIDA 2 700 K						
CÓDIGO	POTENCIA			DISTRIB.	MAYOREO	LISTA
128612	6.5 W	12	48	\$135.00	\$195.00	\$240.00

ÁMBAR 2 200 K						
CÓDIGO	POTENCIA			DISTRIB.	MAYOREO	LISTA
128613	6.5 W	12	48	\$135.00	\$195.00	\$240.00

CUMPLE CON LOS PARÁMETROS DE LA NOM-003-SCFI-2014 **NOM**

Tira LED PARA EXTERIOR Unicolor 5m

100V~ 240V~ |
 12V DC |
 5 000 h de vida |
 IPX6 contra el agua |
 SMD 2835 |
 60 LEDs x m |
 5 m |
 Caja

- Flexible y fácil de instalar
- Resistente al agua
- Para uso en interiores y exteriores
- Puede cortarse cada 5 cm
- Incluye adaptador de 100 V~ - 240 V~

BLANCA 6 500 K						
CÓDIGO	POTENCIA			DISTRIB.	MAYOREO	LISTA
128601	6.5 W	12	48	\$170.00	\$245.00	\$300.00

CÁLIDA 2 700 K						
CÓDIGO	POTENCIA			DISTRIB.	MAYOREO	LISTA
128602	6.5 W	12	48	\$170.00	\$245.00	\$300.00

ÁMBAR 2 200 K						
CÓDIGO	POTENCIA			DISTRIB.	MAYOREO	LISTA
128603	6.5 W	12	48	\$170.00	\$245.00	\$300.00

CUMPLE CON LOS PARÁMETROS DE LA NOM-003-SCFI-2014 **NOM**

Tira RGB LED PARA EXTERIOR Multicolor 5m

100V~ 240V~ |
 12V DC |
 5 000 h de vida |
 IPX6 contra el agua |
 SMD 2835 |
 60 LEDs x m |
 5 m |
 Caja

- Ideal para utilizarse como luz falsa
- Flexible y fácil de instalar
- Resistente al agua
- Para uso en interiores y exteriores
- Puede cortarse cada 17 cm
- Incluye adaptador de 100 V~ - 240 V~

RGB Tecnología LED SMD 2835						
CÓDIGO	POTENCIA			DISTRIB.	MAYOREO	LISTA
128621	12 W	12	48	\$215.00	\$305.00	\$380.00

CUMPLE CON LOS PARÁMETROS DE LA NOM-003-SCFI-2014 **NOM**



TIRAS LED SMD PRO

Iluminación continua de inicio a fin



Cinta resistente



1

Año de garantía

SMD 2835 - interiores



1

Año de garantía

SMD 2835 - siliconizada

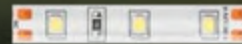

Tira LED PARA INTERIOR
Unicolor 5m



- Flexible y fácil de instalar
- Para uso en interiores
- Puede cortarse cada 5 cm
- Incluye cinta adhesiva para montaje
- Incluye adaptador de 100 V~ - 240 V~

BLANCA 6 500 K						
CÓDIGO	POTENCIA	📦	📦	DISTRIB.	MAYOREO	LISTA
118211	16 W	4	24	\$180.00	\$255.00	\$320.00
CÁLIDA 2 700 K						
CÓDIGO	POTENCIA	📦	📦	DISTRIB.	MAYOREO	LISTA
118212	16 W	4	24	\$180.00	\$255.00	\$320.00
ÁMBAR 2 200 K						
CÓDIGO	POTENCIA	📦	📦	DISTRIB.	MAYOREO	LISTA
118216	16 W	4	24	\$180.00	\$255.00	\$320.00
AZUL						
CÓDIGO	POTENCIA	📦	📦	DISTRIB.	MAYOREO	LISTA
118213	16 W	4	24	\$180.00	\$255.00	\$320.00
ROJO						
CÓDIGO	POTENCIA	📦	📦	DISTRIB.	MAYOREO	LISTA
118214	16 W	4	24	\$180.00	\$255.00	\$320.00
VERDE						
CÓDIGO	POTENCIA	📦	📦	DISTRIB.	MAYOREO	LISTA
118215	16 W	4	24	\$180.00	\$255.00	\$320.00

CUMPLE CON LOS PARÁMETROS DE LA NOM-003-SCFI-2014



Tira LED PARA EXTERIOR
Unicolor 5m



- Flexible y fácil de instalar
- Resistente al agua
- Para uso en interiores y exteriores
- Puede cortarse cada 5 cm
- Incluye cinta adhesiva para montaje
- Incluye adaptador de 100 V~ - 240 V~

BLANCA 6 500 K						
CÓDIGO	POTENCIA	📦	📦	DISTRIB.	MAYOREO	LISTA
118201	16 W	4	24	\$215.00	\$305.00	\$380.00
CÁLIDA 2 700 K						
CÓDIGO	POTENCIA	📦	📦	DISTRIB.	MAYOREO	LISTA
118202	16 W	4	24	\$215.00	\$305.00	\$380.00
ÁMBAR 2 200 K						
CÓDIGO	POTENCIA	📦	📦	DISTRIB.	MAYOREO	LISTA
118206	16 W	4	24	\$215.00	\$305.00	\$380.00
AZUL						
CÓDIGO	POTENCIA	📦	📦	DISTRIB.	MAYOREO	LISTA
118203	16 W	4	24	\$215.00	\$305.00	\$380.00
ROJO						
CÓDIGO	POTENCIA	📦	📦	DISTRIB.	MAYOREO	LISTA
118204	16 W	4	24	\$215.00	\$305.00	\$380.00
VERDE						
CÓDIGO	POTENCIA	📦	📦	DISTRIB.	MAYOREO	LISTA
118205	16 W	4	24	\$215.00	\$305.00	\$380.00

CUMPLE CON LOS PARÁMETROS DE LA NOM-003-SCFI-2014





TIRAS RGB LED SMD PRO

CLASSIC LINE



1
Año de garantía
SMD 2835 RGB - siliconada

1
Año de garantía
SMD 5050 RGB - siliconada

1
Año de garantía
SMD 5050

Tira RGB LED PARA EXTERIOR Multicolor 5m

Tira RGB LED PARA EXTERIOR Multicolor 5m

Manguera LED PARA EXTERIOR Unicolor 5m

100V~ 240V~
 12V~
 30 000 h de vida
 IPX6 contra el agua
 SMD 3528
 16 colores
 60 LEDs x m
 5 m
 Blíster

100V~ 240V~
 12V~
 30 000 h de vida
 IPX6 contra el agua
 SMD 5050
 16 colores
 60 LEDs x m
 5 m
 Blíster

127V~
 30 000 h de vida
 IPX6 contra el agua
 SMD 5050 cód. 18232
 60 LEDs x m
 5 m
 Blíster

- Incluye control remoto programa 16 colores
- 4 modos de iluminación e intensidad
- Fléxible y fácil de instalar
- Resistente al agua
- Para uso en interiores y exteriores
- Puede cortarse cada 15 cm
- Incluye cinta adhesiva para montaje
- Incluye adaptador de 100 V~ - 240 V~

- Ideal para utilizarse como luz falsa (cód. 118231)
- Incluye control remoto programa 16 colores
- 4 modos de iluminación e intensidad
- Fléxible y fácil de instalar
- Resistente al agua
- Para uso en interiores y exteriores
- Puede cortarse cada 5 cm
- Incluye cinta adhesiva para montaje
- Incluye adaptador de 100 V~ - 240 V~

- Flexible y fácil de instalar
- Máxima resistencia al agua e intemperie
- Para uso en interiores y exteriores
- Puede cortarse cada 50 cm
- Incluye grapas para instalación
- No requiere transformador por lo que se puede conectar directamente a la corriente eléctrica (127 V~)

RGB Tecnología LED SMD 3528						
CÓDIGO	POTENCIA			DISTRIB.	MAYOREO	LISTA
118231	12 W	4	24	\$285.00	\$405.00	\$505.00

RGB Tecnología LED SMD 5050						
CÓDIGO	POTENCIA			DISTRIB.	MAYOREO	LISTA
118232	24 W	4	24	\$430.00	\$615.00	\$760.00

BLANCA 6 500 K						
CÓDIGO	POTENCIA			DISTRIB.	MAYOREO	LISTA
118251	40 W	4	24	\$330.00	\$470.00	\$580.00
CÁLIDA 2 700 K						
CÓDIGO	POTENCIA			DISTRIB.	MAYOREO	LISTA
118252	40 W	4	24	\$330.00	\$470.00	\$580.00
ÁMBAR 2 200 K						
CÓDIGO	POTENCIA			DISTRIB.	MAYOREO	LISTA
118253	40 W	4	24	\$330.00	\$470.00	\$580.00

CUMPLE CON LOS PARÁMETROS DE LA NOM-003-SCFI-2014



CUMPLE CON LOS PARÁMETROS DE LA NOM-003-SCFI-2014



CUMPLE CON LOS PARÁMETROS DE LA NOM-003-SCFI-2014



TIRAS LED COB DIMEABLES

Diferencia

SMD



COB



Control desde celular o tableta

1 Año de garantía

COB - dimeable - siliconizada

1 Año de garantía

COB - dimeable smart - siliconizada

Descarga alguna de las dos App

PROX. ●
Tira LED DIMEABLE
Unicolor 5m

100V~ 240V~ | 12V ~ | 30 000 h de vida | CHIP COB | EXTERIORES IP65 | 576 CHIPS x m | 5 m | Caja

- Flexible y fácil de instalar
- Para uso en interiores
- Puede cortarse cada 3.5 cm
- Incluye cinta adhesiva para montaje
- Incluye adaptador de 100 V~ - 240 V~
- Incluye control

BLANCA 6 500 K						
CÓDIGO	POTENCIA	📦	📦	DISTRIB.	MAYOREO	LISTA
128631	10 W	4	24	\$450.00	\$645.00	\$795.00
CÁLIDA 2 700 K						
CÓDIGO	POTENCIA	📦	📦	DISTRIB.	MAYOREO	LISTA
128632	10 W	4	24	\$450.00	\$645.00	\$795.00

CUMPLE CON LOS PARÁMETROS DE LA NOM-003-SCFI-2014



PROX. ●
Tira LED SMART DIMEABLE
Unicolor 5m

100V~ 240V~ | 12V ~ | 30 000 h de vida | CHIP COB | EXTERIORES IP65 | 576 CHIPS x m | 5 m | Caja

- Flexible y fácil de instalar
- Para uso en interiores
- Puede cortarse cada 3.5 cm
- Incluye cinta adhesiva para montaje
- Incluye adaptador de 100 V~ - 240 V~
- Incluye control
- Smart, se controla desde el celular
- Funciona al ritmo de la música

BLANCA 6 500 K						
CÓDIGO	POTENCIA	📦	📦	DISTRIB.	MAYOREO	LISTA
118641	10 W	4	24	\$525.00	\$750.00	\$925.00
CÁLIDA 2 700 K						
CÓDIGO	POTENCIA	📦	📦	DISTRIB.	MAYOREO	LISTA
118642	10 W	4	24	\$525.00	\$750.00	\$925.00

CUMPLE CON LOS PARÁMETROS DE LA NOM-003-SCFI-2014





TIRAS RGB COB DIMEABLES



Control desde celular o tableta

1 Año de garantía
 COB - RGB - dimeable - siliconizada

1 Año de garantía
 COB - RGB smart - siliconizada



PROX.
Tira RGB LED DIMEABLE
 Multicolor 5m

100V~240V~ 12V~ 30 000 h de vida CHIP COB EXTERIORES IP65 576 CHIPS x m 5 m Caja

- Incluye control remoto programa 16 colores
- 4 modos de iluminación e intensidad
- Fléxible y fácil de instalar
- Puede cortarse cada 3.5 cm
- Incluye cinta adhesiva para montaje
- Incluye adaptador de 100 V~ - 240 V~
- Incluye control

RGB DIMEABLE		Tecnología LED				
CÓDIGO	POTENCIA	📦	📦	DISTRIB.	MAYOREO	LISTA
128651	16 W	4	24	\$1,000.00	\$1,430.00	\$1,765.00

CUMPLE CON LOS PARÁMETROS DE LA NOM-003-SCFI-2014 **NOM**

PROX.
Tira RGB SMART LED DIMEABLE
 Multicolor 5m

100V~240V~ 12V~ 30 000 h de vida CHIP COB EXTERIORES IP65 576 CHIPS x m 5 m Caja

- Incluye control remoto programa 16 colores
- 4 modos de iluminación e intensidad
- Smart, se controla desde el celular
- Funciona al ritmo de la música
- Fléxible y fácil de instalar
- Puede cortarse cada 3.5 cm
- Incluye cinta adhesiva para montaje
- Incluye adaptador de 100 V~ - 240 V~
- Incluye control

RGB		Tecnología LED DIMEABLE				
CÓDIGO	POTENCIA	📦	📦	DISTRIB.	MAYOREO	LISTA
128661	16 W	4	24	\$1,100.00	\$1,570.00	\$1,940.00

CUMPLE CON LOS PARÁMETROS DE LA NOM-003-SCFI-2014 **NOM**

PROX. ●

DRIVER PARA TIRA COB LED

- Transforman la corriente de alterna (CA) a continua (CC)
- Adaptan el voltaje de salida a las necesidades del LED
- Fácil de instalar
- Para uso con tiras LED DIMEABLES

**INSTALACIÓN DE 15 m**

CÓDIGO		DISTRIB.	MAYOREO	LISTA
128681	25	\$240.00	\$345.00	\$425.00

INSTALACIÓN DE 25 m

CÓDIGO		DISTRIB.	MAYOREO	LISTA
128682	25	\$340.00	\$485.00	\$600.00

PROX. ●

CONECTOR PARA TIRA LED

CÓMO UNIRLA

1.

Conecta la tira LED al cable de conexión, uniendo el extremo de la tira en el conector-clip del cable de la siguiente manera.

2.

Presiona firmemente la parte posterior del clip del conector para sellar el cierre. Es posible que tengas que quitar parte de la cinta que cubre el lado adhesivo.

**3.**

Limpia la superficie donde pegarás las tiras LED, retira el adhesivo de la tira y presiona firmemente para pegarla a la superficie que quieras.

4.

Conecta el otro extremo del cable al controlador.

5.

Enchufa el controlador a la fuente de alimentación.

JUEGO DE 2 PIEZAS**PARA TIRA LED COB UNICOLOR 128631 Y 128632**

CÓDIGO		DISTRIB.	MAYOREO	LISTA
128639	100	\$15.00	\$21.40	\$26.00

JUEGO DE 2 PIEZAS**PARA TIRA LED COB RGB 128641 Y 128642**

CÓDIGO		DISTRIB.	MAYOREO	LISTA
128649	100	\$20.00	\$29.00	\$35.00



BASE PARA SPOT MR16

1

AÑO DE GARANTÍA

- Fabricados en acero
- Clips de instalación
- Ideales para lámpara LED AKSI MR16



Dale un toque elegante e ilumina tus espacios con las bases empotrables para focos MR16, perfectas para utilizar en plafón, cielo falso, losa, muro, exhibidores, etc.

Elige entre una base fija, base dirigible o base esférica dirigible. Cada una posee características propias que darán elegancia y funcionalidad a tu decoración.

BASE FIJA MR16



COLORES DISPONIBLES



127 V~

7 W POTENCIA MÁXIMA

INCLUYE BASE GU5.3

CAJA

Ideal para focos AKSI® MR16 GU5.3

CÓDIGO	COLOR	📦	📦	DISTRIB.	MAYOREO	LISTA
125001	Blanco	4	24	\$24.00	\$34.00	\$42.00
125002	Negro	4	24	\$24.00	\$34.00	\$42.00
125003	Satinado	4	24	\$28.00	\$40.00	\$49.00
125004	Aluminio	4	24	\$28.00	\$40.00	\$49.00

CUMPLE CON LOS PARÁMETROS DE LA NOM-003-SCFI-2014

NOM

BASE DIRIGIBLE MR16



COLORES DISPONIBLES



127 V~

7 W POTENCIA MÁXIMA

INCLUYE BASE GU5.3

CAJA

Ideal para focos AKSI® MR16 GU5.3

CÓDIGO	COLOR	📦	📦	DISTRIB.	MAYOREO	LISTA
125011	Blanco	4	24	\$35.00	\$50.00	\$62.00
125012	Negro	4	24	\$35.00	\$50.00	\$62.00
125013	Satinado	4	24	\$40.00	\$57.00	\$71.00
125014	Aluminio	4	24	\$40.00	\$57.00	\$71.00

CUMPLE CON LOS PARÁMETROS DE LA NOM-003-SCFI-2014

NOM

BASE ESFÉRICA MR16



COLORES DISPONIBLES

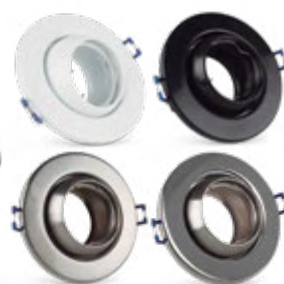

127 V~

7 W POTENCIA MÁXIMA

INCLUYE BASE GU5.3

CAJA

Ideal para focos AKSI® MR16 GU5.3

CÓDIGO	COLOR	📦	📦	DISTRIB.	MAYOREO	LISTA
125021	Blanco	4	24	\$50.00	\$71.00	\$88.00
125022	Negro	4	24	\$50.00	\$71.00	\$88.00
125023	Satinado	4	24	\$57.00	\$81.00	\$101.00
125024	Aluminio	4	24	\$57.00	\$81.00	\$101.00

CUMPLE CON LOS PARÁMETROS DE LA NOM-003-SCFI-2014

NOM



PROX. ●

FAROL CLÁSICO SUSPENDIDO

Decorativa colgante

E27
socket

Caja

1
Año de
garantía

Incluye kit de instalación

CÓDIGO	MODELO		DISTRIB.	MAYOREO	LISTA
131701	Blanco	10	\$215.00	\$305.00	\$380.00
131702	Negro	10	\$215.00	\$305.00	\$380.00

NO INCLUYE FOCO

CUMPLE CON LOS PARÁMETROS DE LA NOM-003-SCFI-2014

NOM

PROX. ●

FAROL CLÁSICO SOPORTADO

Decorativa colgante

E27
socket

Caja

1
Año de
garantía

Incluye kit de instalación

CÓDIGO	MODELO		DISTRIB.	MAYOREO	LISTA
131711	Blanco	10	\$230.00	\$330.00	\$405.00
131712	Negro	10	\$230.00	\$330.00	\$405.00

NO INCLUYE FOCO

CUMPLE CON LOS PARÁMETROS DE LA NOM-003-SCFI-2014

NOM





PROX. ●

FAROL CUADRADO SOPORTADO

Decorativa colgante

E27
socket



Caja

1
Año de
garantía

Incluye kit de instalación

CÓDIGO	MODELO	AÑO DE GARANTÍA	DISTRIB.	MAYOREO	LISTA
131716	Blanco	10	\$230.00	\$330.00	\$405.00
131717	Negro	10	\$230.00	\$330.00	\$405.00

CUMPLE CON LOS PARÁMETROS DE LA NOM-003-SCFI-2014



PROX. ●

FAROL COLONIAL

Decorativa colgante

E27
socket



Caja

1
Año de
garantía

Incluye kit de instalación

CÓDIGO	MODELO	AÑO DE GARANTÍA	DISTRIB.	MAYOREO	LISTA
131721	Blanco	10	\$400.00	\$570.00	\$705.00
131722	Negro	10	\$400.00	\$570.00	\$705.00

CUMPLE CON LOS PARÁMETROS DE LA NOM-003-SCFI-2014





PROX.

FAROL COLGANTE

Decorativa colgante

1 m
cadena

base 9.5 cm

E27
socket

Caja

1
Año de
garantía

Incluye kit de instalación

CÓDIGO	MODELO		DISTRIB.	MAYOREO	LISTA
131731	Blanco	10	\$345.00	\$495.00	\$610.00
131732	Negro	10	\$345.00	\$495.00	\$610.00

NO INCLUYE FOCO

CUMPLE CON LOS PARÁMETROS DE LA NOM-003-SCFI-2014

NOM



*CABLE AJUSTABLE



125161



125162



125163



125166

LUMINARIA SPRING

Decorativa colgante

1.5 m
cable*



base 12 cm

E27
socket



Caja

1
Año de
garantía

Incluye kit de instalación

CÓDIGO	MODELO		DISTRIB.	MAYOREO	LISTA
125161	Ovalo	10	\$350.00	\$500.00	\$615.00
125162	Cono	10	\$350.00	\$500.00	\$615.00
125163	Cilindro	10	\$350.00	\$500.00	\$615.00
125166	Panel abeja	10	\$350.00	\$500.00	\$615.00

NO INCLUYE FOCO

CUMPLE CON LOS PARÁMETROS DE LA NOM-003-SCFI-2014

NOM

multi POSICIÓN

La geometría del luminario **INFINITI** permite ajustarlo a múltiples posiciones.

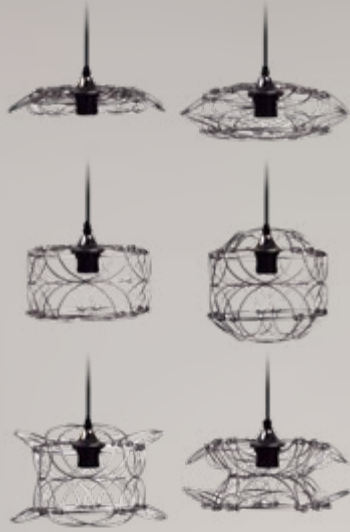

LUMINARIA INFINITI

Decorativa colgante multi posición

1 m
cable*

base 12 cm

E27
socket

Caja

1
Año de
garantía

Incluye kit de instalación

CÓDIGO	MODELO	DISTRIB.	MAYOREO	LISTA	
125181	Negro perlado	10	\$450.00	\$645.00	\$795.00



De fácil almacenaje

NO INCLUYE FOCO

CUMPLE CON LOS PARÁMETROS DE LA NOM-003-SCFI-2014

NOM



multi POSICIÓN

La geometría de los luminarios **BY YOU** permite ajustarlo a múltiples posiciones.



*CABLE AJUSTABLE



125176



125177



125172

LUMINARIA BY YOU

Decorativa colgante multi posición

1 m
cable*

base 12 cm

E27
socket

Caja

1
Año de
garantía

Incluye kit de instalación

CÓDIGO	MODELO	MEDIDA	DISTRIB.	MAVOREO	LISTA
125172	Rose gold	25 x 118 cm	10	\$365.00 \$520.00	\$645.00
125176	French gold	31 x 118 cm	10	\$400.00 \$570.00	\$705.00
125177	Negro perlado	37 x 118 cm	10	\$430.00 \$615.00	\$760.00



De fácil almacenaje

NO INCLUYE FOCO

CUMPLE CON LOS PARÁMETROS DE LA NOM-003-SCFI-2014

NOM

PLEGABLE

La estructura de los luminarios **MESH** permite compactarlo creando diseños variados.



*CABLE AJUSTABLE



125187



125186

LUMINARIA MESH

Decorativa colgante

1 m
cable*

base 12 cm

E27
socket

Caja

1
Año de
garantía



Incluye kit de instalación

CÓDIGO	MODELO		DISTRIB.	MAYOREO	LISTA
125186	Negro perlado	10	\$400.00	\$570.00	\$705.00
125187	Rose gold	10	\$400.00	\$570.00	\$705.00

De fácil almacenaje

NO INCLUYE FOCO

CUMPLE CON LOS PARÁMETROS DE LA NOM-003-SCFI-2014

NOM





LUMINARIA MILÁN

Decorativa colgante

1 m
cable*

base 12 cm

E27
socket

Caja

1
Año de
garantía

Incluye kit de instalación

CÓDIGO	MODELO		DISTRIB.	MAYOREO	LISTA
125131	Níquel cepillado mate	10	\$385.00	\$550.00	\$680.00
125132	Bronce mate	10	\$385.00	\$550.00	\$680.00
125133	Bronce marrón mate	10	\$385.00	\$550.00	\$680.00
125134	Bronce rojo mate	10	\$385.00	\$550.00	\$680.00

NO INCLUYE FOCO

CUMPLE CON LOS PARÁMETROS DE LA NOM-003-SCFI-2014

NOM

LUMINARIA ANDALUCÍA

Decorativa colgante

1 m
cable*

base 12 cm

E27
socket

Caja

1
Año de
garantía

Incluye kit de instalación

CÓDIGO	MODELO		DISTRIB.	MAYOREO	LISTA
125141	Níquel cepillado brillante	10	\$475.00	\$680.00	\$840.00
125142	Bronce brillante	10	\$475.00	\$680.00	\$840.00
125143	Bronce marrón brillante	10	\$475.00	\$680.00	\$840.00
125144	Bronce rojo brillante	10	\$475.00	\$680.00	\$840.00

NO INCLUYE FOCO

CUMPLE CON LOS PARÁMETROS DE LA NOM-003-SCFI-2014

NOM



125121



125124



125123



125122

LUMINARIA LISBOA

Decorativa colgante

1 m
cable*

base 12 cm

E27
socket

Caja

1
Año de
garantía

Incluye kit de instalación

CÓDIGO	MODELO		DISTRIB.	MAYOREO	LISTA
125121	Níquel cepillado brillante	10	\$440.00	\$630.00	\$775.00
125122	Bronce brillante	10	\$440.00	\$630.00	\$775.00
125123	Bronce marrón brillante	10	\$440.00	\$630.00	\$775.00
125124	Bronce rojo brillante	10	\$440.00	\$630.00	\$775.00

NO INCLUYE FOCO

CUMPLE CON LOS PARÁMETROS DE LA NOM-003-SCFI-2014

NOM





*CABLE AJUSTABLE

125102



125101



125103



125104



*CABLE AJUSTABLE

125111



125112



125114

LUMINARIA BASSIC

Decorativa colgante

1 m
cable*

base 12 cm

E27
socket

Caja

1
Año de
garantía

Incluye kit de instalación

CÓDIGO	MODELO		DISTRIB.	MAYOREO	LISTA
125101	Negro mate	10	\$230.00	\$330.00	\$405.00
125102	Blanco mate	10	\$230.00	\$330.00	\$405.00
125103	Bronce rojo mate	10	\$295.00	\$420.00	\$520.00
125104	Plata brillante	10	\$295.00	\$420.00	\$520.00

NO INCLUYE FOCO

CUMPLE CON LOS PARÁMETROS DE LA NOM-003-SCFI-2014

NOM

LUMINARIA CLASSIQUE

Decorativa colgante

1 m
cable*

12 cm

E27
socket

Caja

1
Año de
garantía

Incluye kit de instalación

CÓDIGO	MODELO		DISTRIB.	MAYOREO	LISTA
125111	Negro perla mate	10	\$350.00	\$500.00	\$615.00
125112	Plata brillante	10	\$350.00	\$500.00	\$615.00
125114	Bronce rojo mate	10	\$350.00	\$500.00	\$615.00

NO INCLUYE FOCO

CUMPLE CON LOS PARÁMETROS DE LA NOM-003-SCFI-2014

NOM



LUMINARIA ANKARA

Decorativa colgante

1.5 m
cable*

base 12 cm

E27
socket

Caja

1
Año de
garantía

Incluye kit de instalación

CÓDIGO	MODELO		DISTRIB.	MAYOREO	LISTA
125151	Rock	10	\$395.00	\$565.00	\$695.00
125152	Mármol negro	10	\$495.00	\$705.00	\$875.00
125153	Mármol blanco	10	\$495.00	\$705.00	\$875.00
125154	Marmoleado	10	\$590.00	\$845.00	\$1,040.00

NO INCLUYE FOCO

CUMPLE CON LOS PARÁMETROS DE LA NOM-003-SCFI-2014

NOM





LINTERNAS

► Linternas recargables . ecológicas . minis . luminarios de emergencia . selfie lighting . de escritorio . para bicicleta . camping . tipo minero y más.



Linterna recargable búsqueda y rescate

NOM

CAJA

- ▶ Maxi LED de 15 W
- ▶ Práctico panel con 24 LEDs
- ▶ Ideal para iluminar espacios grandes
- ▶ Hasta 15 horas* de iluminación continua en modo panel
- ▶ Adaptador de corriente

1
año
GARANTÍASoft
GRIP
*SUAVE

AKSI

Ficha TÉCNICA

CÓDIGO	No. DE LEADS	CARGAS ÚTILES			DISTRIB.	MAYOREO	LISTA
111615	1 + 24	250 aprox.	4	16	\$500.00	\$715.00	\$880.00

La linterna debe ser recargada regularmente, de no ser usada se debe recargar 1 vez cada 3 meses descargándola previamente.

Linterna recargable emergency light

NOM

CAJA

- ▶ Maxi LED de 10 W
- ▶ Práctico panel con 24 LEDs
- ▶ Ideal para el hogar y negocios en caso de apagones
- ▶ Hasta 24 horas* de iluminación continua
- ▶ Cordón de carga integrado

1
año
GARANTÍASoft
GRIP
*SUAVE

AKSI

Ficha TÉCNICA

CÓDIGO	No. DE LEADS	CARGAS ÚTILES			DISTRIB.	MAYOREO	LISTA
111614	1 + 24	250 aprox.	4	16	\$350.00	\$500.00	\$615.00

La linterna debe ser recargada regularmente, de no ser usada se debe recargar 1 vez cada 3 meses descargándola previamente.

Linterna recargable búsqueda y rescate

NOM

CAJA

- ▶ Maxi LED de 6 W
- ▶ Dos intensidades de luz
- ▶ Ideal para realizar actividades de búsqueda y rescate
- ▶ Hasta 20 horas* de iluminación continua
- ▶ Cordón de carga integrado

1
año
GARANTÍASoft
GRIP
*SUAVE

AKSI

Ficha TÉCNICA

CÓDIGO	No. DE LEADS	CARGAS ÚTILES			DISTRIB.	MAYOREO	LISTA
111613	1	250 aprox.	6	24	\$300.00	\$430.00	\$530.00

La linterna debe ser recargada regularmente, de no ser usada se debe recargar 1 vez cada 3 meses descargándola previamente.

Linterna recargable emergency light

NOM

CAJA

- ▶ Maxi LED de 2 W y panel con 12 LEDs
- ▶ Dos intensidades de luz
- ▶ Ideal en caso de apagones
- ▶ Hasta 18 horas de iluminación continua en modo panel
- ▶ Hasta 8 horas de iluminación continua en luz alta
- ▶ Cordón de carga integrado

1
año
GARANTÍASoft
GRIP
*SUAVE

AKSI

Ficha TÉCNICA

CÓDIGO	No. DE LEADS	CARGAS ÚTILES			DISTRIB.	MAYOREO	LISTA
111612	1 + 12	250 aprox.	6	24	\$250.00	\$355.00	\$440.00

La linterna debe ser recargada regularmente, de no ser usada se debe recargar 1 vez cada 3 meses descargándola previamente.

Linterna recargable de seguridad

NOM

CAJA

- ▶ Cordón de carga integrado
- ▶ Dos intensidades de luz a 10 ó 24 LEDs
- ▶ Ideal para vigilancia
- ▶ Hasta 15 horas de iluminación continua en luz baja a 10 LEDs
- ▶ Hasta 6 horas de iluminación continua en luz alta a 24 LEDs

1
año
GARANTÍASoft
GRIP
*SUAVE

AKSI

Ficha TÉCNICA

CÓDIGO	No. DE LEADS	CARGAS ÚTILES			DISTRIB.	MAYOREO	LISTA
111611	24	250 aprox.	6	24	\$215.00	\$305.00	\$380.00

La linterna debe ser recargada regularmente, de no ser usada se debe recargar 1 vez cada 3 meses descargándola previamente.

Linterna recargable multiusos

NOM

TARJETA DESLIZABLE

- ▶ 1 LED alta potencia de 2 W
- ▶ Luz de escritorio con 12 LEDs
- ▶ Ideal para el hogar y negocios
- ▶ Hasta 4 horas* de iluminación continua
- ▶ Clavija retráctil para recarga

6
meses
GARANTÍA

MAXTOOL

Ficha TÉCNICA

CÓDIGO	No. DE LEADS	CARGAS ÚTILES			DISTRIB.	MAYOREO	LISTA
305241	1 + 12	250 aprox.	6	24	\$115.00	\$165.00	\$205.00

La linterna debe ser recargada regularmente, de no ser usada se debe recargar 1 vez cada 3 meses descargándola previamente.

Linterna de aluminio

PROX.

NOM

1
año
GARANTÍA

TARJETA DESLIZABLE

- ▶ Linterna con regulación de ángulo: de abierta a directa
- ▶ Incluye cable USB-C para recarga
- ▶ Ilumina hasta 250 m



CÓDIGO	No. DE LEDES			DISTRIB.	MAYOREO	LISTA
131301	1 CREE LED	6	36	\$270.00	\$385.00	\$475.00

La linterna debe ser recargada regularmente, de no ser usada se debe recargar 1 vez cada 3 meses descargándola previamente.

Linterna de aluminio con medidor de batería

PROX.

NOM

1
año
GARANTÍA

TARJETA DESLIZABLE

- ▶ Linterna con regulación de ángulo: de abierta a directa
- ▶ Incluye cable USB-C para recarga
- ▶ Ilumina hasta 350 m



CÓDIGO	No. DE LEDES	CARGAS ÚTILES			DISTRIB.	MAYOREO	LISTA
131302	1 CREE LED	6	36	\$420.00	\$600.00	\$740.00	

La linterna debe ser recargada regularmente, de no ser usada se debe recargar 1 vez cada 3 meses descargándola previamente.

Linterna con inserto de aluminio

PROX.

NOM

1
año
GARANTÍA

TARJETA DESLIZABLE

- ▶ 2 Tipos de luz: regular y tipo tráfico aéreo
- ▶ Incluye cable USB-C para recarga



CÓDIGO	No. DE LEDES	CARGAS ÚTILES			DISTRIB.	MAYOREO	LISTA
131311	1 de 1 W	250	6	36	\$75.00	\$107.00	\$132.00
131312	1 de 3 W	250	6	36	\$120.00	\$170.00	\$210.00

La linterna debe ser recargada regularmente, de no ser usada se debe recargar 1 vez cada 3 meses descargándola previamente.

Linterna de aluminio

PROX.

NOM

1
año
GARANTÍA

TARJETA DESLIZABLE

- ▶ 3 Tipos de luz: alta, baja y estroboscópica
- ▶ Incluye eliminador



CÓDIGO	No. DE LEDES	CARGAS ÚTILES			DISTRIB.	MAYOREO	LISTA
131321	1 de 1 W	250	6	36	\$95.00	\$136.00	\$170.00
131322	1 de 3 W	250	6	36	\$110.00	\$155.00	\$195.00
131323	1 de 5 W	250	6	36v	\$125.00	\$180.00	\$220.00

La linterna debe ser recargada regularmente, de no ser usada se debe recargar 1 vez cada 3 meses descargándola previamente.

*Las horas de iluminación indicada es con la intensidad baja.
Los productos de alta rotación se encuentran distinguidos por el color rojo en su código.
La apariencia del producto puede llegar a variar • Ventas y atención a clientes 55-5383-4412

Linterna ecológica recargable eléctrica y solar

NOM

TARJETA DESLIZABLE

- ▶ Maxi LED de 2 W
- ▶ Práctico panel con 7 LEDs
- ▶ Ideal para expedición y campamento
- ▶ Hasta 6 horas* de iluminación continua
- ▶ Incluye cable USB para recarga



Ficha TÉCNICA



AKSI

1
año
GARANTÍA

CÓDIGO	No. DE LEDS	CARGAS ÚTILES			DISTRIB.	MAYOREO	LISTA
111656	1 + 7	250 aprox.	10	60	\$120.00	\$170.00	\$210.00

La linterna debe ser recargada regularmente, de no ser usada se debe recargar 1 vez cada 3 meses descargándola previamente.

Linterna recargable emergency light

NOM

TARJETA DESLIZABLE

- ▶ Maxi LED de 2 W
- ▶ Práctico panel con 12 LEDs
- ▶ Ideal para apagones y emergencias
- ▶ Hasta 5 horas* de iluminación continua
- ▶ Clavija retráctil para recarga



Ficha TÉCNICA



AKSI

1
año
GARANTÍA

CÓDIGO	No. DE LEDS	CARGAS ÚTILES			DISTRIB.	MAYOREO	LISTA
111658	1 + 12	250 aprox.	6	60	\$85.00	\$121.00	\$150.00

La linterna debe ser recargada regularmente, de no ser usada se debe recargar 1 vez cada 3 meses descargándola previamente.

Linterna recargable detector de billetes falsos

NOM

TARJETA DESLIZABLE

- ▶ 1 LED de alto alcance de 1 W
- ▶ Dos intensidades de luz
- ▶ Eficaz para detectar billetes falsos en negocios
- ▶ Hasta 10 horas* de iluminación continua
- ▶ Clavija retráctil para recarga



Ficha TÉCNICA



AKSI

1
año
GARANTÍASoft
GRIP
*SUAVE

CÓDIGO	No. DE LEDS	CARGAS ÚTILES			DISTRIB.	MAYOREO	LISTA
111651	1 + 1	250 aprox.	10	60	\$65.00	\$93.00	\$115.00

La linterna debe ser recargada regularmente, de no ser usada se debe recargar 1 vez cada 3 meses descargándola previamente.

Linterna recargable detector de billetes falsos

NOM

TARJETA DESLIZABLE

- ▶ 1 LED de alto alcance de 0.5 W
- ▶ Eficaz para detectar billetes falsos en negocios
- ▶ Hasta 6 horas* de iluminación continua
- ▶ Clavija retráctil para recarga



Ficha TÉCNICA



TI MAXTOOL

6
meses
GARANTÍA

CÓDIGO	No. DE LEDS	CARGAS ÚTILES			DISTRIB.	MAYOREO	LISTA
305211	1 + 1	250 aprox.	10	60	\$39.00	\$56.00	\$69.00

La linterna debe ser recargada regularmente, de no ser usada se debe recargar 1 vez cada 3 meses descargándola previamente.

Linterna recargable de seguridad

NOM

TARJETA DESLIZABLE

- ▶ Maxi LED de 2 W
- ▶ Dos intensidades de luz
- ▶ Alarga el tiempo de uso con máxima potencia
- ▶ Hasta 8 horas* de iluminación continua
- ▶ Clavija retráctil para recarga



Ficha TÉCNICA



AKSI

1
año
GARANTÍA

CÓDIGO	No. DE LEDS	CARGAS ÚTILES			DISTRIB.	MAYOREO	LISTA
111657	1	250 aprox.	10	60	\$70.00	\$100.00	\$123.00

La linterna debe ser recargada regularmente, de no ser usada se debe recargar 1 vez cada 3 meses descargándola previamente.

Linterna recargable Xtreme

NOM

TARJETA DESLIZABLE

- ▶ LED de alto alcance de 2 W
- ▶ Dos intensidades de luz
- ▶ Ideal para llevarla de expedición y campamento
- ▶ Hasta 8 horas* de iluminación continua



Ficha TÉCNICA



AKSI

1
año
GARANTÍA

CÓDIGO	No. DE LEDS	CARGAS ÚTILES			DISTRIB.	MAYOREO	LISTA
111654	1	250 aprox.	10	60	\$60.00	\$86.00	\$106.00

La linterna debe ser recargada regularmente, de no ser usada se debe recargar 1 vez cada 3 meses descargándola previamente.

Linterna Jungle explorer

NOM

1 año GARANTÍA

TARJETA DESLIZABLE

- ▶ 12 LEDs de alta potencia + 1 LED de alto alcance
- ▶ Tres intensidades de luz
- ▶ Hasta 5 horas* de iluminación continua
- ▶ 250 cargas útiles
- ▶ Clavija retráctil para recarga



111661



AKSI

CÓDIGO	No. DE LEDES	CARGAS ÚTILES			DISTRIB.	MAYOREO	LISTA
111661	12 + 1	250 aprox.	10	60	\$80.00	\$114.00	\$141.00
111662	12 + 1	250 aprox.	10	60	\$80.00	\$114.00	\$141.00

La linterna debe ser recargada regularmente, de no ser usada se debe recargar 1 vez cada 3 meses descargándola previamente.

Linterna recargable multiusos

NOM

6 meses GARANTÍA

TARJETA DESLIZABLE

- ▶ Dos intensidades de luz a 5 ó 9 LEDs
- ▶ Ideal para el hogar y negocios
- ▶ Hasta 9 horas de iluminación continua en luz baja a 5 LEDs
- ▶ Hasta 5 horas de iluminación continua en luz alta a 9 LEDs
- ▶ Clavija retráctil para recarga



IT MAXTOOL

CÓDIGO	No. DE LEDES	CARGAS ÚTILES			DISTRIB.	MAYOREO	LISTA
305214	9	250 aprox.	10	60	\$70.00	\$100.00	\$123.00

La linterna debe ser recargada regularmente, de no ser usada se debe recargar 1 vez cada 3 meses descargándola previamente.

Linterna recargable ecológica

NOM

1 año GARANTÍA

TARJETA DESLIZABLE

- ▶ Maxi LED de 2 W
- ▶ Dos intensidades de luz
- ▶ Alarga el tiempo de uso con máxima potencia
- ▶ Hasta 10 horas* de iluminación continua
- ▶ Clavija retráctil para recarga



Ficha TÉCNICA



Soft GRIP

➕SUDVZ

AKSI

CÓDIGO	No. DE LEDES	CARGAS ÚTILES			DISTRIB.	MAYOREO	LISTA
111655	1	250 aprox.	10	60	\$85.00	\$121.00	\$150.00

La linterna debe ser recargada regularmente, de no ser usada se debe recargar 1 vez cada 3 meses descargándola previamente.

Linterna recargable utilitaria

NOM

6 meses GARANTÍA

TARJETA DESLIZABLE

- ▶ LED de alto alcance de 0.5 W
- ▶ Dos intensidades de luz
- ▶ Ideal para usos generales
- ▶ Hasta 8 horas* de iluminación continua
- ▶ Clavija retráctil para recarga



IT MAXTOOL

CÓDIGO	No. DE LEDES	CARGAS ÚTILES			DISTRIB.	MAYOREO	LISTA
305212	1	250 aprox.	10	60	\$50.00	\$71.00	\$88.00

La linterna debe ser recargada regularmente, de no ser usada se debe recargar 1 vez cada 3 meses descargándola previamente.

Mini linterna con batería de Litio

NOM

1 año GARANTÍA

TARJETA DESLIZABLE

- ▶ 1 LED de alto alcance
- ▶ Dos intensidades de luz
- ▶ Hasta 12 horas de iluminación continua
- ▶ 250 cargas útiles
- ▶ Incluye batería de LI-ION



Ficha TÉCNICA



AKSI

CÓDIGO	LEDS	CARGAS			DISTRIB.	MAYOREO	LISTA
111660	1	250 aprox.	10	60	\$80.00	\$114.00	\$141.00

Mini linterna

NOM

6 meses GARANTÍA

TARJETA DESLIZABLE

- ▶ 1 LED de alta potencia
- ▶ Dos intensidades de luz
- ▶ Hasta 7 horas de iluminación continua
- ▶ 250 cargas útiles
- ▶ Clavija retráctil para recarga



IT MAXTOOL

CÓDIGO	LEDS	CARGAS			DISTRIB.	MAYOREO	LISTA
305215	1	250 aprox.	10	60	\$34.00	\$49.00	\$60.00

Mini linterna recargable

NOM

6 meses GARANTÍA

TARJETA DESLIZABLE

- ▶ 1 LED alta potencia de 0.5 W
- ▶ Dos intensidades de luz
- ▶ Hasta 5 horas* de iluminación continua
- ▶ Clavija retráctil para recarga



IT MAXTOOL

CÓDIGO	LEDS	CARGAS			DISTRIB.	MAYOREO	LISTA
305210	1	250 aprox.	10	60	\$39.00	\$56.00	\$69.00

Las linternas mini debe ser recargada regularmente, de no ser usada se debe recargar 1 vez cada 3 meses descargándola previamente.

*Las horas de iluminación indicada es con la intensidad baja.

Los productos de alta rotación se encuentran distinguidos por el color rojo en su código. La apariencia del producto puede llegar a variar • Ventas y atención a clientes 55-5383-4412



Luz de noche con interruptor

NOM
1
 año
 GARANTÍA

BLÍSTER

- ▶ Luz incandescente
- ▶ Bajo consumo de energía (4 W)
- ▶ 127 V / 60 Hz



CÓDIGO	DESCRIPCIÓN			DISTRIB.	MAYOREO	LISTA
309701	Football	12	144	\$23.00	\$33.00	\$41.00
309702	Basketball	12	144	\$23.00	\$33.00	\$41.00
309703	Farol blanco	12	144	\$23.00	\$33.00	\$41.00
309704	Farol negro	12	144	\$23.00	\$33.00	\$41.00

CÓDIGO	DESCRIPCIÓN			DISTRIB.	MAYOREO	LISTA
309705	Concha	12	144	\$23.00	\$33.00	\$41.00
309706	Estándar transparente	12	144	\$23.00	\$33.00	\$41.00
309707	Lunas y estrellas	12	144	\$23.00	\$33.00	\$41.00
309708	Flor	12	144	\$23.00	\$33.00	\$41.00

IT MAXTOOL

Linterna recargable Kids

NOM
1
 año
 GARANTÍA

TARJETA DESLIZABLE

- ▶ Dos intensidades de luz
- ▶ Clavija retráctil para recarga
- ▶ Hasta 20 horas* de iluminación continua



Ficha TÉCNICA



CÓDIGO	COLOR	LEDS	CARGAS ÚTILES			DISTRIB.	MAYOREO	LISTA
111652	Azul	1	250 aprox.	10	60	\$60.00	\$86.00	\$106.00
111653	Rosa	1	250 aprox.	10	60	\$60.00	\$86.00	\$106.00

La linterna debe ser recargada regularmente, de no ser usada se debe recargar 1 vez cada 3 meses descargándola previamente.

AKSI

Linterna recargable Mini Kids

NOM
6
 meses
 GARANTÍA

TARJETA DESLIZABLE

- ▶ Dos intensidades de luz
- ▶ Clavija retráctil para recarga
- ▶ Hasta 8 horas* de iluminación continua



CÓDIGO	COLOR	LEDS	CARGAS ÚTILES			DISTRIB.	MAYOREO	LISTA
305208	Rosa	1	250 aprox.	10	60	\$34.00	\$49.00	\$60.00
305209	Turquesa	1	250 aprox.	10	60	\$34.00	\$49.00	\$60.00

La linterna debe ser recargada regularmente, de no ser usada se debe recargar 1 vez cada 3 meses descargándola previamente.

IT MAXTOOL

Linterna con luminario de emergencia

NOM
1
 año
 GARANTÍA

TARJETA DESLIZABLE

- ▶ 1 LED de alta potencia + luminario de emergencia
- ▶ Dos intensidades de luz en el luminario
- ▶ 1 LED de alto alcance
- ▶ Hasta 3 horas* de iluminación continua
- ▶ 250 cargas útiles
- ▶ Clavija retráctil para recarga



Ficha TÉCNICA



CÓDIGO	No. DE LEDS	CARGAS ÚTILES			DISTRIB.	MAYOREO	LISTA
111663	1 + 13	250 aprox.	10	60	\$90.00	\$129.00	\$160.00

La linterna debe ser recargada regularmente, de no ser usada se debe recargar 1 vez cada 3 meses descargándola previamente.

AKSI

Linterna Survivor

NOM
6
 meses
 GARANTÍA

TARJETA DESLIZABLE

- ▶ 1 LED de alta potencia
- ▶ Dos intensidades de luz
- ▶ Hasta 2 horas* de iluminación continua
- ▶ Clavija retráctil para recarga
- ▶ Linterna ligera, ideal para caminatas



CÓDIGO	No. DE LEDS	CARGAS ÚTILES			DISTRIB.	MAYOREO	LISTA
305217	1	250 aprox.	10	60	\$43.00	\$61.00	\$76.00

La linterna debe ser recargada regularmente, de no ser usada se debe recargar 1 vez cada 3 meses descargándola previamente.

IT MAXTOOL



Selfie lighting

Arma tu kit combinando los aros y tripiés



Aro de luz multitonaridad (blanca, cálida, ámbar)



CAJA

- ▶ Ideal para live streaming, videos, make up, etc.
- ▶ Tres tonalidades de luz: blanca, amarilla e intermedia
- ▶ Conexión USB
- ▶ Compatible con tripié AKSI®



Tripié y mini tripié



CAJA

- ▶ Compatible con aros de luz AKSI®
- ▶ Rosca de 1/4"
- ▶ Plegables para fácil transportación



CÓDIGO	MEDIDA			DISTRIB.	MAYOREO	LISTA
128501	Ø 20 cm	10	60	\$150.00	\$215.00	\$265.00
128502	Ø 26 cm	10	40	\$160.00	\$230.00	\$280.00
128503	Ø 32 cm	10	20	\$250.00	\$355.00	\$440.00

CÓDIGO	ALTURA		DISTRIB.	MAYOREO	LISTA
128511	1.6 m	10	\$85.00	\$121.00	\$150.00
128512	20 cm	10	\$20.00	\$29.00	\$35.00

Luminario recargable para escritorio

NOM

CAJA

- ▶ Panel de 30 LEDs
- ▶ Intensidad de luz regulable
- ▶ Desplegable y multiposiciones
- ▶ Hasta 8 horas* de iluminación continua
- ▶ Cable removible



Ficha TÉCNICA

1
año
GARANTÍA

AKSI

CÓDIGO	COLOR	No. DE LEDES	CARGAS ÚTILES			DISTRIB.	MAYOREO	LISTA
111682	Gris	30	250 aprox.	10	40	\$175.00	\$250.00	\$310.00

El luminario debe ser recargado regularmente, de no ser usado se debe recargar 1 vez cada 3 meses descargándolo previamente.

Luminario recargable 2 en 1

NOM

TARJETA DESLIZABLE

- ▶ Luminario de escritorio y linterna de mano
- ▶ 1 LED alta potencia 0.5 W
- ▶ Práctico panel con 18 LEDs
- ▶ Intensidad de luz regulable
- ▶ Desplegable y multiposiciones
- ▶ Hasta 8 horas de iluminación continua
- ▶ Hasta 10 horas de iluminación continua con LED de 0.5 W
- ▶ Clavija retráctil para recarga

6
meses
GARANTÍA

MAXTOOL

CÓDIGO	No. DE LEDES	CARGAS ÚTILES			DISTRIB.	MAYOREO	LISTA
305261	18 + 1	250 aprox.	10	40	\$100.00	\$143.00	\$175.00

El luminario debe ser recargado regularmente, de no ser usado se debe recargar 1 vez cada 3 meses descargándolo previamente.

Letrero luminoso LED

NOM

CAJA

- ▶ Clavija polarizada
- ▶ Incluye 5 señalamientos intercambiables
- ▶ Ideal como señalética en oficina
- ▶ Iluminación LED de bajo consumo
- ▶ Batería de respaldo de 3 horas de duración
- ▶ Dimensión total: 24.6 cm x 20.3 cm

1
año
GARANTÍA

AKSI

CÓDIGO	POTENCIA			DISTRIB.	MAYOREO	LISTA
118105	0.3 W	2	10	\$410.00	\$585.00	\$725.00

El letrero debe ser recargado regularmente, de no ser usado se debe recargar 1 vez cada 3 meses descargándolo previamente.

Ventilador de escritorio con luz LED

NOM

CAJA

- ▶ Ventilador con 2 niveles de intensidad
- ▶ Cubierta abatible con luz LED
- ▶ Conexión USB
- ▶ 2 niveles de iluminación
- ▶ Hasta 15 horas de iluminación continua
- ▶ Con asa para transportación

1
año
GARANTÍA

AKSI

CÓDIGO	No. DE LEDES	INTENSIDADES			DISTRIB.	MAYOREO	LISTA
111683	18	2	6	24	\$250.00	\$355.00	\$440.00

El ventilador debe ser recargado regularmente, de no ser usado se debe recargar 1 vez cada 3 meses descargándolo previamente.

Linterna trasera recargable para bicicleta

NOM

NUEVO

BLÍSTER

- ▶ Linterna trasera para bicicleta
- ▶ Incluye cable USB para recarga

1
año
GARANTÍA

AKSI

CÓDIGO	No. DE LEDES			DISTRIB.	MAYOREO	LISTA
111641	6	12	48	\$150.00	\$215.00	\$265.00

La linterna debe ser recargada regularmente, de no ser usada se debe recargar 1 vez cada 3 meses descargándola previamente.

Linternas para bicicleta delantera y trasera

NOM

BLÍSTER

- ▶ Linternas de baterías
- ▶ Incluye 4 baterías tipo CR2032
- ▶ Resistentes al agua
- ▶ Fabricadas en silicón flexible
- ▶ Para tubos de 2.5 y 3 cm
- ▶ Linterna delantera blanca
- ▶ Linterna trasera roja

6
meses
GARANTÍA

MAXTOOL

CÓDIGO	COLOR			DISTRIB.	MAYOREO	LISTA
305251	Negra	10	60	\$38.00	\$54.00	\$67.00
305252	Azul	10	60	\$38.00	\$54.00	\$67.00
305253	Roja	10	60	\$38.00	\$54.00	\$67.00
305254	Morada	10	60	\$38.00	\$54.00	\$67.00
305255	Rosa	10	60	\$38.00	\$54.00	\$67.00

*Las horas de iluminación indicada es con la intensidad baja.

Linterna recargable tipo minero

NOM

CAJA PLÁSTICA CON FAJILLA

- ▶ 1 LED de alto alcance de 3 W
- ▶ Dos intensidades de luz
- ▶ Útil para trabajos con libertad de movimiento
- ▶ Hasta 12 horas* de iluminación continua
- ▶ Multiposiciones 90°

1 año GARANTÍA



Ficha TÉCNICA



CÓDIGO	No. DE LEDS	CARGAS ÚTILES			DISTRIB.	MAYOREO	LISTA
111632	1	500 aprox.	6	36	\$130.00	\$185.00	\$230.00

La linterna debe ser recargada regularmente, de no ser usada se debe recargar 1 vez cada 3 meses descargándola previamente.

Linterna recargable para campamento

NOM

CAJA

- ▶ 41 LEDS
- ▶ Intensidad de luz regulable
- ▶ Asa giratoria 360° con gancho
- ▶ Ajuste a función de emergencia y expediciones
- ▶ Hasta 10 horas de iluminación continua
- ▶ Cordón de carga removible

1 año GARANTÍA

Soft GRIP +SUAVE



CÓDIGO	No. DE LEDS	CARGAS ÚTILES			DISTRIB.	MAYOREO	LISTA
111621	41	250 aprox.	6	24	\$260.00	\$370.00	\$460.00

La linterna debe ser recargada regularmente, de no ser usada se debe recargar 1 vez cada 3 meses descargándola previamente.

Linterna recargable tipo minero

NOM

CAJA

- ▶ Útil para trabajos con libertad de movimiento
- ▶ 1 LED de alto alcance de 1.3 W
- ▶ Dos intensidades de luz
- ▶ Hasta 18 horas de iluminación continua en luz baja
- ▶ Hasta 8 horas de iluminación continua en luz alta

1 año GARANTÍA



Ficha TÉCNICA

- ▶ Multiposiciones 90°
- ▶ Cordón de carga removible



CÓDIGO	No. DE LEDS	CARGAS ÚTILES			DISTRIB.	MAYOREO	LISTA
111631	1	250 aprox.	6	36	\$100.00	\$143.00	\$175.00

La linterna debe ser recargada regularmente, de no ser usada se debe recargar 1 vez cada 3 meses descargándola previamente.

Linterna recargable para campamento

NOM

CAJA

- ▶ 1 LED alta potencia de 2 W
- ▶ Función de luz tipo faro de 24 LEDS
- ▶ Dos intensidades de luz
- ▶ Asa giratoria 360° ideal para campamentos
- ▶ Hasta 14 horas de iluminación continua con LED de 2 W
- ▶ Hasta 7 horas de iluminación continua con 24 LEDS
- ▶ Cordón de carga removible

6 meses GARANTÍA



CÓDIGO	No. DE LEDS	CARGAS ÚTILES			DISTRIB.	MAYOREO	LISTA
305281	1 + 24	250 aprox.	6	24	\$190.00	\$270.00	\$335.00

La linterna debe ser recargada regularmente, de no ser usada se debe recargar 1 vez cada 3 meses descargándola previamente.

Linterna recargable tipo minero de 1 ó 7 LEDS

NOM

TARJETA DESLIZABLE

- ▶ 1 LED de alto alcance
- ▶ Dos intensidades de luz
- ▶ Útil para trabajos con libertad de movimiento
- ▶ Hasta 8 horas de iluminación continua
- ▶ Multiposiciones 90°
- ▶ Clavija retráctil para recarga

6 meses GARANTÍA



Ficha TÉCNICA



CÓDIGO	No. DE LEDS	CARGAS ÚTILES			DISTRIB.	MAYOREO	LISTA
305232	1	250 aprox.	6	36	\$60.00	\$86.00	\$106.00
305231	7	250 aprox.	6	36	\$60.00	\$86.00	\$106.00

La linterna debe ser recargada regularmente, de no ser usada se debe recargar 1 vez cada 3 meses descargándola previamente.

Foco de emergencia

PROX.

NOM

CAJA

- ▶ Foco A19
- ▶ Base E27
- ▶ Luz blanca
- ▶ 750 lm
- ▶ Hasta 4 horas de iluminación
- ▶ Ideal para campamento

1 año GARANTÍA



CÓDIGO			DISTRIB.	MAYOREO	LISTA
120911	10	40	\$90.00	\$129.00	\$160.00

El foco debe ser recargado regularmente, de no ser usado se debe recargar 1 vez cada 3 meses descargándolo previamente.

*Las horas de iluminación indicada es con la intensidad baja.

Los productos de alta rotación se encuentran distinguidos por el color rojo en su código.

La apariencia del producto puede llegar a variar • Ventas y atención a clientes 55-5383-4412

Lámpara recargable extermina mosquitos con linterna

PROX.

CAJA

- ▶ Lámpara portátil
- ▶ La luz púrpura atrae los insectos, quedando atrapados en el interior de la linterna
- ▶ Linterna con luz ajustable a 3 modos: luz alta, baja y flash
- ▶ Recargable con cable USB
- ▶ No tóxica



NOM

1

año GARANTÍA

CÓDIGO		DISTRIB.	MAYOREO	LISTA
111622	24	\$340.00	\$485.00	\$600.00

La lámpara debe ser recargada regularmente, de no ser usada se debe recargar 1 vez cada 3 meses descargándolo previamente.

Luminario recargable con cargador USB

CAJA

- ▶ Doble panel con 60 LEDs
- ▶ Ideal para iluminar cualquier área de trabajo y recargar celulares
- ▶ Hasta 12 horas* de iluminación continua
- ▶ Práctico puerto de salida USB
- ▶ Panel multi posiciones
- ▶ Cable removible



NOM

1

año GARANTÍA

Soft GRIP
*SUQV2



Ficha TÉCNICA

CÓDIGO	No. DE LEDES	CARGAS ÚTILES			DISTRIB.	MAYOREO	LISTA
118101	60	250 aprox.	6	24	\$355.00	\$505.00	\$625.00

El luminario debe ser recargado regularmente, de no ser usado se debe recargar 1 vez cada 3 meses descargándolo previamente.

Luminario de emergencia recargable, 99 LEDs

CAJA

- ▶ 99 LEDs con dos intensidades de luz
- ▶ Práctica asa retráctil y cordón de encendido
- ▶ Ideal para iluminar cualquier área de trabajo
- ▶ Hasta 10 horas de iluminación continua en intensidad de luz baja
- ▶ Hasta 5 horas de iluminación continua en intensidad de luz alta
- ▶ Cordón de carga removible



NOM

1

año GARANTÍA

CÓDIGO	No. DE LEDES	CARGAS ÚTILES			DISTRIB.	MAYOREO	LISTA
118103	99	250 aprox.	6	24	\$355.00	\$505.00	\$625.00

El luminario debe ser recargado regularmente, de no ser usado se debe recargar 1 vez cada 3 meses descargándolo previamente.

Linterna recargable + extermina mosquitos

BOLSA

- ▶ Raqueta metálica recargable
- ▶ Mango ergonómico
- ▶ Silencioso y seguro en su uso
- ▶ Interruptor de 2 posiciones
- ▶ Linterna recargable de 1 LED



RAQUETA Y LINTERNA RECARGABLE



LINTERNA EN LA PARTE INFERIOR



NOM

1

año GARANTÍA



Ficha TÉCNICA

CÓDIGO	No. DE LEDES			DISTRIB.	MAYOREO	LISTA
111695	1	10	40	\$140.00	\$200.00	\$245.00

La raqueta debe ser recargada regularmente, de no ser usada se debe recargar 1 vez cada 3 meses descargándolo previamente.

Luminario de emergencia recargable

CAJA

- ▶ LEDs de alta potencia
- ▶ Dos intensidades de luz
- ▶ Práctica asa retráctil
- ▶ Ideal para iluminar cualquier área de trabajo
- ▶ Hasta 8 horas* de iluminación continua



NOM

1

año GARANTÍA

CÓDIGO	No. DE LEDES	CARGAS ÚTILES			DISTRIB.	MAYOREO	LISTA
305205	30	250 aprox.	6	24	\$140.00	\$200.00	\$245.00
305206	60	250 aprox.	6	12	\$220.00	\$315.00	\$390.00
305207	90	250 aprox.	5	10	\$290.00	\$415.00	\$510.00

El luminario debe ser recargado regularmente, de no ser usado se debe recargar 1 vez cada 3 meses descargándolo previamente.





► Lazos, lentes, lijas, limas, llanas, llaves, lonas y más.

Lazo de polipropileno

CARRETE

- ▶ Uso industrial, agrícola y casero
- ▶ Resistente a la abrasión
- ▶ 100% polipropileno
- ▶ Precio por carrete
- ▶ El peso aproximado puede variar en un +/- 5 %

INCLUYE CARRETE



CÓDIGO	DIÁMETRO	PESO APROX.	DISTRIB.	MAYOREO	LISTA
113611	3/16" - 4 mm	10 kg ± 5%	\$950.00	\$1,355.00	\$1,675.00
113612	1/4" - 6 mm	22 kg ± 5%	\$2,100.00	\$3,000.00	\$3,705.00
113613	5/16" - 8 mm	22 kg ± 5%	\$2,100.00	\$3,000.00	\$3,705.00
113614	3/8" - 10 mm	27 kg ± 5%	\$2,550.00	\$3,645.00	\$4,500.00
113615	1/2" - 13 mm	40 kg ± 5%	\$3,800.00	\$5,430.00	\$6,705.00
113617	5/8" - 16 mm	40 kg ± 5%	\$3,800.00	\$5,430.00	\$6,705.00
113618	3/4" - 19 mm	40 kg ± 5%	\$3,800.00	\$5,430.00	\$6,705.00

Incluye carrete, el peso indicado es en peso bruto

Lazo de polipropileno

CARRETE

- ▶ Uso agrícola y casero
- ▶ Resistente a la abrasión
- ▶ 90% polipropileno, 10% polietileno
- ▶ Precio por carrete
- ▶ El peso aproximado puede variar en un +/- 5 %

INCLUYE CARRETE



CÓDIGO	DIÁMETRO	PESO APROX.	DISTRIB.	MAYOREO	LISTA
308111	3/16" - 4 mm	10 kg ± 5%	\$890.00	\$1,270.00	\$1,570.00
308112	1/4" - 6 mm	22 kg ± 5%	\$1,900.00	\$2,715.00	\$3,350.00
308113	5/16" - 8 mm	22 kg ± 5%	\$1,900.00	\$2,715.00	\$3,350.00
308114	3/8" - 10 mm	26 kg ± 5%	\$2,350.00	\$3,355.00	\$4,145.00
308115	1/2" - 13 mm	40 kg ± 5%	\$3,450.00	\$4,930.00	\$6,085.00
308116	5/8" - 16 mm	40 kg ± 5%	\$3,450.00	\$4,930.00	\$6,085.00
308117	3/4" - 19 mm	40 kg ± 5%	\$3,450.00	\$4,930.00	\$6,085.00

Incluye carrete, el peso indicado es en peso bruto

Lente de seguridad deportivo

TARJETA

- ▶ Micas de policarbonato (mayor resistencia a impactos)
- ▶ Varillas cubiertas de PVC suave
- ▶ Diseño ligero y ergonómico



CÓDIGO	COLOR	6	36	DISTRIB.	MAYOREO	LISTA
107806	Transparente	6	36	\$35.00	\$50.00	\$62.00
107807	Negro	6	36	\$35.00	\$50.00	\$62.00
107808	Azul	6	36	\$35.00	\$50.00	\$62.00
107809	Rojo	6	36	\$35.00	\$50.00	\$62.00
107810	Amarillo	6	36	\$35.00	\$50.00	\$62.00

Lente de seguridad

BOLSA

- ▶ Micas de policarbonato (mayor resistencia a impactos)
- ▶ Sistema de ventilación antiempañante



CÓDIGO	COLOR	10	100	DISTRIB.	MAYOREO	LISTA
107801	Transparente	10	100	\$23.00	\$33.00	\$41.00
107802	Amarillo	10	100	\$23.00	\$33.00	\$41.00
107803	Negro	10	100	\$23.00	\$33.00	\$41.00

Goggles de seguridad

TARJETA

- ▶ Protege los ojos contra impactos, polvo, chispas, astilladuras y salpicaduras
- ▶ Ventilación directa, antiempañante
- ▶ Mica fabricada en policarbonato



18 meses GARANTÍA



CÓDIGO	6	60	DISTRIB.	MAYOREO	LISTA
306601	6	60	\$25.00	\$36.00	\$44.00

Lente de seguridad ligero

CABALLETE

- ▶ Material: Policarbonato antirrayadura
- ▶ Protección UV



10 años GARANTÍA



CÓDIGO	COLOR	12	144	DISTRIB.	MAYOREO	LISTA
107821	Transparente	12	144	\$23.00	\$33.00	\$41.00
107822	Negro	12	144	\$23.00	\$33.00	\$41.00
107823	Amarillo	12	144	\$23.00	\$33.00	\$41.00

Lente de seguridad ajustable

BOLSA

- ▶ Material: Policarbonato antirrayadura
- ▶ Patillas ajustables



10 años GARANTÍA



CÓDIGO	COLOR	6	36	DISTRIB.	MAYOREO	LISTA
107811	Transparente	6	36	\$23.00	\$33.00	\$41.00
107812	Negro	6	36	\$23.00	\$33.00	\$41.00

Gafas para soldar y repuestos

CABALLETE

- ▶ Marco facial con cinta elástica
- ▶ Sombra No. 6
- ▶ Ideal para soldar y para uso en oxiacorte
- ▶ Repuestos de policarbonato



105832

105831



CÓDIGO	ACABADO	6	36	DISTRIB.	MAYOREO	LISTA
105802	Gafas	6	36	\$70.00	\$100.00	\$123.00
105831	Cristal transparente	20	120	\$8.00	\$11.40	\$14.10
105832	Filtro 6 sombras	20	120	\$8.00	\$11.40	\$14.10

Lija de agua

FAJILLA

- ▶ Papel impermeable
- ▶ Ideal para laca, pintura, pasta automotriz, metal, acabados en vidrio, mármol y fibra de vidrio
- ▶ 9" x 11"



CARBURO DE SILICIO



CÓDIGO	GRANO		DISTRIB.	MAYOREO	LISTA
113301	80	10 juegos	\$6.00	\$8.60	\$10.60
113302	100	10 juegos	\$5.60	\$8.00	\$9.90
113303	120	10 juegos	\$5.40	\$7.70	\$9.50
113304	150	10 juegos	\$5.20	\$7.40	\$9.20
113305	180	10 juegos	\$5.00	\$7.10	\$8.80
113306	220	10 juegos	\$5.00	\$7.10	\$8.80
113307	240	10 juegos	\$5.00	\$7.10	\$8.80
113308	280	10 juegos	\$5.00	\$7.10	\$8.80
113309	320	10 juegos	\$5.00	\$7.10	\$8.80
113310	360	10 juegos	\$5.00	\$7.10	\$8.80
113311	400	10 juegos	\$5.00	\$7.10	\$8.80
113312	500	10 juegos	\$5.00	\$7.10	\$8.80
113313	600	10 juegos	\$5.00	\$7.10	\$8.80
113314	1000	10 juegos	\$9.00	\$12.90	\$15.90
113315	1200	10 juegos	\$9.00	\$12.90	\$15.90

Lijas de agua para repintado automotriz

PROX.

FAJILLA

- ▶ Incluye: 6 Lijas de agua 5 1/2" x 9" grano 1000 ó 2000



CARBURO DE SILICIO



CÓDIGO	GRANO		DISTRIB.	MAYOREO	LISTA
113371	1000	25 juegos	\$30.00	\$43.00	\$53.00
113372	2000	25 juegos	\$30.00	\$43.00	\$53.00

Lija para madera papel cabinet

FAJILLA

- ▶ Papel cabinet
- ▶ Ideal para lijado de madera y recubrimientos
- ▶ 9" x 11"



ÓXIDO DE ALUMINIO



CÓDIGO	GRANO		DISTRIB.	MAYOREO	LISTA
113316	36	10 juegos	\$8.00	\$11.40	\$14.10
113317	40	10 juegos	\$7.00	\$10.00	\$12.30
113318	50	10 juegos	\$6.00	\$8.60	\$10.60
113319	60	10 juegos	\$6.00	\$8.60	\$10.60
113320	80	10 juegos	\$5.00	\$7.10	\$8.80
113321	100	10 juegos	\$4.50	\$6.40	\$7.90
113322	120	10 juegos	\$4.50	\$6.40	\$7.90
113323	150	10 juegos	\$4.50	\$6.40	\$7.90
113324	180	10 juegos	\$4.50	\$6.40	\$7.90

Lija para madera papel kraft

FAJILLA

- ▶ Papel kraft
- ▶ Ideal para lijado de pasta, superficie de yeso y madera sin acabado profesional
- ▶ 9" x 11"



ÓXIDO DE ALUMINIO



CÓDIGO	GRANO		DISTRIB.	MAYOREO	LISTA
113325	50	10 juegos	\$4.50	\$6.40	\$7.90
113326	80	10 juegos	\$4.00	\$5.70	\$7.10
113327	120	10 juegos	\$4.00	\$5.70	\$7.10

Juego de lijas para madera

PROX.

FAJILLA

- ▶ Incluye: 3 Hojas 9" x 11"
- ▶ Grano: 220, 100 y 60



ÓXIDO DE ALUMINIO



CÓDIGO			DISTRIB.	MAYOREO	LISTA
113376	25 juegos	250 juegos	\$36.00	\$51.00	\$64.00



NUEVAS LIJAS

Repintado automotriz
Yeso . Madera . Metal



Conoce las novedades en lijado que AKSI® pone a tu disposición

Lija para plomero

CAJA

- ▶ Para limpieza, aplicación de adhesivos en plomería y rayado de superficies
- ▶ Respaldo de tela
- ▶ Ideal para madera, plástico, metal ferroso y no ferroso



ÓXIDO DE ALUMINIO



CÓDIGO	GRANO	MEDIDAS	DISTRIB.	MAYOREO	LISTA
113336	120	5 m x 1 1/2" 6 48	\$45.00	\$64.00	\$79.00
113337	120	45 m x 1 1/2" 4 12	\$255.00	\$365.00	\$450.00

Lija de banda

FAJILLA

- ▶ Óxido de aluminio
- ▶ Respaldo de tela flexible
- ▶ Ideal para madera, metales ferrosos y no ferrosos



ÓXIDO DE ALUMINIO



CÓDIGO	GRANO	MEDIDAS	DISTRIB.	MAYOREO	LISTA
113351	36	3 x 21" 4 juegos 20 juegos	\$60.00	\$86.00	\$106.00
113352	40	3 x 21" 4 juegos 20 juegos	\$60.00	\$86.00	\$106.00
113353	60	3 x 21" 4 juegos 20 juegos	\$60.00	\$86.00	\$106.00
113354	80	3 x 21" 4 juegos 20 juegos	\$60.00	\$86.00	\$106.00
113355	120	3 x 21" 4 juegos 20 juegos	\$60.00	\$86.00	\$106.00
113356	36	4 x 24" 4 juegos 20 juegos	\$85.00	\$121.00	\$150.00
113357	40	4 x 24" 4 juegos 20 juegos	\$85.00	\$121.00	\$150.00
113358	60	4 x 24" 4 juegos 20 juegos	\$85.00	\$121.00	\$150.00
113359	80	4 x 24" 4 juegos 20 juegos	\$85.00	\$121.00	\$150.00
113360	120	4 x 24" 4 juegos 20 juegos	\$85.00	\$121.00	\$150.00

Lija de esmeril negra

FAJILLA

- ▶ Respaldo de tela flexible
- ▶ Ideal para metal, plástico, eliminación de óxido y operación de limpieza
- ▶ 9" x 11"



ÓXIDO DE ALUMINIO



CÓDIGO	GRANO	DISTRIB.	MAYOREO	LISTA	
113328	36	10 juegos	\$12.00	\$17.10	\$21.20
113329	50	10 juegos	\$11.00	\$15.70	\$19.40
113330	80	10 juegos	\$10.00	\$14.30	\$17.60
113331	120	10 juegos	\$9.60	\$13.70	\$16.90

Lija de esmeril roja

FAJILLA

- ▶ Respaldo de tela flexible
- ▶ Ideal para madera, plástico y metales blandos
- ▶ 9" x 11"



ÓXIDO DE ALUMINIO



CÓDIGO	GRANO	DISTRIB.	MAYOREO	LISTA	
113332	36	10 juegos	\$15.00	\$21.40	\$26.00
113333	50	10 juegos	\$14.00	\$20.00	\$24.70
113334	80	10 juegos	\$12.00	\$17.10	\$21.20
113335	120	10 juegos	\$10.00	\$14.30	\$17.60

Esponja abrasiva

PROX.

FAJILLA

- ▶ Fabricada de óxido de aluminio
- ▶ Ideal para molduras, partes planas y curvas
- ▶ Para madera, plástico, metal y yeso
- ▶ Otorga un lijado uniforme y suave
- ▶ Mismo tipo de grano en ambas caras



ÓXIDO DE ALUMINIO



CÓDIGO	TAMAÑO	GRANO	DISTRIB.	MAY.	LISTA	
113381	4 3/4 x 4 x 1/2"	100	25	\$21.00	\$30.00	\$37.00
113382	3 3/4 x 2 3/4 x 1"	60	25	\$33.00	\$47.00	\$58.00
113383	3 3/4 x 2 3/4 x 1"	150	25	\$23.00	\$33.00	\$41.00

Lija para yeso / tablaroca

PROX.

FAJILLA

- ▶ Incluye: 3 Hojas 3 2/3" x 9" - grano 100
- ▶ Respaldo de papel pesado
- ▶ Proporciona un acabado muy suave



CARBURO DE SILICIO



CÓDIGO	GRANO	DISTRIB.	MAYOREO	LISTA	
113374	100	25 juegos 250 juegos	\$16.00	\$22.90	\$28.00

Lija para metal

PROX.

FAJILLA

- ▶ Incluye: 3 Hojas 3 2/3" x 9" - grano 150
- ▶ Grano rojo



ÓXIDO DE ALUMINIO



CÓDIGO	GRANO	DISTRIB.	MAYOREO	LISTA	
113375	150	25 juegos 250 juegos	\$16.00	\$22.90	\$28.00

Lima triángulo pesado, bastarda

GRANEL

- ▶ Ideal para esquinas terminadas en punta y ángulos rectos
- Bastarda: dientes más grandes para mayor desbaste, más de 0.5 mm de espesor**

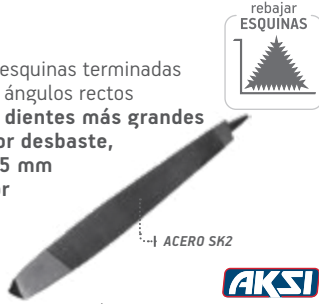

CÓDIGO	LARGO - ANCHO	DISTRIB.	MAYOREO	LISTA	
108501	4" x 25/64"	12 480	\$11.00	\$15.70	\$19.40
108502	5" x 29/64"	12 120	\$12.00	\$17.10	\$21.20
108503	6" x 15/32"	12 120	\$13.00	\$18.60	\$22.90
108504	7" x 35/64"	12 120	\$24.00	\$34.00	\$42.00
108505	8" x 5/8"	12 120	\$29.00	\$41.00	\$51.00

Lima triángulo regular, muza

GRANEL

- ▶ Ideal para esquinas terminadas en punta y ángulos rectos
- ▶ Para afilar machetes, hachas, cuchillos y herramientas similares
- Muza: dientes pequeños para menor desbaste menos de 0.5 mm de espesor**

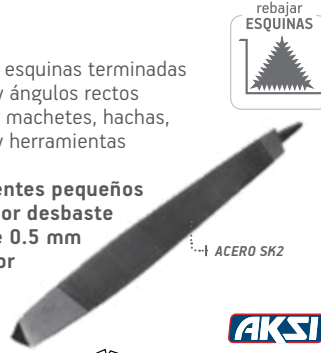

CÓDIGO	LARGO - ANCHO	DISTRIB.	MAYOREO	LISTA	
108506	6" x 15/32"	12 120	\$13.00	\$18.60	\$22.90
108507	7" x 35/64"	12 120	\$22.00	\$31.00	\$39.00
108508	8" x 5/8"	12 120	\$25.00	\$36.00	\$44.00

Lima triángulo doble

GRANEL

- ▶ Ideal para esquinas terminadas en punta y ángulos rectos
- ▶ Para afilar sierras y serrotes con dientes en ángulo de 60°, así como cuchillos y tijeras

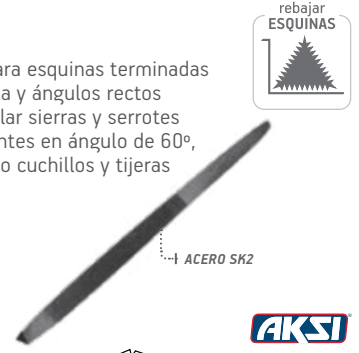

CÓDIGO	LARGO - ANCHO	DISTRIB.	MAYOREO	LISTA	
108509	6" x 13/64"	12 120	\$18.00	\$26.00	\$32.00
108510	7" x 13/64"	12 120	\$20.00	\$29.00	\$35.00
108511	8" x 1/4"	12 120	\$22.00	\$31.00	\$39.00

Lima plana bastarda

GRANEL

- ▶ Ideal para desbastes rápidos en acabados ásperos
- ▶ Para trabajos en acero o hierro
- Bastarda: dientes más grandes para mayor desbaste, más de 0.5 mm de espesor**

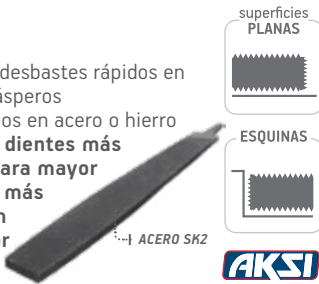

CÓDIGO	LARGO - ANCHO y ESPESOR	DISTRIB.	MAYOREO	LISTA	
108512	4" x 7/16" x 7/64"	12 576	\$19.00	\$27.00	\$34.00
108513	6" x 5/8" x 5/32"	12 72	\$23.00	\$33.00	\$41.00
108514	8" x 25/32" x 13/64"	12 72	\$33.00	\$47.00	\$58.00
108515	10" x 1" x 1/4"	12 72	\$48.00	\$69.00	\$85.00
108516	12" x 1 1/4" x 5/16"	6 60	\$75.00	\$107.00	\$132.00
108517	14" x 1 7/16" x 11/32"	6 60	\$97.00	\$139.00	\$170.00

Lima plana, muza

GRANEL

- ▶ Para trabajos en acero o hierro
- Muza: dientes pequeños para menor desbaste menos de 0.5 mm de espesor**



CÓDIGO	LARGO - ANCHO y ESPESOR	DISTRIB.	MAYOREO	LISTA	
108518	4" x 1/2" x 1/8"	12 576	\$23.00	\$33.00	\$41.00
108519	6" x 5/8" x 5/32"	12 72	\$24.00	\$34.00	\$42.00
108520	8" x 13/16" x 13/64"	12 72	\$35.00	\$50.00	\$62.00
108521	10" x 1" x 15/64"	12 72	\$50.00	\$71.00	\$88.00
108522	12" x 1 3/16" x 9/32"	6 60	\$80.00	\$114.00	\$141.00
108523	14" x 1 3/8" x 5/16"	6 60	\$120.00	\$170.00	\$210.00

Lima media caña, muza

GRANEL

- ▶ Ideal para usarse sobre madera, aluminio, plomo o materiales blandos
- Muza: dientes pequeños para menor desbaste menos de 0.5 mm de espesor**



CÓDIGO	LARGO - ANCHO y ESPESOR	DISTRIB.	MAYOREO	LISTA	
108531	6" x 5/8" x 3/16"	12 72	\$36.00	\$51.00	\$64.00
108532	8" x 13/16" x 1/4"	12 72	\$48.00	\$69.00	\$85.00
108533	10" x 1" x 9/32"	12 72	\$86.00	\$123.00	\$150.00
108534	12" x 13/16" x 3/8"	6 60	\$105.00	\$150.00	\$185.00

Lima escofina media caña, bastarda

GRANEL

- ▶ Para trabajos en madera, aluminio, plomo y otros materiales blandos
- Bastarda: dientes más grandes para mayor desbaste, más de 0.5 mm de espesor**



CÓDIGO	LARGO - ANCHO y ESPESOR	DISTRIB.	MAYOREO	LISTA	
108544	6" x 9/16" x 15/64"	12 72	\$33.00	\$47.00	\$58.00
108545	8" x 13/16" x 5/16"	12 72	\$49.00	\$70.00	\$86.00
108546	10" x 31/32" x 11/32"	12 72	\$67.00	\$96.00	\$118.00
108547	12" x 1 3/16" x 27/64"	6 60	\$95.00	\$136.00	\$170.00

Lima para motosierra

GRANEL

- ▶ Dientes de mayor filo, especiales para afilar dientes de motosierra

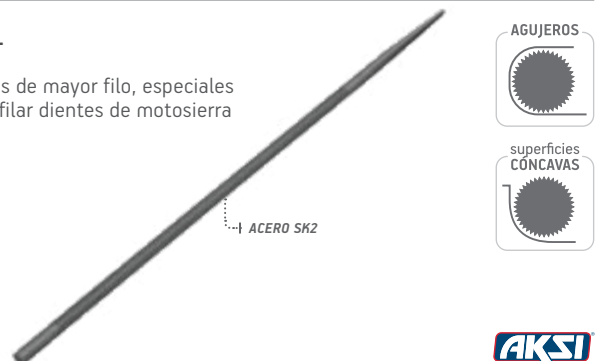

CÓDIGO	LARGO - DIÁMETRO	DISTRIB.	MAYOREO	LISTA	
108524	8" x 5/32"	12 120	\$23.00	\$33.00	\$41.00
108525	8" x 3/16"	12 120	\$23.00	\$33.00	\$41.00
108526	8" x 7/32"	12 120	\$23.00	\$33.00	\$41.00

Lima media caña, bastarda

GRANEL

- ▶ Ideal para desbaste áspero o rugoso
- Bastarda: dientes más grandes para mayor desbaste, más de 0.5 mm de espesor**

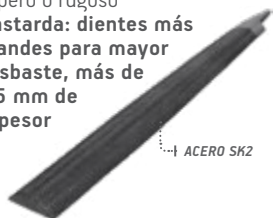

ACERO SK2

CÓDIGO	LARGO - ANCHO y ESPESOR		DISTRIB.	MAYOREO	LISTA
108527	6" x 5/8" x 3/16"	12 72	\$33.00	\$47.00	\$58.00
108528	8" x 13/16" x 1/4"	12 72	\$43.00	\$61.00	\$76.00
108529	10" x 1" x 5/16"	12 72	\$62.00	\$89.00	\$109.00
108530	12" x 13/16" x 3/8"	6 60	\$86.00	\$123.00	\$150.00

AKSI

Lima redonda, muza

GRANEL

- ▶ Útil para desbastes finos
- ▶ Ideal para ajustar y pulir circunferencias



ACERO SK2

CÓDIGO	LARGO - ANCHO y ESPESOR		DISTRIB.	MAYOREO	LISTA
108540	6" x 1/4"	12 72	\$24.00	\$34.00	\$42.00
108541	8" x 5/16"	12 72	\$30.00	\$43.00	\$53.00
108542	10" x 3/8"	12 72	\$40.00	\$57.00	\$71.00
108543	12" x 1/2"	6 60	\$62.00	\$89.00	\$109.00

AKSI

Lima redonda, bastarda

GRANEL

- ▶ Útil para desbastes rápidos
- ▶ Ideal para limar o desbastar circunferencias
- Bastarda: dientes más grandes para mayor desbaste, más de 0.5 mm de espesor**

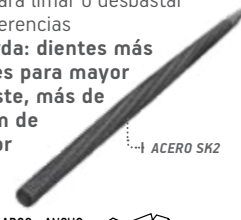

ACERO SK2

CÓDIGO	LARGO - ANCHO y ESPESOR		DISTRIB.	MAYOREO	LISTA
108535	4" x 9/64"	12 576	\$18.00	\$26.00	\$32.00
108536	6" x 1/4"	12 72	\$19.00	\$27.00	\$34.00
108537	8" x 5/16"	12 72	\$24.00	\$34.00	\$42.00
108538	10" x 3/8"	12 72	\$35.00	\$50.00	\$62.00
108539	12" x 1/2"	6 72	\$57.00	\$81.00	\$101.00

AKSI

Llana lisa

GRANEL

- ▶ Resistente mango de ABS
- ▶ Acabado: pulido
- ▶ Ideal para extender y alisar cemento, mortero, yeso, etc. y aplanar mezcla



ACERO AL ALTO CARBONO

CÓDIGO	TAMAÑO		DISTRIB.	MAYOREO	LISTA
101210	11" x 5"	12 72	\$55.00	\$79.00	\$97.00

AKSI

Llana dentado cuadrado

GRANEL

- ▶ Resistente mango de ABS
- ▶ Acabado: pulido
- ▶ Ideal para aplicar cementos o adhesivos al colocar cerámica o piedra, permitiendo salida de aire para mayor agarre



ACERO AL ALTO CARBONO

CÓDIGO	TAMAÑO		DISTRIB.	MAYOREO	LISTA
101211	11" x 5"	12 72	\$55.00	\$79.00	\$97.00

AKSI

Llana dentado triángulo

GRANEL

- ▶ Resistente mango de ABS
- ▶ Acabado: pulido
- ▶ Ideal para aplicar cementos o adhesivos al colocar cerámica o piedra, permitiendo salida de aire para mayor agarre



ACERO AL ALTO CARBONO

CÓDIGO	TAMAÑO		DISTRIB.	MAYOREO	LISTA
101212	11" x 5"	12 72	\$55.00	\$79.00	\$97.00

AKSI

Llave universal para filtro de aceite

BLÍSTER

- ▶ Quijadas con mejor agarre
- ▶ Para utilizarse con matraca cuadrado de 3/8"
- ▶ Capacidad de apertura: MÁXIMA 3 7/8" (98 mm) MÍNIMA 2 1/2" (64 mm)



PARA USO CON MATRACA CUADRO DE 3/8"

10 años GARANTÍA
AKSI

CÓDIGO	PARA FILTRO DE		DISTRIB.	MAYOREO	LISTA
119904	2 1/2" - 3 7/8"	3 36	\$105.00	\$150.00	\$185.00

Llave de banda de Nylon® para filtro de aceite

BLÍSTER

- ▶ Afloja y aprieta filtros de aceite sin dañarlos
- ▶ Con banda antiderrapante
- ▶ Entrada para utilizarse con matraca cuadrado de 1/2"



PARA USO CON MATRACA CUADRO DE 1/2"

1 año GARANTÍA
AKSI

CÓDIGO	MEDIDA		DISTRIB.	MAYOREO	LISTA
119903	Hasta 6"	6 36	\$77.00	\$110.00	\$136.00

Llave de banda metálica para filtro de aceite

BLÍSTER

- ▶ Banda de acero al carbono con estructura resistente a la torsión
- ▶ Mango giratorio cubierto de vinil



1 año GARANTÍA
AKSI

CÓDIGO	PARA FILTRO DE		DISTRIB.	MAYOREO	LISTA
119901	2 1/2" - 3 1/4"	6 36	\$69.00	\$99.00	\$122.00
119902	3 1/4" - 3 3/4"	6 36	\$69.00	\$99.00	\$122.00

Llave de esfera de aleación de zinc

GRANEL

- ▶ Resistente a la corrosión
- ▶ Flujo de agua regulable
- ▶ Cierre hermético evita fugas
- ▶ Maneral de 1/4 de vuelta



CONECTOR PARA ENSAMBLE DE MANGUERA



CÓDIGO	MEDIDA			DISTRIB.	MAYOREO	LISTA
107601	1/2"	6	180	\$30.00	\$43.00	\$53.00

Llave de jardín de latón cromado

GRANEL

- ▶ Resistente a la corrosión
- ▶ Flujo de agua regulable
- ▶ Cierre hermético evita fugas
- ▶ Acabado cromo brillante



ROSCA DE 2 CUERDAS



CÓDIGO	MEDIDA			DISTRIB.	MAYOREO	LISTA
107603	1/2"	12	120	\$68.00	\$97.00	\$120.00

Llave de jardín de latón

GRANEL

- ▶ Resistente a la corrosión
- ▶ Flujo de agua regulable
- ▶ Cierre hermético evita fugas



ROSCA DE 2 CUERDAS



CÓDIGO	MEDIDA			DISTRIB.	MAYOREO	LISTA
107602	1/2"	12	120	\$50.00	\$71.00	\$88.00
107604	3/4"	6	120	\$70.00	\$100.00	\$123.00

Llave angular de latón

GRANEL

- ▶ Fabricadas en latón con acabado cromo brillante
- ▶ Cuerda de: 1/2" x 1/2"



CÓDIGO	MEDIDA	TIPO			DISTRIB.	MAYOREO	LISTA
109601	1/2"	Barril	12	144	\$55.00	\$79.00	\$97.00
109603	1/2"	Cuerda	12	144	\$45.00	\$64.00	\$79.00

Llave angular metálica

GRANEL

- ▶ Fabricadas en aleación metálica con acabado cromo brillante
- ▶ Cuerda de: 1/2" x 1/2"



CÓDIGO	MEDIDA	TIPO			DISTRIB.	MAYOREO	LISTA
303501	1/2"	Barril	12	144	\$32.00	\$46.00	\$56.00
303502	1/2"	Cuerda	12	144	\$29.00	\$41.00	\$51.00

Llave para jardín de 1/2"

GRANEL Y BLÍSTER

- ▶ Resistente a la corrosión
- ▶ Flujo de agua regulable
- ▶ Cierre hermético evita fugas
- ▶ Cuerpo de aleación metálica



CÓDIGO	PRESENTACIÓN			DISTRIB.	MAYOREO	LISTA
306101	Granel	24	120	\$25.00	\$36.00	\$44.00
306102	Blíster	6	120	\$35.00	\$50.00	\$62.00

Válvula de compuerta roscable y soldable

GRANEL

- ▶ Para agua, aceite y gas
- ▶ Cuerpo fabricado en latón sólido
- ▶ Presión máxima 150 PSI



CÓDIGO	TIPO	DIÁMETRO			DISTRIB.	MAYOREO	LISTA
113205	Roscable	1/2"	6	48	\$70.00	\$100.00	\$123.00
113206	Roscable	3/4"	6	48	\$90.00	\$129.00	\$160.00
113207	Soldable	1/2"	6	48	\$70.00	\$100.00	\$123.00
113208	Soldable	3/4"	6	48	\$90.00	\$129.00	\$160.00

Válvula de esfera roscable y soldable

GRANEL

- ▶ Para agua, aceite y gas
- ▶ Cuerpo fabricado en latón sólido
- ▶ Presión máxima 200 PSI



CÓDIGO	TIPO	DIÁMETRO			DISTRIB.	MAYOREO	LISTA
113201	Roscable	1/2"	6	48	\$50.00	\$71.00	\$88.00
113202	Roscable	3/4"	6	48	\$75.00	\$107.00	\$132.00
113203	Soldable	1/2"	6	48	\$48.00	\$69.00	\$85.00
113204	Soldable	3/4"	6	48	\$70.00	\$100.00	\$123.00

Válvula roscable para gas

GRANEL

- ▶ Cuerpo fabricado en latón sólido
- ▶ Presión máxima 200 PSI



CÓDIGO	MEDIDA	TIPO			DISTRIB.	MAYOREO	LISTA
109701	1/2" X 3/8"	Roscable	10	100	\$45.00	\$64.00	\$79.00
109702	1/2" X 5/16"	Roscable	10	100	\$45.00	\$64.00	\$79.00

Llave ajustable con mango de vinil (perico)

PROX.

TARJETA

- ▶ Forjada en acero al carbono
- ▶ Mango recubierto de vinil, para mejor agarre
- ▶ Suave acción de apertura y cierre



10 años
GARANTÍA
AKSI

CÓDIGO	TAMAÑO			DISTRIB.	MAYOREO	LISTA
131501	6"	6	120	\$65.00	\$93.00	\$115.00
131502	8"	6	96	\$85.00	\$121.00	\$150.00
131503	10"	6	60	\$130.00	\$185.00	\$230.00
131504	12"	6	36	\$175.00	\$250.00	\$310.00

Llave ajustable pavonada con mango de vinil (perico)

PROX.

TARJETA

- ▶ Forjada en acero al carbono
- ▶ Mango recubierto de vinil, para mejor agarre
- ▶ Suave acción de apertura y cierre



10 años
GARANTÍA
AKSI

CÓDIGO	TAMAÑO			DISTRIB.	MAYOREO	LISTA
131511	6"	6	120	\$65.00	\$93.00	\$115.00
131512	8"	6	96	\$85.00	\$121.00	\$150.00
131513	10"	6	60	\$130.00	\$185.00	\$230.00
131514	12"	6	36	\$175.00	\$250.00	\$310.00

Llave profesional para tubo (Stilson®)

GRANEL

- ▶ Mordazas forjadas en acero al Cromo Vanadio
- ▶ Cuerpo de hierro nodular, mayor torque y resistencia a la deformación



10 años
GARANTÍA
AKSI

*Stilson® es una marca registrada

CÓDIGO	TAMAÑO			DISTRIB.	MAYOREO	LISTA
104211	8"	6	36	\$105.00	\$150.00	\$185.00
104212	10"	6	24	\$140.00	\$200.00	\$245.00
104213	12"	6	24	\$170.00	\$245.00	\$300.00
104214	14"	3	12	\$220.00	\$315.00	\$390.00
104215	18"	2	8	\$320.00	\$455.00	\$565.00
104216	24"	N/A	4	\$510.00	\$730.00	\$900.00

Llave ajustable pavonada (perico)

GRANEL

- ▶ Forjada en acero al carbono
- ▶ Suave acción de apertura y cierre



18 meses
GARANTÍA
IT MAXTOOL

CÓDIGO	APERTURA	TAMAÑO			DISTRIB.	MAYOREO	LISTA
302105	3/4"	6"	6	120	\$45.00	\$64.00	\$79.00
302106	15/16"	8"	6	96	\$60.00	\$86.00	\$106.00
302107	1 1/8"	10"	6	60	\$90.00	\$129.00	\$160.00
302108	1 5/16"	12"	6	36	\$115.00	\$165.00	\$205.00

Llave ajustable pavonada (perico)

TARJETA

- ▶ Forjada en acero al carbono
- ▶ Suave acción de apertura y cierre



18 meses
GARANTÍA
IT MAXTOOL

CÓDIGO	APERTURA	TAMAÑO			DISTRIB.	MAYOREO	LISTA
302113	3/4"	6"	6	120	\$50.00	\$71.00	\$88.00
302114	15/16"	8"	6	60	\$65.00	\$93.00	\$115.00
302115	1 1/8"	10"	6	60	\$95.00	\$136.00	\$170.00
302116	1 5/16"	12"	6	36	\$120.00	\$170.00	\$210.00

Llave para tubo ajustable (Stilson®)

GRANEL

- ▶ Cuerpo de hierro forjado
- ▶ Mordazas forjadas en acero al carbón



18 meses
GARANTÍA
IT MAXTOOL

*Stilson® es una marca registrada

CÓDIGO	TAMAÑO			DISTRIB.	MAYOREO	LISTA
301201	8"	6	48	\$70.00	\$100.00	\$123.00
301202	10"	6	36	\$90.00	\$129.00	\$160.00
301203	12"	6	24	\$115.00	\$165.00	\$205.00
301204	14"	4	12	\$145.00	\$205.00	\$255.00
301205	18"	4	12	\$220.00	\$315.00	\$390.00
301206	24"	2	6	\$315.00	\$450.00	\$555.00

Llave ajustable cromada (perico)

GRANEL

- ▶ Forjada en acero al carbono
- ▶ Suave acción de apertura y cierre



18 meses
GARANTÍA
IT MAXTOOL

CÓDIGO	APERTURA	TAMAÑO			DISTRIB.	MAYOREO	LISTA
302101	3/4"	6"	6	120	\$45.00	\$64.00	\$79.00
302102	15/16"	8"	6	96	\$60.00	\$86.00	\$106.00
302103	1 1/8"	10"	6	60	\$90.00	\$129.00	\$160.00
302104	1 5/16"	12"	6	36	\$115.00	\$165.00	\$205.00

Llave ajustable cromada (perico)

TARJETA

- ▶ Forjada en acero al carbono
- ▶ Suave acción de apertura y cierre



18 meses
GARANTÍA
IT MAXTOOL

CÓDIGO	APERTURA	TAMAÑO			DISTRIB.	MAYOREO	LISTA
302109	3/4"	6"	6	120	\$50.00	\$71.00	\$88.00
302110	15/16"	8"	6	60	\$65.00	\$93.00	\$115.00
302111	1 1/8"	10"	6	60	\$95.00	\$136.00	\$170.00
302112	1 5/16"	12"	6	36	\$120.00	\$170.00	\$210.00

Llave ajustable cromada (perico)

BLÍSTER

- ▶ Forjada en acero al carbono
- ▶ Suave acción de apertura y cierre



18 meses
GARANTÍA
IT MAXTOOL

CÓDIGO	APERTURA	TAMAÑO			DISTRIB.	MAYOREO	LISTA
302117	3/4"	6"	6	120	\$55.00	\$79.00	\$97.00
302118	15/16"	8"	6	60	\$70.00	\$100.00	\$123.00
302119	1 1/8"	10"	6	60	\$100.00	\$143.00	\$175.00
302120	1 5/16"	12"	6	36	\$135.00	\$195.00	\$240.00

Llave para plomero

TARJETA

- ▶ Diseñada para su uso en lugares de difícil acceso
- ▶ Longitud: 12"



CÓDIGO	TAMAÑO			DISTRIB.	MAYOREO	LISTA
112601	12"	6	24	\$115.00	\$165.00	\$205.00

Llave para tanque de gas

GRANEL

- ▶ Fabricada en acero al carbono
- ▶ Cuadro de 3/8"



CÓDIGO	TAMAÑO			DISTRIB.	MAYOREO	LISTA
112602	7/8"	6	60	\$43.00	\$61.00	\$76.00

Llaves de cruz 18" y 20"

GRANEL

- ▶ Acabado pulido y cromado
- ▶ 17 mm, 3/4", 13/16", 7/8"



CÓDIGO	MEDIDA			DISTRIB.	MAYOREO	LISTA
116301	18"	N/A	12	\$175.00	\$250.00	\$310.00
116302	20"	N/A	12	\$200.00	\$285.00	\$355.00

Llave de cruz de 14"

GRANEL

- ▶ Pintura gris metálica
- ▶ 17 mm, 3/4", 13/16", 7/8"

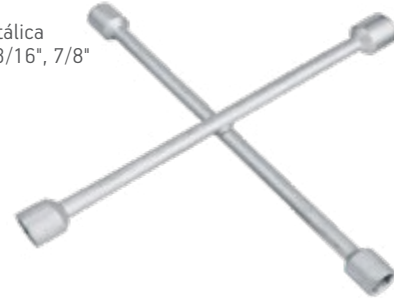

CÓDIGO	MEDIDA		DISTRIB.	MAYOREO	LISTA
305321	14"	12	\$105.00	\$150.00	\$185.00

Llaves de cruz plegable 14"

BOLSA

- ▶ Acabado pulido y cromado
- ▶ 17 mm, 3/4", 13/16", 7/8"



CÓDIGO	MEDIDA			DISTRIB.	MAYOREO	LISTA
116311	14"	3	12	\$200.00	\$285.00	\$355.00

Llaves combinadas estándar y milimétricas, juego de 5

ESTUCHE

- ▶ Forjadas en acero al carbono



MEDIDAS mm	std
8 mm	3/8"
10 mm	7/16"
11 mm	1/2"
12 mm	9/16"
13 mm	5/8"



CÓDIGO	MEDIDA			DISTRIB.	MAYOREO	LISTA
305301	std	6	36	\$115.00	\$165.00	\$205.00
305302	mm	6	36	\$110.00	\$155.00	\$195.00

Llaves Allen® tipo navaja, juego de 8

TARJETA

- ▶ Fabricadas en acero Cromo Vanadio
- ▶ Mango de caucho texturizado para un mejor agarre

*Allen® es una marca registrada

MEDIDAS mm	Std
1,5 mm	1/16"
2 mm	5/64"
2,5 mm	3/32"
3 mm	1/8"
4 mm	5/32"
5 mm	3/16"
6 mm	1/4"
8 mm	5/16"



CÓDIGO	MEDIDA			DISTRIB.	MAYOREO	LISTA
115801	mm	6	36	\$60.00	\$86.00	\$106.00
115802	std	6	36	\$60.00	\$86.00	\$106.00

Llaves Allen® tipo llavero, juego de 8

BOLSA

- ▶ Fabricadas en acero al carbono

*Allen® es una marca registrada

MEDIDAS mm	Std
1,5 mm	1/16"
2 mm	5/64"
2,5 mm	3/32"
3 mm	1/8"
4 mm	5/32"
5 mm	3/16"
5,5 mm	7/32"
6 mm	1/4"



CÓDIGO	MEDIDA			DISTRIB.	MAYOREO	LISTA
308601	std	12	144	\$17.00	\$24.30	\$30.00
308602	mm	12	144	\$17.00	\$24.30	\$30.00

Lona de polietileno uso rudo 180 g/m²

BOLSA

- ▶ Refuerzo de plástico rígido en las esquinas con ojillos de aluminio
- ▶ Composición de 3 capas con refuerzo de rafia
- ▶ Gramaje: 180 g / m²
- ▶ Espesor: 0.25 mm
- ▶ Hilos x pulgada²: 14 x 14

OJILLOS DE ALUMINIO



3 CAPAS DE REFUERZO



REFUERZO EN DRILLAS



CÓDIGO	MEDIDA			DISTRIB.	MAYOREO	LISTA
101702	2 m x 3 m	3	12	\$100.00	\$143.00	\$175.00
101703	3 m x 3 m	3	12	\$145.00	\$205.00	\$255.00
101704	3 m x 4 m	2	10	\$190.00	\$270.00	\$335.00
101705	4 m x 5 m	2	6	\$310.00	\$445.00	\$545.00
101706	4 m x 6 m	2	6	\$365.00	\$520.00	\$645.00
101707	5 m x 6 m	N/A	3	\$460.00	\$655.00	\$810.00
101708	6 m x 12 m	N/A	1	\$1,100.00	\$1,570.00	\$1,940.00
101709	12 m x 17 m	N/A	2	\$3,000.00	\$4,285.00	\$5,290.00

Lona básica de polietileno 90 g/m²

BOLSA

- ▶ Ojillos de aluminio distribuidos
- ▶ Refuerzo de plástico rígido en las esquinas
- ▶ Doble recubrimiento impermeable
- ▶ Gramaje: 90 g / m²
- ▶ Espesor: 0.11 mm
- ▶ Hilos x pulgada²: 8 x 8



AZUL							ROJA							VERDE						
CÓDIGO	MEDIDA			DISTRIB.	MAYOREO	LISTA	CÓDIGO	MEDIDA			DISTRIB.	MAYOREO	LISTA	CÓDIGO	MEDIDA			DISTRIB.	MAYOREO	LISTA
302422	2 m x 3 m	4	20	\$50.00	\$71.00	\$88.00	302430	2 m x 3 m	4	20	\$50.00	\$71.00	\$88.00	302441	2 m x 3 m	4	20	\$50.00	\$71.00	\$88.00
302423	3 m x 3 m	4	20	\$70.00	\$100.00	\$123.00	302431	3 m x 3 m	4	20	\$70.00	\$100.00	\$123.00	302442	3 m x 3 m	4	20	\$70.00	\$100.00	\$123.00
302424	3 m x 4 m	4	20	\$95.00	\$136.00	\$170.00	302432	3 m x 4 m	4	20	\$95.00	\$136.00	\$170.00	302443	3 m x 4 m	4	20	\$95.00	\$136.00	\$170.00
302425	4 m x 5 m	2	10	\$160.00	\$230.00	\$280.00	302433	4 m x 5 m	2	10	\$160.00	\$230.00	\$280.00	302444	4 m x 5 m	2	10	\$160.00	\$230.00	\$280.00
302426	4 m x 6 m	2	6	\$185.00	\$265.00	\$325.00	302434	4 m x 6 m	2	6	\$185.00	\$265.00	\$325.00	302445	4 m x 6 m	2	6	\$185.00	\$265.00	\$325.00
302427	5 m x 6 m	N/A	3	\$230.00	\$330.00	\$405.00	302435	5 m x 6 m	N/A	3	\$230.00	\$330.00	\$405.00	302446	5 m x 6 m	N/A	3	\$230.00	\$330.00	\$405.00
302428	6 m x 12 m	N/A	2	\$550.00	\$785.00	\$970.00	302436	6 m x 12 m	N/A	2	\$550.00	\$785.00	\$970.00	302447	6 m x 12 m	N/A	2	\$550.00	\$785.00	\$970.00

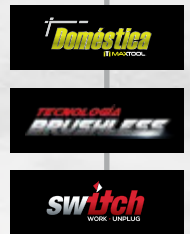

máquinas
INALÁMBRICAS

► Rotomartillo . taladro . llave de impacto . esmeriladora . lijadora . sierra . clavadora . accesorios y más.



ROTOMARTILLO
TALADRO Y DESTORNILLADOR
1/2" - 20 V

APLICACIONES:

- De uso particular moderado y profesional en talleres de herrería, carpintería, cancelería, etc.
- Ideal para desatornillar, atornillar y perforar en madera, plástico, metal no ferroso, concreto, losas y pisos



TALADRO
Y DESTORNILLADOR
3/8" - 20 V

APLICACIONES:

- Ideal para atornillar, desatornillar y perforar en madera, plástico, metal no ferroso, tablaroca



ROTOMARTILLO, TALADRO Y DESTORNILLADOR 196012

Tensión	20 V c.d.
Velocidad 1	400 rev / min
Velocidad 2	1 600 rev / min
Posición de torque	21 + 2 (Taladro - rotomartillo)
Dirección de rotación	Delante / Reversa
Funciones	Rotomartillo / Taladro / Destornillador
Broquero	1/2" (13 mm) metálico
Capacidad de perforación	
Acero	∅ 3/8" (10 mm)
Madera	∅ 1" (25,4 mm)
Concreto	∅ 3/8" (10 mm)
Batería ION-LITIO incluida	
Cargador incluido	

Ventajas de mi herramienta

- Ergonómico, menor esfuerzo al perforar.
- Selector con 3 funciones: rotomartillo, taladro y destornillador.
- Función reversible.
- Broquero metálico de apriete manual.
- Cargador con indicador de carga
- Luz LED de trabajo.

ACCESORIOS PARA MI ROTOMARTILLO

BATERÍAS COMPATIBLES

196502	20 V c.d. / 2 Ah	\$580.00	\$830.00	\$1,025.00
196503	20 V c.d. / 3 Ah	\$870.00	\$1,245.00	\$1,535.00

CARGADOR COMPATIBLE

196511	20 V	\$120.00	\$170.00	\$210.00
196512	20 V (carga rápida)	\$240.00	\$345.00	\$425.00

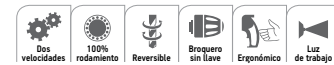

¿QUÉ INCLUYE MI HERRAMIENTA?

1 Batería 2 Ah
1 Cargador estándar
1 Punta combinada cruz / plana
Garantía e instructivo con listado de centros de servicio.

196012

MODELO: INL-DRT-20p-AK

Garantía 1 Año

Caja a color

DISTRIB.	MAYOREO	LISTA
\$1,600.00	\$2,285.00	\$2,820.00



TALADRO Y DESTORNILLADOR 196003

Tensión	20 V c.d.
Velocidad 1	600 rev / min
Posición de torque	15 + 1 (Taladro)
Dirección de rotación	Delante / Reversa
Funciones	Taladro / Destornillador
Broquero	3/8" (10 mm) 24 UNF plástico
Capacidad de perforación	
Acero	∅ 5/16" (8 mm)
Madera	∅ 3/4" (20 mm)
Concreto	∅ 3/8" (10 mm)
Batería ION-LITIO incluida	
Cargador incluido	

Ventajas de mi herramienta

- Ergonómico, menor esfuerzo al perforar.
- Selector con 2 funciones: taladro y destornillador.
- Función reversible.
- Broquero plástico de apriete manual.
- Cargador con indicador de carga total
- Luz LED de trabajo.

ACCESORIOS PARA MI TALADRO

BATERÍAS COMPATIBLES

196501	20 V c.d. / 1.5 Ah	\$460.00	\$655.00	\$810.00
196502	20 V c.d. / 2 Ah	\$580.00	\$830.00	\$1,025.00

CARGADOR COMPATIBLE

196511	20 V	\$940.00	\$1,345.00	\$1,660.00
196512	20 V (carga rápida)	\$240.00	\$345.00	\$425.00



¿QUÉ INCLUYE MI HERRAMIENTA?

1 Batería 1.5 Ah
1 cargador estándar
1 punta combinada cruz / plana
Garantía e instructivo con listado de centros de servicio.

196003

MODELO: INL-DTL-20p-AK

Garantía 1 Año

Caja a color

DISTRIB.	MAYOREO	LISTA
\$1,100.00	\$1,570.00	\$1,940.00



LLAVE DE IMPACTO**1/2" - 20 V****APLICACIONES:**

- De uso particular moderado y profesional en taller automotriz
- Ideal para extraer y apretar tornillos y tuercas en cualquier ensamble o unión

Switch
 WORK · UNPLUG
**ESMERILADORA****ANGULAR****4 1/2" - 20 V****APLICACIONES:**

- De uso particular moderado y profesional en taller automotriz, herrería, hojalatería, plomería y cancelería
- Desbaste de metal, concreto, mármol, etc.
- Corte de metal, remoción de óxido en general

Switch
 WORK · UNPLUG

Tensión	20 V c.d.
Velocidad	2 000 rev / min
Torque	Apriete: 350 Nm Extracción: 450 Nm
Dirección de rotación	Delante / Reversa
Funciones	Extracción y atornillado
Cuadro de mando	1/2" (13 mm)
Batería ION-LITIO incluida	20 V c.d. / 4 Ah
Cargador incluido	Carga rápida

196021

Tensión	20 V c.d.
Velocidad	2 000 rev / min
Torque	Apriete: 350 Nm Extracción: 450 Nm
Dirección de rotación	Delante / Reversa
Funciones	Extracción y atornillado
Cuadro de mando	1/2" (13 mm)
Batería ION-LITIO incluida	20 V c.d. / 4 Ah
Cargador incluido	Carga rápida

Ventajas de mi herramienta

- Función reversible.
- Cargador con luz indicadora de carga total de batería.
- Luz LED de trabajo.

**ACCESORIOS PARA MI LLAVE DE IMPACTO****BATERÍAS COMPATIBLES**

196503	20 V c.d. / 3 Ah	\$870.00	\$1,245.00	\$1,535.00
196504	20 V c.d. / 4 Ah	\$940.00	\$1,345.00	\$1,660.00

**CARGADOR COMPATIBLE**

196511	20 V	\$120.00	\$170.00	\$210.00
196512	20 V (carga rápida)	\$240.00	\$345.00	\$425.00

¿QUÉ INCLUYE MI HERRAMIENTA?

- 1 Batería 4 Ah
- 1 Cargador estándar
- 1 Pija
- 1 Broche para colgar
- Garantía e instructivo con listado de centros de servicio.

196021

MODELO: INL-LIM-20p-AK

Garantía 1 Año



Caja a color

NOM

DISTRIB.	MAYOREO	LISTA
\$2,350.00	\$3,355.00	\$4,145.00

Ventajas de mi herramienta

- Guarda con sistema de ajuste rápido.
- Porta llave.
- Ergonómico, menor esfuerzo al lijar.
- Emite pocas vibraciones para trabajar sin fatiga.
- Indicador de consumo de batería en carga y descarga.
- Cargador con luz indicadora de carga total de batería.

**ACCESORIOS PARA MI ESMERILADORA****BATERÍAS COMPATIBLES**

196503	20 V c.d. / 3 Ah	\$870.00	\$1,245.00	\$1,535.00
196504	20 V c.d. / 4 Ah	\$940.00	\$1,345.00	\$1,660.00

**CARGADOR COMPATIBLE**

196511	20 V	\$120.00	\$170.00	\$210.00
196512	20 V (carga rápida)	\$240.00	\$345.00	\$425.00

¿QUÉ INCLUYE MI HERRAMIENTA?

- 1 Batería 4 Ah
- 1 Cargador estándar
- 1 Disco abrasivo de 4 1/2"
- 1 Guarda
- 1 Par de bridas
- 1 Mango porta llave
- 1 Llave
- Garantía e instructivo con listado de centros de servicio.

196031

MODELO: INL-EAG-20p-AK

Garantía 1 Año



Caja a color

NOM

DISTRIB.	MAYOREO	LISTA
\$2,100.00	\$3,000.00	\$3,705.00

**LIJADORA
ROTO-ORBITAL
5" - 20 V==**

APLICACIONES:

- De uso particular moderado y profesional en taller automatizado, hojalatería y carpintería
- Con amplia gama de aplicaciones de lijado en madera y metal



5" (13 cm)

ALMOHADILLA



[TIPS DE USO!]

**SIERRA CIRCULAR
6 1/2" - 20 V==**

APLICACIONES:

- De uso particular moderado y profesional en carpintería
- Cortes rectos y biselados en madera



6 1/2" (16.5 cm)

SIERRA DE CORTE



[TIPS DE USO!]

196041

Tensión	20 V c.d.
Velocidad	10 500 - 11 000 orbitas / min orbital / roto-orbital
Funciones	Almohadilla orbital Almohadilla mouse
Batería ION-LITIO incluida	20 V c.d. / 2 Ah
Cargador incluido	Carga estándar

Tensión	20 V c.d.
Velocidad	10 500 - 11 000 orbitas / min orbital / roto-orbital
Diámetro de disco	ø 5" (130 mm)
Diámetro de flecha	140 mm x 100 mm
Profundidad de corte	20 V c.d. / 2 Ah
Batería ION-LITIO incluida	Carga estándar
Cargador incluido	

Ventajas de mi herramienta

- Ergonómica, menor esfuerzo al lijar.
- Emite pocas vibraciones para trabajar sin fatiga.
- Recolección de polvo a través de adaptador.
- Cargador con luz indicadora de carga total de batería.
- Luz LED de trabajo.



ACCESORIOS PARA MI LIJADORA



BATERÍAS COMPATIBLES

196502	20 V c.d. / 2 Ah	\$580.00	\$830.00	\$1,025.00
196503	20 V c.d. / 3 Ah	\$870.00	\$1,245.00	\$1,535.00



CARGADOR COMPATIBLE

196511	20 V	\$120.00	\$170.00	\$210.00
196512	20 V (carga rápida)	\$240.00	\$345.00	\$425.00

¿QUÉ INCLUYE MI HERRAMIENTA?

- 1 Batería 2 Ah
- 1 Cargador estándar
- 1 Recolector de polvo
- 1 Almohadilla orbital de 5"
- 1 Almohadilla mouse
- 2 Lijas
- Tornillería
- Garantía e instructivo con listado de centros de servicio.

196041

MODELO: INL-LRO-20p-AK

Garantía 1 Año



Caja a color



DISTRIB.	MAYOREO	LISTA
\$1,350.00	\$1,930.00	\$2,380.00

ACCESORIOS PARA MI SIERRA CIRCULAR



BATERÍAS COMPATIBLES

196503	20 V c.d. / 3 Ah	\$870.00	\$1,245.00	\$1,535.00
196504	20 V c.d. / 4 Ah	\$940.00	\$1,345.00	\$1,660.00



CARGADOR COMPATIBLE

196511	20 V	\$120.00	\$170.00	\$210.00
196512	20 V (carga rápida)	\$240.00	\$345.00	\$425.00



SIERRAS AKSI®

Página 394

196061

Tensión	20 V c.d.
Velocidad	5 000 rev / min
Diámetro de disco	6 1/2" (165 mm)
Diámetro de flecha	5/8" (16 mm)
Profundidad de corte	0° 65 mm
Batería ION-LITIO incluida	20 V c.d. / 4 Ah
Cargador incluido	Carga rápida

Tensión	20 V c.d.
Velocidad	5 000 rev / min
Diámetro de disco	6 1/2" (165 mm)
Diámetro de flecha	5/8" (16 mm)
Profundidad de corte	0° 65 mm
Batería ION-LITIO incluida	20 V c.d. / 4 Ah
Cargador incluido	Carga rápida

Ventajas de mi herramienta

- Profundidad de corte regulable con escala para referencia rápida.
- Sierra de carburo de tungsteno de 24 dientes para cortes rápidos.
- Ergonómica, menor esfuerzo al cortar.
- Expulsión de virutas optimizada para una mejor visión.
- Indicador de consumo de batería en carga y descarga.
- Cargador con luz indicadora de carga total de batería.



¿QUÉ INCLUYE MI HERRAMIENTA?

- 1 Batería 4 Ah
- 1 Cargador rápido
- Tornillo
- Bridas
- 1 Disco sierra
- 1 Llave
- 1 Regla guía
- Garantía e instructivo con listado de centros de servicio.

196061

MODELO: INL-SCR-6-1/2p-AK

Garantía 1 Año



Caja a color



DISTRIB.	MAYOREO	LISTA
\$2,150.00	\$3,070.00	\$3,790.00



SIERRA CALADORA 20 V ==

APLICACIONES:

- De uso particular moderado y profesional en carpintería
- Ideal para cortes precisos en madera, plástico y acero



switch
WORK · UNPLUG



CLAVADORA 18 GA - 20 V ==

APLICACIONES:

- De uso particular moderado y profesional en carpintería y tapicería
- Uniones de madera por medio de grapas y clavos.



switch
WORK · UNPLUG



Tensión	20 V c.d.
Velocidad	2 400 carreras / min
Tipo de segueta	Tipo "T"
Long. de carrera	20 mm
Posiciones pendulares	0 / 1 / 2 / 3
Ángulo de operaciones	0° / 45°

Capacidad de corte

Madera

Metal

Batería ION-LITIO incluida

Cargador incluido

196071

Tensión	20 V c.d.
Calibre	18 GA
Capacidad de clavo	3/4" 1" 1 3/16" 1 1/4" 1 1/2" 1 9/16" 1 3/4" 2"
Capacidad de grapa	3/4" 7/8" 1" 1 1/8" 1 1/4" 1 1/2" 1 9/16"
Tensión	20 V c.d. / 2 Ah
Cargador incluido	Carga rápida

25 mm

2 mm

20 V c.d. / 2 Ah

Carga estándar

Tensión	20 V c.d.
Calibre	18 GA
Capacidad de clavo	3/4" 1" 1 3/16" 1 1/4" 1 1/2" 1 9/16" 1 3/4" 2"
Capacidad de grapa	3/4" 7/8" 1" 1 1/8" 1 1/4" 1 1/2" 1 9/16"
Tensión	20 V c.d. / 2 Ah
Cargador incluido	Carga rápida

Batería ION-LITIO incluida

Cargador incluido

Ventajas de mi herramienta

196081

Tensión	20 V c.d.
Calibre	18 GA
Capacidad de clavo	3/4" 1" 1 3/16" 1 1/4" 1 1/2" 1 9/16" 1 3/4" 2"
Capacidad de grapa	3/4" 7/8" 1" 1 1/8" 1 1/4" 1 1/2" 1 9/16"
Tensión	20 V c.d. / 2 Ah
Cargador incluido	Carga rápida

20 V c.d. / 2 Ah

Carga rápida

Ventajas de mi herramienta

- Ajuste de base para cortes en ángulos de 0° y 45°
- 4 posiciones pendulares.
- Ergonómica y ligera.
- Indicador de consumo de batería.
- Cargador con luz indicadora de carga total de batería.



! ¿QUÉ INCLUYE MI HERRAMIENTA?

- 1 Batería 2 Ah
- 1 Cargador estándar
- 1 Llave hexagonal
- Garantía e instructivo con listado de centros de servicio.

196071

MODELO: INL-SCL-20p-AK

Garantía 1 Año

4



Caja a color

NOM

DISTRIB.	MAYOREO	LISTA
\$1,600.00	\$2,285.00	\$2,820.00

ACCESORIOS PARA MI CLAVADORA



BATERÍAS COMPATIBLES

196501	20 V c.d. / 1.5 Ah	\$460.00	\$655.00	\$810.00
196502	20 V c.d. / 2 Ah	\$580.00	\$830.00	\$1,025.00
196503	20 V c.d. / 3 Ah	\$870.00	\$1,245.00	\$1,535.00



CARGADOR COMPATIBLE

196511	20 V	\$120.00	\$170.00	\$210.00
196512	20 V (carga rápida)	\$240.00	\$345.00	\$425.00



! ¿QUÉ INCLUYE MI HERRAMIENTA?

- 1 Batería 2 Ah
- 1 Cargador rápido
- 1 Llave
- Garantía e instructivo con listado de centros de servicio.

196081

MODELO: INL-ECL-20p-AK

Garantía 1 Año

3



Caja a color

NOM

DISTRIB.	MAYOREO	LISTA
\$3,250.00	\$4,645.00	\$5,735.00

MULTIFUNCIONAL
450 PSI - 20 V

- Hidrolavadora
- Aspiradora
- Sopladora
- Infladora

APLICACIONES:

- De uso moderado en el hogar
- Ideal para limpieza en superficies como pisos, paredes, autos, serpentines e inflado de neumáticos



Tensión	20 V c.d.
Velocidad	2 000 rev / min
Presión salida de agua	450 PSI máximo
Manómetro neumático	110 PSI máximo permisible
Manguera	5/16" (8 mm) x 5.8 m
Ángulo de operación	0° 25° 40°
Tiempo de inflado (neumático rin 15")	6,5 min (7 neumáticos hasta agotar batería)
Ciclo de batería	Aspirar, enjabonar, lavar un automóvil compacto

Batería ION-LITIO incluida
Cargador incluido

196201

20 V c.d.
2 000 rev / min
450 PSI máximo
110 PSI máximo permisible
5/16" (8 mm) x 5.8 m
0° 25° 40°
6,5 min (7 neumáticos hasta agotar batería)
Aspirar, enjabonar, lavar un automóvil compacto
20 V c.d. / 4 Ah
Carga rápida

Ventajas de mi herramienta

- 4 Funciones en una sola herramienta: hidrolavadora, aspiradora, sopladora e infladora.
- Utiliza una manguera para toma de agua desde una cubeta o recipiente de 10 litros.
- Con maleta de transporte y almacenamiento de accesorios.
- Una sola batería realiza trabajo de aspirado, lavado e inflado de neumáticos de manera simultánea (en autos compactos).
- Ergonómica y ligera.
- Indicador de consumo de batería en carga y descarga.
- Cargador con luz indicadora de carga total de la batería.



ACCESORIOS PARA MI MULTIFUNCIONAL



BATERÍAS COMPATIBLES

196504	20 V c.d. / 4 Ah	
\$940.00	\$1,345.00	\$1,660.00



CARGADOR COMPATIBLE

196511	20 V	
\$120.00	\$170.00	\$210.00
196512	20 V (carga rápida)	
\$240.00	\$345.00	\$425.00

¿QUÉ INCLUYE MI HERRAMIENTA?

- | | |
|----------------------|--|
| 1 Batería 4 Ah | Lanza |
| 1 Cargador rápido | Extensión |
| Maleta | Bomba de agua |
| Boquilla | Manguera 5/16" (8 mm) x 5.8 m |
| Recolector de basura | Recipiente para jabón |
| Filtro | Manómetro |
| Soplador | Garantía e instructivo con listado de centros de servicio. |

196201

MODELO: INL-MULTI-20p-AK
Garantía 1 Año



Caja a color



DISTRIB.	MAYOREO	LISTA
\$4,000.00	\$5,715.00	\$7,055.00



TECNOLOGÍA BRUSHLESS SIN CARBONES

Motor "Brushless"

CIRCUITO

Reemplaza el conmutador de un típico montaje con escobillas.

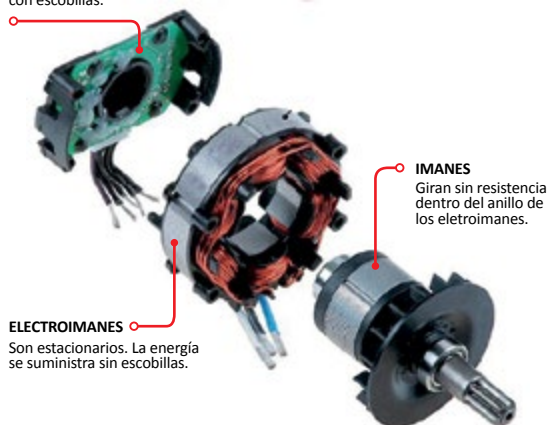

ELECTROIMANES
Son estacionarios. La energía se suministra sin escobillas.

IMANES

Giran sin resistencia dentro del anillo de los electroimanes.

Motor con escobillas

ESCOBILLAS

Conducen la electricidad de la batería al conmutador.

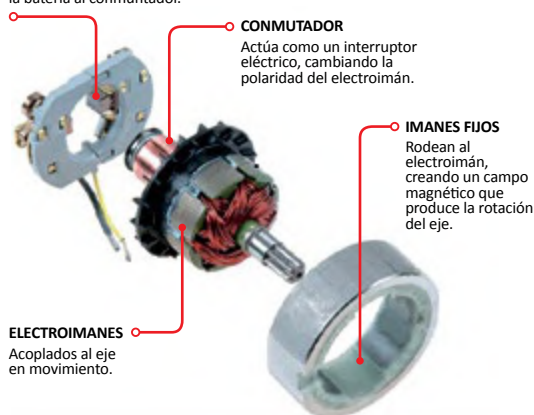

CONMUTADOR

Actúa como un interruptor eléctrico, cambiando la polaridad del electroimán.

IMANES FIJOS

Rodean al electroimán, creando un campo magnético que produce la rotación del eje.

ELECTROIMANES
Acoplados al eje en movimiento.

¿Qué es la tecnología BRUSHLESS?

La palabra **BRUSHLESS** se traduce a "motor sin escobillas". Las máquinas con motores sin escobillas son un gran avance en tecnología inalámbrica para herramientas eléctricas.

El carecer de escobillas significa que este tipo de motor no experimenta la caída de voltaje ni la fricción que se producen con un motor estándar. Esto implica:

1. Menor cantidad de piezas sujetas a desgaste, lo que aumenta la vida útil del motor y el rendimiento general.
2. Menor pérdida de energía en fricción y calor, por lo que ese ahorro de energía se invierte para crear un mayor torque.

La tecnología brushless ofrece grandes ventajas en nuestras herramientas AKSI®



Mayor torsión y velocidad de rotación



Mayor durabilidad de la batería



Mayor durabilidad de la herramienta



Menor calentamiento de la herramienta



Funcionamiento silencioso



Requiere menor mantenimiento



Herramienta compacta y ligera

ROTOMARTILLO

TALADRO Y DESTORNILLADOR

1/2" - 20 V₌₌**TALADRO**

Y DESTORNILLADOR

1/2" - 20 V₌₌

APLICACIONES:

- De uso particular moderado y profesional en talleres de herrería, carpintería, cancelería, etc.
- Ideal para trabajos en madera, plástico, metal no ferroso, concreto, losas y pisos

**ROTOMARTILLO - 1/2"**

cód. 196013

**TALADRO - 1/2"**

cód. 196004

**SIN CARBONES****SIN CARBONES****TSI**ROTOMARTILLO,
TALADRO Y
DESTORNILLADOR**196013**

Tensión
Velocidad 1
Velocidad 2
Posición de torque
Dirección de rotación
Funciones
Broquero

Capacidad de perforación

Acero
Madera
Concreto

Batería ION-LITIO incluida**Cargador incluido**

20 V c.d.
400 rev / min
1 500 rev / min
16 + 2 (Taladro - rotomartillo)
Delante / Reversa
Rotomartillo / Taladro / Destornillador
1/2" (13 mm) metálico

∅ 3/8" (10 mm)
∅ 1" (25,4 mm)
∅ 3/8" (10 mm)

20 V c.d. / 2 Ah
Carga estándar

SITALADRO Y
DESTORNILLADOR**196004**

20 V c.d.
400 rev / min
1 500 rev / min
16 + 1 (Taladro)
Delante / Reversa
Taladro / Destornillador
1/2" (13 mm) metálico

∅ 3/8" (10 mm)
∅ 1" (25,4 mm)

20 V c.d. / 2 Ah
Carga estándar

Ventajas de mi herramienta

ACCESORIOS PARA MI
ROTOMARTILLO o TALADRO**BATERÍAS COMPATIBLES**

196505	20 V c.d. / 2 Ah	
\$410.00	\$585.00	\$725.00

**CARGADOR COMPATIBLE**

196513	20 V	
\$205.00	\$295.00	\$360.00

- Ergonómico, menor esfuerzo al perforar.
- Selector con 3 funciones: rotomartillo, taladro y destornillador.
- Selector de velocidad alta y baja.
- Función reversible.
- Broquero metálico de apriete manual.
- Luz LED de trabajo.

**¿QUÉ INCLUYE MI HERRAMIENTA?**

1 Batería 2 Ah, 1 cargador estándar, 2 puntas combinadas cruz / plana, 1 pija, 1 broche para colgar y garantía e instructivo con listado de centros de servicio.

196013

MODELO: INL-SCR-20p-AK

Garantía 1 Año

6



Caja a color

NOM

DISTRIB.	MAYOREO	LISTA
\$1,800.00	\$2,570.00	\$3,175.00

**¿QUÉ INCLUYE MI HERRAMIENTA?**

1 Batería 2 Ah, 1 cargador estándar, 2 puntas combinadas cruz /plana, 1 pija, broche para colgar y garantía e instructivo con listado de centros de servicio.

196004

MODELO: INL-SCT-20p-AK

Garantía 1 Año

6



Caja a color

NOM

DISTRIB.	MAYOREO	LISTA
\$1,500.00	\$2,145.00	\$2,645.00

**MÁQUINAS
SIN CARBONES**
196013 y 196004



TECNOLOGÍA EN BATERÍAS ION-LITIO: Larga vida con mínimo mantenimiento. Excelente desempeño frente a los diferentes cambios de temperatura. Mantiene la tensión constante durante casi 90% del ciclo de descarga. Batería con indicador de consumo.

ROTOMARTILLO TALADRO Y DESTORNILLADOR 1/2"

APLICACIONES:

- De uso doméstico moderado, en talleres de herrería, carpintería, cancelería, etc.
- Ideal para desatornillar, atornillar y perforar en madera, plástico, metal no ferroso y concreto ligero



20 V - 1/2"

cód. 396121



ROTOMARTILLO TALADRO Y DESTORNILLADOR 3/8"

APLICACIONES:

- De uso doméstico moderado, en talleres de herrería, carpintería, cancelería, etc.
- Ideal para desatornillar, atornillar y perforar en madera, plástico, metal no ferroso y concreto ligero



12 V - 3/8"

cód. 396122



Tensión
Velocidad 1
Velocidad 2
Posición de torque
Dirección de rotación
Funciones
Broquero

Capacidad de perforación

Acero
Madera
Concreto
Batería ION-LITIO incluida
Cargador incluido

ROTOMARTILLO,
TALADRO Y
DESTORNILLADOR

396121

20 V c.d.
0 - 400 rev/min
0 - 1400 rev/min
18 + 2 (20 Nm)
Delante / Reversa
Rotomartillo / Taladro / Destornillador
1/2" (13 mm) plástico

Ø 3/8" (10 mm)
Ø 1" (25.4 mm)
Ø 3/8" (10 mm)
20 V c.d. / 2 Ah
Carga estándar

Tensión
Velocidad 1
Velocidad 2
Posición de torque
Dirección de rotación
Funciones
Broquero

Capacidad de perforación

Acero
Madera
Concreto
Batería ION-LITIO incluida
Cargador incluido

ROTOMARTILLO,
TALADRO Y
DESTORNILLADOR

396122

12 V c.d.
0 - 400 rev/min
0 - 1400 rev/min
18 + 2 (12 Nm)
Delante / Reversa
Rotomartillo / Taladro / Destornillador
3/8" (10 mm) plástico

Ø 3/8" (10 mm)
Ø 1" (25.4 mm)
Ø 3/8" (10 mm)
12 V c.d. / 2 Ah
Carga estándar

Ventajas de mi herramienta

- Ergonómico, menor esfuerzo al perforar.
- Selector con 3 funciones: rotomartillo, taladro y destornillador.
- Función reversible.
- Broquero plástico de apriete manual.
- Equipado con luz LED.



Ventajas de mi herramienta

- Ergonómico, menor esfuerzo al perforar.
- Selector con 3 funciones: rotomartillo, taladro y destornillador.
- Función reversible.
- Broquero plástico de apriete manual.
- Equipado con luz LED.



ACCESORIOS PARA MI ROTOMARTILLO



BATERÍAS COMPATIBLES

396211	20 V c.d. / 2 Ah
\$405.00	\$580.00 \$715.00



CARGADOR COMPATIBLE

396551	20 V
\$110.00	\$155.00 \$195.00

¿QUÉ INCLUYE MI HERRAMIENTA?

- 1 Batería 2 Ah
- 1 Cargador estándar
- Garantía e instructivo con listado de centros de servicio.

396121

MODELO: INL-DRT-20-MX

Garantía 6 Meses

10



Caja a color

DISTRIB.	MAYOREO	LISTA
\$950.00	\$1,355.00	\$1,675.00

ACCESORIOS PARA MI ROTOMARTILLO



BATERÍAS COMPATIBLES

396212	12 V c.d. / 2 Ah
\$330.00	\$470.00 \$580.00



CARGADOR COMPATIBLE

396552	12 V
\$75.00	\$107.00 \$132.00

¿QUÉ INCLUYE MI HERRAMIENTA?

- 1 Batería 2 Ah
- 1 Cargador estándar
- Garantía e instructivo con listado de centros de servicio.

396122

MODELO: INL-DRT-12-MX

Garantía 6 Meses

10



Caja a color

DISTRIB.	MAYOREO	LISTA
\$680.00	\$970.00	\$1,200.00

TALADRO Y DESTORNILLADOR 3/8"

APLICACIONES:

- De uso doméstico moderado
- Ideal para desatornillar, atornillar y perforar en madera, plástico, metal no ferroso y tablaroca



20 V - 3/8"
cód. 396111



Doméstica
MAXTOOL

TALADRO Y DESTORNILLADOR 3/8"

APLICACIONES:

- De uso doméstico moderado
- Ideal para desatornillar, atornillar y perforar en madera, plástico, metal no ferroso y tablaroca



12 V - 3/8"
cód. 396112



Doméstica
MAXTOOL



TALADRO Y DESTORNILLADOR **396111**

Tensión	20 V c.d.
Velocidad 1	0 - 650 rev/min
Velocidad 2	-----
Posición de torque	18 + 1 (14 - 25 Nm)
Dirección de rotación	Delante / Reversa
Funciones	Taladro / Destornillador
Broquero	3/8" (10 mm) 24 UNF

Capacidad de perforación

Acero	Ø 5/16" (8 mm)
Madera	Ø 3/4" (20 mm)

Batería ION-LITIO incluida

Cargador incluido

20 V c.d. / 1.3 Ah
Carga estándar

Ventajas de mi herramienta

- Ergonómico, menor esfuerzo al perforar.
- Función reversible.
- Broquero plástico de apriete manual.
- Equipado con luz LED.



TALADRO Y DESTORNILLADOR **396112**

Tensión	12 V c.d.
Velocidad 1	0 - 400 rev/min
Velocidad 2	0 - 1400 rev/min
Posición de torque	18 + 1 (12 - 25 Nm)
Dirección de rotación	Delante / Reversa
Funciones	Taladro / Destornillador
Broquero	3/8" (10 mm) 24 UNF

Capacidad de perforación

Acero	Ø 5/16" (8 mm)
Madera	Ø 3/4" (20 mm)

Batería ION-LITIO incluida

Cargador incluido

12 V c.d. / 1.3 Ah
Carga estándar

Ventajas de mi herramienta

- Ergonómico, menor esfuerzo al perforar.
- Función reversible.
- Broquero plástico de apriete manual.
- Equipado con luz LED.



ACCESORIOS PARA MI ROTOMARTILLO



BATERÍAS COMPATIBLES

396211	20 V c.d. / 2 Ah
\$405.00	\$580.00 \$715.00



CARGADOR COMPATIBLE

396551	20 V
\$110.00	\$155.00 \$195.00

¿QUÉ INCLUYE MI HERRAMIENTA?

- 1 Batería 1.3 Ah
- 1 Cargador estándar
- Garantía e instructivo con listado de centros de servicio.

396111

MODELO: INL-DTL-20-MX

Garantía 6 Meses

10



Caja a color



DISTRIB.	MAYOREO	LISTA
\$630.00	\$900.00	\$1,110.00

ACCESORIOS PARA MI ROTOMARTILLO



BATERÍAS COMPATIBLES

396212	12 V c.d. / 2 Ah
\$330.00	\$470.00 \$580.00



CARGADOR COMPATIBLE

396552	12 V
\$75.00	\$107.00 \$132.00

¿QUÉ INCLUYE MI HERRAMIENTA?

- 1 Batería 1.3 Ah
- 1 Cargador estándar
- Garantía e instructivo con listado de centros de servicio.

396112

MODELO: INL-DTL-12-MX

Garantía 6 Meses

10



Caja a color



DISTRIB.	MAYOREO	LISTA
\$580.00	\$830.00	\$1,025.00



ACCESORIOS

PARA MÁQUINAS INALÁMBRICAS

BATERÍAS ION-LITIO PARA MÁQUINAS SWITCH



CAJA

- ▶ Baterías de ION-LITIO
- ▶ Recargables
- ▶ Baterías compatibles solo con la línea SWITCH



¡TODO SOBRE LAS BATERÍAS!



CÓDIGO	CORRIENTE	MODELO		DISTRIB.	MAYOREO	LISTA
196501	20 V / 1.5 A	BAT-1.5-AK	50	\$460.00	\$655.00	\$810.00
196502	20 V / 2 A	BAT-2.0-AK	50	\$580.00	\$830.00	\$1,025.00
196503	20 V / 3 A	BAT-3.0-AK	25	\$870.00	\$1,245.00	\$1,535.00
196504	20 V / 4 A	BAT-4.0-AK	25	\$940.00	\$1,345.00	\$1,660.00

CARGADORES PARA MÁQUINAS SWITCH



CAJA

- ▶ Cargadores estándar compatibles únicamente con la línea SWITCH

CARGADOR

Tensión	110 - 240 V - 50/60 Hz
Salida	20 V d.c.

BATERÍAS COMPATIBLES

1.5 A	Modelo: BAT-1.5-AK
2 A	Modelo: BAT-2.0-AK
3 A	Modelo: BAT-3.0-AK
4 A	Modelo: BAT-4.0-AK



CÓDIGO	CARGA	SALIDA	MODELO		DISTRIB.	MAYOREO	LISTA
196511	Estándar	450 mA	ADAP-0.45-SW-P	50	\$120.00	\$170.00	\$210.00
196512	Rápida	2000 mA	ADAP-2.0-SW-P	50	\$240.00	\$345.00	\$425.00

BATERÍA

PARA MÁQUINAS BRUSHLESS

- ▶ Batería de ION-LITIO
- ▶ Recargable
- ▶ Baterías compatibles solo con la línea Brushless

CARACTERÍSTICAS

Tensión 110 - 240 V - 50/60 Hz
Salida 20 V d.c.
Corriente 2 Ah



CÓDIGO	MODELO		DISTRIB.	MAYOREO	LISTA
196505	BAT-2.0-SC-AK	50	\$410.00	\$585.00	\$725.00

CARGADOR

PARA MÁQUINAS BRUSHLESS

- ▶ Cargador rápido
- ▶ Compatibles solo con la línea Brushless

CARGADOR

Tensión 110 - 240 V - 50/60 Hz
Salida 20 V d.c.
Corriente 2 Ah

BATERÍAS COMPATIBLES

2 A Modelo: BAT-2.0-SC-AK



CÓDIGO	MODELO		DISTRIB.	MAYOREO	LISTA
196513	ADAP-2.0-SW-PSC	50	\$205.00	\$295.00	\$360.00

BATERÍA y CARGADOR

20 V

- ▶ Batería y cargador compatible solo con la línea inalámbrica doméstica

BATERÍA

Salida 20 V d.c. / 2 Ah

CARGADOR

Carga Estándar
Tensión 110 - 240 V - 50/60 Hz
Salida 20 V d.c. / 0.5 A



COMPATIBLE SOLO CON
Cód. 396111 Y 396121

BATERÍA
396211



CARGADOR
396551

**BATERÍAS COMPATIBLES**

1.3 A Modelo: BAT-1.3-MX
2 A Modelo: BAT-2.0-MX

CÓDIGO	DESCRIPCIÓN	MODELO		DISTRIB.	MAYOREO	LISTA
396211	Batería	BAT-2.0-MX	50	\$405.00	\$580.00	\$715.00
396551	Cargador	ADAP-0.4-MX	50	\$110.00	\$155.00	\$195.00

BATERÍA y CARGADOR

12 V

- ▶ Batería y cargador compatible solo con la línea inalámbrica doméstica

BATERÍA

Salida 12 V d.c. / 2 Ah

CARGADOR

Carga Estándar
Tensión 110 - 240 V - 50/60 Hz
Salida 12 V d.c. / 0.3 A



COMPATIBLE SOLO CON
Cód. 396112 y 396122

BATERÍA
396212



CARGADOR
396552

BATERÍAS COMPATIBLES

1.3 A Modelo: BAT-1.3-MX
2 A Modelo: BAT-2.0-MX

CÓDIGO	DESCRIPCIÓN	MODELO		DISTRIB.	MAYOREO	LISTA
396212	Batería	BAT-2.0-C-MX	50	\$330.00	\$470.00	\$580.00
396552	Cargador	ADAP-0.4-C-MX	50	\$75.00	\$107.00	\$132.00



ATORNILLADOR INALÁMBRICO

4,8 V \equiv con 18 puntas

APLICACIONES:

· Atornilla y desatornilla con diferentes puntas

· INCLUYE:

1 Punta magnética
1 adaptador (cargador de batería tecnología Níquel-Cadmio)
y 18 Puntas:

⊖ 4 piezas ⊕ 3 piezas
⊕ 3 piezas ⊕ 5 piezas
⊕ 3 piezas



Doméstica
IT MAXTOOL

DESTORNILLADOR 396101

Tensión / frecuencia
Velocidad
Dirección de rotación
Torque máximo
Peso

120 V ~ / 60 Hz / 6 W
180 rev / min (sin carga)
Adelante / Reversa
22.1 lb/in (2.5 Nm)
280 g

· Larga vida con mínimo mantenimiento.
· Excelente desempeño frente a los diferentes cambios de temperatura.
· Mantiene la tensión constante durante casi 90% del ciclo de descarga.

Batería tecnología Ni-Cd

100 - 240 V ~ / 50 - 60 Hz / 0.2 A
6 V 200 mA

Entrada de adaptador
Salida de adaptador

Capacidad de perforación

Acero
Madera

∅ 1/2" (13 mm)
∅ 1 - 3/16" (30 mm)

Ventajas de mi herramienta

- Diseño tipo pistola.
- Con correa de transportación.
- Mango ergonómico con cubierta antiderrapante.



! ¿QUÉ INCLUYE MI HERRAMIENTA?

18 Puntas diferentes
1 Punta magnética
1 Adaptador (cargador de baterías)
Garantía e instructivo con listado de centros de servicio.

396101

MODELO: ATORN-IN-4.8-MX

Garantía 6 Meses

12



Blistér

NOM

DISTRIB.	MAYOREO	LISTA
\$225.00	\$320.00	\$395.00

DESBROZADORA INALÁMBRICA

18 V \equiv

APLICACIONES:

- Ideal para corte de césped y recortar orillas
- Funciona como podadora

Batería ION-LITIO

Incluye ruedas, función de poda y mando antivibración

Guía lateral desplegable para desorillar



9" (23 cm)
DIÁMETRO DE CORTE

Semi PRO
AKSI

190821

18 V cc / 1.3 Ah
8 000 rev / min
9" (23 cm)
De 2 a 2.4 mm

100 - 240 V ~ 60 Hz/45 W
22 V cc / 1 500 mA

18 V = / 1,3 Ah
Cargado rápido (1 hr)

30 minutos de trabajo x 10 minutos de descanso. Máximo diario: 3 horas.

Tiempo de operación

Ventajas de mi herramienta

- Empuñadura ergonómica para mayor comodidad.
- Con pocas vibraciones para trabajar sin fatiga.
- Eje con perno de ajuste telescópico.
- Mango auxiliar tipo "D"



! ¿QUÉ INCLUYE MI HERRAMIENTA?

1 Mango tipo "D" antivibración
1 Guarda protectora
1 Juego de tornillería para ensamble
1 Juego de ruedas para función de poda
1 Cargador de batería (18 V)
1 Carrete con hilo
Garantía e instructivo con listado de centros de servicio.

190821

MODELO: DSBZ-18S-AK

Garantía 1 Año

4



Caja a color

NOM

DISTRIB.	MAYOREO	LISTA
\$1,550.00	\$2,215.00	\$2,735.00

ACCESORIOS COMPATIBLES PARA TU DESBROZADORA

Carga	Rápida		
Salida	18 V d.c / 1.3 Ah		
Tiempo de carga	1 Hora		
CÓDIGO	DISTRIB.	MAYOREO	LISTA
190851	\$760.00	\$1,085.00	\$1,340.00

1
Año de garantía





máquinas
ELÉCTRICAS Y GASOLINA

► Rotomartillo . taladro . llave de impacto . esmeriladora . lijadora . sierra . clavadora . accesorios y más.



ROTOMARTILLO 1 200 ó 1 050 W

APLICACIONES:

- Rotomartillo:
Ideal para perforar losas,
block de concreto y pisos.
- Taladro:
Ideal para perforar madera
y acero.
- Atornillador:
Para uso en diferentes
materiales.



NUEVO

1 200 W - 1/2"

cód. 190123



Dos velocidades
mecánicas

1 050 W - 1/2"

cód. 190121



Industrial
AKSI

Industrial
AKSI

Tensión / frecuencia

Potencia

Corriente

Velocidad 1

Velocidad 2

Dirección de rotación

Funciones

Capacidad / broquero

Golpes por minuto

Capacidad de perforación

Acero

Madera

Concreto

Tiempo de operación

Ventajas de mi herramienta

Enriquece tu herramienta con
BROCAS AKSI®

PÁG. 54 - 57



TSI

ROTOMARTILLO,
TALADRO Y
DESTORNILLADOR

190123

120 V ~ / 60 Hz

1200 W

8 A

0 - 1 300 rev / min

1 - 3 100 rev / min

Adelante / Reversa

Rotomartillo / Taladro / Atornillador

1/2" (13 mm)

17 000 gpm / 43 000 gpm

Ø 1/2" (13 mm)

Ø 1 - 3/16" (30 mm)

Ø 5/8" (16 mm)

50 minutos de trabajo x 20 minutos de
descanso. Máximo diario: 6 horas.

- Maquinaria nivel industrial para mayor rendimiento.
- Incluye mango lateral multiposición fabricado en aluminio y guía de profundidad.
- Botón de uso continuo con perilla de regulación de velocidad.
- Selector con 2 velocidades.



¿QUÉ INCLUYE MI HERRAMIENTA?

1 Guía de control de profundidad
1 Par de carbones
1 Llave para broquero
1 Mango auxiliar 360°
Garantía e instructivo con listado de
centros de servicio.

190123

MODELO: RTMR-1/2-1200i-AK

Garantía 1 Año

5



Caja a color

NOM

DISTRIB.
\$1,550.00MAYOREO
\$2,215.00LISTA
\$2,735.00

TSI

ROTOMARTILLO,
TALADRO Y
DESTORNILLADOR

190121

120 V ~ / 60 Hz

1050 W

8.75 A

0 - 1 100 rev / min

0 - 3 000 rev / min

Adelante / Reversa

Rotomartillo / Taladro / Atornillador

1/2" (13 mm)

16 500 gpm / 42 000 gpm

Ø 1/2" (13 mm)

Ø 1 - 3/16" (30 mm)

Ø 5/8" (16 mm)

50 minutos de trabajo x 20 minutos de
descanso. Máximo diario: 6 horas.

- Maquinaria nivel industrial para mayor rendimiento.
- Incluye mango lateral multiposición fabricado en aluminio y guía de profundidad metálica.
- Botón de uso continuo con perilla de regulación de velocidad.
- Selector con 2 velocidades.



¿QUÉ INCLUYE MI HERRAMIENTA?

1 Guía de control de profundidad
1 Par de carbones
1 Llave para broquero
1 Mango auxiliar 360°
Garantía e instructivo con listado de
centros de servicio.

190121

MODELO: RTMR-1/2-1050i-AK

Garantía 1 Año

6



Caja a color

NOM

DISTRIB.
\$1,600.00MAYOREO
\$2,285.00LISTA
\$2,820.00

ROTOMARTILLO 850 ó 600 ó 500 W

APLICACIONES:

- Rotomartillo: Ideal para perforar losas, block de concreto y pisos.
- Taladro: Ideal para perforar madera y acero.
- Atornillador: Para uso en diferentes materiales.



850 W - 1/2"

cód. 190102

600 W - 1/2"

cód. 190101

500 W - 3/8" y 1/2"

cód. 390101 y 390102

Mango metálico
Mayor soporte

Profesional
AKSI

Semi.PRO
AKSI

Doméstica
MAXTOOL

TSI ROTOMARTILLO, TALADRO Y DESTORNILLADOR

Tensión / frecuencia
Potencia
Corriente
Velocidad máxima de motor
Funciones
Broquero
Dirección de rotación
Capacidad de perforación
Acero
Madera
Concreto

Tiempo de operación

Ventajas de mi herramienta

190102
127 V ~ / 60 Hz
850 W
6.8 A
0-2 800 rev/min (sin carga)
Rotomartillo/Taladro/Destornillador
1/2" (13 mm)
Adelante / Reversa
1/2"
Ø 1/2" (13 mm)
Ø 1 - 3/16" (30 mm)
Ø 5/8" (16 mm)

30 minutos de trabajo x 10 minutos de descanso. Máximo diario: 3 horas.

- Mango lateral multiposición y guía de profundidad metálica.
- Selector de función: Rotomartillo / Taladro.
- Carcasa metálica que disipa el calor.
- Botón de uso continuo con perilla de regulación de velocidad.

190101
127 V ~ / 60 Hz
600 W
4.8 A
0 - 3 200 rev / min (sin carga)
Rotomartillo/Taladro/Destornillador
1/2" (13 mm)
Adelante / Reversa
1/2"
Ø 1/2" (13 mm)
Ø 1 - 3/16" (30 mm)
Ø 5/8" (16 mm)

20 minutos de trabajo x 10 minutos de descanso. Máximo diario: 1.5 horas.

- Mango lateral multiposición y guía de profundidad.
- Selector de función: Rotomartillo / Taladro.
- Botón de uso continuo con perilla de regulación de velocidad.

390101 y 390102
127 V ~ / 60 Hz
500 W
4 A
0 - 3 000 / min (sin carga)
Rotomartillo/Taladro/Destornillador
1/2" (13 mm)
Adelante / Reversa
1/2"
Ø 1/2" (13 mm)
Ø 1-3/16" (30 mm)
Ø 5/8" (16 mm)
3/8"
Ø 3/8" (10 mm)
Ø 3/4" (19 mm)
Ø 3/8" (10 mm)

15 minutos de trabajo x 8 minutos de descanso. Máximo diario: 1 hora.

- Mango lateral multiposición y guía de profundidad.
- Selector de función: Rotomartillo / Taladro.
- Botón de uso continuo con perilla de regulación de velocidad.

Enriquece tu herramienta con
BROQUERO AKSI®

PÁG. 57



! ¿QUÉ INCLUYE MI HERRAMIENTA?

1 Guía de control de profundidad, 1 par de carbones, 1 llave para broquero, 1 mango auxiliar 360° y garantía e instructivo con listado de centros de servicio.

! ¿QUÉ INCLUYE MI HERRAMIENTA?

1 Guía de control de profundidad, 1 par de carbones, 1 llave para broquero, 1 mango auxiliar 360° y garantía e instructivo con listado de centros de servicio.

! ¿QUÉ INCLUYE MI HERRAMIENTA?

1 Guía de control de profundidad, 1 par de carbones, 1 llave para broquero, 1 mango auxiliar 360° y garantía e instructivo con listado de centros de servicio.

190102
MODELO: RTMR-1/2-850-AK
Garantía 1 Año
10

Caja a color
NOM
DISTRIB. \$900.00
MAYOREO \$1,285.00
LISTA \$1,590.00

190101
MODELO: RTMR-1/2-600-AK
Garantía 1 Año
10

Caja a color
NOM
DISTRIB. \$570.00
MAYOREO \$815.00
LISTA \$1,005.00

390101
MODELO: RTMR-3/8-500-2-MX
Garantía 6 Meses
5

Caja a color
NOM
DISTRIB. \$405.00
MAY. \$580.00
LISTA \$715.00
390102
MODELO: RTMR-1/2-500-2-MX
Garantía 6 Meses
5

Caja a color
NOM
DISTRIB. \$430.00
MAY. \$615.00
LISTA \$760.00

ROTOMARTILLO ELECTRONEUMÁTICO 800 W

APLICACIONES:

- Rotomartillo:
Ideal para perforar losas, block de concreto y pisos.
- Taladro:
Ideal para perforar madera y acero.
- Atornillador:
Para uso en diferentes materiales.
- Cíncel:
Ideal para perforar concreto, losas y pisos.

800 W - 1/2"

cód. 190151



Industrial
AKSI

TALADRO 350 W

APLICACIONES:

Ideal para perforar madera y acero.

350 W - 3/8"

cód. 190201



Semi.PRO
AKSI

3 FUNCIONES
› Taladro
› Rotomartillo
› Cíncel



TSI

ROTOMARTILLO,
TALADRO Y
CINCEL

190151

Tensión / frecuencia
Potencia
Corriente
Velocidad 1
Velocidad 2
Dirección de rotación
Funciones
Capacidad / broquero
Energía de impacto

Capacidad de perforación

Acero
Madera
Concreto

Tiempo de operación

Ventajas de mi herramienta

120 V ~ / 60 Hz
800 W
6.6 A
900 rev / min (taladro)
4 000 gpm (rotomartillo)
Adelante / Reversa
Rotomartillo / Taladro / Cíncelador
1/2" (13 mm)
2.7 joules

Ø 1/2" (13 mm)
Ø 1 - 3/16" (30 mm)
Ø 1 - 1/32" (26 mm)

50 minutos de trabajo x 20 minutos de descanso. Máximo diario: 6 horas.

- Incluye guía de profundidad.
- Botón de uso continuo con perilla de regulación de velocidad.
- Selector con 2 velocidades.
- Reversible.



¿QUÉ INCLUYE MI HERRAMIENTA?

- 1 Guía de control de profundidad
- 1 Par de carbones
- 3 Brocas para concreto SDS PLUS
- 1 Broquero con adaptador SDS PLUS
- 1 Llave para broquero
- 1 Mango auxiliar 360°
- 1 Cíncel SDS PLUS
- 1 Punzón SDS PLUS
- Garantía e instructivo con listado de centros de servicio.

Enriquece tu herramienta con
CINCELES AKSI®

PÁG. 86



190151

MODELO: RTMR-SDS-800i-AK

Garantía 1 Año

4



Caja a color

NOM

DISTRIB.	MAYOREO	LISTA
\$1,650.00	\$2,355.00	\$2,910.00

TALADRO

190201

Tensión / frecuencia
Potencia
Corriente
Velocidad 1
Dirección de rotación
Funciones
Capacidad / broquero

Capacidad de perforación

Acero
Madera
Concreto

Tiempo de operación

Ventajas de mi herramienta

127 V ~ / 60 Hz
350 W
2.8 A
4 200 rev / min (sin carga)
Adelante / Reversa
Taladro
3/8" (10 mm)

Ø 5/16" (8 mm)
Ø 3/4" (20 mm)
Ø 3/8" (10 mm)

20 minutos de trabajo x 10 minutos de descanso. Máximo diario: 1 hora 30 minutos.

- Diseño ergonómico que permite un uso seguro.
- Diseño compacto para trabajar en lugares de difícil acceso.
- Velocidad variable reversible.
- Botón de uso continuo.



¿QUÉ INCLUYE MI HERRAMIENTA?

- 1 Llave para broquero
- 1 Par de carbones de repuesto
- Garantía e instructivo con listado de centros de servicio.

Enriquece tu herramienta con
BROCAS AKSI®

PÁG. 54 - 57



190201

MODELO: TLDR-3/8-350-AK

Garantía 1 Año

10



Caja a color

NOM

DISTRIB.	MAYOREO	LISTA
\$520.00	\$745.00	\$915.00

TALADROS DE BANCO o DE PISO

250 ó 450 ó 550 ó 750 W

APLICACIONES:

- Taladros ideales para perforar acero, madera, bronce, aluminio, etc.



250 W - 1/3 HP

cód. 197801



58 cm

450 W - 1/2 HP

cód. 197811



83.3 cm

550 W - 3/4 HP

cód. 197812



98.2 cm

750 W - 1 HP

cód. 197813



98.2 cm

Industrial
AKSI

Industrial
AKSI

Industrial
AKSI

Industrial
AKSI



PARA
BROQUERO
DE LLAVE

Tensión / frecuencia

Potencia

Velocidades

Mesa de trabajo

Altura máxima

Broquero

Capacidad de perforación

Acero

Madera

Recorrido de usillo

197801

127 V ~ / 60 Hz
250 W (1/3 HP)
5 (580-2650 rev/min)
160 mm x 160 mm
580 mm
1/2" (13 mm)

Ø 1-3/16" (30 mm)
Ø 1-3/16" (30 mm)
50 mm

50 minutos de trabajo x 20 minutos de descanso. Máximo diario: 6 horas.

197811

127 V ~ / 60 Hz
450 W (1/2 HP)
12 (220-2450 rev/min)
250 mm X 250 mm
833 mm
5/8" (16 mm)

Ø 1-3/16" (30 mm)
Ø 1-3/16" (30 mm)
60 mm

50 minutos de trabajo x 20 minutos de descanso. Máximo diario: 6 horas.

197812

127 V ~ / 60 Hz
550 W (3/4 HP)
12 (340 - 2860 rev / min)
250 mm x 250 mm
982 mm
5/8" (16 mm)

Ø 1-3/16" (30 mm)
Ø 1-3/16" (30 mm)
80 mm

50 minutos de trabajo x 20 minutos de descanso. Máximo diario: 6 horas.

197813

127 V ~ / 60 Hz
750 W (1 HP)
12 (340-2860 rev / min)
250 mm x 250 mm
982 mm
5/8" (16 mm)

Ø 1-3/16" (30 mm)
Ø 1-3/16" (30 mm)
80 mm

50 minutos de trabajo x 20 minutos de descanso. Máximo diario: 6 horas.

Tiempo de operación

Ventajas de mi herramienta

EN TODOS LOS MODELOS:

- Para perforar orificios utilizando escala con tornillo de ajuste en la profundidad del taladro requerida.
- La mesa de taladro puede inclinarse hacia la derecha y hacia la izquierda.
- Ajuste de 12 velocidades de acuerdo al diámetro de broca requerida y material al perforar.
- Se encuentra equipado con manija por medio de la cual puede empujar el motor en dirección al broquero disminuyendo la pre-tensión de las bandas ajustando la velocidad.



! ¿QUÉ INCLUYE MI HERRAMIENTA?

1 Llave para broquero
1 Broquero 1/2"
1 Cuña
2 Llaves Allen®
1 Banda
Garantía e instructivo con listado de centros de servicio.



! ¿QUÉ INCLUYE MI HERRAMIENTA?

1 Llave para broquero
1 Broquero 5/8"
1 Cuña
2 Llaves Allen®
1 Banda
Garantía e instructivo con listado de centros de servicio.



! ¿QUÉ INCLUYE MI HERRAMIENTA?

1 Llave para broquero
1 Broquero 5/8"
1 Cuña
2 Llaves Allen®
1 Banda
Garantía e instructivo con listado de centros de servicio.



! ¿QUÉ INCLUYE MI HERRAMIENTA?

1 Llave para broquero
1 Broquero 5/8"
1 Cuña
2 Llaves Allen®
1 Banda
Garantía e instructivo con listado de centros de servicio.

197801

MODELO: TLDR-BNC-1/2-250-AK

Garantía 1 Año



Caja a color

NOM

DISTRIB. MAYOREO LISTA
\$2,400.00 \$3,430.00 \$4,235.00

197811

MODELO: TLDR-PS-5/8-450i-AK

Garantía 1 Año



Caja a color

NOM

DISTRIB. MAYOREO LISTA
\$4,000.00 \$5,715.00 \$7,055.00

197812

MODELO: TLDR-PS-5/8-550i-AK

Garantía 1 Año



Caja a color

NOM

DISTRIB. MAYOREO LISTA
\$4,800.00 \$6,855.00 \$8,465.00

197813

MODELO: TLDR-PS-5/8-750i-AK

Garantía 1 Año



Caja a color

NOM

DISTRIB. MAYOREO LISTA
\$7,000.00 \$10,000.00 \$12,345.00

ESMERILADORA ANGULAR

2 600 ó 1 100 ó 900 W

APLICACIONES:

- Desbaste de metal, concreto, mármol, etc.
- Corte de metal, concreto, mármol, etc.
- Remoción de óxido en general.



PROX.

2 600 W

cód. 190325

9"
(22.8 cm)

DISCO DE CORTE



1 100 W

cód. 190324

4 1/2"
(11.4 cm)

DISCO DE CORTE



900 W

cód. 190321

4 1/2"
(11.4 cm)

DISCO DE CORTE



Industrial
AKSI

Industrial
AKSI

Industrial
AKSI



¡HERRAMIENTA MEJORADA!

Nuevo modelo

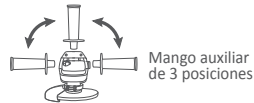

190325

Tensión / frecuencia	127 V ~ / 60 Hz
Potencia	2 600 W
Corriente	19 A
Velocidad	6 500 rev / min (sin carga)
Diámetro de disco	9" (22.86 cm)
Mango lateral	3 Posiciones
Tipo de cuerda	En eje 5/8" - 11 (15.875 mm)

50 minutos de trabajo x 20 minutos de descanso. Máximo diario: 6 horas.

- Interruptor extra largo para mayor comodidad de operación.
- Baleros 100% protegidos contra polvo.
- Guarda de protección con sistema de ajuste rápido.



190324

Tensión / frecuencia	127 V ~ / 60 Hz
Potencia	1 100 W
Corriente	7.5 A
Velocidad	11 000 rev / min (sin carga)
Diámetro de disco	4 1/2" (11.4 cm)
Mango lateral	3 Posiciones
Tipo de cuerda	En eje 5/8" - 11 (11 mm)

50 minutos de trabajo x 20 minutos de descanso. Máximo diario: 6 horas.

- Interruptor extra largo para mayor comodidad de operación.
- Baleros 100% protegidos contra polvo.
- Guarda de protección con sistema de ajuste rápido.



190321

Tensión / frecuencia	127 V ~ / 60 Hz
Potencia	900 W
Corriente	7.5 A
Velocidad	11 000 rev / min (sin carga)
Diámetro de disco	4 1/2" (11.4 cm)
Mango lateral	3 Posiciones
Tipo de cuerda	En eje 5/8" - 11 (11 mm)

50 minutos de trabajo x 20 minutos de descanso. Máximo diario: 6 horas.

- Interruptor extra largo para mayor comodidad de operación.
- Baleros 100% protegidos contra polvo.
- Guarda de protección con sistema de ajuste rápido.

Tensión / frecuencia
Potencia
Corriente
Velocidad
Diámetro de disco
Mango lateral

Tiempo de operación

Ventajas de mi herramienta

Enríquez tu herramienta con **DISCOS AKSI®**

PÁG. 107 - 111



¿QUÉ INCLUYE MI HERRAMIENTA?

1 Guarda protectora,
1 Mango auxiliar ajustable
1 Llave para bridas
Garantía e instructivo con listado de centros de servicio

190325

MODELO: ESM-9-2600i-AK

Garantía 1 Año

6



Caja a color

NOM

DISTRIB. \$1,500.00
MAYOREO \$2,145.00
LISTA \$2,645.00

¿QUÉ INCLUYE MI HERRAMIENTA?

1 Guarda protectora,
1 Mango auxiliar ajustable
1 Llave para bridas
Garantía e instructivo con listado de centros de servicio

190324

MODELO: ESM-4-1/2-1100i-AK

Garantía 1 Año

6



Caja a color

NOM

DISTRIB. \$1,200.00
MAYOREO \$1,715.00
LISTA \$2,115.00

¿QUÉ INCLUYE MI HERRAMIENTA?

1 Guarda metálica
1 Mango auxiliar ajustable
1 Llave de pernos
2 Bridas
Garantía e instructivo con listado de centros de servicio

190321

MODELO: ESM-4-1/2-900i-AK

Garantía 1 Año

6



Caja a color

NOM

DISTRIB. \$880.00
MAYOREO \$1,255.00
LISTA \$1,550.00

ESMERILADORA ANGULAR
900 ó 710 W ó 500 W

APLICACIONES:

- Desbaste de metal, concreto, mármol, etc.
- Corte de metal, concreto, mármol, etc.
- Remoción de óxido en general.



900 W

cód. 190302

4 1/2"
(11.4 cm)
DISCO DE CORTE



710 W

cód. 190305

4 1/2"
(11.4 cm)
DISCO DE CORTE



500 W

cód. 390301

4 1/2"
(11.4 cm)
DISCO DE CORTE

Profesional
AKSI

Profesional
AKSI

Doméstica
MAXTOOL



Mango auxiliar de 2 posiciones



Mango auxiliar de 2 posiciones



Mango auxiliar de 2 posiciones

190302

Tensión / frecuencia	
Potencia	
Corriente	
Velocidad	
Diámetro de disco	
Mango lateral	
Tipo de cuerda	

127 V ~ 60 Hz
900 W
7.2 A
11 000 rev / min
4 1/2" (11.4 cm)
2 Posiciones
En eje 5/8" - 11

190305

120 V ~ / 60 Hz
710 W
5.9 A
11 000 rev / min
4 1/2" (11.4 cm)
2 Posiciones
En eje 5/8" - 11

390301

127 V ~ / 60 Hz
500 W
4 A
11 000 rev / min
4 1/2" (11.4 cm)
2 Posiciones
En eje 5/8" M14 (14 cm)

Tiempo de operación

30 minutos de trabajo x 10 minutos de descanso. Máximo diario: 3 horas.

30 minutos de trabajo x 10 minutos de descanso. Máximo diario: 3 horas.

15 minutos de trabajo x 8 minutos de descanso. Máximo diario: 1 hora.

Ventajas de mi herramienta

- Cuentan con disco de 4 1/2", adecuado para trabajos en espacios reducidos.
- Incluye guarda de protección con sistema de ajuste rápido.
- Cómodo interruptor diseñado para un mejor control.
- Botón de bloqueo de eje que facilita el cambio de disco.

- Cuentan con disco de 4 1/2", adecuado para trabajos en espacios reducidos.
- Incluye guarda de protección con sistema de ajuste rápido.
- Cómodo interruptor diseñado para un mejor control.
- Botón de bloqueo de eje que facilita el cambio de disco.

- Cuentan con disco de 4 1/2", adecuado para trabajos en espacios reducidos.
- Incluye guarda de protección con sistema de ajuste rápido.
- Cómodo interruptor diseñado para un mejor control.
- Botón de bloqueo de eje que facilita el cambio de disco.



¿QUÉ INCLUYE MI HERRAMIENTA?

- 1 Mango auxiliar ajustable
- 1 Guarda de 4 1/2"
- 1 Llave para pernos
- 1 Par de carbones de repuesto
- Garantía e instructivo con listado de centros de servicio.

¿QUÉ INCLUYE MI HERRAMIENTA?

- 1 Mango auxiliar ajustable
- 1 Guarda de 4 1/2"
- 1 Llave para pernos
- 1 Par de carbones de repuesto
- 2 Bridas
- Garantía e instructivo con listado de centros de servicio.

¿QUÉ INCLUYE MI HERRAMIENTA?

- 1 mango auxiliar
- 1 guarda de seguridad (disco no incluido)
- 1 Llave para bridas
- 1 Par de carbones de repuesto
- Garantía e instructivo con listado de centros de servicio.

Enriquece tu herramienta con **DISCOS MAXTOOL®**



PÁG. 110 - 111

190302

MODELO: ESM-4 1/2p-900p-2-AK

Garantía 1 Año

6



Caja a color

NOM

DISTRIB.	MAYOREO	LISTA
\$830.00	\$1,185.00	\$1,465.00

190305

MODELO: ESM-4 1/2-710p-2-AK

Garantía 1 Año

6



Caja a color

NOM

DISTRIB.	MAYOREO	LISTA
\$690.00	\$985.00	\$1,215.00

390301

MODELO: ESM-4.5-500-MX

Garantía 6 Meses

6



Caja a color

NOM

DISTRIB.	MAYOREO	LISTA
\$550.00	\$785.00	\$970.00

CORTADOR DE AZULEJOS

ELÉCTRICO
1250 W

APLICACIONES:

- Para cortes rectos y biselados en azulejo, cerámica, mármol, cantera y materiales de construcción.



4 1/2" (11.4 cm)

USA DISCO DE CORTE



Industrial
AKSI

SIERRA DE MESA 10"

2 200 W / 3 HP

APLICACIONES:

- Excelentes cortes rectos y angulares en madera y aluminio.



10" (25.4 cm)

USA SIERRA DE CORTE



Industrial
AKSI

Discos AKSI® exclusivos para esta cortadora



Disco rin segmentado 4 1/2" | Disco rin continuo 4 1/2" | Disco rin turbo 4 1/2"

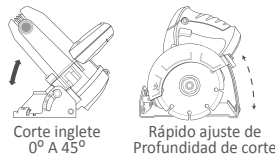

Corte inglete 0° A 45° | Rápido ajuste de Profundidad de corte

191451

Tensión / frecuencia	120 V ~ / 60 Hz
Potencia	1 250 W
Corriente	11 A
Velocidad	13 200 rev / min (sin carga)
Diámetro de disco	4 1/2" (11.4 cm)
Eje con diámetro de brida	20 mm
Grado de protección	IP20
Profundidad de corte	
Corte biselado	0° - 45°
Losa	20 mm
Loseta, azulejo	20 a 25 mm
Cerámica	30 mm

Tiempo de operación

Ventajas de mi herramienta

30 minutos de trabajo x 15 minutos de descanso. Máximo diario: 3 horas.

- Profundidad de corte regulable.
- Ajuste de base para cortes con ángulo de 0° a 45°
- Sistema de suministro de agua para enfriar el disco y reducir el polvo.
- Ergonómico y ligero.
- Botón de encendido continuo.



¿QUÉ INCLUYE MI HERRAMIENTA?

- 1 Manguera con adaptador de grifo
- 1 Llave española
- 1 Llave hexagonal
- 1 Par de carbones
- Garantía e instructivo con listado de centros de servicio.

191451

MODELO: CRTAZ-4-1/2-1250i-AK

Garantía 1 Año



Caja a color

NOM

DISTRIB. \$1,300.00 | MAYOREO \$1,855.00 | LISTA \$2,295.00

Profundidad de corte

A 0°
A 45°

Tiempo de operación

Ventajas de mi herramienta

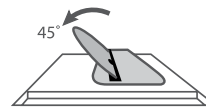

Corte inglete 0° A 45°



Base metálica de alta resistencia

197401

Tensión / frecuencia	127 V ~ / 60 Hz
Potencia	2 200 W / 3 HP
Corriente	16 A
Velocidad	5 000 rev / min (sin carga)
Peso	23.88 kg
Escala de inglete	60° Izquierda y derecha
Diámetro de disco	10" (25.4 cm)
Diámetro de eje	5/8" (16 mm)
Mesa de trabajo	92.7 x 67.3 cm

Tensión / frecuencia	127 V ~ / 60 Hz
Potencia	2 200 W / 3 HP
Corriente	16 A
Velocidad	5 000 rev / min (sin carga)
Peso	23.88 kg
Escala de inglete	60° Izquierda y derecha
Diámetro de disco	10" (25.4 cm)
Diámetro de eje	5/8" (16 mm)
Mesa de trabajo	92.7 x 67.3 cm

Profundidad de corte

A 0°
A 45°

Tiempo de operación

3" (76.2 mm)
2 1/2" (63.5 mm)

120 minutos de trabajo x 30 minutos de descanso. Máximo diario: 6 horas.

Ventajas de mi herramienta

- Encendido suave.
- Potente motor de 3 HP para cortes exigentes.
- Corte de inglete 0° a 45°
- Motor con sistema de protección de sobrecarga.
- Altura de corte regulable.
- Mesa de trabajo de 25" x 17" que proporciona mayor apoyo a las operaciones.
- Guarda protectora transparente con trinquetes de contragolpe integrados.
- Interruptor con llave de seguridad.
- Guía paralela para cortes precisos.
- Guía paralela angular para cortes en diferentes ángulos.



¿QUÉ INCLUYE MI HERRAMIENTA?

- 1 Sierra de 10" con dientes de carburo de tungsteno
- 1 Guarda de sierra
- 2 Llaves para cambio de sierra
- 1 Guía de inglete
- 1 Guía de corte
- 1 Guía auxiliar
- 1 Volante de ajuste de bisel
- Trinquetes anti-retroceso
- 4 Bases de goma
- Tornillería
- Garantía e instructivo con listado de centros de servicio.

197401

MODELO: SM-10i-AK

Garantía 1 Año



Caja a color

NOM

DISTRIB. \$5,000.00 | MAYOREO \$7,145.00 | LISTA \$8,820.00

**SIERRA DE INGLETE
TELESCÓPICA COMPUESTA 10"**
CORTE BISEL 45°
1 800 W

APLICACIONES:

- Ideal para cortes en madera y aluminio.



USA SIERRA DE CORTE



Industrial
AKSI

CORTADORA DE METALES 14"
2 200 W

APLICACIONES:

- Ideal para cortes en metal.



USA DISCO DE CORTE



Industrial
AKSI

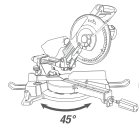

Mesa de trabajo
0° a 45°

197202

Tensión / frecuencia
Potencia
Corriente
Velocidad
Peso

127 V ~ / 60 Hz
1 800 W
15 A
4 500 rev / min (sin carga)
15.190 kg

Capacidad de corte
Ángulo de corte bisel
Ángulo de corte inglete
Profundidad de corte
Diámetro de disco
Diámetro de eje

45° izquierda
45° izquierda
90° (340 x 90 mm)
45° (240 x 45 mm)
10" (255 mm)
1" (25.4 mm)

Tiempo de operación

50 minutos de trabajo x 20 minutos de descanso. Máximo diario: 6 horas.

Ventajas de mi herramienta

- Brazo telescópico.
- Sistema de recolección de polvo.
- Encendido suave.
- Corte de inglete y bisel a 45°.
- Incluye guía de corte láser.
- Cortes precisos por medio de recorrido paralelo de brazo telescópico.
- Barras de extensión incluidas.



¿QUÉ INCLUYE MI HERRAMIENTA?

1 Llave hexagonal, 1 sierra con dientes de carburo de tungsteno de 10", 1 bolsa recolectora de polvo, 2 accesorios de sujeción, 1 par de carbones de repuesto y garantía e instructivo con listado de centros de servicio.

197202

MODELO: SRA-ING-10-1800i-AK

Garantía 1 Año

1



Caja a color

NOM

DISTRIB.	MAYOREO	LISTA
\$4,850.00	\$6,930.00	\$8,555.00

Enriquece tu herramienta con **DISCOS AKSI®**

PÁG. 107 - 111



197302

Tensión / frecuencia
Potencia
Corriente
Velocidad
Peso
Mango

120 V ~ / 60 Hz
2 200 W
14.5 A
3 900 rev / min
12.4 kg
Tipo "L"

Capacidad de corte
Profundidad de corte
Para disco
Tiempo de operación

A 0° - 3" (76.2 mm)
A 45° - 2 1/2" (63.5 mm)
14" (356 mm)

50 minutos de trabajo x 20 minutos de descanso. Máximo diario: 6 horas.

Ventajas de mi herramienta

- Bloqueo de eje para cambios de discos.
- Guarda abatible para mayor protección del usuario.
- Base con prensa de trabajo ajustable para corte en diferentes ángulos.
- Tope de regulación de profundidad de corte
- Es portátil.



¿QUÉ INCLUYE MI HERRAMIENTA?

1 Disco de 14"
1 Llave para cambio de disco
1 Par de carbones de repuesto
3 Bridas
Tornillería
Garantía e instructivo con listado de centros de servicio.

197302

MODELO: CRT-MT-14-2 200-AK

Garantía 1 Año

1



Caja a color

NOM

DISTRIB.	MAYOREO	LISTA
\$2,400.00	\$3,430.00	\$4,235.00

SIERRA CALADORA 720 ó 570 ó 350 W

APLICACIONES:

- Diseñada para corte en madera, plástico y/o metal.



720 W

cód. 190503



720 W

cód. 190502



570 W

cód. 190501



350 W

cód. 390501



Industrial
AKSI

Profesional
AKSI

Profesional
AKSI

Doméstica
MAXITOL

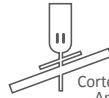

Cortes de 0° a 45°
Ambos lados

190503

Tensión / frecuencia	120 V ~ / 60 Hz
Potencia	720 W
Corriente	6 A
Velocidad (sin carga)	1 300 - 3 000 Carreras / min
Tipo de segueta	Tipo "T"
Longitud de carrera	28 mm

Tensión / frecuencia	120 V ~ / 60 Hz
Potencia	720 W
Corriente	6 A
Velocidad (sin carga)	1 300 - 3 000 Carreras / min
Tipo de segueta	Tipo "T"
Longitud de carrera	28 mm

Capacidad de perforación

Madera	80 mm
Metal	4 mm
Plástico	20 mm

Tiempo de operación

50 minutos de trabajo x 20 minutos de descanso. Máximo diario: 6 horas.

Ventajas de mi herramienta

- Ajuste de base para cortes en ángulos de 0°, 15°, 30° y 45° hacia ambos lados.
- Botón de encendido continuo.
- Velocidad variable.

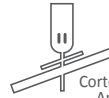

Cortes de 0° a 45°
Ambos lados

190502

Tensión / frecuencia	127 V ~ / 60 Hz
Potencia	720 W
Corriente	6 A
Velocidad (sin carga)	1200 - 3 000 Carreras / min
Tipo "T"	Tipo "T"
Longitud de carrera	20 mm

Madera	60 mm
Metal	4 mm
Plástico	20 mm

30 minutos de trabajo x 10 minutos de descanso. Máximo diario: 3 horas.

- Ajuste de base para cortes en ángulos de 0°, 15°, 30° y 45° hacia ambos lados.
- Práctico adaptador para la colocación de un aspirador.
- Botón de encendido continuo.
- Velocidad variable.

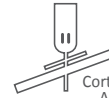

Cortes de 0° a 45°
Ambos lados

190501

Tensión / frecuencia	127 V ~ / 60 Hz
Potencia	570 W
Corriente	4.5 A
Velocidad (sin carga)	800 - 3 000 Carreras / min
Tipo "U" compatible con "T"	Tipo "U" compatible con "T"
Longitud de carrera	20 mm

Madera	60 mm
Metal	4 mm
Plástico	20 mm

30 minutos de trabajo x 10 minutos de descanso. Máximo diario: 3 horas.

- Ajuste de base para cortes en ángulos de 0°, 15°, 30° y 45° hacia ambos lados.
- Práctico adaptador para la colocación de un aspirador.
- Incluye función de soplador.
- Botón de encendido continuo.
- Velocidad variable.

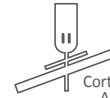

Cortes de 0° a 45°
Ambos lados

390501

Tensión / frecuencia	127 V ~ / 60 Hz
Potencia	350 W
Corriente	2.8 A
Velocidad (sin carga)	3 000 Carreras / min
Tipo "U" compatible con "T"	Tipo "U" compatible con "T"
Longitud de carrera	20 mm

Madera	55 mm
Metal	4 mm
Plástico	20 mm

15 minutos de trabajo x 8 minutos de descanso. Máximo diario: 1 hora.

- Ajuste de base para cortes en ángulos de 0°, 15°, 30° y 45° hacia ambos lados.
- Práctico adaptador para la colocación de un aspirador.
- Botón de encendido continuo.



¿QUÉ INCLUYE MI HERRAMIENTA?

1 Guía de corte, 1 segueta para corte en madera, 1 segueta para corte en metal, 1 llave hexagonal para zapata y garantía e instructivo con listado de centros de servicio.

190503

MODELO: CLDR-720i-2-AK

Garantía 1 Año

5



Caja a color

NOM

DISTRIB.	MAYOREO	LISTA
\$1,550.00	\$2,215.00	\$2,735.00

¿QUÉ INCLUYE MI HERRAMIENTA?

1 Llave hexagonal, 1 segueta para corte en metal, 1 segueta para corte en madera, 2 carbones, 1 guía paralela y garantía e instructivo con listado de centros de servicio.

190502

MODELO: CLDR-720p-AK

Garantía 1 Año

10



Caja a color

NOM

DISTRIB.	MAYOREO	LISTA
\$800.00	\$1,145.00	\$1,410.00

¿QUÉ INCLUYE MI HERRAMIENTA?

1 Llave hexagonal, 1 segueta para corte en metal, 1 segueta para corte en madera, 2 carbones, 1 guía paralela y garantía e instructivo con listado de centros de servicio.

190501

MODELO: CLDR-570-AK

Garantía 1 Año

10



Caja a color

NOM

DISTRIB.	MAYOREO	LISTA
\$600.00	\$855.00	\$1,060.00

¿QUÉ INCLUYE MI HERRAMIENTA?

1 Llave hexagonal, 1 segueta para plástico / metal, 1 segueta para madera, 2 carbones y garantía e instructivo con listado de centros de servicio.

390501

MODELO: CLDR-350-MX

Garantía 6 Meses

5



Caja a color

NOM

DISTRIB.	MAYOREO	LISTA
\$400.00	\$570.00	\$705.00

SIERRA SABLE 900 ó 710 W

APLICACIONES:

- Corte de diferentes materiales de acuerdo a la siqueta: metal, madera, plástico, acrílico, etc.



Industrial
AKSI

Profesional
AKSI

Tensión / frecuencia
Potencia
Corriente
Velocidad
Tipo de sierra
Profundidad de corte
Madera
Metal

190522
120 V ~ / 60 Hz
900 W
6.6 A
0-3 000 carreras/min
Zanco universal 1/2" (12.7 mm)
108 mm
10 mm

190521
120 V ~ / 60 Hz
710 W
6 A
0-2 500 carreras/min
Zanco universal 1/2" (12.7 mm)
108 mm
10 mm

Tiempo de operación

50 minutos de trabajo x 20 minutos de descanso. Máximo diario: 6 horas.

30 minutos de trabajo x 10 minutos de descanso. Máximo diario: 3 horas.

Ventajas de mi herramienta

- Cambio de 5 posiciones: presiona y gira.
- Sistema de cambio rápido de siqueta.
- Incluye luz LED de trabajo.
- Interruptor de uso continuo.
- Velocidad variable.
- Facilita el acceso a lugares incómodos y cortes a ras de piso.

- Sistema de cambio rápido de siqueta
- 5 posiciones: presiona y gira.
- Velocidad variable.
- Facilita el acceso a lugares incómodos y cortes a ras de piso.



¿QUÉ INCLUYE MI HERRAMIENTA?

- 1 Segueta para corte de madera 11 dpp
- 1 Segueta para corte de metal 25 dpp
- Garantía e instructivo con listado de centros de servicio.

¿QUÉ INCLUYE MI HERRAMIENTA?

- 1 Segueta para corte de madera 11 dpp
- 1 Segueta para corte de metal 25 dpp
- 1 Llave hexagonal
- Garantía e instructivo con listado de centros de servicio.

190522
MODELO: SABLE-900i-AK
Garantía 1 Año
6

Caja a color
NOM
DISTRIB. \$1,400.00
MAYOREO \$2,000.00
LISTA \$2,470.00

190521
MODELO: SABLE-710p-2-AK
Garantía 1 Año
6

Caja a color
NOM
DISTRIB. \$1,300.00
MAYOREO \$1,855.00
LISTA \$2,295.00

CEPILLO PORTÁTIL 13"

ELÉCTRICO
2 000 W

APLICACIONES:

- Corte de diferentes materiales de acuerdo a la segueta: metal, madera, plástico, acrílico, etc.

PROX.

2 000 W

cód. 190581



Profesional
AKSI

CEPILLO 3 1/4"

ELECTRICO
800 W

APLICACIONES:

- Ideal en cepillado, desbaste, rebajes y biselados en madera.
- Se recomienda en uso profesional y particular en talleres de carpintería.

NUEVO

800 W

cód. 190571



Profesional
AKSI

190581

Tensión / frecuencia	127 V ~ / 60 Hz
Potencia	2 000 W
Corriente	16 A
Velocidad	11 000 rev/min
Grado de protección	IP20
Capacidad máxima de corte	13" (330 mm)
Numero de navajas	3
Velocidad de avance	6.4 m/min
Dimensiones de base de trabajo	13"x 29" (330 x 736 mm)

Profundidad máxima de corte

3 mm

Tiempo de operación

30 minutos de trabajo x 10 minutos de descanso. Máximo diario: 3 horas.

Ventajas de mi herramienta

- Traba de cuatro columnas que asegura el cabezal cortante contra los cuatro postes de acero, para reducir y evitar desviaciones o pérdida de precisión.
- Ajuste de cuchilla magnético y almacenamiento de llaves para cambios de cuchilla rápidos, fáciles y precisos.
- Cabezal cortante de tres cuchillas.
- Cambio de hoja con una sola herramienta.
- Escala de espesor precisa.
- Tope de espesor de torreta para cortes en serie.



¿QUÉ INCLUYE MI HERRAMIENTA?

- 1 Cepillo portátil
- 1 Deflector de astillas
- 1 Llave
- 1 Atornillador
- Garantía e instructivo con listado de centros de servicio.

190581

MODELO: CEP-PORM-2000p-AK

Garantía 1 Año

1



Caja a color

NOM

DISTRIB. \$7,000.00 MAYOREO \$10,000.00 LISTA \$12,345.00

190571

Tensión / frecuencia	127 V ~ / 60 Hz
Potencia	800 W
Corriente	6 A
Velocidad	16 000 rev/min

Capacidad de corte

Madera

3/4" (8.25 cm)

Profundidad de corte

0,5, 0,75, 1, 1,25, 1,5, 1,75, 2, 2,25, 2,5, 2,75, 3 mm.

Tiempo de operación

30 minutos de trabajo x 10 minutos de descanso. Máximo diario: 3 horas.

Ventajas de mi herramienta

- Cuenta con 11 posiciones para ajuste de profundidad.
- Más rápido y potente que permite ahorrar tiempo.
- Realiza el trabajo de manera más eficiente.
- Acabados más profesionales.

¿QUÉ INCLUYE MI HERRAMIENTA?

- 2 Cuchillas de repuesto
- 1 Guía paralela y de profundidad
- 2 Pares de carbones
- Garantía e instructivo con listado de centros de servicio.

190571

MODELO: CEP-800p-AK

Garantía 1 Año

6



Caja a color

NOM

DISTRIB. \$1,150.00 MAYOREO \$1,645.00 LISTA \$2,030.00

**ROUTER
1 600 W**

APLICACIONES:

- Corte de diferentes materiales de acuerdo a la segueta: metal, madera, plástico, acrílico, etc.



Profesional
AKSI



Tensión / frecuencia
Potencia
Corriente
Velocidad (sin carga)
Mordaza de sujeción

Profundidad de corte
Madera

Tiempo de operación

Ventajas de mi herramienta

190551

127 V ~ / 60 Hz
1 600 W
9 A
600 - 25 000 rev / min
1/4" (6.35 mm) y 1/2" (12.7 mm)

12 mm

30 minutos de trabajo x 10 minutos de descanso. Máximo diario: 3 horas.

- Velocidad variable.
- Incluye perilla de micro ajuste.
- Botón de uso continuo.
- Base de niveles de pre selección de tope de profundidad.
- Diseño compacto con motor de excelente potencia.
- Perilla de ajuste rápido de altura.



¿QUÉ INCLUYE MI HERRAMIENTA?

- 1 Tubo extractor de polvo
- 1 Llave
- 1 Guía copiadora
- 1 Guía paralela con 2 varillas
- 1 Escala de profundidad
- 1 Perilla mariposa para fijación de escala
- 1 Par de carbones
- 1 Conjunto de collet 1/4" y 1/2"
- 1 Aditamento para cortes curvos
- Garantía e instructivo con listado de centros de servicio.

190551

MODELO: ROU-1600p-AK
Garantía 1 Año

3



Caja a color

NOM

DISTRIB.	MAYOREO	LISTA
\$2,150.00	\$3,070.00	\$3,790.00



**¡¡Vamos contigo!!
en tus mejores proyectos**

LIJADORA DE BANDA 1200 ó 900 W

APLICACIONES:

- Reduce el esfuerzo de lijado, ahorrando energía y tiempo.
- Ideal para trabajos rudos y pesados.
- Lijadora con amplia gama de aplicaciones de lijado en madera, yeso, metal.

NUEVO
1200 W

cód. 190452

Incluye bolsa recolectora de polvo

900 W

cód. 190451



Incluye bolsa recolectora de polvo

Industrial
AKSI

Profesional
AKSI

¡HERRAMIENTA MEJORADA!

Nuevo modelo.

190452

Tensión / frecuencia	120 V ~ / 60 Hz
Potencia	1 200 W
Corriente	8.6 A
Velocidad	450 m/min
Tamaño de banda de lija	4" x 24" (7.6 x 53 cm)

50 minutos de trabajo x 20 minutos de descanso. Máximo diario: 6 horas.

- Maquinaria nivel industrial para mayor rendimiento.
- Sistema de tensión de banda de lija.
- Base de lija de metal para trabajos más eficientes.
- Botón de encendido continuo.
- Bolsa recolectora de polvo.

¿QUÉ INCLUYE MI HERRAMIENTA?

 1 Recolector de polvo
 1 Lija de banda
 1 Par de carbones
 Garantía e instructivo con listado de centros de servicio.

190452

MODELO: LJDB-1200i-AK

Garantía 1 Año

2



Caja a color

NOM

DISTRIB.	MAYOREO	LISTA
\$2,150.00	\$3,070.00	\$3,790.00

190451

Tensión / frecuencia	127 V ~ / 60 Hz
Potencia	900 W
Corriente	7.5 A
Velocidad	410 m/min
Tamaño de banda de lija	3" x 21" (7.6 x 53 cm)

30 minutos de trabajo x 10 minutos de descanso. Máximo diario: 3 horas.

- Sistema de tensión de banda de lija.
- Base de lija de metal para trabajos más eficientes.
- Botón de encendido continuo.
- Bolsa recolectora de polvo.

¿QUÉ INCLUYE MI HERRAMIENTA?

 1 Bolsa recolectora de polvo
 1 Lija de banda
 Garantía e instructivo con listado de centros de servicio.

190451

MODELO: LJDB-900p-AK

Garantía 1 Año

6



Caja a color

NOM

DISTRIB.	MAYOREO	LISTA
\$1,200.00	\$1,715.00	\$2,115.00

 Enriquece tu herramienta con
LIJAS AKSI®

PÁG. 228

LIJADORA ORBITAL 300 ó 180 ó 150 W

APLICACIONES:

- Ideal para superficies planas.
- Lijadora con amplia gama de aplicaciones de lijado en madera, yeso, metal.

300 W

cód. 190402

180 W

cód. 190401

150 W

cód. 390401

Profesional
AKSI

Semi.PRO
AKSI

Doméstica
MAXTOOL

¡HERRAMIENTA MEJORADA!

Nuevo modelo

190402

Tensión / frecuencia	127 V ~ / 60 Hz
Potencia	300 W
Corriente	2.4 A
Velocidad (sin carga)	6 000 - 12 000 orbitas/min
Tamaño de lija	1/2 hoja (10.8 x 28 cm)

Tensión / frecuencia	127 V ~ / 60 Hz
Potencia	300 W
Corriente	2.4 A
Velocidad (sin carga)	6 000 - 12 000 orbitas/min
Tamaño de lija	1/2 hoja (10.8 x 28 cm)

30 minutos de trabajo x 10 minutos de descanso. Máximo diario: 3 horas.

190401

Tensión / frecuencia	127 V ~ / 60 Hz
Potencia	180 W
Corriente	1.66 A
Velocidad (sin carga)	13 000 orbitas/min
Tamaño de lija	1/4 Hoja (11 x 11.5 cm)

20 minutos de trabajo x 10 minutos de descanso. Máximo diario: 1.5 horas.

390401

Tensión / frecuencia	127 V ~ / 60 Hz
Potencia	150 W
Corriente	1.2 A
Velocidad (sin carga)	12 000 orbitas/min
Tamaño de lija	1/3 Hoja (9.5 x 21.5 cm)

15 minutos de trabajo x 8 minutos de descanso. Máximo diario: 1.5 horas.

Tiempo de operación

Ventajas de mi herramienta

- Empuñadura ergonómica para mayor comodidad durante períodos de uso prolongado.
- Práctico adaptador para la colocación de un aspirador.
- Base con Velcro® para mejor fijación de la lija.



Velcro® es una marca registrada.



! ¿QUÉ INCLUYE MI HERRAMIENTA?

- 1 Recolector de polvo
- 1 Hoja de lija
- 1 Par de carbones
- Garantía e instructivo con listado de centros de servicio.

! ¿QUÉ INCLUYE MI HERRAMIENTA?

- 1 Recolector de polvo
- 1 Hoja de lija
- 1 Par de carbones
- Garantía e instructivo con listado de centros de servicio.

! ¿QUÉ INCLUYE MI HERRAMIENTA?

- 1 Recolector de polvo
- 1 Hoja de lija
- 1 Par de carbones
- Garantía e instructivo con listado de centros de servicio.

 Enriquece tu herramienta con
LIJAS AKSI®

PÁG. 227 - 228

190402

MODELO: LJD-1/2-300-AK

Garantía 1 Año

10



Caja a color

NOM

DISTRIB.	MAYOREO	LISTA
\$930.00	\$1,330.00	\$1,640.00

190401

MODELO: LJD-1/4-180-AK

Garantía 1 Año

10



Caja a color

NOM

DISTRIB.	MAYOREO	LISTA
\$650.00	\$930.00	\$1,145.00

390401

MODELO: LJD-1/2-300-AK

Garantía 6 Meses

4



Caja a color

NOM

DISTRIB.	MAYOREO	LISTA
\$450.00	\$645.00	\$795.00

LIJADORA ROTO-ORBITAL 430 ó 350 W

APLICACIONES:

- Perfecta en superficies curvas o cantos.
- Ideal para acabados muy finos de gran calidad.
- Recomendable para ebanistería y en sector automotriz.

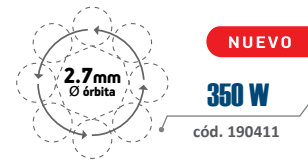
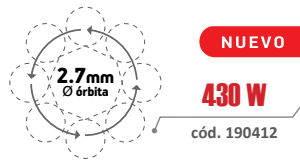

Industrial
AKSI

Profesional
AKSI

Tensión / frecuencia
Potencia
Corriente
Velocidad (sin carga)
Tamaño de lija

Tiempo de operación

Ventajas de mi herramienta

190412

120 V ~ / 60 Hz
430 W
3.5 A
5 000 - 12 000 rev/min
5" (12.7 cm)

50 minutos de trabajo x 20 minutos de descanso. Máximo diario: 6 horas.

- Operables con una sola mano.
- Doble movimiento elíptico y rotativo que proporciona un acabado fino.
- Empuñadura ergonómica para mayor comodidad durante periodos de uso prolongado.
- Base con Velcro® para mejor fijación de la lija.



! ¿QUÉ INCLUYE MI HERRAMIENTA?

- 1 Recolector de polvo
- 1 Hoja de lija
- 1 Par de carbones
- Garantía e instructivo con listado de centros de servicio.

190412

MODELO: LROT-430i-AK

Garantía 1 Año

6



Caja a color

NOM

DISTRIB.	MAYOREO	LISTA
\$850.00	\$1,215.00	\$1,500.00

190411

120 V ~ / 60 Hz
350 W
3 A
12 000 rev/min
5" (12.7 cm)

30 minutos de trabajo x 10 minutos de descanso. Máximo diario: 3 horas.

- Operables con una sola mano.
- Doble movimiento elíptico y rotativo que proporciona un acabado fino.
- Empuñadura ergonómica para mayor comodidad.
- Emite pocas vibraciones para trabajar sin fatiga.
- Base con Velcro® para mejor fijación de la lija.



! ¿QUÉ INCLUYE MI HERRAMIENTA?

- 1 Recolector de polvo
- 1 Hoja de lija
- 1 Par de carbones
- Garantía e instructivo con listado de centros de servicio.

190411

MODELO: LROT-350p-AK

Garantía 1 Año

10



Caja a color

NOM

DISTRIB.	MAYOREO	LISTA
\$700.00	\$1,000.00	\$1,235.00

PULIDORA

1 400 ó 1 200 ó 110 W

APLICACIONES:

- Ideal para pulir y abrillantar autos, tinas de baño y muebles laminados.



1400 W - 7"
cód. 190702

1200 W - 7"
cód. 190701

110 W - 10"
cód. 390701

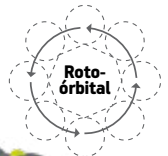

Incluye bonete de tela y bonete de lana

Industrial
AKSI

Profesional
AKSI

Doméstica
MAXTOOL

190702

Tensión / frecuencia	127 V ~ / 60 Hz
Potencia	1 400 W
Corriente	10 A
Velocidad variable (sin carga)	0 - 1 500 - 3 200 rev / min
Diámetro del plato	ø 7" (178 mm)
Maneral de apoyo	TIPO "D"

TIPO DE CUERDA

Tiempo de operación

Ventajas de mi herramienta

En eje 5/8" - 11 (16 mm)

50 minutos de trabajo x 20 minutos de descanso. Máximo diario: 6 horas.

- Maquinaria nivel industrial para mayor rendimiento.
- Preselección del número de revoluciones en 6 niveles para trabajar con diferentes materiales.
- Interruptor diseñado para un mejor control, mayor comodidad y arranque suave.

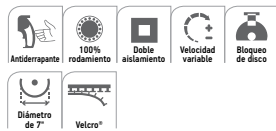

190701

Tensión / frecuencia	127 V ~ / 60 Hz
Potencia	1 200 W
Corriente	8.5 A
Velocidad variable (sin carga)	450 a 3 000 rev / min
Diámetro del plato	ø 7" (178 mm)
Maneral de apoyo	TIPO "D"

En eje 5/8" - 11 (16 mm)

30 minutos de trabajo x 10 minutos de descanso. Máximo diario: 3 horas.

- Preselección del número de revoluciones en 6 niveles para trabajar con diferentes materiales.
- Interruptor diseñado para un mejor control, mayor comodidad y arranque suave.

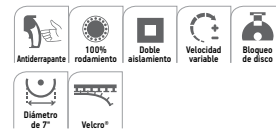

390701

Tensión / frecuencia	127 V ~ / 60 Hz
Potencia	110 W
Corriente	0.75 A
Velocidad variable (sin carga)	3 200 rev / min
Diámetro del plato	ø 10" (254 mm)
Maneral de apoyo	TIPO "D"

15 minutos de trabajo x 8 minutos de descanso. Máximo diario: 1.5 horas.

- Sistema incorporado para evitar dañar la pintura del vehículo.
- Interruptor de encendido continuo.
- Empuñadura en "D" para mejor sujeción.
- Respaldo suave para mayor cuidado al pulir.
- Sistema roto-órbital



¿QUÉ INCLUYE MI HERRAMIENTA?

1 Disco de 7" con Velcro®
1 bonete, 1 mango tipo "D" 1 llave hexagonal,
1 juego de tornillería, 1 par de carbones de repuesto y garantía e instructivo con listado de centros de servicio.

¿QUÉ INCLUYE MI HERRAMIENTA?

1 Disco de 7" con Velcro®
1 bonete, 1 mango tipo "D" 1 llave hexagonal,
1 juego de tornillería, 1 par de carbones de repuesto y garantía e instructivo con listado de centros de servicio.

¿QUÉ INCLUYE MI HERRAMIENTA?

1 Bonete para pulido
1 bonete para abrillantado
Garantía e instructivo con listado de centros de servicio.

190702

MODELO: PLDR-7-1400I-AK

Garantía 1 Año

2



Caja a color

NOM

DISTRIB.	MAYOREO	LISTA
\$1,650.00	\$2,355.00	\$2,910.00

190701

MODELO: PLDR-7-1200-AK

Garantía 1 Año

4



Caja a color

NOM

DISTRIB.	MAYOREO	LISTA
\$1,300.00	\$1,855.00	\$2,295.00

390701

MODELO: PLDR-10-110-MX

Garantía 6 Meses

4



Caja a color

NOM

DISTRIB.	MAYOREO	LISTA
\$720.00	\$1,030.00	\$1,270.00

ACCESORIOS COMPATIBLES PARA TU HERRAMIENTA

Complementa tu herramienta con los accesorios compatibles



Bonete AKSI®

CÓDIGO	MED.	DISTRIB.	MAYOREO	LISTA	
190781	7"	50	\$110.00	\$155.00	\$195.00



Bonete MAXTOOL®

CÓDIGO	MED.	DISTRIB.	MAYOREO	LISTA	
390781	10"	100	\$60.00	\$86.00	\$106.00

PISTOLA DE CALOR 1 500 W

APLICACIONES:

- Ideal para eliminar fácilmente pintura, sellador, pegamentos y masilla con la salida de calor concentrado.



Profesional
AKSI

PISTOLA PARA PINTAR ELÉCTRICA 550 W

APLICACIONES:

- Para pintura de agua o esmalte.
- De uso profesional en el hogar, talleres de pintura y hojalatería.

NUEVO
Capacidad - 800 ml



Profesional
AKSI

190601

Tensión / frecuencia	127 V ~ / 60 Hz
Potencia	1 500 W
Corriente	11.7 A
Volumen de aire	250 - 500 L / min
Temperatura	50° a 550° C
Temperatura fija	50° C

Tiempo de operación

Ventajas de mi herramienta

30 minutos de trabajo x 10 minutos de descanso. Máximo diario: 3 horas.

- El control disminuye el consumo de energía, evitando el sobrecalentamiento, característica que aumenta la vida útil de la máquina.
- La base de soporte permite trabajar con las manos libres especialmente en aplicaciones de alta temperatura.
- 2 niveles de calor: Fijo y regulable.

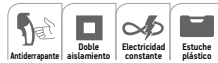

! ¿QUÉ INCLUYE MI HERRAMIENTA?

- 1 Estuche
- 4 Boquillas
- 1 Mango para láminas de calafateo
- 1 Lámina de calafateo
- Garantía e instructivo con listado de centros de servicio.

190601

MODELO: PST-CLR-1500-2-AK

Garantía 1 Año

5



Caja a color

NOM

DISTRIB.	MAYOREO	LISTA
\$850.00	\$1,215.00	\$1,500.00

190651

Tensión / frecuencia	127 V ~ / 60 Hz
Potencia	550 W
Corriente	4.5 A
Capacidad	800 ml
Flujo máximo	600 ml / min
Boquilla	ø 2.5 cm

Tiempo de operación

Ventajas de mi herramienta

30 minutos de trabajo x 10 minutos de descanso. Máximo diario: 3 horas.

- Permite cubrir mayor superficie en tiempos cortos de operación.



! ¿QUÉ INCLUYE MI HERRAMIENTA?

- 1 Medidor de viscosidad
- 1 Cepillo de limpieza
- 1 Aguja para limpieza
- Boquillas metálicas de repuesto
- Garantía e instructivo con listado de centros de servicio.

190651

MODELO: PISTEL-550p-AK

Garantía 1 Año

10



Caja a color

NOM

DISTRIB.	MAYOREO	LISTA
\$700.00	\$1,000.00	\$1,235.00

ESMERIL DE BANCO 560 ó 250 ó 150 W

APLICACIONES:

- Ideal para afilar cuchillas para podadoras de césped, tijeras, desarmadores, brocas y cuchillos.



PROX.

560 W

cód. 197003

8"

DIÁMETRO DE PIEDRA



250 W

cód. 197001

6"

DIÁMETRO DE PIEDRA



150 W

cód. 197002

5"

DIÁMETRO DE PIEDRA



Profesional
AKSI

Profesional
AKSI

Semi.PRO
AKSI

197003

Tensión / frecuencia	127 V ~ / 60 Hz
Potencia	560 W / 3/4 HP
Corriente	3 A
Velocidad (sin carga)	3 450 rev / min
Diámetro de eje	5/8" (16 mm)
Diámetro de piedra	8" (203.4 mm)

Tensión / frecuencia	127 V ~ / 60 Hz
Potencia	560 W / 3/4 HP
Corriente	3 A
Velocidad (sin carga)	3 450 rev / min
Diámetro de eje	5/8" (16 mm)
Diámetro de piedra	8" (203.4 mm)

Tiempo de operación

30 minutos de trabajo x 10 minutos de descanso. Máximo diario: 3 horas.

197001

Tensión / frecuencia	127 V ~ / 60 Hz
Potencia	250 W / 1/3 HP
Corriente	2 A
Velocidad (sin carga)	3 450 rev / min
Diámetro de eje	1/2" (12.7 mm)
Diámetro de piedra	6" (150 mm)

30 minutos de trabajo x 10 minutos de descanso. Máximo diario: 3 horas.

197002

Tensión / frecuencia	127 V ~ / 60 Hz
Potencia	150 W / 1/5 HP
Corriente	1.2 A
Velocidad (sin carga)	3 450 rev / min
Diámetro de eje	1/2" (12.7 mm)
Diámetro de piedra	5" (130 mm)

20 minutos de trabajo x 10 minutos de descanso. Máximo diario: 1.5 horas.

Ventajas de mi herramienta

- Soportes de trabajo ajustables para una mayor comodidad de operación.
- Base de acero que reduce la vibración y mejora la estabilidad.
- Acepta piedras para pulir.



- Soportes de trabajo ajustables para una mayor comodidad de operación.
- Base de acero que reduce la vibración y mejora la estabilidad.
- Acepta piedras para pulir.



- Soportes de trabajo ajustables para una mayor comodidad de operación.
- Base de acero que reduce la vibración y mejora la estabilidad.
- Acepta piedras para pulir.



! ¿QUÉ INCLUYE MI HERRAMIENTA?

1 Piedra de esmeril de grano 36, 1 piedra de esmeril de grano 60, 2 guardas protectoras, 2 soportes de apoyo, tornillería de ensamble y garantía e instructivo con listado de centros de servicio.

! ¿QUÉ INCLUYE MI HERRAMIENTA?

1 Piedra de esmeril de grano 36, 1 piedra de esmeril de grano 60, 2 guardas protectoras, 2 soportes de apoyo, tornillería de ensamble y garantía e instructivo con listado de centros de servicio.

! ¿QUÉ INCLUYE MI HERRAMIENTA?

1 Piedra de esmeril de grano 36, 1 piedra de esmeril de grano 60, 2 guardas protectoras, 2 soportes de apoyo, tornillería de ensamble y garantía e instructivo con listado de centros de servicio.

197003

MODELO: EBANC-B-8-560-AK

Garantía 1 Año

1



Caja a color

NOM

DISTRIB.	MAYOREO	LISTA
\$1,600.00	\$2,285.00	\$2,820.00

197001

MODELO: EBANC-B-6-250-AK

Garantía 1 Año

1



Caja a color

NOM

DISTRIB.	MAYOREO	LISTA
\$950.00	\$1,355.00	\$1,675.00

197002

MODELO: EBANC-B-5-150-AK

Garantía 1 Año

1



Caja a color

NOM

DISTRIB.	MAYOREO	LISTA
\$750.00	\$1,070.00	\$1,325.00

ACCESORIOS COMPATIBLES PARA TU HERRAMIENTA

RUEDA ABRASIVA, ø 6"

Óxido de aluminio

CÓDIGO	MEDIDA	GRANO	🌀	🛡️	DISTRIB.	MAY.	LISTA
114702	3/4" x 1"	36	6	24	\$65.00	\$93.00	\$115.00
114704	1" x 1"	36	6	24	\$75.00	\$107.00	\$132.00
114703	3/4" x 1"	60	6	24	\$65.00	\$93.00	\$115.00
114705	1" x 1"	60	6	24	\$75.00	\$107.00	\$132.00

Carburo de silicio

CÓDIGO	MEDIDA	GRANO	🌀	🛡️	DISTRIB.	MAY.	LISTA
114711	3/4" x 1"	60	6	24	\$105.00	\$150.00	\$185.00
114712	1" x 1"	60	6	24	\$115.00	\$165.00	\$205.00

RUEDA ABRASIVA, ø 5"

Óxido de aluminio

CÓDIGO	MEDIDA	GRANO	🌀	🛡️	DISTRIB.	MAY.	LISTA
114701	3/4" x 1/2"	36	6	24	\$50.00	\$71.00	\$88.00

RUEDA ABRASIVA, ø 8"

Óxido de aluminio

CÓDIGO	MEDIDA	GRANO	🌀	🛡️	DISTRIB.	MAY.	LISTA
114706	1" x 1"	36	6	24	\$115.00	\$165.00	\$205.00
114707	1" x 1"	60	6	24	\$115.00	\$165.00	\$205.00



Algunos modelos incluyen adaptadores
Más detalles en: **Página 344**

SOPLADOR TIPO MOCHILA

A GASOLINA

26 cc

APLICACIONES:

- Ideal para limpieza de jardines, parques y banquetas.

La máquina enciende jalando suavemente



Arnés ergonómico
Tipo mochila
Mayor comodidad



Industrial
AKSI

CORTASETOS

A GASOLINA

25,4 cc

APLICACIONES:

- Ideal para cortar setos, hierba y dar forma.

Guarda transparente que brinda visibilidad de corte



Industrial
AKSI

Cilindrada
Potencia
Velocidad a ralentí (vacío)
Tipo de motor
Velocidad de motor
Velocidad de aire
Volumen de aire
Capacidad tanque

Relación de mezcla: Gasolina-Aceite

Tiempo de operación

Ventajas de mi herramienta

191601
26 cc
700 W
3 500 rev / min
Enfriado por aire 2 tiempos
7 500 - 9 000 rev / min
280 km/h
8 m ³ / min
500 ml

Mezcla recomendada: aceite de 2 tiempos, mineral o sintético. Se recomienda 30:1 (33 ml de aceite por 1 L de gasolina)

Se recomiendan 15 minutos de descanso por cada carga de combustible.

- Motor no contaminante de 2 tiempos con diseño avanzado para una potencia óptima y bajas emisiones.
- Soplador de gran alcance y fácil dirección.
- Carburador de primera calidad para un encendido fácil y un rendimiento óptimo.
- Seguro de gatillo del acelerador.
- Sistema acojinado antivibración.
- Fácil arranque.



¿QUÉ INCLUYE MI HERRAMIENTA?

- 1 Vaso dosificador de combustible
- 1 Llave 5/8" - 3/4" punta plana
- 1 Boquilla de 2 1/4"
- 1 Boquilla de 1 5/8"
- 1 Extensión
- Garantía e instructivo con listado de centros de servicio.



191601

MODELO: SOP25CCI-AK

Garantía 1 Año

1



Caja a color

NOM

DISTRIB. MAYOREO LISTA
\$3,100.00 \$4,430.00 \$5,470.00

Cilindrada
Longitud de corte
Velocidad a ralentí (vacío)
Velocidad del clutch
Velocidad máx. De motor
Capacidad tanque
Encendido

Relación de mezcla: Gasolina-Aceite

Tiempo de operación

Ventajas de mi herramienta

191021
25.4 cc
550 mm
2 700-3400 rev / min
4 300 rev / min
8 500 rev / min
600 ml
Cuerda retráctil

Mezcla recomendada: aceite de 2 tiempos, mineral o sintético. Se recomienda 30:1 (33 ml de aceite por 1 L de gasolina)

Se recomiendan 15 minutos de descanso por cada carga de combustible.

- Motor no contaminante de 2 tiempos con diseño avanzado para una potencia óptima y bajas emisiones.
- Carburador de primera calidad para un encendido fácil y un rendimiento óptimo.
- Cuchillas sincronizadas para proporcionar un excelente corte.
- Seguro de gatillo del acelerador.



¿QUÉ INCLUYE MI HERRAMIENTA?

- 1 Vaso dosificador de combustible
- 1 Desarmador punta plana 1/2" - 3/4"
- 1 Desarmador de cruz
- Garantía e instructivo con listado de centros de servicio.



191021

MODELO: CCETOS-25-AK

Garantía 1 Año

1



Caja a color

NOM

DISTRIB. MAYOREO LISTA
\$2,700.00 \$3,855.00 \$4,765.00

DESMALZADORA

EJE RECTO/MANGO TIPO "BICI"
A GASOLINA

APLICACIONES: USO RUDO

- Ideal para cortar pasto, hierba, maleza y desorillar.



52 cc

16"
(41 cm)DIÁMETRO
DE CORTE

cód. 190901



33 cc

16.5"
(42 cm)DIÁMETRO
DE CORTE

cód. 190903

Industrial

AKSI

Industrial

AKSI

¡HERRAMIENTA MEJORADA!

Cubierta del tanque de gasolina reforzada, antes plástico ahora metal

190901

Cilindrada	52 cc
Potencia	1 400 W (1.9 HP)
Velocidad	8 500 rev / min
Tipo de eje	Recto
Tipo de asa	Tipo "Bici"
Diámetro de corte	16" (41 cm)
Diámetro de hilo	7/64" (2.8 mm)
Capacidad de combustible	1200 ml
Encendido	Con cuerda retráctil
Duración de tanque	1 hora

Mezcla recomendada: aceite de 2 tiempos, mineral o sintético. Se recomienda 30:1 (33 ml de aceite por 1 L de gasolina)

Se recomiendan 15 minutos de descanso por cada carga de combustible.

- Motor no contaminante de 2 tiempos con diseño avanzado para una potencia óptima y bajas emisiones.
- Carburador de primera calidad para un encendido fácil y un rendimiento óptimo.
- Recortadora de eje recto para áreas de difícil acceso.
- Nuevo sistema de arranque mejorado con embrague.
- Sólido cigüeñal que soporta altas revoluciones y un intenso uso profesional asegurando una larga vida útil.
- Mango de control tipo bici, facilita su manejo.
- Cabezal con alimentación semiautomática de doble hilo.
- Incluye guarda.



¿QUÉ INCLUYE MI HERRAMIENTA?

1 Mango tipo "Bici", 1 cuchilla TRI-ARC®, 1 sierra circular, 1 guarda, 1 arnés completo, 1 llave para bujías, 1 llave hexagonal, 1 vaso dosificador, 1 carrete con hilo, 1 retén metálico, 1 brida, 1 cubierta de protección, 1 tuerca izquierda M13, 2 abrazaderas de plástico (cinchos) y garantía e instructivo con listado de centros de servicio.

190901

MODELO: DSMLZ-52CC-AK

Garantía 1 Año

🔧 1

Caja a color

DISTRIB.	MAYOREO	LISTA
\$3,450.00	\$4,930.00	\$6,085.00

190903

Cilindrada	33 cc
Potencia	900 W (1.2 HP)
Velocidad	6 500 rev / min
Tipo de eje	Recto
Tipo de asa	Tipo "Bici"
Diámetro de corte	16.5" / (42 cm)
Diámetro de hilo	7/64" (2.8 mm)
Capacidad de combustible	700 ml
Encendido	Con cuerda retráctil
Duración de tanque	45 minutos

Mezcla recomendada: aceite de 2 tiempos, mineral o sintético. Se recomienda 30:1 (33 ml de aceite por 1 L de gasolina)

Se recomiendan 15 minutos de descanso por cada carga de combustible.

- Motor no contaminante de 2 tiempos con diseño avanzado para una potencia óptima y bajas emisiones.
- Carburador de primera calidad para un encendido fácil y un rendimiento óptimo.
- Recortadora de eje recto para áreas de difícil acceso.
- Nuevo sistema de arranque mejorado con embrague.
- Sólido cigüeñal que soporta altas revoluciones y un intenso uso profesional asegurando una larga vida útil.
- Mango de control tipo bici, facilita su manejo.
- Cabezal con alimentación semiautomática de doble hilo.
- Incluye guarda.



¿QUÉ INCLUYE MI HERRAMIENTA?

1 Mango tipo "Bici", 1 cuchilla TRI-ARC®, 1 sierra circular, 1 guarda, 1 arnés con soporte, 1 carrete, 1 desarmador de cruz, 2 llaves hexagonales, 2 abrazaderas de plástico, 1 vaso dosificador y garantía e instructivo con listado de centros de servicio.

190903

MODELO: DSMLZ-52CC-AK

Garantía 1 Año

🔧 1

Caja a color

DISTRIB.	MAYOREO	LISTA
\$3,300.00	\$4,715.00	\$5,820.00

Cilindrada	
Potencia	
Velocidad	
Tipo de eje	
Tipo de asa	
Diámetro de corte	
Diámetro de hilo	
Capacidad de combustible	
Encendido	
Duración de tanque	

Relación de mezcla: Gasolina-Aceite

Tiempo de operación

Ventajas de mi herramienta

Enriquece tu herramienta con

HILO AKSI®

PÁG. 127



Enriquece tu herramienta con

ACEITE 2 TIEMPOS

PÁG. 49



DESBROZADORA

EJE RECTO / MANGO "T" o
EJE CURVO / MANGO "D"
A GASOLINA

APLICACIONES:

· Ideal para cortar pasto, hierba y desorillar.

**52 cc****16"**
(41 cm)DIÁMETRO
DE CORTE

cód. 190904

**43 cc****18"**
(45.7 cm)DIÁMETRO
DE CORTE

cód. 190907

De ensamble
Lo que facilita
su transportación.**25 cc****15"**
(38 cm)DIÁMETRO
DE CORTE

cód. 190902

Profesional
AKSI**Profesional**
AKSI**Profesional**
AKSI**190904**

Cilindrada	52 cc
Potencia	1 400 W (1.9 HP)
Velocidad	8 500 rev / min
Tipo de eje	Recto
Tipo de asa	Tipo "Bici"
Diámetro de corte	16" (41 cm)
Diámetro de hilo	7/64" (2.8 mm)
Capacidad de combustible	1200 ml
Encendido	Con cuerda retráctil

Relación de mezcla: Gasolina-Aceite**Tiempo de operación****Ventajas de mi herramienta**

Enríchez tu herramienta con

HILO AKSI®

PÁG. 127



Enríchez tu herramienta con

ACEITE 2 TIEMPOS

PÁG. 49

**¿QUÉ INCLUYE MI HERRAMIENTA?**

- 1 Mango tipo "Bici"
- 1 Guarda
- 1 Arnés completo
- 1 Llave para bujías
- 1 Llave hexagonal
- 1 Vaso dosificador
- 1 Carrete con hilo
- 1 Retén metálico
- 1 Brida
- 1 Cubierta de protección
- 1 Tuerca izquierda M13
- 2 Abrazaderas de plástico (cinchos)
- Garantía e instructivo con listado de centros de servicio.

190904

MODELO: DSBZR-52CC-AK

Garantía 1 Año

1



Caja a color

DOBLE CAJA
Se guarda en dos cajas, permitiendo un fácil almacenaje en menor espacio.

DISTRIB.	MAYOREO	LISTA
\$2,950.00	\$4,215.00	\$5,205.00

190907

Cilindrada	43 cc
Potencia	1.7 HP
Velocidad	10 000 rev / min
Tipo de eje	Recto
Tipo de asa	Tipo "D"
Diámetro de corte	18" / (45.7 cm)
Diámetro de hilo	De 2 a 2.6" (2.8 mm)
Capacidad de combustible	1200 ml
Encendido	Con cuerda retráctil

Mezcla recomendada: aceite de 2 tiempos, mineral o sintético. Se recomienda 30:1 (33 ml de aceite por 1 L de gasolina)

Se recomiendan 15 minutos de descanso por cada carga de combustible.

- Motor no contaminante de 2 tiempos con diseño avanzado para una potencia óptima y bajas emisiones.
- Carburador de primera calidad para un encendido fácil y un rendimiento óptimo.
- Recortadora de eje recto para áreas difíciles.
- Nuevo sistema de arranque mejorado con embrague.

**¿QUÉ INCLUYE MI HERRAMIENTA?**

- 1 Extensión
- 1 Carrete con hilo
- 1 Brida
- 1 Mango tipo "D"
- 1 Guarda protectora
- 1 Juego de tornillería para ensamble
- 1 Vaso dosificador
- 1 Arnés
- 1 Llave hexagonal
- Garantía e instructivo con listado de centros de servicio.

190907

MODELO: DSBZR-43CCp-AK

Garantía 1 Año

1



Caja a color

DISTRIB.	MAYOREO	LISTA
\$2,250.00	\$3,215.00	\$3,970.00

190902

Cilindrada	25 cc
Potencia	750 W (1 HP)
Velocidad	8 000 rev / min
Tipo de eje	Curvo
Tipo de asa	Tipo "D"
Diámetro de corte	15" / (38 cm)
Diámetro de hilo	De 2 a 2.4" (2.8 mm)
Capacidad de combustible	750 ml
Encendido	Con cuerda retráctil

Mezcla recomendada: aceite de 2 tiempos, mineral o sintético. Se recomienda 30:1 (33 ml de aceite por 1 L de gasolina)

Se recomiendan 15 minutos de descanso por cada carga de combustible.

- Sólido cigüeñal que soporta altas revoluciones y un intenso uso asegurando una larga vida útil.
- Cabezal de corte con alimentación semiautomática de doble hilo.

**¿QUÉ INCLUYE MI HERRAMIENTA?**

- 1 Mango tipo "D"
- 1 Guarda protectora
- 1 Llave mixta tipo "T" de 11/16" - 3/4"
- 1 Desarmador de cruz 1 Juego de tornillería para ensamble
- 1 Vaso dosificador 1 Arnés
- 1 Llave hexagonal
- Garantía e instructivo con listado de centros de servicio.

190902

MODELO: DSBZR-25CC-2-AK

Garantía 1 Año

1



Caja a color

DISTRIB.	MAYOREO	LISTA
\$1,950.00	\$2,785.00	\$3,440.00

DESBROZADORA 2 en 1 con MOTOSIERRA con CORTACETOS

APLICACIONES:

- Ideal para cortar pasto, hierba y desorillar.



43 cc

18" (41 cm)

DIÁMETRO DE CORTE

cód. 190908



De ensamble e intercambiable
Combinalos entre desbrozadora y sierra
o desbrozadora y cortacetos.



43 cc

18" (41 cm)

DIÁMETRO DE CORTE

cód. 190909

Profesional
AKSI

Profesional
AKSI

Cilindrada
Potencia
Velocidad
Tipo de eje
Tipo de asa
Diámetro de corte
Diámetro de hilo
Capacidad de combustible
Encendido

Longitud de espada
Ancho de espada
Aceite para lubricación

Relación de mezcla: Gasolina-Aceite

Tiempo de operación

Ventajas de mi herramienta

Enriquece tu herramienta con
HILO AKSI®

PÁG. 127



Enriquece tu herramienta con
ACEITE 2 TIEMPOS

PÁG. 49



190908

DESBROZADORA

43 cc
1.7 HP
10 000 rev / min
Recto
Tipo "D"
18" / (45.7 cm)
De 2 a 2.6" (2.8 mm)
1200 ml
Con cuerda retráctil

MOTOSIERRA

13.5" (34.2 cm)
5.4 cm
Aceite hidráulico

Mezcla recomendada: aceite de 2 tiempos, mineral. Se recomienda 25:1 (40 ml de aceite por 1 L de gasolina)

Se recomiendan 15 minutos de descanso por cada carga de combustible.

- Motor no contaminante de 2 tiempos con diseño avanzado para una potencia óptima y bajas emisiones.
- Carburador de primera calidad para un encendido fácil y un rendimiento óptimo.
- Recortadora de eje recto para áreas difíciles.
- Nuevo sistema de arranque mejorado con embrague.



¿QUÉ INCLUYE MI HERRAMIENTA?

1 Mango tipo "D", 6 tornillos, 4 tuercas, 1 abrazadera metálica, 2 abrazaderas de neopreno, 2 llaves hexagonales, 1 llave para bujía, 1 carrete con hilo, 1 desarmador, 1 arnés, 1 vaso dosificador, 1 brida inferior para disco, 1 tuerca de seguridad para disco, 1 cabezal motosierra, 1 motor, 1 cabezal desbrozadora, 1 guarda, 1 cadena, 1 espada, 1 llave, 1 extensión, 1 disco tri-arc y garantía e instructivo con listado de centros de servicio.

190908

MODELO: DSBRZ-MT-43CCp-AK

Garantía 1 Año

1



Caja a color

DISTRIB.	MAYOREO	LISTA
\$3,000.00	\$4,285.00	\$5,290.00

190909

DESBROZADORA

43 cc
1.7 HP
10 000 rev / min
Recto
Tipo "D"
18" / (45.7 cm)
De 2 a 2.6" (2.8 mm)
1200 ml
Con cuerda retráctil

CORTACETOS

17" (43.2 cm)
6 cm

Mezcla recomendada: aceite de 2 tiempos, mineral. Se recomienda 25:1 (40 ml de aceite por 1 L de gasolina)

Se recomiendan 15 minutos de descanso por cada carga de combustible.

- Motor no contaminante de 2 tiempos con diseño avanzado para una potencia óptima y bajas emisiones.
- Carburador de primera calidad para un encendido fácil y un rendimiento óptimo.
- Recortadora de eje recto para áreas difíciles.
- Nuevo sistema de arranque mejorado con embrague.



¿QUÉ INCLUYE MI HERRAMIENTA?

1 Mango tipo "D", 6 tornillos, 4 tuercas, 1 abrazadera metálica, 2 abrazaderas de neopreno, 2 llaves hexagonales, 1 llave para bujía, 1 carrete con hilo, 1 desarmador, 1 arnés, 1 vaso dosificador, 1 brida inferior para disco, 1 brida superior para disco, 1 casquillo para disco, 1 tuerca de seguridad para disco, 1 cabezal cortacetos, 1 motor, 1 cabezal desbrozadora, 1 guarda, 1 extensión y garantía e instructivo con listado de centros de servicio.

190909

MODELO: DSBRZ-CT-43CCp-AK

Garantía 1 Año

1



Caja a color

DISTRIB.	MAYOREO	LISTA
\$3,300.00	\$4,715.00	\$5,820.00

ACCESORIOS COMPATIBLES PARA TU HERRAMIENTA

Complementa tu herramienta con los accesorios compatibles



Desmalezadora 18"

CÓDIGO	DISTRIB.	MAYOREO	LISTA
190907	1	\$2,250.00	\$3,215.00



Disco TRI-ARC desmalezadora 10"

∅ Externo	10" (254 mm)
∅ Interno	1" (25.4 mm)
Número de segmentos	3

CÓDIGO	DISTRIB.	MAYOREO	LISTA
190991	50	\$115.00	\$205.00



Disco para desmalezadora 10"

∅ Externo	10" (254 mm)
∅ Interno	1" (25.4 mm)
Número de dientes	40

CÓDIGO	DISTRIB.	MAYOREO	LISTA
190992	100	\$125.00	\$220.00

DESBROZADORA ELÉCTRICA 300 ó 500 W

APLICACIONES:

- Ideal para uso en jardinería.

PODADORA ELÉCTRICA 1 000 W

APLICACIONES:

- Ideal para corte de césped en diferentes alturas.



Mango tipo D

500 W

11" (28 cm)

DIÁMETRO DE CORTE

cód. 190801

300 W

10" (25.4 cm)

DIÁMETRO DE CORTE

cód. 390801

Bolsa de recolección

Profesional
AKSI

Doméstica
TI MAXTOOL

Semi.PRO
AKSI



TIPS DE USU1

Tensión / frecuencia
Potencia
Corriente
Velocidad
Trayecto de corte
Tipo de eje
Tipo de empuñadura
Diámetro de hilo

Tiempo de operación

Ventajas de mi herramienta

190801

127 V ~ / 60 Hz
500 W
4 A
11 000 rev / min
11" (28 cm)
Ajuste de altura
Tipo "D"
De 1.5 a 1.6 mm

30 minutos de trabajo x 10 minutos de descanso. Máximo diario: 6 horas.

- Empuñadura ergonómica para mayor comodidad.
- Guía lateral desplegable para desorillar.
- Baja vibración para trabajar sin fatiga.
- Eje superior ajustable.
- Gancho traba de cable para evitar la desconexión eléctrica no deseada.
- Mango auxiliar tipo "D" con diferentes posiciones.
- Incluye guarda.



¿QUÉ INCLUYE MI HERRAMIENTA?

- 1 Mango tipo "D"
- 1 Guarda protectora
- 1 Juego de tornillería para ensamble
- 1 Rueda desorilladora
- 1 Carrete con hilo
- Garantía e instructivo con listado de centros de servicio.

190801

MODELO: DSBZR-500-AK

Garantía 1 Año

4



Caja a color

NOM

DISTRIB.	MAYOREO	LISTA
\$900.00	\$1,285.00	\$1,590.00

390801

127 V ~ / 60 Hz
300 W
3 A
11 000 rev / min
10" (25.4 cm)
Desmontable
Tipo "D"
De 1.2 a 1.6 mm

15 minutos de trabajo x 8 minutos de descanso. Máximo diario: 1 hora.

- Mango ergonómico con gatillo para comodidad de agarre.
- Con pocas vibraciones para trabajar sin fatiga.
- Gancho traba para cable que evita la desconexión eléctrica no deseada.
- Incluye guarda.



¿QUÉ INCLUYE MI HERRAMIENTA?

- 1 Mango tipo "T"
- 1 Guarda protectora
- 2 Pijas
- 1 Carrete con hilo
- 1 Par de carbones de repuesto
- Garantía e instructivo con listado de centros de servicio.

390801

MODELO: DSBZR-300-MX

Garantía 6 Meses

10



Caja a color

NOM

DISTRIB.	MAYOREO	LISTA
\$480.00	\$685.00	\$845.00

190831

127 V ~ / 60 Hz
1 000 W
8.3 A
4 000 rev / min (sin carga)
12" - 12.5" (300 - 320 mm)
Altura de corte: 20, 40 y 55 mm

30 minutos de trabajo x 15 minutos de descanso. Máximo diario: 1.5 horas.

- Altura regulable de la cuchilla para 3 niveles de corte.
- Seguro para evitar encendido accidental.
- Ajuste sencillo para la altura de corte.
- Sistema de corte que dirige el césped cortado hacia la bolsa de recolección.
- Estructura abatible que permite almacenamiento de manera compacta.



¿QUÉ INCLUYE MI HERRAMIENTA?

- 1 Conjunto de manija de sujeción con seguro de interruptor
- 1 Caja recolectora de césped
- 4 Ruedas con cubierta
- 1 Sujeta cable
- 2 Abrazaderas
- 2 Perillas mariposa
- Garantía e instructivo con listado de centros de servicio.

190831

MODELO: POD-1000s-AK

Garantía 1 Año

1



Caja a color

NOM

DISTRIB.	MAYOREO	LISTA
\$1,750.00	\$2,500.00	\$3,085.00

Enriquece tu herramienta con
HILO AKSI®



PÁG. 127

MOTOSIERRA A GASOLINA

APLICACIONES:

- Ideal para talar troncos de encino, pino, etc.

USO AGRÍCOLA

- No causa I.V.A.



Freno de cadena, máxima protección al usuario



El freno de cadena se activa al empujar hacia adelante la palanca del freno de cadena con la muñeca izquierda

45 cc - 18"

cód. 191001

45 cc - 16"

cód. 191003

56.5 cc - 20"

cód. 191004

45 cc - 20"

cód. 191002



Industrial
AKSI

Industrial
AKSI

Industrial
AKSI

Industrial
AKSI

Cilindrada	45 cc
Potencia nominal motor	1 800 W (2.4 HP)
Velocidad	10 000 rev / min
Longitud de la espada	18" (457.2 mm)
Nivel de ruido	115 dB
Capacidad de tanque	500 ml

Capacidad de perforación

Relación de mezcla: Gasolina-Aceite

Tiempo de operación

Ventajas de mi herramienta

191001

45 cc
1 800 W (2.4 HP)
10 000 rev / min
18" (457.2 mm)
115 dB
500 ml

18"

Hasta 34" (863.6 mm)

191003

45 cc
1 800 W (2.4 HP)
11 000 rev / min
16" (406.4 mm)
113 dB
500 ml

16"

Hasta 32" (812.8 mm)

191004

56,5 cc
2 500 W (3.3 HP)
11 000 rev / min
20" (508 mm)
117 dB
700 ml

20"

Hasta 36" (914.4 mm)

191002

45 cc
1 800 W (2.4 HP)
10 000 rev / min
20" (508 mm)
117 dB
500 ml

20"

Hasta 36" (914.4 mm)

PARA TODOS LOS MODELOS: Mezcla recomendada aceite de 2 tiempos, mineral o sintético. Se recomienda 40:1 (25 ml de aceite por 1 L de gasolina)

15 minutos de descanso por cada carga de combustible

15 minutos de descanso por cada carga de combustible

15 minutos de descanso por cada carga de combustible

15 minutos de descanso por cada carga de combustible

- Freno de mano activado por inercia.
- Eficaces amortiguadores antivibración.
- Impulsión por engranaje y autosuministro de aceite para una mayor lubricación en la espada y cadena.
- Sólido cigüeñal que soporta altas revoluciones y un intenso uso, asegurando una larga vida útil.



- Freno de mano activado por inercia.
- Eficaces amortiguadores antivibración.
- Impulsión por engranaje y autosuministro de aceite para una mayor lubricación en la espada y cadena.
- Sólido cigüeñal que soporta altas revoluciones y un intenso uso, asegurando una larga vida útil.



- Freno de mano activado por inercia.
- Eficaces amortiguadores antivibración.
- Impulsión por engranaje y autosuministro de aceite para una mayor lubricación en la espada y cadena.
- Sólido cigüeñal que soporta altas revoluciones y un intenso uso, asegurando una larga vida útil.



- Freno de mano activado por inercia.
- Eficaces amortiguadores antivibración.
- Impulsión por engranaje y autosuministro de aceite para una mayor lubricación en la espada y cadena.
- Sólido cigüeñal que soporta altas revoluciones y un intenso uso, asegurando una larga vida útil.



! ¿QUÉ INCLUYE MI HERRAMIENTA?

- 1 Vaso dosificador
- 1 Llave para bujía
- 1 Desarmador punta plana
- 1 Funda para espada
- 1 Cadena de 18"
- 1 Lima para afilado de cadena
- Garantía e instructivo con listado de centros de servicio.

! ¿QUÉ INCLUYE MI HERRAMIENTA?

- 1 Vaso dosificador
- 1 Llave para bujía
- 1 Desarmador punta plana
- 1 Funda para espada
- 1 Cadena de 16"
- Garantía e instructivo con listado de centros de servicio.

! ¿QUÉ INCLUYE MI HERRAMIENTA?

- 1 Vaso dosificador
- 1 Llave para bujía
- 1 Desarmador punta plana
- 1 Funda para espada
- 1 Cadena de 20"
- Garantía e instructivo con listado de centros de servicio.

! ¿QUÉ INCLUYE MI HERRAMIENTA?

- 1 Vaso dosificador
- 1 Llave para bujía
- 1 Desarmador punta plana
- 1 Funda para espada
- 1 Cadena de 20"
- 1 Lima para afilado de cadena
- Garantía e instructivo con listado de centros de servicio.

Enriquece tu herramienta con
ACEITE 2 TIEMPOS

PÁG. 49



Incluye funda para espada



Incluye vaso dosificador

191001

MODELO: MTSRA-18-45-AK

Garantía 1 Año



Caja a color

DISTRIB. MAYOREO LISTA
\$2,250.00 \$3,215.00 \$4,605.00

191003

MODELO: MTSRA-16-45i-AK

Garantía 1 Año



Caja a color

DISTRIB. MAYOREO LISTA
\$2,150.00 \$3,070.00 \$4,400.00

191004

MODELO: MTSRA-20-56i-AK

Garantía 1 Año



Caja a color

DISTRIB. MAYOREO LISTA
\$2,650.00 \$3,785.00 \$5,420.00

191002

MODELO: MTSRA-20-45-AK

Garantía 1 Año



Caja a color

DISTRIB. MAYOREO LISTA
\$2,350.00 \$3,355.00 \$4,810.00

FUMIGADOR tipo mochila

A GASOLINA
25 L - 1 HP

USO AGRÍCOLA
· No causa I.V.A.



PROX.

25 L - 1 HP

cód. 191031

Industrial
AKSI

191031

Capacidad	25 L (6.6 gal)
Presión máxima de trabajo	362 psi
Potencia	750 W (1 HP)
Cilindrada del motor	25 cc
Peso	9 kg

Tiempo de operación

15 minutos de descanso por cada carga de combustible

Ventajas de mi herramienta

- Motor a 2 tiempos, mezcla de aceite y gasolina 50:1
- Arranque manual (cuerda retráctil)
- Lanzas y boquillas de acero inoxidable
- Doble lanza de 60 cm
- Presión regulable
- Doble manguera de pulverizado
- 2 Tipos de rociado
- Tanque de polietileno
- Mangos con válvula



¿QUÉ INCLUYE MI HERRAMIENTA?

- 2 Extensiones con 3 boquillas
- 2 Mangueras
- 1 Lanceta
- 2 Mangos con válvula
- 1 Conexión tipo Y
- 1 Llave hexagonal / destornillador
- 1 Mezclador gasolina - aceite
- Garantía e instructivo con listado de centros de servicio.

191031

MODELO: FUMGS-25cci-AK

Garantía 1 Año

1



Caja a color

NOM

DISTRIB.	MAYOREO	LISTA
\$2,700.00	\$3,855.00	\$5,525.00

Fumigador 1 ó 2 litros

CAJA

- ▶ Boquilla regulable que logra desde un rocío fino hasta un chorro uniforme
- ▶ Pistón y gatillo de suave acción
- ▶ Para uso en interiores y exteriores
- ▶ Útil para riego, control de plagas, limpieza general, etc.



1
año
GARANTÍA

AKSI

CÓDIGO	CAPACIDAD			DISTRIB.	MAYOREO	LISTA
103503	1 L	4	16	\$75.00	\$107.00	\$132.00
103504	2 L	4	16	\$95.00	\$136.00	\$170.00

Fumigador 15 litros tipo mochila

CAJA

- ▶ Pipeta y boquilla de polipropileno
- ▶ Tanque translúcido que permite ver el nivel del líquido
- ▶ Manguera de PVC



1
año
GARANTÍA

AKSI

USO AGRÍCOLA
No causa I.V.A.

CÓDIGO	CAPACIDAD			DISTRIB.	MAYOREO	LISTA
103515	15 L	1		\$650.00	\$930.00	\$1,330.00

Fumigador 5 litros

CAJA

- ▶ Práctico y ligero para el control de plagas
- ▶ Boquilla de aspersión más grande, que brinda mayor área de rocío
- ▶ Correa de tejido de Nylon® ligera y resistente para portar al hombro



18
meses
GARANTÍA

MAXTOOL

USO AGRÍCOLA
No causa I.V.A.

CÓDIGO	CAPACIDAD			DISTRIB.	MAYOREO	LISTA
301101	5 L	6		\$180.00	\$255.00	\$370.00

TIPOS DE Bombas para agua



¿Qué necesito?

	Tipo	Línea			
		- COSTO	+ BENEFICIO		
Altura	PERIFÉRICAS Mayor presión, haciendo subir el agua a una mayor altura, su caudal es menor.	 1/2 HP Maxtool Código: 391301 Altura: 20 m Hmin Flujo: 30 L/min	 1 HP Pro Código: 191323 Altura: 56 m Hmin Flujo: 50 L/min		
Flujo	CENTRÍFUGAS Mayor volumen de agua. Perfecta para llevar agua de la cisterna al tinaco.	 1/2 HP Pro Código: 191341 Altura: 19 m Hmin Flujo: 80 L/min	 1 HP Pro Código: 191343 Altura: 30 m Hmin Flujo: 103 L/min		
Extraer agua a corta profundidad	SUMERGIBLES Bomba totalmente sellada y a prueba de agua.	 1/2 HP Pro Código: 191302 Altura: 7 m Hmin Flujo: 108 L/min	 1 HP Pro Código: 191301 Altura: 8 m Hmin Flujo: 216 L/min		Vaciado de albercas, circulación de agua en fuentes
		 1/2 HP Pro Código: 191313 Altura: 18 m Hmin Flujo: 120 L/min	 1 HP Pro Código: 191311 Altura: 30 m Hmin Flujo: 180 L/min		
Extraer agua a larga profundidad	SUMERGIBLE TIPO BALA Ideal para espacios estrechos. Ofrecen mayor altura, presión y distancia.	 3/4 HP Ind Código: 191363 Altura: 50 m Hmin Flujo: 100 L/min	 1 1/2 HP Ind Código: 191361 Altura: 90 m Hmin Flujo: 100 L/min		Ideal para pozos
Extraer agua con caudal máximo	MOTOBOMBA	 5.5 HP 2" Código: 197101 Altura: 28 m Hmin Flujo: 505 L/min	 6.5 HP 3" Código: 197102 Altura: 26 m Hmin Flujo: 1 160 L/min		Ideal para riego en terrenos extensos

BOMBA PRESURIZADORA 1/6 ó 1/3 HP

APLICACIONES:

- El motor arranca automáticamente cuando abres el grifo y diriges el agua a su destino
- Se utiliza para ahorrar el consumo de líquido y prolongar la vida útil de la tubería
- La presión evita estancamiento o el bloqueo
- Uso doméstico
- Silenciosa

PROX.

1/6 HP- 25 L/m

cód. 191381



PROX.

1/3 HP- 60 L/m

cód. 191382

Profesional
AKSI

Profesional
AKSI

191381

Tensión / frecuencia	127 V ~ / 60 Hz
Potencia	1/6 HP
Corriente	1 A
Velocidad	3 450 rev/min
Altura manométrica total	10 m
Temperatura máxima de líquido	80° C
Ø Entrada / salida:	1/2" NPT
Caudal máximo	25 L/min
Grado de protección	IP44

Tensión / frecuencia	127 V ~ / 60 Hz
Potencia	1/3 HP
Corriente	2 A
Velocidad	3 450 rev/min
Altura manométrica total	20 m
Temperatura máxima de líquido	80° C
Ø Entrada / salida:	3/4" NPT
Caudal máximo	60 L/min
Grado de protección	IP44

191382

Tensión / frecuencia	127 V ~ / 60 Hz
Potencia	1/3 HP
Corriente	2 A
Velocidad	3 450 rev/min
Altura manométrica total	20 m
Temperatura máxima de líquido	80° C
Ø Entrada / salida:	3/4" NPT
Caudal máximo	60 L/min
Grado de protección	IP44

Tiempo de operación

50 minutos de trabajo x 20 minutos de descanso.

50 minutos de trabajo x 20 minutos de descanso.

Ventajas de mi herramienta

- Impulsor de acero inoxidable.
- Incorpora sistema de protección.
- Base preparada para su fijación.
- Carcasa 100% metálica.

- Impulsor de acero inoxidable.
- Incorpora sistema de protección.
- Base preparada para su fijación.
- Carcasa 100% metálica.

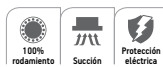

! ¿QUÉ INCLUYE MI HERRAMIENTA?

Garantía e instructivo con listado de centros de servicio.

! ¿QUÉ INCLUYE MI HERRAMIENTA?

Garantía e instructivo con listado de centros de servicio.

191381

MODELO: BP-1/6p-AK
Garantía 1 Año



Caja a color

NOM

DISTRIB. \$650.00 MAYOREO \$930.00 LISTA \$1,145.00

191382

MODELO: BP-1/3p-AK
Garantía 1 Año



Caja a color

NOM

DISTRIB. \$1,100.00 MAYOREO \$1,570.00 LISTA \$1,940.00

Control automático de presión de bombas para agua 90° y 180°

APLICACIONES:

- Para uso con bombas periféricas, periféricas autocebantes, centrífugas, presurizadoras, tipo jet y presurizadoras multi-etapas
- Usar con bombas de 1/2 hasta 1 1/2 HP (excepto bombas sumergibles)
- Encendido automático al detectar flujo de agua
- Sensor de flujo que protege la bomba contra daños causados por el funcionamiento en seco
- Manómetro y luz indicador LED

VENTAJAS:

- Presión regulable
- Mantiene el flujo y presión de agua
- Se activa con el flujo de agua

NUEVO

90°



191371

Presión de trabajo	145 PSI
Consumo	10 A
Ángulo de salida	90°
Ø De entrada - salida	1"
Temperatura máxima del agua	60°

Garantía 1 Año

12



Caja a color

NOM

DISTRIB. \$500.00 MAYOREO \$715.00 LISTA \$880.00

NUEVO

180°



191372

Presión de trabajo	145 PSI
Consumo	10 A
Ángulo de salida	180°
Ø De entrada - salida	1"
Temperatura máxima del agua	60°

Garantía 1 Año

12



Caja a color

NOM

DISTRIB. \$500.00 MAYOREO \$715.00 LISTA \$880.00

BOMBA PERIFÉRICA

1/2 ó 3/4 ó 1 HP

Las bombas periféricas proporcionan mayor presión, haciendo subir el agua a una mayor altura, su caudal generalmente es menor

USO AGRÍCOLA
· No causa I.V.A.



1/2 HP- 370 W

cód. 191321



3/4 HP- 550 W

cód. 191322



1 HP- 750 W

cód. 191323



1/2 HP- 370 W

cód. 391301



Profesional
AKSI

Profesional
AKSI

Profesional
AKSI

Doméstica
MAXITOL

191321

Tensión / frecuencia	127 V ~ / 60 Hz
Potencia	370 W / 1/2 HP
Corriente	4.8 A
Velocidad	3 450 rev / min (sin carga)
Altura manométrica total	30 m
Profundidad máxima de succión	9 m
Ø entrada / salida	1" NPT (25.4 mm)
Caudal máximo	38 L/min

Tensión / frecuencia	127 V ~ / 60 Hz
Potencia	550 W / 3/4 HP
Corriente	8 A
Velocidad	3 450 rev / min (sin carga)
Altura manométrica total	48 m
Profundidad máxima de succión	9 m
Ø entrada / salida	1" NPT (25.4 mm)
Caudal máximo	48 L/min

191322

Tensión / frecuencia	120 V ~ / 60 Hz
Potencia	750 W / 1 HP
Corriente	10 A
Velocidad	3 450 rev / min (sin carga)
Altura manométrica total	56 m
Profundidad máxima de succión	9 m
Ø entrada / salida	1" NPT (25 mm)
Caudal máximo	50 L/min

191323

Tensión / frecuencia	127 V ~ / 60 Hz
Potencia	370 W / 1/2 HP
Corriente	4.8 A
Velocidad	3 450 rev / min (sin carga)
Altura manométrica total	20 m
Profundidad máxima de succión	9 m
Ø entrada / salida	1" NPT (25 mm)
Caudal máximo	30 L/min

391301

Tensión / frecuencia	127 V ~ / 60 Hz
Potencia	370 W / 1/2 HP
Corriente	4.8 A
Velocidad	3 450 rev / min (sin carga)
Altura manométrica total	20 m
Profundidad máxima de succión	9 m
Ø entrada / salida	1" NPT (25 mm)
Caudal máximo	30 L/min

Tiempo de operación

Ventajas de mi herramienta

50 minutos de trabajo x 20 minutos de descanso. Máximo diario: 6 horas.

50 minutos de trabajo x 20 minutos de descanso. Máximo diario: 6 horas.

50 minutos de trabajo x 20 minutos de descanso. Máximo diario: 6 horas.

15 minutos de trabajo x 8 minutos de descanso. Máximo diario: 1 hora.

- Impulsor de latón.
- Incorpora sistema de protección.
- Base preparada para su fijación.
- Carcasa 100% metálica.

- Impulsor de latón.
- Incorpora sistema de protección.
- Base preparada para su fijación.
- Carcasa 100% metálica.

- Impulsor de latón.
- Incorpora sistema de protección.
- Base preparada para su fijación.
- Carcasa 100% metálica.

- Impulsor de latón.
- Incorpora sistema de protección.
- Base preparada para su fijación.
- Carcasa 100% metálica.



Impulsor de latón en todas las bombas periféricas

! ¿QUÉ INCLUYE MI HERRAMIENTA?

Diámetro de entrada y salida de 1"
Garantía e instructivo con listado de centros de servicio.

! ¿QUÉ INCLUYE MI HERRAMIENTA?

Diámetro de entrada y salida de 1"
Garantía e instructivo con listado de centros de servicio.

! ¿QUÉ INCLUYE MI HERRAMIENTA?

Diámetro de entrada y salida de 1"
Garantía e instructivo con listado de centros de servicio.

! ¿QUÉ INCLUYE MI HERRAMIENTA?

Diámetro de entrada y salida de 1"
Garantía e instructivo con listado de centros de servicio.

191321

MODELO: BMP-1/2p-3-AK

Garantía 1 Año

6



Caja a color

NOM

DISTRIB. MAYOREO LISTA
\$650.00 \$930.00 \$1,330.00

191322

MODELO: BMP-3/4p-2-AK

Garantía 1 Año

2



Caja a color

NOM

DISTRIB. MAYOREO LISTA
\$1,200.00 \$1,715.00 \$2,455.00

191323

MODELO: BMP-1p-3-AK

Garantía 1 Año

2



Caja a color

NOM

DISTRIB. MAYOREO LISTA
\$1,400.00 \$2,000.00 \$2,865.00

391301

MODELO: BMP-1/2-MX

Garantía 6 Meses

6



Caja a color

NOM

DISTRIB. MAYOREO LISTA
\$345.00 \$495.00 \$705.00

BOMBA CENTRÍFUGA 1/2 ó 3/4 ó 1 HP

Las bombas centrífugas generan mayor volumen de agua. Perfecta para llevar agua de la cisterna al tinaco



1/2 HP - 370 W

cód. 191341



3/4 HP - 550 W

cód. 191342



1 HP - 750 W

cód. 191343



Profesional
AKSI

Profesional
AKSI

Profesional
AKSI

✓ ¡HERRAMIENTA MEJORADA!
Nuevo modelo

191341

Tensión / frecuencia	127 V ~ / 60 Hz
Potencia	370 W / 1/2 HP
Corriente	4.8 A
Velocidad	3 450 rev / min (sin carga)
Altura manométrica total	19 m
Profundidad máxima de succión	9 m
Ø entrada / salida	1" NPT (25 mm)
Caudal máximo	80 L/min

Tiempo de operación

Ventajas de mi herramienta

- Impulsor de acero inoxidable.
- Incorpora sistema de protección.
- Base preparada para su fijación.
- Carcasa 100% metálica.

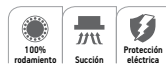

! ¿QUÉ INCLUYE MI HERRAMIENTA?

Diámetro de entrada y salida de 1"
Garantía e instructivo con listado de centros de servicio.

191341

MODELO: BMC-1/2-AK

Garantía 1 Año

2



Caja a color

NOM

DISTRIB.	MAYOREO	LISTA
\$1,350.00	\$1,930.00	\$2,380.00

✓ ¡HERRAMIENTA MEJORADA!
Nuevo modelo

191342

Tensión / frecuencia	127 V ~ / 60 Hz
Potencia	550 W / 3/4 HP
Corriente	8 A
Velocidad	3 450 rev / min (sin carga)
Altura manométrica total	28 m
Profundidad máxima de succión	9 m
Ø entrada / salida	1" NPT (25 mm)
Caudal máximo	100 L/min

50 minutos de trabajo x 20 minutos de descanso. Máximo diario: 6 horas.

- Impulsor de acero inoxidable.
- Incorpora sistema de protección.
- Base preparada para su fijación.
- Carcasa 100% metálica.



! ¿QUÉ INCLUYE MI HERRAMIENTA?

Diámetro de entrada y salida de 1"
Garantía e instructivo con listado de centros de servicio.

191342

MODELO: BMC-3/4-AK

Garantía 1 Año

2



Caja a color

NOM

DISTRIB.	MAYOREO	LISTA
\$1,750.00	\$2,500.00	\$3,085.00

✓ ¡HERRAMIENTA MEJORADA!
Nuevo modelo

191343

Tensión / frecuencia	127 V ~ / 60 Hz
Potencia	750 W / 1 HP
Corriente	10 A
Velocidad	3 450 rev / min (sin carga)
Altura manométrica total	30 m
Profundidad máxima de succión	9 m
Ø entrada / salida	1" NPT (25 mm)
Caudal máximo	103 L/min

50 minutos de trabajo x 20 minutos de descanso. Máximo diario: 6 horas.

- Impulsor de acero inoxidable.
- Incorpora sistema de protección.
- Base preparada para su fijación.
- Carcasa 100% metálica.



! ¿QUÉ INCLUYE MI HERRAMIENTA?

Diámetro de entrada y salida de 1"
Garantía e instructivo con listado de centros de servicio.

191343

MODELO: BMC-1p-AK

Garantía 1 Año

2



Caja a color

NOM

DISTRIB.	MAYOREO	LISTA
\$2,250.00	\$3,215.00	\$3,970.00

Impulsor de acero inoxidable en todas las bombas centrífugas.

BOMBA SUMERGIBLE de aluminio

1/2 ó 3/4 ó 1 HP

APLICACIONES:

- Ideal para sacar agua limpia de albercas, fuentes, estanques.
- Necesidades generales de achique para agua limpia.

A 2 m - 180 L/min

cód. 191311



A 2 m - 160 L/min

cód. 191312



A 2 m - 120 L/min

cód. 191313



Industrial
AKSI

Industrial
AKSI

Industrial
AKSI

AGUA LIMPIA

191311

Tensión / frecuencia	127 V ~ / 60 Hz
Potencia	750 W / 1 HP
Corriente	12 A
Flujo de agua máximo	30m: 25 L/min 2m: 180 L/min
Altura manométrica total	30 m
Profundidad máxima	5 m
Grado de protección	IPX8
Ø entrada / salida	1 1/4" a 1" NPT

Tiempo de operación

Ventajas de mi herramienta

50 minutos de trabajo x 20 minutos de descanso.

- Para agua limpia con partículas de hasta 2 mm de diámetro.
- Rejillas filtradoras de partículas.
- Motor con bobina de cobre.
- Incluye flotador para detección de bajo nivel de agua.
- Impulsor y cubierta de aluminio.



AGUA LIMPIA

191312

Tensión / frecuencia	127 V ~ / 60 Hz
Potencia	560 W / 3/4" HP
Corriente	8 A
Flujo de agua máximo	22m: 25 L/min 2m: 160 L/min
Altura manométrica total	22 m
Profundidad máxima	5 m
Grado de protección	IPX8
Ø entrada / salida	1 1/4" a 1" NPT

50 minutos de trabajo x 20 minutos de descanso.

- Para agua limpia con partículas de hasta 2 mm de diámetro.
- Rejillas filtradoras de partículas.
- Motor con bobina de cobre.
- Incluye flotador para detección de bajo nivel de agua.
- Impulsor y cubierta de aluminio.



AGUA LIMPIA

191313

Tensión / frecuencia	127 V ~ / 60 Hz
Potencia	370 W / 1/2 HP
Corriente	7.6 A
Flujo de agua máximo	18m: 25 L/min 2m: 120 L/min
Altura manométrica total	18 m
Profundidad máxima	5 m
Grado de protección	IPX8
Ø entrada / salida	1 1/4" a 1" NPT

50 minutos de trabajo x 20 minutos de descanso.

- Para agua limpia con partículas de hasta 2 mm de diámetro.
- Rejillas filtradoras de partículas.
- Motor con bobina de cobre.
- Incluye flotador para detección de bajo nivel de agua.
- Impulsor y cubierta de aluminio.



! ¿QUÉ INCLUYE MI HERRAMIENTA?

1 Juego de coples para descarga
Garantía e instructivo con listado de centros de servicio.

! ¿QUÉ INCLUYE MI HERRAMIENTA?

1 Juego de coples para descarga
Garantía e instructivo con listado de centros de servicio.

! ¿QUÉ INCLUYE MI HERRAMIENTA?

1 Juego de coples para descarga
Garantía e instructivo con listado de centros de servicio.

191311

MODELO: BSAL-750-AK

Garantía 1 Año

2



Caja a color

NOM

DISTRIB.	MAYOREO	LISTA
\$2,450.00	\$3,500.00	\$4,320.00

191312

MODELO: BSAL-560-AK

Garantía 1 Año

2



Caja a color

NOM

DISTRIB.	MAYOREO	LISTA
\$2,200.00	\$3,145.00	\$3,880.00

191313

MODELO: BSAL-370-AK

Garantía 1 Año

2



Caja a color

NOM

DISTRIB.	MAYOREO	LISTA
\$1,650.00	\$2,355.00	\$2,910.00

BOMBA SUMERGIBLE 1/2 ó 1 HP

Para agua sucia

- Ideal para sistemas de desagüe, fosas sépticas y aguas negras.
- Tareas de limpieza en zonas urbanas.
- Necesidades de achique en minas, astilleros y otras zonas industriales.

Para agua limpia

- Ideal para sacar agua limpia de albercas, fuentes, estanques.
- Necesidades generales de achique para agua limpia.

agua sucia - 250 L/min

cód. 191301



agua sucia - 160 L/min

cód. 191303



agua limpia - 208 L/min

cód. 191302



Profesional
AKSI

Profesional
AKSI

Profesional
AKSI

AGUA SUCIA

191301

Tensión / frecuencia	127 V ~ / 60 Hz
Potencia	750 W / 1 HP
Corriente	6 A
Flujo de agua máximo	250 L / min
Altura manométrica total	8 m
Profundidad máxima	5 m
Peso	4.7 kg

50 minutos de trabajo x 20 minutos de descanso. Máximo diario: 5 horas.

Tiempo de operación

Ventajas de mi herramienta

- Para aguas sucias con partículas de hasta 35 mm de diámetro.
- Excelente transporte de sólidos.
- Fiabilidad a largo plazo.



AGUA SUCIA

191303

Tensión / frecuencia	127 V ~ / 60 Hz
Potencia	400 W / 1/2 HP
Corriente	3.2 A
Flujo de agua máximo	160 L / min
Altura manométrica total	6 m
Profundidad máxima	5 m
Peso	4.6 kg

50 minutos de trabajo x 20 minutos de descanso. Máximo diario: 5 horas.

- Para aguas sucias con partículas de hasta 35 mm de diámetro.
- Excelente transporte de sólidos.
- Fiabilidad a largo plazo.



AGUA LIMPIA

191302

Tensión / frecuencia	127 V ~ / 60 Hz
Potencia	350 W / 1/2 HP
Corriente	3.2 A
Flujo de agua máximo	208 L / min
Altura manométrica total	6 m
Profundidad máxima	5 m
Peso	4.4 kg

50 minutos de trabajo x 20 minutos de descanso. Máximo diario: 5 horas.

- Para partículas de hasta 5 mm de diámetro.
- Excelente transporte de líquidos.
- Fiabilidad a largo plazo.
- Modelo compacto básico, para evacuar o transferir rápidamente aguas limpias o turbias.



! ¿QUÉ INCLUYE MI HERRAMIENTA?

1 Juego de coples para descarga
Garantía e instructivo con listado de centros de servicio.

191301

MODELO: BSMG-750-S-2-AK

Garantía 1 Año

4



Caja a color

NOM

DISTRIB. \$1,200.00 MAYOREO \$1,715.00 LISTA \$2,115.00

! ¿QUÉ INCLUYE MI HERRAMIENTA?

1 Juego de coples para descarga
Garantía e instructivo con listado de centros de servicio.

191303

MODELO: BSMG-400-S-2-AK

Garantía 1 Año

4



Caja a color

NOM

DISTRIB. \$950.00 MAYOREO \$1,355.00 LISTA \$1,675.00

! ¿QUÉ INCLUYE MI HERRAMIENTA?

1 Juego de coples para descarga
Garantía e instructivo con listado de centros de servicio.

191302

MODELO: BSMG-350-L-2-AK

Garantía 1 Año

4



Caja a color

NOM

DISTRIB. \$950.00 MAYOREO \$1,355.00 LISTA \$1,675.00

BOMBA SUMERGIBLE TIPO BALA PARA AGUA LIMPIA 1 1/2 ó 1 ó 3/4 HP

APLICACIONES:

- Ideal para bombear agua limpia de pozos y manantiales o en sistemas de riego.
- Uso industrial y agrícola.

Profundidad: 8 a 82 m
21 - 90 m 100 L/min 1 1/2 HP
cód. 191361



Profundidad: 8 a 62 m
16 - 70 m 100 L/min 1 HP
cód. 191362



Profundidad: 8 a 42 m
12 - 50 m 100 L/min 3/4 HP
cód. 191363



Industrial
AKSI

Industrial
AKSI

Industrial
AKSI

Tensión / frecuencia
Potencia
Corriente
Flujo de agua máximo
Altura manométrica total
Profundidad máxima
Grado de protección
Ø Salida

Tiempo de operación

Ventajas de mi herramienta

191361
127 V~ / 60 Hz
1120 W / 1 1/2 HP
14.6 A
90 m: 20 L / min 73m: 60 L / min 21m: 100 L / min
90 m
8 m - 82 m
IPX8
1 1/4" FNPT
50 minutos de trabajo x 20 minutos de descanso.

- Cuerpo de acero inoxidable.
- Unidad de conexión eléctrica.



191362
127 V~ / 60 Hz
750 W / 1 HP
10.3 A
70 m: 20 L / min 57m: 60 L / min 16m: 100 L / min
70 m
8 m - 62 m
IPX8
1 1/4" FNPT
50 minutos de trabajo x 20 minutos de descanso.

- Cuerpo de acero inoxidable.
- Unidad de conexión eléctrica.



191363
127 V~ / 60 Hz
560 W / 3/4 HP
8.7 A
50 m: 20 L / min 41m: 60 L / min 12m: 100 L / min
50 m
8 m - 42 m
IPX8
1 1/4" FNPT
50 minutos de trabajo x 20 minutos de descanso.

- Cuerpo de acero inoxidable.
- Unidad de conexión eléctrica.

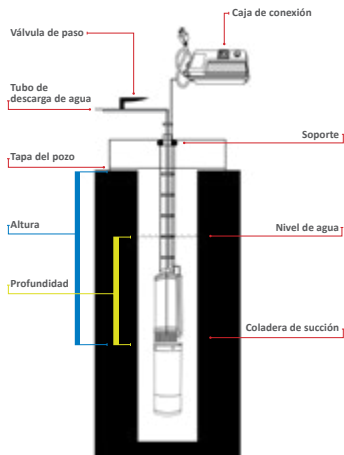

¿QUÉ INCLUYE MI HERRAMIENTA?

1 Cinta aislante
1 Cinta impermeable
1 Caja de control
Garantía e instructivo con listado de centros de servicio.

191361
MODELO: BSB-1120-AK
Garantía 1 Año
1
Caja a color
NOM
DISTRIB. \$3,400.00
MAYOREO \$4,855.00
LISTA \$5,995.00

¿QUÉ INCLUYE MI HERRAMIENTA?

1 Cinta aislante
1 Cinta impermeable
1 Caja de control
Garantía e instructivo con listado de centros de servicio.

191362
MODELO: BSB-750-AK
Garantía 1 Año
1
Caja a color
NOM
DISTRIB. \$3,000.00
MAYOREO \$4,285.00
LISTA \$5,290.00

¿QUÉ INCLUYE MI HERRAMIENTA?

1 Cinta aislante
1 Cinta impermeable
1 Caja de control
Garantía e instructivo con listado de centros de servicio.

191363
MODELO: BSB-560-AK
Garantía 1 Año
1
Caja a color
NOM
DISTRIB. \$2,450.00
MAYOREO \$3,500.00
LISTA \$4,320.00

MOTOBOMBA 6.5 ó 5.5 HP

·USO AGRÍCOLA:
No causa I.V.A.



6.5 HP - 1160 L/min - 3" de salida

cód. 197102



Vista trasera

5.5 HP - 505 L/min - 2" de salida

cód. 197101



Vista trasera

Industrial
AKSI

Industrial
AKSI



SISTEMA DE PROTECCIÓN
DE BAJO NIVEL DE ACEITE

197102

4 875 W / 6.5 HP
3 900 rev / min
1 160 L / min
93 dB
OHV de 6.5 HP
4 tiempos
3.6 L
Sin plomo
2.4 h
SAE 10 W-30 sintético
8 m
26 m

Se recomiendan 15 minutos de descanso por cada carga de combustible.



SISTEMA DE PROTECCIÓN
DE BAJO NIVEL DE ACEITE

197101

4 125 W / 5.5 HP
3 900 rev / min
505 L / min
93 dB
OHV de 5.5 HP
4 tiempos
3.6 L
Sin plomo
2.8 h
SAE 10 W-30 sintético
8 m
28 m

Se recomiendan 15 minutos de descanso por cada carga de combustible.

Potencia del motor
Velocidad del motor
Caudal máximo
Nivel de ruido
Motor
Tipo de motor
Capacidad de tanque
Tipo de gasolina
Rendimiento de gasolina
Tipo de aceite
Profundidad de succión
Elevación máxima

Tiempo de operación

Ventajas de mi herramienta

Motor no contaminante de 4 tiempos con diseño avanzado para una potencia óptima y bajas emisiones.
· Carburador de primera calidad para un encendido fácil y un rendimiento óptimo.
· Nuevo sistema de arranque mejorado.
· Sólido cigüeñal que soporta altas revoluciones y un intenso uso profesional asegurando una larga vida útil.
· Cebador para arranques rápidos y bajo nivel de vibración.
· 69 600 litros/hora. Propulsada con motor de 6,5 HP.
· Chasis tubular de acero para uso rudo.
· Sistema de protección de bajo nivel de aceite.



¿QUÉ INCLUYE MI HERRAMIENTA?

1 Llave para bujía
2 tubos conectores para manguera
2 anillos sujetadores de tubo conector
2 sellos para agua
3 abrazaderas
4 patas de goma
4 tuercas M8
1 filtro
Garantía e instructivo con listado de centros de servicio.

197102

MODELO: MTBMB-6.5-3-AK

Garantía 1 Año

1



Caja a color

DISTRIB. \$4,000.00 MAYOREO \$5,715.00 LISTA \$8,185.00



¿QUÉ INCLUYE MI HERRAMIENTA?

1 Llave para bujía
2 tubos conectores para manguera
2 anillos sujetadores de tubo conector
2 sellos para agua
3 abrazaderas
4 patas de goma
4 tuercas M8
1 filtro
Garantía e instructivo con listado de centros de servicio.

197101

MODELO: MTBMB-5.5-2-AK

Garantía 1 Año

1



Caja a color

DISTRIB. \$3,615.00 MAYOREO \$5,165.00 LISTA \$7,395.00

ACCESORIOS COMPATIBLES PARA TU HERRAMIENTA

Flotador eléctrico 3m

Tensión / frecuencia 125 V ~ / 60 Hz
Corriente 10 A
Longitud de cable 3 m
Conexión de acuerdo de uso 2 conexiones (Vaciado o llenado de cisterna / tinaco)



1
Año de garantía

¿QUÉ INCLUYE MI HERRAMIENTA?

1 Flotador, contrapeso y garantía e instructivo con listado de centros de servicio.

CÓDIGO	MODELO	1	24
191391	FLTDR-3p-AK	4	24
DISTRIB.	MAYOREO	LISTA	
\$150.00	\$215.00	\$265.00	

GENERADOR ELÉCTRICO

A GASOLINA
15 ó 13 ó 6.5 HP

APLICACIONES: USO RUDO

· Ideal para el trabajo en lugares con ausencia de luz eléctrica, en construcciones, campamentos, estadios o en el campo, etc.



15 HP - 8 000 W

cód. 197513



USO RUDO

13 HP - 6 500 W

cód. 197512



USO RUDO

6.5 HP - 3 500 W

cód. 197511



USO RUDO

Industrial
AKSI

Industrial
AKSI

Industrial
AKSI



SISTEMA DE PROTECCIÓN DE BAJO NIVEL DE ACEITE

197513

Tensión	120 V ~ / 240 V ~ / 12 V D.C
Potencia máxima	8 000 W
Potencia nominal	7 200 W
Corriente máxima	30 A
Frecuencia de salida	60 Hz
No. de fases	1
Potencia de motor	15 HP / 8 kW
Tipo de motor	OHV a 4 tiempos
Velocidad sin carga	3 600 rev/min
Combustible	Gasolina sin plomo
Capacidad de tanque	22 L
Tipo de aceite para motor	SAE 10 W-30 sintético
Nivel de aceite	1 500 ml
Duración del tanque	9 horas
Arranque	Cuerda retráctil
Peso	96 kg
Tamaño de rueda	4"

Se recomiendan 15 minutos de descanso por cada carga de combustible.



SISTEMA DE PROTECCIÓN DE BAJO NIVEL DE ACEITE

197512

Tensión	120 V ~ / 240 V ~ / 12 V D.C
Potencia máxima	6 500 W
Potencia nominal	5 500 W
Corriente máxima	25 A
Frecuencia de salida	60 Hz
No. de fases	1
Potencia de motor	13 HP / 6.5 kW
Tipo de motor	OHV a 4 tiempos
Velocidad sin carga	3 800 rev/min
Combustible	Gasolina sin plomo
Capacidad de tanque	22 L
Tipo de aceite para motor	SAE 10 W-30 sintético
Nivel de aceite	1 500 ml
Duración del tanque	9 horas
Arranque	Cuerda retráctil
Peso	86 kg
Tamaño de rueda	4"

Se recomiendan 15 minutos de descanso por cada carga de combustible.



SISTEMA DE PROTECCIÓN DE BAJO NIVEL DE ACEITE

197511

Tensión	120 V ~ / 240 V ~ / 12 V D.C
Potencia máxima	3 500 W
Potencia nominal	3 000 W
Corriente máxima	15 A
Frecuencia de salida	60 Hz
No. de fases	1
Potencia de motor	6.5 HP / 3.5 kW
Tipo de motor	OHV a 4 tiempos
Velocidad sin carga	3 800 rev/min
Combustible	Gasolina sin plomo
Capacidad de tanque	12 L
Tipo de aceite para motor	SAE 10 W-30 sintético
Nivel de aceite	600 ml
Duración del tanque	8 horas
Arranque	Cuerda retráctil
Peso	53 kg
Tamaño de rueda	6"

Se recomiendan 15 minutos de descanso por cada carga de combustible.

Tensión	120 V ~ / 240 V ~ / 12 V D.C
Potencia máxima	8 000 W
Potencia nominal	7 200 W
Corriente máxima	30 A
Frecuencia de salida	60 Hz
No. de fases	1
Potencia de motor	15 HP / 8 kW
Tipo de motor	OHV a 4 tiempos
Velocidad sin carga	3 600 rev/min
Combustible	Gasolina sin plomo
Capacidad de tanque	22 L
Tipo de aceite para motor	SAE 10 W-30 sintético
Nivel de aceite	1 500 ml
Duración del tanque	9 horas
Arranque	Cuerda retráctil
Peso	96 kg
Tamaño de rueda	4"

Tiempo de operación

Ventajas de mi herramienta



Diseño con ruedas y manubrio abatible para fácil transportación

- Motor a gasolina
- Estructura tubular.
- Arranque fácil: Cuenta con nuevo sistema de arranque eléctrico.
- Medidor digital.
- Acumulador para encendido automático con un simple giro de la llave.
- Manerales para fácil transportación.
- Cuatro salidas de corriente en 120 V
- Una salida de corriente en 240 V
- Una salida de corriente en 12 VCD
- Interruptor de ignición.
- Sistema de bajo nivel de aceite.



! ¿QUÉ INCLUYE MI HERRAMIENTA?

- 1 Clavija de seguridad (240 V).
- 4 Clavijas aterrizadas (120 V).
- 4 Ruedas con tapas.
- 4 Pernos para ruedas.
- 8 Chavetas.
- 1 Perilla para mango abatible.
- 4 Rondanas planas.
- 1 Llave y perno para cambio de bujía.
- 1 Bolsa para accesorios.
- 1 Juego de llaves para encendido.
- 2 Perillas para borne (12 VCD).
- Garantía e instructivo con listado de centros de servicio

197513

MODELO: GENER-8000i-AK

Garantía 1 Año

1



Caja a color

DISTRIB.	MAYOREO	LISTA
\$20,000.00	\$28,570.00	\$35,280.00

- Motor a gasolina
- Estructura tubular.
- Arranque fácil: Cuenta con nuevo sistema de arranque eléctrico.
- Medidor digital.
- Acumulador para encendido automático con un simple giro de la llave.
- Manerales para fácil transportación.
- Cuatro salidas de corriente en 120 V
- Una salida de corriente en 240 V
- Una salida de corriente en 12 VCD
- Interruptor de ignición.
- Sistema de bajo nivel de aceite.



! ¿QUÉ INCLUYE MI HERRAMIENTA?

- 1 Clavija de seguridad (240 V).
- 4 Clavijas aterrizadas (120 V).
- 4 Ruedas con tapas.
- 4 Pernos para ruedas.
- 8 Chavetas.
- 1 Perilla de mango abatible.
- 4 Rondanas planas.
- 1 Llave y perno para cambio de bujía.
- 1 Bolsa para accesorios.
- Garantía e instructivo con listado de centros de servicio.

197512

MODELO: GENER-6500i-AK

Garantía 1 Año

1



Caja a color

DISTRIB.	MAYOREO	LISTA
\$17,000.00	\$24,285.00	\$29,985.00

- Motor a gasolina
- Estructura tubular.
- Arranque fácil: Cuenta con nuevo sistema de arranque eléctrico.
- Medidor digital.
- Acumulador para encendido automático con un simple giro de la llave.
- Manerales para fácil transportación.
- Cuatro salidas de corriente en 120 V
- Una salida de corriente en 240 V
- Una salida de corriente en 12 VCD
- Interruptor de ignición.
- Sistema de bajo nivel de aceite.



! ¿QUÉ INCLUYE MI HERRAMIENTA?

- 1 Clavija de seguridad (240 V).
- 2 Clavijas aterrizadas (120 V).
- 4 Ruedas con tapas.
- 4 Pernos para ruedas.
- 8 Chavetas.
- 1 Perilla de mango abatible.
- 4 Rondanas planas.
- 1 Llave y perno para cambio de bujía.
- 1 Bolsa para accesorios.
- Garantía e instructivo con listado de centros de servicio.

197511

MODELO: GENER-3500i-AK

Garantía 1 Año

1



Caja a color

DISTRIB.	MAYOREO	LISTA
\$10,000.00	\$14,285.00	\$17,640.00

GENERADOR ELÉCTRICO

A GASOLINA
10.5 ó 5.5 ó 2 HP

APLICACIONES:

- Ideal para el trabajo en lugares o ausencia de luz eléctrica, construcción, campamento, estadio, campo, etc.



10.5 HP - 8 000 W

cód. 197506



5.5 HP - 2 500 W

cód. 197503



Vista frontal

2 HP - 850 W

cód. 397401



Con vaso dosificador

Profesional
AKSI

Semi PRO
AKSI

Doméstica
IT MAXTOOL

SISTEMA DE PROTECCIÓN DE BAJO NIVEL DE ACEITE

197506

Tensión	120 V ~ / 240 V ~ / 12 V D.C
Potencia máxima	8 000 W
Potencia nominal	7 200 W
Corriente máxima	30 A
Frecuencia de salida	60 Hz
No. de fases	1
Potencia de motor	10.5 HP / 8 kW
Tipo de motor	OHV a 4 tiempos
Velocidad sin carga	3 800 rev/min
Combustible	Gasolina sin plomo
Capacidad de tanque	25 L
Tipo de aceite para motor	SAE 10 W-30 sintético
Nivel de aceite	1 500 ml
Duración del tanque	8 horas
Arranque	Cuerda retráctil
Peso	89 kg
Tamaño de rueda	8"

Tiempo de operación

Ventajas de mi herramienta

- Sistema de arranque eléctrico.
- Estructura tubular.
- Medidor análogo: voltímetro para ambas salidas de voltaje.
- Acumulador para encendido automático con un simple giro de la llave.
- Ruedas de 8"
- Cuatro salidas de corriente en 120 V
- Una salida de corriente en 240 V
- Una salida de corriente en 12 VCD
- Sistema de bajo nivel de aceite.



¿QUÉ INCLUYE MI HERRAMIENTA?

1 Clavija de seguridad (240V), 4 clavijas aterrizadas (120 V), 2 ruedas de 8" con tapas, 2 ejes para rueda, 2 chavetas para eje de rueda, 1 llave y perno para cambio de bujía, 1 soporte de base con 2 gomas antiderrapantes, 1 asa, 2 llaves para encendido, 1 bolsa para accesorios y garantía e instructivo con listado de centros de servicio.

197506

MODELO: GENER-8000Ep-AK

Garantía 1 Año

1



Caja a color

DISTRIB.	MAYOREO	LISTA
\$17,000.00	\$24,285.00	\$29,985.00

SISTEMA DE PROTECCIÓN DE BAJO NIVEL DE ACEITE

197503

Tensión	120 V ~ / 240 V ~ / 12 V D.C
Potencia máxima	2 500 W
Potencia nominal	2 200 W
Corriente máxima	9.2 A
Frecuencia de salida	60 Hz
No. de fases	1
Potencia de motor	5.5 HP / 2.5 kW
Tipo de motor	OHV a 4 tiempos
Velocidad sin carga	3 600 rev/min
Combustible	Gasolina sin plomo
Capacidad de tanque	15 L
Tipo de aceite para motor	SAE 10 W-30 sintético
Nivel de aceite	600 ml
Duración del tanque	8 horas
Arranque	Cuerda retráctil
Peso	42 kg
Tamaño de rueda	-----

Se recomiendan 15 minutos de descanso por cada carga de combustible.

- Arranque fácil, sistema de arranque eléctrico.
- Estructura tubular.
- Medidor análogo: voltímetro para ambas salidas de voltaje.
- Acumulador para encendido automático con un simple giro de la llave.
- Ruedas de 8"
- Cuatro salidas de corriente en 120 V
- Una salida de corriente en 240 V
- Una salida de corriente en 12 VCD
- Sistema de bajo nivel de aceite.



¿QUÉ INCLUYE MI HERRAMIENTA?

1 Clavija de seguridad (240 V), 2 clavijas aterrizadas (120 V), 1 llave y perno para cambio de bujía, 1 bolsa para tornillería, accesorios y garantía e instructivo con listado de centros de servicio.

197503

MODELO: GENER-2500s-AK

Garantía 1 Año

1



Caja a color

DISTRIB.	MAYOREO	LISTA
\$7,500.00	\$10,715.00	\$13,230.00

SISTEMA DE PROTECCIÓN DE BAJO NIVEL DE ACEITE

397401

Tensión	120 V ~ / 12 V D.C
Potencia máxima	850 W
Potencia nominal	650 W
Corriente máxima	5.4 A
Frecuencia de salida	60 Hz
No. de fases	1
Potencia de motor	2 HP
Tipo de motor	OHV a 2 tiempos
Velocidad sin carga	3 600 rev/min
Combustible	Gasolina sin plomo
Capacidad de tanque	4 L
Tipo de aceite para motor	SAE 10 W-30 sintético
Nivel de aceite	OHV a 2 tiempos
Duración del tanque	6 horas
Arranque	Cuerda retráctil
Peso	14.5 kg
Tamaño de rueda	-----

Se recomiendan 15 minutos de descanso por cada carga de combustible.

- Arranque fácil, sistema de arranque eléctrico.
- Estructura tubular.
- Medidor análogo: voltímetro para ambas salidas de voltaje.
- Acumulador para encendido automático con un simple giro de la llave.
- Ruedas de 8"
- Cuatro salidas de corriente en 120 V
- Una salida de corriente en 240 V
- Una salida de corriente en 12 VCD
- Sistema de bajo nivel de aceite.



¿QUÉ INCLUYE MI HERRAMIENTA?

1 Mango, 1 clavija, cables para conectar aparatos de 12 VCD, 1 bolsa de herramienta: 1 desarmador plano/cruz, 1 llave para bujía y 2 tornillos, 1 vaso dosificador y garantía e instructivo con listado de centros de servicio.

397401

MODELO: GENER-850-MX

Garantía 6 Meses

1



Caja a color

DISTRIB.	MAYOREO	LISTA
\$3,300.00	\$4,715.00	\$5,820.00

ACCESORIOS COMPATIBLES PARA TU HERRAMIENTA

PROX.

Manómetro de presión 200 PSI

▶ Cuerda 1/4"



CÓDIGO	10	100
DISTRIB.	MAYOREO	LISTA
\$50.00	\$71.00	\$88.00

COMPRESOR DE BANDA 60 ó 100 ó 120 L

APLICACIONES:

- Ideal para trabajo en carpintería, talleres, etc.



4 HP - 60 L - 2 985 W

cód. 197631



3 HP - 100 L - 2 200 W

cód. 197632



4 HP - 120 L - 2 985 W

cód. 197633



Industrial
AKSI

Industrial
AKSI

Industrial
AKSI

Tensión / frecuencia	120 V / 220 V ~ / 60 Hz
Potencia	2 200 W / 2 985 W / 4 HP
Corriente	16 A / 11 A
Velocidad	3 450 rev/min
Presión máxima	800 kPa - 116 PSI (8 Bar)
Flujo de aire	250 L / min
Salida de aire	1 fija - 1 regulada
Capacidad	60 L
Nivel de aceite (motor)	450 ml
Tipo de aceite	SAE 10 W-30 sintético

Tiempo de operación

197631

Tensión / frecuencia	120 V / 220 V ~ / 60 Hz
Potencia	2 200 W / 2 985 W / 4 HP
Corriente	16 A / 11 A
Velocidad	3 450 rev/min
Presión máxima	800 kPa - 116 PSI (8 Bar)
Flujo de aire	250 L / min
Salida de aire	1 fija - 1 regulada
Capacidad	60 L
Nivel de aceite (motor)	450 ml
Tipo de aceite	SAE 10 W-30 sintético

50 minutos de trabajo x 20 minutos de descanso.

197632

Tensión / frecuencia	120 V ~ / 60 Hz
Potencia	2 200 W / 3 HP
Corriente	13 A
Velocidad	3 450 rev/min
Presión máxima	800 kPa - 116 PSI (8 Bar)
Flujo de aire	335 L / min
Salida de aire	1 fija - 1 regulada
Capacidad	100 L
Nivel de aceite (motor)	1 000 ml
Tipo de aceite	SAE 10 W-30 sintético

50 minutos de trabajo x 20 minutos de descanso.

197633

Tensión / frecuencia	220 V ~ / 60 Hz
Potencia	2 985 W / 4 HP
Corriente	10 A
Velocidad	3 450 rev/min
Presión máxima	800 kPa - 116 PSI (8 Bar)
Flujo de aire	246 L / min
Salida de aire	1 fija - 1 regulada
Capacidad	120 L
Nivel de aceite (motor)	450 ml
Tipo de aceite	SAE 10 W-30 sintético

50 minutos de trabajo x 20 minutos de descanso.

Ventajas de mi herramienta



Devanado de cobre en todos los compresores

- Sistema para drenar condensación de aire a presión.
- Interruptor de sobrecorriente de reestablecimiento manual.
- Devanado de motor elaborado en cobre.
- Filtro de aire con cartucho de fácil reemplazo.
- Manija de transportación soldada al tanque.
- Mirilla para visualizar nivel de aceite.
- Regulador de presión y manómetro.
- Manija de transportación desmontable.



- Sistema para drenar condensación de aire a presión.
- Interruptor de sobrecorriente de reestablecimiento manual.
- Devanado de motor elaborado en cobre.
- Filtro de aire con cartucho de fácil reemplazo.
- Manija de transportación soldada al tanque.
- Mirilla para visualizar nivel de aceite.
- Regulador de presión y manómetro.
- Manija de transportación desmontable.



- Sistema para drenar condensación de aire a presión.
- Interruptor de sobrecorriente de reestablecimiento manual.
- Devanado de motor elaborado en cobre.
- Filtro de aire con cartucho de fácil reemplazo.
- Manija de transportación soldada al tanque.
- Mirilla para visualizar nivel de aceite.
- Regulador de presión y manómetro.
- Manija de transportación desmontable.



! ¿QUÉ INCLUYE MI HERRAMIENTA?

2 Filtros
1 Bote con aceite
1 Tapón de depósito de aceite
1 Bolsa con tornillería
1 Manija de transportación
1 Interruptor de sobrecorriente
1 Regulador de presión
1 Manómetro
4 Llantas
Garantía e instructivo con listado de centros de servicio.

! ¿QUÉ INCLUYE MI HERRAMIENTA?

2 Filtros
1 Bote con aceite
1 Tapón de depósito de aceite
1 Bolsa con tornillería
1 Manija de transportación
1 Interruptor de sobrecorriente
1 Regulador de presión
1 Manómetro
4 Llantas
Garantía e instructivo con listado de centros de servicio.

! ¿QUÉ INCLUYE MI HERRAMIENTA?

2 Filtros
1 Bote con aceite
1 Tapón de depósito de aceite
1 Bolsa con tornillería
1 Manija de transportación
1 Interruptor de sobrecorriente
1 Regulador de presión
1 Manómetro
4 Llantas
Garantía e instructivo con listado de centros de servicio.

197631

MODELO: COMP-60i-AK
Garantía 1 Año



Caja a color

NOM

DISTRIB.	MAYOREO	LISTA
\$8,500.00	\$12,145.00	\$14,995.00

197632

MODELO: COMP-100i-AK
Garantía 1 Año



Caja a color

NOM

DISTRIB.	MAYOREO	LISTA
\$9,500.00	\$13,570.00	\$16,755.00

197633

MODELO: COMP-120i-AK
Garantía 1 Año



Caja a color

NOM

DISTRIB.	MAYOREO	LISTA
\$10,000.00	\$14,285.00	\$17,640.00

COMPRESOR VERTICAL y DE BANDA 50 ó 200 ó 240 L

APLICACIONES:

- Ideal para trabajo en carpintería, talleres, etc.



3.5 HP - 50 L - 2 610 W

cód. 197641



3 HP - 200 L - 2 200 W

cód. 197651 - De banda



4 HP - 240 L - 2 985 W

cód. 197652 - De banda



Industrial
AKSI

Industrial
AKSI

Industrial
AKSI

197641

Tensión / frecuencia	120 V ~ / 60 Hz
Potencia	2 610 W / 3.5 HP
Corriente	12 A
Velocidad	3 450 rev/min
Presión máxima	800 kPa - 116 PSI (8 Bar)
Flujo de aire	246 L / min
Salida de aire	1 regulada
Capacidad	50 L
Consumo de energía	1.5 kWh
Nivel de aceite (motor)	250 ml
Tipo de aceite	SAE 10 W-30 sintético

Tensión / frecuencia	120 V ~ / 60 Hz
Potencia	2 610 W / 3.5 HP
Corriente	12 A
Velocidad	3 450 rev/min
Presión máxima	800 kPa - 116 PSI (8 Bar)
Flujo de aire	246 L / min
Salida de aire	1 regulada
Capacidad	50 L
Consumo de energía	1.5 kWh
Nivel de aceite (motor)	250 ml
Tipo de aceite	SAE 10 W-30 sintético

197651

Tensión / frecuencia	120 V ~ / 60 Hz
Potencia	2 200 W / 3 HP
Corriente	14 A
Velocidad	3 450 rev/min
Presión máxima	800 kPa - 116 PSI (8 Bar)
Flujo de aire	335 L / min
Salida de aire	1 fija - 1 regulada
Capacidad	200 L
Consumo de energía	1.75 kWh
Nivel de aceite (motor)	1 000 ml
Tipo de aceite	SAE 10 W-30 sintético

197652

Tensión / frecuencia	220 V ~ / 60 Hz
Potencia	2 985 W / 4 HP
Corriente	9 A
Velocidad	3 450 rev/min
Presión máxima	800 kPa - 116 PSI (8 Bar)
Flujo de aire	246 L / min
Salida de aire	1 fija - 1 regulada
Capacidad	240 L
Consumo de energía	1.75 kWh
Nivel de aceite (motor)	1 000 ml
Tipo de aceite	SAE 10 W-30 sintético

Tiempo de operación

30 minutos de trabajo x 15 minutos de descanso.

50 minutos de trabajo x 20 minutos de descanso.

50 minutos de trabajo x 20 minutos de descanso.

Ventajas de mi herramienta



Devanado de Cobre
en todos los compresores

- Devanado de motor elaborado en cobre.
- Sistema para drenar condensación de aire a presión.
- Filtro de aire con cartucho de fácil reemplazo.
- Manija de transportación.
- Interruptor de sobrecorriente de restablecimiento manual.
- Mirilla para visualizar nivel de aceite.
- Regulador de presión y manómetro.

- Devanado de motor elaborado en cobre.
- Sistema para drenar condensación de aire a presión.
- Filtro de aire con cartucho de fácil reemplazo.
- Manija de transportación.
- Interruptor de sobrecorriente de restablecimiento manual.
- Mirilla para visualizar nivel de aceite.
- Regulador de presión y manómetro.

- Devanado de motor elaborado en cobre.
- Sistema para drenar condensación de aire a presión.
- Filtro de aire con cartucho de fácil reemplazo.
- Manija de transportación.
- Interruptor de sobrecorriente de restablecimiento manual.
- Mirilla para visualizar nivel de aceite.
- Regulador de presión y manómetro.



Protección eléctrica



Protección eléctrica



Protección eléctrica

ACCESORIOS COMPATIBLES PARA TU HERRAMIENTA

PROX.

Manómetro de presión 200 PSI

- ▶ Cuerda 1/4"



CÓDIGO		
113009	10	100
DISTRIB.	MAYOREO	LISTA
\$50.00	\$71.00	\$88.00

¿QUÉ INCLUYE MI HERRAMIENTA?

- 1 Filtro
- 1 Bote con aceite
- 1 Tapón depósito de aceite
- 1 Manija de transportación
- 1 Interruptor de sobrecorriente
- 1 Regulador de presión
- 1 Manómetro
- 2 Llantas
- Bolsa con tornillería
- Garantía e instructivo con listado de centros de servicio.

197641

MODELO: COMP-50p-Vert-AK

Garantía 1 Año

1



Caja a color

NOM

DISTRIB.	MAYOREO	LISTA
\$3,800.00	\$5,430.00	\$6,705.00

¿QUÉ INCLUYE MI HERRAMIENTA?

- 1 Filtro
- 1 Bote con aceite
- 1 Tapón depósito de aceite
- 1 Manija de transportación
- 1 Interruptor de sobrecorriente
- 1 Regulador de presión
- 1 Manómetro
- 2 Llantas
- Bolsa con tornillería
- Garantía e instructivo con listado de centros de servicio.

197651

MODELO: COMP-200i-AK

Garantía 1 Año

1



Caja a color

NOM

DISTRIB.	MAYOREO	LISTA
\$12,800.00	\$18,285.00	\$22,580.00

¿QUÉ INCLUYE MI HERRAMIENTA?

- 1 Filtro
- 1 Bote con aceite
- 1 Tapón depósito de aceite
- 1 Manija de transportación
- 1 Interruptor de sobrecorriente
- 1 Regulador de presión
- 1 Manómetro
- 2 Llantas
- Bolsa con tornillería
- Garantía e instructivo con listado de centros de servicio.

197652

MODELO: COMP-240i-AK

Garantía 1 Año

1



Caja a color

NOM

DISTRIB.	MAYOREO	LISTA
\$13,200.00	\$18,855.00	\$23,285.00

COMPRESOR 25 ó 50 L

APLICACIONES:

- Ideal para trabajo en carpintería, talleres, etc.



2 HP - 25 L - 1500 W

cód. 197611



2 HP - 50 L - 1500 W

cód. 197612



Profesional
AKSI

Profesional
AKSI

Tensión / frecuencia
Potencia
Corriente
Velocidad
Presión máxima
Flujo de aire
Salida de aire
Capacidad
Consumo de energía
Manija de transportación
Nivel de aceite (motor)
Tipo de aceite

Tiempo de operación

Ventajas de mi herramienta



Devanado de Cobre en todos los compresores



Ambos compresores cuentan con 2 salidas de aire con conectores rápidos: presión máxima y presión regulada

197611

120 V ~ 60 Hz
1 500 W / 2 HP
12.5 A
3 450 rev / min (sin carga)
800 kPa - 115 PSI - 8 Bar
246 L / min
1 fija - 1 regulada
25 L
1.5 kWh
Metálica
200 ml
SAE 10 W-30 sintético

30 minutos de trabajo x 15 minutos de descanso.

- Devanado de motor elaborado en cobre que alarga el tiempo de vida.
- Conectores de latón.
- Filtro con cartucho de fácil reemplazo.
- Manija de transportación soldada al tanque.
- Sistema para drenar condensación de aire a presión.
- Interruptor termomagnético de protección.
- Ruedas incluidas para su fácil transportación.
- Tapón de depósito de aceite.
- Mirilla de nivel de aceite.
- Regulador de presión y manómetro.
- Arranque automático y manual.



¿QUÉ INCLUYE MI HERRAMIENTA?

- 1 Bote con aceite
- 1 Filtro de aire
- 2 Ruedas
- 1 Tapón de depósito de aceite
- Juego de tornillería
- 1 Reductor
- 1 Soporte de goma
- Garantía e instructivo con listado de centros de servicio.

197611

MODELO: COMP-25p-2-AK
Garantía 1 Año

1



Caja a color

NOM

DISTRIB.	MAYOREO	LISTA
\$3,200.00	\$4,570.00	\$5,645.00

197612

120 V ~ 60 Hz
1 500 W / 2 HP
12.5 A
3 450 rev / min (sin carga)
800 kPa - 115 PSI - 8 Bar
246 L / min
1 fija - 1 regulada
50 L
1.5 kWh
Metálica
200 ml
SAE 10 W-30 sintético

30 minutos de trabajo x 15 minutos de descanso.

- Devanado de motor elaborado en cobre que alarga el tiempo de vida.
- Conectores de latón.
- Filtro con cartucho de fácil reemplazo.
- Manija de transportación soldada al tanque.
- Sistema para drenar condensación de aire a presión.
- Interruptor termomagnético de protección.
- Ruedas incluidas para su fácil transportación.
- Tapón de depósito de aceite.
- Mirilla de nivel de aceite.
- Regulador de presión y manómetro.
- Arranque automático y manual.



¿QUÉ INCLUYE MI HERRAMIENTA?

- 1 Bote con aceite
- 1 Filtro de aire
- 2 Ruedas
- 1 Tapón de depósito de aceite
- Juego de tornillería
- 1 Reductor
- 1 Soporte de goma
- Garantía e instructivo con listado de centros de servicio.

197612

MODELO: COMP-50p-2-AK
Garantía 1 Año

1



Caja a color

NOM

DISTRIB.	MAYOREO	LISTA
\$3,500.00	\$5,000.00	\$6,175.00

COMPRESOR 25 ó 50 L

APLICACIONES:

- Ideal para trabajo en carpintería, talleres, etc.



2 HP - 25 L - 1 500 W

cód. 197601



Semi PRO
AKSI

2 HP - 50 L - 1 500 W

cód. 197602



Semi PRO
AKSI

Tensión / frecuencia
Potencia
Corriente
Velocidad
Presión máxima
Flujo de aire
Salida de aire
Capacidad
Consumo de energía
Manija de transportación
Nivel de aceite (motor)
Tipo de aceite

Tiempo de operación

Ventajas de mi herramienta



Devanado de Aluminio en todos los compresores



Ambos compresores cuentan con 2 salidas de aire con conectores rápidos: presión máxima y presión regulada

197601

120 V ~ 60 Hz
1 500 W / 2 HP
12.5 A
3 450 rev / min (sin carga)
800 kPa - 115 PSI - 8 Bar
246 L / min
1 fija - 1 regulada
25 L
1.5 kWh
Metálica
200 ml
SAE 10 W-30 sintético

20 minutos de trabajo x 10 minutos de descanso.

- Devanado de motor elaborado en aluminio.
- Filtro con cartucho de fácil reemplazo.
- Manija de transportación soldada al tanque.
- Sistema para drenar condensación de aire a presión.
- Interruptor termomagnético de protección.
- Ruedas incluidas para su fácil transportación.
- Tapón de depósito de aceite.
- Mirilla de nivel de aceite.
- Regulador de presión y manómetro.
- Arranque automático y manual.



¿QUÉ INCLUYE MI HERRAMIENTA?

- 1 Bote con aceite
- 1 Filtro de aire
- 2 Ruedas
- 1 Tapón de depósito de aceite
- Juego de tornillería
- 1 Reductor
- 1 Soporte de goma
- Garantía e instructivo con listado de centros de servicio.

197601

MODELO: COMP-25s-2-AK

Garantía 1 Año

1



Caja a color

NOM

DISTRIB.	MAYOREO	LISTA
\$2,400.00	\$3,430.00	\$4,235.00



¿QUÉ INCLUYE MI HERRAMIENTA?

- 1 Bote con aceite
- 1 Filtro de aire
- 2 Ruedas
- 1 Tapón de depósito de aceite
- Juego de tornillería
- 1 Reductor
- 1 Soporte de goma
- Garantía e instructivo con listado de centros de servicio.

197602

MODELO: COMP-50s-2-AK

Garantía 1 Año

1



Caja a color

NOM

DISTRIB.	MAYOREO	LISTA
\$2,900.00	\$4,145.00	\$5,115.00

ACCESORIOS COMPATIBLES PARA TU HERRAMIENTA

PROX.

Manómetro de presión 200 PSI

► Cuerda 1/4"



CÓDIGO		
113009	10	100
DISTRIB.	MAYOREO	LISTA
\$50.00	\$71.00	\$88.00

KIT NEUMÁTICO 25 L / 1500 W

APLICACIONES:

- Recomendado para uso en carpinterías, talleres etc.



Devanado de Cobre



Devanado de Aluminio

Profesional
AKSI

Semi-PRO
AKSI

Compresor

Tensión / frecuencia
Potencia
Corriente
Velocidad
Presión máxima
Flujo de aire
Salida de aire
Capacidad
Consumo de energía
Manija de transportación
Nivel de aceite (motor)
Tipo de aceite

Pistola de aire

Presión de trabajo
Aguja
Boquilla
Capacidad del vaso

Manguera de aire

Conector rápido macho

Tiempo de operación

Ventajas de mi herramienta



Ambos compresores cuentan con 2 salidas de aire con conectores rápidos: presión máxima y presión regulada

197691

120 V ~ 60 Hz
1 500 W / 2 HP
12.5 A
3 450 rev / min (sin carga)
800 kPa - 115 PSI - 8 Bar
246 L / min
1 fija - 1 regulada
25 L
1.5 kWh
Metálica
200 ml
SAE 10 W-30 sintético

43 a 70 PSI
Con tope de latón
1.8 mm
1 litro

Baja presión 1/4" - reforzada

Cuerda 1/4" NPT - acero cromado

30 minutos de trabajo x 15 minutos de descanso.

- Manija de transportación soldada al tanque.
- Sistema para drenar condensación de aire a presión.
- Mirilla para visualizar nivel de aceite.
- Regulador de presión y manómetro.
- Filtro de aire con cartucho de fácil reemplazo.



¿QUÉ INCLUYE MI HERRAMIENTA?

197611 Compresor 25 L / 1500 W
117637 Pistola de alta presión
102911 Manguera de aire 5 m
306404 Conector rápido macho
Garantía e instructivo con listado de centros de servicio.

197691

Garantía 1 Año

1



Caja a color

NOM

DISTRIB.	MAYOREO	LISTA
\$3,600.00	\$5,145.00	\$6,350.00

197692

120 V ~ 60 Hz
1 500 W / 2 HP
12.5 A
3 450 rev / min (sin carga)
800 kPa - 115 PSI - 8 Bar
246 L / min
1 fija - 1 regulada
25 L
1.5 kWh
Metálica
200 ml
SAE 10 W-30 sintético

25 a 45 PSI
Con tope de latón
1.5 mm
1 litro

Baja presión 1/4" - reforzada

Cuerda 1/4" NPT - acero cromado

20 minutos de trabajo x 10 minutos de descanso.

- Manija de transportación soldada al tanque.
- Sistema para drenar condensación de aire a presión.
- Mirilla para visualizar nivel de aceite.
- Regulador de presión y manómetro.
- Filtro de aire con cartucho de fácil reemplazo.



¿QUÉ INCLUYE MI HERRAMIENTA?

197601 Compresor 25 L / 1500 W
117601 Pistola de baja presión
102911 Manguera de aire 5 m
306404 Conector rápido macho
Garantía e instructivo con listado de centros de servicio.

197692

Garantía 1 Año

1



Caja a color

NOM

DISTRIB.	MAYOREO	LISTA
\$2,500.00	\$3,570.00	\$4,410.00

HIDROLAVADORA A GASOLINA 7.5 ó 6.5 HP

APLICACIONES:

- Ideal para lavar cisternas industriales, serpentines industriales, pisos, paredes, lavado de autos, etc.

SISTEMA DE PRESIÓN EFICIENTE
Bomba de presión de agua con componentes para **USO RUDO** que incrementa la vida útil



7.5 HP - 3 600 PSI

cód. 191102

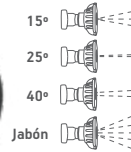

6.5 HP - 2 600 PSI

cód. 191101

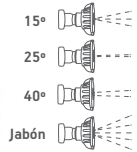

Industrial
AKSI

Industrial
AKSI

SISTEMA DE PROTECCIÓN DE BAJO NIVEL DE ACEITE

191102

Potencia de motor	5 593 W / 7.5 HP
Velocidad del motor	3 400 rev / min
Presión máxima	3 600 PSI
Manguera de alta presión	7.6 m
Flujo máximo	9 L / min
Combustible	Gasolina sin plomo
Capacidad del tanque	3 600 ml
Rendimiento de gasolina	1.5 h
Motor	OHV 7,5 HP 4 tiempos
Cilindrada	223 cc
Peso	33.5 Kg
Encendido	Cuerda retráctil
Tipo de aceite para mortor	SAE 10 W-30-sintético
Tamaño de llanta	12"

Se recomiendan 15 minutos de descanso por cada carga de combustible.

Tiempo de operación

Ventajas de mi herramienta

- Lanza rociadora de acero de 21" y cople de conexión.
- Carburador de primera calidad para un encendido fácil y un rendimiento óptimo.
- Pistola de gatillo ergonómica con traba.
- Sólido cigüeñal que soporta altas revoluciones y un intenso uso industrial asegurando una larga vida útil.
- De fácil traslado.
- Estructura metálica.
- Sistema de bajo nivel de aceite.



¡HERRAMIENTA MEJORADA!

Sistema de arranque mejorado

SISTEMA DE PROTECCIÓN DE BAJO NIVEL DE ACEITE

191101

Potencia de motor	4 875 W / 6,5 HP
Velocidad del motor	3 400 rev / min
Presión máxima	2 600 PSI
Manguera de alta presión	8 m
Flujo máximo	9 L / min
Combustible	Gasolina sin plomo
Capacidad del tanque	3 000 ml
Rendimiento de gasolina	1.5 h
Motor	OHV de 6.5 HP 4 Tiempos
Cilindrada	196 cc
Peso	32 kg
Encendido	Cuerda retráctil
Tipo de aceite para mortor	SAE 10 W-30-sintético
Tamaño de llanta	8"

Se recomiendan 15 minutos de descanso por cada carga de combustible.

- Lanza rociadora de acero de 21" y cople de conexión.
- Carburador de primera calidad para un encendido fácil y un rendimiento óptimo.
- Pistola de gatillo ergonómica con traba.
- Sólido cigüeñal que soporta altas revoluciones y un intenso uso industrial asegurando una larga vida útil.
- De fácil traslado.
- Estructura metálica.
- Sistema de bajo nivel de aceite.



¿QUÉ INCLUYE MI HERRAMIENTA?

- 5 Boquillas
 - 1 Manguera de alta presión
 - 2 Ruedas de 12"
 - 1 Lanza metálica
 - 1 Manguera para aplicación de jabón líquido
- Garantía e instructivo con listado de centros de servicio.

191102

MODELO: HIDRO-G-7.5-AK

Garantía 1 Año



Caja a color

NOM

DISTRIB.	MAYOREO	LISTA
\$8,500.00	\$12,145.00	\$14,995.00



¿QUÉ INCLUYE MI HERRAMIENTA?

- 1 Filtro
 - 1 Cinta teflón
 - 2 Llantas de 8"
 - 2 Pernos para llantas
 - 3 Llaves españolas
 - 1 Pistola
 - 1 Manguera para pistola
 - 1 Portapistola
 - 1 Lanza
 - 5 Boquillas
 - 1 Limpiaboquillas
 - 1 Llave para buja con perno
 - 1 Manguera para toma de agua en tinaco o cisterna
 - 1 Manguera para aplicación de líquido
 - 1 Portamanguera
 - 1 Conector rápido para manguera
 - 1 Soporte de transportación
 - 4 Tornillos con rondana plana
- Garantía e instructivo con listado de centros de servicio.

191101

MODELO: HIDRO-G-6.5-2-AK

Garantía 1 Año



Caja a color

NOM

DISTRIB.	MAYOREO	LISTA
\$7,200.00	\$10,285.00	\$12,700.00

HIDROLAVADORA ELÉCTRICA 1 650 ó 1 350 W

APLICACIONES:

- Ideal para la limpieza en superficies como paredes, pisos, automóviles y serpentines.

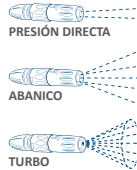

1 650 W - 1 850 PSI

cód. 191202

Profesional
AKSI

1 350 W - 1 500 PSI

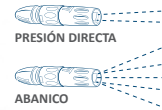
cód. 391202

Doméstica
IT MAX TOOL

Tensión / frecuencia
Potencia
Corriente
Presión máxima
Flujo de agua
Depósito de jabón

Tiempo de operación

Ventajas de mi herramienta

¡HERRAMIENTA MEJORADA!
Sistema de protección eléctrica.

191202

127 V ~ / 60 Hz
1 650 W
13 A
12 755 KPa (1850 PSI)
6 L / min
Interno

30 minutos de trabajo x 10 minutos de descanso. Máximo diario: 3 horas.

- Seguro de gatillo.
- Ruedas para su fácil traslado.
- Conexiones rápidas en la manguera.
- Práctica pistola.
- Una lanza turbo tipo cónico y una lanza con regulador de presión y regulador para succionar el jabón.
- Soportes laterales y traseros, mejor uso.
- Interruptor térmico en el motor para proteger de sobrecalentamiento, alargando su vida útil.

¿QUÉ INCLUYE MI HERRAMIENTA?

1 Manija de sujeción, 1 pistola, 1 lanza boquilla turbo, 1 lanza boquilla abanico con regulador de presión, 1 protector de lanza, 1 porta pistola, 1 porta manguera, 1 manguera de presión, 1 filtro de agua, 1 conector rápido, 1 limpia boquillas y garantía e instructivo con listado de centros de servicio.

191202

MODELO: HIDRO-E-1850-AK

Garantía 1 Año



Caja a color

NOM

DISTRIB.	MAYOREO	LISTA
\$2,000.00	\$2,855.00	\$3,530.00

¡HERRAMIENTA MEJORADA!
Sistema de protección eléctrica.

391202

127 V ~ / 60 Hz
1 350 W
10 A
10 342 KPa (1500 PSI)
5.4 - 6 L / min

15 minutos de trabajo x 8 minutos de descanso. Máximo diario: 1 hora.

- Seguro de gatillo.
- Portátil y de fácil transportación.
- Una lanza con regulador de presión.
- 5 m de cable de alimentación.
- 3 m de manguera de alta presión.
- Soportes laterales, mejor uso.
- El motor cuenta con interruptor térmico para proteger el motor de sobrecalentamiento y alargar su vida útil.

¿QUÉ INCLUYE MI HERRAMIENTA?

1 Manija de sujeción, 1 porta cable, 1 porta pistola, 1 porta manguera, 1 cubierta para tubo de entrada y salida, 1 pistola, 1 lanza boquilla abanico, 1 extensión de lanza, 1 manguera de presión, 1 limpia boquillas, 1 filtro de agua, 4 pijas, 1 conexión de entrada de agua y garantía e instructivo con listado de centros de servicio.

391202

MODELO: HIDRO-E-1500-MX

Garantía 6 Meses



Caja a color

NOM

DISTRIB.	MAYOREO	LISTA
\$1,150.00	\$1,645.00	\$2,030.00

 Enriquece tu herramienta con
CONECTOR DE RIEGO

PÁG.91



LAVADORA DE TAPICERÍA

1 200 ó 450 W

APLICACIONES:

- Ideal para uso particular y profesional en el hogar, autolavados, centros de lavado de tapicería, etc.
- Elimina fácilmente manchas de comida, líquidos derramados, lodo, mugre y más.
- Muy útil en el lavado de alfombras, sofás, colchones, sillas de tela y vestiduras de autos.

1 200 W - 20 L

cód. 191752



450 W - 12 L

cód. 191751



Boquilla pulverizadora con cepillo

Profesional
AKSI

HOME
XPERIENCE SERIES

Funciones
Tensión
Potencia
Corriente
Capacidad máxima de sólidos
Capacidad máxima de líquidos
Fuerza de succión
Capacidad de depósito
Manguera

Tiempo de operación

Ventajas de mi herramienta

191752

Aspirado / soplado / lavado
127 V ~ / 60 Hz
1 200 W
10 A
20 litros
12.5 litros
17 kPa / 2.64 PSI / 0.068 bar
4 litros
1.9 m

30 minutos de trabajo x 10 minutos de descanso. Máximo diario: 3 horas.

- **Control inalámbrico en encendido de rociado, aspirado y soplado.**
- Depósito para recolección de líquidos sucios.
- Depósito para enjuague.
- Cuenta con cepillo para remover y succionar polvo o líquidos impregnados en telas, alfombras y tapicería en general.
- Fácil de guardar y transportar.
- Ecológico.
- Desplazamiento por medio de ruedas giratorias 360°

¿QUÉ INCLUYE MI HERRAMIENTA?

2 Ruedas 360°	2 Boquillas rociadoras
2 Extensiones	1 Boquilla esquinera
1 Filtro para polvo	1 Conector de manguera
1 Filtro para agua	Garantía e instructivo con listado de centros de servicio.
1 Depósito para agua	
1 Manguera	
1 Pila	
2 Cepillos	

191752

MODELO: LAVTAP-1200p-AK

Garantía 1 Año

1



Caja a color

NOM

DISTRIB.	MAYOREO	LISTA
\$3,150.00	\$4,500.00	\$5,555.00

191751

Aspirado / lavado
127 V ~ / 60 Hz
450 W
3.5 A
1.2 litros
0.4 L / min
9 kPa

1.3 m

30 minutos de trabajo x 10 minutos de descanso. Máximo diario: 3 horas.

- Aspirado, lavado y enjuague.
- Depósito para enjuague.
- Depósito para recolección de líquidos sucios.
- Cuenta con cepillo para remover y succionar polvo o líquidos impregnados en telas, alfombras y tapicería en general.
- El sistema de rociado es eficaz para eliminar manchas en telas y tapicerías.

¿QUÉ INCLUYE MI HERRAMIENTA?

- 1 Depósito para agua limpia
- 1 Depósito para agua sucia
- 1 Cepillo
- 1 Boquilla de succión
- 1 Manguera de 1.3 m
- Garantía e instructivo con listado de centros de servicio.

191751

MODELO: LAVTAP-450h-AK

Garantía 1 Año

2



Caja a color

NOM

DISTRIB.	MAYOREO	LISTA
\$1,950.00	\$2,785.00	\$3,440.00

ASPIRADORA 20 y 50 L

APLICACIONES:

- Ideal para uso particular y profesional.
- Aspira partículas sólidas y líquidas (no apta para líquidos inflamables).
- Útil en inflado de globos, inflables, colchones, etc.

1 400 W - 50 L / 13 Gal

cód. 191702



1 200 W - 20 L / 5 Gal

cód. 191701



Industrial
AKSI

Industrial
AKSI

Tensión
Potencia
Corriente
Capacidad máxima en sólidos
Capacidad máxima en líquidos
Fuerza de succión
Manguera

191702

127 V ~ / 60 Hz
1 400 W
10 A
50 litros
35 L / min
17 kPa
1.5 m

50 minutos de trabajo x 20 minutos de descanso. Máximo diario: 6 horas.

- Desagüe amplio, para un vaciado rápido.
- Asa superior de rápida liberación.
- Fácil transportación con ruedas giratorias 360°
- Ahorra espacio al guardar sus accesorios internamente.
- Ecológica.

191701

127 V ~ / 60 Hz
1 200 W
10 A
20 litros
14.5 L / min
17 kPa
1.5 m

50 minutos de trabajo x 20 minutos de descanso. Máximo diario: 6 horas.

- Desagüe amplio, para un vaciado rápido.
- Asa superior de rápida liberación.
- Fácil transportación con ruedas giratorias 360°
- Ahorra espacio al guardar sus accesorios internamente.
- Ecológica.

Tiempo de operación

Ventajas de mi herramienta

¿QUÉ INCLUYE MI HERRAMIENTA?

- 4 Ruedas 360°
- 2 Extensiones
- 1 Filtro para polvo
- 1 Filtro para agua
- 1 Manguera de 1.5 m
- 1 Boquilla esquinera
- 1 Boquilla tipo garra
- 1 Cepillo esquinero
- 1 Cepillo deslizante
- Garantía e instructivo con listado de centros de servicio.



191702

MODELO: ASPIM-1400i-AK

Garantía 1 Año

1



Caja a color

NOM

DISTRIB.	MAYOREO	LISTA
\$3,500.00	\$5,000.00	\$6,175.00

¿QUÉ INCLUYE MI HERRAMIENTA?

- 4 Ruedas 360°
- 3 Extensiones
- 1 Filtro para polvo
- 1 Filtro para agua
- 1 Manguera de 1.5 m
- 1 Boquilla esquinera
- 1 Cepillo esquinero
- 1 Cepillo deslizante
- 1 Asa
- 2 Tornillos para asa
- Garantía e instructivo con listado de centros de servicio.



191701

MODELO: ASPIM-1200i-AK

Garantía 1 Año

1



Caja a color

NOM

DISTRIB.	MAYOREO	LISTA
\$1,750.00	\$2,500.00	\$3,085.00

POLIPASTO ELÉCTRICO

APLICACIONES:

- Sostenimiento o elevación de carga.
- Dos diferentes capacidades de carga.

850 W - 400 kg

cód. 197701

1 180 W - 600 kg

cód. 197702

1 450 W - 800 kg

cód. 197703

1 500 W - 1 000 kg

cód. 197704

Industrial
AKSI

Industrial
AKSI

Industrial
AKSI

Industrial
AKSI

Tensión	120 V ~
Corriente	7.1 A
Frecuencia	60 Hz
Potencia	850 W
Velocidad	10 m/min (200 kg) 5 m/min (400 kg)
Altura	12 m (200 kg) 6 m (400 kg)
Motor	Cobre
Cable de control	1.5 m

200 / 400 kg
197701
300 / 600 kg
197702
400 / 800 kg
197703
500 / 1 000 kg
197704

Tensión	120 V ~
Corriente	7.1 A
Frecuencia	60 Hz
Potencia	850 W
Velocidad	10 m/min (200 kg) 5 m/min (400 kg)
Altura	12 m (200 kg) 6 m (400 kg)
Motor	Cobre
Cable de control	1.5 m

Tensión	120 V ~
Corriente	9.85 A
Frecuencia	60 Hz
Potencia	1 180 W
Velocidad	10 m/min (300 kg) 5 m/min (600 kg)
Altura	12 m (300 kg) 6 m (600 kg)
Motor	Cobre
Cable de control	3 m

Tensión	120 V ~
Corriente	12.6 A
Frecuencia	60 Hz
Potencia	1 450 W
Velocidad	10 m/min (400 kg) 5 m/min (800 kg)
Altura	12 m (400 kg) 6 m (800 kg)
Motor	Cobre
Cable de control	3 m

Tensión	120 V ~
Corriente	12.9 A
Frecuencia	60 Hz
Potencia	1 500 W
Velocidad	10 m/min (500 kg) 5 m/min (1 000 kg)
Altura	12 m (500 kg) 6 m (1 000 kg)
Motor	Cobre
Cable de control	3 m

Tiempo de operación

2 minutos de trabajo x 8 minutos de descanso. Máximo diario: 6 horas.

2 minutos de trabajo x 8 minutos de descanso. Máximo diario: 6 horas.

2 minutos de trabajo x 8 minutos de descanso. Máximo diario: 6 horas.

2 minutos de trabajo x 8 minutos de descanso. Máximo diario: 6 horas.

Ventajas de mi herramienta

· Dos modalidades para el sostenimiento y elevación de carga.

· Dos modalidades para el sostenimiento y elevación de carga.

· Dos modalidades para el sostenimiento y elevación de carga.

· Dos modalidades para el sostenimiento y elevación de carga.



Para cargas altas



Para cargas bajas

! ¿QUÉ INCLUYE MI HERRAMIENTA?

 1 Polea
1 Gancho
2 Abrazaderas
Garantía e instructivo con listado de centros de servicio.

! ¿QUÉ INCLUYE MI HERRAMIENTA?

 1 Polea
1 Gancho
2 Abrazaderas
Garantía e instructivo con listado de centros de servicio.

! ¿QUÉ INCLUYE MI HERRAMIENTA?

 1 Polea
1 Gancho
2 Abrazaderas
Garantía e instructivo con listado de centros de servicio.

! ¿QUÉ INCLUYE MI HERRAMIENTA?

 1 Polea
1 Gancho
2 Abrazaderas
Garantía e instructivo con listado de centros de servicio.

197701

MODELO: PPE-200i-2-AK

Garantía 1 Año



Caja a color

DISTRIB.	MAYOREO	LISTA
\$3,300.00	\$4,715.00	\$5,820.00

197702

MODELO: PPE-300i-2-AK

Garantía 1 Año



Caja a color

DISTRIB.	MAYOREO	LISTA
\$4,300.00	\$6,145.00	\$7,585.00

197703

MODELO: PPE-400i-AK

Garantía 1 Año



Caja a color

DISTRIB.	MAYOREO	LISTA
\$5,000.00	\$7,145.00	\$8,820.00

197704

MODELO: PPE-500i-AK

Garantía 1 Año



Caja a color

DISTRIB.	MAYOREO	LISTA
\$7,000.00	\$10,000.00	\$12,345.00

TIPOS DE Soldadoras AKSI®

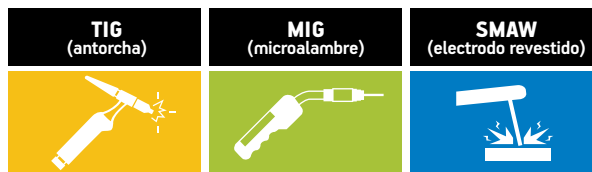

CÓDIGO		197911 pág. 296	197912 pág. 296	197923 pág. 296	197924 pág. 297	197925 pág. 297	197931 pág. 299	197932 pág. 299	197933 pág. 298	197934 pág. 298
		SEMI PROFESIONAL			PROFESIONAL					
V~	TIPO DE VOLTAJE	BI-VOLTAJE 127 - 220 V~	BI-VOLTAJE 127 - 220 V~	BI-VOLTAJE 127 - 220 V~	BI-VOLTAJE 127 - 220 V~	BI-VOLTAJE 127 - 220 V~	BI-VOLTAJE 127 - 220 V~	BI-VOLTAJE 127 - 220 V~	VOLTAJE 220 V~	VOLTAJE 220 V~
APLICACIONES	HERRERÍA	TIG	TIG		TIG	TIG	TIG	TIG	TIG	TIG
							MIG	MIG	MIG	MIG
		SMAW	SMAW	SMAW	SMAW	SMAW	SMAW	SMAW	SMAW	SMAW
INDUSTRIA					TIG	TIG	TIG	TIG	TIG	TIG
				SMAW	SMAW	SMAW			SMAW	SMAW
AUTOMOTRIZ		TIG	TIG		TIG	TIG	TIG	TIG	TIG	TIG
							MIG	MIG	MIG	MIG
NO se recomienda el uso de SMAW en la industria automotriz										
ESPECIFICACIONES	GAS RECOMENDADO Ar - Argón CO ₂ - Dioxido de Carbono	Ar / CO ₂	Ar / CO ₂	N/A	Ar / CO ₂	Ar / CO ₂	CO ₂	CO ₂	CO ₂	CO ₂
	PROTECCIÓN TÉRMICA	•	•	•	•	•	•	•	•	•
	ARCO REFORZADO	x	x	•	•	•	x	•	•	•
	ANTIADHERENTE	x	x	•	•	•	•	•	•	•
	ARRANQUE EN CALIENTE	x	x	•	•	•	x	x	x	x
VRD (Reducción de voltaje)	x	x	•	•	•	x	x	x	x	
TIPO DE SOLDADURA	Electrodo revestido SMAW	6013: 3/32 1/8 5/32 6011: 3/32 1/8 5/32 7018: 3/32 1/8 5/32	6013: 3/32 1/8 5/32 6011: 3/32 1/8 5/32 7018: 3/32 1/8 5/32	6013: 3/32 1/8 5/32 6011: 3/32 1/8 5/32 7018: 3/32 1/8 5/32	6013: 3/32 1/8 5/32 6011: 3/32 1/8 5/32 7018: 3/32 1/8 5/32	6013: 3/32 1/8 5/32 6011: 3/32 1/8 5/32 7018: 3/32 1/8 5/32	6013: 3/32 1/8 5/32 6011: 3/32 1/8 5/32 7018: 3/32 1/8	6013: 3/32 1/8 5/32 6011: 3/32 1/8 5/32 7018: 3/32 1/8	6013: 3/32 1/8 5/32 6011: 3/32 1/8 5/32 7018: 3/32 1/8 5/32	6013: 3/32 1/8 5/32 6011: 3/32 1/8 5/32 7018: 3/32 1/8 5/32
	Microalambre MIG	x	x	x	x	x	1.6 mm 2 mm	1.6 mm 2 mm	1.6 mm 2 mm	1.6 mm 2 mm
	Antorcha TIG	1.6 mm	1.6 mm	x	1.6 mm 2 mm	1.6 mm 2 mm	0.6 mm 0.8 mm 1 mm	0.6 mm 0.8 mm 1 mm	0.6 mm 0.8 mm 1 mm	0.6 mm 0.8 mm 1 mm



¿QUÉ TUNGSTENO DEBO UTILIZAR?

COLOR	CORRIENTE	MATERIAL A SOLDAR
VERDE	AC	Aluminio, Magnesio
AMARILLO	DC	Acero, Níquel, Titanio, Cobre
ROJO	DC	Acero, Níquel, Titanio, Cobre
MORADO	DC	Acero, Níquel, Titanio, Cobre
NARANJA	DC	Acero, Níquel, Titanio, Cobre
BLANCO	AC	Aluminio, Magnesio
NEGRO	AC/DC	Acero, Níquel, Titanio, Cobre, Aluminio
AZUL	AC/DC	Acero, Níquel, Titanio, Cobre, Aluminio
GRIS	AC/DC	Acero, Níquel, Titanio, Cobre, Aluminio
TURQUEZA	AC/DC	Acero, Níquel, Titanio, Cobre, Aluminio

¿QUÉ NECESITO PARA SOLDAR CON TIG?

1. Tanque de gas inerte.
2. Regulador de gas.
3. Electrodo de Tungsteno.
4. Esmeril de banco (Cód. 197002) con rueda abrasiva de Carburo de silicio (Cód. 114711, Cód. 114712). Se requiere para dar filo al electrodo de Tungsteno.
5. Varillas de relleno (acorde al material a soldar).
6. Careta.
7. Guantes y equipo de protección personal.

TIPOS DE Soldadoras MX®

	CÓDIGO	391401 pág. 300	391402 pág. 300
V~	TIPO DE VOLTAJE	VOLTAJE 127 V~	BI-VOLTAJE 220 V~
APLICACIONES	HERRERÍA	SMAW	TIG SMAW
	INDUSTRIA		
	AUTOMOTRIZ	NO se recomienda SMAW en la industria automotriz	
ESPECIFICACIONES	GAS RECOMENDADO Ar - Argón CO ₂ - Dioxido de Carbono		Ar / CO ₂
	PROTECCIÓN TÉRMICA	•	•
	ARCO REFORZADO	x	x
	ANTIADHERENTE	x	x
	ARRANQUE EN CALIENTE	x	x
	VRD (Reducción de voltaje)	x	x
TIPO DE SOLDADURA	Electrodo revestido SMAW	6013: 3/32 1/8 6011: 3/32 1/8 7018: 3/32	6013: 3/32 1/8 5/32 6011: 3/32 1/8 5/32 7018: 3/32 1/8
	Microalambre MIG	x	x
	Antorcha TIG	x	1.6 mm

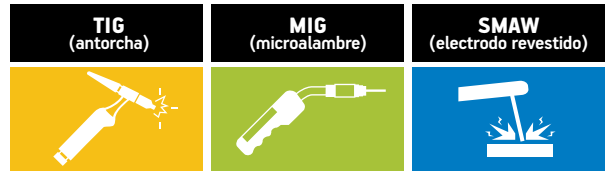

NOMENCLATURA DE ELECTRODOS

Cómo saber que electrodo debo utilizar
(E-6011, E-6013, E7018)

Este ejercicio esta realizado con el electrodo

E - 60 1 3

E	Electrodo
60	Resistencia mínima a la tracción Ksi (kilolibras/pulgada ²) 1 Ksi = 1 000 psi En este ejemplo son 60 000 psi, representado con el 60
1	Posición para soldar 1: Todas las posiciones 2: Posición plana y horizontal 4: Todas, especialmente vertical con progresión descendente.
3	Tipo de revestimiento 0-1 Tipo celusico. 3-4 Tipo rutílico 5-6-8 Tipo básico o bajo Hidrógeno

SOLDADORA INVERSORA

APLICACIONES:

· Ideal para ser usada en talleres mecánicos, hojalatería y pintura, herrería y balconería.



PROX.

127 V~ 130 A

cód. 197923



USO



PROX.

127 V~ y 220 V~ 160 A

cód. 197911



USO



PROX.

127 V~ y 220 V~ 200 A

cód. 197912



USO



Profesional
AKSI

Semi PRO
AKSI

Semi PRO
AKSI

197923

127 V~	220 V~
Tensión / frecuencia 127 V~ / 60 Hz	220 V~ / 60 Hz
Salida de corriente 105 A	130 A
Rango de corriente 30 - 120 A	30 - 120 A
Corriente de entrada 35 - 43 A	28 - 35 A
Corriente máxima 130 A	130 A
Grado de protección IP 21S	IP 21S
Peso 3.4 kg	3.4 kg
Tipo de gas N/A	

E-6013	3/32", 1/8"
E-6011	3/32", 1/8", 5/32"
E-7018	3/32", 1/8"

197911

127 V~	220 V~
Tensión / frecuencia 127 V~ / 60 Hz	220 V~ / 60 Hz
Salida de corriente 124 A	155 A
Rango de corriente 20 - 160 A	10 - 160 A
Corriente de entrada 35 - 45 A	30 - 35 A
Corriente máxima 160 A	160 A
Grado de protección IP 21S	IP 21S
Peso 3.9 A	3.9 A
Tipo de gas Ar, CO ₂	

E-6013	3/32", 1/8", 5/32"
E-6011	3/32", 1/8", 5/32"
E-7018	3/32", 1/8", 5/32"

1.6 mm

197912

127 V~	220 V~
Tensión / frecuencia 127 V~ / 60 Hz	220 V~ / 60 Hz
Salida de corriente 140 A	185 A
Rango de corriente 20 - 200 A	20 - 200 A
Corriente de entrada 45 - 55 A	35 - 45 A
Corriente máxima 200 A	200 A
Grado de protección IP 21S	IP 21S
Peso 4.4 kg	4.4 kg
Tipo de gas Ar, CO ₂	

E-6013	3/32", 1/8", 5/32"
E-6011	3/32", 1/8", 5/32"
E-7018	3/32", 1/8", 5/32"

1.6 mm

Tensión / frecuencia	127 V~ / 60 Hz	220 V~ / 60 Hz
Salida de corriente	105 A	130 A
Rango de corriente	30 - 120 A	30 - 120 A
Corriente de entrada	35 - 43 A	28 - 35 A
Corriente máxima	130 A	130 A
Grado de protección	IP 21S	IP 21S
Peso	3.4 kg	3.4 kg
Tipo de gas	N/A	

Tipo de electrodo SMAW

Tipo de electrodo TIG

Tiempo de operación

127 V~	220 V~
30% a 130 A: 3 minutos de trabajo x 7 minutos de descanso.	30% a 180 A: 3 minutos de trabajo x 7 minutos de descanso.
60% a 100 A: 6 minutos de trabajo x 4 minutos de descanso.	60% a 155 A: 6 minutos de trabajo x 4 minutos de descanso.

127 V~	220 V~
30% a 130 A: 3 minutos de trabajo x 7 minutos de descanso.	30% a 180 A: 3 minutos de trabajo x 7 minutos de descanso.
60% a 100 A: 6 minutos de trabajo x 4 minutos de descanso.	60% a 155 A: 6 minutos de trabajo x 4 minutos de descanso.

127 V~	220 V~
30% a 130 A: 3 minutos de trabajo x 7 minutos de descanso.	30% a 180 A: 3 minutos de trabajo x 7 minutos de descanso.
60% a 100 A: 6 minutos de trabajo x 4 minutos de descanso.	60% a 155 A: 6 minutos de trabajo x 4 minutos de descanso.

Ventajas de mi herramienta

Protección térmica	•
Arco reforzado	•
Antiadherente	•
Arranque en caliente	•
VRD (reducción de voltaje)	•

Protección térmica	•
Arco reforzado	•
Antiadherente	x
Arranque en caliente	x
VRD (reducción de voltaje)	x

Protección térmica	•
Arco reforzado	•
Antiadherente	x
Arranque en caliente	x
VRD (reducción de voltaje)	x

Enriquece tu herramienta con **ELECTRODOS AKSI®**

PÁG. 113

Enriquece tu herramienta con **VARIEDAD DE PINZAS**

PÁG. 363



¿QUÉ INCLUYE MI HERRAMIENTA?

Cables pinza punta electrodo
1 Pinza a tierra
1 Careta
1 Martillo
1 Cepillo de alambre
Garantía e instructivo con listado de centros de servicio.

197923

SLDR-INVER-130p-AK

Garantía 1 Año

1



Caja a color

DISTRIB.	MAYOREO	LISTA
\$1,950.00	\$2,785.00	\$3,440.00



¿QUÉ INCLUYE MI HERRAMIENTA?

Cables pinza punta electrodo
1 Pinza a tierra
1 Careta
1 Martillo
1 Cepillo de alambre
Garantía e instructivo con listado de centros de servicio.

197911

MODELO: SLDL-INVER-160s-AK

Garantía 1 Año

1



Caja a color

DISTRIB.	MAYOREO	LISTA
\$1,700.00	\$2,430.00	\$3,000.00



¿QUÉ INCLUYE MI HERRAMIENTA?

Cables pinza punta electrodo
1 Pinza a tierra
1 Careta
1 Martillo
1 Cepillo de alambre
Garantía e instructivo con listado de centros de servicio.

197912

SLDR-INVER-200s-AK

Garantía 1 Año

1



Caja a color

DISTRIB.	MAYOREO	LISTA
\$2,500.00	\$3,570.00	\$4,410.00

SOLDADORA TIG INVERSORA

APLICACIONES:

- Ideal para ser usada en talleres mecánicos, hojalatería y pintura, herrería y balconería.

PROX.

TIG 127 V~ y 220 V~ 160 A

cód. 197924



USO



Profesional
AKSI

PROX.

TIG 127 V~ y 220 V~ 200 A

cód. 197925



USO



Profesional
AKSI

AKSI®

M

197924

127 V~	220 V~
127 V~ / 60 Hz	220 V~ / 60 Hz
117 - 146 A	117 - 146 A
30 - 160 A	30 - 160 A
32 - 40 A	24 - 32 A
160 A	160 A
IP 21S	IP 21S
3.8 kg	3.8 kg

Ar, CO₂

E-6013	3/32", 1/8", 5/32"
E-6011	3/32", 1/8", 5/32"
E-7018	3/32", 1/8", 5/32"
1.6 mm, 2 mm	

127 V~

30% a 130 A:
3 minutos de trabajo
x 7 minutos de
descanso.
60% a 100 A:
6 minutos de trabajo
x 4 minutos de
descanso.

220 V~

30% a 180 A:
3 minutos de trabajo
x 7 minutos de
descanso.
60% a 155 A:
6 minutos de trabajo
x 4 minutos de
descanso.

Protección térmica	•
Arco reforzado	•
Antiadherente	•
Arranque en caliente	•
VRD (reducción de voltaje)	•



¿QUÉ INCLUYE MI HERRAMIENTA?

Cables pinza punta electrodo
1 Pinza a tierra
1 Careta
1 Martillo
1 Cepillo de alambre
Garantía e instructivo con listado de centros de servicio.

197924

MODELO: SLDR-INV-TIG-160p-AK

Garantía 1 Año



Caja a color

DISTRIB.	MAYOREO	LISTA
\$2,550.00	\$3,645.00	\$4,500.00

197925

127 V~	220 V~
127 V~ / 60 Hz	220 V~ / 60 Hz
80 - 92 A	80 - 192 A
30 - 200 A	30 - 200 A
30 - 38 A	30 - 45 A
200 A	200 A
IP 21S	IP 21S
4.1 kg	4.1 kg

Ar, CO₂

E-6013	3/32", 1/8", 5/32"
E-6011	3/32", 1/8", 5/32"
E-7018	3/32", 1/8", 5/32"
1.6 mm, 2 mm	

127 V~

30% a 130 A:
3 minutos de trabajo
x 7 minutos de
descanso.
60% a 100 A:
6 minutos de trabajo
x 4 minutos de
descanso.

220 V~

30% a 180 A:
3 minutos de trabajo
x 7 minutos de
descanso.
60% a 155 A:
6 minutos de trabajo
x 4 minutos de
descanso.

Protección térmica	•
Arco reforzado	•
Antiadherente	•
Arranque en caliente	•
VRD (reducción de voltaje)	•



¿QUÉ INCLUYE MI HERRAMIENTA?

Cables pinza punta electrodo
1 Pinza a tierra
1 Careta
1 Martillo
1 Cepillo de alambre
Garantía e instructivo con listado de centros de servicio.

197925

MODELO: SLDR-INV-TIG-200p-AK

Garantía 1 Año



Caja a color

DISTRIB.	MAYOREO	LISTA
\$3,250.00	\$4,645.00	\$5,735.00

Tensión / frecuencia

Salida de corriente

Rango de corriente

Corriente de entrada

Corriente máxima

Grado de protección

Peso

Tipo de gas

Tipo de electrodo SMAW

Tipo de electrodo TIG

Tiempo de operación

Ventajas de mi herramienta

Enriquece tu herramienta con
ELECTRODOS AKSI®

PÁG. 113

Enriquece tu herramienta con
VARIEDAD DE PINZAS

PÁG. 363

SOLDADORA MIG INVERSORA

APLICACIONES:

· Ideal para ser usada en talleres mecánicos, hojalatería y pintura, herrería y balconería.

No se recomienda el uso de electrodos revestidos SMAW en la industria automotriz.



Profesional
AKSI

Profesional
AKSI

Tensión / frecuencia
Salida de corriente
Rango de corriente
Corriente de entrada
Corriente máxima
Grado de protección
Peso
Tipo de gas

Tipo de electrodo SMAW

Tipo de electrodo TIG

Tipo de electrodo MIG

Tiempo de operación

Ventajas de mi herramienta

Enriquece tu herramienta con **ELECTRODOS AKSI®**

PÁG. 113

Enriquece tu herramienta con **VARIEDAD DE PINZAS**

PÁG. 363

197933

220 V~

220 V~ / 60 Hz
70 - 180 A
20 - 200 A
20 - 44 A
200 A
IP 21S
20 kg
CO ₂

E-6013	3/32", 1/8", 5/32"
E-6011	3/32", 1/8", 5/32"
E-7018	3/32", 1/8", 5/32"
1.6 mm	
0.6 mm, 0.8 mm, 1mm	

127 V~

30% a 130 A:
3 minutos de trabajo
x 7 minutos de
descanso.
60% a 100 A:
6 minutos de trabajo
x 4 minutos de
descanso.

220 V~

30% a 180 A:
3 minutos de trabajo
x 7 minutos de
descanso.
60% a 155 A:
6 minutos de trabajo
x 4 minutos de
descanso.

Protección térmica	•
Arco reforzado	•
Antiadherente	•
Arranque en caliente	x
VRD (reducción de voltaje)	x



¿QUÉ INCLUYE MI HERRAMIENTA?

Cables pinza punta electrodo
1 Pinza a tierra
1 Careta
1 Martillo
1 Cepillo de alambre
Garantía e instructivo con listado de centros de servicio.

197933

MODELO: SLDL-INV-MIG-200p-AK

Garantía 1 Año

1



Caja a color

DISTRIB.	MAYOREO	LISTA
\$13,000.00	\$18,570.00	\$22,930.00

197934

220 V~

220 V~ / 60 Hz
90 - 230 A
20 - 250 A
20 - 55 A
250 A
IP 21S
25 kg
CO ₂

E-6013	3/32", 1/8", 5/32"
E-6011	3/32", 1/8", 5/32"
E-7018	3/32", 1/8", 5/32"
0.6 mm, 0.8 mm, 1mm	

127 V~

30% a 130 A:
3 minutos de trabajo
x 7 minutos de
descanso.
60% a 100 A:
6 minutos de trabajo
x 4 minutos de
descanso.

220 V~

30% a 180 A:
3 minutos de trabajo
x 7 minutos de
descanso.
60% a 155 A:
6 minutos de trabajo
x 4 minutos de
descanso.

Protección térmica	•
Arco reforzado	•
Antiadherente	•
Arranque en caliente	x
VRD (reducción de voltaje)	x



¿QUÉ INCLUYE MI HERRAMIENTA?

Cables pinza punta electrodo
1 Pinza a tierra
1 Careta
1 Martillo
1 Cepillo de alambre
Garantía e instructivo con listado de centros de servicio.

197934

MODELO: SLDL-INV-MIG-250p-AK

Garantía 1 Año

1



Caja a color

DISTRIB.	MAYOREO	LISTA
\$8,000.00	\$11,430.00	\$14,110.00

SOLDADORA MIG INVERSORA

APLICACIONES:

· Ideal para ser usada en talleres mecánicos, hojalatería y pintura, herrería y balconería.

No se recomienda el uso de electrodos revestidos SMAW en la industria automotriz.

PROX.

MIG

127 V~ 130 A

cód. 197931



USO Herrería Industria Automotriz

Profesional
AKSI

PROX.

AKSI®

M

MIG

127 V~ 140 A

cód. 197932



USO Herrería Industria Automotriz

Profesional
AKSI

Tensión / frecuencia
Salida de corriente
Rango de corriente
Corriente de entrada
Corriente máxima
Grado de protección
Peso
Tipo de gas

Tipo de electrodo SMAW

Tipo de electrodo TIG

Tipo de electrodo MIG

Tiempo de operación

Ventajas de mi herramienta

Enriquece tu herramienta con **ELECTRODOS AKSI®**

PÁG. 113

Enriquece tu herramienta con **VARIEDAD DE PINZAS**

PÁG. 363

197931

127 V~	220 V~
127 V~ / 60 Hz	220 V~ / 60 Hz
80 - 130 A	80 - 130 A
30 - 130 A	30 - 130 A
18 - 40 A	18 - 40 A
160 A	160 A
IP 21S	IP 21S
6 kg	6 kg

CO₂

E-6013	3/32", 1/8", 5/32"
E-6011	3/32", 1/8", 5/32"
E-7018	3/32", 1/8"
1.6 mm	
0.6 mm, 0.8 mm, 1mm	

127 V~	220 V~
30% a 130 A: 3 minutos de trabajo x 7 minutos de descanso.	30% a 180 A: 3 minutos de trabajo x 7 minutos de descanso.
60% a 100 A: 6 minutos de trabajo x 4 minutos de descanso.	60% a 155 A: 6 minutos de trabajo x 4 minutos de descanso.

Protección térmica	•
Arco reforzado	x
Antiadherente	•
Arranque en caliente	x
VRD (reducción de voltaje)	x



! ¿QUÉ INCLUYE MI HERRAMIENTA?

Cables pinza punta electrodo
1 Pinza a tierra
1 Careta
1 Martillo
1 Cepillo de alambre
Garantía e instructivo con listado de centros de servicio.

197931

MODELO: SLDR-INV-MIG-130p-AK
Garantía 1 Año
1
Caja a color
DISTRIB. \$2,750.00
MAYOREO \$3,930.00
LISTA \$4,850.00

197932

127 V~	220 V~
127 V~ / 60 Hz	220 V~ / 60 Hz
80 - 110 A	80 - 110 A
30 - 125 A	30 - 125 A
13 - 35 A	13 - 35 A
140 A	140 A
IP 21S	IP 21S
5 kg	5 kg

CO₂

E-6013	3/32", 1/8", 5/32"
E-6011	3/32", 1/8", 5/32"
E-7018	3/32", 1/8"
1.6 mm	
0.6 mm, 0.8 mm, 1mm	

127 V~	220 V~
30% a 130 A: 3 minutos de trabajo x 7 minutos de descanso.	30% a 180 A: 3 minutos de trabajo x 7 minutos de descanso.
60% a 100 A: 6 minutos de trabajo x 4 minutos de descanso.	60% a 155 A: 6 minutos de trabajo x 4 minutos de descanso.

Protección térmica	•
Arco reforzado	•
Antiadherente	•
Arranque en caliente	x
VRD (reducción de voltaje)	x



! ¿QUÉ INCLUYE MI HERRAMIENTA?

Cables pinza punta electrodo
1 Pinza a tierra
1 Careta
1 Martillo
1 Cepillo de alambre
Garantía e instructivo con listado de centros de servicio.

197932

MODELO: SLDR-INV-MIG-140p-AK
Garantía 1 Año
1
Caja a color
DISTRIB. \$5,500.00
MAYOREO \$7,855.00
LISTA \$9,700.00

SOLDADORA y MINI SOLDADORA

APLICACIONES:

· Ideal para ser usada en talleres mecánicos, hojalatería y pintura, herrería y balconería.

ARCO ELÉCTRICO 127 V~ y 220 V~ 250 A

cód. 197902



127 V~ y 220 V~ 100 A

cód. 391401



127 V~ y 220 V~ 130 A

cód. 391402



USO



USO



Profesional
AKSI

Doméstica
ITI MAXTOOL

Doméstica
ITI MAXTOOL

197902

127 V~	220 V~
127 V ~ / 60 Hz	220 V ~ / 60 Hz
120 A	180 A
50 - 180 A	50 - 180 A
95 A	47 A
250 A	250 A
IP 21S	IP 21S
20 kg	20 kg
Tipo de gas: N/A	

E-6013 | 3/32", 1/8"

391401

127 V~	220 V~
127 V ~ / 60 Hz	220 V ~ / 60 Hz
97 A	116 A
20 - 101 A	20 - 130 A
28 - 30 A	28 - 35 A
101 A	130 A
IP 21S	IP 21S
2.5 kg	2.9 kg
Tipo de gas: N/A	

E-6013 | 3/32", 1/8"
E-6011 | 3/32", 1/8"
E-7018 | 3/32"

391402

127 V~	220 V~
127 V ~ / 60 Hz	220 V ~ / 60 Hz
113 A	116 A
20 - 130 A	20 - 130 A
28 - 35 A	18 - 21 A
130 A	130 A
IP 21S	IP 21S
2.9 kg	2.9 kg
Tipo de gas: Ar / CO ₂	

E-6013 | 3/32", 1/8", 5/32"
E-6011 | 3/32", 1/8", 5/32"
E-7018 | 3/32", 1/8"

1.6 mm

Tensión / frecuencia	127 V ~ / 60 Hz	220 V ~ / 60 Hz
Salida de corriente	120 A	180 A
Rango de corriente	50 - 180 A	50 - 180 A
Corriente de entrada	95 A	47 A
Corriente máxima	250 A	250 A
Grado de protección	IP 21S	IP 21S
Peso	20 kg	20 kg
Tipo de gas	N/A	

Tipo de electrodo SMAW

Tipo de electrodo TIG

Tiempo de operación

127 V~	220 V~
30% a 120 A, 3 minutos de trabajo x 7 minutos de descanso.	20% a 180 A, 2 minutos de trabajo x 8 minutos de descanso.

127 V~	220 V~
30% a 130 A: 3 minutos de trabajo x 7 minutos de descanso. 60% a 100 A: 6 minutos de trabajo x 4 minutos de descanso.	30% a 180 A: 3 minutos de trabajo x 7 minutos de descanso. 60% a 155 A: 6 minutos de trabajo x 4 minutos de descanso.

127 V~	220 V~
30% a 130 A: 3 minutos de trabajo x 7 minutos de descanso. 60% a 100 A: 6 minutos de trabajo x 4 minutos de descanso.	30% a 180 A: 3 minutos de trabajo x 7 minutos de descanso. 60% a 155 A: 6 minutos de trabajo x 4 minutos de descanso.

Ventajas de mi herramienta

Protección térmica	x
Arco reforzado	x
Antiadherente	x
Arranque en caliente	x
VRD (reducción de voltaje)	x



Protección térmica	.
Arco reforzado	x
Antiadherente	x
Arranque en caliente	x
VRD (reducción de voltaje)	x



Protección térmica	.
Arco reforzado	x
Antiadherente	x
Arranque en caliente	x
VRD (reducción de voltaje)	x



Enriquece tu herramienta con
ELECTRODOS AKSI®

PÁG. 113

Enriquece tu herramienta con
VARIEDAD DE PINZAS

PÁG. 363

¿QUÉ INCLUYE MI HERRAMIENTA?

Cables pinza punta electrodo
1 Pinza a tierra
1 Careta
1 Martillo
1 Cepillo de alambre
Garantía e instructivo con listado de centros de servicio.

¿QUÉ INCLUYE MI HERRAMIENTA?

Cables pinza punta electrodo
1 Pinza a tierra
1 Careta
1 Martillo
1 Cepillo de alambre
Garantía e instructivo con listado de centros de servicio.

¿QUÉ INCLUYE MI HERRAMIENTA?

Cables pinza punta electrodo
1 Pinza a tierra
1 Careta
1 Martillo
1 Cepillo de alambre
Garantía e instructivo con listado de centros de servicio.

197902

MODELO: SLD-AE-250I-AK

Garantía 1 Año



Caja a color

DISTRIB.	MAYOREO	LISTA
\$3,100.00	\$4,430.00	\$5,470.00

391401

MODELO: MN-SLD-INV-100-MX

Garantía 6 Meses



Caja a color

DISTRIB.	MAYOREO	LISTA
\$1,100.00	\$1,570.00	\$1,940.00

391402

MODELO: MN-SLD-INV-130-MX

Garantía 6 Meses



Caja a color

DISTRIB.	MAYOREO	LISTA
\$1,350.00	\$1,930.00	\$2,380.00

TERMOFUSORA para PPR

APLICACIONES:

- Plancha de calentamiento y dados de aluminio
- Cero fugas, proceso rápido, higiénico y sencillo
- Permite unir las piezas en una sola tubería
- Ciclo de trabajo continuo

PROX.

127 V~ 2 000 W

cód. 191803



Estuche metálico

110 V~ 650 W

cód. 191801



Estuche metálico

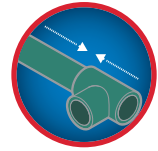

UNE



CORTA



CALIENTA



SIN FUGAS

Industrial
AKSI

Profesional
AKSI

Tensión
Frecuencia
Potencia
Grado de protección
Dados de termofusora

Tiempo de operación

191803

127 V~
60 Hz
2 000 W
IPX4
20 mm 25 mm 32 mm
40 mm 50 mm 63 mm

Trabajo continuo



¿QUÉ INCLUYE MI HERRAMIENTA?

1 Termofusora
1 Base fija para termofusora
1 Llave Allen®
1 Pinza de extracción
1 Pinza para corte de tubo PPR
1 Juego de dados
6 Tornillos
1 Nivel
1 Guantes
1 Flexometro 3 m
1 Desarmador
Garantía e instructivo con listado de centros de servicio.

191803

MODELO: TERMKIT-2000i-AK

Garantía 1 Año

4



Caja a color

DISTRIB.	MAYOREO	LISTA
\$1,500.00	\$2,145.00	\$2,645.00

191801

110 V~
60 Hz
650 W
IPX4
20 mm 25 mm 32 mm

Trabajo continuo



¿QUÉ INCLUYE MI HERRAMIENTA?

1 Termofusora
1 Base fija para termofusora
1 Llave Allen®
1 Pinza de extracción
1 Juego de dados (20, 25 y 32 mm)
3 Tornillos
1 Estuche metálico
Garantía e instructivo con listado de centros de servicio.

191801

MODELO: TERMO-650p-AK

Garantía 1 Año

4



Caja a color

DISTRIB.	MAYOREO	LISTA
\$900.00	\$1,285.00	\$1,590.00

ACCESORIOS PARA TERMOFUSORA

Conexiones PPR Página 385



Dado para termofusora

BOLSA

▶ Dados de aluminio



CÓDIGO	MEDIDA	PZAS X CAJA			DISTRIB.	MAYOREO	LISTA
191821	20 mm	1	10	100	\$100.00	\$143.00	\$175.00
191822	25 mm	1	10	100	\$120.00	\$170.00	\$210.00
191823	32 mm	1	10	190	\$130.00	\$185.00	\$230.00

MULTIHERRAMIENTA OSCILANTE 300 W

APLICACIONES:

· Lijar y pulir en seco superficies, reparar baños, pisos cerámicos, pisos vinílicos y alfombrados, realizar excelentes trabajos de adaptación y ajuste en lugares con poco espacio, además de realizar cortes más limpios y rápidos sobre materiales plásticos, metales no ferrosos y madera.

*Velcro® es una marca registrada.

MULTI PRO



Profesional

AKSI



Tensión
Potencia
Corriente
Oscilaciones

191501

127 V ~ / 60 Hz
300 W
2.3 A
10 000 - 18 000 órbitas / minuto

30 minutos de trabajo x 10 minutos de descanso. Máximo diario: 3 horas.

Tiempo de operación

Ventajas de mi herramienta

- Diseño compacto y múltiples accesorios que permiten cortar, lijar y remover diferentes materiales.
- Base de lijado con Velcro®



Accesorios de lijado intercambiables para llegar a los rincones más difíciles



Sierra semicircular ideal para corte en PVC, aluminio, cobre y pared de yeso



Útil rascador que remueve pintura, alfombras y adhesivos



Práctica hoja para cortar madera, plástico y metales no ferrosos



¿QUÉ INCLUYE MI HERRAMIENTA?

- 1 Hoja de corte de 1/2"
- 1 Hoja de sierra semicircular de 3"
- 1 Rascador rígido de 2"
- 4 Lijas
- 1 Almohadilla para lijado
- 1 Llave hexagonal
- 1 Brida
- 1 Tornillo de 1/4" para fijación de accesorios
- 1 Maletín
- Garantía e instructivo con listado de centros de servicio.



· Incluye maleta con accesorios

191501

MODELO: MULTIPRO-300-AK

Garantía 1 Año

6



Caja a color

DISTRIB.	MAYOREO	LISTA
\$900.00	\$1,285.00	\$1,590.00

MOTO TOOL 140 W

APLICACIONES:

- Ideal para uso artesanal en taller o casa.



Incluye extensión tipo lápiz
Chicote flexible



Incluye soporte para mesa de trabajo

Profesional
AKSI

191511

Tensión / Frecuencia
Potencia
Corriente
Velocidad (sin carga)
∅ Disco
∅ Eje
Mordazas

120 V ~ 60 Hz
140 W
1.16 A
10 000 - 30 000 rev / min
24 mm
7.8 mm
1/8" (3.17 mm)

30 minutos de trabajo x 10 minutos de descanso. Máximo diario: 3 horas.



¿QUÉ INCLUYE MI HERRAMIENTA?

1 Set de accesorios
1 Par de carbones de repuesto
1 Soporte de mesa
1 Chicote flexible

1 Maletín
Garantía e instructivo con listado de centros de servicio.

Tiempo de operación

Ventajas de mi herramienta

- Velocidad variable.
- Incluye soporte con fijación que permite la colocación cerca del área de trabajo para hacer la herramienta más versátil.
- Incluye extensión flexible para su uso en conjunto con el soporte de fijación.

191511

MODELO: MULTIT-140p-AK

Garantía 1 Año

10



Maletín de plástico

NOM

DISTRIB.
\$610.00

MAYOREO
\$870.00

LISTA
\$1,075.00

ACCESORIOS PARA MOTO TOOL

JUEGO DE ACCESORIOS

CONTENIDO:

- 1 Adaptador de goma para barriles de lija
- 1 Adaptador de discos de corte
- 4 Barriles de lija
- 10 discos de corte
- 5 Puntas montadas
- 5 Puntas diamantadas
- 6 Brocas de alta velocidad
- 3 Cepillos
- 3 Mordazas de sujeción
- 1 Llave con desarmador plano



Maletín plástico

CÓDIGO			DISTRIB.	MAYOREO	LISTA
191571	6	36	\$135.00	\$195.00	\$240.00

JUEGO DE PIEDRAS MONTADAS

BLISTER:

- Ideal para desbaste, rebabeo, acabado de metales ferrosos y fundición
- Fabricadas en óxido de aluminio
- Rectificado de interiores



AKSI

CÓDIGO	CONTENIDO			DISTRIB.	MAYOREO	LISTA
110101	5 pzas.	6	36	\$40.00	\$57.00	\$71.00



máquinas
NEUMÁTICAS

► Llave de impacto . taladro . remachadora . matracca . esmeriladora . lijadora y más.



click ¡TIPS DE USO!

LLAVE DE IMPACTO

APLICACIONES:

- Ideal para ser usada en talleres mecánicos, industria manufacturera, siderúrgica, minera, agrícola, etc.
- Facilita la extracción y colocación de pernos y tuercas.



Cuadro de 1/2"

cód. 198021



Cuadro de 3/4"

cód. 198011



Cuadro de 1"

cód. 198002



Cuadro de 1 1/2"

cód. 198001



Profesional
AKSI

Profesional
AKSI

Profesional
AKSI

Profesional
AKSI

Carcasa de
ALUMINIO PULIDO

198021

Impulsor de cuadro	1/2" (12.7 mm)
Velocidad	7 500 RPM
Torque máximo	500 lb-ft (678 Nm)
Presión de trabajo	90-115 PSI (621-793 kPa)
Consumo de CFM	3.5 CFM (99 L / min)
Entrada de rosca	1/4" NPT
Niveles de torque	5
Peso sin accesorios	2.6 kg
Conector rápido recomendado	1/4" NPT x 3/8"

Tiempo de operación

Ventajas de mi herramienta



Trabajo continuo, siempre y cuando la máquina se encuentre lubricada.

- Mecanismo Twin Hammer.
- Carcasa de aluminio pulido.



Carcasa de
ALUMINIO PULIDO

198011

Impulsor de cuadro	3/4" (19.05 mm)
Velocidad	4 500 RPM
Torque máximo	664 lb-ft (900 Nm)
Presión de trabajo	90-115 PSI (621-793 kPa)
Consumo de CFM	8 CFM (226.5 L / min)
Entrada de rosca	3/8" NPT
Niveles de torque	3
Peso sin accesorios	4.8 kg
Conector rápido recomendado	3/8" NPT x 3/8"

Trabajo continuo, siempre y cuando la máquina se encuentre lubricada.

- Mecanismo Twin Hammer.
- Carcasa de aluminio pulido.



Carcasa de
ALUMINIO PULIDO

198002

Impulsor de cuadro	1" (25.4 mm)
Velocidad	4 200 RPM
Torque máximo	1328 lb-ft (1800 Nm)
Presión de trabajo	90-115 PSI (621-793 kPa)
Consumo de CFM	10 CFM (283.2 L / min)
Entrada de rosca	3/8" NPT
Niveles de torque	3
Peso sin accesorios	7.1 kg
Conector rápido recomendado	3/8" NPT x 1/2"

Trabajo continuo, siempre y cuando la máquina se encuentre lubricada.

- Mecanismo Twin Hammer.
- Carcasa de aluminio pulido.



Carcasa de
ALUMINIO PULIDO

198001

Impulsor de cuadro	1 1/2" (25.4 mm)
Velocidad	5 000 RPM
Torque máximo	1925 lb-ft (2610 Nm)
Presión de trabajo	90-115 PSI (621-793 kPa)
Consumo de CFM	10 CFM (283.2 L / min)
Entrada de rosca	1/2" NPT
Niveles de torque	3
Peso sin accesorios	13.6 kg
Conector rápido recomendado	1/2" NPT x 1/2"

Trabajo continuo, siempre y cuando la máquina se encuentre lubricada.

- Mecanismo Twin Hammer.
- Carcasa de aluminio pulido.



LUBRICACIÓN CONSTANTE

La herramienta requiere estar lubricada en todo momento para un óptimo funcionamiento.

¿QUÉ INCLUYE MI HERRAMIENTA?

1 Conector rápido de 3/8" a 3/8" NPT
Garantía e instructivo con listado de centros de servicio.

¿QUÉ INCLUYE MI HERRAMIENTA?

1 Conector rápido de 3/8" a 3/8" NPT
Garantía e instructivo con listado de centros de servicio.

¿QUÉ INCLUYE MI HERRAMIENTA?

1 Conector rápido de 3/8" a 3/8" NPT
Garantía e instructivo con listado de centros de servicio.

¿QUÉ INCLUYE MI HERRAMIENTA?

1 Conector rápido de 1/2" a 1/2" NPT
1 Llave hexagonal
Garantía e instructivo con listado de centros de servicio.

198021

Garantía 1 Año

4



Caja a color

DISTRIB.	MAYOREO	LISTA
\$1,350.00	\$1,930.00	\$2,380.00

198011

Garantía 1 Año

4



Caja a color

DISTRIB.	MAYOREO	LISTA
\$2,650.00	\$3,785.00	\$4,675.00

198002

Garantía 1 Año

4



Caja a color

DISTRIB.	MAYOREO	LISTA
\$3,750.00	\$5,355.00	\$6,615.00

198001

Garantía 1 Año

2



Caja a color

DISTRIB.	MAYOREO	LISTA
\$5,000.00	\$7,145.00	\$8,820.00

Enriquece tu herramienta con
ACCESORIOS neumáticos

PÁG. 313 - 315



LLAVE DE IMPACTO

APLICACIONES:

- Ideal para ser usada en talleres mecánicos, industria manufacturera, siderúrgica, minera, agrícola, etc.
- Facilita la extracción y colocación de pernos y tuercas.



Cuadro de 1/2"

cód. 198032



Cuadro de 1/2"

cód. 198031



Cuadro de 3/8"

cód. 198041



Carcasa de ALUMINIO PULIDO

198032 (kit)

Impulsor de cuadro	1/2" (12.7 mm)
Velocidad	7 000 RPM
Torque máximo	236 lb-ft (320 Nm)
Presión de trabajo	90-115 PSI (621-793 kPa)
Consumo de CFM	4 CFM (113 L / min)
Entrada de rosca	1/4" NPT
Niveles de torque	4
Peso sin accesorios	2.3 kg
Conector rápido recomendado	1/4" NPT x 3/8"

1/2" (12.7 mm)
7 000 RPM
236 lb-ft (320 Nm)
90-115 PSI (621-793 kPa)
4 CFM (113 L / min)
1/4" NPT
4
2.3 kg
1/4" NPT x 3/8"

Carcasa de ALUMINIO PULIDO

198031

1/2" (12.7 mm)
7 000 RPM
236 lb-ft (320 Nm)
90-115 PSI (621-793 kPa)
4 CFM (113 L / min)
1/4" NPT
4
2.3 kg
1/4" NPT x 3/8"

Carcasa de ALUMINIO PULIDO

198041

3/8" (9.5 mm)
10 000 RPM
75 lb-ft (101.6 Nm)
90-115 PSI (621-793 kPa)
2.5 CFM (70.8 L / min)
1/4" NPT
8
0.8 kg
1/4" NPT x 3/8"

Tiempo de operación

Trabajo continuo, siempre y cuando la máquina se encuentre lubricada.

Trabajo continuo, siempre y cuando la máquina se encuentre lubricada.

Trabajo continuo, siempre y cuando la máquina se encuentre lubricada.

Ventajas de mi herramienta

- Mecanismo Twin Hammer.
- Carcasa de aluminio pulido.

- Mecanismo Twin Hammer.
- Carcasa de aluminio pulido.

- Mecanismo Twin Hammer.
- Carcasa de aluminio pulido.



LUBRICACIÓN CONSTANTE

La herramienta requiere estar lubricada en todo momento para un óptimo funcionamiento.

¿QUÉ INCLUYE MI HERRAMIENTA?

- 1 Conector rápido de 3/8"-1/4" NPT.
 - 10 Dados de 9 a 27 mm.
 - 1 Extensión de 5".
 - 1 Dosificador de aceite.
 - 1 Llave hexagonal.
 - 1 Filtro.
- Garantía e instructivo con listado de centros de servicio.

¿QUÉ INCLUYE MI HERRAMIENTA?

- 1 Conector rápido de 3/8" a 1/4" NPT y garantía e instructivo con listado de centros de servicio.

¿QUÉ INCLUYE MI HERRAMIENTA?

- 1 Conector rápido de 3/8" a 1/4" NPT y garantía e instructivo con listado de centros de servicio.

Enríquece tu herramienta con **ACCESORIOS** neumáticos



PÁG. 313 - 315

198032

Garantía 1 Año



Caja a color

DISTRIB.	MAYOREO	LISTA
\$1,100.00	\$1,570.00	\$1,940.00

198031

Garantía 1 Año



Caja a color

DISTRIB.	MAYOREO	LISTA
\$690.00	\$985.00	\$1,215.00

198041

Garantía 1 Año



Caja a color

DISTRIB.	MAYOREO	LISTA
\$560.00	\$800.00	\$990.00

TALADRO REVERSIBLE

APLICACIONES:

- Diseñado para barrenar, rectificar, escariar y cepillar.



500 RPM - 1/2"

cód. 198102



1 100 RPM - 3/8"

cód. 198111



500 RPM - 1/2"

cód. 198112



Profesional
AKSI

Semi PRO
AKSI

Semi PRO
AKSI

Carcasa de
ALUMINIO PULIDO



TALADRO
REVERSIBLE

198102

Broquero	1/2" (1.5 mm - 13 mm)
Velocidad	500 RPM
Presión de trabajo	90-115 PSI (621-793 kPa)
Consumo de CFM	4 CFM (113 L / min)
Entrada de rosca	1/4" NPT
Peso sin accesorios	1.6 kg
Conector rápido recomendado	1/4" NPT x 1/4"

Capacidad de perforación

Madera	1/2"
Metal	3/8"

Tiempo de operación

Ventajas de mi herramienta

Trabajo continuo, siempre y cuando la máquina se encuentre lubricada.

- Carcasa de aluminio pulido.



Carcasa de
ALUMINIO PULIDO



TALADRO
REVERSIBLE

198111

Broquero	3/8" (9.5 mm)
Velocidad	1 100 RPM
Presión de trabajo	90-115 PSI (621-793 kPa)
Consumo de CFM	4 CFM (113 L / min)
Entrada de rosca	1/4" NPT
Peso sin accesorios	1.2 kg
Conector rápido recomendado	1/4" NPT x 1/4"

Madera	3/8"
Metal	5/16"

Trabajo continuo, siempre y cuando la máquina se encuentre lubricada.

- Carcasa de aluminio pulido.



Carcasa de
ALUMINIO PULIDO



TALADRO
REVERSIBLE

198112

Broquero	1/2" (1.5 mm - 13 mm)
Velocidad	500 RPM
Presión de trabajo	90-115 PSI (621-793 kPa)
Consumo de CFM	4 CFM (113 L / min)
Entrada de rosca	1/4" NPT
Peso sin accesorios	1.6 kg
Conector rápido recomendado	1/4" NPT x 1/4"

Madera	1/2"
Metal	3/8"

Trabajo continuo, siempre y cuando la máquina se encuentre lubricada.

- Carcasa de aluminio pulido.



LUBRICACIÓN CONSTANTE

La herramienta requiere estar lubricada en todo momento para un óptimo funcionamiento.

¿QUÉ INCLUYE MI HERRAMIENTA?

1 Conector rápido de 3/8" a 1/4" NPT,
1 Llave para broquero,
1 Manija desmontable
Garantía e instructivo con listado de centros de servicio.

¿QUÉ INCLUYE MI HERRAMIENTA?

1 Conector rápido de 3/8" a 1/4" NPT,
1 Llave para broquero,
1 Manija desmontable
Garantía e instructivo con listado de centros de servicio.

¿QUÉ INCLUYE MI HERRAMIENTA?

1 Conector rápido de 3/8" a 1/4" NPT,
1 Llave para broquero,
1 Manija desmontable
Garantía e instructivo con listado de centros de servicio.

Enriquece tu herramienta con
ACCESORIOS neumáticos

PÁG. 313 - 315



198102

Garantía 1 Año



Caja a color

DISTRIB.	MAYOREO	LISTA
\$1,150.00	\$1,645.00	\$2,030.00

198111

Garantía 1 Año



Caja a color

DISTRIB.	MAYOREO	LISTA
\$530.00	\$755.00	\$935.00

198112

Garantía 1 Año



Caja a color

DISTRIB.	MAYOREO	LISTA
\$830.00	\$1,185.00	\$1,465.00

REMACHADORA

APLICACIONES:

- Ideal para cancelería de aluminio, talleres de hojalatería y carroceros.



Remache de 1/4" □

cód. 198502



Sistema auxiliar de vacío

Remache de 3/16" □

cód. 198511



Contenedor de residuos

Remache de 1/4" □

cód. 198512



Contenedor de residuos

Profesional
AKSI

Semi PRO
AKSI

Semi PRO
AKSI

MORDAZA DE AGERO
Mayor resistencia al desgaste

MORDAZA DE AGERO
Mayor resistencia al desgaste

MORDAZA DE AGERO
Mayor resistencia al desgaste

198502

Tipo de remache	Ciego
Capacidad de remache	3/32" a 1/4"
Presión de aire	90-115 PSI (621-793 kPa)
Consumo de CFM	3.5 CFM (99 L / min)
Fuerza de tracción	1410 kgF
Entrada de rosca	1/4" NPT
Peso	1.7 kg
Conector rápido recomendado	1/4" NPT x 3/8"

Ciego
3/32" a 1/4"
90-115 PSI (621-793 kPa)
3.5 CFM (99 L / min)
1410 kgF
1/4" NPT
1.7 kg
1/4" NPT x 3/8"

BOQUILLAS INCLUIDAS

· 3/32" (2.4 mm) · 1/8" (3.2 mm)
· 3/16" (4.8 mm) · 1/4" (6.4 mm)

Tiempo de operación

Trabajo continuo, siempre y cuando la máquina se encuentre lubricada.

Ventajas de mi herramienta

- Mordazas de acero para mayor resistencia al desgaste.

198511

Ciego
3/32" a 3/16"
90-115 PSI (621-793 kPa)
3.5 CFM (99 L / min)
885 kgF
1/4" NPT
1.7 kg
1/4" NPT x 3/8"

· 3/32" (2.4 mm) · 1/8" (3.2 mm)
· 5/32" (4 mm) · 3/16" (4.8 mm)

Trabajo continuo, siempre y cuando la máquina se encuentre lubricada.

- Mordazas de acero para mayor resistencia al desgaste.

198512

Ciego
3/32" a 1/4"
90-115 PSI (621-793 kPa)
3.5 CFM (99 L / min)
1410 kgF
1/4" NPT
1.7 kg
1/4" NPT x 3/8"

· 1/8" (3.2 mm) · 5/32" (4 mm)
· 3/16" (4.8 mm) · 1/4" (6.4 mm)

Trabajo continuo, siempre y cuando la máquina se encuentre lubricada.

- Mordazas de acero para mayor resistencia al desgaste.



! ¿QUÉ INCLUYE MI HERRAMIENTA?

2 Llaves, 1 contenedor de residuos, 2 juegos de mordazas, 4 boquillas y garantía e instructivo con listado de centros de servicio.

! ¿QUÉ INCLUYE MI HERRAMIENTA?

2 Llaves, 1 contenedor de residuos, 2 juegos de mordazas, 4 boquillas y garantía e instructivo con listado de centros de servicio.

! ¿QUÉ INCLUYE MI HERRAMIENTA?

2 Llaves, 1 contenedor de residuos, 2 juegos de mordazas, 4 boquillas y garantía e instructivo con listado de centros de servicio.

LUBRICACIÓN CONSTANTE

La herramienta requiere estar lubricada en todo momento para un óptimo funcionamiento.

Enriquece tu herramienta con **ACCESORIOS** neumáticos

PÁG. 313 - 315



198502

Garantía 1 Año

4



Caja a color

DISTRIB.	MAYOREO	LISTA
\$2,200.00	\$3,145.00	\$3,880.00



198511

Garantía 1 Año

4



Caja a color

DISTRIB.	MAYOREO	LISTA
\$1,200.00	\$1,715.00	\$2,115.00



198512

Garantía 1 Año

4



Caja a color

DISTRIB.	MAYOREO	LISTA
\$1,250.00	\$1,785.00	\$2,205.00

MATRACA

APLICACIONES:

- Ideal para trabajar en áreas de difícil acceso.
- Válvula de reversa para fáciles cambios de dirección.



150 RPM **3/8"**

cód. 198201



150 RPM **1/2"**

cód. 198202



Semi PRO
AKSI

Semi PRO
AKSI

Carcasa de
ALUMINIO PULIDO

198201

Impulsor de cuadro	3/8" (9.5 mm)
Velocidad	150 RPM
Torque máximo	50 lb-ft (67.79 Nm)
Presión de trabajo	90-115 PSI (621-793 kPa)
Consumo de CFM	3 CFM (85 L / min)
Entrada de rosca	1/4" NPT
Desalojo de aire	Frontal
Peso sin accesorios	0.5 kg
Conector rápido recomendado	1/4" NPT x 1/2"

Trabajo continuo, siempre y cuando la máquina se encuentre lubricada.

- Carcasa de aluminio pulido.
- Estructura reforzada.
- Liberación de aire frontal.



¿QUÉ INCLUYE MI HERRAMIENTA?

1 Conector rápido de 3/8" a 1/4" NPT
Garantía e instructivo con listado de centros de servicio.

198201

Garantía 1 Año

4



Caja a color

DISTRIB.	MAYOREO	LISTA
\$475.00	\$680.00	\$840.00

Carcasa de
ALUMINIO PULIDO

198202

Impulsor de cuadro	1/2" (12.7 mm)
Velocidad	150 RPM
Torque máximo	50 lb-ft (67.79 Nm)
Presión de trabajo	90-115 PSI (621-793 kPa)
Consumo de CFM	3 CFM (85 L / min)
Entrada de rosca	1/4" NPT
Desalojo de aire	Frontal
Peso sin accesorios	0.5 kg
Conector rápido recomendado	1/4" NPT x 1/2"

Trabajo continuo, siempre y cuando la máquina se encuentre lubricada.

- Carcasa de aluminio pulido.
- Estructura reforzada.
- Liberación de aire frontal.



¿QUÉ INCLUYE MI HERRAMIENTA?

1 Conector rápido de 3/8" a 1/4" NPT
Garantía e instructivo con listado de centros de servicio.

198202

Garantía 1 Año

4



Caja a color

DISTRIB.	MAYOREO	LISTA
\$475.00	\$680.00	\$840.00

Impulsor de cuadro	3/8" (9.5 mm)
Velocidad	150 RPM
Torque máximo	50 lb-ft (67.79 Nm)
Presión de trabajo	90-115 PSI (621-793 kPa)
Consumo de CFM	3 CFM (85 L / min)
Entrada de rosca	1/4" NPT
Desalojo de aire	Frontal
Peso sin accesorios	0.5 kg
Conector rápido recomendado	1/4" NPT x 1/2"

Tiempo de operación

Ventajas de mi herramienta



LUBRICACIÓN CONSTANTE

La herramienta requiere estar lubricada en todo momento para un óptimo funcionamiento.

Enriquece tu herramienta con **ACCESORIOS** neumáticos

PÁG. 313 - 315



MINI ESMERILADORA

APLICACIONES:

- Ideal para pulir, desbastar y cortar en materiales como: porcelana, yeso, acrílico y algunos plásticos (PLA, PET, PP, PVC y baquelita).
- Tamaño compacto, permite su uso en áreas de difícil acceso.



Entrada de 1/4"

cód. 198302



Incluye estuche plástico

Entrada de 1/4"

cód. 198301



Entrada de 1/4"

cód. 198311



Semi PRO
AKSI

Semi PRO
AKSI

Semi PRO
AKSI

Carcasa de ALUMINIO PULIDO

Carcasa de ALUMINIO PULIDO

Carcasa de ALUMINIO PULIDO

198302 (kit)

Velocidad	25 000 RPM
Presión de aire	90-115 PSI (621-793 kPa)
Consumo de CFM	2.5 CFM (70.8 L / min)
Entrada de rosca	1/4" NPT
Peso sin accesorios	0.3 kg
Conector rápido recomendado	1/4" NPT x 1/4"

Trabajo continuo, siempre y cuando la máquina se encuentre lubricada.

- Carcasa de aluminio pulido.
- Diseño compacto y ligero.



198301

Velocidad	25 000 RPM
Presión de aire	90-115 PSI (621-793 kPa)
Consumo de CFM	2.5 CFM (70.8 L / min)
Entrada de rosca	1/4" NPT
Peso sin accesorios	0.3 kg
Conector rápido recomendado	1/4" NPT x 1/4"

Trabajo continuo, siempre y cuando la máquina se encuentre lubricada.

- Carcasa de aluminio pulido.
- Diseño compacto y ligero.



198311

Velocidad	20 000 RPM
Presión de aire	90-115 PSI (621-793 kPa)
Consumo de CFM	2.5 CFM (70.8 L / min)
Entrada de rosca	1/4" NPT
Peso sin accesorios	0.6 kg
Conector rápido recomendado	1/4" NPT x 1/4"

Trabajo continuo, siempre y cuando la máquina se encuentre lubricada.

- Carcasa de aluminio pulido.
- Diseño compacto y ligero.



Velocidad	25 000 RPM
Presión de aire	90-115 PSI (621-793 kPa)
Consumo de CFM	2.5 CFM (70.8 L / min)
Entrada de rosca	1/4" NPT
Peso sin accesorios	0.3 kg
Conector rápido recomendado	1/4" NPT x 1/4"

Tiempo de operación

Ventajas de mi herramienta



LUBRICACIÓN CONSTANTE

La herramienta requiere estar lubricada en todo momento para un óptimo funcionamiento.

¿QUÉ INCLUYE MI HERRAMIENTA?

1 Conector rápido de 1/4" a 1/4" NPT
1 Collets de 1/4" - 1/8"
5 Piedras montadas de 1/4" de zanco
5 Piedras montadas de 1/8" de zanco
1 Llave de 7/16" y 1 llave de 11/16"
Garantía e instructivo con listado de centros de servicio.

¿QUÉ INCLUYE MI HERRAMIENTA?

1 Conector rápido de 1/4" a 1/4" NPT
2 llaves: 7/16" - 11/16"
Garantía e instructivo con listado de centros de servicio.

¿QUÉ INCLUYE MI HERRAMIENTA?

1 Conector rápido de 3/8" a 1/4" NPT
2 llaves: 7/16" - 11/16"
Garantía e instructivo con listado de centros de servicio.

198302

Garantía 1 Año
4
Caja a color
DISTRIB. \$500.00
MAYOREO \$715.00
LISTA \$880.00

198301

Garantía 1 Año
4
Caja a color
DISTRIB. \$295.00
MAYOREO \$420.00
LISTA \$520.00

198311

Garantía 1 Año
4
Caja a color
DISTRIB. \$495.00
MAYOREO \$705.00
LISTA \$875.00

Enrique tu herramienta con ACCESORIOS neumáticos



PÁG. 313 - 315

ESMERIL RECTO

Corte de 3"

APLICACIONES:

- Ideal para uso en materiales ligeros y flexibles como láminas, fibra de vidrio y algunos perfiles metálicos (sección cuadrada, circular y escuadra).
- Perfecta para hojalatería semiprofesional o casera, y estética automotriz.
- Diseñados para uso continuo.

INCLUYE DISCO PARA CORTE DE 3"



USA DISCO DE CORTE



Semi PRO
AKSI

Clavadora

Calibre 18

APLICACIONES:

- Uso profesional en madera
- Ideal para trabajos de ensamblaje en serie

Calibre 18

cód. 198601



Profesional
AKSI

Carcasa de
ALUMINIO PULIDO

198321

Velocidad	18 000 RPM
Presión de aire	90-115 PSI (621-793 kPa)
Consumo de CFM	2.5 CFM (70.8 L / min)
Entrada de rosca	1/4" NPT
Ø de disco externo	3" (76.2 mm)
Ø de disco	3/8" (10 mm)
Peso sin accesorios	0.6 kg
Conector rápido recomendado	1/4" NPT x 1/4"

Velocidad	18 000 RPM
Presión de aire	90-115 PSI (621-793 kPa)
Consumo de CFM	2.5 CFM (70.8 L / min)
Entrada de rosca	1/4" NPT
Ø de disco externo	3" (76.2 mm)
Ø de disco	3/8" (10 mm)
Peso sin accesorios	0.6 kg
Conector rápido recomendado	1/4" NPT x 1/4"

Trabajo continuo, siempre y cuando la máquina se encuentre lubricada.

Tiempo de operación

Ventajas de mi herramienta

- Carcasa de aluminio pulido.



¿QUÉ INCLUYE MI HERRAMIENTA?

- 1 Conector rápido de 3/8" a 1/4" NPT
- 1 llave hexagonal 3/16"
- 1 llave 9/16"
- 1 disco de corte de 3"
- Garantía e instructivo con listado de centros de servicio.

LUBRICACIÓN CONSTANTE

La herramienta requiere estar lubricada en todo momento para un óptimo funcionamiento.

Enriquece tu herramienta con **ACCESORIOS** neumáticos

PÁG. 313 - 315



198321

Garantía 1 Año

4



Caja a color

DISTRIB.	MAYOREO	LISTA
\$315.00	\$450.00	\$555.00

Carcasa de
ALUMINIO PULIDO

198601

Presión de aire	75-110 PSI (517 - 758 kPa)
Consumo de CFM	2.1 CFM (59 L / min)
Entrada de rosca	1/4" NPT
Ø interno de manguera	3/8" (9.5 mm)
Capacidad de catucho	100 clavos
Medida de largo de clavo	5/8" 3/4" 1" 1 3/16" 1 1/4" 1 3/8" 1 5/8" 1 3/4" 2"
Calibre de clavo	18 (1.2 mm)
Peso	1.5 kg
Conector rápido recomendado	1/4" NPT x 3/8"

Presión de aire	75-110 PSI (517 - 758 kPa)
Consumo de CFM	2.1 CFM (59 L / min)
Entrada de rosca	1/4" NPT
Ø interno de manguera	3/8" (9.5 mm)
Capacidad de catucho	100 clavos
Medida de largo de clavo	5/8" 3/4" 1" 1 3/16" 1 1/4" 1 3/8" 1 5/8" 1 3/4" 2"
Calibre de clavo	18 (1.2 mm)
Peso	1.5 kg
Conector rápido recomendado	1/4" NPT x 3/8"

Tiempo de operación

Ventajas de mi herramienta

Trabajo continuo, siempre y cuando la máquina se encuentre lubricada.

- Sistema de liberación de cambio rápido
- Válvula móvil para direccionar la salida de aire
- Carcasa de aluminio pulido.



LUBRICACIÓN CONSTANTE

La herramienta requiere estar lubricada en todo momento para un óptimo funcionamiento.

¿QUÉ INCLUYE MI HERRAMIENTA?

- 1 Conector rápido de 1/4" NPT
- 1 llave allen 3 mm
- 1 llave allen 4 mm
- Garantía e instructivo con listado de centros de servicio.

198601

Garantía 1 Año

1



Caja a color

DISTRIB.	MAYOREO	LISTA
\$670.00	\$955.00	\$1,180.00

LIJADORA ORBITAL 5" y 6"

APLICACIONES:

- Ideal para utilizar con lijas de 5 ó 6 pulgadas.
- Para trabajos en madera y metal.
- Sistema Randon orbit, elimina el patrón circular en el acabado del material.



Profesional
AKSI

Semi.PRO
AKSI

Carcasa de
ALUMINIO PULIDO

Carcasa de
ALUMINIO PULIDO

198401

198411

Ø del pad	
Velocidad	
Presión de aire	
Consumo de CFM	
Entrada de rosca	
Succión	
Peso	
Conector rápido recomendado	

6" (152.4 mm)
10 000 - 12 000 RPM
90-115 PSI (621-793 kPa)
2.5 CFM (70.8 L / min)
1/4" NPT
Trasera
0.8 kg
1/4" NPT x 1/4"

5" (127 mm)
10 000 - 12 000 RPM
90-115 PSI (621-793 kPa)
2.5 CFM (70.8 L / min)
1/4" NPT
Trasera
1 kg
1/4" NPT x 1/4"

Tiempo de operación

Trabajo continuo, siempre y cuando la máquina se encuentre lubricada.

Trabajo continuo, siempre y cuando la máquina se encuentre lubricada.

Ventajas de mi herramienta

- Diseño compacto y ligero.
- Estructura reforzada para mayor resistencia.
- Cuerpo ergonómico.
- Alta velocidad y bajo ruido.
- Bajo consumo de aire.
- Diseñados para uso continuo.

- Diseño compacto y ligero.
- Estructura reforzada para mayor resistencia.
- Cuerpo ergonómico.
- Alta velocidad y bajo ruido.
- Bajo consumo de aire.
- Diseñados para uso continuo.



LUBRICACIÓN CONSTANTE

La herramienta requiere estar lubricada en todo momento para un óptimo funcionamiento.

¿QUÉ INCLUYE MI HERRAMIENTA?

- 1 Conector rápido de 3/8" a 1/4" NPT
- 1 Manguera
- 1 Recolector de polvo
- 1 Llave para el pad
- Garantía e instructivo con listado de centros de servicio.

¿QUÉ INCLUYE MI HERRAMIENTA?

- 1 Conector rápido de 3/8" a 1/4" NPT
- 1 Manguera
- 1 Recolector de polvo
- 1 Llave para el pad
- Garantía e instructivo con listado de centros de servicio.

Enriquece tu herramienta con **ACCESORIOS** neumáticos

PÁG. 313 - 315



198401

Garantía 1 Año

4



Caja a color

DISTRIB.	MAYOREO	LISTA
\$1,450.00	\$2,070.00	\$2,560.00

198411

Garantía 1 Año

4



Caja a color

DISTRIB.	MAYOREO	LISTA
\$1,000.00	\$1,430.00	\$1,765.00

NEUMÁTICA

ACCESORIOS



► Conectores . coples . infladores . mangueras . válvulas . etc.

Manómetro de presión, 200 PSI

PROX.

CAJA

- Cuerda 1/4" NPT
- 200 PSI



CÓDIGO			DISTRIB.	MAYOREO	LISTA
113009	10	100	\$50.00	\$71.00	\$88.00

Cabeza de latón para inflar hembra

PROX.

BLÍSTER

- Cuerda 1/4" NPT
- Fabricada en latón
- Compatible con válvulas americanas tipo Schrader



CÓDIGO			DISTRIB.	MAYOREO	LISTA
113010	12	144	\$28.00	\$40.00	\$49.00

Conector rápido de acero cromado macho y hembra

BLÍSTER

- Cuerda 1/4" NPT



306404

306403



CÓDIGO	TIPO			DISTRIB.	MAYOREO	LISTA
306403	Hembra	12	144	\$11.00	\$15.70	\$19.40
306404	Macho	12	144	\$11.00	\$15.70	\$19.40

Cople rápido de acero cromado hembra

BLÍSTER

- Cuerda 1/4" NPT



CÓDIGO			DISTRIB.	MAYOREO	LISTA
306407	12	144	\$38.00	\$54.00	\$67.00

Cople de acero cromado hembra-hembra

BLÍSTER

- Cuerda 1/4" NPT



CÓDIGO			DISTRIB.	MAYOREO	LISTA
306408	12	144	\$11.00	\$15.70	\$19.40

Niple de acero cromado macho-macho

BLÍSTER

- Cuerda 1/4" NPT



CÓDIGO			DISTRIB.	MAYOREO	LISTA
306406	12	144	\$11.00	\$15.70	\$19.40

Cople rápido de acero cromado macho y hembra

BLÍSTER

► Cuerda 1/4" NPT



18
meses
GARANTÍA

IT MAXTOOL

CÓDIGO	TIPO			DISTRIB.	MAYOREO	LISTA
306409	Hembra	12	144	\$32.00	\$46.00	\$56.00
306410	Macho	12	144	\$32.00	\$46.00	\$56.00

Juego de cople macho y conectores rápidos de acero cromado, 5 piezas

BLÍSTER

► Cuerda 1/4" NPT



18
meses
GARANTÍA

IT MAXTOOL

CONTENIDO						
1 Cople rápido tipo macho 3 Conectores rápidos tipo macho 1 Conector rápido tipo hembra						
CÓDIGO			DISTRIB.	MAYOREO	LISTA	
306405	12	72	\$55.00	\$79.00	\$97.00	

Juego de cople hembra y conectores rápidos de acero cromado, 5 piezas

BLÍSTER

► Cuerda 1/4" NPT



18
meses
GARANTÍA

IT MAXTOOL

CONTENIDO						
1 Cople rápido tipo hembra 3 Conectores rápidos tipo macho 1 Conector rápido tipo hembra						
CÓDIGO			DISTRIB.	MAYOREO	LISTA	
306402	12	72	\$60.00	\$86.00	\$106.00	

Juego de accesorios neumáticos para limpiar e inflar

BLÍSTER

► Cuerda 1/4" NPT



CONTENIDO

- 1 Pistola para sopletear
- 2 Conectores rápidos tipo macho 1/4"
- 2 Coples rápidos tipo hembra 1/4"
- 2 Conectores rápidos tipo hembra 1/4"
- 1 Inflador para neumáticos cabeza sencilla
- 1 Boquilla con cubierta plástica
- 1 Niple universal
- 1 Cople universal 1/4
- 1 Válvula para inflar balones
- 1 Reductor para válvula
- 1 Manguera tipo resorte de 7.5m

10
años
GARANTÍA

AKSI

CÓDIGO			DISTRIB.	MAYOREO	LISTA
113004	4	24	\$335.00	\$480.00	\$590.00

Juego de accesorios neumáticos para limpiar e inflar

BLÍSTER

► Cuerda 1/4" NPT



CONTENIDO

- 1 Pistola para sopletear
- 2 Conectores rápidos tipo macho 1/4"
- 2 Coples rápidos tipo hembra 1/4"
- 2 Conectores rápidos tipo hembra 1/4"
- 1 Inflador para neumáticos cabeza sencilla
- 1 Boquilla con cubierta plástica
- 1 Niple universal
- 1 Cople universal 1/4
- 1 Válvula para inflar balones
- 1 Reductor para válvula
- 1 Manguera tipo resorte de 7.5m

18
meses
GARANTÍA

IT MAXTOOL

CÓDIGO			DISTRIB.	MAYOREO	LISTA
306411	6	24	\$250.00	\$355.00	\$440.00

Juego de coples y conectores rápidos de acero cromado, 4 piezas

BLÍSTER

► Cuerda 1/4" NPT



18
meses
GARANTÍA

IT MAXTOOL

CONTENIDO						
1 Conector rápido tipo macho 1 Conector rápido tipo hembra 1 Cople rápido tipo macho 1 Cople rápido tipo hembra						
CÓDIGO			DISTRIB.	MAYOREO	LISTA	
306401	12	72	\$70.00	\$100.00	\$123.00	

Juego de accesorios neumáticos para limpiar, inflar y calibrar

BLÍSTER

► Cuerda 1/4" NPT

- CONTENIDO**
- 1 Pistola para sopletear
 - 1 Inflador para neumáticos doble cabeza
 - 2 Niple tipo macho de 1/4"
 - 1 Adaptador para válvula
 - 1 Boquilla de punta de alta presión
 - 1 Cople rápido tipo hembra
 - 2 Conectores rápidos tipo hembra
 - 4 Conectores rápidos tipo macho
 - 1 Medidor de presión
 - 1 Inflador punta espiga
 - 1 Válvula para inflar balones
 - 1 Cople rápido tipo hembra 1/4"



CÓDIGO			DISTRIB.	MAYOREO	LISTA
113005	6	24	\$280.00	\$400.00	\$495.00

Juego de accesorios neumáticos para limpiar, inflar y calibrar

BLÍSTER

► Cuerda 1/4" NPT

- CONTENIDO**
- 1 Pistola para sopletear
 - 1 Inflador para neumáticos doble cabeza
 - 2 Niple tipo macho de 1/4"
 - 1 Adaptador para válvula
 - 1 Boquilla de punta de alta presión
 - 1 Cople rápido tipo hembra
 - 2 Conectores rápidos tipo hembra
 - 4 Conectores rápidos tipo macho
 - 1 Medidor de presión
 - 1 Inflador punta espiga
 - 1 Válvula para inflar balones
 - 1 Cople rápido tipo hembra 1/4"



CÓDIGO			DISTRIB.	MAYOREO	LISTA
306412	6	24	\$195.00	\$280.00	\$345.00

Cople rápido tipo hembra

BLÍSTER

► Cuerda 1/4" NPT



CÓDIGO			DISTRIB.	MAYOREO	LISTA
113006	12	144	\$55.00	\$79.00	\$97.00

Filtro separador de agua y aceite

BLÍSTER

► Cuerda 1/4" NPT
► Cuerpo de aluminio y policarbonato
► Presión máxima 120 PSI



CÓDIGO			DISTRIB.	MAYOREO	LISTA
113007	6	24	\$85.00	\$121.00	\$150.00

Manguera tipo resorte

CABALLETE

► Cuerda 1/4" NPT



CÓDIGO	MEDIDA		DISTRIB.	MAYOREO	LISTA
113002	1/4" x 25 ft	20	\$70.00	\$100.00	\$123.00
113003	1/4" x 50 ft	20	\$110.00	\$155.00	\$195.00

Inflador de cabeza doble

BLÍSTER

► Cuerda 1/4" NPT
► Tubo y conector fabricado en acero
► Cabeza de aleación metálica



CÓDIGO			DISTRIB.	MAYOREO	LISTA
306413	6	48	\$37.00	\$53.00	\$65.00

Pistola metálica para sopletear

BLÍSTER

► Cuerda 1/4" NPT
► Incluye boquilla y adaptador para válvula
► Cuerpo de aleación metálica



CÓDIGO			DISTRIB.	MAYOREO	LISTA
113001	6	36	\$48.00	\$69.00	\$85.00

Pistola metálica para sopletear con 5 boquillas

BLÍSTER

► Cuerda 1/4" NPT
► Incluye:
3 Boquillas con extensión
1 Boquillas sin extensión
1 Boquilla cónica plástica



CÓDIGO			DISTRIB.	MAYOREO	LISTA
113008	6	36	\$70.00	\$100.00	\$123.00



PROX. ●

CÓDIGO	USO	PRESENTACIÓN	DISTRIB.	MAYOREO	LISTA
679101	Shampoo para mascotas . lavanda-manzanilla	500 ml	\$59.00	\$84.00	\$104.00
679102	Shampoo para mascotas . avena-coco	500 ml	\$59.00	\$84.00	\$104.00
679201	Perfume para mascotas	500 ml	\$59.00	\$84.00	\$104.00
679301	Repelente de orina para mascotas	500 ml	\$55.00	\$79.00	\$97.00
679302	Atrayente de orina para mascotas	500 ml	\$55.00	\$79.00	\$97.00
679303	Eliminador de olores	1 litro	\$115.00	\$165.00	\$205.00

Tamaño

	Ø Externo	Ø Interno	Alto
CHICO	50 cm	12 cm	5 cm
MEDIANO	60 cm	14.5 cm	6 cm
GRANDE	70 cm	18 cm	7 cm

VISTA SUPERIOR

BASE ANTIDERRAPANTE

Cama antiestrés

PROX.

- ▶ Tejido de felpa muy suave
- ▶ Bordes elevados que ayudan reducir la ansiedad de tu mascota
- ▶ Se puede lavar en lavadora sin sufrir deformaciones



CÓDIGO	TALLA	COLOR	DISTRIB.	MAYOREO	LISTA
600001	Chica	Coral	6	\$250.00	\$355.00 \$440.00
600011	Chica	Aqua	6	\$250.00	\$355.00 \$440.00
600021	Chica	Marrón	6	\$250.00	\$355.00 \$440.00
600031	Chica	Gris	6	\$250.00	\$355.00 \$440.00

CÓDIGO	TALLA	COLOR	DISTRIB.	MAYOREO	LISTA
600002	Mediana	Coral	6	\$320.00	\$455.00 \$565.00
600012	Mediana	Aqua	6	\$320.00	\$455.00 \$565.00
600022	Mediana	Marrón	6	\$320.00	\$455.00 \$565.00
600032	Mediana	Gris	6	\$320.00	\$455.00 \$565.00

CÓDIGO	TALLA	COLOR	DISTRIB.	MAYOREO	LISTA
600003	Grande	Coral	6	\$400.00	\$570.00 \$705.00
600013	Grande	Aqua	6	\$400.00	\$570.00 \$705.00
600023	Grande	Marrón	6	\$400.00	\$570.00 \$705.00
600033	Grande	Gris	6	\$400.00	\$570.00 \$705.00

Tamaño

	Ancho	Base	Alto
CHICO	50 cm	40 cm	12 cm
MEDIANO	60 cm	45 cm	14 cm
GRANDE	70 cm	55 cm	16 cm

VISTA SUPERIOR

BASE ANTIDERRAPANTE

Cama doble vista

PROX.

- ▶ Costuras invisibles, lo que permite volverla reversible
- ▶ Se puede lavar en lavadora sin sufrir deformaciones
- ▶ Fabricada en textiles resistentes y transpirables



CÓDIGO	TALLA	COLOR	DISTRIB.	MAYOREO	LISTA
600401	Chica	Azul	6	\$300.00	\$430.00 \$530.00
600601	Chica	Rosa	6	\$300.00	\$430.00 \$530.00
600801	Chica	Crema	6	\$300.00	\$430.00 \$530.00

CÓDIGO	TALLA	COLOR	DISTRIB.	MAYOREO	LISTA
600402	Mediana	Azul	6	\$350.00	\$500.00 \$615.00
600602	Mediana	Rosa	6	\$350.00	\$500.00 \$615.00
600802	Mediana	Crema	6	\$350.00	\$500.00 \$615.00

CÓDIGO	TALLA	COLOR	DISTRIB.	MAYOREO	LISTA
600403	Grande	Azul	6	\$430.00	\$615.00 \$760.00
600603	Grande	Rosa	6	\$430.00	\$615.00 \$760.00
600803	Grande	Crema	6	\$430.00	\$615.00 \$760.00

Tamaño			
	ANCHO	BASE	ALTO
CHICO	50 cm	40 cm	6 cm
MEDIANO	60 cm	45 cm	8 cm
GRANDE	70 cm	55 cm	10 cm

Cama rectangular

PROX.

- ▶ Tejido suave al tacto
- ▶ Se puede lavar en lavadora sin sufrir deformaciones
- ▶ Ligera y portátil



Petit®

CÓDIGO	TALLA	COLOR	DISTRIB.	MAYOREO	LISTA
600201	Chica	Gris	20	\$150.00	\$215.00 \$265.00
600211	Chica	Marrón	20	\$150.00	\$215.00 \$265.00
600221	Chica	Negro	20	\$150.00	\$215.00 \$265.00

CÓDIGO	TALLA	COLOR	DISTRIB.	MAYOREO	LISTA
600202	Mediana	Gris	20	\$200.00	\$285.00 \$355.00
600212	Mediana	Marrón	20	\$200.00	\$285.00 \$355.00
600222	Mediana	Negro	20	\$200.00	\$285.00 \$355.00

CÓDIGO	TALLA	COLOR	DISTRIB.	MAYOREO	LISTA
600203	Grande	Gris	20	\$250.00	\$355.00 \$440.00
600213	Grande	Marrón	20	\$250.00	\$355.00 \$440.00
600223	Grande	Negro	20	\$250.00	\$355.00 \$440.00

Tamaño			
	ANCHO	BASE	ALTO
MEDIANO	60 cm	80 cm	6 cm
GRANDE	80 cm	100 cm	7 cm

Colchoneta

PROX.

- ▶ Colchoneta multiusos
- ▶ Fácil de transportar
- ▶ Se puede lavar en lavadora



VISTA SUPERIOR



BASE ANTIDERRAPANTE



Petit®

CÓDIGO	TALLA	COLOR	DISTRIB.	MAYOREO	LISTA
608001	Mediana	Blanco - rosa - rojo	10	\$195.00	\$280.00 \$345.00
608011	Mediana	Negro - huesitos y huellitas	10	\$195.00	\$280.00 \$345.00

CÓDIGO	TALLA	COLOR	DISTRIB.	MAYOREO	LISTA
608002	Grande	Blanco - rosa - rojo	10	\$300.00	\$430.00 \$530.00
608012	Grande	Negro - huesitos y huellitas	10	\$300.00	\$430.00 \$530.00

Tamaño				
	ALTO	ANCHO	LARGO	HASTA
24"	50 cm	43.5 cm	62 cm	-- kg
30"	55 cm	48 cm	78 cm	-- kg
36"	63 cm	57 cm	92 cm	-- kg
42"	79 cm	71.5 cm	107 cm	-- kg
48"	84 cm	76 cm	122 cm	-- kg

Jaula de alambre

PROX.

- ▶ Fabricada con estructura de acero
- ▶ Diseño plegable
- ▶ Ideal para viaje en automovil
- ▶ Se puede usar para diversas mascotas (perro, gato, animales de corral, etc.)



Petit®

CÓDIGO	MEDIDA Largo x Ancho x Alto	DISTRIB.	MAYOREO	LISTA
609001	24" (62 x 43.5 x 50 cm)	1	\$570.00	\$815.00 \$1,005.00
609002	30" (78 x 48 x 55 cm)	1	\$710.00	\$1,015.00 \$1,250.00
609003	36" (92 x 57 x 63 cm)	1	\$1,000.00	\$1,430.00 \$1,765.00
609004	42" (107 x 71.5 x 79 cm)	1	\$1,400.00	\$2,000.00 \$2,470.00
609005	48" (122 x 76 x 84 cm)	1	\$1,650.00	\$2,355.00 \$2,910.00



Plegable

Correa retráctil Pro

TARJETA

- ▶ Ideal para dar más espacio de paseo a tu mascota
- ▶ Correa plana con destorcedor 360° zamak cromado
- ▶ Carcasa ABS con asa TPR
- ▶ Botón de seguridad ajustable en 3 modalidades:
Libertad de movimiento
Bloqueo inmediato
Bloqueo permanente
- ▶ Tres medidas a elegir:
Chico
Mascotas hasta 10 kg con 4 m de correa
Mediano
Mascotas de 10 a 20 kg con 5 m de correa
Grande
Mascotas de 20 a 30 kg con 5 m de correa



Petit

CÓDIGO	TALLA	COLOR			DISTRIB.	MAYOREO	LISTA
623202	Chica	Rojo	4	24	\$175.00	\$250.00	\$310.00
623206	Chica	Azul	4	24	\$175.00	\$250.00	\$310.00
623207	Chica	Gris	4	24	\$175.00	\$250.00	\$310.00
623208	Chica	Negro	4	24	\$175.00	\$250.00	\$310.00
623302	Mediana	Rojo	4	24	\$200.00	\$285.00	\$355.00
623306	Mediana	Azul	4	24	\$200.00	\$285.00	\$355.00
623307	Mediana	Gris	4	24	\$200.00	\$285.00	\$355.00
623308	Mediana	Negro	4	24	\$200.00	\$285.00	\$355.00
623402	Grande	Rojo	4	24	\$240.00	\$345.00	\$425.00
623406	Grande	Azul	4	24	\$240.00	\$345.00	\$425.00
623407	Grande	Gris	4	24	\$240.00	\$345.00	\$425.00
623408	Grande	Negro	4	24	\$240.00	\$345.00	\$425.00

Correa retráctil

TARJETA

- ▶ Ideal para dar mas espacio de paseo a tu mascota
- ▶ Correa cilíndrica con destorcedor 360° zamak cromado
- ▶ Carcasa y asa de polietileno
- ▶ Botón de seguridad ajustable en 3 modalidades:
Libertad de movimiento
Bloqueo inmediato
Bloqueo permanente
- ▶ Tres medidas a elegir:
Chico
Mascotas hasta 10 kg con 4 m de correa
Mediano
Mascotas de 10 a 20 kg con 5 m de correa
Grande
Mascotas de 20 a 30 kg con 5 m de correa



Petit

CÓDIGO	TALLA	COLOR			DISTRIB.	MAYOREO	LISTA
622201	Chica	Rosa	4	24	\$150.00	\$215.00	\$265.00
622206	Chica	Azul	4	24	\$150.00	\$215.00	\$265.00
622208	Chica	Negro	4	24	\$150.00	\$215.00	\$265.00
622301	Mediana	Rosa	4	24	\$170.00	\$245.00	\$300.00
622306	Mediana	Azul	4	24	\$170.00	\$245.00	\$300.00
622308	Mediana	Negro	4	24	\$170.00	\$245.00	\$300.00
622401	Grande	Rosa	4	24	\$200.00	\$285.00	\$355.00
622406	Grande	Azul	4	24	\$200.00	\$285.00	\$355.00
622408	Grande	Negro	4	24	\$200.00	\$285.00	\$355.00

Cadena para perro cromada

CABALLETE

- ▶ Eslabones de acero soldado
- ▶ Bandola en el extremo
- ▶ Asa de polipropileno
- ▶ Largo de 1.20 m



CON BANDOLA EN EL EXTREMO

ASA DE POLIPROPILENO, VARIOS COLORES

Petit

CÓDIGO	MEDIDA	COLOR			DISTRIB.	MAYOREO	LISTA	CÓDIGO	MEDIDA	COLOR			DISTRIB.	MAYOREO	LISTA
113501	2 mm	Rosa	6	144	\$14.00	\$20.00	\$24.70	113517	4 mm	Rosa	6	72	\$31.00	\$44.00	\$55.00
113502	2 mm	Negro	6	144	\$14.00	\$20.00	\$24.70	113518	4 mm	Negro	6	72	\$31.00	\$44.00	\$55.00
113503	2 mm	Azul	6	144	\$14.00	\$20.00	\$24.70	113519	4 mm	Azul	6	72	\$31.00	\$44.00	\$55.00
113504	2 mm	Rojo	6	144	\$14.00	\$20.00	\$24.70	113520	4 mm	Rojo	6	72	\$31.00	\$44.00	\$55.00
113505	2.5 mm	Rosa	6	144	\$18.00	\$26.00	\$32.00	113521	4.5 mm	Rosa	6	48	\$38.00	\$54.00	\$67.00
113506	2.5 mm	Negro	6	144	\$18.00	\$26.00	\$32.00	113522	4.5 mm	Negro	6	48	\$38.00	\$54.00	\$67.00
113507	2.5 mm	Azul	6	144	\$18.00	\$26.00	\$32.00	113523	4.5 mm	Azul	6	48	\$38.00	\$54.00	\$67.00
113508	2.5 mm	Rojo	6	144	\$18.00	\$26.00	\$32.00	113524	4.5 mm	Rojo	6	48	\$38.00	\$54.00	\$67.00
113509	3 mm	Rosa	6	72	\$23.00	\$33.00	\$41.00	113525	5 mm	Rosa	6	48	\$47.00	\$67.00	\$83.00
113510	3 mm	Negro	6	72	\$23.00	\$33.00	\$41.00	113526	5 mm	Negro	6	48	\$47.00	\$67.00	\$83.00
113511	3 mm	Azul	6	72	\$23.00	\$33.00	\$41.00	113527	5 mm	Azul	6	48	\$47.00	\$67.00	\$83.00
113512	3 mm	Rojo	6	72	\$23.00	\$33.00	\$41.00	113528	5 mm	Rojo	6	48	\$47.00	\$67.00	\$83.00
113513	3.5 mm	Rosa	6	72	\$28.00	\$40.00	\$49.00								
113514	3.5 mm	Negro	6	72	\$28.00	\$40.00	\$49.00								
113515	3.5 mm	Azul	6	72	\$28.00	\$40.00	\$49.00								
113516	3.5 mm	Rojo	6	72	\$28.00	\$40.00	\$49.00								

Cadena de entrenamiento para perro

CABALLETE



ANILLOS A LOS EXTREMOS

ESLABONES DE ACERO SOLDADOS

AKSI

CÓDIGO	MEDIDA	LONGITUD			DISTRIB.	MAYOREO	LISTA
113541	2 mm	46 cm	12	144	\$8.00	\$11.40	\$14.10
113542	2.5 mm	46 cm	12	144	\$10.00	\$14.30	\$17.60
113543	3 mm	51 cm	12	144	\$13.00	\$18.60	\$22.90
113544	3.5 mm	56 cm	12	144	\$16.00	\$22.90	\$28.00
113545	4 mm	61 cm	12	72	\$20.00	\$29.00	\$35.00

Guía de tallas



Collar ajustable

TARJETA

- ▶ Collar de poliéster ajustable, material suave y ligero
- ▶ El tinte no destiñe, significa que no se decolora ni se despinta cuando está mojado
- ▶ Broche plástico POM de liberación rápida: se puede abrir rápidamente en caso de emergencia
- ▶ Argolla de acero cromado para placa de identificación o correa



Petit

CÓDIGO	TALLA	COLOR			DISTRIB.	MAYOREO	LISTA
611101	Extra chico	Rosa	6	60	\$30.00	\$43.00	\$53.00
611109	Extra chico	Morado	6	60	\$30.00	\$43.00	\$53.00
611106	Extra chico	Azul	6	60	\$30.00	\$43.00	\$53.00
611104	Extra chico	Amarillo	6	60	\$30.00	\$43.00	\$53.00
611110	Extra chico	Beige	6	60	\$30.00	\$43.00	\$53.00
611201	Chico	Rosa	6	60	\$40.00	\$57.00	\$71.00
611209	Chico	Morado	6	60	\$40.00	\$57.00	\$71.00
611206	Chico	Azul	6	60	\$40.00	\$57.00	\$71.00
611204	Chico	Amarillo	6	60	\$40.00	\$57.00	\$71.00
611210	Chico	Beige	6	60	\$40.00	\$57.00	\$71.00

CÓDIGO	TALLA	COLOR			DISTRIB.	MAYOREO	LISTA
611301	Mediano	Rosa	6	60	\$50.00	\$71.00	\$88.00
611309	Mediano	Morado	6	60	\$50.00	\$71.00	\$88.00
611306	Mediano	Azul	6	60	\$50.00	\$71.00	\$88.00
611304	Mediano	Amarillo	6	60	\$50.00	\$71.00	\$88.00
611310	Mediano	Beige	6	60	\$50.00	\$71.00	\$88.00
611401	Grande	Rosa	6	60	\$60.00	\$86.00	\$106.00
611409	Grande	Morado	6	60	\$60.00	\$86.00	\$106.00
611406	Grande	Azul	6	60	\$60.00	\$86.00	\$106.00
611404	Grande	Amarillo	6	60	\$60.00	\$86.00	\$106.00
611410	Grande	Beige	6	60	\$60.00	\$86.00	\$106.00

Guía de tallas

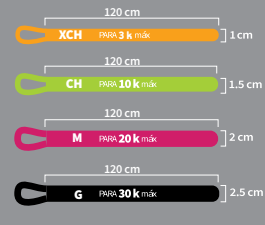

Correa

TARJETA

- ▶ Correa de poliéster con destorcedor zamak cromado
- ▶ El tinte no destiñe, significa que esta correa no se decolora ni se despinta cuando está mojada
- ▶ Asa con costura cruzada para mayor seguridad



Destorcedor 360° zamak cromado

Petit

CÓDIGO	TALLA	COLOR			DISTRIB.	MAYOREO	LISTA
621101	Extra chica	Rosa	6	60	\$50.00	\$71.00	\$88.00
621109	Extra chica	Morado	6	60	\$50.00	\$71.00	\$88.00
621106	Extra chica	Azul	6	60	\$50.00	\$71.00	\$88.00
621104	Extra chica	Amarillo	6	60	\$50.00	\$71.00	\$88.00
621110	Extra chica	Beige	6	60	\$50.00	\$71.00	\$88.00
621201	Chica	Rosa	6	60	\$60.00	\$86.00	\$106.00
621209	Chica	Morado	6	60	\$60.00	\$86.00	\$106.00
621206	Chica	Azul	6	60	\$60.00	\$86.00	\$106.00
621204	Chica	Amarillo	6	60	\$60.00	\$86.00	\$106.00
621210	Chica	Beige	6	60	\$60.00	\$86.00	\$106.00

CÓDIGO	TALLA	COLOR			DISTRIB.	MAYOREO	LISTA
621301	Mediana	Rosa	6	60	\$70.00	\$100.00	\$123.00
621309	Mediana	Morado	6	60	\$70.00	\$100.00	\$123.00
621306	Mediana	Azul	6	60	\$70.00	\$100.00	\$123.00
621304	Mediana	Amarillo	6	60	\$70.00	\$100.00	\$123.00
621310	Mediana	Beige	6	60	\$70.00	\$100.00	\$123.00
621401	Grande	Rosa	6	60	\$90.00	\$129.00	\$160.00
621409	Grande	Morado	6	60	\$90.00	\$129.00	\$160.00
621406	Grande	Azul	6	60	\$90.00	\$129.00	\$160.00
621404	Grande	Amarillo	6	60	\$90.00	\$129.00	\$160.00
621410	Grande	Beige	6	60	\$90.00	\$129.00	\$160.00



Guía de tallas

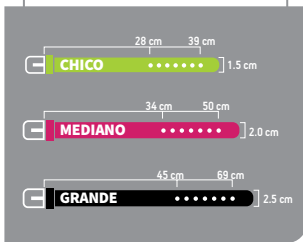

Collar ajustable contra el agua

- ▶ Collar ajustable de poliéster recubierto de silicón: material suave y repelente al agua
- ▶ Broche plástico POM de liberación rápida: se puede abrir rápidamente en caso de emergencia
- ▶ Argolla de acero cromado para placa de identificación o correa
- ▶ Tres medidas a elegir:
Chico - para mascotas de hasta 10 kg
Mediano - para mascotas de hasta 20 kg
Grande - para mascotas de hasta 30 kg



CÓDIGO	TALLA	COLOR		DISTRIB.	MAYOREO	LISTA
614206	Chico	Azul	6	60	\$60.00	\$86.00 \$106.00
614205	Chico	Verde	6	60	\$60.00	\$86.00 \$106.00
614204	Chico	Amarillo	6	60	\$60.00	\$86.00 \$106.00
614203	Chico	Naranja	6	60	\$60.00	\$86.00 \$106.00
614202	Chico	Rojo	6	60	\$60.00	\$86.00 \$106.00

CÓDIGO	TALLA	COLOR		DISTRIB.	MAYOREO	LISTA
614306	Mediano	Azul	6	60	\$70.00	\$100.00 \$123.00
614305	Mediano	Verde	6	60	\$70.00	\$100.00 \$123.00
614304	Mediano	Amarillo	6	60	\$70.00	\$100.00 \$123.00
614303	Mediano	Naranja	6	60	\$70.00	\$100.00 \$123.00
614302	Mediano	Rojo	6	60	\$70.00	\$100.00 \$123.00

CÓDIGO	TALLA	COLOR		DISTRIB.	MAYOREO	LISTA
614406	Grande	Azul	6	60	\$80.00	\$114.00 \$141.00
614405	Grande	Verde	6	60	\$80.00	\$114.00 \$141.00
614404	Grande	Amarillo	6	60	\$80.00	\$114.00 \$141.00
614403	Grande	Naranja	6	60	\$80.00	\$114.00 \$141.00
614402	Grande	Rojo	6	60	\$80.00	\$114.00 \$141.00

Guía de tallas



Correa contra el agua

TARJETA

- ▶ Correa de poliéster recubierta de silicón con destorcedor zamak* cromado
- ▶ Asa con costura cruzada para mayor seguridad

- ▶ Tres medidas a elegir:
Chico - para mascotas de hasta 10 kg
Mediano - para mascotas de hasta 20 kg
Grande - para mascotas de hasta 30 kg



Destorcedor 360° metálico



CÓDIGO	TALLA	COLOR		DISTRIB.	MAYOREO	LISTA
624206	Chica	Azul	6	60	\$100.00	\$143.00 \$175.00
624205	Chica	Verde	6	60	\$100.00	\$143.00 \$175.00
624204	Chica	Amarillo	6	60	\$100.00	\$143.00 \$175.00
624203	Chica	Naranja	6	60	\$100.00	\$143.00 \$175.00
624202	Chica	Rojo	6	60	\$100.00	\$143.00 \$175.00

CÓDIGO	TALLA	COLOR		DISTRIB.	MAYOREO	LISTA
624306	Mediana	Azul	6	60	\$110.00	\$155.00 \$195.00
624305	Mediana	Verde	6	60	\$110.00	\$155.00 \$195.00
624304	Mediana	Amarillo	6	60	\$110.00	\$155.00 \$195.00
624303	Mediana	Naranja	6	60	\$110.00	\$155.00 \$195.00
624302	Mediana	Rojo	6	60	\$110.00	\$155.00 \$195.00

CÓDIGO	TALLA	COLOR		DISTRIB.	MAYOREO	LISTA
624406	Grande	Azul	6	60	\$120.00	\$170.00 \$210.00
624405	Grande	Verde	6	60	\$120.00	\$170.00 \$210.00
624404	Grande	Amarillo	6	60	\$120.00	\$170.00 \$210.00
624403	Grande	Naranja	6	60	\$120.00	\$170.00 \$210.00
624402	Grande	Rojo	6	60	\$120.00	\$170.00 \$210.00

Guía de tallas



Collar Soft

TARJETA

- ▶ Collar de polipropileno con cojinete interno de PVC
 - ▶ Costuras reforzadas
 - ▶ Hebilla y ojales zamak cromado
 - ▶ Argolla de acero cromado para placa de identificación o correa
- ▶ Tres medidas a elegir:
 Chico - para mascotas hasta 10 kg
 Mediano - mascotas hasta 20 kg
 Grande - mascotas hasta 30 kg



CÓDIGO	TALLA	COLOR		DISTRIB.	MAYOREO	LISTA
615202	Chico	Rojo	12 72	\$40.00	\$57.00	\$71.00
615206	Chico	Azul	12 72	\$40.00	\$57.00	\$71.00
615208	Chico	Negro	12 72	\$40.00	\$57.00	\$71.00

CÓDIGO	TALLA	COLOR		DISTRIB.	MAYOREO	LISTA
615302	Mediano	Rojo	12 72	\$50.00	\$71.00	\$88.00
615306	Mediano	Azul	12 72	\$50.00	\$71.00	\$88.00
615308	Mediano	Negro	12 72	\$50.00	\$71.00	\$88.00

CÓDIGO	TALLA	COLOR		DISTRIB.	MAYOREO	LISTA
615402	Grande	Rojo	12 72	\$60.00	\$86.00	\$106.00
615406	Grande	Azul	12 72	\$60.00	\$86.00	\$106.00
615408	Grande	Negro	12 72	\$60.00	\$86.00	\$106.00

Guía de tallas



Collar & correa Soft

TARJETA

- ▶ Collar con cojinete interno
- ▶ Hebilla y ojales metálicos
- ▶ Argolla metálica para correa



Cojinete interno

Destorcedor 360°

CÓDIGO	TALLA	COLOR		DISTRIB.	MAYOREO	LISTA
632202	Chico	Rojo	12 96	\$70.00	\$100.00	\$123.00
632206	Chico	Azul	12 96	\$70.00	\$100.00	\$123.00
632208	Chico	Negro	12 96	\$70.00	\$100.00	\$123.00

CÓDIGO	TALLA	COLOR		DISTRIB.	MAYOREO	LISTA
632302	Mediano	Rojo	12 96	\$85.00	\$121.00	\$150.00
632306	Mediano	Azul	12 96	\$85.00	\$121.00	\$150.00
632308	Mediano	Negro	12 96	\$85.00	\$121.00	\$150.00

CÓDIGO	TALLA	COLOR		DISTRIB.	MAYOREO	LISTA
632402	Grande	Rojo	6 60	\$100.00	\$143.00	\$175.00
632406	Grande	Azul	6 60	\$100.00	\$143.00	\$175.00
632408	Grande	Negro	6 60	\$100.00	\$143.00	\$175.00

Guía de tallas

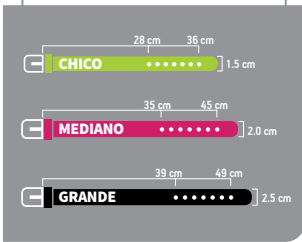

- ▶ Tres medidas a elegir:
Chico - mascotas de hasta 10 kg
Mediano - mascotas de hasta 20 kg
Grande - mascotas de hasta 30 kg

Collar Chevron

TARJETA

- ▶ Collar con cojinete interno
- ▶ Hebilla y ojales metálicos
- ▶ Argolla metálica para correa



CÓDIGO	TALLA	COLOR		DISTRIB.	MAYOREO	LISTA
612202	Chico	Rojo	12 72	\$55.00	\$79.00	\$97.00
612203	Chico	Naranja	12 72	\$55.00	\$79.00	\$97.00
612206	Chico	Azul	12 72	\$55.00	\$79.00	\$97.00
612209	Chico	Morado	12 72	\$55.00	\$79.00	\$97.00
612207	Chico	Gris	12 72	\$55.00	\$79.00	\$97.00
612208	Chico	Negro	12 72	\$55.00	\$79.00	\$97.00

CÓDIGO	TALLA	COLOR		DISTRIB.	MAYOREO	LISTA
612302	Mediano	Rojo	12 72	\$75.00	\$107.00	\$132.00
612303	Mediano	Naranja	12 72	\$75.00	\$107.00	\$132.00
612306	Mediano	Azul	12 72	\$75.00	\$107.00	\$132.00
612309	Mediano	Morado	12 72	\$75.00	\$107.00	\$132.00
612307	Mediano	Gris	12 72	\$75.00	\$107.00	\$132.00
612308	Mediano	Negro	12 72	\$75.00	\$107.00	\$132.00

CÓDIGO	TALLA	COLOR		DISTRIB.	MAYOREO	LISTA
612402	Grande	Rojo	12 72	\$85.00	\$121.00	\$150.00
612403	Grande	Naranja	12 72	\$85.00	\$121.00	\$150.00
612406	Grande	Azul	12 72	\$85.00	\$121.00	\$150.00
612409	Grande	Morado	12 72	\$85.00	\$121.00	\$150.00
612407	Grande	Gris	12 72	\$85.00	\$121.00	\$150.00
612408	Grande	Negro	12 72	\$85.00	\$121.00	\$150.00

Guía de tallas

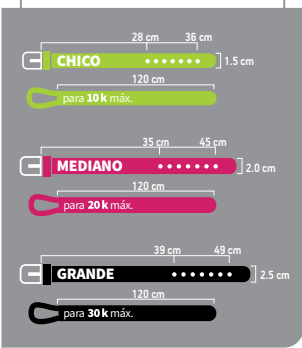

Collar G correa Chevron

TARJETA

- ▶ Collar con cojinete interno
- ▶ Hebilla y ojales metálicos
- ▶ Argolla metálica para correa
- ▶ Correa con asa acojinada
- ▶ Destorcedor 360° metálico



CÓDIGO	TALLA	COLOR		DISTRIB.	MAYOREO	LISTA
631202	Chico	Rojo	6 48	\$110.00	\$155.00	\$195.00
631203	Chico	Naranja	6 48	\$110.00	\$155.00	\$195.00
631206	Chico	Azul	6 48	\$110.00	\$155.00	\$195.00
631209	Chico	Morado	6 48	\$110.00	\$155.00	\$195.00
631207	Chico	Gris	6 48	\$110.00	\$155.00	\$195.00
631208	Chico	Negro	6 48	\$110.00	\$155.00	\$195.00

CÓDIGO	TALLA	COLOR		DISTRIB.	MAYOREO	LISTA
631302	Mediano	Rojo	6 48	\$140.00	\$200.00	\$245.00
631303	Mediano	Naranja	6 48	\$140.00	\$200.00	\$245.00
631306	Mediano	Azul	6 48	\$140.00	\$200.00	\$245.00
631309	Mediano	Morado	6 48	\$140.00	\$200.00	\$245.00
631307	Mediano	Gris	6 48	\$140.00	\$200.00	\$245.00
631308	Mediano	Negro	6 48	\$140.00	\$200.00	\$245.00

CÓDIGO	TALLA	COLOR		DISTRIB.	MAYOREO	LISTA
631402	Grande	Rojo	6 48	\$160.00	\$230.00	\$280.00
631403	Grande	Naranja	6 48	\$160.00	\$230.00	\$280.00
631406	Grande	Azul	6 48	\$160.00	\$230.00	\$280.00
631409	Grande	Morado	6 48	\$160.00	\$230.00	\$280.00
631407	Grande	Gris	6 48	\$160.00	\$230.00	\$280.00
631408	Grande	Negro	6 48	\$160.00	\$230.00	\$280.00

Guía de tallas

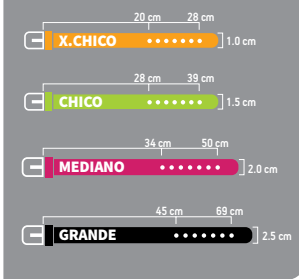

Collar ajustable con reflectante

TARJETA

- ▶ Collar ajustable de poliéster con banda reflectante
- ▶ Broche plástico POM de liberación rápida: se puede abrir rápidamente en caso de emergencia
- ▶ Costuras reforzadas
- ▶ Argolla de acero cromado para placa de identificación o correa



Tira reflejante



Petit



CÓDIGO	TALLA	COLOR			DISTRIB.	MAYOREO	LISTA
613108	Extra chico	Negro	6	60	\$35.00	\$50.00	\$62.00
613208	Chico	Negro	6	60	\$45.00	\$64.00	\$79.00
613308	Mediano	Negro	6	60	\$50.00	\$71.00	\$88.00
613408	Grande	Negro	6	60	\$60.00	\$86.00	\$106.00

Guía de tallas



Cinturón de seguridad universal 2 en 1

PROX.

TARJETA

- ▶ Correa para asegurar a tu mascota en viajes de automóvil
- ▶ Dos en uno:
 1. Anclaje a broche de cinturón de seguridad del auto
 2. Correa ajustable de paseo tradicional
- ▶ Destorcedor 360° zamak
- ▶ Clip de anclaje de acero
- ▶ Costuras cruzadas para mayor resistencia

Advertencia: Por seguridad de su mascota al viajar en el automóvil, debe sujetarla desde un arnés. NUNCA lo sujete del cuello ya que en accidentes viales puede causar ahorcamiento.



Petit

CÓDIGO	TALLA	COLOR			DISTRIB.	MAYOREO	LISTA
630202	Chico	Rojo-café	12	48	\$65.00	\$93.00	\$115.00
630206	Chico	Azul-rosa	12	48	\$65.00	\$93.00	\$115.00
630208	Chico	Verde-negro	12	48	\$65.00	\$93.00	\$115.00

CÓDIGO	TALLA	COLOR			DISTRIB.	MAYOREO	LISTA
630302	Mediano	Rojo-café	12	48	\$75.00	\$107.00	\$132.00
630306	Mediano	Azul-rosa	12	48	\$75.00	\$107.00	\$132.00
630308	Mediano	Verde-negro	12	48	\$75.00	\$107.00	\$132.00

CÓDIGO	TALLA	COLOR			DISTRIB.	MAYOREO	LISTA
630402	Grande	Rojo-café	12	48	\$85.00	\$121.00	\$150.00
630406	Grande	Azul-rosa	12	48	\$85.00	\$121.00	\$150.00
630408	Grande	Verde-negro	12	48	\$85.00	\$121.00	\$150.00

Guía de tallas

	Pecho	Cuello	Peso Para mascotas de hasta
CHICO	30 a 33 cm	23 a 26 cm	10 k
MEDIANO	36 a 38 cm	33 a 36 cm	20 k
GRANDE	41 a 44 cm	38 a 41 cm	30 k

Arnés ajustable tipo "A"

CABALLETE

- ▶ Tipo Americano: se compone de tiras que rodean las patas y el pecho de la mascota y se cierra sobre las costillas
- ▶ La correa se engancha desde una argolla de seguridad en el lomo
- ▶ Ajustable al cuerpo de la mascota en dos ejes

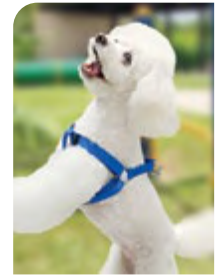

Petit

CÓDIGO	TALLA	COLOR	DISTRIB.	MAYOREO	LISTA
641202	Chico	Rojo	6 72	\$60.00	\$86.00 \$106.00
641201	Chico	Rosa	6 72	\$60.00	\$86.00 \$106.00
641205	Chico	Verde	6 72	\$60.00	\$86.00 \$106.00
641206	Chico	Azul	6 72	\$60.00	\$86.00 \$106.00
641207	Chico	Gris	6 72	\$60.00	\$86.00 \$106.00
641208	Chico	Negro	6 72	\$60.00	\$86.00 \$106.00

CÓDIGO	TALLA	COLOR	DISTRIB.	MAYOREO	LISTA
641302	Mediano	Rojo	6 72	\$75.00	\$107.00 \$132.00
641301	Mediano	Rosa	6 72	\$75.00	\$107.00 \$132.00
641305	Mediano	Verde	6 72	\$75.00	\$107.00 \$132.00
641306	Mediano	Azul	6 72	\$75.00	\$107.00 \$132.00
641307	Mediano	Gris	6 72	\$75.00	\$107.00 \$132.00
641308	Mediano	Negro	6 72	\$75.00	\$107.00 \$132.00

CÓDIGO	TALLA	COLOR	DISTRIB.	MAYOREO	LISTA
641402	Grande	Rojo	6 72	\$90.00	\$129.00 \$160.00
641401	Grande	Rosa	6 72	\$90.00	\$129.00 \$160.00
641405	Grande	Verde	6 72	\$90.00	\$129.00 \$160.00
641406	Grande	Azul	6 72	\$90.00	\$129.00 \$160.00
641407	Grande	Gris	6 72	\$90.00	\$129.00 \$160.00
641408	Grande	Negro	6 72	\$90.00	\$129.00 \$160.00

Guía de tallas

	Pecho	Cuello	Peso Para mascotas de hasta
CHICO	30 a 33 cm	23 a 26 cm	10 k
MEDIANO	36 a 38 cm	33 a 36 cm	20 k
GRANDE	41 a 44 cm	38 a 41 cm	30 k

Arnés tipo "Noruego"

GRANEL

- ▶ Hecho con poliéster suave y duradero
- ▶ El acolchado proporciona comodidad
- ▶ El asa ofrece fácil y rápida intervención
- ▶ De muy fácil colocación, solo introduzca la cabeza de la mascota y abroche por el contorno del pecho, ¡¡listo!!
- ▶ Ajustable en eje del pecho
- ▶ Broche plástico POM de liberación rápida: se puede abrir rápidamente en caso de emergencia
- ▶ Argolla zamak para correa



Petit

CÓDIGO	TALLA	COLOR	DISTRIB.	MAYOREO	LISTA
642202	Chico	Rojo-café	6 48	\$140.00	\$200.00 \$245.00
642206	Chico	Azul-rosa	6 48	\$140.00	\$200.00 \$245.00
642205	Chico	Verde-negro	6 48	\$140.00	\$200.00 \$245.00

CÓDIGO	TALLA	COLOR	DISTRIB.	MAYOREO	LISTA
642302	Mediano	Rojo-café	6 48	\$165.00	\$235.00 \$290.00
642306	Mediano	Azul-rosa	6 48	\$165.00	\$235.00 \$290.00
642305	Mediano	Verde-negro	6 48	\$165.00	\$235.00 \$290.00

CÓDIGO	TALLA	COLOR	DISTRIB.	MAYOREO	LISTA
642402	Grande	Rojo-café	4 32	\$215.00	\$305.00 \$380.00
642406	Grande	Azul-rosa	4 32	\$215.00	\$305.00 \$380.00
642405	Grande	Verde-negro	4 32	\$215.00	\$305.00 \$380.00

Guía de tallas

	Ancho	Base	Alto
CHICO	11.5 cm	21.5 cm	4 cm
MEDIANO	12 cm	24 cm	4 cm
GRANDE	16 cm	29 cm	5.5 cm

Plato doble de plástico

GRANEL

- ▶ Comedero y bebedero en una sola pieza
- ▶ Plástico seguro para tu mascota (polipropileno), no tóxico
- ▶ Libre de BPA
- ▶ Gomas de silicón antideslizante
- ▶ Agarraderas laterales para fácil transportación



Petit

CÓDIGO	TALLA	COLOR	DISTRIB.	MAYOREO	LISTA
655202	Chico	Rojo	12 72	\$22.00	\$31.00 \$39.00
655201	Chico	Rosa	12 72	\$22.00	\$31.00 \$39.00
655205	Chico	Verde	12 72	\$22.00	\$31.00 \$39.00
655206	Chico	Azul	12 72	\$22.00	\$31.00 \$39.00
655207	Chico	Gris	12 72	\$22.00	\$31.00 \$39.00
655208	Chico	Negro	12 72	\$22.00	\$31.00 \$39.00

CÓDIGO	TALLA	COLOR	DISTRIB.	MAYOREO	LISTA
655302	Mediano	Rojo	12 72	\$30.00	\$43.00 \$53.00
655301	Mediano	Rosa	12 72	\$30.00	\$43.00 \$53.00
655305	Mediano	Verde	12 72	\$30.00	\$43.00 \$53.00
655306	Mediano	Azul	12 72	\$30.00	\$43.00 \$53.00
655307	Mediano	Gris	12 72	\$30.00	\$43.00 \$53.00
655308	Mediano	Negro	12 72	\$30.00	\$43.00 \$53.00

CÓDIGO	TALLA	COLOR	DISTRIB.	MAYOREO	LISTA
655402	Grande	Rojo	6 72	\$40.00	\$57.00 \$71.00
655401	Grande	Rosa	6 72	\$40.00	\$57.00 \$71.00
655405	Grande	Verde	6 72	\$40.00	\$57.00 \$71.00
655406	Grande	Azul	6 72	\$40.00	\$57.00 \$71.00
655407	Grande	Gris	6 72	\$40.00	\$57.00 \$71.00
655408	Grande	Negro	6 72	\$40.00	\$57.00 \$71.00

Tamaño



	Ø Externo	Ø Interno	Alto
CHICO	15.5 cm	12 cm	5 cm
MEDIANO	18 cm	15 cm	5.5 cm
GRANDE	21 cm	16 cm	6 cm

BPA FREE

APTO PARA MICROONDAS

APTO PARA LAVAVAJILLAS

Plato redondo, plástico cristal

GRANEL

- ▶ Plástico seguro para tu mascota (polipropileno), no tóxico
- ▶ Libre de BPA
- ▶ Gomas de silicón antiderrapante
- ▶ Agarraderas laterales para fácil transportación



Petit

CÓDIGO	TALLA	COLOR	📦	📦	DISTRIB.	MAYOREO	LISTA
653202	Chico	Rojo	12	72	\$25.00	\$36.00	\$44.00
653201	Chico	Rosa	12	72	\$25.00	\$36.00	\$44.00
653205	Chico	Verde	12	72	\$25.00	\$36.00	\$44.00
653206	Chico	Azul	12	72	\$25.00	\$36.00	\$44.00
653207	Chico	Gris	12	72	\$25.00	\$36.00	\$44.00
653208	Chico	Negro	12	72	\$25.00	\$36.00	\$44.00

CÓDIGO	TALLA	COLOR	📦	📦	DISTRIB.	MAYOREO	LISTA
653302	Mediano	Rojo	12	72	\$30.00	\$43.00	\$53.00
653301	Mediano	Rosa	12	72	\$30.00	\$43.00	\$53.00
653305	Mediano	Verde	12	72	\$30.00	\$43.00	\$53.00
653306	Mediano	Azul	12	72	\$30.00	\$43.00	\$53.00
653307	Mediano	Gris	12	72	\$30.00	\$43.00	\$53.00
653308	Mediano	Negro	12	72	\$30.00	\$43.00	\$53.00

CÓDIGO	TALLA	COLOR	📦	📦	DISTRIB.	MAYOREO	LISTA
653402	Grande	Rojo	12	72	\$40.00	\$57.00	\$71.00
653401	Grande	Rosa	12	72	\$40.00	\$57.00	\$71.00
653405	Grande	Verde	12	72	\$40.00	\$57.00	\$71.00
653406	Grande	Azul	12	72	\$40.00	\$57.00	\$71.00
653407	Grande	Gris	12	72	\$40.00	\$57.00	\$71.00
653408	Grande	Negro	12	72	\$40.00	\$57.00	\$71.00

Tamaño



	Ø Externo	Ø Interno	Alto
CHICO	18 cm	12 cm	5 cm
MEDIANO	21.5 cm	14.5 cm	6 cm
GRANDE	25.5 cm	18 cm	7 cm

Plato de acero anti-ruido

GRANEL

- ▶ Comedero de acero inoxidable con orilla de PVC
- ▶ El PVC reduce ruidos incómodos si el plato se desliza



Petit

CÓDIGO	TALLA	COLOR	📦	📦	DISTRIB.	MAYOREO	LISTA
651201	Chico	Acero	12	60	\$50.00	\$71.00	\$88.00
651301	Mediano	Acero	12	60	\$60.00	\$86.00	\$106.00
651401	Grande	Acero	12	60	\$70.00	\$100.00	\$123.00

Tamaño



	Ø Externo	Ø Interno	Alto
CHICO	14 cm	11 cm	5 cm
MEDIANO	17 cm	14 cm	6.5 cm
GRANDE	21 cm	17 cm	7.5 cm

Plato de acero antideslizante base de silicón

GRANEL

- ▶ Comedero de acero inoxidable con base de silicón
- ▶ El silicón evita que el plato se deslice



Base de silicón

Petit

CÓDIGO	TALLA	COLOR	📦	📦	DISTRIB.	MAYOREO	LISTA
652208	Chico	Acero	4	20	\$130.00	\$185.00	\$230.00
652308	Mediano	Acero	4	20	\$150.00	\$215.00	\$265.00
652408	Grande	Acero	4	20	\$195.00	\$280.00	\$345.00

Tamaño



	Ø	Alto
CHICO	13 cm	5 cm
GRANDE	18 cm	7 cm

BPA FREE

APTO PARA LAVAVAJILLAS

Plato plegable de silicón

GRANEL

- ▶ Comedero de silicón plegable y ligero
- ▶ Ideal para paseos, viajes, campamentos, etc.
- ▶ Incluye bandola metálica



Petit

CÓDIGO	TALLA	COLOR	📦	📦	DISTRIB.	MAYOREO	LISTA
654202	Chico	Rojo	6	72	\$40.00	\$57.00	\$71.00
654203	Chico	Naranja	6	72	\$40.00	\$57.00	\$71.00
654204	Chico	Amarillo	6	72	\$40.00	\$57.00	\$71.00
654209	Chico	Morado	6	72	\$40.00	\$57.00	\$71.00
654201	Chico	Rosa	6	72	\$40.00	\$57.00	\$71.00
654206	Chico	Azul	6	72	\$40.00	\$57.00	\$71.00
654205	Chico	Verde	6	72	\$40.00	\$57.00	\$71.00
654211	Chico	Blanco	6	72	\$40.00	\$57.00	\$71.00
654208	Chico	Negro	6	72	\$40.00	\$57.00	\$71.00

CÓDIGO	TALLA	COLOR	📦	📦	DISTRIB.	MAYOREO	LISTA
654302	Grande	Rojo	6	72	\$70.00	\$100.00	\$123.00
654303	Grande	Naranja	6	72	\$70.00	\$100.00	\$123.00
654304	Grande	Amarillo	6	72	\$70.00	\$100.00	\$123.00
654309	Grande	Morado	6	72	\$70.00	\$100.00	\$123.00
654301	Grande	Rosa	6	72	\$70.00	\$100.00	\$123.00
654306	Grande	Azul	6	72	\$70.00	\$100.00	\$123.00
654305	Grande	Verde	6	72	\$70.00	\$100.00	\$123.00
654311	Grande	Blanco	6	72	\$70.00	\$100.00	\$123.00
654308	Grande	Negro	6	72	\$70.00	\$100.00	\$123.00



Bebedero portátil

GRANEL

- ▶ Bebedero plegable de plástico
- ▶ Ideal para paseos, viajes, campamentos, etc.



CHICO: 250 ml

CÓDIGO	COLOR			DISTRIB.	MAYOREO	LISTA
662202	Rojo	6	60	\$30.00	\$43.00	\$53.00
662201	Rosa	6	60	\$30.00	\$43.00	\$53.00
662205	Verde	6	60	\$30.00	\$43.00	\$53.00
662206	Azul	6	60	\$30.00	\$43.00	\$53.00
662207	Gris	6	60	\$30.00	\$43.00	\$53.00
662208	Negro	6	60	\$30.00	\$43.00	\$53.00

MEDIANO: 500 ml

CÓDIGO	COLOR			DISTRIB.	MAYOREO	LISTA
662302	Rojo	6	60	\$40.00	\$57.00	\$71.00
662301	Rosa	6	60	\$40.00	\$57.00	\$71.00
662305	Verde	6	60	\$40.00	\$57.00	\$71.00
662306	Azul	6	60	\$40.00	\$57.00	\$71.00
662307	Gris	6	60	\$40.00	\$57.00	\$71.00
662308	Negro	6	60	\$40.00	\$57.00	\$71.00

GRANDE: 750 ml

CÓDIGO	COLOR			DISTRIB.	MAYOREO	LISTA
662402	Rojo	6	48	\$55.00	\$79.00	\$97.00
662401	Rosa	6	48	\$55.00	\$79.00	\$97.00
662405	Verde	6	48	\$55.00	\$79.00	\$97.00
662406	Azul	6	48	\$55.00	\$79.00	\$97.00
662407	Gris	6	48	\$55.00	\$79.00	\$97.00
662408	Negro	6	48	\$55.00	\$79.00	\$97.00



Bebedero portátil de silicón, 580 ml

GRANEL

- ▶ Botella de plástico PET, no tóxico
- ▶ Hoja de silicón
- ▶ Libres de BPA
- ▶ Tapa con ajuste a presión, compatible con las botellas convencionales de agua



Compatible con las botellas de agua convencionales



CÓDIGO			DISTRIB.	MAYOREO	LISTA
662501	4	32	\$110.00	\$155.00	\$195.00



Bebedero automático de 3.8 L

GRANEL

- ▶ Suministra agua por método de gravedad
- ▶ Incluye válvula para evitar derrames
- ▶ Ideal para mascotas con estancias largas en casa
- ▶ Fácil de limpiar y de rellenar



CÓDIGO	COLOR		DISTRIB.	MAYOREO	LISTA
661405	Verde	8	\$170.00	\$245.00	\$300.00
661401	Rosa	8	\$170.00	\$245.00	\$300.00
661407	Gris	8	\$170.00	\$245.00	\$300.00

Alimentador automático de 3.8 L

GRANEL

- ▶ Dispensador con boca extra ancha para que sea fácil recargar
- ▶ Suministra la comida por método de gravedad
- ▶ Ideal para mascotas con estancias largas en casa
- ▶ Fácil de limpiar y de rellenar



CÓDIGO	COLOR		DISTRIB.	MAYOREO	LISTA
661505	Verde	8	\$170.00	\$245.00	\$300.00
661501	Rosa	8	\$170.00	\$245.00	\$300.00
661507	Gris	8	\$170.00	\$245.00	\$300.00

Tamaño

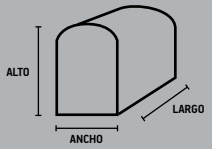

	Alto	Ancho	Largo
CHICA	36 cm	41 cm	46 cm
MEDIANA	53 cm	46 cm	64 cm
GRANDE	61 cm	56 cm	79 cm

Advertencia: La casa de campo NO es transportadora. NO se recomienda cargar la casa de campo con la mascota dentro.

Casa de campo plegable

BOLSA

- ▶ Plegable tipo portafolio para fácil almacenaje y transportación
- ▶ Incluye anclas que mejoran la sujeción
- ▶ Base de madera cubierta con funda acolchada desmontable para fácil limpieza



CÓDIGO	TAMAÑO	DISTRIB.	MAYOREO	LISTA
664801	Chica 6	\$620.00	\$885.00	\$1,095.00
664802	Mediana 6	\$800.00	\$1,145.00	\$1,410.00
664803	Grande 6	\$1,100.00	\$1,570.00	\$1,940.00

Tamaño

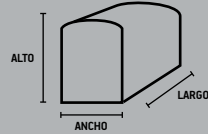

	Alto	Ancho	Largo	Hasta
CHICA	25 cm	22 cm	36 cm	10 kg
GRANDE	27 cm	25 cm	43 cm	15 kg

Transportadora

BOLSA

- ▶ Transportadora suave con malla transpirable
- ▶ Fabricada en poliéster con respaldo de PVC
- ▶ Dos medidas disponibles



CÓDIGO	TAMAÑO	DISTRIB.	MAYOREO	LISTA
664701	Chica 2 10	\$300.00	\$430.00	\$530.00
664702	Grande 2 10	\$340.00	\$485.00	\$600.00

Tamaño

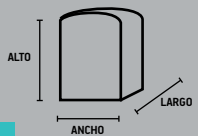

Alto	Ancho	Largo	Hasta
42 cm	33 cm	30 cm	6 kg

Mochila transportadora

BOLSA

- ▶ Práctica y cómoda para viajar con tu mascota
- ▶ Con malla transpirable, lo que la hace fresca y segura
- ▶ Bolsas laterales
- ▶ Asas acolchadas que amortiguan el peso
- ▶ Base de la mochila rígida



CÓDIGO	COLOR	DISTRIB.	MAYOREO	LISTA
664602	Rojo 2 24	\$345.00	\$495.00	\$610.00
664601	Café 2 24	\$345.00	\$495.00	\$610.00
664606	Azul 2 24	\$345.00	\$495.00	\$610.00
664607	Gris 2 24	\$345.00	\$495.00	\$610.00
664608	Negro 2 24	\$345.00	\$495.00	\$610.00

Tamaño

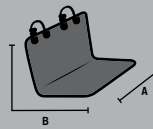

Ancho (A)	Largo (B)
110 cm	130 cm

Cubreasiento tipo "L"

CAJA

- ▶ Adaptable a todo tipo de automóvil
- ▶ Impermeable y de larga duración
- ▶ Cintas ajustables para sujetarlos de los reposacabezas
- ▶ Aperturas para liberar los broches del cinturón de seguridad
- ▶ De fácil colocación



CÓDIGO	DISTRIB.	MAYOREO	LISTA
665001	2 12	\$310.00	\$445.00 \$545.00

Tamaño

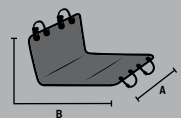

Ancho (A)	Largo (B)
137 cm	145 cm

Cubreasiento tipo "U"

BOLSA

- ▶ Adaptable a todo tipo de automóvil
- ▶ Impermeable y de larga duración
- ▶ Cintas ajustables para sujetarlos de los reposacabezas posteriores y delanteros
- ▶ Aperturas para liberar los broches del cinturón de seguridad
- ▶ De fácil colocación



CÓDIGO	DISTRIB.	MAYOREO	LISTA
665002	2 10	\$215.00	\$305.00 \$380.00

Tamaño

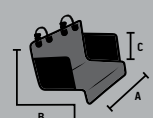

Ancho (A)	Largo (B)	Alto (C)
104 cm	185 cm	58 cm

Cubrecajuela

BOLSA

- ▶ Adaptable a todo tipo de automóvil
- ▶ Impermeable y de larga duración
- ▶ Cubre en su totalidad la cajuela, deteniéndolo de los reposacabezas posteriores y apoyandose de las paredes laterales
- ▶ De fácil colocación



CÓDIGO	DISTRIB.	MAYOREO	LISTA
664901	2 10	\$300.00	\$430.00 \$530.00

Despachador de bolsas

BLÍSTER

- ▶ Despachador roscable en forma de huesito
- ▶ Con gancho para sujetarlo del collar o la correa
- ▶ Ligero y resistente
- ▶ Incluye 15 bolsas
- ▶ Tres colores a elegir



CÓDIGO	COLOR			DISTRIB.	MAYOREO	LISTA
664202	Rojo	12	48	\$22.00	\$31.00	\$39.00
664206	Azul	12	48	\$22.00	\$31.00	\$39.00
664208	Negro	12	48	\$22.00	\$31.00	\$39.00

Rollo de bolsa para desechos

CABALLETE

- ▶ Pack de 4 rollos con 20 bolsas cada uno
- ▶ Compatible con el despachador de huesito
- ▶ Bolsa biodegradable
- ▶ Color negro



CÓDIGO			DISTRIB.	MAYOREO	LISTA
664101	12	48	\$20.00	\$29.00	\$35.00

Corta uñas con resorte

TARJETA

- ▶ Mango ergonómico que facilita su uso
- ▶ Cortes limpios y seguros
- ▶ Cuchillas de acero inoxidable
- ▶ Dos tamaños
Chico: mascotas mini y pequeñas
Grande: mascotas medianas y grandes



CÓDIGO	TAMAÑO			DISTRIB.	MAYOREO	LISTA
664301	Chico	6	36	\$60.00	\$86.00	\$106.00
664302	Mediano	6	36	\$75.00	\$107.00	\$132.00

Lava patas 2 en 1

GRANEL

- ▶ Lavapatas 2 en 1: se puede utilizar como lavapatas y al reverso como cepillo
- ▶ Fabricado en silicón, material higiénico y suave
- ▶ No provoca dolor ni molestia a la mascota
- ▶ Dos medidas a elegir: Chico - Mediano



CÓDIGO	TAMAÑO			DISTRIB.	MAYOREO	LISTA
664401	Chico	4	48	\$99.00	\$141.00	\$175.00
664402	Mediano	4	28	\$120.00	\$170.00	\$210.00

Guante con malla para cepillado y baño

CAJA

- ▶ Su peine flexible extrae la suciedad, caspa y pelo muerto de la mascota
- ▶ El peinado suave hará que su mascota disfrute de un masaje calmante para estimular la piel y promover el brillo del pelo
- ▶ El peine de goma asegura un masaje sin dolor y sin arañazos
- ▶ Para todo tipo de mascota



CÓDIGO	COLOR			DISTRIB.	MAYOREO	LISTA
663302	Rojo	6	48	\$55.00	\$79.00	\$97.00
663306	Azul	6	48	\$55.00	\$79.00	\$97.00

Guante con microfibra para cepillado y baño

BOLSA

- ▶ Ideal para cepillado y baño de la mascota
- ▶ La microfibra súper absorbente ayudará a bañarlos con mayor facilidad
- ▶ El peine tipo huella brinda un masaje relajante a tu mascota
- ▶ Soporte interno para tener un mejor agarre de cepillado



CÓDIGO			DISTRIB.	MAYOREO	LISTA
663301	6	36	\$110.00	\$155.00	\$195.00

Cepillo carda con autolimpieza

TARJETA

- ▶ Cerdas de acero inoxidable
- ▶ Mango plástico ergonómico
- ▶ Sistema de autolimpieza



Sistema de autolimpieza

Petit

CÓDIGO	COLOR			DISTRIB.	MAYOREO	LISTA
663203	Naranja	6	48	\$110.00	\$155.00	\$195.00
663206	Azul	6	48	\$110.00	\$155.00	\$195.00

Cepillo carda

TARJETA

- ▶ Cerdas de acero inoxidable
- ▶ Mango plástico
- ▶ Ideal para pelo medio, largo, liso y rizado
- ▶ Cepilla con firmeza siguiendo la dirección del pelo
- ▶ No cepilles sobre lesiones o piel irritada
- ▶ Tres tamaños disponibles



Petit

CÓDIGO	TAMAÑO			DISTRIB.	MAYOREO	LISTA
663101	Chico	6	48	\$35.00	\$50.00	\$62.00
663102	Mediano	6	48	\$40.00	\$57.00	\$71.00
663103	Grande	6	48	\$50.00	\$71.00	\$88.00

Arenero

GRANEL

- ▶ Plástico ecológico de alta calidad
- ▶ Material duradero
- ▶ Con tapa semicerrada, guarda malos olores y evita que saquen la arena al rascar
- ▶ Desmontable
- ▶ De fácil limpieza



Desmontable

Petit

CÓDIGO	COLOR	TAMAÑO			DISTRIB.	MAYOREO	LISTA
671302	Rojo	40 x 30 x 17 cm	6	24	\$135.00	\$195.00	\$240.00
671303	Naranja		6	24	\$135.00	\$195.00	\$240.00
671304	Amarillo		6	24	\$135.00	\$195.00	\$240.00
671301	Rosa		6	24	\$135.00	\$195.00	\$240.00
671306	Azul		6	24	\$135.00	\$195.00	\$240.00
671305	Verde		6	24	\$135.00	\$195.00	\$240.00

Pala para arenero

GRANEL

- ▶ Plástico ecológico de alta calidad
- ▶ Ideal para limpieza de areneros
- ▶ Dos medidas disponibles:
Mediana - 28 x 13 cm
Grande - 34 x 16 cm



Petit

CÓDIGO	TAMAÑO	COLOR			DISTRIB.	MAYOREO	LISTA	CÓDIGO	TAMAÑO	COLOR			DISTRIB.	MAYOREO	LISTA
672302	Chica	Rojo	12	144	\$13.00	\$18.60	\$22.90	672402	Grande	Rojo	12	144	\$20.00	\$29.00	\$35.00
672303	Chica	Naranja	12	144	\$13.00	\$18.60	\$22.90	672403	Grande	Naranja	12	144	\$20.00	\$29.00	\$35.00
672304	Chica	Amarillo	12	144	\$13.00	\$18.60	\$22.90	672404	Grande	Amarillo	12	144	\$20.00	\$29.00	\$35.00
672301	Chica	Rosa	12	144	\$13.00	\$18.60	\$22.90	672401	Grande	Rosa	12	144	\$20.00	\$29.00	\$35.00
672306	Chica	Azul	12	144	\$13.00	\$18.60	\$22.90	672406	Grande	Azul	12	144	\$20.00	\$29.00	\$35.00
672305	Chica	Verde	12	144	\$13.00	\$18.60	\$22.90	672405	Grande	Verde	12	144	\$20.00	\$29.00	\$35.00

Lanza pelota

BLÍSTER

- ▶ Juguete interactivo
- ▶ Lanza la pelota a grandes distancias con muy poco esfuerzo evitando el contacto directo con la pelota
- ▶ Pelota de goma estilo tenis
- ▶ La base del lanzador agarra firmemente la pelota y la libera cuando balanceas tu brazo
- ▶ Compatible con diversas pelotas

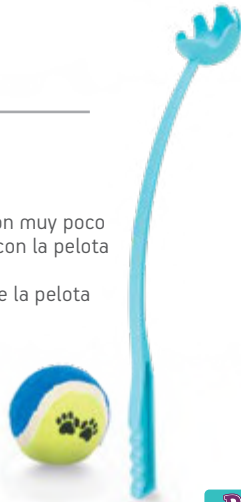

CÓDIGO			DISTRIB.	MAYOREO	LISTA
681004	6	48	\$45.00	\$64.00	\$79.00

Pelota de tenis

PROX.

GRANEL

- ▶ Pelota de goma
- ▶ Compatible con el lanza pelota
- ▶ Venta individual o en pack de 3 piezas



Los colores pueden variar dependiendo del stock existente.



CÓDIGO	DESCRIPCIÓN			DISTRIB.	MAYOREO	LISTA
681109	1 pieza	24	144	\$15.00	\$21.40	\$26.00
681110	3 piezas	N/A	48	\$40.00	\$57.00	\$71.00

Pelota de cuerda con asa

GRANEL

- ▶ Pelota de cuerda 100% algodón
- ▶ Trenzado que da resistencia al juguete
- ▶ Ayuda a la limpieza dental de la mascota



CÓDIGO	TAMAÑO			DISTRIB.	MAYOREO	LISTA
680601	7.5" (19 cm)	6	48	\$30.00	\$43.00	\$53.00
680602	9" (22 cm)	6	48	\$45.00	\$64.00	\$79.00
680603	9.5" (24 cm)	6	48	\$60.00	\$86.00	\$106.00

Pelota de cuerda

GRANEL

- ▶ Pelota de cuerda 100% algodón
- ▶ Trenzado que da resistencia al juguete
- ▶ Ayuda a la limpieza dental de la mascota



CÓDIGO			DISTRIB.	MAYOREO	LISTA
680701	6	48	\$24.50	\$35.00	\$43.00

Pelota de Cañamo-Algodón

GRANEL

- ▶ Pelota hecha de Cañamo-Algodón
- ▶ Material 100% natural para el juego de las mascotas
- ▶ Dos medidas disponibles

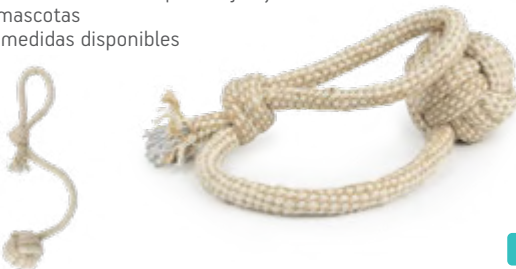

CÓDIGO	TAMAÑO			DISTRIB.	MAYOREO	LISTA
680101	16" (40 cm)	6	48	\$40.00	\$57.00	\$71.00
680102	20" (50 cm)	6	48	\$50.00	\$71.00	\$88.00

Hueso de cuerda soft

GRANEL

- ▶ Mordedora tipo hueso de cuerda 100% algodón
- ▶ Elimina ansiedad de la dentición en los cachorros
- ▶ Ayuda a la limpieza dental de la mascota
- ▶ Fácil lavado



CÓDIGO	TAMAÑO			DISTRIB.	MAYOREO	LISTA
680301	7" (18 cm)	6	48	\$15.00	\$21.40	\$26.00
680302	9" (22 cm)	6	48	\$20.00	\$29.00	\$35.00
680303	12" (30 cm)	6	48	\$25.00	\$36.00	\$44.00

Hueso de cuerda

GRANEL

- ▶ Mordedera tipo hueso de cuerda 100% algodón
- ▶ Elimina ansiedad de la dentición en los cachorros
- ▶ Ayuda a la limpieza dental de la mascota
- ▶ Fácil lavado



Petit

CÓDIGO	TAMAÑO			DISTRIB.	MAYOREO	LISTA
680401	8" (20 cm)	6	48	\$22.00	\$31.00	\$39.00
680402	12" (30 cm)	6	48	\$30.00	\$43.00	\$53.00
680403	14" (35.5 cm)	6	48	\$40.00	\$57.00	\$71.00
680404	17" (18cm)	6	48	\$50.00	\$71.00	\$88.00



Mordedera de cuerda, 4 ó 5 nudos

GRANEL

- ▶ Mordedera de cuerda 100% algodón
- ▶ Ayuda a la limpieza dental de la mascota
- ▶ Fácil lavado
- ▶ Ideal para perros medianos y grandes



4 Nudos - 28" (66 cm)



5 Nudos - 34" (86 cm)

Petit

CÓDIGO	TAMAÑO			DISTRIB.	MAYOREO	LISTA
680201	28" (70 cm)	6	24	\$105.00	\$150.00	\$185.00
680202	34" (86 cm)	6	24	\$135.00	\$195.00	\$240.00

Mordedera de cuerda en 8 con pelotas

GRANEL

- ▶ Mordedera de cuerda 100% algodón
- ▶ Pelotas de goma
- ▶ Fácil lavado
- ▶ Ideal para perros medianos y grandes



Petit

CÓDIGO			DISTRIB.	MAYOREO	LISTA
681003	6	48	\$60.00	\$86.00	\$106.00

Disco de cuerda

GRANEL

- ▶ Mordedera de cuerda de algodón
- ▶ Cubierta textil de poliéster
- ▶ Ayuda a la limpieza dental de la mascota
- ▶ Fácil lavado



Petit

CÓDIGO	TAMAÑO			DISTRIB.	MAYOREO	LISTA
680501	7" (18 cm)	6	48	\$40.00	\$57.00	\$71.00
680502	8" (20 cm)	6	48	\$50.00	\$71.00	\$88.00
680503	9" (22 cm)	6	48	\$55.00	\$79.00	\$97.00

Mordedera de cuerda en 8

GRANEL

- ▶ Mordedera de cuerda 100% algodón
- ▶ Ayuda a la limpieza dental de la mascota
- ▶ Fácil lavado
- ▶ Dos medidas disponibles



Petit

CÓDIGO	TAMAÑO			DISTRIB.	MAYOREO	LISTA
681001	7" (18 cm)	6	48	\$30.00	\$43.00	\$53.00
681002	8" (20 cm)	6	48	\$40.00	\$57.00	\$71.00

Mordedera de llanta con cuerda

GRANEL

- ▶ Mordedera de caucho natural
- ▶ Cuerda 100% algodón
- ▶ Juguete de dos texturas, más tiempo de entretenimiento para las mascotas
- ▶ Fácil lavado
- ▶ Dos medidas disponibles



CÓDIGO	Ø			DISTRIB.	MAYOREO	LISTA
680801	5" (13.5 cm)	6	48	\$110.00	\$155.00	\$195.00
680802	7" (18 cm)	6	24	\$180.00	\$255.00	\$320.00

Mordedera de llanta

GRANEL

- ▶ Mordedera fabricada de caucho natural
- ▶ Muy resistente
- ▶ Elimina la ansiedad de las mascotas
- ▶ Fácil lavado
- ▶ Dos medidas disponibles



CÓDIGO	Ø			DISTRIB.	MAYOREO	LISTA
680901	5" (13.5 cm)	6	48	\$80.00	\$114.00	\$141.00
680902	7" (18 cm)	6	24	\$150.00	\$215.00	\$265.00

Pelota para premios

CAJA

- ▶ Diseñado para introducir premios o alimento a la pelota
- ▶ Alto nivel de interactividad para la mascota
- ▶ Ayuda a la limpieza dental
- ▶ Fácil lavado



CÓDIGO	TAMAÑO			DISTRIB.	MAYOREO	LISTA
681005	7 cm	6	48	\$50.00	\$71.00	\$88.00

Mordedera limpia dientes

BLÍSTER

- ▶ Mordedera de caucho natural, no tóxico
- ▶ Textura suave y segura, ayuda a la limpieza dental sin dañar las encías de su mascota
- ▶ Fácil lavado
- ▶ Dos medidas disponibles

Reduce enfermedades periodontales*



*El uso del limpiantes en combinación con una buena higiene dental reduce visiblemente la enfermedad periodontal.



CÓDIGO	TAMAÑO			DISTRIB.	MAYOREO	LISTA
664501	Chica	6	48	\$55.00	\$79.00	\$97.00
664502	Grande	6	36	\$120.00	\$170.00	\$210.00

Pelota fluorescente

BLÍSTER

- ▶ Material TPR brillante en la oscuridad, no tóxico
- ▶ Estimula el sentido de la vista en lugares con poca luz
- ▶ Fácil lavado



CÓDIGO	TAMAÑO			DISTRIB.	MAYOREO	LISTA
681105	5 cm	6	48	\$55.00	\$79.00	\$97.00
681104	6 cm	6	48	\$80.00	\$114.00	\$141.00
681103	7 cm	6	48	\$105.00	\$150.00	\$185.00

Pelota deportiva

GRANEL

- ▶ Pelota de vinil, no tóxico
- ▶ Con sonido al apretarla
- ▶ Fácil lavado



Pelota chillona



CÓDIGO	CARACTERÍSTICAS			DISTRIB.	MAYOREO	LISTA
681101	Basketball	6	48	\$23.00	\$33.00	\$41.00
681102	Football	6	48	\$23.00	\$33.00	\$41.00

Pollo con sonido

GRANEL

- ▶ Pollo de PVC
- ▶ No tóxico
- ▶ Con sonido al apretarlo



Petit

CÓDIGO	TAMAÑO			DISTRIB.	MAYOREO	LISTA
681106	Chico	6	48	\$25.00	\$36.00	\$44.00
681108	Mediano	6	48	\$40.00	\$57.00	\$71.00
681107	Grande	6	48	\$55.00	\$79.00	\$97.00

Gallo con sonido

GRANEL

- ▶ Divertido gallo de latex
- ▶ No tóxico
- ▶ Con sonido al apretarlo



Petit

CÓDIGO			DISTRIB.	MAYOREO	LISTA
681006	6	36	\$80.00	\$114.00	\$141.00



Caña con juguete

TARJETA

- ▶ Juguete para estimular el instinto de caza en los mininos
- ▶ Ayuda a reducir la ansiedad, estrés y aburrimiento
- ▶ Fabricado en plástico y textil



Petit

CÓDIGO			DISTRIB.	MAYOREO	LISTA
681008	6	36	\$30.00	\$43.00	\$53.00

Pelotitas

CABALLETE

- ▶ Juego de 6 pelotitas con múltiples texturas
- ▶ 3 Pelotitas plásticas
- ▶ y 3 pelotitas textiles



Petit

CÓDIGO			DISTRIB.	MAYOREO	LISTA
681007	6	36	\$80.00	\$114.00	\$141.00



Llave temporizadora para lavabo

PROX. ●

CAJA

- ▶ Fabricada en latón
- ▶ Para baños públicos
- ▶ Botón de cierre automático
- ▶ Incluye aireador
- ▶ Tiempo de cierre 7 segundos
- ▶ Conexión roscable de 1/2"



3 años GARANTÍA

euro .PRECIO

CÓDIGO			DISTRIB.	MAYOREO	LISTA
115111	4	72	\$495.00	\$705.00	\$875.00

Llave economizadora para lavabo

PROX. ●

CAJA

- ▶ Fabricada en latón
- ▶ Para baños públicos
- ▶ Palanca multidireccional con cierre automático
- ▶ Conexión roscable de 1/2"



3 años GARANTÍA

euro .PRECIO

CÓDIGO			DISTRIB.	MAYOREO	LISTA
115112	4	72	\$765.00	\$1,095.00	\$1,350.00

Llave con sensor para lavabo

PROX. ●

CAJA

- ▶ Cuerpo metálico cromado
- ▶ Sensor de proximidad
- ▶ Sensor activado de 8 a 15 cm
- ▶ Salida de agua continua de 90 mili segundos
- ▶ Incluye aireador



3 años GARANTÍA

euro .PRECIO

CARACTERÍSTICAS
Alimentación: 14 baterías AA (no incluidas)
Tensión: 127 V-

CÓDIGO			DISTRIB.	MAYOREO	LISTA
115113	6	36	\$1,800.00	\$2,570.00	\$3,175.00

Mezcladora / Fregadero 8" cuello de ganso

CAJA

- ▶ Maneral hexagonal de zamak
- ▶ Cartuchos de cerámica
- ▶ Apertura de 1/4 de vuelta
- ▶ Cuerpo de una sola pieza
- ▶ Charola y cuello de acero inoxidable
- ▶ Acabado cromado, incluye aireador



Repuesto de válvula



3 años GARANTÍA

euro

CÓDIGO	DESCRIPCIÓN			DISTRIB.	MAYOREO	LISTA
115101	Mezcladora	4	16	\$330.00	\$470.00	\$580.00
115194	Par de repuestos	N/A	18 sets	\$55.00	\$79.00	\$97.00

Mezcladora / Fregadero 8" cuello de ganso

CAJA

- ▶ Maneral en cruz
- ▶ Manerales de zamak
- ▶ Charola y cuello de acero inoxidable
- ▶ Apertura de 1/4 de vuelta
- ▶ Acabado cromado
- ▶ Incluye aireador
- ▶ Cartuchos de cerámica
- ▶ Cuerpo de una sola pieza



Repuesto de válvula



3 años GARANTÍA

euro

CÓDIGO	DESCRIPCIÓN			DISTRIB.	MAYOREO	LISTA
115104	Mezcladora	4	16	\$340.00	\$485.00	\$600.00
115193	Par de repuestos	N/A	18 sets	\$55.00	\$79.00	\$97.00

Mezcladora / Fregadero 8" cuello de ganso

CAJA

- ▶ Maneral tipo marfil
- ▶ Manerales de zamak
- ▶ Charola y cuello de acero inoxidable
- ▶ Apertura de 1/4 de vuelta
- ▶ Acabado cromado
- ▶ Incluye aireador
- ▶ Cartuchos de cerámica
- ▶ Cuerpo de una sola pieza



Repuesto de válvula



3 años GARANTÍA

euro

CÓDIGO	DESCRIPCIÓN			DISTRIB.	MAYOREO	LISTA
115103	Mezcladora	4	16	\$340.00	\$485.00	\$600.00
115192	Par de repuestos	N/A	18 sets	\$55.00	\$79.00	\$97.00

Mezcladora / Fregadero 8" cuello de ganso

CAJA

- ▶ Maneral tipo palanca
- ▶ Manerales de zamak
- ▶ Charola y cuello de acero inoxidable
- ▶ Apertura de 1/4 de vuelta
- ▶ Acabado cromado
- ▶ Incluye aireador
- ▶ Cartuchos de cerámica
- ▶ Cuerpo de una sola pieza



Repuesto de válvula



3 años GARANTÍA

euro

CÓDIGO	DESCRIPCIÓN			DISTRIB.	MAYOREO	LISTA
115102	Mezcladora	4	16	\$330.00	\$470.00	\$580.00
115191	Par de repuestos	N/A	18 sets	\$55.00	\$79.00	\$97.00

Mezcladora / Fregadero 8" cuello cobra

CAJA

- ▶ Manerales tipo marfil de zamak
- ▶ Charola y cuello de acero inoxidable
- ▶ Apertura de 1/4 de vuelta
- ▶ Acabado cromado
- ▶ Incluye aireador
- ▶ Cartuchos de cerámica
- ▶ Cuerpo de una sola pieza



Repuesto de válvula



3 años GARANTÍA



CÓDIGO	DESCRIPCIÓN			DISTRIB.	MAYOREO	LISTA
115105	Mezcladora	4	16	\$380.00	\$545.00	\$670.00
115192	Par de repuestos	N/A	18 sets	\$55.00	\$79.00	\$97.00

Mezcladora / Lavabo 4" cuello curvo

CAJA

- ▶ Manerales tipo marfil de zamak
- ▶ Charola y cuello de acero inoxidable
- ▶ Apertura de 1/4 de vuelta
- ▶ Acabado cromado
- ▶ Incluye aireador
- ▶ Cartuchos de cerámica
- ▶ Cuerpo de una sola pieza



Repuesto de válvula



3 años GARANTÍA



CÓDIGO	DESCRIPCIÓN			DISTRIB.	MAYOREO	LISTA
115003	Mezcladora	4	24	\$265.00	\$380.00	\$465.00
115192	Par de repuestos	N/A	18 sets	\$55.00	\$79.00	\$97.00

Mezcladora / Lavabo 4" cuello curvo

CAJA

- ▶ Manerales hexagonales de zamak
- ▶ Charola y cuello de acero inoxidable
- ▶ Apertura de 1/4 de vuelta
- ▶ Acabado cromado
- ▶ Incluye aireador
- ▶ Cartuchos de cerámica
- ▶ Cuerpo de una sola pieza



Repuesto de válvula



3 años GARANTÍA



CÓDIGO	DESCRIPCIÓN			DISTRIB.	MAYOREO	LISTA
115001	Mezcladora	4	24	\$265.00	\$380.00	\$465.00
115194	Par de repuestos	N/A	18 sets	\$55.00	\$79.00	\$97.00

Mezcladora / Fregadero 8" cuello cobra

CAJA

- ▶ Manerales tipo palanca de zamak
- ▶ Charola y cuello de acero inoxidable
- ▶ Apertura de 1/4 de vuelta
- ▶ Acabado cromado
- ▶ Incluye aireador
- ▶ Cartuchos de cerámica
- ▶ Cuerpo de una sola pieza



Repuesto de válvula



3 años GARANTÍA



CÓDIGO	DESCRIPCIÓN			DISTRIB.	MAYOREO	LISTA
115106	Mezcladora	4	16	\$380.00	\$545.00	\$670.00
115191	Par de repuestos	N/A	18 sets	\$55.00	\$79.00	\$97.00

Mezcladora / Lavabo 4" cuello curvo

CAJA

- ▶ Manerales tipo palanca de zamak
- ▶ Charola y cuello de acero inoxidable
- ▶ Apertura de 1/4 de vuelta
- ▶ Acabado cromado
- ▶ Incluye aireador
- ▶ Cartuchos de cerámica
- ▶ Cuerpo de una sola pieza



Repuesto de válvula



3 años GARANTÍA



CÓDIGO	DESCRIPCIÓN			DISTRIB.	MAYOREO	LISTA
115002	Mezcladora	4	24	\$265.00	\$380.00	\$465.00
115191	Par de repuestos	N/A	18 sets	\$55.00	\$79.00	\$97.00

Mezcladora / Lavabo 4" cuello curvo

CAJA

- ▶ Manerales en cruz de zamak
- ▶ Charola y cuello de acero inoxidable
- ▶ Apertura de 1/4 de vuelta
- ▶ Acabado cromado
- ▶ Incluye aireador
- ▶ Cartuchos de cerámica
- ▶ Cuerpo de una sola pieza



Repuesto de válvula



3 años GARANTÍA



CÓDIGO	DESCRIPCIÓN			DISTRIB.	MAYOREO	LISTA
115004	Mezcladora	4	24	\$265.00	\$380.00	\$465.00
115195	Par de repuestos	N/A	18 sets	\$55.00	\$79.00	\$97.00

Monomando plástico para fregadero

CAJA

- ▶ Cuello, maneral y charola de ABS
- ▶ Apertura de 1/4 de vuelta
- ▶ Acabado cromado
- ▶ Incluye aireador y dos mangueras flexibles
- ▶ Cartuchos de cerámica



Cartucho para monomando



12

meses
GARANTÍA

ITIMAXTOOL

CÓDIGO	DESCRIPCIÓN			DISTRIB.	MAYOREO	LISTA
308404	Monomando	6	12 pzas.	\$350.00	\$500.00	\$615.00
308395	Cartucho	N/A	16 pzas.	\$45.00	\$64.00	\$79.00

Mezcladora / Fregadero 8" cuello de ganso

CAJA

- ▶ Maneral hexagonal
- ▶ Cuello de acero inoxidable
- ▶ Manerales y charola de ABS
- ▶ Apertura de 1/4 de vuelta
- ▶ Acabado cromado
- ▶ Incluye aireador
- ▶ Cartuchos de cerámica



Repuesto de válvula



12

meses
GARANTÍA

ITIMAXTOOL

CÓDIGO	DESCRIPCIÓN			DISTRIB.	MAYOREO	LISTA
308401	Mezcladora	4	16	\$250.00	\$355.00	\$440.00
308391	Par de repuestos	N/A	18 sets	\$35.00	\$50.00	\$62.00

Mezcladora para lavabo 4" cuello curvo

CAJA

- ▶ Maneral hexagonal
- ▶ Cuello de acero inoxidable
- ▶ Manerales y charola de ABS
- ▶ Apertura de 1/4 de vuelta
- ▶ Acabado cromado
- ▶ Incluye aireador
- ▶ Cartuchos de cerámica



Repuesto de válvula



12

meses
GARANTÍA

ITIMAXTOOL

CÓDIGO	DESCRIPCIÓN			DISTRIB.	MAYOREO	LISTA
308301	Mezcladora	4	24	\$200.00	\$285.00	\$355.00
308391	Par de repuestos	N/A	18 sets	\$35.00	\$50.00	\$62.00

Mezcladora / Fregadero 8" cuello cobra

CAJA

- ▶ Maneral tipo marfil
- ▶ Cuello de acero inoxidable
- ▶ Manerales y charola de ABS
- ▶ Apertura de 1/4 de vuelta
- ▶ Acabado cromado
- ▶ Incluye aireador
- ▶ Cartuchos de cerámica



Repuesto de válvula



12

meses
GARANTÍA

ITIMAXTOOL

CÓDIGO	DESCRIPCIÓN			DISTRIB.	MAYOREO	LISTA
308403	Mezcladora	4	16	\$320.00	\$455.00	\$565.00
308393	Par de repuestos	N/A	18 sets	\$35.00	\$50.00	\$62.00

Mezcladora / Fregadero 8" cuello de ganso

CAJA

- ▶ Maneral tipo rombo
- ▶ Cuello de acero inoxidable
- ▶ Manerales y charola de ABS
- ▶ Apertura de 1/4 de vuelta
- ▶ Acabado cromado
- ▶ Incluye aireador
- ▶ Cartuchos de cerámica



Repuesto de válvula



12

meses
GARANTÍA

ITIMAXTOOL

CÓDIGO	DESCRIPCIÓN			DISTRIB.	MAYOREO	LISTA
308402	Mezcladora	4	16	\$250.00	\$355.00	\$440.00
308392	Par de repuestos	N/A	18 sets	\$35.00	\$50.00	\$62.00

Mezcladora para lavabo 4" cuello curvo

CAJA

- ▶ Maneral tipo rombo
- ▶ Cuello de acero inoxidable
- ▶ Manerales y charola de ABS
- ▶ Apertura de 1/4 de vuelta
- ▶ Acabado cromado
- ▶ Incluye aireador
- ▶ Cartuchos de cerámica



Repuesto de válvula



12

meses
GARANTÍA

ITIMAXTOOL

CÓDIGO	DESCRIPCIÓN			DISTRIB.	MAYOREO	LISTA
308302	Mezcladora	4	24	\$200.00	\$285.00	\$355.00
308392	Par de repuestos	N/A	18 sets	\$35.00	\$50.00	\$62.00

Mezcladora / Lavabo 4" cuello bar

CAJA

- ▶ Maneral hexagonal
- ▶ Cuello de acero inoxidable
- ▶ Manerales y charola de ABS
- ▶ Apertura de 1/4 de vuelta
- ▶ Acabado cromado
- ▶ Incluye aireador
- ▶ Cartuchos de cerámica



CÓDIGO	DESCRIPCIÓN	📦	📦	DISTRIB.	MAYOREO	LISTA
308303	Mezcladora	4	24	\$250.00	\$355.00	\$440.00
308391	Par de repuestos	N/A	18 sets	\$35.00	\$50.00	\$62.00

Mezcladora para lavabo 4" cuello corto

CAJA

- ▶ Maneral tipo rombo
- ▶ Cuello de acero inoxidable
- ▶ Manerales y charola de ABS
- ▶ Apertura de 1/4 de vuelta
- ▶ Acabado cromado
- ▶ Incluye aireador
- ▶ Cartuchos de cerámica



CÓDIGO	DESCRIPCIÓN	📦	📦	DISTRIB.	MAYOREO	LISTA
308304	Mezcladora	4	24	\$250.00	\$355.00	\$440.00
308392	Par de repuestos	N/A	18 sets	\$35.00	\$50.00	\$62.00

Monomando plástico 4" para lavabo

CAJA

- ▶ Cuello, maneral y charola de ABS
- ▶ Apertura de 1/4 de vuelta
- ▶ Incluye aireador y dos mangueras flexibles
- ▶ Cartuchos de cerámica
- ▶ Acabado cromado



CÓDIGO	DESCRIPCIÓN	📦	📦	DISTRIB.	MAYOREO	LISTA
308305	Monomando	4	16 pzas	\$260.00	\$370.00	\$460.00
308396	Repuesto	N/A	16 pzas	\$45.00	\$64.00	\$79.00

Llave individual para lavabo

CAJA

- ▶ Nariz de acero inoxidable
- ▶ Maneral de ABS
- ▶ Apertura de 1/4 de vuelta
- ▶ Acabado cromado
- ▶ Incluye aireador
- ▶ Cartuchos de cerámica



CÓDIGO	DESCRIPCIÓN	📦	📦	DISTRIB.	MAYOREO	LISTA
308306	Llave	6	60	\$130.00	\$185.00	\$230.00
308394	Repuesto	N/A	36	\$27.00	\$39.00	\$48.00

Brazo y chapetón metálicos

CAJA

- ▶ Brazo metálico de alta resistencia



CÓDIGO	📦	📦	DISTRIB.	MAYOREO	LISTA
114806	10	100	\$40.00	\$57.00	\$71.00

Brazo plástico y chapetón metálico

CABALLETE

- ▶ Gran resistencia a altas temperaturas



CÓDIGO	📦	📦	DISTRIB.	MAYOREO	LISTA
308203	20	200	\$18.00	\$26.00	\$32.00

Manguera flexible para monomando

GRANEL

- ▶ Ideal para su uso en monomando AKSI® y MAXTOOL®
- ▶ Trenzado en aluminio
- ▶ Conector de 1/2" de acero inoxidable
- ▶ Conector tipo M10 de latón
- ▶ Longitud de 500 mm

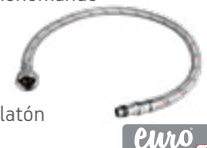

CÓDIGO	LONGITUD	📦	📦	DISTRIB.	MAYOREO	LISTA
103313	50 cm	10	150	\$20.00	\$29.00	\$35.00

Manguera flexible para agua

TARJETA

- ▶ Trenzado en aluminio
- ▶ Tramado de 8 hilos de aluminio
- ▶ Espigas de aluminio y férula de acero inoxidable



CÓDIGO	LONG.	DIÁMETRO	USO	📦	📦	DISTRIB.	MAYOREO	LISTA
103307	55 cm	1/2"x1/2"	Freg.	Bolsa c/10 pzas	150	\$17.00	\$24.30	\$30.00
103308	35 cm	1/2"x7/8"	WC	Bolsa c/10 pzas	150	\$16.00	\$22.90	\$28.00
103310	40 cm	1/2"x1/2"	Lavabo	Bolsa c/10 pzas	150	\$15.00	\$21.40	\$26.00
103311	60 cm	1/2"x3/4"	Boiler	Bolsa c/10 pzas	150	\$27.00	\$39.00	\$48.00
103312	60 cm	3/4"x3/4"	Boiler	Bolsa c/10 pzas	150	\$30.00	\$43.00	\$53.00

Césped flexible, fregadero - 1 1/2" con bote y contracanasta de polipropileno

BOLSA

- ▶ Contracanasta de 3 1/2"
- ▶ Estructura de polipropileno
- ▶ Resistente al agua caliente
- ▶ Fácil instalación

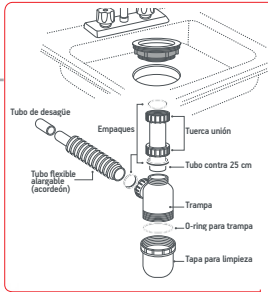

CÓDIGO			DISTRIB.	MAYOREO	LISTA
130001	4	24	\$95.00	\$136.00	\$170.00

Césped flexible, fregadero - 1 1/2" con bote y contrarrejilla plástica

BOLSA

- ▶ Contrarrejilla de 2 1/2"
- ▶ Para tarjetas tipo bar
- ▶ Estructura de polipropileno
- ▶ Resistente al agua caliente
- ▶ Fácil instalación

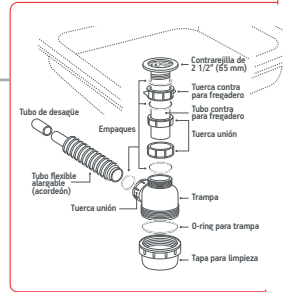
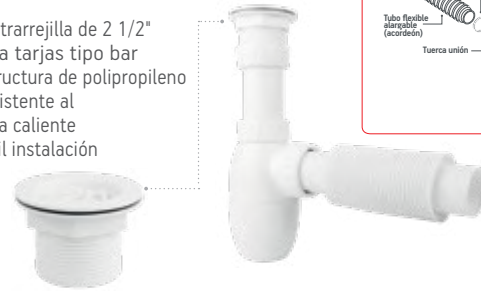

CÓDIGO			DISTRIB.	MAYOREO	LISTA
130002	4	24	\$50.00	\$71.00	\$88.00

Césped flexible, fregadero - 1 1/2" con bote sin contracanasta

BOLSA

- ▶ Estructura de polipropileno
- ▶ Resistente al agua caliente
- ▶ Fácil instalación

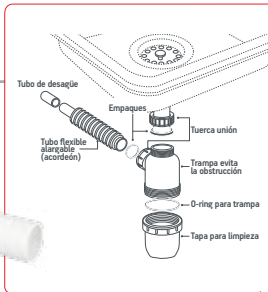

CÓDIGO			DISTRIB.	MAYOREO	LISTA
130003	8	24	\$55.00	\$79.00	\$97.00

Césped rígido, lavabo - 1 1/4" con contra de arillo cromado

BOLSA

- ▶ Estructura de polipropileno
- ▶ Resistente al agua caliente
- ▶ Fácil instalación

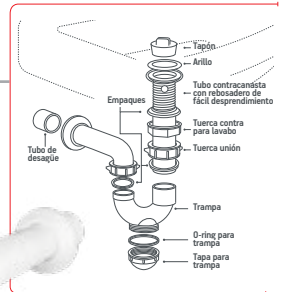

CÓDIGO			DISTRIB.	MAYOREO	LISTA
130004	6	36	\$50.00	\$71.00	\$88.00

Césped flexible, lavabo - 1 1/4" con bote y contra

BOLSA

- ▶ Estructura de polipropileno
- ▶ Resistente al agua caliente
- ▶ Fácil instalación

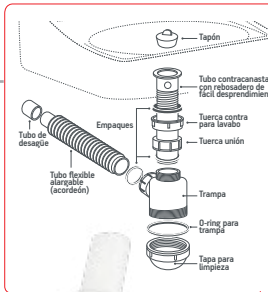

CÓDIGO			DISTRIB.	MAYOREO	LISTA
130005	6	36	\$40.00	\$57.00	\$71.00

Césped flexible, lavabo - 1 1/4" con contra plástica

BOLSA

- ▶ Estructura de polipropileno
- ▶ Resistente al agua caliente
- ▶ Fácil instalación

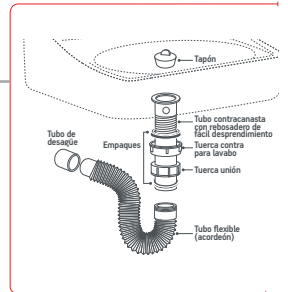

CÓDIGO			DISTRIB.	MAYOREO	LISTA
130006	8	48	\$40.00	\$57.00	\$71.00

Césped flexible, fregadero - 1 1/2"

con contracanasta plástica

BOLSA

- ▶ Cuerpo y contrarrejilla de 2 1/2"
- ▶ Para tarjas tipo bar
- ▶ Estructura de polipropileno
- ▶ Resistente al agua caliente
- ▶ Fácil instalación

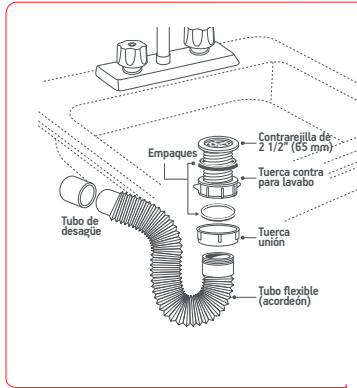

1 año GARANTÍA

euro

CÓDIGO



DISTRIB.

MAYOREO

LISTA

130007

4

24

\$35.00

\$50.00

\$62.00

Césped flexible, lavabo / fregadero

sin contra de polipropileno

BOLSA

- ▶ Con adaptador: para lavabo 1 1/4" para fregadero 1 1/2"
- ▶ Estructura de polipropileno
- ▶ Resistente al agua caliente
- ▶ Fácil instalación

ADAPTADORES 1 1/4" Y 1 1/2"



1 año GARANTÍA

euro

CÓDIGO



DISTRIB.

MAYOREO

LISTA

130008

8

48

\$35.00

\$50.00

\$62.00

Césped flexible, lavabo - 1 1/4"

con extensión

PROX.

BOLSA

- ▶ Cuerpo flexible de PVC resistente al agua caliente
- ▶ Sin extensión
- ▶ Para contracanastas con tubo de 1 1/2"



1 año GARANTÍA

euro

CÓDIGO



DISTRIB.

MAYOREO

LISTA

130009

4

24

\$44.00

\$63.00

\$78.00

Césped doble, fregadero - 1 1/2"

sin contracanasta plástica

BOLSA

- ▶ Para uso en tarjas de tina doble
- ▶ Estructura de polipropileno
- ▶ Resistente al agua caliente
- ▶ Fácil instalación

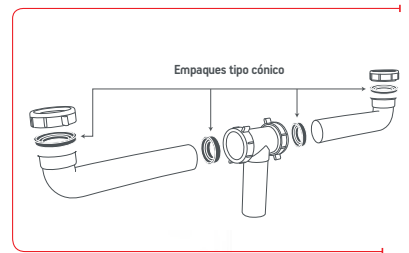

1 año GARANTÍA

euro

CÓDIGO



DISTRIB.

MAYOREO

LISTA

130041

10

40

\$48.00

\$69.00

\$85.00

Canastilla malla, lavabo - 1/2"

PROX.

BOLSA

- ▶ Fabricada en acero inoxidable
- ▶ Resistente a la corrosión
- ▶ Evita el paso de sólidos que obstruyen la tubería
- ▶ Malla flexible para ajustar a la contracanasta



3
años
GARANTÍA

euro AKSI

CÓDIGO			DISTRIB.	MAYOREO	LISTA
130061	10	60	\$15.00	\$21.40	\$26.00

Canastilla malla, fregadero - 3/4"

PROX.

BOLSA

- ▶ Fabricada en acero inoxidable
- ▶ Resistente a la corrosión
- ▶ Evita el paso de sólidos que obstruyen la tubería
- ▶ Malla flexible para ajustar a la contracanasta



3
años
GARANTÍA

euro AKSI

CÓDIGO			DISTRIB.	MAYOREO	LISTA
130062	10	60	\$23.00	\$33.00	\$41.00

Canastilla de acero inoxidable para contracanastas - 3 1/2"

PROX.

BOLSA

- ▶ Cuerpo de acero inoxidable
- ▶ Evita el paso de desperdicios a la tubería



3
años
GARANTÍA

euro AKSI

CÓDIGO			DISTRIB.	MAYOREO	LISTA
130063	6	90	\$20.00	\$29.00	\$35.00

Cubretaladros - 1 3/4"

PROX.

BOLSA

- ▶ Tapa de acero inoxidable
- ▶ Diámetro 42.2 mm
- ▶ Tornillo y mariposa de acero galvanizado
- ▶ Evita la filtración de agua



3
años
GARANTÍA

euro AKSI

CÓDIGO	ACABADO			DISTRIB.	MAYOREO	LISTA
130066	Cromo	12	60	\$11.00	\$15.70	\$19.40
130067	Satín	12	60	\$13.00	\$18.60	\$22.90

Chupón

PROX.

BOLSA

- ▶ Para conectar el tubo de céspol al desagüe del muro
- ▶ No requiere herramientas para su instalación



3
años
GARANTÍA

euro AKSI

CÓDIGO	MEDIDA			DISTRIB.	MAYOREO	LISTA
130071	2" x 1 1/4"	10	300	\$4.00	\$5.70	\$7.10
130072	2" x 1 1/2"	10	300	\$4.00	\$5.70	\$7.10

Juego de accesorios para WC - 2"

PROX.

BOLSA

- ▶ Válvula de llenado y de descarga de polipropileno
- ▶ Cadena plástica, tornillos y varilla de polipropileno
- ▶ Palanca de ABS con acabado cromo
- ▶ Sapo de silicona con marco rígido anti-fugas
- ▶ Para W.C. de 2 piezas con descarga de 2"



3
años
GARANTÍA

euro AKSI

CÓDIGO			DISTRIB.	MAYOREO	LISTA
130081	4	24	\$100.00	\$143.00	\$175.00

Contraacnasta, fregadero - 3 1/2"

con tubo plástico

CAJA

- ▶ Coladera desmontable con tapón
- ▶ Contra y tubo de polipropileno
- ▶ Rejilla y arillo de acero inoxidable



3 años GARANTÍA

euro

CÓDIGO			DISTRIB.	MAYOREO	LISTA
130051	10	40	\$38.00	\$54.00	\$67.00

Contraacnasta con tapa - 3 1/2"

de acero inoxidable

PROX.

CAJA

- ▶ Cuerpo y tubo de acero inoxidable
- ▶ Canastilla extraíble de acero inoxidable
- ▶ Tapa con cierre hermético
- ▶ Cuerpo profundo de 4 cm, con tuerca metálica



3 años GARANTÍA

euro

CÓDIGO			DISTRIB.	MAYOREO	LISTA
130053	6	24	\$95.00	\$136.00	\$170.00

Contraacnasta, fregadero - 3 1/2"

con tubo de latón

PROX.

CAJA

- ▶ Coladera desmontable con tapón
- ▶ Rejilla y arillo de acero inoxidable



3 años GARANTÍA

euro

CÓDIGO			DISTRIB.	MAYOREO	LISTA
130054	6	24	\$94.50	\$135.00	\$165.00

Tapa para coladera - 5"

juego de 2 piezas

PROX.

BOLSA

- ▶ Fabricadas en PVC
- ▶ Para coladeras de piso y regaderas



3 años GARANTÍA

euro

CÓDIGO			DISTRIB.	MAYOREO	LISTA
130095	5	150	\$18.00	\$26.00	\$32.00

Coladera de ABS salida universal con rejilla cromada - 5"

PROX.

BOLSA

- ▶ Cuerpo de ABS
- ▶ Rejilla de ABS cromada
- ▶ Trampa de polipropileno
- ▶ Sello hidráulico
- ▶ Para instalación en tubo de PVC sanitario de:
2" (50 mm)
3" (75 mm)
4" (100 mm)



3 años GARANTÍA

euro

CÓDIGO	TIPO			DISTRIB.	MAYOREO	LISTA
130091	1/4 de vuelta	4	24	\$58.00	\$83.00	\$102.00
130092	Con tornillos	4	24	\$58.00	\$83.00	\$102.00

Coladera de ABS salida lateral con rejilla cromada - 5"

PROX.

BOLSA

- ▶ Cuerpo de ABS
- ▶ Rejilla de ABS cromada
- ▶ Trampa de polipropileno
- ▶ Sello hidráulico
- ▶ Ideal para baño y segundos pisos
- ▶ Para conexión de 2"



3 años GARANTÍA

euro

CÓDIGO	TIPO			DISTRIB.	MAYOREO	LISTA
130093	1/4 de vuelta	4	24	\$62.00	\$89.00	\$109.00
130094	Con tornillos	4	24	\$62.00	\$89.00	\$109.00

Césped cromado, lavabo - 1 1/4"

con contra de latón

BOLSA

- ▶ Sistema con rebosadero
- ▶ Tubos y brazo de acero inoxidable
- ▶ Resistente al agua caliente
- ▶ Fácil instalación

Incluye:

- 4 Empaques tipo cónico
- 1 Tuerca contra
- 2 Tuerca unión
- 1 Tapón con cadena
- 1 Chapetón
- 1 Tubo (brazo)
- 1 Tubo en "U"



3 años GARANTÍA

Euro

CÓDIGO			DISTRIB.	MAYOREO	LISTA
130021	6	36	\$240.00	\$345.00	\$425.00

Contra cromado, lavabo - 1 1/4"

con rebosadero, sistema push

BOLSA

- ▶ Resistente al agua caliente
- ▶ Fácil instalación

Incluye:

- 1 Empaque plano
- 2 Empaques tipo cónico
- 1 Tuerca de sujeción
- 1 Contra (perno, botón push)
- 1 Tubo

CON REBOSADERO



SISTEMA PUSH

3 años GARANTÍA

Euro

CÓDIGO			DISTRIB.	MAYOREO	LISTA
130031	8	48	\$150.00	\$215.00	\$265.00

Césped cromado, lavabo - 1 1/4"

sin contra

BOLSA

- ▶ Resistente al agua caliente
- ▶ Fácil instalación

Incluye:

- 2 Empaques tipo cónico
- 2 Tuercas unión
- 1 Chapetón
- 1 Tubo (brazo)
- 1 Tubo en "U"



3 años GARANTÍA

Euro

CÓDIGO			DISTRIB.	MAYOREO	LISTA
130023	6	48	\$150.00	\$215.00	\$265.00

Contra cromado, lavabo - 1 1/4"

sin rebosadero, sistema push

BOLSA

- ▶ Resistente al agua caliente
- ▶ Fácil instalación

Incluye:

- 1 Empaque plano
- 2 Empaques tipo cónico
- 1 Tuerca de sujeción
- 1 Contra (perno, botón push)
- 1 Tubo



SISTEMA PUSH

3 años GARANTÍA

Euro

CÓDIGO			DISTRIB.	MAYOREO	LISTA
130032	8	48	\$160.00	\$230.00	\$280.00

Césped cromado, lavabo - 1 1/4"

con contra de latón tipo moneda

BOLSA

- ▶ Sistema con rebosadero
- ▶ Tubos y brazo de acero inoxidable
- ▶ Resistente al agua caliente
- ▶ Fácil instalación

Incluye:

- 1 Empaque plano
- 4 Empaques tipo cónico
- 1 Tuerca contra
- 2 Tuerca unión
- 1 Contra
- 1 Tubo contra
- 1 Chapetón
- 1 Tubo (brazo)
- 1 Tubo en "U"



TIPO MONEDA

3 años GARANTÍA

Euro

CÓDIGO			DISTRIB.	MAYOREO	LISTA
130022	6	36	\$245.00	\$350.00	\$430.00

Contra de polipropileno, lavabo - 1 1/4"

con rebosadero

PROX.

BOLSA

- ▶ Cuerpo y tubo de polipropileno resistente al agua caliente
- ▶ Tapa removible para lavabos con rebosadero
- ▶ Rejilla cromada
- ▶ Tubo de 1 1/4"

CON REBOSADERO



3 años GARANTÍA

Euro

CÓDIGO			DISTRIB.	MAYOREO	LISTA
130052	4	24	\$26.00	\$37.00	\$46.00

Regadera eléctrica, 3 temperaturas

PROX.

CAJA

- ▶ Cuerpo termo-plástico con aislante térmico y eléctrico
- ▶ Incluye una manguera y ducha manual
- ▶ Ahorradora, mínimo consumo de energía
- ▶ Flujo uniforme de agua



CARACTERÍSTICAS	
127 V	
50 A	
5500 W	

NOM

3 años GARANTÍA

euro

CÓDIGO			DISTRIB.	MAYOREO	LISTA
114891	4	24	\$225.00	\$320.00	\$395.00

Regadera eléctrica, 4 temperaturas

PROX.

CAJA

- ▶ Cuerpo termo-plástico con aislante térmico y eléctrico
- ▶ Incluye una manguera y ducha manual
- ▶ Ahorradora, mínimo consumo de energía
- ▶ Proporciona un baño de mayor volumen



CARACTERÍSTICAS	
127 V	
50 A	
5500 W	

NOM

3 años GARANTÍA

euro

CÓDIGO			DISTRIB.	MAYOREO	LISTA
114896	4	24	\$310.00	\$445.00	\$545.00

Regadera eléctrica, 3 temperaturas

PROX.

CAJA

- ▶ Cuerpo termo-plástico con aislante térmico y eléctrico
- ▶ Incluye una manguera y ducha manual
- ▶ Ahorradora, mínimo consumo de energía
- ▶ Flujo uniforme de agua



CARACTERÍSTICAS	
127 V	
50 A	
5500 W	

NOM

3 años GARANTÍA

euro

CÓDIGO			DISTRIB.	MAYOREO	LISTA
114892	4	24	\$225.00	\$320.00	\$395.00

Regadera eléctrica, 4 temperaturas

PROX.

CAJA

- ▶ Cuerpo termo-plástico con aislante térmico y eléctrico
- ▶ Incluye una manguera y ducha manual
- ▶ Ahorradora, mínimo consumo de energía
- ▶ Proporciona un baño de mayor volumen



CARACTERÍSTICAS	
127 V	
50 A	
5500 W	

NOM

3 años GARANTÍA

euro

CÓDIGO			DISTRIB.	MAYOREO	LISTA
114897	4	24	\$310.00	\$445.00	\$545.00

Resistencia para regadera eléctrica, 3 temperaturas

PROX.

CAJA

- ▶ Con 3 temperaturas
- ▶ Compatible con la regadera eléctrica 114891 y 114892



3 años GARANTÍA

euro

NOM

CÓDIGO			DISTRIB.	MAYOREO	LISTA
114895	4	24	\$65.00	\$93.00	\$115.00

Resistencia para regadera eléctrica, 4 temperaturas

PROX.

CAJA

- ▶ Con 4 temperaturas
- ▶ Compatible con la regadera eléctrica 114896 y 114897



3 años GARANTÍA

euro

NOM

CÓDIGO			DISTRIB.	MAYOREO	LISTA
114899	4	24	\$65.00	\$93.00	\$115.00

Regadera tipo platillo

CAJA

- ▶ Cuerpo fabricado en plástico de alta resistencia
- ▶ Chapetón metálico
- ▶ Brazo plástico
- ▶ Cabeza anti-sarro de 4 1/2"
- ▶ Puntas plásticas para una fácil limpieza



NOM

CÓDIGO			DISTRIB.	MAYOREO	LISTA
114801	4	40	\$110.00	\$155.00	\$195.00

Regadera redonda metálica

CAJA

- ▶ Cabeza metálica de 3 1/2"
- ▶ Incluye brazo y chapetón metálicos



NOM

CÓDIGO			DISTRIB.	MAYOREO	LISTA
114802	4	40	\$90.00	\$129.00	\$160.00

Regadera redonda metálica

CAJA

- ▶ Cabeza metálica de 3 1/2"



NOM

CÓDIGO			DISTRIB.	MAYOREO	LISTA
114803	4	40	\$75.00	\$107.00	\$132.00

Regadera redonda

CABALLETE

- ▶ Resistente cabeza de ABS de 3 1/2"



NOM

CÓDIGO			DISTRIB.	MAYOREO	LISTA
308202	4	40	\$38.00	\$54.00	\$67.00

Regadera de ABS cromada

CAJA

- ▶ Cabeza anti-sarro de 2 1/2"
- ▶ Fácil limpieza



NOM

CÓDIGO			DISTRIB.	MAYOREO	LISTA
114804	4	40	\$45.00	\$64.00	\$79.00

Regadera cuadrada metálica

CAJA

- ▶ Cabeza metálica de 2"
- ▶ Incluye brazo plástico y chapetón metálico



NOM

CÓDIGO			DISTRIB.	MAYOREO	LISTA
114807	4	40	\$95.00	\$136.00	\$170.00

Regadera estándar

CABALLETE

- ▶ Resistente cabeza de ABS
- ▶ Excelente distribución del agua
- ▶ Incluye brazo y chapetón



NOM

CÓDIGO			DISTRIB.	MAYOREO	LISTA
308201	4	40	\$38.00	\$54.00	\$67.00

Regadera de ABS blanca

CAJA

- ▶ Cabeza anti-sarro de 2 1/2"
- ▶ Fácil limpieza



NOM

CÓDIGO			DISTRIB.	MAYOREO	LISTA
114805	4	40	\$43.00	\$61.00	\$76.00

Manguera flexible para monomando

GRANEL

- ▶ Ideal para su uso con monomando AKSI® y MAXTOOL®
- ▶ Trenzado en aluminio
- ▶ Conector de 1/2" de acero inoxidable
- ▶ Conector tipo M10 de latón
- ▶ Longitud de 500 mm



CÓDIGO	LONGITUD			DISTRIB.	MAYOREO	LISTA
103313	50 cm	10	150	\$20.00	\$29.00	\$35.00

Manguera flexible de aluminio para agua

TARJETA

- ▶ Trenzado en aluminio
- ▶ Tramado de 8 hilos de aluminio
- ▶ Espigas de aluminio y férula de acero inoxidable
- ▶ Tuercas metálicas



CÓDIGO	LONG.	DIÁMETRO	USO			DISTRIB.	MAYOREO	LISTA
103307	55 cm	1/2"x1/2"	Freg.	Bolsa c/10 pzas	150	\$17.00	\$24.30	\$30.00
103308	35 cm	1/2"x7/8"	WC	Bolsa c/10 pzas	150	\$16.00	\$22.90	\$28.00
103310	40 cm	1/2"x1/2"	Lavabo	Bolsa c/10 pzas	150	\$15.00	\$21.40	\$26.00
103311	60 cm	1/2"x3/4"	Boiler	Bolsa c/10 pzas	150	\$27.00	\$39.00	\$48.00
103312	60 cm	3/4"x3/4"	Boiler	Bolsa c/10 pzas	150	\$30.00	\$43.00	\$53.00

Manguera flexible de aluminio para agua

TARJETA

- ▶ Trenzado en aluminio
- ▶ Tramado de 8 hilos de aluminio
- ▶ Espigas de aluminio y férula de acero inoxidable
- ▶ Tuercas metálicas



CÓDIGO	LONG.	DIÁMETRO	USO			DISTRIB.	MAYOREO	LISTA
307601	55 cm	1/2"x1/2"	Freg.	6	96	\$14.00	\$20.00	\$24.70
307602	35 cm	1/2"x7/8"	WC	6	96	\$14.00	\$20.00	\$24.70
307604	40 cm	1/2"x1/2"	Lavabo	6	96	\$13.00	\$18.60	\$22.90
307605	60 cm	1/2"x3/4"	Boiler	6	96	\$22.00	\$31.00	\$39.00
307606	60 cm	3/4"x3/4"	Boiler	6	96	\$25.00	\$36.00	\$44.00

Manguera flexible de vinil con tuerca plástica, para WC o lavabo

PROX.

GRANEL

- ▶ Trenzado plástico
- ▶ Conector de 7/8" plástica
- ▶ Para uso en WC o lavabo



GRANEL

- ▶ Trenzado plástico
- ▶ Conector de 1/2" plástica
- ▶ Para uso en lavabo



CÓDIGO	LONGITUD	DIÁMETRO	USO			DISTRIB.	MAYOREO	LISTA
307631	35 cm	1/2"x7/8"	WC	6	96	\$11.00	\$15.70	\$19.40
307632	50 cm	1/2"x7/8"	WC	6	96	\$13.00	\$18.60	\$22.90
307633	60 cm	1/2"x7/8"	WC	6	96	\$14.00	\$20.00	\$24.70

CÓDIGO	LONGITUD	DIÁMETRO	USO			DISTRIB.	MAYOREO	LISTA
307641	40 cm	1/2"x1/2"	Lavabo	6	96	\$12.00	\$17.10	\$21.20
307642	50 cm	1/2"x1/2"	Lavabo	6	96	\$13.00	\$18.60	\$22.90
307643	100 cm	1/2"x1/2"	Lavabo	6	96	\$20.00	\$29.00	\$35.00

Manguera flexible de aluminio en "Y" para lavabo

PROX.

GRANEL

- ▶ Trenzado plástico
- ▶ Tuercas metálicas de 1/2"
- ▶ Para uso en lavabo

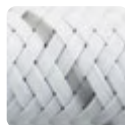

CONEXIÓN DE LATÓN



CÓDIGO	LONGITUD	DIÁMETRO			DISTRIB.	MAYOREO	LISTA
307651	55 cm	1/2"x1/2" x 1/2"	6	96	\$60.00	\$86.00	\$106.00

Manguera flexible de vinil en "Y" para lavabo

PROX.

GRANEL

- ▶ Trenzado plástico
- ▶ Tuercas plásticas de 1/2"
- ▶ Para uso en lavabo

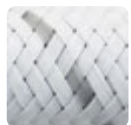

CONEXIÓN PLÁSTICA



CÓDIGO	LONGITUD	DIÁMETRO			DISTRIB.	MAYOREO	LISTA
307652	55 cm	1/2"x1/2" x 1/2"	6	96	\$50.00	\$71.00	\$88.00

Manguera para usos generales

GRANEL

- ▶ Flexibilidad y resistencia al uso rudo
- ▶ Diámetro de manguera 3/8"



CÓDIGO	LONGITUD		DISTRIB.	MAYOREO	LISTA
102951	50 m	1	\$445.00	\$635.00	\$785.00

Manguera industrial

GRANEL

- ▶ Flexibilidad y resistencia al uso rudo
- ▶ De uso general
- ▶ Recomendado para conducción de líquidos no abrasivos

DIÁMETRO

ESPESOR



CÓDIGO	DIÁMETRO	ESPESOR	LONGITUD	DISTRIB.	MAYOREO	LISTA
102921	5/16" - 8 mm	1,02 mm	100 m	\$470.00	\$670.00	\$830.00
102922	3/8" - 10 mm	1,49 mm	100 m	\$680.00	\$970.00	\$1,200.00
102923	1/2" - 13 mm	1,70 mm	100 m	\$1,050.00	\$1,500.00	\$1,850.00
102924	3/4" - 19 mm	1,78 mm	100 m	\$2,150.00	\$3,070.00	\$3,790.00
102925	1" - 25 mm	2,39 mm	100 m	\$3,500.00	\$5,000.00	\$6,175.00

Manguera flexible (usos generales) conector de 3/8"

TARJETA COLGANTE

- ▶ Conectores de latón de 3/8"
- ▶ Cumple con requerimientos de protección civil
- ▶ Presión máxima 300 PSI
- ▶ Tramado reforzado
- ▶ Espesor de 3,4 mm
- ▶ Usos: tanque de gas, estufa, boiler, etc.



CÓDIGO	LONGITUD		DISTRIB.	MAYOREO	LISTA
103321	60 cm	5	\$55.00	\$79.00	\$97.00
103322	1 m	5	\$60.00	\$86.00	\$106.00
103323	1,5 m	5	\$70.00	\$100.00	\$123.00
103324	2 m	5	\$76.00	\$109.00	\$134.00
103325	3 m	5	\$90.00	\$129.00	\$160.00
103326	5 m	5	\$115.00	\$165.00	\$205.00

Manguera de poliducto flexible (sin guía)

GRANEL

- ▶ Elaborado con polietileno de alta densidad
- ▶ Ideal para instalaciones eléctricas en cualquier tipo de construcción
- ▶ Evita el uso de codos y curvas gracias a su gran flexibilidad



CÓDIGO	DIÁMETRO	LONGITUD		DISTRIB.	MAYOREO	LISTA
307620	1/2" - 13 mm	100 m	1	\$250.00	\$355.00	\$440.00
307621	3/4" - 19 mm	50 m	1	\$250.00	\$355.00	\$440.00

Manguera de nivel

GRANEL

- ▶ Elaborado con PVC de excelente calidad que le brinda gran transparencia y brillantez
- ▶ Flexibilidad y resistencia al uso rudo
- ▶ Recomendado para la conducción de líquidos no abrasivos

DIÁMETRO

CÓDIGO	DIÁMETRO	LONGITUD		DISTRIB.	MAYOREO	LISTA
102909	5/16" - 8 mm	100 m	1	\$370.00	\$530.00	\$655.00
102910	3/8" - 10 mm	100 m	1	\$465.00	\$665.00	\$820.00

Manguera de aire (baja presión) 1/4"

TARJETA

- ▶ Manguera reforzada con conexiones de 1/4"
- ▶ Para su uso en equipos neumáticos

PRESIÓN de trabajo
250 PSI
 17 kg / cm²
5 años GARANTÍA

CÓDIGO	DIÁMETRO	LONGITUD		DISTRIB.	MAYOREO	LISTA
102911	1/4" - 6.3 mm	5 m	3	\$95.00	\$136.00	\$170.00
102912	1/4" - 6.3 mm	10 m	3	\$150.00	\$215.00	\$265.00
102913	1/4" - 6.3 mm	15 m	3	\$200.00	\$285.00	\$355.00

Set para riego de jardinería con pistola plástica

TARJETA

- ▶ Manguera de 1/2" reforzada con 10 m de largo, fabricada en 3 capas
- ▶ Conectores de 1/2" NPT
- ▶ Pistola plástica de 4"



CÓDIGO	LONGITUD		DISTRIB.	MAYOREO	LISTA
102931	10 m	6	\$155.00	\$220.00	\$275.00

Set para riego de jardinería con pistola plástica 5 funciones

TARJETA

- ▶ Manguera de 1/2" reforzada con 15 m de largo, fabricada en 3 capas
- ▶ Conectores de 1/2" NPT
- ▶ Pistola plástica de 5 funciones



CÓDIGO	LONGITUD		DISTRIB.	MAYOREO	LISTA
102932	15 m	6	\$195.00	\$280.00	\$345.00

Set para riego de jardinería con pistola plástica 8 funciones

PROX.

TARJETA

- ▶ Manguera de 1/2" reforzada con 15 m de largo, fabricada en 3 capas
- ▶ Conectores de 1/2" NPT
- ▶ Pistola plástica de 8 funciones



CÓDIGO	LONGITUD		DISTRIB.	MAYOREO	LISTA
102933	15 m	3	\$235.00	\$335.00	\$415.00

Set para riego de jardinería con pistola plástica 5 funciones

TARJETA

- ▶ Manguera de 1/2" reforzada con 20 m de largo, fabricada en 3 capas
- ▶ Conectores de 1/2" NPT
- ▶ Pistola plástica de 5 funciones



CÓDIGO	LONGITUD		DISTRIB.	MAYOREO	LISTA
102934	20 m	3	\$260.00	\$370.00	\$460.00

Complementos

Chiflón de latón para manguera

BLÍSTER

- ▶ Cuerpo 100% de latón de alta resistencia
- ▶ Ajustable para riego a chorro y fino rocío
- ▶ Incluye empaque



CÓDIGO	TAMAÑO			DISTRIB.	MAYOREO	LISTA
104001	3"	6	60	\$48.00	\$69.00	\$85.00
104002	3 1/2"	6	60	\$57.00	\$81.00	\$101.00

Conectores para riego juego de 4 piezas

TARJETA

- ▶ Ideal para intercambiar al instante mangueras y accesorios de riego con conectores click
- ▶ Interrumpe el flujo de agua al desconectarse
- ▶ Cuerda estándar de 3/4" NPT
- ▶ Incluye empaque



CÓDIGO	ROSCA	TIPO			DISTRIB.	MAYOREO	LISTA
102411	3/4"	Macho/Hembra	12	72	\$45.00	\$64.00	\$79.00

Empaque de hule para manguera

BOLSA

- ▶ Medida estándar para colocarse en cualquier tipo de conexión con cuerda de 3/4"
- ▶ Práctico sistema para despachar por piezas



PRECIO POR BOLSA

CÓDIGO	Ø			DISTRIB.	MAYOREO	LISTA
102418	3/4"	100 pzas x bolsa	10 bolsas	\$45.00	\$64.00	\$79.00

Empacado en bolsa con 100 piezas

Manguera de 5/8" reforzada para jardín

GRANEL

- ▶ Flexibilidad y resistencia al uso rudo
- ▶ Fabricada en PVC,
- ▶ Reforzada con tramado textil
- ▶ Fabricada en 3 capas



CÓDIGO	DIÁMETRO	ESPESOR	LONGITUD	DISTRIB.	MAYOREO	LISTA
102941	5/8"-16mm	2.4 mm	100 m	\$1,500.00	\$2,145.00	\$2,645.00
102942	3/4"-19mm	2.6 mm	100 m	\$2,000.00	\$2,855.00	\$3,530.00
102943	1"-25mm	3.4 mm	50 m	\$1,700.00	\$2,430.00	\$3,000.00

Mango de cepillo para impermeabilizar

GRANEL

- ▶ Mango de madera perfilada



CÓDIGO	LARGO	DISTRIB.	MAYOREO	LISTA	
109308	1.2 m	N/A	\$22.00	\$31.00	\$39.00

Manguera de 1/2" para jardín con conector

TARJETA

- ▶ Manguera reforzada y fabricada en 3 capas
- ▶ Conectores crimpados para evitar fugas

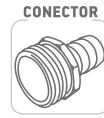

CÓDIGO	LONGITUD	ESPESOR	DISTRIB.	MAYOREO	LISTA	
102903	10 m	1.8 mm	3	\$135.00	\$195.00	\$240.00
102904	15 m	1.8 mm	3	\$175.00	\$250.00	\$310.00
102905	20 m	1.8 mm	3	\$220.00	\$315.00	\$390.00
102906	25 m	1.8 mm	3	\$255.00	\$365.00	\$450.00

Mango de madera para escoba de jardín sin cuerda

GRANEL

- ▶ Mango de madera perfilada con un tratamiento especial para eliminar el exceso de humedad



CÓDIGO	DISTRIB.	MAYOREO	LISTA	
109301	N/A	\$25.00	\$36.00	\$44.00

Manguera de 1/2" para jardín 100 m

GRANEL

- ▶ Manguera reforzada y fabricada en 3 capas
- ▶ Espesor 1.8 mm



CÓDIGO	DIÁMETRO	LONGITUD	DISTRIB.	MAYOREO	LISTA	
102907	1/2"-12.7 mm	100 m	1	\$770.00	\$1,100.00	\$1,360.00

Mango para pala

GRANEL

- ▶ Mango largo: madera pulido y laqueado de 36"
- ▶ Mango "Y": alma de madera con recubrimiento de polipropileno y puño con ángulo



109306

109307



CÓDIGO	DESCRIPCIÓN	DISTRIB.	MAYOREO	LISTA	
109306	Mango "Y"	N/A	\$69.00	\$99.00	\$122.00
109307	Mango largo	N/A	\$115.00	\$165.00	\$205.00

Mango para zapapico, hacha de media y labor entera de 36"

GRANEL

- ▶ Mango de madera perfilada de encino estufado con un tratamiento especial para eliminar el exceso de humedad



109304

109303



CÓDIGO	DISTRIB.	MAYOREO	LISTA	
109303	N/A	\$98.00	\$140.00	\$175.00
109304	N/A	\$78.00	\$111.00	\$138.00

Machetes

GRANEL

- ▶ Hoja pulida fabricada en acero al alto carbono
- ▶ La hoja del machete llega al final de la cacha
- ▶ Cacha de 4 remaches



CÓDIGO	TAMAÑO	TIPO			DISTRIB.	MAYOREO	LISTA
101601	14"	Estándar	12	36	\$50.00	\$71.00	\$88.00
101602	16"	Estándar	12	36	\$50.00	\$71.00	\$88.00
101603	18"	Estándar	12	36	\$51.00	\$73.00	\$90.00
101604	20"	Estándar	12	36	\$52.00	\$74.00	\$92.00
101605	22"	Estándar	12	36	\$54.00	\$77.00	\$95.00
101606	24"	Estándar	12	36	\$56.00	\$80.00	\$99.00
101607	26"	Estándar	12	36	\$58.00	\$83.00	\$102.00
101608	24"	Acapulqueño	12	36	\$59.00	\$84.00	\$104.00
101609	27"	Acapulqueño	12	36	\$59.00	\$84.00	\$104.00
101610	27"	Caguayana	12	36	\$59.00	\$84.00	\$104.00

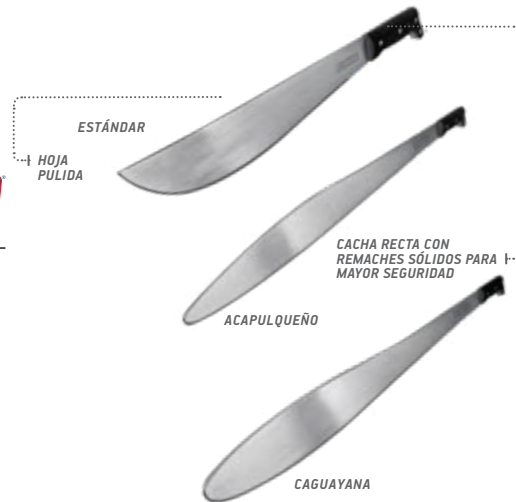

Malla hexagonal

PROX.

ROLLO

- ▶ Malla formada por alambres de acero galvanizado torcidos entre sí, resistente a la corrosión
- ▶ Refuerzo de alambre cada 30 cm para mayor resistencia



CÓDIGO	CALIBRE	MEDIDA	ABERTURA	DISTRIB.	MAYOREO	LISTA
117091	23	45 m x 0.9 m	13 mm	\$1,200.00	\$1,715.00	\$2,115.00
117092	22	45 m x 1 m	25 mm	\$810.00	\$1,155.00	\$1,430.00
117093	22	45 m x 1.2 m	25 mm	\$980.00	\$1,400.00	\$1,730.00
117094	22	45 m x 1.5 m	25 mm	\$1,200.00	\$1,715.00	\$2,115.00
117095	22	45 m x 1.75 m	25 mm	\$1,450.00	\$2,070.00	\$2,560.00
117096	20	45 m x 1.5 m	38 mm	\$1,150.00	\$1,645.00	\$2,030.00
117097	20	45 m x 1.75 m	38 mm	\$1,300.00	\$1,855.00	\$2,295.00
117098	20	45 m x 1.5 m	50 mm	\$850.00	\$1,215.00	\$1,500.00

Malla para plafón

ROLLO

- ▶ Malla metálica de una sola pieza fabricada de lámina ranurada y estirada en frío
- ▶ Ideal para usar en muros falsos, fachadas aparentes, cancelas, marquesinas y forros de aislantes térmicos
- ▶ 22 m de longitud



CÓDIGO	TIPO	ANCHO	DISTRIB.	MAYOREO	LISTA
117031	500	0.91 m	\$580.00	\$830.00	\$1,025.00

Multimalla

ROLLO

- ▶ Fabricada en acero galvanizado
- ▶ Rejilla electrosoldada en punto de cruce
- ▶ Calibre 14
- ▶ Aberturas homogéneas
- ▶ Ideal para jaulas, protección como reja, exhibidores, etc.
- ▶ Rollo de 20 m

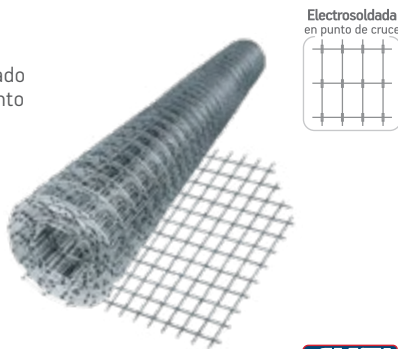

CÓDIGO	ABERTURA	ANCHO	DISTRIB.	MAYOREO	LISTA
117081	5 x 5 cm	1.22 m	\$1,500.00	\$2,145.00	\$2,645.00
117082	5 x 10 cm	1.22 m	\$1,150.00	\$1,645.00	\$2,030.00

Malla criba

ROLLO

- ▶ Fabricada en acero galvanizado
- ▶ Rejilla electrosoldada en punto de cruce
- ▶ Ideal para cernir materiales y en trabajos de construcción
- ▶ Rollo de 30 m



CÓDIGO	ABERTURA	ANCHO	DISTRIB.	MAYOREO	LISTA
117071	2 x 2 cuadros x in ²	0.91 m	\$2,400.00	\$3,430.00	\$4,235.00
117072	3 x 3 cuadros x in ²	0.91 m	\$2,450.00	\$3,500.00	\$4,320.00
117073	4 x 4 cuadros x in ²	0.91 m	\$2,500.00	\$3,570.00	\$4,410.00

Martillo con mango de fibra de vidrio uña curva

GRANEL

- ▶ Cabeza forjada y templada en acero alto carbono
- ▶ Mango confort grip
- ▶ Cabeza de 16 oz.
- ▶ Dureza de uña: 40-50 HRc
- ▶ Dureza de cabeza: 45-55 HRc



CÓDIGO	CABEZA			DISTRIB.	MAYOREO	LISTA
105009	16 oz	6	36	\$100.00	\$143.00	\$175.00

Martillo mango tubular y neopreno uña curva

GRANEL

- ▶ Forjado en acero al carbono y mango
- ▶ Acabado tubular con cabeza pulida y laqueada
- ▶ Dureza de cabeza: 45-55 HRc
- ▶ Dureza de uña: 40-50 HRc
- ▶ Cabeza: 16 oz



CÓDIGO	CABEZA			DISTRIB.	MAYOREO	LISTA
300301	16 oz	6	36	\$95.00	\$136.00	\$170.00

Martillo con mango tubular uña curva y uña recta

GRANEL

- ▶ Fabricado en acero alto carbono y encabado tubular para trabajo pesado
- ▶ Cuerpo granallado y laqueado
- ▶ Dureza de cabeza: 45-55 HRc
- ▶ Dureza de uña: 40-50 HRc



CÓDIGO	CABEZA			DISTRIB.	MAYOREO	LISTA
105005	16 oz	6	24	\$90.00	\$129.00	\$160.00
105006	16 oz	6	24	\$90.00	\$129.00	\$160.00

Mazo de hule

GRANEL

- ▶ Proporciona fuertes impactos sin dañar las superficies



CÓDIGO	CABEZA			DISTRIB.	MAYOREO	LISTA
101011	8 oz	12	48	\$45.00	\$64.00	\$79.00
101012	16 oz	6	36	\$65.00	\$93.00	\$115.00
101013	24 oz	6	24	\$90.00	\$129.00	\$160.00

Marro con mango de madera

GRANEL

- ▶ Forjado en acero al carbono con mango de madera pulido y laqueado
- ▶ Encabado al 100% con uña de acero



CÓDIGO	CABEZA	MANGO	DUREZA			DISTRIB.	MAYOREO	LISTA
101001	2 lbs	12"	48-57HRc	6	24	\$120.00	\$170.00	\$210.00
101002	3 lbs	12"	48-57HRc	6	12	\$140.00	\$200.00	\$245.00
101003	4 lbs	12"	48-57HRc	6	12	\$170.00	\$245.00	\$300.00
101004	6 lbs	36"	48-57HRc	N/A	6	\$320.00	\$455.00	\$565.00
101005	8 lbs	36"	48-57HRc	N/A	4	\$410.00	\$585.00	\$725.00
101006	10 lbs	36"	48-57HRc	N/A	4	\$475.00	\$680.00	\$840.00
101007	12 lbs	36"	48-57HRc	N/A	4	\$540.00	\$770.00	\$955.00
101008	14 lbs	36"	48-57HRc	N/A	4	\$640.00	\$915.00	\$1,130.00
101009	16 lbs	36"	48-57HRc	N/A	2	\$720.00	\$1,030.00	\$1,270.00

Martillo con mango de madera uña curva y uña recta

GRANEL

- ▶ Cabeza forjada en acero alto carbono pulida y laqueada
- ▶ Mango de madera pulido y laqueado, encabado con doble uña



CÓDIGO	CABEZA			DISTRIB.	MAYOREO	LISTA
105001	16 oz	6	36	\$80.00	\$114.00	\$141.00
105002	20 oz	6	24	\$95.00	\$136.00	\$170.00
105003	16 oz	6	36	\$80.00	\$114.00	\$141.00
105004	20 oz	6	24	\$95.00	\$136.00	\$170.00

Martillo bola con mango de madera

GRANEL

- ▶ Cabeza forjada en acero al carbono pulida y laqueada
- ▶ Mango de madera pulido y laqueado
- ▶ Encabado con doble uña



CÓDIGO	CABEZA			DISTRIB.	MAYOREO	LISTA
300302	16 oz	6	36	\$110.00	\$155.00	\$195.00
300303	24 oz	6	24	\$140.00	\$200.00	\$245.00
300304	32 oz	6	24	\$160.00	\$230.00	\$280.00
300305	40 oz	6	12	\$185.00	\$265.00	\$325.00

Mascarilla para polvo

CAJA Y BOLSA

- ▶ Ideal para polvo y sustancias no tóxicas
- ▶ Pieza nasal ajustable, ligera y cómoda
- ▶ No dificulta la respiración ni el habla
- ▶ No afecta el campo visual



PRECIO POR PIEZA

CÓDIGO			DISTRIB.	MAYOREO	LISTA
107901	Caja c/50 pzas	10 cajas	\$3.00	\$4.30	\$5.30
107918	6 Bolsa c/10 pzas	36 Bolsas	\$30.00	\$43.00	\$53.00

Mascarilla para polvo y vapores orgánicos

BOLSA

- ▶ Ideal para polvo y vapores orgánicos
- ▶ Pieza nasal ajustable, ligera y cómoda
- ▶ No dificulta la respiración ni el habla
- ▶ No afecta el campo visual



BOLSA CON 2 PIEZAS

CÓDIGO			DISTRIB.	MAYOREO	LISTA
107904	6 Bolsas c/2 pzas	36 Bolsas	\$33.00	\$47.00	\$58.00

Mascarilla plástica con filtro y repuesto (para polvo)

CAJA Y CABALLETE

- ▶ Ideal para polvo y vapores orgánicos
- ▶ Ligera y cómoda
- ▶ Ideal para la industria, construcción, taller y hogar



PRECIO POR PIEZA



CÓDIGO	PRESENTACIÓN			DISTRIB.	MAYOREO	LISTA
306001	Caja	12 piezas	72 piezas	\$18.00	\$26.00	\$32.00
306002	Caballote	6 piezas	72 piezas	\$20.00	\$29.00	\$35.00

Multiherramienta 14 en 1

BLÍSTER

- ▶ Ideal para campamento, casa y oficina
- ▶ Fabricada en acero inoxidable
- ▶ Resorte que ayuda a abrir de manera automática la cabeza de la pinza
- ▶ Incluye estuche para cinturón



HERRAMIENTAS INCLUIDAS

- Pinza punta larga
- Cizalla de corte
- Mordazas de sujeción
- Abrelatas
- Desarmador plano chico
- SERRUCHO
- Desarmador plano largo
- Lima
- Destapador
- Desarmador plano
- Desarmador de cruz
- Quita escamas
- Regla
- Cuchillo

10 años GARANTÍA



CÓDIGO			DISTRIB.	MAYOREO	LISTA
108703	6	72	\$195.00	\$280.00	\$345.00

Multiherramienta 14 en 1

BLÍSTER

- ▶ Ideal para campamento, casa y oficina
- ▶ Fabricada en acero inoxidable
- ▶ Incluye estuche para cinturón



18 meses GARANTÍA



CÓDIGO			DISTRIB.	MAYOREO	LISTA
305401	6	72	\$105.00	\$150.00	\$185.00

Mechero y boquilla para bote de gas roscable y de 1/4 de vuelta

BLÍSTER

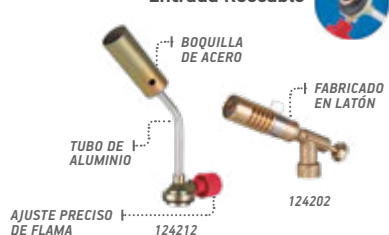

2 años GARANTÍA



MECHERO DE ACERO PARA BOTE DE GAS ROSCABLE Y DE 1/4 DE VUELTA

CÓDIGO	ENTRADA			DISTRIB.	MAYOREO	LISTA
124211	1/4 De vuelta	6	48	\$70.00	\$100.00	\$123.00
124212	Roscable	6	48	\$70.00	\$100.00	\$123.00

BOQUILLA DE LATÓN PARA BOTE DE GAS ROSCABLE Y 1/4 DE VUELTA

CÓDIGO	ENTRADA			DISTRIB.	MAYOREO	LISTA
124201	1/4 De vuelta	6	48	\$150.00	\$215.00	\$265.00
124202	Roscable	6	48	\$150.00	\$215.00	\$265.00

Cartuchos de gas

Encendedor y repuestos



CARTUCHO DE GAS CON VÁLVULA ROSCADA

CÓDIGO	CONTENIDO			DISTRIB.	MAYOREO	LISTA
119571	275 gr.	N/A	6	\$37.00	\$53.00	\$65.00

CARTUCHO DE GAS CON VÁLVULA 1/4 DE VUELTA

CÓDIGO	CONTENIDO			DISTRIB.	MAYOREO	LISTA
119572	220 gr.	6	24	\$37.00	\$53.00	\$65.00

ENCENDEDOR TIPO CAZUELA Y REPUESTOS

CÓDIGO	PRODUCTO			DISTRIB.	MAYOREO	LISTA
124101	Encendedor	6	36	\$22.00	\$31.00	\$39.00
124109	Repuestos	N/A	300	\$14.00	\$20.00	\$24.70

Ménsula tipo escalera

GRANEL

- ▶ Elegante diseño de fácil instalación
- ▶ Funciona con repisas de hasta 30 cm
- ▶ Fabricada en acero
- ▶ Acabado en pintura electrostática

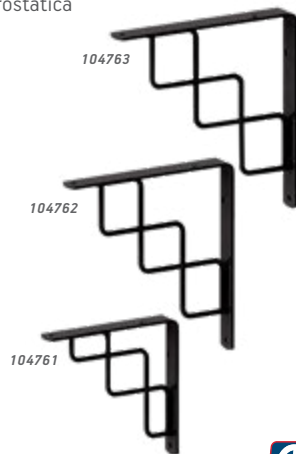

CÓDIGO	MEDIDA			DISTRIB.	MAYOREO	LISTA
104761	150 x 150 mm	10	60	\$35.00	\$50.00	\$62.00
104762	200 x 200 mm	10	40	\$40.00	\$57.00	\$71.00
104763	250 x 250 mm	10	40	\$45.00	\$64.00	\$79.00

Complementos

Escuadra esquinera

BOLSA / BLÍSTER

- ▶ Fabricadas de acero galvanizado
- ▶ Con refuerzo angular
- ▶ Ideales para sostener objetos o reforzar esquineros

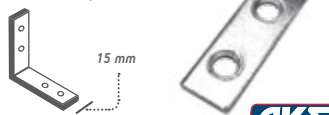

BOLSA

CÓDIGO	MEDIDA	PZAS X BOLSA			DISTRIB.	MAYOREO	LISTA
106601	25 x 15 mm	50	6	24	\$48.00	\$69.00	\$85.00
106602	30 x 15 mm	50	6	24	\$65.00	\$93.00	\$115.00
106603	50 x 15 mm	50	3	12	\$90.00	\$129.00	\$160.00
106604	60 x 15 mm	24	6	24	\$60.00	\$86.00	\$106.00
106605	75 x 15 mm	24	3	18	\$80.00	\$114.00	\$141.00
106606	80 x 15 mm	24	3	18	\$105.00	\$150.00	\$185.00
106607	100 x 15 mm	24	3	12	\$130.00	\$185.00	\$230.00

Mínimo a surtir 1 bolsa

BLÍSTER:

4 ESCUADRAS CON 16 TORNILLOS

PRECIO POR SET

CÓDIGO	MEDIDA			DISTRIB.	MAYOREO	LISTA
106611	25 x 15 mm	12	144	\$16.00	\$22.90	\$28.00
106612	30 x 15 mm	12	144	\$17.00	\$24.30	\$30.00
106613	50 x 15 mm	12	144	\$21.00	\$30.00	\$37.00
106614	60 x 15 mm	12	72	\$23.00	\$33.00	\$41.00
106615	75 x 15 mm	12	72	\$32.00	\$46.00	\$56.00
106617	100 x 15 mm	12	72	\$50.00	\$71.00	\$88.00

Ménsula reforzada

GRANEL

- ▶ Fabricada en acero
- ▶ Acabado en pintura electrostática
- ▶ Máxima resistencia en soporte de carga



COLOR BLANCO

CÓDIGO	MEDIDA			DISTRIB.	MAYOREO	LISTA
104731	8" x 12"	N/A	10	\$43.00	\$61.00	\$76.00
104732	10" x 16"	N/A	10	\$60.00	\$86.00	\$106.00
104733	13" x 20"	N/A	10	\$75.00	\$107.00	\$132.00

COLOR GRIS

CÓDIGO	MEDIDA			DISTRIB.	MAYOREO	LISTA
104741	8" x 12"	N/A	10	\$43.00	\$61.00	\$76.00
104742	10" x 16"	N/A	10	\$60.00	\$86.00	\$106.00
104743	13" x 20"	N/A	10	\$75.00	\$107.00	\$132.00

COLOR NEGRO

CÓDIGO	MEDIDA			DISTRIB.	MAYOREO	LISTA
104751	8" x 12"	N/A	10	\$43.00	\$61.00	\$76.00
104752	10" x 16"	N/A	10	\$60.00	\$86.00	\$106.00
104753	13" x 20"	N/A	10	\$75.00	\$107.00	\$132.00

Ménsulas

GRANEL

- ▶ Fabricada en acero
- ▶ Acabado en pintura electrostática



COLOR BLANCO

CÓDIGO	MEDIDA			DISTRIB.	MAYOREO	LISTA
305501	4" x 5"	24	144	\$4.00	\$5.70	\$7.10
305502	5" x 6"	24	144	\$5.00	\$7.10	\$8.80
305503	6" x 8"	24	144	\$6.00	\$8.60	\$10.60
305504	8" x 10"	24	144	\$10.00	\$14.30	\$17.60
305505	10" x 12"	24	144	\$13.00	\$18.60	\$22.90

COLOR CAFÉ

CÓDIGO	MEDIDA			DISTRIB.	MAYOREO	LISTA
305511	4" x 5"	24	144	\$4.00	\$5.70	\$7.10
305512	5" x 6"	24	144	\$5.00	\$7.10	\$8.80
305513	6" x 8"	24	144	\$6.00	\$8.60	\$10.60
305514	8" x 10"	24	144	\$10.00	\$14.30	\$17.60
305515	10" x 12"	24	144	\$13.00	\$18.60	\$22.90

COLOR GRIS

CÓDIGO	MEDIDA			DISTRIB.	MAYOREO	LISTA
305521	4" x 5"	24	144	\$4.00	\$5.70	\$7.10
305522	5" x 6"	24	144	\$5.00	\$7.10	\$8.80
305523	6" x 8"	24	144	\$6.00	\$8.60	\$10.60
305524	8" x 10"	24	144	\$10.00	\$14.30	\$17.60
305525	10" x 12"	24	144	\$13.00	\$18.60	\$22.90

COLOR NEGRO

CÓDIGO	MEDIDA			DISTRIB.	MAYOREO	LISTA
305531	4" x 5"	24	144	\$4.00	\$5.70	\$7.10
305532	5" x 6"	24	144	\$5.00	\$7.10	\$8.80
305533	6" x 8"	24	144	\$6.00	\$8.60	\$10.60
305534	8" x 10"	24	144	\$10.00	\$14.30	\$17.60
305535	10" x 12"	24	144	\$13.00	\$18.60	\$22.90

Molino manual de prensa para grano

PROX.

CAJA

- ▶ Cuerpo de hierro fundido con recubrimiento de estaño que evita la contaminación de la comida



CÓDIGO		DISTRIB.	MAYOREO	LISTA
309901	6	\$495.00	\$705.00	\$875.00

Molino manual de prensa para carne No. 10

PROX.

CAJA

- ▶ Cuerpo de aluminio
- ▶ Cuchillas y cedazo de acero inoxidable
- ▶ Ajuste tipo prensa



CÓDIGO		DISTRIB.	MAYOREO	LISTA
309911	10	\$370.00	\$530.00	\$655.00

Molino manual montable para carne No. 12 y No. 22

PROX.

CAJA

- ▶ Cuerpo de aluminio
- ▶ Cuchillas y cedazo de acero inoxidable



CÓDIGO	TAMAÑO		DISTRIB.	MAYOREO	LISTA
309912	No. 12	10	\$400.00	\$570.00	\$705.00
309913	No. 22	5	\$690.00	\$985.00	\$1,215.00

Navaja abatible

BLÍSTER

- ▶ Ranura para corte de hilos
- ▶ Clip porta navaja de acero inoxidable
- ▶ Mango de aluminio endurecido forrado con goma termoplástica
- ▶ Sistema de bloqueo seguro



INCLUYE:

- ▶ 6 Cuchillas de 19 mm de acero SK6



CÓDIGO	CUCHILLA			DISTRIB.	MAYOREO	LISTA
102108	19 mm - 3/4"	6	36	\$135.00	\$195.00	\$240.00

Navaja multiusos de aluminio

BLÍSTER

- ▶ Mango ergonómico antiderrapante
- ▶ Compartimento en el cuerpo de la navaja para guardar los repuestos



INCLUYE:

- ▶ 1 Cuchilla para corte de acrílico
- ▶ 5 Cuchillas de repuesto fabricadas en acero SK5



CÓDIGO			DISTRIB.	MAYOREO	LISTA
102107	6	72	\$81.00	\$116.00	\$143.00

Respuestas

Cuchilla para navaja

TARJETA

- ▶ Cuchillas fabricadas en acero SK5
- ▶ Ideal para cortes de alta precisión
- ▶ Repuestos para navaja Cód. 102107 y 102108 AKSI®



PRECIO POR ESTUCHE

CÓDIGO	ESTUCHE			DISTRIB.	MAYOREO	LISTA
102109	5 navajas	12	144	\$13.50	\$19.30	\$23.80
102110	10 navajas	12	144	\$16.00	\$22.90	\$28.00

Nivel profesional magnético de aluminio

GRANEL

- ▶ Resistente cuerpo de aluminio con protectores plásticos
- ▶ 3 Gotas en 45°, 90° y 180°
- ▶ Variación máxima 1 mm x metro



CÓDIGO	MEDIDA			DISTRIB.	MAYOREO	LISTA
104811	12"	6	36	\$75.00	\$107.00	\$132.00
104804	16"	6	36	\$95.00	\$136.00	\$170.00
104805	18"	6	36	\$105.00	\$150.00	\$185.00
104806	24"	6	36	\$125.00	\$180.00	\$220.00
104812	36"	6	24	\$195.00	\$280.00	\$345.00
104813	48"	6	24	\$220.00	\$315.00	\$390.00

Nivel de aluminio

TARJETA

- ▶ Resistente cuerpo de aluminio con protectores plásticos
- ▶ 3 Gotas en 45°, 90° y 180°



CÓDIGO	MEDIDA			DISTRIB.	MAYOREO	LISTA
303102	14"	6	36	\$55.00	\$79.00	\$97.00
303103	18"	6	36	\$65.00	\$93.00	\$115.00
303104	24"	6	36	\$75.00	\$107.00	\$132.00

Nivel torpedo magnético de 9"

BLÍSTER

- ▶ Cuerpo plástico con imán que facilita el trabajo a manos libres
- ▶ Gotas de acrílico con tres posiciones: 45°, 90° y 180°



CÓDIGO	MEDIDA			DISTRIB.	MAYOREO	LISTA
303101	9"	10	60	\$25.00	\$36.00	\$44.00

Overol desechable

BOLSA

- ▶ Espesor 0,28 mm
- ▶ Tela interior de polipropileno
- ▶ Tela exterior de polietileno
- ▶ Ideal para trabajar con líquidos no abrasivos



CÓDIGO	TALLA			DISTRIB.	MAYOREO	LISTA
107931	Chica	5	25	\$70.00	\$100.00	\$123.00
107932	Mediana	5	25	\$70.00	\$100.00	\$123.00
107933	Grande	5	25	\$70.00	\$100.00	\$123.00
107934	Extra grande	5	25	\$70.00	\$100.00	\$123.00

Orejera protectora

CABALLETE

- ▶ Ideal para uso industrial o actividades donde el nivel sonoro sea alto
- ▶ Orejera con almohadillas
- ▶ Ajustable al tamaño de la cabeza



CÓDIGO			DISTRIB.	MAYOREO	LISTA
108004	4	40	\$85.00	\$121.00	\$150.00

Protector facial con refuerzo de aluminio y repuestos

CABALLETE

- ▶ Mica de policarbonato antirrayadura con refuerzo de aluminio
- ▶ Suspensión con ajuste tipo matraca



CÓDIGO	DESCRIP.		DISTRIB.	MAYOREO	LISTA
107831	Protector	10	\$150.00	\$215.00	\$265.00
107832	Mica	36	\$70.00	\$100.00	\$123.00

Caña de pescar con carrete

NUEVO

TARJETA

- ▶ Caña de fibra de vidrio con grafito
- ▶ Carrete en línea abierto con sistema anti-bloqueo
- ▶ Manivela de 2 posiciones
- ▶ Caña de 2 secciones
- ▶ Ojillos cerámicos



310001		310002	
Longitud de caña	1.8 m	Longitud de caña	2.1 m
Longitud de hilo	120 m	Longitud de hilo	120 m
Diámetro de hilo	0.37 mm	Diámetro de hilo	0.37 mm
Soporte de peso	3.5 a 6.5 kg	Soporte de peso	3.5 a 6.5 kg

CÓDIGO	LARGO		DISTRIB.	MAYOREO	LISTA
310001	1.8 m	10	\$485.00	\$695.00	\$855.00
310002	2.1 m	10	\$520.00	\$745.00	\$915.00

Caña telescópica con carrete y accesorios

NUEVO

TARJETA

- ▶ Caña de fibra de vidrio
- ▶ Carrete en línea abierto con sistema anti-bloqueo
- ▶ Manivela de 2 posición

Incluye:

- 1 Caña para pescar
- 1 Carrete con línea
- 1 Señuelo
- 1 Flotador
- 1 Cebo falso
- 3 Plomadas
- 3 Anzuelos con línea



CÓDIGO	LARGO			DISTRIB.	MAYOREO	LISTA
310011	1.8 m de 5 secciones	5	20	\$260.00	\$370.00	\$460.00
310012	2.1 m de 6 secciones	5	20	\$335.00	\$480.00	\$590.00

Anzuelo

PROX.

CAJA

- ▶ Fabricado en acero al carbono
- ▶ Revestimiento niquelado
- ▶ Ojo redondo
- ▶ Punta recta "tipo aguja"



Presentación en caja con 100 piezas

CÓDIGO	TAMAÑO		DISTRIB.	MAYOREO	LISTA	
310021	No. 8	10	80	\$68.00	\$97.00	\$120.00
310022	No. 9	10	160	\$45.00	\$64.00	\$79.00
310023	No. 10	10	160	\$37.00	\$53.00	\$65.00
310024	No. 11	10	160	\$34.00	\$49.00	\$60.00
310025	No. 12	10	160	\$30.00	\$43.00	\$53.00
310026	No. 13	10	160	\$24.00	\$34.00	\$42.00
310027	No. 14	10	160	\$21.00	\$30.00	\$37.00
310028	No. 15	10	160	\$20.00	\$29.00	\$35.00
310029	No. 16	10	160	\$20.50	\$29.00	\$36.00
310030	No. 18	10	160	\$20.00	\$29.00	\$35.00
310031	No. 20	10	160	\$19.50	\$28.00	\$34.00

Hilo de Nylon® para pesca, 100 m multicolor

NUEVO

GRANEL

- ▶ 100% Poliamida
- ▶ Alta resistencia
- ▶ Carrete con 100 m



CÓDIGO	TAMAÑO		DISTRIB.	MAYOREO	LISTA	
310041	0.30 mm	10	240	\$11.00	\$15.70	\$19.40
310042	0.35 mm	10	240	\$12.00	\$17.10	\$21.20
310043	0.40 mm	10	240	\$13.00	\$18.60	\$22.90
310044	0.50 mm	10	240	\$16.00	\$22.90	\$28.00
310045	0.60 mm	10	240	\$20.00	\$29.00	\$35.00
310046	0.70 mm	10	240	\$26.00	\$37.00	\$46.00
310047	0.80 mm	10	180	\$30.00	\$43.00	\$53.00
310048	0.90 mm	10	180	\$37.00	\$53.00	\$65.00
310049	1 mm	10	180	\$45.00	\$64.00	\$79.00

Hilo de Nylon® para pesca, 100 m transparente

PROX.

GRANEL

- ▶ 100% Poliamida
- ▶ Alta resistencia
- ▶ Carrete con 100 m



CÓDIGO	TAMAÑO		DISTRIB.	MAYOREO	LISTA	
310071	0.30 mm	10	240	\$5.80	\$8.30	\$10.20
310072	0.35 mm	10	240	\$6.60	\$9.40	\$11.60
310073	0.40 mm	10	240	\$7.60	\$10.90	\$13.40
310074	0.50 mm	10	240	\$9.00	\$12.90	\$15.90
310075	0.60 mm	10	240	\$12.00	\$17.10	\$21.20
310076	0.70 mm	10	240	\$15.00	\$21.40	\$26.00
310077	0.80 mm	10	180	\$19.00	\$27.00	\$34.00
310078	0.90 mm	10	180	\$23.00	\$33.00	\$41.00
310079	1 mm	10	180	\$26.00	\$37.00	\$46.00

Hilo de Nylon® para pesca, 100 m color verde

PROX.

GRANEL

- ▶ 100% Poliamida
- ▶ Alta resistencia
- ▶ Carrete con 100 m



CÓDIGO	TAMAÑO		DISTRIB.	MAYOREO	LISTA	
310051	0.30 mm	10	240	\$5.80	\$8.30	\$10.20
310052	0.35 mm	10	240	\$6.60	\$9.40	\$11.60
310053	0.40 mm	10	240	\$7.60	\$10.90	\$13.40
310054	0.50 mm	10	240	\$9.00	\$12.90	\$15.90
310055	0.60 mm	10	240	\$12.00	\$17.10	\$21.20
310056	0.70 mm	10	240	\$15.00	\$21.40	\$26.00
310057	0.80 mm	10	180	\$19.00	\$27.00	\$34.00
310058	0.90 mm	10	180	\$23.00	\$33.00	\$41.00
310059	1 mm	10	180	\$26.00	\$37.00	\$46.00

Hilo de Nylon® para pesca, 100 m color azul

NUEVO

GRANEL

- ▶ 100% Poliamida
- ▶ Alta resistencia
- ▶ Carrete con 100 m



CÓDIGO	TAMAÑO		DISTRIB.	MAYOREO	LISTA	
310061	0.30 mm	10	240	\$5.80	\$8.30	\$10.20
310062	0.35 mm	10	240	\$6.60	\$9.40	\$11.60
310063	0.40 mm	10	240	\$7.60	\$10.90	\$13.40
310064	0.50 mm	10	240	\$9.00	\$12.90	\$15.90
310065	0.60 mm	10	240	\$12.00	\$17.10	\$21.20
310066	0.70 mm	10	240	\$15.00	\$21.40	\$26.00
310067	0.80 mm	10	180	\$19.00	\$27.00	\$34.00
310068	0.90 mm	10	180	\$23.00	\$33.00	\$41.00
310069	1 mm	10	180	\$26.00	\$37.00	\$46.00

Hilo de Nylon® para pesca, 100 m color amarillo

PROX.

GRANEL

- ▶ 100% Poliamida
- ▶ Alta resistencia
- ▶ Carrete con 100 m



CÓDIGO	TAMAÑO		DISTRIB.	MAYOREO	LISTA	
310081	0.30 mm	10	240	\$5.80	\$8.30	\$10.20
310082	0.35 mm	10	240	\$6.60	\$9.40	\$11.60
310083	0.40 mm	10	240	\$7.60	\$10.90	\$13.40
310084	0.50 mm	10	240	\$9.00	\$12.90	\$15.90
310085	0.60 mm	10	240	\$12.00	\$17.10	\$21.20
310086	0.70 mm	10	240	\$15.00	\$21.40	\$26.00
310087	0.80 mm	10	180	\$19.00	\$27.00	\$34.00
310088	0.90 mm	10	180	\$23.00	\$33.00	\$41.00
310089	1 mm	10	180	\$26.00	\$37.00	\$46.00

Parrilla de sobreponer

CAJA

- ▶ 2 Quemadores superiores
- ▶ Ajustada para gas L.P. a 2,75 kPa
- ▶ Capacidad térmica de 5 200 kJ/h
- ▶ Dimensión:
 - A - 48 cm
 - B - 24 cm
 - C - 8 cm

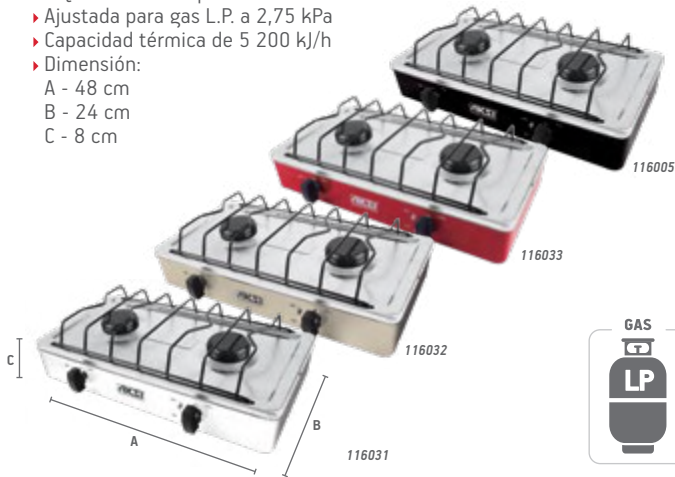

CÓDIGO	COLOR		DISTRIB.	MAYOREO	LISTA
116031	Blanco / Acero inoxidable	1	\$435.00	\$620.00	\$765.00
116032	Almendra / Acero inoxidable	1	\$435.00	\$620.00	\$765.00
116033	Rojo / Acero inoxidable	1	\$435.00	\$620.00	\$765.00
116005	Negro / Acero inoxidable	1	\$440.00	\$630.00	\$775.00

Parrilla de sobreponer

CAJA

- ▶ 4 Quemadores superiores
- ▶ Ajustada para gas L.P. a 2,75 kPa
- ▶ Capacidad térmica de 5 200 kJ/h
- ▶ Dimensión:
 - A - 48 cm
 - B - 48 cm
 - C - 8 cm

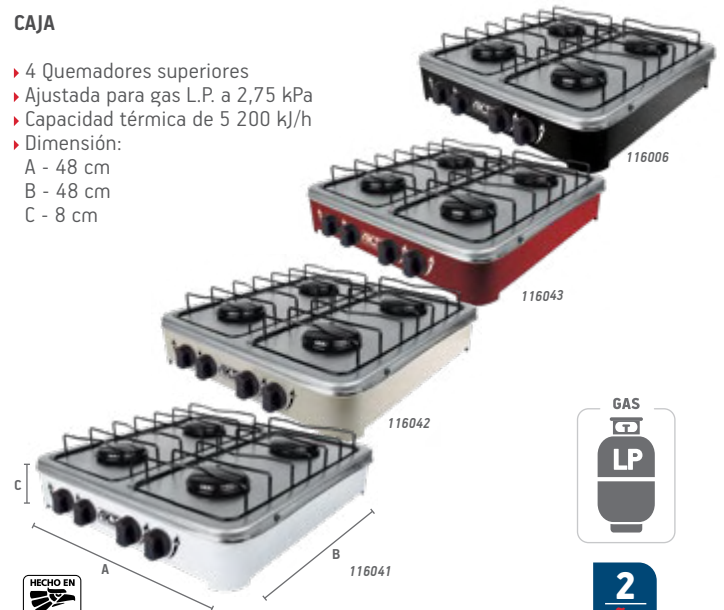

CÓDIGO	COLOR		DISTRIB.	MAYOREO	LISTA
116041	Blanco / Acero inoxidable	1	\$835.00	\$1,195.00	\$1,475.00
116042	Almendra / Acero inoxidable	1	\$835.00	\$1,195.00	\$1,475.00
116043	Rojo / Acero inoxidable	1	\$835.00	\$1,195.00	\$1,475.00
116006	Negro / Acero inoxidable	1	\$810.00	\$1,155.00	\$1,430.00

Parrilla de sobreponer, acero inoxidable

CAJA

- ▶ 2 y 4 quemadores superiores
- ▶ Ajustada para gas L.P. a 2,75 kPa
- ▶ Capacidad térmica de 5 200 kJ/h
- ▶ Dimensión:

116013	116012
A - 48 cm	A - 48 cm
B - 48 cm	B - 24 cm
C - 9.2 cm	C - 9.2 cm

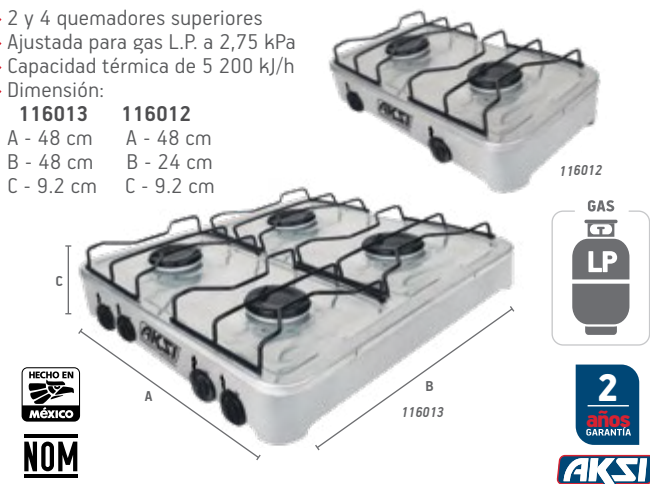

CÓDIGO	QUEMADORES		DISTRIB.	MAYOREO	LISTA
116012	2	1	\$520.00	\$745.00	\$915.00
116013	4	1	\$865.00	\$1,235.00	\$1,525.00

Parrilla negra de sobreponer

CAJA

- ▶ 2 y 4 quemadores superiores
- ▶ Ajustada para gas L.P. a 2,75 kPa
- ▶ Capacidad térmica de 5 200 kJ/h
- ▶ Dimensión:

116004	116003
A - 48 cm	A - 48 cm
B - 48 cm	B - 24 cm
C - 8 cm	C - 8 cm



CÓDIGO	QUEMADORES		DISTRIB.	MAYOREO	LISTA
116003	2	1	\$370.00	\$530.00	\$655.00
116004	4	1	\$680.00	\$970.00	\$1,200.00

Parrilla eléctrica doble con termostato

CAJA

- ▶ 800 W cada elemento calefactor
- ▶ Calefactor de alta eficiencia y ahorro de energía
- ▶ Perillas ajustables con 5 niveles de temperatura
- ▶ Resistencia de acero inoxidable



CARACTERÍSTICAS

Voltaje 127 V~



CÓDIGO	TAMAÑO		DISTRIB.	MAYOREO	LISTA
114922	48.1 x 25 x 5 cm	6	\$450.00	\$645.00	\$795.00

Parrilla eléctrica sencilla 600 W y doble 800 W

CAJA

- ▶ Calefactor de alta eficiencia y ahorro de energía
- ▶ Resistencia de acero inoxidable
- ▶ Fácil de almacenar
- ▶ Perillas ajustables con 5 niveles de temperatura (309202)



CARACTERÍSTICAS

Voltaje 127 V~



CÓDIGO	TAMAÑO	CARACTERÍSTICAS		DISTRIB.	MAYOREO	LISTA
309201	16.9 cm	600 W	6	\$130.00	\$185.00	\$230.00
309202	43.7 x 18.2 x 4.3 cm	800 W	4	\$355.00	\$505.00	\$625.00

Tarja para sobreponer con 4 quemadores

CAJA

- ▶ Fabricada en acero inoxidable 304, resistente a oxidación
- ▶ 4 Quemadores italianos
- ▶ Uso con gas L.P.
- ▶ Perillas laterales, para mayor seguridad
- ▶ 8 soportes, mayor resistencia en peso a cacerolas grandes
- ▶ Esquinas dobladas para evitar filtraciones en los gabinetes
- ▶ Tarja con perforación para mezcladora o monomando



CÓDIGO	DESCRIPCIÓN	MEDIDA	CALIBRE		DISTRIB.	MAYOREO	LISTA
124673	Derecha	150 x 52 cm	22	1	\$4,750.00	\$6,785.00	\$8,380.00
124674	Izquierda	150 x 52 cm	22	1	\$4,750.00	\$6,785.00	\$8,380.00

Estufilla de gas portátil

CAJA

- ▶ Sistema de apagado automático en caso de alta presión de gas
- ▶ Útil para acampar o para emergencias en casa
- ▶ Funciona con un cartucho de gas butano / propano de 1/4 de vuelta, no incluida

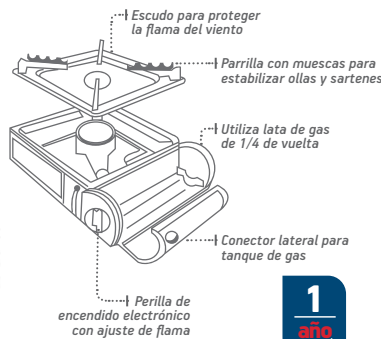

ESTUCHE INCLUIDO

CÓDIGO		DISTRIB.	MAYOREO	LISTA
116021	6	\$430.00	\$615.00	\$760.00

Complementa tu estufilla

Cartucho de gas para estufilla

AEROSOL

- ▶ Cartucho con válvula de 1/4" de vuelta
- ▶ Ideal para utilizar con la estufilla AKSI® código 116021
- ▶ Gas butano / propano



CÓDIGO	CONT.		DISTRIB.	MAYOREO	LISTA
119572	220 gr	6	\$37.00	\$53.00	\$65.00

Pala carbonera puño en "Y"

GRANEL

- ▶ Puño curvo de polipropileno, resistente a fuertes impactos, diseño ergonómico para obtener un mejor agarre
- ▶ Mango "Y": alma de madera con recubrimiento de polipropileno
- ▶ Pala de acero templado CALIBRE 16, soporta hasta 160 kg sin deformarse



CÓDIGO	CALIBRE		DISTRIB.	MAYOREO	LISTA
111204	16	1	\$240.00	\$345.00	\$425.00

Pala cuadrada puño en "Y"

GRANEL

- ▶ Puño de polipropileno, resistente a fuertes impactos, diseño ergonómico para obtener un mejor agarre
- ▶ Mango "Y": alma de madera con recubrimiento de polipropileno
- ▶ Pala de acero templado, soporta hasta 160 kg sin deformarse



CÓDIGO	CALIBRE		DISTRIB.	MAYOREO	LISTA
111201	16	1	\$175.00	\$250.00	\$310.00
111205	16	1	\$200.00	\$285.00	\$355.00

Pala escarramán puño en "Y"

GRANEL

- ▶ Puño de polipropileno, resistente a fuertes impactos, diseño ergonómico para obtener un mejor agarre
- ▶ Mango "Y": alma de madera con recubrimiento de polipropileno
- ▶ Pala de acero templado, soporta hasta 160 kg sin deformarse



CÓDIGO	CALIBRE		DISTRIB.	MAYOREO	LISTA
111203	16	1	\$175.00	\$250.00	\$310.00

Pala redonda puño en "Y"

GRANEL

- ▶ Puño de polipropileno, resistente a fuertes impactos, diseño ergonómico para obtener un mejor agarre
- ▶ Mango "Y": alma de madera con recubrimiento de polipropileno
- ▶ Pala de acero templado, soporta hasta 160 kg sin deformarse

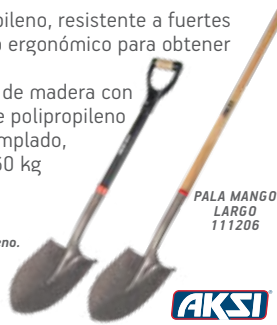

CÓDIGO	CALIBRE		DISTRIB.	MAYOREO	LISTA
111202	16	3	\$175.00	\$250.00	\$310.00
111206	16	3	\$200.00	\$285.00	\$355.00

Mango para pala

GRANEL

- ▶ Mango "Y": alma de madera con recubrimiento de polipropileno y puño con ángulo
- ▶ Mango largo: madera pulido y laqueado de 36"



CÓDIGO	DESCRIPCIÓN		DISTRIB.	MAYOREO	LISTA
109306	Mango "Y"	1	\$69.00	\$99.00	\$122.00
109307	Mango largo	1	\$115.00	\$165.00	\$205.00

Pinza de extensión

BLÍSTER

- ▶ Forjadas en acero al carbono
- ▶ Mangos recubiertos con vinil para un máximo agarre y comodidad
- ▶ Mordazas estriadas para facilitar la sujeción



CÓDIGO	TAMAÑO		DISTRIB.	MAYOREO	LISTA
104615	8"	6 36	\$86.00	\$123.00	\$150.00
104616	10"	6 36	\$105.00	\$150.00	\$185.00
104617	12"	6 36	\$130.00	\$185.00	\$230.00

Pinza de presión

BLÍSTER

- ▶ Mordazas en **ACERO AL CROMO MOLIBDENO**
- ▶ Mordazas estriadas que facilitan la sujeción



CÓDIGO	TAMAÑO	MORDAZA		DISTRIB.	MAYOREO	LISTA
100911	10"	Recta	3 36	\$125.00	\$180.00	\$220.00
100912	10"	Curva	3 36	\$125.00	\$180.00	\$220.00

Pinza de presión

BLÍSTER

- ▶ Mordazas en **ACERO AL CARBONO**
- ▶ Mordazas estriadas que facilitan la sujeción



CÓDIGO	TAMAÑO	MORDAZA		DISTRIB.	MAYOREO	LISTA
306701	10"	Recta	6 36	\$75.00	\$107.00	\$132.00
306702	10"	Curva	6 36	\$75.00	\$107.00	\$132.00

Pinza profesional de electricista mango de vinil

BLÍSTER

- ▶ Mordazas estriadas que optimizan la sujeción
- ▶ Forjadas en acero al Cromo Vanadio

PUNTA PLANA ESTRIADO DIAGONAL



CÓDIGO	TAMAÑO			DISTRIB.	MAYOREO	LISTA
104633	7"	6	36	\$105.00	\$150.00	\$185.00
104634	8"	6	36	\$125.00	\$180.00	\$220.00

Pinza ligera de electricista mango de vinil

BLÍSTER

- ▶ Diseñadas para uso en instalaciones eléctricas
- ▶ Mordazas estriadas que optimizan la sujeción
- ▶ Forjadas en acero al Cromo Vanadio

PUNTA PLANA ESTRIADO DIAGONAL



CÓDIGO	TAMAÑO			DISTRIB.	MAYOREO	LISTA
104631	7"	6	36	\$90.00	\$129.00	\$160.00
104632	8"	6	36	\$105.00	\$150.00	\$185.00

Pinza de corte diagonal mango de vinil

BLÍSTER

- ▶ Diseño que proporciona un mejor corte conservando el filo
- ▶ Pinzas de filos templados que facilitan los cortes
- ▶ Forjadas en acero al Cromo Vanadio

PUNTA ESTÁNDAR CORTE DIAGONAL



CÓDIGO	TAMAÑO			DISTRIB.	MAYOREO	LISTA
104636	6"	6	60	\$70.00	\$100.00	\$123.00
104637	7"	6	36	\$85.00	\$121.00	\$150.00

Pinza de punta y corte mango de vinil

BLÍSTER

- ▶ Diseñadas para trabajar en espacios estrechos y para hacer ajustes de alta precisión
- ▶ Mangos ergonómicos, máximo agarre y comodidad
- ▶ Filos endurecidos para mejor corte y gran durabilidad
- ▶ Forjadas en acero al Cromo Vanadio

PUNTA CÓNICA ESTRIADO DIAGONAL



CÓDIGO	TAMAÑO			DISTRIB.	MAYOREO	LISTA
104638	6"	6	60	\$70.00	\$100.00	\$123.00
104639	7"	6	36	\$75.00	\$107.00	\$132.00
104640	8"	6	36	\$85.00	\$121.00	\$150.00

Pinza pelacables

BLÍSTER

- ▶ Corta cable de cobre y aluminio de diferentes calibres
- ▶ Sistema de cizalla para cortar cables de medidas comunes
- ▶ Mangos ergonómicos recubiertos con vinil
- ▶ Incluye mordaza para apretar terminales
- ▶ Cuenta con corta tornillos de medidas comunes



CÓDIGO	TAMAÑO			DISTRIB.	MAYOREO	LISTA
104614	9"	6	36	\$90.00	\$129.00	\$160.00

Mini pinzas

BLÍSTER

- ▶ **PINZA DE ELECTRICISTA:** Muecas endurecidas y mordazas estriadas para cortar y sujetar
- ▶ **PINZA DE PUNTA EXTRA LARGA:** Puntas de aguja para espacios reducidos
- ▶ **PINZA DE PUNTA CURVA:** Ideal para trabajar en electrónica

- ▶ **PINZA PUNTA Y CORTE:** Muecas endurecidas y mordazas estriadas para cortar y sujetar
- ▶ **PINZA DE PUNTA REDONDA:** Ideales para trabajos de joyería, electrónica y artesanías

- ▶ **PINZA DE CORTE DIAGONAL:** Ideales para trabajos de joyería, electrónica y artesanías
- ▶ **PINZA TIPO TENAZA:** Facilita el corte en superficies planas y rígidas



CÓDIGO	TIPO			DISTRIB.	MAYOREO	LISTA
304101	Mini pinza de electricista 4"	6	60	\$32.00	\$46.00	\$56.00
304102	Mini pinza de punta y corte 4"	6	60	\$32.00	\$46.00	\$56.00
304103	Mini pinza de corte diagonal	6	60	\$32.00	\$46.00	\$56.00
304104	Mini pinza punta extra larga 6"	6	60	\$32.00	\$46.00	\$56.00
304105	Mini pinza de punta curva 4"	6	60	\$32.00	\$46.00	\$56.00
304106	Mini pinza de punta redonda	6	60	\$32.00	\$46.00	\$56.00
304107	Mini pinza tipo tenaza	6	60	\$32.00	\$46.00	\$56.00



Pinza de electricista profesional

TARJETA Y BLÍSTER

- ▶ Forjadas en acero al carbono
- ▶ Mordazas estriadas que facilitan la sujeción
- ▶ Nariz cuadrada resistente a los aprietes extremos
- ▶ Mangos con recubrimiento de vinil antiderrapante



18
meses
GARANTÍA

IT MAXTOOL

CÓDIGO	TAMAÑO	EMPAQUE			DISTRIB.	MAYOREO	LISTA
304501	8"	Tarjeta	6	36	\$85.00	\$121.00	\$150.00
304502	9"	Tarjeta	6	36	\$95.00	\$136.00	\$170.00
CÓDIGO	TAMAÑO	EMPAQUE			DISTRIB.	MAYOREO	LISTA
304517	8"	Blister	6	36	\$87.00	\$124.00	\$155.00
304518	9"	Blister	6	36	\$97.00	\$139.00	\$170.00

Pinza ligera de electricista

TARJETA Y BLÍSTER

- ▶ Fabricadas en acero al carbono
- ▶ Para uso en instalaciones eléctricas
- ▶ Mordazas estriada que facilitan la sujeción
- ▶ Mangos con recubrimiento de vinil antiderrapante



18
meses
GARANTÍA

IT MAXTOOL

CÓDIGO	TAMAÑO	EMPAQUE			DISTRIB.	MAYOREO	LISTA
304503	7"	Tarjeta	6	60	\$50.00	\$71.00	\$88.00
304504	8"	Tarjeta	6	48	\$55.00	\$79.00	\$97.00
CÓDIGO	TAMAÑO	EMPAQUE			DISTRIB.	MAYOREO	LISTA
304519	7"	Blister	6	60	\$55.00	\$79.00	\$97.00
304512	8"	Blister	6	48	\$60.00	\$86.00	\$106.00

Pinza de punta y corte

TARJETA Y BLÍSTER

- ▶ Para uso en espacios estrechos y ajustes de precisión
- ▶ Forjadas en acero al carbono
- ▶ Mordazas estriadas que facilitan la sujeción
- ▶ Mangos con recubrimiento de vinil antiderrapante



18
meses
GARANTÍA

IT MAXTOOL

TARJETA

CÓDIGO	TAMAÑO	EMPAQUE			DISTRIB.	MAYOREO	LISTA
304505	6"	Tarjeta	6	60	\$40.00	\$57.00	\$71.00
304506	7"	Tarjeta	6	60	\$45.00	\$64.00	\$79.00
304507	8"	Tarjeta	6	48	\$50.00	\$71.00	\$88.00

BLÍSTER

304513	6"	Blister	6	60	\$42.00	\$60.00	\$74.00
304520	7"	Blister	6	60	\$50.00	\$71.00	\$88.00
304521	8"	Blister	6	48	\$55.00	\$79.00	\$97.00

Pinza de corte diagonal

TARJETA Y BLÍSTER

- ▶ Fabricada en acero al carbono
- ▶ Pinzas de filos templados que proporcionan un mejor corte y conservan el filo
- ▶ Mangos con recubrimiento de vinil antiderrapante



18
meses
GARANTÍA

IT MAXTOOL

CÓDIGO	TAMAÑO	EMPAQUE			DISTRIB.	MAYOREO	LISTA
304508	6"	Tarjeta	6	60	\$40.00	\$57.00	\$71.00
304509	7"	Tarjeta	6	48	\$45.00	\$64.00	\$79.00
CÓDIGO	TAMAÑO	EMPAQUE			DISTRIB.	MAYOREO	LISTA
304514	6"	Blister	6	60	\$42.00	\$60.00	\$74.00
304522	7"	Blister	6	60	\$50.00	\$71.00	\$88.00

Pinza de chofer

TARJETA Y BLÍSTER

- ▶ Fabricadas en acero al carbono
- ▶ Mordazas estriadas con dos posiciones de ajuste
- ▶ Mangos con recubrimiento de vinil antiderrapante



18
meses
GARANTÍA

IT MAXTOOL

TARJETA

CÓDIGO	TAMAÑO	EMPAQUE			DISTRIB.	MAYOREO	LISTA
304510	6"	Tarjeta	6	60	\$35.00	\$50.00	\$62.00
304511	8"	Tarjeta	6	60	\$45.00	\$64.00	\$79.00

BLÍSTER

304515	6"	Blister	6	60	\$38.00	\$54.00	\$67.00
304516	8"	Blister	6	60	\$47.00	\$67.00	\$83.00

Juego de 3 mini pinzas

BLÍSTER

- ▶ **PUNTA Y CORTE:** Muecas endurecidas y mordazas estriadas para cortar y sujetar
- ▶ **PUNTA REDONDA:** Ideales para engarzar y sujetar cosas pequeñas
- ▶ **CORTE DIAGONAL:** Muecas afiladas para cortar cables y alambres



18
meses
GARANTÍA

IT MAXTOOL

CÓDIGO	PIEZAS			DISTRIB.	MAYOREO	LISTA
304108	3	4	24	\$90.00	\$129.00	\$160.00

Pinza porta electrodo

NUEVO

CAJA

- ▶ Mordaza de latón para una excelente conductividad eléctrica
- ▶ Recubrimiento de fibra de vidrio resistente a temperaturas elevadas
- ▶ Opresor para sujetar el cable



RECUBRIMIENTO DE FIBRA DE VIDRIO

CARACTERÍSTICAS	
Capacidad:	300 A 500 A
Calibre de cable:	2/0 AWG (70 mm ²) 4/0 AWG (120 mm ²)
Largo:	25 cm 32 cm
Peso:	520 g 840 g



CÓDIGO	CAPACIDAD			DISTRIB.	MAYOREO	LISTA
130101	300 A	4	16	\$190.00	\$270.00	\$335.00
130102	500 A	4	16	\$285.00	\$405.00	\$505.00

Pinza porta electrodo

NUEVO

CAJA

- ▶ Mordaza de latón para una excelente conductividad eléctrica
- ▶ Recubrimiento de fibra de vidrio resistente a temperaturas elevadas
- ▶ Opresor para sujetar el cable



CARACTERÍSTICAS	
Capacidad:	300 A 500 A
Calibre de cable:	2/0 AWG (70 mm ²) 4/0 AWG (120 mm ²)
Largo:	23 cm 25 cm
Peso:	345 g 465 g



CÓDIGO	CAPACIDAD			DISTRIB.	MAYOREO	LISTA
310201	300 A	4	16	\$105.00	\$150.00	\$185.00
310202	500 A	4	16	\$125.00	\$180.00	\$220.00

Pinza para tierra

NUEVO

CAJA

- ▶ Resorte de alta precisión, mejor agarre de la pieza de trabajo
- ▶ Lámina de acero galvanizada, resistente a la corrosión
- ▶ Puente de cobre entre mordazas, mejora la conductividad eléctrica



CARACTERÍSTICAS	
Capacidad:	300 A 500 A
Largo:	20 cm 24 cm
Peso:	250 g 380 g

CÓDIGO	CAPACIDAD			DISTRIB.	MAYOREO	LISTA
130111	300 A	4	16	\$71.00	\$101.00	\$125.00
130112	500 A	4	16	\$90.00	\$129.00	\$160.00

Pinza para tierra

NUEVO

CAJA

- ▶ Resorte de alta precisión, mejor agarre de la pieza de trabajo
- ▶ Lámina de acero galvanizada, resistente a la corrosión
- ▶ Puente de cobre entre mordazas, mejora la conductividad eléctrica



CARACTERÍSTICAS	
Capacidad:	300 A 500 A
Largo:	20 cm 24 cm
Peso:	250 g 380 g



CÓDIGO	CAPACIDAD			DISTRIB.	MAYOREO	LISTA
310211	300 A	4	16	\$50.00	\$71.00	\$88.00
310212	500 A	4	16	\$68.00	\$97.00	\$120.00

NUEVO

Complementos

Electrodos para soldadura SMAW

CAJA

- ▶ Corriente CA/CD
- ▶ Inicio de arco rápido y estable
- ▶ Acero suave de fácil fundición
- ▶ De baja escoria
- ▶ No genera porosidad

Estructuras ligeras 6013



Estructuras pesadas 7018



Alta penetración 6011



Ideal para láminas metálicas delgadas, soldadura y herrería en general

Para estructuras en edificios, puentes y construcción de recipientes sometidos a presión

Para acero al carbono, industria metalmeccánica y herrería ligera

CÓDIGO	MEDIDA			DISTRIB.	MAYOREO	LISTA
130301	3/32"	5	20	\$55.00	\$79.00	\$97.00
130302	1/8"	5	20	\$55.00	\$79.00	\$97.00
130303	5/32"	5	20	\$55.00	\$79.00	\$97.00

CÓDIGO	MEDIDA			DISTRIB.	MAYOREO	LISTA
130311	3/32"	5	20	\$60.00	\$86.00	\$106.00
130312	1/8"	5	20	\$60.00	\$86.00	\$106.00
130313	5/32"	5	20	\$60.00	\$86.00	\$106.00

CÓDIGO	MEDIDA			DISTRIB.	MAYOREO	LISTA
130321	3/32"	5	20	\$60.00	\$86.00	\$106.00
130322	1/8"	5	20	\$60.00	\$86.00	\$106.00
130323	5/32"	5	20	\$60.00	\$86.00	\$106.00

Pistola calafateadora tipo esqueleto profesional

GRANEL

- ▶ Mango de inyección de aluminio tipo "T"
- ▶ Cuerpo de acero remachado doblemente al mango
- ▶ Para cartuchos de silicón estándar
- ▶ Émbolo de acero con sección hexagonal que mejora el trinquete



CÓDIGO			DISTRIB.	MAYOREO	LISTA
104501	6	36	\$45.00	\$64.00	\$79.00

Pistola calafateadora con cremallera

GRANEL

- ▶ Fabricada en lámina de acero con sistema de cremallera
- ▶ Para cartuchos de silicón estándar
- ▶ Acabado con pintura electrostática, mayor resistencia a la oxidación



CÓDIGO			DISTRIB.	MAYOREO	LISTA
104502	6	36	\$45.00	\$64.00	\$79.00

Pistola calafateadora con cremallera y lisa

GRANEL

- ▶ Fabricada en lámina de acero con sistema de cremallera (sólo 303901)
- ▶ Para cartuchos de silicón estándar
- ▶ Acabado con pintura electrostática, mayor resistencia a la oxidación



CÓDIGO	DESCRIPCIÓN			DISTRIB.	MAYOREO	LISTA
303901	Cremallera	6	36	\$42.00	\$60.00	\$74.00
303902	Lisa	6	36	\$40.00	\$57.00	\$71.00

Sellador de silicón uso general

BLÍSTER

- ▶ Para uso en interiores y exteriores
- ▶ Excelente adherencia en vidrio, aluminio, azulejo, madera, etc.



CÓDIGO	COLOR	CONTENIDO			DISTRIB.	MAYOREO	LISTA
105211	Transparente	85 g	6	48	\$27.00	\$39.00	\$48.00

Sellador de silicón para calafateadora

TUBO

- ▶ Uso general
- ▶ Para uso en interiores y exteriores
- ▶ Excelente adherencia en vidrio, aluminio, azulejo, madera, etc.
- ▶ Contenido 280 ml



CÓDIGO	COLOR		DISTRIB.	MAYOREO	LISTA
105201	Transparente	12	\$45.00	\$64.00	\$79.00
105202	Blanco	12	\$45.00	\$64.00	\$79.00
105203	Negro	12	\$45.00	\$64.00	\$79.00

Sellador de silicón automotriz

BLÍSTER

- ▶ Resistencia a fluidos de transmisión, agua, aceite y anticongelantes.
- ▶ Resiste temperaturas desde 0° C hasta 310° C



CÓDIGO	COLOR	CONT.			DISTRIB.	MAYOREO	LISTA
105221	Negro	70 g	6	48	\$27.00	\$39.00	\$48.00
105222	Rojo	70 g	6	48	\$27.00	\$39.00	\$48.00

Pistola eléctrica para silicón 10 W

BLÍSTER

- ▶ Utiliza barras de 5/16"
- ▶ Incluye 2 barras de silicón



6 años GARANTÍA

ITI MAXTOOL

NOM

CÓDIGO	VOLTAJE			DISTRIB.	MAYOREO	LISTA
306301	10 W	6	36	\$65.00	\$93.00	\$115.00

Barras de silicón

TARJETA

- ▶ Barra de 5/16" x 4", empaque con 12 piezas
- ▶ Barra de 1/2" x 4", empaque con 6 piezas



CÓDIGO	DIÁMETRO			DISTRIB.	MAYOREO	LISTA
306303	5/16"	8	120	\$13.00	\$18.60	\$22.90
306304	1/2"	8	120	\$13.00	\$18.60	\$22.90

Pistola plástica de riego 4" y 5"

TARJETA

- ▶ Perilla plástica que permite regular el flujo de agua
- ▶ Boquilla con cuerda para accesorios
- ▶ Cuerpo plástico de gran resistencia
- ▶ Seguro de riego continuo



18 meses GARANTÍA
ITIMAXTOOL

CÓDIGO	CONEXIÓN			DISTRIB.	MAYOREO	LISTA
300801	1/2" - 13 mm	12	96	\$15.00	\$21.40	\$26.00
300805	3/4" - 19 mm	12	96	\$17.00	\$24.30	\$30.00

Pistola metálica de riego 4" y 5"

TARJETA

- ▶ Perilla de latón que permite regular el flujo de agua
- ▶ Boquilla con cuerda que permite conectar accesorios
- ▶ Seguro de riego continuo
- ▶ Cuerpo metálico



18 meses GARANTÍA
ITIMAXTOOL

CÓDIGO	CONEXIÓN			DISTRIB.	MAYOREO	LISTA
300802	1/2" - 13 mm	12	96	\$38.00	\$54.00	\$67.00
300803	3/4" - 19 mm	12	96	\$47.00	\$67.00	\$83.00

Chiflón de latón para manguera

BLÍSTER

- ▶ Cuerpo 100% de latón de alta resistencia
- ▶ Ajustable para riego a chorro y fino rocío
- ▶ Incluye empaque

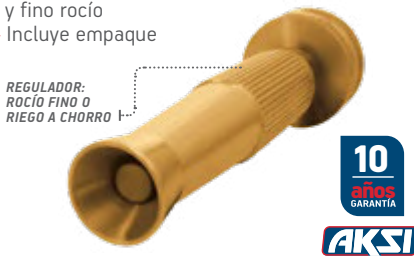

10 años GARANTÍA
AKSI

CÓDIGO	TAMAÑO			DISTRIB.	MAYOREO	LISTA
104001	3"	6	60	\$48.00	\$69.00	\$85.00
104002	3 1/2"	6	60	\$57.00	\$81.00	\$101.00

Pistola plástica de riego boquilla regulable

TARJETA

- ▶ Perilla plástica que permite regular el flujo de agua
- ▶ Boquilla plástica ajustable para riego a chorro o rocío
- ▶ Mango ergonómico antiderrapante
- ▶ Seguro de riego continuo



10 años GARANTÍA
AKSI

CÓDIGO	CONEXIÓN			DISTRIB.	MAYOREO	LISTA
102505	3/4" - 19 mm	12	48	\$40.00	\$57.00	\$71.00

Pistola metálica de riego 5"

TARJETA

- ▶ Perilla metálica que permite regular el flujo de agua
- ▶ Seguro de riego continuo
- ▶ Cuerpo metálico



10 años GARANTÍA
AKSI

CÓDIGO	CONEXIÓN			DISTRIB.	MAYOREO	LISTA
102504	3/4" - 19 mm	6	36	\$70.00	\$100.00	\$123.00

Chiflón plástico para manguera

TARJETA

- ▶ Resistente cuerpo de polipropileno
- ▶ Casquillo de ABS
- ▶ Incluye empaque



18 meses GARANTÍA
ITIMAXTOOL

CÓDIGO	TAMAÑO			DISTRIB.	MAYOREO	LISTA
300601	4"	48	288	\$12.00	\$17.10	\$21.20

Pistola plástica de riego 8 funciones

TARJETA

- ▶ Perilla que permite regular el flujo de agua
- ▶ Boquilla ajustable para riego con 8 funciones
- ▶ Seguro de riego continuo
- ▶ Mango ergonómico antiderrapante



10 años GARANTÍA
AKSI

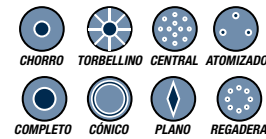

CÓDIGO	CONEXIÓN			DISTRIB.	MAYOREO	LISTA
102507	3/4" - 19 mm	6	36	\$50.00	\$71.00	\$88.00

Pistola plástica de riego 5 funciones

TARJETA

- ▶ Perilla plástica que permite regular el flujo de agua
- ▶ Boquilla ajustable para riego con 5 funciones
- ▶ Seguro de riego continuo



18 meses GARANTÍA
ITIMAXTOOL

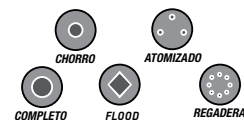

CÓDIGO	CONEXIÓN			DISTRIB.	MAYOREO	LISTA
300804	3/4" - 19 mm	12	48	\$30.00	\$43.00	\$53.00

CROME®

N O S R E N O V A M O S

Nueva imagen . Mantenemos una excelente calidad



► Pintura en aerosol . primarios . para madera . esmaltes . brochas . cepillos . charolas . pistolas . rodillos y más.



¡TIPS DE USO!

Pintura en aerosol colores regulares 400 ml

AEROSOL

► Pintura acrílica de secado rápido, anticorrosiva, útil para interiores y exteriores



Mostrario de color
AEROSOL



CÓDIGO	CÓDIGO DE COLOR	COLOR			DISTRIB.	MAYOREO	LISTA
114251	PA-005	○ Transparente	4	16	\$35.00	\$50.00	\$62.00
114252	PA-010	○ Blanco Mate	4	16	\$35.00	\$50.00	\$62.00
114253	PA-015	○ Blanco brillante	4	16	\$35.00	\$50.00	\$62.00
114275	PA-130	● Crema	4	16	\$35.00	\$50.00	\$62.00
114255	PA-110	● Amarillo canario	4	16	\$35.00	\$50.00	\$62.00
114256	PA-115	● Amarillo medio	4	16	\$35.00	\$50.00	\$62.00
114257	PA-205	● Naranja brillante	4	16	\$35.00	\$50.00	\$62.00
114258	PA-305	● Naranja oscuro	4	16	\$35.00	\$50.00	\$62.00
114259	PA-310	● Rojo	4	16	\$35.00	\$50.00	\$62.00
114261	PA-308	● Rojo intenso	4	16	\$35.00	\$50.00	\$62.00
114276	PA-306	● Rosa mexicano	4	16	\$35.00	\$50.00	\$62.00
114277	PA-425	● Violeta	4	16	\$35.00	\$50.00	\$62.00
114264	PA-415	● Azul oscuro	4	16	\$35.00	\$50.00	\$62.00
114263	PA-410	● Azul rey	4	16	\$35.00	\$50.00	\$62.00
114262	PA-405	● Azul claro	4	16	\$35.00	\$50.00	\$62.00
114265	PA-505	● Verde manzana	4	16	\$35.00	\$50.00	\$62.00
114266	PA-510	● Verde ecológico	4	16	\$35.00	\$50.00	\$62.00
114267	PA-515	● Verde oscuro	4	16	\$35.00	\$50.00	\$62.00
114268	PA-610	● Café oscuro	4	16	\$35.00	\$50.00	\$62.00
114278	PA-615	● Chocolate	4	16	\$35.00	\$50.00	\$62.00
114269	PA-705	● Gris claro	4	16	\$35.00	\$50.00	\$62.00
114271	PA-715	● Gris oscuro	4	16	\$35.00	\$50.00	\$62.00
114273	PA-805	● Negro mate	4	16	\$35.00	\$50.00	\$62.00
114274	PA-815	● Negro brillante	4	16	\$35.00	\$50.00	\$62.00
114279	PA-825	● Negro satinado	4	16	\$35.00	\$50.00	\$62.00

La referencia del color puede variar, te recomendamos consultar la carta de color.

Pintura en aerosol colores metálicos 400 ml

AEROSOL

► Pintura acrílica de secado rápido, anticorrosiva, útil para interiores y exteriores



Mostrario de color
AEROSOL metálico



CÓDIGO	CÓDIGO DE COLOR	COLOR			DISTRIB.	MAYOREO	LISTA
114281	PAM-905	● Oro	4	16	\$45.00	\$64.00	\$79.00
114286	PAM-900	● Oro pálido	4	16	\$45.00	\$64.00	\$79.00
114282	PAM-910	● Plata	4	16	\$45.00	\$64.00	\$79.00
114284	PAM-715	● Cromo	4	16	\$45.00	\$64.00	\$79.00
114283	PAM-915	● Cobre	4	16	\$45.00	\$64.00	\$79.00
114285	PAM-415	● Azul	4	16	\$45.00	\$64.00	\$79.00

La referencia del color puede variar, te recomendamos consultar la carta de color.

Pintura en aerosol colores fluorescentes 400 ml

AEROSOL

► Pintura acrílica de secado rápido, anticorrosiva, útil para interiores y exteriores



Mostrario de color
AEROSOL fluorescente



CÓDIGO	CÓDIGO DE COLOR	COLOR			DISTRIB.	MAYOREO	LISTA
114291	PAF-205	● Naranja	4	16	\$45.00	\$64.00	\$79.00
114292	PAF-305	● Rosa	4	16	\$45.00	\$64.00	\$79.00
114293	PAF-505	● Verde	4	16	\$45.00	\$64.00	\$79.00
114294	PAF-105	● Amarillo	4	16	\$45.00	\$64.00	\$79.00

La referencia del color puede variar, te recomendamos consultar la carta de color.

Pintura en aerosol alta temperatura 400 ml

AEROSOL

► Resiste altas temperaturas, no aplicar a superficies directas al fuego
► Ideal para hornos, asadores, estufas, calderas, tubos de vapor, utensilios de chimenea, maquinaria y superficies metálicas en general
► Secado rápido



CÓDIGO	CÓDIGO DE COLOR	COLOR			DISTRIB.	MAYOREO	LISTA
119521	PAAT-805	● Negro	4	16	\$79.00	\$113.00	\$139.00

Pintura en aerosol colores regulares 300 ml

AEROSOL

- ▶ Pintura acrílica de secado rápido, anticorrosiva, útil para interiores y exteriores



CÓDIGO	CÓDIGO DE COLOR	COLOR		DISTRIB.	MAYOREO	LISTA
309121	PA-005	○ Transparente	12	\$30.00	\$43.00	\$53.00
309122	PA-010	○ Blanco mate	12	\$30.00	\$43.00	\$53.00
309123	PA-015	○ Blanco brillante	12	\$30.00	\$43.00	\$53.00
309124	PA-110	● Amarillo canario	12	\$30.00	\$43.00	\$53.00
309125	PA-205	● Naranja brillante	12	\$30.00	\$43.00	\$53.00
309126	PA-308	● Rojo intenso	12	\$30.00	\$43.00	\$53.00
309127	PA-405	● Azul claro	12	\$30.00	\$43.00	\$53.00
309128	PA-410	● Azul rey	12	\$30.00	\$43.00	\$53.00
309129	PA-510	● Verde eco	12	\$30.00	\$43.00	\$53.00
309130	PA-610	● Café oscuro	12	\$30.00	\$43.00	\$53.00
309131	PA-705	● Gris claro	12	\$30.00	\$43.00	\$53.00
309132	PA-805	● Negro mate	12	\$30.00	\$43.00	\$53.00
309133	PA-815	● Negro brillante	12	\$30.00	\$43.00	\$53.00

La referencia del color puede variar, te recomendamos consultar la carta de color.

Primario en aerosol

AEROSOL

- ▶ Protege de la corrosión
- ▶ Ideal para metal, acero, lámina, tubería, tanque de gas, etc.



CÓDIGO	COLOR			DISTRIB.	MAYOREO	LISTA
119511	● Primario rojo	4	16	\$40.00	\$57.00	\$71.00
119512	● Primario gris	4	16	\$40.00	\$57.00	\$71.00

Pintura en aerosol para madera

AEROSOL

- ▶ Pintura de secado rápido y alto poder cubriente

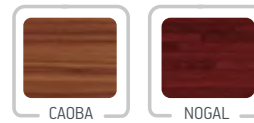

Mostrario de color
AEROSOL
madera



CÓDIGO	COLOR			DISTRIB.	MAYOREO	LISTA
119501	● Caoba	4	16	\$50.00	\$71.00	\$88.00
119502	● Nogal	4	16	\$50.00	\$71.00	\$88.00

PINTA COMO PROFESIONAL

Puedes calcularlo de la siguiente manera:

$$\frac{\text{Área total a pintar (m}^2\text{)}}{\text{Rendimiento de pintura}^*} = \text{Litros requeridos}$$

*Consulta el rendimiento en el envase de la pintura.



Pintura en esmalte colores metálicos

LATA

- ▶ Para interiores y exteriores
- ▶ Protege contra la corrosión
- ▶ Fácil aplicación



CÓDIGO	CONTENIDO	CÓDIGO DE COLOR	COLOR		DISTRIB.	MAYOREO	LISTA
119674	250 ml	PAM-715	● Cromo	9	\$80.00	\$114.00	\$141.00
119675	500 ml	PAM-715	● Cromo	9	\$130.00	\$185.00	\$230.00
119676	1 litro	PAM-715	● Cromo	6	\$220.00	\$315.00	\$390.00
119671	250 ml	PAM-910	● Plata	9	\$80.00	\$114.00	\$141.00
119672	500 ml	PAM-910	● Plata	9	\$130.00	\$185.00	\$230.00
119673	1 litro	PAM-910	● Plata	6	\$220.00	\$315.00	\$390.00
119677	250 ml	PAM-905	● Oro	9	\$80.00	\$114.00	\$141.00
119678	500 ml	PAM-905	● Oro	9	\$130.00	\$185.00	\$230.00
119679	1 litro	PAM-905	● Oro	6	\$220.00	\$315.00	\$390.00

La referencia del color puede variar, te recomendamos consultar la carta de color.

Primarios anticorrosivos

LATA

- ▶ Ideal para interiores y exteriores
- ▶ Para estructuras y superficies ferrosas
- ▶ Inhibe la corrosión y brinda gran adherencia a los recubrimientos finales



CÓDIGO	CONTENIDO	COLOR		DISTRIB.	MAYOREO	LISTA
119693	1 litro	● Gris	6	\$145.00	\$205.00	\$255.00
119694	1 galón	● Gris	2	\$440.00	\$630.00	\$775.00
119691	1 litro	● Rojo	6	\$145.00	\$205.00	\$255.00
119692	1 galón	● Rojo	2	\$440.00	\$630.00	\$775.00

Pintura en esmalte

LATA

- ▶ Para interiores y exteriores
- ▶ Protege contra la corrosión
- ▶ Fácil aplicación



CÓDIGO	CONTENIDO	CÓDIGO DE COLOR	COLOR		DISTRIB.	MAYOREO	LISTA
119621	250 ml	PA-010	○ Blanco mate	9	\$80.00	\$114.00	\$141.00
119622	500 ml	PA-010	○ Blanco mate	9	\$130.00	\$185.00	\$230.00
119623	1 litro	PA-010	○ Blanco mate	6	\$220.00	\$315.00	\$390.00
119624	1 galón	PA-010	○ Blanco mate	2	\$750.00	\$1,070.00	\$1,325.00
119625	250 ml	PA-015	○ Blanco brillante	9	\$80.00	\$114.00	\$141.00
119626	500 ml	PA-015	○ Blanco brillante	9	\$130.00	\$185.00	\$230.00
119627	1 litro	PA-015	○ Blanco brillante	6	\$220.00	\$315.00	\$390.00
119628	1 galón	PA-015	○ Blanco brillante	2	\$750.00	\$1,070.00	\$1,325.00
119629	250 ml	PA-115	● Amarillo medio	9	\$80.00	\$114.00	\$141.00
119630	500 ml	PA-115	● Amarillo medio	9	\$130.00	\$185.00	\$230.00
119631	1 litro	PA-115	● Amarillo medio	6	\$220.00	\$315.00	\$390.00
119632	250 ml	PA-308	● Rojo intenso	9	\$80.00	\$114.00	\$141.00
119633	500 ml	PA-308	● Rojo intenso	9	\$130.00	\$185.00	\$230.00
119634	1 litro	PA-308	● Rojo intenso	6	\$220.00	\$315.00	\$390.00
119644	250 ml	PA-610	● Café oscuro	9	\$80.00	\$114.00	\$141.00
119645	500 ml	PA-610	● Café oscuro	9	\$130.00	\$185.00	\$230.00
119646	1 litro	PA-610	● Café oscuro	6	\$220.00	\$315.00	\$390.00
119765	250 ml	PA-520	● Verde bandera	9	\$80.00	\$114.00	\$141.00
119766	500 ml	PA-520	● Verde bandera	9	\$130.00	\$185.00	\$230.00
119767	1 litro	PA-520	● Verde bandera	6	\$220.00	\$315.00	\$390.00
119756	250 ml	PA-400	● Azul cielo	9	\$80.00	\$114.00	\$141.00
119757	500 ml	PA-400	● Azul cielo	9	\$130.00	\$185.00	\$230.00
119758	1 litro	PA-400	● Azul cielo	6	\$220.00	\$315.00	\$390.00
119635	250 ml	PA-410	● Azul rey	9	\$80.00	\$114.00	\$141.00
119636	500 ml	PA-410	● Azul rey	9	\$130.00	\$185.00	\$230.00
119637	1 litro	PA-410	● Azul rey	6	\$220.00	\$315.00	\$390.00
119753	250 ml	PA-017	● Gris perla	9	\$80.00	\$114.00	\$141.00
119754	500 ml	PA-017	● Gris perla	9	\$130.00	\$185.00	\$230.00
119755	1 litro	PA-017	● Gris perla	6	\$220.00	\$315.00	\$390.00
119650	250 ml	PA-805	● Negro mate	9	\$80.00	\$114.00	\$141.00
119651	500 ml	PA-805	● Negro mate	9	\$130.00	\$185.00	\$230.00
119652	1 litro	PA-805	● Negro mate	6	\$220.00	\$315.00	\$390.00
119653	1 galón	PA-805	● Negro mate	2	\$750.00	\$1,070.00	\$1,325.00
119654	250 ml	PA-815	● Negro brillante	9	\$80.00	\$114.00	\$141.00
119655	500 ml	PA-815	● Negro brillante	9	\$130.00	\$185.00	\$230.00
119656	1 litro	PA-815	● Negro brillante	6	\$220.00	\$315.00	\$390.00
119657	1 galón	PA-815	● Negro brillante	2	\$750.00	\$1,070.00	\$1,325.00

La referencia del color puede variar, te recomendamos consultar la carta de color.



Pintura vinílica

CUBETA

- ▶ Formulada con materias primas de alta calidad
- ▶ Para interiores y exteriores
- ▶ Aplicable sobre yeso, cemento, aplanados, tablaroca, block, mampostería o madera
- ▶ Ideal para acabados finos y decorativos
- ▶ Acabado mate
- ▶ Lavable al 15 %
- ▶ Fácil aplicación



CÓDIGO	CONTENIDO	CÓDIGO DE COLOR	COLOR		DISTRIB.	MAYOREO	LISTA
119602	19 litros	PV-010	○ Blanco	1	\$1,200.00	\$1,715.00	\$2,115.00
119601	1 Galón	PV-010	○ Blanco	2	\$290.00	\$415.00	\$510.00
119603	1 Galón	PV-106	● Vainilla	2	\$290.00	\$415.00	\$510.00
119616	1 Galón	PV-102	● Arena	2	\$290.00	\$415.00	\$510.00
119618	1 Galón	PV-125	● Durazno	2	\$290.00	\$415.00	\$510.00
119605	1 Galón	PV-200	● Salmón	2	\$290.00	\$415.00	\$510.00
119606	1 Galón	PV-205	● Naranja	2	\$290.00	\$415.00	\$510.00
119708	1 Galón	PROX. ●	- Coral	2	\$290.00	\$415.00	\$510.00
119709	1 Galón	PROX. ●	- Piñon	2	\$290.00	\$415.00	\$510.00
119710	1 Galón	PROX. ●	- Tangerina	2	\$290.00	\$415.00	\$510.00
119617	1 Galón	PV-109	● Amarillo limón	2	\$290.00	\$415.00	\$510.00
119704	1 Galón	PROX. ●	- Amarillo napolitano	2	\$290.00	\$415.00	\$510.00
119705	1 Galón	PROX. ●	- Amarillo ocre	2	\$290.00	\$415.00	\$510.00
119608	1 Galón	PV-307	● Rosa oscuro	2	\$290.00	\$415.00	\$510.00
119609	1 Galón	PV-380	● Morado uva	2	\$290.00	\$415.00	\$510.00
119712	1 Galón	PROX. ●	Violeta intenso	2	\$290.00	\$415.00	\$510.00
119701	1 Galón	PV-310	● Rojo	2	\$290.00	\$415.00	\$510.00
119702	1 Galón	PV-315	● Rojo óxido	2	\$290.00	\$415.00	\$510.00
119619	1 Galón	PV-400	● Azul claro	2	\$290.00	\$415.00	\$510.00
119610	1 Galón	PV-407	● Azul medio	2	\$290.00	\$415.00	\$510.00
119706	1 Galón	PROX. ●	Azul horizonte	2	\$290.00	\$415.00	\$510.00
119707	1 Galón	PROX. ●	Azul rey	2	\$290.00	\$415.00	\$510.00
119714	1 Galón	PROX. ●	Azul profundo	2	\$290.00	\$415.00	\$510.00
119715	1 Galón	PROX. ●	Azul infinito	2	\$290.00	\$415.00	\$510.00
119611	1 Galón	PV-500	● Verde pastel	2	\$290.00	\$415.00	\$510.00
119620	1 Galón	PV-505	● Verde lima	2	\$290.00	\$415.00	\$510.00
119711	1 Galón	PROX. ●	Verde manzana	2	\$290.00	\$415.00	\$510.00
119713	1 Galón	PROX. ●	Verde olivo	2	\$290.00	\$415.00	\$510.00
119613	1 Galón	PV-605	● Chocolate	2	\$290.00	\$415.00	\$510.00
119614	1 Galón	PV-705	● Gris claro	2	\$290.00	\$415.00	\$510.00
119703	1 Galón	PV-815	● Negro	2	\$290.00	\$415.00	\$510.00

La referencia del color puede variar, te recomendamos consultar la carta de color.

Brochas con mango plástico 3 Pack y 2 Pack

BOLSA / CABALLETE

- ▶ Cerdas perfectamente adheridas al mango que no se desprenden



CÓDIGO	MEDIDAS		DISTRIB.	MAYOREO	LISTA
301514	1/2", 1" y 1 1/2"	12 60	\$15.00	\$21.40	\$26.00
301515	2" y 2 1/2"	12 60	\$18.00	\$26.00	\$32.00

Brocha con mango plástico

BOLSA

- ▶ Cerdas perfectamente adheridas al mango que no se desprenden



CÓDIGO	ANCHO		DISTRIB.	MAYOREO	LISTA
301501	1/2"	24 600	\$4.00	\$5.70	\$7.10
301502	1"	24 600	\$5.00	\$7.10	\$8.80
301503	1 1/2"	24 480	\$6.00	\$8.60	\$10.60
301504	2"	24 480	\$8.00	\$11.40	\$14.10
301505	2 1/2"	12 240	\$10.00	\$14.30	\$17.60
301506	3"	12 180	\$13.00	\$18.60	\$22.90
301507	4"	12 120	\$22.00	\$31.00	\$39.00
301508	5"	6 120	\$28.00	\$40.00	\$49.00
301509	6"	6 120	\$35.00	\$50.00	\$62.00

Brocha con mango de polipropileno

FAJILLA

- ▶ Cerdas extra larga y abundante, deja un acabado fino
- ▶ Ideal para usar con todo tipo de pintura
- ▶ Mango macizo, inyectado en una sola pieza
- ▶ Alto rendimiento, uso profesional



CÓDIGO	ANCHO	COLOR			DISTRIB.	MAYOREO	LISTA
111101	1/2"	●	6	72	\$6.00	\$8.60	\$10.60
111102	1"	●	6	72	\$9.00	\$12.90	\$15.90
111103	1 1/2"	●	6	72	\$12.00	\$17.10	\$21.20
111104	2"	●	6	72	\$15.00	\$21.40	\$26.00
111105	2 1/2"	●	6	72	\$18.00	\$26.00	\$32.00
111106	3"	●	6	72	\$25.00	\$36.00	\$44.00
111107	4"	●	6	72	\$43.00	\$61.00	\$76.00
111108	5"	●	6	72	\$59.00	\$84.00	\$104.00
111109	6"	●	6	72	\$68.00	\$97.00	\$120.00

Cepillo de alambre 4 x 16 pinceles, mango curvo

GRANEL

- ▶ Alambre de acero alto carbono diámetro 0,33 mm
- ▶ Para limpieza y pulido de superficies metálicas, elimina soldadura, óxido, pintura, adherencias en general
- ▶ Cómodo mango de polipropileno



CÓDIGO	LARGO	ANCHO			DISTRIB.	MAYOREO	LISTA
109801	27 cm	3,1 cm	6	36	\$23.00	\$33.00	\$41.00

Cepillo de alambre 3 x 17 pinceles, mango recto

GRANEL

- ▶ Alambre de acero alto carbono diámetro 0,33 mm
- ▶ Para limpieza y pulido de superficies metálicas, elimina soldadura, óxido, pintura, adherencias en general
- ▶ Cómodo mango de polipropileno



CÓDIGO	LARGO	ANCHO			DISTRIB.	MAYOREO	LISTA
109802	33 cm	2,5 cm	6	36	\$23.00	\$33.00	\$41.00

Cepillo de alambre con espátula 3 x 17 pinceles, mango recto

GRANEL

- ▶ Útil espátula, ideal para eliminar los excesos de pintura sin afectar el resto de la superficie
- ▶ Alambre de acero alto carbono diámetro 0,33 mm
- ▶ Elimina soldadura, óxido, pintura, adherencias en general
- ▶ Cómodo mango de polipropileno



CÓDIGO	LARGO	ANCHO			DISTRIB.	MAYOREO	LISTA
109803	33 cm	2,5 cm	6	36	\$25.00	\$36.00	\$44.00

Cepillo de alambre 9 x 20 y 6 x 19 pinceles

GRANEL

- ▶ Alambre de acero alto carbono diámetro 0,33 mm
- ▶ Ideal para cardado en superficies planas
- ▶ Diseño de bloque útil para aplicar mayor presión y limpiar adherencias difíciles de quitar

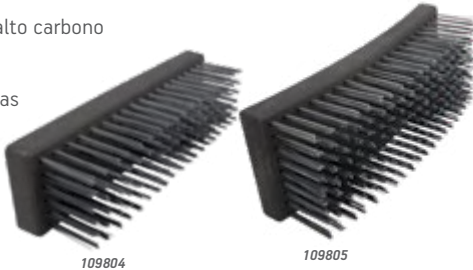

109804

109805



CÓDIGO	LARGO	ANCHO			DISTRIB.	MAYOREO	LISTA
109804	18 cm	5 cm	6	36	\$30.00	\$43.00	\$53.00
109805	18,2 cm	7 cm	6	36	\$45.00	\$64.00	\$79.00

Cepillo para impermeabilizar de 7 x 19 pinceles

GRANEL

- ▶ Cerdas 100% fibra natural
- ▶ Cabeza plástica súper durable
- ▶ Disponible con mango de madera pulida o cabeza sola



109811

109308



CÓDIGO	MODELO		DISTRIB.	MAYOREO	LISTA
109811	Sin mango	32	\$62.00	\$89.00	\$109.00
109812	Con mango	12	\$82.00	\$117.00	\$145.00
109308	Mango	12	\$22.00	\$31.00	\$39.00

Cepillo para pintar semi-rígido de 7 x 14 pinceles

GRANEL

- ▶ Cerdas: 50% ixtle natural y 50% fibra sintética
- ▶ Mango ergonómico de diseño reforzado
- ▶ Se puede utilizar con extensión
- ▶ Ideal para pintar sobre superficies extra rugosas



CÓDIGO	CERDAS			DISTRIB.	MAYOREO	LISTA
109806	4,9 cm	6	36	\$55.00	\$79.00	\$97.00

Cepillo para pintar suave de 7 x 14 pinceles

GRANEL

- ▶ Cerdas: 60% cola caballo y 40% ixtle
- ▶ Mango ergonómico de diseño reforzado
- ▶ Se puede utilizar con extensión
- ▶ Ideal para pintar sobre superficies lisas y rugosas



CÓDIGO	CERDAS			DISTRIB.	MAYOREO	LISTA
109807	3,7 cm	6	36	\$60.00	\$86.00	\$106.00

Charola para pintura profesional

GRANEL

- ▶ Charola fabricada en polipropileno de alta resistencia
- ▶ Base reforzada y gran resistencia a toda clase de solventes
- ▶ Amplios canales para desalojar exceso de pintura



CÓDIGO	LARGO	PAQUETES	DISTRIB.	MAYOREO	LISTA
106908	9"	24	\$27.00	\$39.00	\$48.00

Juego de charola con rodillo para pintura profesional

GRANEL

- ▶ Charola fabricada en polipropileno de alta resistencia
- ▶ Base reforzada y gran resistencia a toda clase de solventes
- ▶ Rodillo para superficies finas lisas que ahorra hasta un 10% de pintura



CÓDIGO	LARGO	PAQUETES	DISTRIB.	MAYOREO	LISTA
106909	9"	14	\$60.00	\$86.00	\$106.00

Plastiprotector

BOLSA

- ▶ Película de polietileno de alta densidad
- ▶ Transparente
- ▶ Para trabajos de pintura, protección de muebles y superficies



CÓDIGO	MEDIDA	USO	PAQUETES	DISTRIB.	MAYOREO	LISTA
106920	2x5m(10m²)	Ligero	6 48	\$12.00	\$17.10	\$21.20
106921	2x7.5m(15m²)	Ligero	6 48	\$14.00	\$20.00	\$24.70
106922	2x5m(10m²)	Rudo	6 48	\$15.00	\$21.40	\$26.00

Charola para pintura

GRANEL

- ▶ Charola de plástico negro para uso con rodillo
- ▶ Mejora el aprovechamiento de la pintura



CÓDIGO	TAMAÑO	PAQUETES	DISTRIB.	MAYOREO	LISTA
301512	9"	24	\$19.00	\$27.00	\$34.00

Juego de charola y rodillo para pintura

BOLSA Y GRANEL

- ▶ Rodillo para superficies lisas: ahorra hasta un 10%
- ▶ Charola de plástico negro

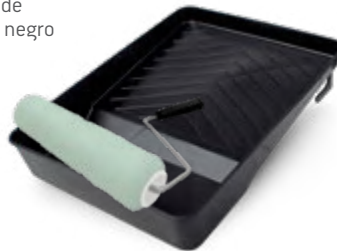

CÓDIGO	TAMAÑO	PAQUETES	DISTRIB.	MAYOREO	LISTA
301511	9"	24	\$52.00	\$74.00	\$92.00

Plastiprotector uso rudo

ROLLO

- ▶ Película de polietileno de alta densidad
- ▶ Para trabajos de pintura, protección de muebles y superficies
- ▶ Color negro
- ▶ En rollo



CÓDIGO	MEDIDA	PAQUETES	DISTRIB.	MAYOREO	LISTA
106926	0,92 x 14,88 m (13,68 m²)	12	\$115.00	\$165.00	\$205.00
106927	3,02 x 7,52 m (22,7 m²)	6	\$190.00	\$270.00	\$335.00

Extensión telescópica de acero para rodillo

GRANEL

- ▶ Prácticas puntas con y sin cuerda para adaptar todo tipo de rodillos
- ▶ Máxima extensión de 1 a 2 m



TELESCÓPICAS



CÓDIGO	LARGO	PAQUETES	DISTRIB.	MAYOREO	LISTA
106911	2 m	5 25	\$50.00	\$71.00	\$88.00

Extensión fija de acero para rodillo

GRANEL

- ▶ Práctica punta con cuerda para adaptar todo tipo de rodillos



CÓDIGO	LARGO	PAQUETES	DISTRIB.	MAYOREO	LISTA
106912	1.2 m	30	\$28.00	\$40.00	\$49.00

Rodillo para pintar 9"

BOLSA

- ▶ Evita el desprendimiento de pelusa
- ▶ Ahorra hasta un 10% más pintura que otros rodillos



CÓDIGO	LARGO	ESPESOR	SUPERFICIE	48	DISTRIB.	MAYOREO	LISTA
106901	9"	1 1/4"	Extra rugosa	48	\$37.00	\$53.00	\$65.00
106902	9"	3/4"	Rugosa	48	\$37.00	\$53.00	\$65.00
106903	9"	3/8"	Lisa	48	\$37.00	\$53.00	\$65.00

Repuesto felpa de microfibra 9"

BOLSA

- ▶ Fabricado en poliéster
- ▶ Para acabados finos
- ▶ Para pinturas vinílicas, esmaltes y epóxicos



CÓDIGO	ESPESOR	180	DISTRIB.	MAYOREO	LISTA
106907	3/8"	180	\$25.00	\$36.00	\$44.00

Repuesto para rodillo 9"

BOLSA

- ▶ Evita el desprendimiento de pelusa
- ▶ Ahorra hasta un 10% más pintura que otros rodillos



CÓDIGO	LARGO	ESPESOR	SUPERFICIE	120	DISTRIB.	MAYOREO	LISTA
106904	9"	1 1/4"	Extra rugosa	120	\$17.00	\$24.30	\$30.00
106905	9"	3/4"	Rugosa	120	\$17.00	\$24.30	\$30.00
106906	9"	3/8"	Lisa	120	\$17.00	\$24.30	\$30.00

Mini-rodillo de microfibra y repuestos 4"

BOLSA Y BLÍSTER

- ▶ Para todo tipo de pintura
- ▶ Ideal para retoques y espacios reducidos
- ▶ Mayor absorción
- ▶ 106931 maneral con rosca interior para uso con extensión



CÓDIGO	ESPESOR	12	48	DISTRIB.	MAYOREO	LISTA
106931	3/8"	12	48	\$24.00	\$34.00	\$42.00
106941	3/8"	Blister c/ 10	60	\$70.00	\$100.00	\$123.00

Mini-rodillo de esponja y repuestos 4"

BOLSA Y BLÍSTER

- ▶ Para todo tipo de pintura
- ▶ Ideal para retoques y espacios reducidos en superficies lisas
- ▶ Cobertura rápida
- ▶ 106933 maneral con rosca interior para uso con extensión



CÓDIGO	ESPESOR	12	48	DISTRIB.	MAYOREO	LISTA
106933	3/8"	12	48	\$28.00	\$40.00	\$49.00
106943	3/8"	Blister c/ 10	60	\$110.00	\$155.00	\$195.00

Maneral con jaula 9"

BOLSA

- ▶ Varilla de 6 mm
- ▶ Estructura de acero
- ▶ Para felpas de 9"
- ▶ Mango con rosca interior para uso con extensión



CÓDIGO	LARGO	24	DISTRIB.	MAYOREO	LISTA
106910	9"	24	\$28.00	\$40.00	\$49.00

Mini-rodillo de poliéster y repuestos 4"

BOLSA

- ▶ Ideal para retoques y espacios reducidos
- ▶ Para todo tipo de pintura
- ▶ Cobertura uniforme
- ▶ 106932 maneral con rosca interior para uso con extensión



CÓDIGO	ESPESOR	12	48	DISTRIB.	MAYOREO	LISTA
106932	3/4"	12	48	\$28.00	\$40.00	\$49.00
106942	3/4"	6	48	\$10.00	\$14.30	\$17.60

Complemento

PISTOLA PARA PINTAR eléctrica 550 W

- ▶ Para pintura de agua o esmalte
- ▶ De uso profesional en el hogar, talleres de pintura y hojalatería
- ▶ Permite cubrir mayor superficie en tiempos cortos de operación



NOM

1

Año de garantía

ESPECIFICACIONES TÉCNICAS

Tensión / frecuencia	127 V ~ / 60 Hz
Potencia	550 W
Corriente	4.5 A
Capacidad	800 ml
Flujo máximo	600 ml / min
Boquilla	ø 2.5 cm

CÓDIGO	DISTRIB.	MAYOREO	LISTA
190651	10	\$700.00	\$1,000.00 / \$1,235.00

LÍNEA CLÁSICA

Pistola de baja presión

CAJA

- ▶ Presión de trabajo 25 a 45 PSI
- ▶ Incluye 1 boquillas de 1.45 mm
- ▶ Incluye kit de limpieza
- ▶ Vaso de 1 L
- ▶ Para uso con esmalte, laca, barniz y vinílica

1
año
GARANTÍA

CROME

CÓDIGO			DISTRIB.	MAYOREO	LISTA
117601	2	10	\$195.00	\$280.00	\$345.00

Pistola de baja presión doble abanico

CAJA

- ▶ Presión de trabajo 25 a 45 PSI
- ▶ Incluye boquilla de punto, boquilla 45°, filtro para tubo de succión y kit de limpieza
- ▶ Vaso de 1 L

1
año
GARANTÍA

CROME

CÓDIGO			DISTRIB.	MAYOREO	LISTA
117602	2	10	\$235.00	\$335.00	\$415.00

Vaso de aluminio de 1 L

CAJA

- ▶ Vaso para pistola de baja presión 50 PSI
- cód. 117601 y 117602



CROME

CÓDIGO			DISTRIB.	MAYOREO	LISTA
117603	1	20	\$70.00	\$100.00	\$123.00

Kit de reparación para pistola
cód. 117601 y 117602

BOLSA

- ▶ Incluye empaque, tobera, aguja de flujo, resorte, boquilla de 1,5 mm



CROME

CÓDIGO			DISTRIB.	MAYOREO	LISTA
117604	20	200	\$75.00	\$107.00	\$132.00

LÍNEA CLÁSICA

Pistola para retoque

CAJA

- ▶ Presión de trabajo 50 a 60 PSI
- ▶ Incluye boquilla de 1.5 mm
- ▶ Vaso de 200 ml
- ▶ Incluye kit de limpieza
- ▶ Para uso con esmalte
- ▶ 2 Controles:
 - Flujo de pintura
 - Abanico

1
año
GARANTÍA

CROME

CÓDIGO			DISTRIB.	MAYOREO	LISTA
117621	6	36	\$275.00	\$395.00	\$485.00

Vaso de aluminio 200 ml

CAJA

- ▶ Vaso para pistola de baja presión 70 PSI
- cód. 117621



CROME

CÓDIGO			DISTRIB.	MAYOREO	LISTA
117622	4	48	\$75.00	\$107.00	\$132.00

Kit de reparación para pistola
cód. 117621

BLÍSTER

- ▶ Incluye empaque, tobera, aguja de flujo, resorte, boquilla de 1,5 mm



CROME

CÓDIGO			DISTRIB.	MAYOREO	LISTA
117623	6	36	\$90.00	\$129.00	\$160.00

LÍNEA PROFESIONAL

Pistola alta presión

CAJA

- ▶ **Succión:** Evita el flujo de aire continuo y la deformación del vaso
- ▶ Presión de trabajo 43 a 70 PSI
- ▶ Aguja de acero inoxidable
- ▶ Tope de latón que la hace más resistente al uso
- ▶ Incluye boquilla de 1.8 mm
- ▶ Vaso de 1L
- ▶ Incluye kit de limpieza
- ▶ Para uso con esmalte y vinílica
- ▶ 3 Controles:
 - Flujo de aire
 - Flujo de pintura
 - Abanico

1
año
GARANTÍA

CROME

CÓDIGO			DISTRIB.	MAYOREO	LISTA
117637	2	10	\$365.00	\$520.00	\$645.00

Vaso de aluminio de 1 L

CAJA

- ▶ Vaso para pistola de alta presión 70 PSI
- cód. 117637



CROME

CÓDIGO			DISTRIB.	MAYOREO	LISTA
117638	1	20	\$85.00	\$121.00	\$150.00

Kit de reparación para pistola
cód. 117637

BOLSA

- ▶ Incluye empaque, tobera, aguja de flujo, resorte, boquilla de 1,8 mm



CROME

CÓDIGO		DISTRIB.	MAYOREO	LISTA
117639	36	\$85.00	\$121.00	\$150.00

LÍNEA PROFESIONAL

Pistola alta presión 70 PSI

CAJA

- ▶ **Succión:** Evita el flujo de aire continuo y la deformación del vaso
- ▶ Presión de trabajo 43 a 70 PSI
- ▶ Aguja con tope de latón que la hace más resistente al uso
- ▶ Incluye boquilla de 1.8 mm
- ▶ Vaso de 1 L
- ▶ Incluye kit de limpieza y vaso reforzado
- ▶ 3 Controles:
 - Flujo de aire
 - Flujo de pintura
 - Abanico



CÓDIGO			DISTRIB.	MAYOREO	LISTA
117631	2	10	\$375.00	\$535.00	\$660.00

LÍNEA PROFESIONAL

Pistola alta presión 70 PSI

CAJA

- ▶ **Succión:** Evita el flujo de aire continuo y la deformación del vaso
- ▶ Reguladores de pintura y de aire de alta precisión.
- ▶ Presión de trabajo 43 a 70 PSI
- ▶ Aguja con tope de latón que la hace más resistente al uso
- ▶ Incluye boquilla de 1.8 mm
- ▶ Vaso de 1 L
- ▶ Incluye kit de limpieza, placa anti goteo y tapa cromada
- ▶ 3 Controles:
 - Flujo de aire
 - Flujo de pintura
 - Abanico



CÓDIGO			DISTRIB.	MAYOREO	LISTA
117634	2	10	\$385.00	\$550.00	\$680.00

LÍNEA PROFESIONAL

Pistola de gravedad vaso giratorio 125 ml

CAJA

- ▶ Presión de trabajo 60 PSI
- ▶ Incluye boquilla de 0.5 mm
- ▶ Vaso giratorio de 125 ml que facilita trabajar en diferentes ángulos
- ▶ Incluye kit de limpieza
- ▶ 2 Controles:
 - Flujo de pintura
 - Abanico



CÓDIGO			DISTRIB.	MAYOREO	LISTA
117654	6	36	\$150.00	\$215.00	\$265.00

Vaso reforzado de aluminio de 1 L

CAJA

- ▶ Vaso para pistola de alta presión 70 PSI
- cód. 117631



CÓDIGO		DISTRIB.	MAYOREO	LISTA
117632	20	\$90.00	\$129.00	\$160.00

Vaso de aluminio de 1 L

CAJA

- ▶ Vaso para pistola de alta presión 70 PSI
- cód. 117634



CÓDIGO			DISTRIB.	MAYOREO	LISTA
117635	1	20	\$115.00	\$165.00	\$205.00

Vaso giratorio de 125 ml

CAJA

- ▶ Vaso de aluminio para pistola de gravedad 60 PSI
- cód. 117654



CÓDIGO			DISTRIB.	MAYOREO	LISTA
117655	4	48	\$50.00	\$71.00	\$88.00

Kit de reparación para pistola
cód. 117631

BLÍSTER

- ▶ Incluye empaque, tobera, aguja de flujo, resorte, boquilla de 1,8 mm



CÓDIGO			DISTRIB.	MAYOREO	LISTA
117633	6	36	\$100.00	\$143.00	\$175.00

Kit de reparación para pistola
cód. 117634

BLÍSTER

- ▶ Incluye empaque, tobera, aguja de flujo, resorte, boquilla de 1,8 mm



CÓDIGO		DISTRIB.	MAYOREO	LISTA
117636	36	\$95.00	\$136.00	\$170.00

Kit de reparación para pistola
cód. 117654

BLÍSTER

- ▶ Incluye anillo, tobera, aguja de flujo, resorte, boquilla de 0,5 mm



CÓDIGO			DISTRIB.	MAYOREO	LISTA
117656	6	36	\$33.00	\$47.00	\$58.00

LÍNEA CLÁSICA

Pistola de gravedad vaso giratorio
400 ml

CAJA

- ▶ Presión de trabajo 43 a 70 PSI
- ▶ Incluye boquilla de 1.5mm
- ▶ Vaso giratorio de 400 ml que facilita trabajar en diferentes ángulos
- ▶ Incluye kit de limpieza
- ▶ 3 Controles:
 - Flujo de aire
 - Flujo de pintura
 - Abanico



CÓDIGO			DISTRIB.	MAYOREO	LISTA
117657	2	10	\$240.00	\$345.00	\$425.00

Vaso giratorio de 400 ml

CAJA

- ▶ Vaso de aluminio para pistola de gravedad 70 PSI
- cód. 117657



CÓDIGO			DISTRIB.	MAYOREO	LISTA
117658	4	48	\$60.00	\$86.00	\$106.00

Kit de reparación para pistola 117657

BLÍSTER

- ▶ Incluye aguja de flujo, resorte, boquilla y tobera de 1,5 mm



CÓDIGO			DISTRIB.	MAYOREO	LISTA
117659	6	36	\$85.00	\$121.00	\$150.00

LÍNEA CLÁSICA

Pistola de gravedad HVLP
(Alto volumen baja presión)

CAJA

- ▶ HVLP: Uso de pintura hasta 30% más eficiente
- ▶ Presión de trabajo 23 a 45 PSI
- ▶ Incluye boquilla de 1.0 mm
- ▶ Vaso plástico de 125 ml
- ▶ Incluye kit de limpieza
- ▶ 3 Controles:
 - Flujo de aire
 - Flujo de pintura
 - Abanico



CÓDIGO			DISTRIB.	MAYOREO	LISTA
117663	2	10	\$250.00	\$355.00	\$440.00

Vaso plástico de 125 ml

CAJA

- ▶ Vaso para pistola de gravedad 45 PSI
- cód. 117663



CÓDIGO			DISTRIB.	MAYOREO	LISTA
117664	4	48	\$35.00	\$50.00	\$62.00

Kit de reparación para pistola 117663

BOLSA

- ▶ Incluye aguja de flujo, resorte, boquilla y tobera de 1 mm



CÓDIGO			DISTRIB.	MAYOREO	LISTA
117665	6	36	\$90.00	\$129.00	\$160.00

LÍNEA PROFESIONAL

Pistola de gravedad HVLP
(Alto volumen baja presión)

CAJA

- ▶ HVLP: Uso de pintura hasta 30% más eficiente
- ▶ Presión de trabajo 35 a 45 PSI
- ▶ Incluye 3 boquillas de 1.4 mm, 1.7 mm, y 2 mm
- ▶ Vaso plástico de 600 ml
- ▶ Incluye kit de limpieza
- ▶ 3 Controles:
 - Flujo de aire
 - Flujo de pintura
 - Abanico



CÓDIGO			DISTRIB.	MAYOREO	LISTA
117660	2	10	\$550.00	\$785.00	\$970.00

Vaso plástico 600 ml

CAJA

- ▶ Vaso para pistola de gravedad 45 PSI
- cód. 117660



CÓDIGO			DISTRIB.	MAYOREO	LISTA
117661	4	48	\$55.00	\$79.00	\$97.00

Kit de reparación para pistola 117660

BLÍSTER

- ▶ Incluye tobera, aguja de flujo, resorte y boquilla de 1,7 mm



CÓDIGO			DISTRIB.	MAYOREO	LISTA
117662	6	36	\$90.00	\$129.00	\$160.00

ACCESORIOS - LÍNEA CLÁSICA

Aerógrafo de succión

ESTUCHE

- ▶ Presión de trabajo 15 a 50 PSI
- ▶ Doble vaso de 22 ml
- ▶ Incluye manguera y gotero
- ▶ Salida para compresor de 1/4"



CÓDIGO



DISTRIB.

MAYOREO

LISTA

117683

2

20

\$175.00

\$250.00

\$310.00

Kit de reparación para pistola aerográfica cód. 117681

BLISTER

- ▶ Incluye aguja de flujo y boquilla de 0,3 mm



CÓDIGO



DISTRIB.

MAYOREO

LISTA

117682

6

36

\$70.00

\$100.00

\$123.00

Gas propelente para aerógrafo

AEROSOL

- ▶ Para aerógrafos
- ▶ Contiene 500 ml
- ▶ Requiere una válvula (no incluida)



CÓDIGO



DISTRIB.

MAYOREO

LISTA

119576

12

\$30.00

\$43.00

\$53.00

Manguera para pistola aerográfica cód. 117681

BLISTER

- ▶ Manguera de 1,8 m con conectores de 1/4" y 1/8"
- ▶ Diámetro de 5/32"



CÓDIGO



DISTRIB.

MAYOREO

LISTA

117685

6

36

\$75.00

\$107.00

\$132.00

Regulador de aire

CAJA

- ▶ Regulador con tres escalas kg/m², kPa y PSI
- ▶ Máxima presión de 180 PSI



CÓDIGO



DISTRIB.

MAYOREO

LISTA

117691

2

50

\$95.00

\$136.00

\$170.00

LÍNEA PROFESIONAL

Pistola aerográfica de gravedad

ESTUCHE

- ▶ Presión de trabajo 25 a 50 PSI
- ▶ Incluye llave para limpieza, gotero y copa de 7 ml
- ▶ Para manguera de 1/8" con salida de 1/4"



CÓDIGO



DISTRIB.

MAYOREO

LISTA

117681

2

20

\$305.00

\$435.00

\$540.00

Pistola para limpieza de motores

CAJA

- ▶ Presión máxima 90 PSI
- ▶ Presión de trabajo 40 - 60 PSI
- ▶ Vaso de 1L



CÓDIGO



DISTRIB.

MAYOREO

LISTA

117721

2

10

\$165.00

\$235.00

\$290.00

Pistola para recubrimiento

CAJA

- ▶ Presión de trabajo 40 a 60 PS
- ▶ Entrada 1/4 NPT



CÓDIGO



DISTRIB.

MAYOREO

LISTA

117731

2

10

\$135.00

\$195.00

\$240.00



¡TIPS DE USO!



NUEVO

VÁLVULA AHORRADORA

Funcional en todo tipo de tubería

AHORRA

hasta **50%** menos en tu recibo de agua



CON LA VÁLVULA **AKSI**

80% MENOS AIRE



¿CÓMO FUNCIONA?

La válvula ahorradora AKSI® comprime el aire contenido en las tuberías de agua, al reducir el volumen de aire contabilizado por el medidor, genera un ahorro de metros cúbicos. Este se reflejará en tu recibo de pago.

BENEFICIOS:

- Ahorro de hasta un 50%, o más, en la facturación de agua.
- Ahorro GARANTIZADO*
- Vida útil de más de 20 años.
- No requiere mantenimiento.
- Fácil instalación.

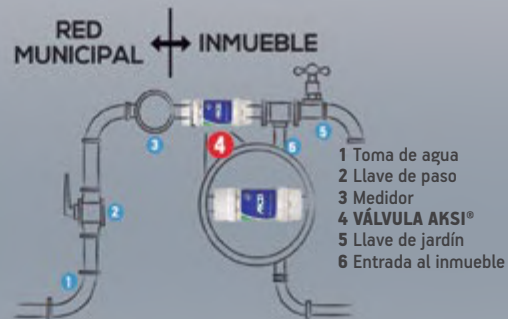

INSTALACIÓN:

- Debe colocarse DESPUÉS del medidor de agua, hasta un máximo de 15 metros después.
- Instalar de forma horizontal con un tramo recto mínimo de 30 cm. En caso de instalarse inmediatamente después del medidor, no será necesario ya que el medidor contará como tramo recto.
- No colocar otras válvulas u accesorios como tees, filtros, check's, entre el medidor y la válvula AKSI®. Sólo se aceptan válvulas de cierre/llaves de paso.

CÓDIGO	DÍAMETRO		DISTRIB.	MAYOREO	LISTA
128391	1/2"	125	\$950.00	\$1,355.00	\$1,675.00
128392	3/4"	125	\$2,450.00	\$3,500.00	\$4,320.00



CONEXIONES PVC

Conexiones

MEDIDA	23° C	60° C
1/2"	42 kgf/cm ² / 600 psi	9 kgf/cm ² / 130 psi
3/4"	34 kgf/cm ² / 480 psi	7 kgf/cm ² / 100 psi
1"	32 kgf/cm ² / 450 psi	7 kgf/cm ² / 100 psi
1 1/4"	27 kgf/cm ² / 384 psi	6 kgf/cm ² / 80 psi
1 1/2"	23 kgf/cm ² / 330 psi	5 kgf/cm ² / 70 psi
2"	19 kgf/cm ² / 270 psi	4 kgf/cm ² / 60 psi

Tubos

CÉDULA 40	23° C
1/2"	42 kgf/cm ² / 600 psi
3/4"	34 kgf/cm ² / 480 psi
1"	32 kgf/cm ² / 450 psi
1 1/4"	27 kgf/cm ² / 384 psi
1 1/2"	23 kgf/cm ² / 330 psi
2"	19 kgf/cm ² / 270 psi

RD	23° C
RD 21	13.7 kgf/cm ² / 190 psi
RD 26	11 kgf/cm ² / 160 psi

Tubo cédula 40

PROX.

BOLSA

► Presión máxima 23° C a 60° C



PRECIOS POR PIEZA

CÓDIGO	DIÁMETRO EXTERIOR	Espesor	PIEZAS X BOLSA	DISTRIB.	MAYOREO	LISTA
132101	(1/2") 20 mm x 3 m	2.77 mm	10	\$42.00	\$60.00	\$74.00
132102	(3/4") 25 mm x 3 m	2.87 mm	10	\$56.00	\$80.00	\$99.00
132103	(1") 32 mm x 3 m	3.38 mm	5	\$82.00	\$117.00	\$145.00
132104	(1 1/4") 31 mm x 3 m	3.56 mm	5	\$110.00	\$155.00	\$195.00
132105	(1 1/2") 38 mm x 3 m	3.68 mm	5	\$130.00	\$185.00	\$230.00
132106	(2") 64 mm x 3 m	3.91 mm	5	\$185.00	\$265.00	\$325.00

Tubo RD's

PROX.

BOLSA

► Presión máxima 23° C a 60° C



PRECIOS POR PIEZA

CÓDIGO	DIÁMETRO EXTERIOR	Espesor	PIEZAS X BOLSA	DISTRIB.	MAYOREO	LISTA
132111	(1/2") 20 mm x 3 m	1.5 mm	5	\$24.00	\$34.00	\$42.00
132112	(3/4") 25 mm x 3 m	1.5 mm	5	\$37.00	\$53.00	\$65.00
132113	(1") 32 mm x 3 m	1.5 mm	5	\$43.00	\$61.00	\$76.00
132114	(1 1/4") 31 mm x 3 m	1.63 mm	5	\$62.00	\$89.00	\$109.00
132115	(1 1/2") 38 mm x 3 m	1.85 mm	5	\$80.00	\$114.00	\$141.00
132116	(2") 64 mm x 3 m	2.31 mm	5	\$125.00	\$180.00	\$220.00

Codo 90°

PROX.

BOLSA

► Presión máxima 23° C a 60° C



PRECIOS POR PIEZA

CÓDIGO	MEDIDA	PIEZAS X BOLSA	PIEZAS X BOLSA	DISTRIB.	MAYOREO	LISTA
132011	1/2"	20	30	\$1.80	\$2.60	\$3.20
132012	3/4"	20	19	\$2.70	\$3.90	\$4.80
132013	1"	20	15	\$5.00	\$7.10	\$8.80
132014	1 1/4"	4	30	\$9.00	\$12.90	\$15.90
132015	1 1/2"	4	21	\$13.00	\$18.60	\$22.90
132016	2"	4	13	\$20.00	\$29.00	\$35.00

Mínimo a surtir 1 bolsa

Codo 45°

PROX.

BOLSA

► Presión máxima 23° C a 60° C



PRECIOS POR PIEZA

CÓDIGO	MEDIDA	PIEZAS X BOLSA	PIEZAS X BOLSA	DISTRIB.	MAYOREO	LISTA
132021	1/2"	20	34	\$1.90	\$2.70	\$3.40
132022	3/4"	20	22	\$2.70	\$3.90	\$4.80
132023	1"	20	17	\$4.50	\$6.40	\$7.90
132024	1 1/4"	4	37	\$8.00	\$11.40	\$14.10
132025	1 1/2"	4	22	\$12.00	\$17.10	\$21.20
132026	2"	4	14	\$17.00	\$24.30	\$30.00

Mínimo a surtir 1 bolsa

Cople

PROX.

BOLSA

► Presión máxima 23° C a 60° C



PRECIOS POR PIEZA

CÓDIGO	MEDIDA	PIEZAS X BOLSA	PIEZAS X BOLSA	DISTRIB.	MAYOREO	LISTA
132001	1/2"	20	44	\$1.40	\$2.00	\$2.50
132002	3/4"	20	30	\$2.30	\$3.30	\$4.10
132003	1"	20	25	\$3.60	\$5.10	\$6.40
132004	1 1/4"	4	56	\$5.60	\$8.00	\$9.90
132005	1 1/2"	4	34	\$7.00	\$10.00	\$12.30
132006	2"	4	26	\$11.00	\$15.70	\$19.40

Mínimo a surtir 1 bolsa

Tees sencillas

PROX. ●

BOLSA

▶ Presión máxima
23° C a 60° C

AKSI

PRECIOS POR PIEZA

CÓDIGO	MEDIDA	PIEZAS X BOLSA		DISTRIB.	MAYOREO	LISTA
132031	1/2"	20	20	\$3.00	\$4.30	\$5.30
132032	3/4"	20	13	\$4.00	\$5.70	\$7.10
132033	1"	20	10	\$6.00	\$8.60	\$10.60
132034	1 1/4"	4	20	\$12.00	\$17.10	\$21.20
132035	1 1/2"	4	14	\$16.00	\$22.90	\$28.00
132036	2"	4	8	\$25.00	\$36.00	\$44.00

Mínimo a surtir 1 bolsa

Reducción bushing

PROX. ●

BOLSA

▶ Presión máxima
23° C a 60° C

AKSI

PRECIOS POR PIEZA

CÓDIGO	MEDIDA	PIEZAS X BOLSA		DISTRIB.	MAYOREO	LISTA
132041	3/4" x 1/2"	20	54	\$1.60	\$2.30	\$2.80
132042	1" x 1/2"	20	33	\$3.20	\$4.60	\$5.60
132043	1" x 3/4"	20	33	\$3.00	\$4.30	\$5.30
132044	1 1/2" x 1"	10	29	\$6.50	\$9.30	\$11.50
132045	1 1/2" x 1 1/4"	4	70	\$5.00	\$7.10	\$8.80
132046	1 1/4" x 1"	4	100	\$4.50	\$6.40	\$7.90
132047	2" x 1/2"	4	43	\$10.00	\$14.30	\$17.60

Mínimo a surtir 1 bolsa

Tapón

PROX. ●

BOLSA

▶ Presión máxima
23°C a 60°C

AKSI

PRECIOS POR PIEZA

CÓDIGO	MEDIDA	PIEZAS X BOLSA		DISTRIB.	MAYOREO	LISTA
132051	1/2"	20	71	\$1.20	\$1.70	\$2.10
132052	3/4"	20	47	\$1.80	\$2.60	\$3.20
132053	1"	20	45	\$2.70	\$3.90	\$4.80
132054	1 1/4"	4	90	\$4.50	\$6.40	\$7.90
132055	1 1/2"	4	54	\$5.50	\$7.90	\$9.70
132056	2"	4	36	\$8.00	\$11.40	\$14.10

Mínimo a surtir 1 bolsa

Tuerca unión

PROX. ●

BOLSA

▶ Presión máxima
23°C a 60°C

AKSI

PRECIOS POR PIEZA

CÓDIGO	MEDIDA	PIEZAS X BOLSA		DISTRIB.	MAYOREO	LISTA
132061	1/2"	20	15	\$8.00	\$11.40	\$14.10
132062	3/4"	20	10	\$13.00	\$18.60	\$22.90
132063	1"	20	6	\$20.00	\$29.00	\$35.00
132064	1 1/4"	4	18	\$33.00	\$47.00	\$58.00
132065	1 1/2"	4	13	\$45.00	\$64.00	\$79.00
132066	2"	4	8	\$76.00	\$109.00	\$134.00

Mínimo a surtir 1 bolsa

Adaptador hembra

PROX. ●

BOLSA

▶ Presión máxima
23° C a 60° C

AKSI

PRECIOS POR PIEZA

CÓDIGO	MEDIDA	PIEZAS X BOLSA		DISTRIB.	MAYOREO	LISTA
132071	1/2"	20	43	\$2.00	\$2.90	\$3.50
132072	3/4"	20	29	\$3.00	\$4.30	\$5.30
132073	1"	20	20	\$4.00	\$5.70	\$7.10
132074	1 1/4"	4	48	\$8.00	\$11.40	\$14.10
132075	1 1/2"	4	34	\$10.00	\$14.30	\$17.60
132076	2"	4	23	\$14.00	\$20.00	\$24.70

Mínimo a surtir 1 bolsa

Adaptador macho

PROX. ●

BOLSA

▶ Presión máxima
23° C a 60° C

AKSI

PRECIOS POR PIEZA

CÓDIGO	MEDIDA	PIEZAS X BOLSA		DISTRIB.	MAYOREO	LISTA
132081	1/2"	20	49	\$1.40	\$2.00	\$2.50
132082	3/4"	20	32	\$2.30	\$3.30	\$4.10
132083	1"	20	25	\$3.50	\$5.00	\$6.20
132084	1 1/4"	4	65	\$5.50	\$7.90	\$9.70
132085	1 1/2"	4	45	\$7.00	\$10.00	\$12.30
132086	2"	4	28	\$10.00	\$14.30	\$17.60

Mínimo a surtir 1 bolsa



CONEXIONES CPVC

Tubo

BOLSA

- ▶ Presión máxima a 15.6° C: 1 MPa/100 PSI
- ▶ Presión máxima a 80° C: 0.68 MPa/100 PSI



PRECIOS POR PIEZA

CÓDIGO	DIÁMETRO EXTERIOR	PIEZAS X BOLSA	DISTRIB.	MAYOREO	LISTA
128191	(1/2") 20 mm x 3.05 m	50	\$36.00	\$51.00	\$64.00
128192	(3/4") 25 mm x 3.05 m	30	\$60.00	\$86.00	\$106.00
128193	(1") 32 mm x 3.05 m	20	\$90.00	\$129.00	\$160.00

Codo 90°

BOLSA

- ▶ Presión máxima a 15.6° C: 1 MPa/100 PSI
- ▶ Presión máxima a 80° C: 0.68 MPa/100 PSI



PRECIOS POR PIEZA

CÓDIGO	MEDIDA	PIEZAS X BOLSA	DISTRIB.	MAYOREO	LISTA	
128011	1/2"	20	80 bolsas	\$1.30	\$1.90	\$2.30
128012	3/4"	20	32 bolsas	\$2.70	\$3.90	\$4.80
128013	1"	20	15 bolsas	\$5.80	\$8.30	\$10.20

Mínimo a surtir 1 bolsa

Codo 45°

BOLSA

- ▶ Presión máxima a 15.6° C: 1 MPa/100 PSI
- ▶ Presión máxima a 80° C: 0.68 MPa/100 PSI



PRECIOS POR PIEZA

CÓDIGO	MEDIDA	PIEZAS X BOLSA	DISTRIB.	MAYOREO	LISTA	
128031	1/2"	20	90 bolsas	\$1.40	\$2.00	\$2.50
128032	3/4"	20	37 bolsas	\$2.50	\$3.60	\$4.40
128033	1"	20	17 bolsas	\$5.20	\$7.40	\$9.20

Mínimo a surtir 1 bolsa

Codo oreja

BOLSA

- ▶ Presión máxima a 15.6° C: 1 MPa/100 PSI
- ▶ Presión máxima a 80° C: 0.68 MPa/100 PSI



PRECIOS POR PIEZA

CÓDIGO	MEDIDA	PIEZAS X BOLSA	DISTRIB.	MAYOREO	LISTA	
128111	1/2"	20	22 bolsas	\$7.60	\$10.90	\$13.40

Mínimo a surtir 1 bolsa

Cople

BOLSA

- ▶ Presión máxima a 15.6° C: 1 MPa/100 PSI
- ▶ Presión máxima a 80° C: 0.68 MPa/100 PSI



PRECIOS POR PIEZA

CÓDIGO	MEDIDA	PIEZAS X BOLSA	DISTRIB.	MAYOREO	LISTA	
128001	1/2"	20	125 bolsas	\$0.90	\$1.30	\$1.60
128002	3/4"	20	50 bolsas	\$1.90	\$2.70	\$3.40
128003	1"	20	25 bolsas	\$3.80	\$5.40	\$6.70

Mínimo a surtir 1 bolsa

Cople de compresión

BOLSA

- ▶ Presión máxima a 15.6° C: 1 MPa/100 PSI
- ▶ Presión máxima a 80° C: 0.68 MPa/100 PSI



PRECIOS POR PIEZA

CÓDIGO	MEDIDA	PIEZAS X BOLSA	DISTRIB.	MAYOREO	LISTA	
128141	1/2"	5	52 bolsas	\$15.00	\$21.40	\$26.00
128142	3/4"	5	30 bolsas	\$24.00	\$34.00	\$42.00
128143	1"	5	20 bolsas	\$31.00	\$44.00	\$55.00

Mínimo a surtir 1 bolsa

Cople reducción

BOLSA

- ▶ Presión máxima a 15.6° C: 1 MPa/100 PSI
- ▶ Presión máxima a 80° C: 0.68 MPa/100 PSI



PRECIOS POR PIEZA

CÓDIGO	MEDIDA	PIEZAS X BOLSA	DISTRIB.	MAYOREO	LISTA
128061	3/4" x 1/2"	20	65 bolsas	\$1.90	\$2.70 \$3.40

Mínimo a surtir 1 bolsa

Reducción bushing

BOLSA

- ▶ Presión máxima a 15.6° C: 1 MPa/100 PSI
- ▶ Presión máxima a 80° C: 0.68 MPa/100 PSI



PRECIOS POR PIEZA

CÓDIGO	MEDIDA	PIEZAS X BOLSA	DISTRIB.	MAYOREO	LISTA
128051	3/4" x 1/2"	20	115 bolsas	\$1.40	\$2.00 \$2.50
128052	1" x 1/2"	20	52 bolsas	\$3.20	\$4.60 \$5.60
128053	1" x 3/4"	20	52 bolsas	\$2.40	\$3.40 \$4.20

Mínimo a surtir 1 bolsa

Tapón

BOLSA

- ▶ Presión máxima a 15.6° C: 1 MPa/100 PSI
- ▶ Presión máxima a 80° C: 0.68 MPa/100 PSI



PRECIOS POR PIEZA

CÓDIGO	MEDIDA	PIEZAS X BOLSA	DISTRIB.	MAYOREO	LISTA
128071	1/2"	20	225 bolsas	\$0.90	\$1.30 \$1.60
128072	3/4"	20	90 bolsas	\$1.50	\$2.10 \$2.60

Mínimo a surtir 1 bolsa

Adaptador macho

BOLSA

- ▶ Presión máxima a 15.6° C: 1 MPa/100 PSI
- ▶ Presión máxima a 80° C: 0.68 MPa/100 PSI



PRECIOS POR PIEZA

CÓDIGO	MEDIDA	PIEZAS X BOLSA	DISTRIB.	MAYOREO	LISTA
128041	1/2"	20	85 bolsas	\$1.70	\$2.40 \$3.00
128042	3/4"	20	47 bolsas	\$2.50	\$3.60 \$4.40
128043	1"	20	25 bolsas	\$5.00	\$7.10 \$8.80

Mínimo a surtir 1 bolsa

Adaptador hembra

BOLSA

- ▶ Presión máxima a 15.6° C: 1 MPa/100 PSI
- ▶ Presión máxima a 80° C: 0.68 MPa/100 PSI



PRECIOS POR PIEZA

CÓDIGO	MEDIDA	PIEZAS X BOLSA	DISTRIB.	MAYOREO	LISTA
128121	1/2"	20	62 bolsas	\$2.60	\$3.70 \$4.60
128122	3/4"	20	35 bolsas	\$3.40	\$4.90 \$6.00
128123	1"	20	20 bolsas	\$6.00	\$8.60 \$10.60

Mínimo a surtir 1 bolsa

Tuerca unión

BOLSA

- ▶ Presión máxima a 15.6° C: 1 MPa/100 PSI
- ▶ Presión máxima a 80° C: 0.68 MPa/100 PSI



PRECIOS POR PIEZA

CÓDIGO	MEDIDA	PIEZAS X BOLSA	DISTRIB.	MAYOREO	LISTA
128091	1/2"	20	30 bolsas	\$7.00	\$10.00 \$12.30
128092	3/4"	20	17 bolsas	\$11.00	\$15.70 \$19.40
128093	1"	20	10 bolsas	\$20.00	\$29.00 \$35.00

Mínimo a surtir 1 bolsa

Adaptador macho con inserto de latón

BOLSA

- ▶ Presión máxima a 15.6° C: 1 MPa/100 PSI
- ▶ Presión máxima a 80° C: 0.68 MPa/100 PSI



PRECIOS POR PIEZA

CÓDIGO	MEDIDA	PIEZAS X BOLSA	DISTRIB.	MAYOREO	LISTA
128171	1/2"	10	30 bolsas	\$27.00	\$39.00 \$48.00
128172	3/4"	10	19 bolsas	\$38.00	\$54.00 \$67.00

Mínimo a surtir 1 bolsa

Adaptador hembra con inserto de latón

BOLSA

- ▶ Presión máxima a 15.6° C: 1 MPa/100 PSI
- ▶ Presión máxima a 80° C: 0.68 MPa/100 PSI



PRECIOS POR PIEZA

CÓDIGO	MEDIDA	PIEZAS X BOLSA	DISTRIB.	MAYOREO	LISTA
128181	1/2"	10	40 bolsas	\$26.00	\$37.00 \$46.00
128182	3/4"	10	25 bolsas	\$35.00	\$50.00 \$62.00

Mínimo a surtir 1 bolsa

Abrazadera tipo U

BOLSA

- ▶ Presión máxima a 15.6° C: 1 MPa/100 PSI
- ▶ Presión máxima a 80° C: 0.68 MPa/100 PSI



PRECIOS POR PIEZA

CÓDIGO	MEDIDA	PIEZAS X BOLSA	DISTRIB.	MAYOREO	LISTA
128131	3/4"	10	360 bolsas	\$0.90	\$1.30 \$1.60

Mínimo a surtir 1 bolsa

Tees sencillas

BOLSA

- ▶ Presión máxima a 15.6° C: 1 MPa/100 PSI
- ▶ Presión máxima a 80° C: 0.68 MPa/100 PSI



PRECIOS POR PIEZA

CÓDIGO	MEDIDA	PIEZAS X BOLSA	DISTRIB.	MAYOREO	LISTA	
128021	1/2"	20	52 bolsas	\$2.20	\$3.10	\$3.90
128022	3/4"	20	20 bolsas	\$4.00	\$5.70	\$7.10
128023	1"	20	10 bolsas	\$8.00	\$11.40	\$14.10

Mínimo a surtir 1 bolsa

Tee reducida central

BOLSA

- ▶ Presión máxima a 15.6° C: 1 MPa/100 PSI
- ▶ Presión máxima a 80° C: 0.68 MPa/100 PSI



PRECIOS POR PIEZA

CÓDIGO	MEDIDA	PIEZAS X BOLSA	DISTRIB.	MAYOREO	LISTA	
128081	3/4" x 3/4" x 1/2"	10	55 bolsas	\$4.50	\$6.40	\$7.90
128082	1" x 1" x 1/2"	10	30 bolsas	\$7.00	\$10.00	\$12.30

Mínimo a surtir 1 bolsa

Tee reducida lateral

BOLSA

- ▶ Presión máxima a 15.6° C: 1 MPa/100 PSI
- ▶ Presión máxima a 80° C: 0.68 MPa/100 PSI



PRECIOS POR PIEZA

CÓDIGO	MEDIDA	PIEZAS X BOLSA	DISTRIB.	MAYOREO	LISTA	
128151	1/2" x 3/4" x 3/4"	10	45 bolsas	\$5.60	\$8.00	\$9.90

Mínimo a surtir 1 bolsa

Válvula de esfera

BOLSA

- ▶ Presión máxima a 15.6° C: 1 MPa/100 PSI
- ▶ Presión máxima a 80° C: 0.68 MPa/100 PSI



PRECIOS POR PIEZA

CÓDIGO	MEDIDA	PIEZAS X BOLSA	DISTRIB.	MAYOREO	LISTA	
128301	1/2"	10	30 bolsas	\$20.00	\$29.00	\$35.00
128302	3/4"	10	20 bolsas	\$33.00	\$47.00	\$58.00
128303	1"	10	11 bolsas	\$55.00	\$79.00	\$97.00

Mínimo a surtir 1 bolsa

Válvula de globo

BOLSA

- ▶ Presión máxima a 15.6° C: 1 MPa/100 PSI
- ▶ Presión máxima a 80° C: 0.68 MPa/100 PSI



PRECIOS POR PIEZA

CÓDIGO	MEDIDA	PIEZAS X BOLSA	DISTRIB.	MAYOREO	LISTA	
128321	1/2"	5	33 bolsas	\$25.00	\$36.00	\$44.00

Mínimo a surtir 1 bolsa

Cruz

BOLSA

- ▶ Presión máxima a 15.6° C: 1 MPa/100 PSI
- ▶ Presión máxima a 80° C: 0.68 MPa/100 PSI



PRECIOS POR PIEZA

CÓDIGO	MEDIDA	PIEZAS X BOLSA	DISTRIB.	MAYOREO	LISTA	
128101	1/2"	10	75 bolsas	\$4.70	\$6.70	\$8.30
128102	3/4"	10	30 bolsas	\$7.60	\$10.90	\$13.40

Mínimo a surtir 1 bolsa

Llave angular

BOLSA

- ▶ Presión máxima a 15.6° C: 1 MPa/100 PSI
- ▶ Presión máxima a 80° C: 0.68 MPa/100 PSI



PRECIOS POR PIEZA

CÓDIGO	MEDIDA	PIEZAS X BOLSA	DISTRIB.	MAYOREO	LISTA	
128331	1/2" x 1/2"	10	40 bolsas	\$22.00	\$31.00	\$39.00

Mínimo a surtir 1 bolsa

Llave angular con volante

BOLSA

- ▶ Presión máxima a 15.6° C: 1 MPa/100 PSI
- ▶ Presión máxima a 80° C: 0.68 MPa/100 PSI



PRECIOS POR PIEZA

CÓDIGO	MEDIDA	PIEZAS X BOLSA	DISTRIB.	MAYOREO	LISTA	
128311	1/2" x 1/2"	5	27 bolsas	\$25.00	\$36.00	\$44.00

Mínimo a surtir 1 bolsa

Mezclador tipo bigote

BOLSA

- ▶ Presión máxima a 15.6° C: 1 MPa/100 PSI
- ▶ Presión máxima a 80° C: 0.68 MPa/100 PSI



PRECIOS POR PIEZA

CÓDIGO	MEDIDA	PIEZAS X BOLSA	DISTRIB.	MAYOREO	LISTA	
128161	1/2"	10	20 bolsas	\$16.00	\$22.90	\$28.00

Mínimo a surtir 1 bolsa



CONEXIONES PPR



Termofusora 650 W para PPR

CAJA A COLOR

ESPECIFICACIONES:

- ▶ 120 V~ | 60 Hz
- ▶ 650 W
- ▶ Diámetro: 20-32 mm



CONTENIDO

- 1 Termofusor de 120 V-600 W, 60 Hz
- 1 Base para termofusor fijo
- 1 Llave Allen®
- 1 Pinza de extracción
- 1 Juego de dados (20, 25 y 32 mm)
- 3 Tornillos

NOM

CÓDIGO	MODELO	POTENCIA		DISTRIB.	MAYOREO	LISTA
191801	TERMO-650p-AK	650 W	4	\$900.00	\$1,285.00	\$1,590.00



Dado para termofusora

BOLSA

- ▶ Dados de aluminio



FABRICADOS EN ALUMINIO



CÓDIGO	MEDIDA	PZAS X CAJA			DISTRIB.	MAYOREO	LISTA
191821	20 mm	1	10	100	\$100.00	\$143.00	\$175.00
191822	25 mm	1	10	100	\$120.00	\$170.00	\$210.00
191823	32 mm	1	10	190	\$130.00	\$185.00	\$230.00

Termofusora 2000 W para PPR

PROX.

CAJA A COLOR

ESPECIFICACIONES:

- ▶ 120 V~ | 60 Hz
- ▶ 2 000 W
- ▶ 6 Dados: 20 mm, 25 mm, 32 mm, 40 mm, 50 mm y 63 mm



CONTENIDO

- 1 Termofusor de 120 V-1500 W, 60 Hz
- 1 Base para termofusor fijo
- 1 Llave Allen®
- 1 Pinza de extracción
- 1 Pinza para corte de tubo PPR
- 6 Juego de dados
- 6 Tornillos
- 1 Nivel
- 1 Par de guantes
- 1 Flexometro 3 m
- 1 Desarmador

NOM

CÓDIGO	MODELO	POTENCIA		DISTRIB.	MAYOREO	LISTA
191803	TERMKIT-2000i-AK	2000 W	1	\$1,500.00	\$2,145.00	\$2,645.00



Tubo PPR

GRANEL

- ▶ Presión máxima a 20° C: 2 000 kPa/290 PSI
- ▶ Presión máxima a 95° C: 620 kPa/90 PSI
- ▶ PN: 1.6 MPa (16 Bar)



CÓDIGO	DIÁMETRO EXTERIOR	LARGO DE TUBO		DISTRIB.	MAYOREO	LISTA
118797	(1/2") 20 mm	3 m	50 pzas	\$33.00	\$47.00	\$58.00
118798	(3/4") 25 mm	3 m	25 pzas	\$49.00	\$70.00	\$86.00
118799	(1") 32 mm	3 m	20 pzas	\$82.00	\$117.00	\$145.00

Codo 90°

BOLSA

- ▶ Presión máxima a 20° C: 2 400 kPa/345 PSI
- ▶ Presión máxima a 95° C: 620 kPa/90 PSI
- ▶ PN 2.5 MPa (25 Bar)



PRECIOS POR PIEZA

CÓDIGO	MEDIDA	PIEZAS X BOLSA		DISTRIB.	MAYOREO	LISTA
118601	20 mm	10	42 bolsas	\$2.30	\$3.30	\$4.10
118602	25 mm	10	27 bolsas	\$3.00	\$4.30	\$5.30
118603	32 mm	10	15 bolsas	\$6.00	\$8.60	\$10.60

Mínimo a surtir 1 bolsa con 10 piezas

Codo 45°

BOLSA

- ▶ Presión máxima a 20° C: 2 400 kPa/345 PSI
- ▶ Presión máxima a 95° C: 620 kPa/90 PSI
- ▶ PN 2.5 MPa (25 Bar)



PRECIOS POR PIEZA

CÓDIGO	MEDIDA	PIEZAS X BOLSA		DISTRIB.	MAYOREO	LISTA
118611	20 mm	10	50 bolsas	\$2.50	\$3.60	\$4.40
118612	25 mm	10	35 bolsas	\$4.00	\$5.70	\$7.10
118613	32 mm	10	20 bolsas	\$5.00	\$7.10	\$8.80

Mínimo a surtir 1 bolsa con 10 piezas

Cople

BOLSA

- ▶ Presión máxima a 20° C: 2 400 kPa/345 PSI
- ▶ Presión máxima a 95° C: 620 kPa/90 PSI
- ▶ PN 2.5 MPa (25 Bar)



PRECIOS POR PIEZA

CÓDIGO	MEDIDA	PIEZAS X BOLSA		DISTRIB.	MAYOREO	LISTA
118621	20 mm	10	79 bolsas	\$1.50	\$2.10	\$2.60
118622	25 mm	10	49 bolsas	\$2.50	\$3.60	\$4.40
118623	32 mm	10	30 bolsas	\$4.00	\$5.70	\$7.10

Mínimo a surtir 1 bolsa con 10 piezas

Reducción

BOLSA

- ▶ Presión máxima a 20° C: 2 400 kPa/345 PSI
- ▶ Presión máxima a 95° C: 620 kPa/90 PSI
- ▶ PN 2.5 MPa (25 Bar)



PRECIOS POR PIEZA

CÓDIGO	MEDIDA	PIEZAS X BOLSA		DISTRIB.	MAYOREO	LISTA
118631	25 mm x 20 mm	10	68 bolsas	\$1.80	\$2.60	\$3.20
118632	32 mm x 20 mm	10	50 bolsas	\$3.00	\$4.30	\$5.30
118633	32 mm x 25 mm	10	40 bolsas	\$3.50	\$5.00	\$6.20

Mínimo a surtir 1 bolsa con 10 piezas

Codo 90°, rosca hembra

BOLSA

- ▶ Presión máxima a 20° C: 2 400 kPa/345 PSI
- ▶ Presión máxima a 95° C: 620 kPa/90 PSI
- ▶ PN 2.5 MPa (25 Bar)



PRECIOS POR PIEZA

CÓDIGO	MEDIDA	PIEZAS X BOLSA		DISTRIB.	MAYOREO	LISTA
118711	20 mm x 1/2"	10	15 bolsas	\$17.00	\$24.30	\$30.00
118712	25 mm x 3/4"	10	12 bolsas	\$22.00	\$31.00	\$39.00
118713	32 mm x 1"	10	6 bolsas	\$41.00	\$59.00	\$72.00

Mínimo a surtir 1 bolsa con 10 piezas

Codo 90°, rosca macho

BOLSA

- ▶ Presión máxima a 20° C: 2 400 kPa/345 PSI
- ▶ Presión máxima a 95° C: 620 kPa/90 PSI
- ▶ PN 2.5 MPa (25 Bar)



PRECIOS POR PIEZA

CÓDIGO	MEDIDA	PIEZAS X BOLSA		DISTRIB.	MAYOREO	LISTA
118701	20 mm x 1/2"	10	16 bolsas	\$20.00	\$29.00	\$35.00
118702	25 mm x 3/4"	10	10 bolsas	\$32.00	\$46.00	\$56.00
118703	32 mm x 1"	10	6 bolsas	\$55.00	\$79.00	\$97.00

Mínimo a surtir 1 bolsa con 10 piezas

Tee reducida

BOLSA

- ▶ Presión máxima a 20° C: 2 400 kPa/345 PSI
- ▶ Presión máxima a 95° C: 620 kPa/90 PSI
- ▶ PN 2.5 MPa (25 Bar)
- ▶ 118651 y 118652 reducidas extrema
- ▶ 118653 reducida central



PRECIOS POR PIEZA

CÓDIGO	MEDIDA	PIEZAS X BOLSA		DISTRIB.	MAYOREO	LISTA
118651	25 x 20 x 20 mm	10	32 bolsas	\$5.40	\$7.70	\$9.50
118652	25 x 25 x 20 mm	10	20 bolsas	\$4.00	\$5.70	\$7.10
118653	25 x 20 x 25 mm	10	24 bolsas	\$4.00	\$5.70	\$7.10

Mínimo a surtir 1 bolsa con 10 piezas

Tee rosca central hembra

BOLSA

- ▶ Presión máxima a 20° C: 2 400 kPa/345 PSI
- ▶ Presión máxima a 95° C: 620 kPa/90 PSI
- ▶ PN 2.5 MPa (25 Bar)



PRECIOS POR PIEZA

CÓDIGO	MEDIDA	PIEZAS X BOLSA		DISTRIB.	MAY.	LISTA
118722	20 mm x 1/2"	10	14 bolsas	\$20.00	\$29.00	\$35.00

Mínimo a surtir 1 bolsa con 10 piezas

Tee sencilla

BOLSA

- ▶ Presión máxima a 20° C: 2 400 kPa/345 PSI
- ▶ Presión máxima a 95° C: 620 kPa/90 PSI
- ▶ PN 2.5 MPa (25 Bar)



PRECIOS POR PIEZA

CÓDIGO	MEDIDA	PIEZAS X BOLSA		DISTRIB.	MAYOREO	LISTA
118641	20 mm	10	32 bolsas	\$2.70	\$3.90	\$4.80
118642	25 mm	10	20 bolsas	\$4.50	\$6.40	\$7.90
118643	32 mm	10	12 bolsas	\$7.40	\$10.60	\$13.10

Mínimo a surtir 1 bolsa con 10 piezas

Tee rosca central macho

BOLSA

- ▶ Presión máxima a 20° C: 2 400 kPa/345 PSI
- ▶ Presión máxima a 95° C: 620 kPa/90 PSI
- ▶ PN 2.5 MPa (25 Bar)



PRECIOS POR PIEZA

CÓDIGO	MEDIDA	PIEZAS X BOLSA		DISTRIB.	MAYOREO	LISTA
118721	20 mm x 1/2"	10	14 bolsas	\$23.00	\$33.00	\$41.00

Mínimo a surtir 1 bolsa con 10 piezas

Tuerca unión mixta

BOLSA

- ▶ Presión máxima a 20° C: 2 400 kPa/345 PSI
- ▶ Presión máxima a 95° C: 620 kPa/90 PSI
- ▶ PN 2.5 MPa (25 Bar)



PRECIOS POR PIEZA

CÓDIGO	MEDIDA	PIEZAS X BOLSA		DISTRIB.	MAYOREO	LISTA
118751	20 mm x 1/2"	10	13 bolsas	\$57.00	\$81.00	\$101.00
118752	25 mm x 3/4"	10	10 bolsas	\$72.00	\$103.00	\$127.00
118753	32 mm x 1"	10	5 bolsas	\$105.00	\$150.00	\$185.00

Mínimo a surtir 1 bolsa con 10 piezas

Tuerca unión

BOLSA

- ▶ Presión máxima a 20° C: 2 400 kPa/345 PSI
- ▶ Presión máxima a 95° C: 620 kPa/90 PSI
- ▶ PN 2.5 MPa (25 Bar)



PRECIOS POR PIEZA

CÓDIGO	MEDIDA	PIEZAS X BOLSA		DISTRIB.	MAYOREO	LISTA
118761	20 mm	10	18 bolsas	\$39.00	\$56.00	\$69.00
118762	25 mm	10	12 bolsas	\$50.00	\$71.00	\$88.00
118763	32 mm	10	8 bolsas	\$86.00	\$123.00	\$150.00

Mínimo a surtir 1 bolsa con 10 piezas

Adaptador macho

BOLSA

- ▶ Presión máxima a 20° C: 2 400 kPa/345 PSI
- ▶ Presión máxima a 95° C: 620 kPa/90 PSI
- ▶ PN 2.5 MPa (25 Bar)



PRECIOS POR PIEZA

CÓDIGO	MEDIDA	PIEZAS X BOLSA		DISTRIB.	MAYOREO	LISTA
118731	20 mm x 1/2"	10	18 bolsas	\$19.00	\$27.00	\$34.00
118732	25 mm x 3/4"	10	13 bolsas	\$27.00	\$39.00	\$48.00
118733	32 mm x 1"	10	8 bolsas	\$50.00	\$71.00	\$88.00

Mínimo a surtir 1 bolsa con 10 piezas

Adaptador hembra

BOLSA

- ▶ Presión máxima a 20° C: 2 400 kPa/345 PSI
- ▶ Presión máxima a 95° C: 620 kPa/90 PSI
- ▶ PN 2.5 MPa (25 Bar)



PRECIOS POR PIEZA

CÓDIGO	MEDIDA	PIEZAS X BOLSA		DISTRIB.	MAYOREO	LISTA
118741	20 mm x 1/2"	10	23 bolsas	\$15.00	\$21.40	\$26.00
118742	25 mm x 3/4"	10	16 bolsas	\$22.00	\$31.00	\$39.00
118743	32 mm x 1"	10	8 bolsas	\$42.00	\$60.00	\$74.00

Mínimo a surtir 1 bolsa con 10 piezas

Tapón

BOLSA

- ▶ Presión máxima a 20° C: 2 400 kPa/345 PSI
- ▶ Presión máxima a 95° C: 620 kPa/90 PSI
- ▶ PN 2.5 MPa (25 Bar)



PRECIOS POR PIEZA

CÓDIGO	MEDIDA	PIEZAS X BOLSA		DISTRIB.	MAYOREO	LISTA
118661	20 mm	10	130 bolsas	\$1.50	\$2.10	\$2.60
118662	25 mm	10	80 bolsas	\$2.50	\$3.60	\$4.40
118663	32 mm	10	50 bolsas	\$4.00	\$5.70	\$7.10

Mínimo a surtir 1 bolsa con 10 piezas

Poncho uso ligero

BOLSA

- ▶ Capucha fija
- ▶ Unitalla
- ▶ 100% Polietileno



CÓDIGO	COLOR	📦	📦	DISTRIB.	MAYOREO	LISTA
307711	Amarillo	50	200	\$14.00	\$20.00	\$24.70
307712	Azul	50	200	\$14.00	\$20.00	\$24.70
307713	Negro	50	200	\$14.00	\$20.00	\$24.70

Plomada

GRANEL

- ▶ Carrete para alinear perpendicularmente al piso, puertas, ventanas, castillos, etc.
- ▶ Plomadas con centro, ideales para albañilería



CÓDIGO	No.	PESO BARRIL	📦	📦	DISTRIB.	MAYOREO	LISTA
303805	1	200 g	6	36	\$60.00	\$86.00	\$106.00
303802	2	350 g	6	36	\$80.00	\$114.00	\$141.00
303803	3	375 g	6	36	\$95.00	\$136.00	\$170.00
303804	4	750 g	6	24	\$175.00	\$250.00	\$310.00

Protector auditivo triple barrera

ESTUCHE

- ▶ Diseño de triple barrera para asegurar un buen ajuste en el canal auditivo y garantizar el bloqueo de ruidos
- ▶ Tapones ergonómicos reusables de fácil ajuste
- ▶ Incluye práctico estuche para guardarlos y transportarlos



CÓDIGO	CARACTERÍSTICA	📦	📦	DISTRIB.	MAYOREO	LISTA
108001	Con cordón y estuche	10	1000	\$8.00	\$11.40	\$14.10

Prensa tipo C de hierro nodular

TARJETA

- ▶ Fabricadas en hierro nodular, ligera y de gran resistencia al trabajo pesado
- ▶ Virola con diseño de rótula, ajustable al cuerpo
- ▶ Husillo de acero al carbono



CÓDIGO	MEDIDA	📦	📦	DISTRIB.	MAYOREO	LISTA
101308	1"	12	144	\$30.00	\$43.00	\$53.00
101309	2"	12	72	\$45.00	\$64.00	\$79.00
101310	3"	6	36	\$75.00	\$107.00	\$132.00
101311	4"	6	36	\$100.00	\$143.00	\$175.00
101312	5"	6	30	\$135.00	\$195.00	\$240.00
101313	6"	6	24	\$175.00	\$250.00	\$310.00
101314	8"	6	12	\$230.00	\$330.00	\$405.00

Protector auditivo de espuma con y sin cordón

TARJETA

- ▶ Fabricados con espuma de poliuretano de expansión lenta que ejercen muy poca presión en el oído
- ▶ Espuma dermatológicamente segura que proporciona un aislamiento cómodo y efectivo



CÓDIGO	CARACTERÍSTICA	📦	📦	DISTRIB.	MAYOREO	LISTA
108002	Con cordón	10	1000	\$5.60	\$8.00	\$9.90
108003	Sin cordón	10	1000	\$4.50	\$6.40	\$7.90

Poncho

BOLSA PVC

- ▶ Prácticos broches laterales
- ▶ Capucha fija con jareta ajustable
- ▶ Unitalla
- ▶ 100% PVC



CÓDIGO	ESPESOR	📦	📦	DISTRIB.	MAYOREO	LISTA
107711	0.25 mm	5	20	\$95.00	\$136.00	\$170.00
107712	0.10 mm	5	20	\$55.00	\$79.00	\$97.00

Prensa esquinera

TARJETA

- ▶ Cuerpo de aluminio
- ▶ Sujeta material de igual o diferente espesor en ángulos rectos
- ▶ Ideal para unión de marcos



CÓDIGO	📦	📦	DISTRIB.	MAYOREO	LISTA
101304	6	36	\$90.00	\$129.00	\$160.00

Rodillera Profesional

TARJETA COLGANTE

- ▶ Tiras elásticas de ajuste
- ▶ Cápsula de PVC rígido que protege de clavos, vidrios, piedras etc.
- ▶ Acoginado suave y plantilla de gel para mayor estabilidad



CÓDIGO	📦	📦	DISTRIB.	MAYOREO	LISTA
107841	2	12	\$245.00	\$350.00	\$430.00

Piedra para guadaña

CAJA

- ▶ Fabricada de carburo de silicio
- ▶ Para afilado, biselado de vidrio, guadañas, hachas y machetes



CÓDIGO	GRANO			DISTRIB.	MAYOREO	LISTA
114721	90	10	100	\$20.00	\$29.00	\$35.00
114722	120	10	100	\$20.00	\$29.00	\$35.00

Rueda abrasiva para esmeril, ø 5"

CAJA

- ▶ Fabricada de óxido de aluminio
- ▶ Para desbaste y afilado
- ▶ Uso general
- ▶ Compatible con el esmeril AKSI® 197002



ESPECIFICACIONES	
Diámetro	5" - 125 mm
Centro	1/2" - 13 mm
Espesor	3/4" - 19 mm



Óxido de aluminio						
CÓDIGO	GRANO			DISTRIB.	MAYOREO	LISTA
114701	36	6	24	\$50.00	\$71.00	\$88.00

Rueda abrasiva para esmeril, ø 6"

CAJA

- ▶ Para desbaste y afilado
- ▶ Uso general
- ▶ Compatible con el esmeril AKSI® 197001
- ▶ Incluye 3 adaptadores plásticos



ESPECIFICACIONES		Adaptadores	
114702 / 114703	114704 / 114705	3/4" - 1"	5/8" - 3/4"
Diámetro	6" - 152 mm	6" - 152 mm	3/4" - 1"
Centro	1" - 25 mm	1" - 25 mm	5/8" - 3/4"
Espesor	3/4" - 19 mm	1" - 25 mm	1/2" - 5/8"

Óxido de aluminio						
CÓDIGO	GRANO			DISTRIB.	MAYOREO	LISTA
114702	36	6	24	\$65.00	\$93.00	\$115.00
114704	36	6	24	\$75.00	\$107.00	\$132.00
114703	60	6	24	\$65.00	\$93.00	\$115.00
114705	60	6	24	\$75.00	\$107.00	\$132.00

Piedra para asentar

BLÍSTER

- ▶ Fabricada de óxido de aluminio
- ▶ Grano 150 (grueso): ideal para afilar, remover imperfecciones
- ▶ Grano 240 (fino): para asentar
- ▶ Para afilado de cuchillos, tijeras y otras herramientas de corte en general



CÓDIGO	MEDIDA			DISTRIB.	MAYOREO	LISTA
114731	6"	10	50	\$57.00	\$81.00	\$101.00
114732	8"	10	50	\$65.00	\$93.00	\$115.00

Rueda abrasiva para esmeril, ø 8"

CAJA

- ▶ Fabricada de óxido de aluminio
- ▶ Para desbaste y afilado
- ▶ Uso general
- ▶ Incluye 3 adaptadores plásticos



ESPECIFICACIONES		Adaptadores	
Diámetro	8" - 203 mm	3/4" - 1"	5/8" - 3/4"
Centro	1" - 25 mm	5/8" - 3/4"	1/2" - 5/8"
Espesor	1" - 25 mm	1/2" - 5/8"	



Óxido de aluminio						
CÓDIGO	GRANO			DISTRIB.	MAYOREO	LISTA
114706	36	6	12	\$115.00	\$165.00	\$205.00
114707	60	6	12	\$115.00	\$165.00	\$205.00

Complemento

ESMERIL DE BANCO

560 W

8"
DIÁMETRO DE PIEDRA

NOM

1
Año de garantía

CÓDIGO		DISTRIB.	MAYOREO	LISTA
197003	1	\$1,600.00	\$2,285.00	\$2,820.00

ESPECIFICACIONES TÉCNICAS

Tensión / frecuencia	127 V ~ / 60 Hz
Potencia	560 W
Corriente	3 A
Velocidad (sin carga)	3 450 rev / min
Diámetro de eje	5/8" (16 mm)
Diámetro de piedra	8" (203.4 mm)

ESMERIL DE BANCO

250 W

6"
DIÁMETRO DE PIEDRA

NOM

1
Año de garantía

CÓDIGO		DISTRIB.	MAYOREO	LISTA
197002	1	\$750.00	\$1,070.00	\$1,325.00

ESPECIFICACIONES TÉCNICAS

Tensión / frecuencia	127 V ~ / 60 Hz
Potencia	250 W / 1/3 HP
Corriente	2 A
Velocidad (sin carga)	3 450 rev / min
Diámetro de eje	1/2" (12.7 mm)
Diámetro de piedra	6" (150 mm)

Más detalles en: **Página 266**

Regadera eléctrica, 3 temperaturas

PROX.

CAJA

- ▶ Cuerpo termo-plástico con aislante térmico y eléctrico
- ▶ Incluye una manguera y ducha manual
- ▶ Ahorradora, mínimo consumo de energía
- ▶ Flujo uniforme de agua



CARACTERÍSTICAS	
127 V	
50 A	
5500 W	

NOM

3 años GARANTÍA

Euro

CÓDIGO			DISTRIB.	MAYOREO	LISTA
114891	4	24	\$225.00	\$320.00	\$395.00

Regadera eléctrica, 4 temperaturas

PROX.

CAJA

- ▶ Cuerpo termo-plástico con aislante térmico y eléctrico
- ▶ Incluye una manguera y ducha manual
- ▶ Ahorradora, mínimo consumo de energía
- ▶ Proporciona un baño de mayor volumen



CARACTERÍSTICAS	
127 V	
50 A	
5500 W	

NOM

3 años GARANTÍA

Euro

CÓDIGO			DISTRIB.	MAYOREO	LISTA
114896	4	24	\$310.00	\$445.00	\$545.00

Regadera eléctrica, 3 temperaturas

PROX.

CAJA

- ▶ Cuerpo termo-plástico con aislante térmico y eléctrico
- ▶ Incluye una manguera y ducha manual
- ▶ Ahorradora, mínimo consumo de energía
- ▶ Flujo uniforme de agua



CARACTERÍSTICAS	
127 V	
50 A	
5500 W	

NOM

3 años GARANTÍA

Euro

CÓDIGO			DISTRIB.	MAYOREO	LISTA
114892	4	24	\$225.00	\$320.00	\$395.00

Regadera eléctrica, 4 temperaturas

PROX.

CAJA

- ▶ Cuerpo termo-plástico con aislante térmico y eléctrico
- ▶ Incluye una manguera y ducha manual
- ▶ Ahorradora, mínimo consumo de energía
- ▶ Proporciona un baño de mayor volumen



CARACTERÍSTICAS	
127 V	
50 A	
5500 W	

NOM

3 años GARANTÍA

Euro

CÓDIGO			DISTRIB.	MAYOREO	LISTA
114897	4	24	\$310.00	\$445.00	\$545.00

Resistencia para regadera eléctrica, 3 temperaturas

PROX.

CAJA

- ▶ Con 3 temperaturas
- ▶ Compatible con la regadera eléctrica 114891 y 114892



3 años GARANTÍA

Euro

NOM

CÓDIGO			DISTRIB.	MAYOREO	LISTA
114895	4	24	\$65.00	\$93.00	\$115.00

Resistencia para regadera eléctrica, 4 temperaturas

PROX.

CAJA

- ▶ Con 4 temperaturas
- ▶ Compatible con la regadera eléctrica 114896 y 114897



3 años GARANTÍA

Euro

NOM

CÓDIGO			DISTRIB.	MAYOREO	LISTA
114899	4	24	\$65.00	\$93.00	\$115.00

Regadera tipo platillo

CAJA

- ▶ Cuerpo fabricado en plástico de alta resistencia
- ▶ Chapetón metálico
- ▶ Brazo plástico
- ▶ Cabeza anti-sarro de 4 1/2"
- ▶ Puntas plásticas para una fácil limpieza



3 años GARANTÍA

EURO

NOM

CÓDIGO	4	40	DISTRIB.	MAYOREO	LISTA
114801			\$110.00	\$155.00	\$195.00

Regadera redonda metálica

CAJA

- ▶ Cabeza metálica de 3 1/2"
- ▶ Incluye brazo y chapetón metálicos



3 años GARANTÍA

EURO

NOM

CÓDIGO	4	40	DISTRIB.	MAYOREO	LISTA
114802			\$90.00	\$129.00	\$160.00

Regadera redonda metálica

CAJA

- ▶ Cabeza metálica de 3 1/2"



3 años GARANTÍA

EURO

NOM

CÓDIGO	4	40	DISTRIB.	MAYOREO	LISTA
114803			\$75.00	\$107.00	\$132.00

Regadera redonda

CABALLETE

- ▶ Resistente cabeza de ABS de 3 1/2"



12 meses GARANTÍA

ITIMAXTOOL

NOM

CÓDIGO	4	40	DISTRIB.	MAYOREO	LISTA
308202			\$38.00	\$54.00	\$67.00

Regadera de ABS cromada

CAJA

- ▶ Cabeza anti-sarro de 2 1/2"
- ▶ Fácil limpieza



3 años GARANTÍA

EURO

NOM

CÓDIGO	4	40	DISTRIB.	MAYOREO	LISTA
114804			\$45.00	\$64.00	\$79.00

Regadera cuadrada metálica

CAJA

- ▶ Cabeza metálica de 2"
- ▶ Incluye brazo plástico y chapetón metálico



3 años GARANTÍA

EURO

NOM

CÓDIGO	4	40	DISTRIB.	MAYOREO	LISTA
114807			\$95.00	\$136.00	\$170.00

Regadera estándar

CABALLETE

- ▶ Resistente cabeza de ABS
- ▶ Excelente distribución del agua
- ▶ Incluye brazo y chapetón



12 meses GARANTÍA

ITIMAXTOOL

NOM

CÓDIGO	4	40	DISTRIB.	MAYOREO	LISTA
308201			\$38.00	\$54.00	\$67.00

Regadera de ABS blanca

CAJA

- ▶ Cabeza anti-sarro de 2 1/2"
- ▶ Fácil limpieza



3 años GARANTÍA

EURO

NOM

CÓDIGO	4	40	DISTRIB.	MAYOREO	LISTA
114805			\$43.00	\$61.00	\$76.00

Rastrillo jardinero

NUEVO

GRANEL

- ▶ Cabeza de acero con 14 dientes
- ▶ Mango de madera



CARACTERÍSTICAS	
Cabeza	14.5" (37 cm)
Mango	49" (125 cm)
Espesor de peine	5/32" (4 mm)



CÓDIGO		DISTRIB.	MAYOREO	LISTA
111231	6	\$135.00	\$195.00	\$240.00

Rastrillo recto

NUEVO

GRANEL

- ▶ Cabeza de acero con 16 dientes
- ▶ Mango de madera



CARACTERÍSTICAS	
Cabeza	16 1/2" (42 cm)
Mango	60" (152 cm)
Espesor de peine	3/16" (4.8 mm)



CÓDIGO		DISTRIB.	MAYOREO	LISTA
111232	6	\$175.00	\$250.00	\$310.00

Complementos

Escoba metálica para jardín 22 dientes

GRANEL

- ▶ Fabricadas en acero alto carbono SAE 1050 gran resistencia al desgaste
- ▶ Uso rudo en hierba húmeda
- ▶ Acabado en pintura electrostática
- ▶ Mango de madera perfilada
- ▶ Diseño curvo



CÓDIGO	PRESENTACIÓN		DISTRIB.	MAYOREO	LISTA
100602	Con mango	50	\$75.00	\$107.00	\$132.00
100605	Sin mango	25	\$60.00	\$86.00	\$106.00

Escoba metálica para jardín 22 dientes

GRANEL

- ▶ Fabricada en acero al carbono
- ▶ Mango de madera perfilada
- ▶ Para uso en hierba húmeda
- ▶ Acabado en pintura electrostática
- ▶ Diseño curvo



CÓDIGO	PRESENTACIÓN		DISTRIB.	MAYOREO	LISTA
302502	Con mango	25	\$70.00	\$100.00	\$123.00
302504	Sin mango	25	\$55.00	\$79.00	\$97.00

Escoba plástica para jardín 22 dientes

GRANEL

- ▶ Fabricadas en polipropileno, gran flexibilidad en los dientes ya que no se deforman
- ▶ Para uso en hierba seca
- ▶ Mango de madera pulido



18 meses GARANTÍA



CÓDIGO	PRESENTACIÓN		DISTRIB.	MAYOREO	LISTA
302503	Con mango	6 36	\$65.00	\$93.00	\$115.00
302505	Sin mango	6 24	\$45.00	\$64.00	\$79.00

Remachadora tipo acordeón

PROX.

BLÍSTER

- ▶ Con 5 boquillas intercambiables de 3/32", 1/8", 5/32", 3/16" y 1/4"
- ▶ Boquillas de cambio rápido
- ▶ Cuerpo de aluminio
- ▶ Mango ergonómico



10 años GARANTÍA



CÓDIGO			DISTRIB.	MAYOREO	LISTA
101904	5	10	\$360.00	\$515.00	\$635.00

Repuestos para remachadora

PROX.

BOLSA

- ▶ Juego de repuestos para remachadora tipo acordeón



10 años GARANTÍA



CÓDIGO			DISTRIB.	MAYOREO	LISTA
101905	25	150	\$75.00	\$107.00	\$132.00

Remachadora industrial

BLÍSTER

- ▶ Con cuatro boquillas intercambiables de 3/32", 1/8", 5/32" y 3/16"
- ▶ Boquillas de cambio rápido
- ▶ Sistema de presión ajustable para remachado
- ▶ Mango ergonómico



10 años GARANTÍA
AKSI

CÓDIGO			DISTRIB.	MAYOREO	LISTA
101903	6	24	\$185.00	\$265.00	\$325.00

Remachadora profesional con cabeza movable

BLÍSTER

- ▶ Con cuatro boquillas intercambiables de 3/32", 1/8", 5/32" y 3/16"
- ▶ Cabeza y cuerpo fabricada en aluminio
- ▶ Palanca de accionamiento bricada en acero al carbono
- ▶ Mangos recubiertos de PVC

CAPACIDAD DE GIRO 360°



10 años GARANTÍA
AKSI

CÓDIGO			DISTRIB.	MAYOREO	LISTA
101902	6	24	\$255.00	\$365.00	\$450.00

Remachadora profesional 10"

BLÍSTER

- ▶ Con cuatro boquillas intercambiables de 3/32", 1/8", 5/32" y 3/16"
- ▶ Boquillas de acero al cromo y cuerpo fabricado en aluminio
- ▶ Ideal para trabajo rudo sobre aluminio y diversos materiales plásticos y metálicos



10 años GARANTÍA
AKSI

CÓDIGO			DISTRIB.	MAYOREO	LISTA
101901	3	36	\$115.00	\$165.00	\$205.00

Remachadora

BLÍSTER

- ▶ Con cuatro boquillas intercambiables de 3/32", 1/8", 5/32" y 3/16"
- ▶ Cilindro de acero templado y mangos de vinil
- ▶ Ideal para reparaciones en el hogar



12 meses GARANTÍA
IT MAXTOOL

CÓDIGO	PRESENTACIÓN			DISTRIB.	MAYOREO	LISTA
302201	Sin Remaches	3	36	\$80.00	\$114.00	\$141.00
302202	Con Remaches	6	36	\$95.00	\$136.00	\$170.00

Remache de aluminio, blanco y negro

CABALLETE

- ▶ Perfectos para unir de forma fácil piezas no desmontables de metal, madera, plástico, etc.



AKSI

		BLANCO				PRECIO POR BOLSA CON 100 REMACHES		
CÓDIGO	No.	DIÁMETRO (in -mm)	AGARRE MÁX. (in -mm)			DISTRIB.	MAYOREO	LISTA
105369	44B	1/8" - 3.1	1/4" - 6.3	10 bolsas	60 bolsas	\$21.50	\$31.00	\$38.00
105370	45B	1/8" - 3.1	5/16" - 7.9	10 bolsas	60 bolsas	\$22.00	\$31.00	\$39.00
105371	46B	1/8" - 3.1	3/8" - 9.5	10 bolsas	60 bolsas	\$23.00	\$33.00	\$41.00
105372	54B	5/32" - 3.9	1/4" - 6.3	10 bolsas	60 bolsas	\$28.00	\$40.00	\$49.00
105373	56B	5/32" - 3.9	3/8" - 9.5	5 bolsas	30 bolsas	\$33.00	\$47.00	\$58.00
		NEGRO						
105374	44N	1/8" - 3.1	1/4" - 6.3	10 bolsas	60 bolsas	\$21.50	\$31.00	\$38.00
105375	45N	1/8" - 3.1	5/16" - 7.9	10 bolsas	60 bolsas	\$22.00	\$31.00	\$39.00
105376	46N	1/8" - 3.1	3/8" - 9.5	10 bolsas	60 bolsas	\$23.00	\$33.00	\$41.00
105377	54N	5/32" - 3.9	1/4" - 6.3	10 bolsas	60 bolsas	\$28.00	\$40.00	\$49.00
105378	56N	5/32" - 3.9	3/8" - 9.5	5 bolsas	30 bolsas	\$33.00	\$47.00	\$58.00

Remache de aluminio

CABALLETE

- ▶ Repartidos en bolsas plásticas perfectamente identificados con etiquetas para conocer las medidas del remache y a su vez empacados dentro de una caja
- ▶ Los códigos 105367 y 105368 son de ala ancha

PRECIO POR BOLSA
CON LAS PIEZAS INDICADAS EN LA TABLA



ALA ANCHA PARA MEJOR AGARRE

						PRECIO POR BOLSA (consulta la tabla)			
CÓDIGO	No.	DIÁMETRO (in -mm)	AGARRE MÁX. (in -mm)	PZAS. X BOLSA			DISTRIB.	MAYOREO	LISTA
105351	42	1/8" - 3.1	1/8" - 3.1	100	10 bolsas	60 bolsas	\$15.00	\$21.40	\$26.00
105352	43	1/8" - 3.1	3/16" - 4.7	100	10 bolsas	60 bolsas	\$16.00	\$22.90	\$28.00
105353	44	1/8" - 3.1	1/4" - 6.3	100	10 bolsas	60 bolsas	\$17.00	\$24.30	\$30.00
105354	45	1/8" - 3.1	5/16" - 7.9	100	10 bolsas	60 bolsas	\$18.00	\$26.00	\$32.00
105355	46	1/8" - 3.1	3/8" - 9.5	100	10 bolsas	60 bolsas	\$19.00	\$27.00	\$34.00
105356	48	1/8" - 3.1	1/2" - 12.7	100	10 bolsas	60 bolsas	\$20.00	\$29.00	\$35.00
105357	52	5/32" - 3.9	1/8" - 3.1	100	10 bolsas	60 bolsas	\$22.00	\$31.00	\$39.00
105358	54	5/32" - 3.9	1/4" - 6.3	100	10 bolsas	60 bolsas	\$24.00	\$34.00	\$42.00
105359	56	5/32" - 3.9	3/8" - 9.5	100	5 bolsas	30 bolsas	\$25.00	\$36.00	\$44.00
105360	58	5/32" - 3.9	1/2" - 12.7	100	5 bolsas	30 bolsas	\$27.00	\$38.00	\$48.00
105361	62	3/16" - 4.7	1/8" - 3.1	100	5 bolsas	30 bolsas	\$29.00	\$41.00	\$51.00
105362	64	3/16" - 4.7	1/4" - 6.3	100	5 bolsas	30 bolsas	\$31.00	\$44.00	\$55.00
105363	66	3/16" - 4.7	3/8" - 9.5	100	5 bolsas	30 bolsas	\$38.00	\$54.00	\$67.00
105364	68	3/16" - 4.7	1/2" - 12.7	100	5 bolsas	30 bolsas	\$40.00	\$57.00	\$71.00
105365	610	3/16" - 4.7	5/8" - 15.8	50	5 bolsas	30 bolsas	\$23.00	\$33.00	\$41.00
105366	612	3/16" - 4.7	3/4" - 19.5	50	5 bolsas	30 bolsas	\$24.00	\$34.00	\$42.00
REMACHE DE ALA ANCHA									
105367	66	3/16" - 4.7	3/8" - 9.5	50	5 bolsas	30 bolsas	\$25.00	\$36.00	\$44.00
105368	68	3/16" - 4.7	1/2" - 12.7	50	5 bolsas	30 bolsas	\$27.00	\$39.00	\$48.00

Rafia color blanco

GRANEL

- ▶ Uso comercial
- ▶ No se pudre
- ▶ Resistente a la abrasión
- ▶ 100% polipropileno



CÓDIGO	PESO		DISTRIB.	MAYOREO	LISTA
113606	1 kg	20	\$100.00	\$143.00	\$175.00

Rodaja tipo bola

GRANEL

- ▶ Rueda fabricada en polipropileno



PRECIO POR PIEZA

CÓDIGO	MEDIDA	PESO	PLACA		DISTRIB.	MAYOREO	LISTA
119301	1 1/2"	50 kg	Espiga	30	\$15.00	\$21.40	\$26.00
119302	2"	50 kg	Espiga	30	\$19.00	\$27.00	\$34.00
119311	1 1/2"	50 kg	Placa móvil	30	\$16.00	\$22.90	\$28.00
119312	2"	50 kg	Placa móvil	30	\$19.00	\$27.00	\$34.00
119316	1 1/2"	25 kg	Placa móvil	30	\$14.00	\$20.00	\$24.70
119317	2"	25 kg	Placa móvil	30	\$16.00	\$22.90	\$28.00

Mínimo a surtir 1 caja con 4 piezas

Rodaja de hierro

PROX. ○*

GRANEL

- ▶ Rueda fabricada de hierro
- ▶ Diseño con placa fija y móvil
- ▶ Uso industrial
- ▶ Para superficies lisas de concreto



CÓDIGO	MEDIDA	PLACA			DISTRIB.	MAYOREO	LISTA
119201	2"	Móvil	4	80	\$30.00	\$43.00	\$53.00
119202	2 1/2"	Móvil	4	48	\$55.00	\$79.00	\$97.00
119203	3"	Móvil	4	36	\$60.00	\$86.00	\$106.00
*119204	4"	Móvil	N/A	60	\$99.00	\$141.00	\$175.00
119206	2"	Fija	4	80	\$27.00	\$39.00	\$48.00
119207	2 1/2"	Fija	4	48	\$49.00	\$70.00	\$86.00
119208	3"	Fija	4	36	\$53.00	\$76.00	\$93.00
*119209	4"	Fija	N/A	60	\$95.00	\$136.00	\$170.00

*Los códigos marcados llegarán próximamente

Rodaja de hule

GRANEL

- ▶ Rueda fabricada de hule
- ▶ Diseño en placa fija y móvil
- ▶ Uso general, interior y exterior



PRECIO POR PIEZA

CÓDIGO	MEDIDA	PLACA		DISTRIB.	MAYOREO	LISTA
119231	2"	Móvil	30	\$19.00	\$27.00	\$34.00
119232	2 1/2"	Móvil	20	\$35.00	\$50.00	\$62.00
119233	3"	Móvil	15	\$39.00	\$56.00	\$69.00
119236	2"	Fija	30	\$13.00	\$18.60	\$22.90
119237	2 1/2"	Fija	20	\$29.00	\$41.00	\$51.00
119238	3"	Fija	15	\$37.00	\$53.00	\$65.00

Mínimo a surtir 1 caja con 4 piezas

Rodaja de Nylon® tipo yoyo

GRANEL

- ▶ Disponible en espiga, móvil y móvil con freno
- ▶ Rueda fabricada en Nylon®
- ▶ Uso general



CÓDIGO	MEDIDA	DESCRIPCIÓN		DISTRIB.	MAYOREO	LISTA
119321	1 1/2"	Espiga	50	\$9.00	\$12.90	\$15.90
119322	2"	Espiga	40	\$10.00	\$14.30	\$17.60
119324	1 1/2"	Placa móvil	50	\$10.00	\$14.30	\$17.60
119325	2"	Placa móvil	40	\$11.00	\$15.70	\$19.40
119327	1 1/2"	Placa móvil y freno	50	\$11.00	\$15.70	\$19.40
119328	2"	Placa móvil y freno	40	\$13.00	\$18.60	\$22.90

Mínimo a surtir 1 caja con 4 piezas

Rodaja de PVC

GRANEL

- ▶ Rueda fabricada en PVC
- ▶ Los modelos 119211 y 119213 tienen freno
- ▶ Uso general interior y exterior

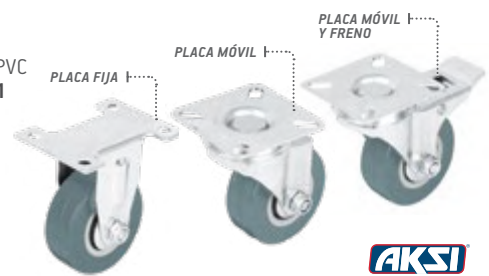

CÓDIGO	MEDIDA	PLACA		DISTRIB.	MAYOREO	LISTA	
119221	2"	Fija	4	120	\$15.00	\$21.40	\$26.00
119222	3"	Fija	4	60	\$30.00	\$43.00	\$53.00
119211	2"	Móvil y freno	4	100	\$25.00	\$36.00	\$44.00
119213	3"	Móvil y freno	4	60	\$45.00	\$64.00	\$79.00
119217	2"	Móvil	4	120	\$20.00	\$29.00	\$35.00
119218	3"	Móvil	4	60	\$33.00	\$47.00	\$58.00

Serrucho premium

GRANEL

- ▶ Hoja fabricada en acero alto carbono pulida y laqueada
- ▶ Mango ergonómico barnizado



DIENTES CORTE RÁPIDO TRIPLE FILO. CORTES 50% MÁS RÁPIDOS Y SUAVES QUE LOS DE TRABAJO NORMAL

CÓDIGO	TAMAÑO	📦	📦	DISTRIB.	MAYOREO	LISTA
103811	22"	6	36	\$130.00	\$185.00	\$230.00
103812	24"	6	36	\$140.00	\$200.00	\$245.00
103813	26"	6	36	\$155.00	\$220.00	\$275.00
103814	28"	6	36	\$165.00	\$235.00	\$290.00

Serrucho corte rápido con dientes triple filo

GRANEL

- ▶ Hoja fabricada en acero alto carbono pulida y laqueada
- ▶ Mango ergonómico barnizado



DIENTES CORTE RÁPIDO TRIPLE FILO. CORTES 50% MÁS RÁPIDOS Y SUAVES QUE LOS DE TRABAJO NORMAL

CÓDIGO	TAMAÑO	📦	📦	DISTRIB.	MAYOREO	LISTA
103801	18"	6	24	\$85.00	\$121.00	\$150.00
103802	20"	6	24	\$90.00	\$129.00	\$160.00
103803	22"	6	24	\$95.00	\$136.00	\$170.00
103804	24"	6	24	\$105.00	\$150.00	\$185.00

Serrucho corte fino con dientes doble filo

GRANEL

- ▶ Hoja fabricada en acero alto carbono pulida y laqueada
- ▶ Mango ergonómico barnizado



DIENTES CORTE FINO DOBLE FILO. CORTES 30% MÁS RÁPIDOS Y SUAVES QUE LOS DE TRABAJO NORMAL

CÓDIGO	TAMAÑO	📦	📦	DISTRIB.	MAYOREO	LISTA
103805	18"	6	24	\$75.00	\$107.00	\$132.00
103806	20"	6	24	\$80.00	\$114.00	\$141.00
103807	22"	6	24	\$85.00	\$121.00	\$150.00
103808	24"	6	24	\$95.00	\$136.00	\$170.00

Serrucho de costilla

GRANEL

- ▶ Hoja fabricada en acero alto carbono pulida y laqueada
- ▶ Diseño fino de dientes para trabajos delicados
- ▶ Mango ergonómico barnizado



DIENTES CORTE RÁPIDO TRIPLE FILO. CORTES 50% MÁS RÁPIDOS Y SUAVES QUE LOS DE TRABAJO NORMAL

CÓDIGO	TAMAÑO	📦	📦	DISTRIB.	MAYOREO	LISTA
103809	12"	6	24	\$85.00	\$121.00	\$150.00
103810	14"	6	24	\$90.00	\$129.00	\$160.00

Sierra para plásticos, aglomerados y contrachapados centro 5/8"

BLÍSTER

- ▶ Dientes de carburo de tungsteno
- ▶ Alta frecuencia en soldadura lo que permite un 50% más resistencia al desprendimiento
- ▶ Reduce astillado o viruta



DIENTES ALTERNADOS IZQUIERDA-DERECHA. CORTES MÁS SUAVES

CÓDIGO	Ø	DIENTES	📦	📦	DISTRIB.	MAYOREO	LISTA
118551	7 1/4"	48	3	12	\$140.00	\$200.00	\$245.00

Sierras para aluminio, centro 5/8"

BLÍSTER

- ▶ Dientes de carburo de tungsteno
- ▶ Alta frecuencia en soldadura lo que permite un 50% más resistencia al desprendimiento
- ▶ Realiza un corte largo y estrecho gracias a sus dientes trapezoidales



CÓDIGO	Ø	DIENTES	📦	📦	DISTRIB.	MAYOREO	LISTA
118531	10"	80	3	12	\$300.00	\$430.00	\$530.00
118532	10"	100	3	12	\$330.00	\$470.00	\$580.00
118541	12"	80	3	12	\$400.00	\$570.00	\$705.00
118542	12"	100	3	12	\$430.00	\$615.00	\$760.00

Sierras para madera, centro 5/8"

BLÍSTER

- ▶ Dientes de carburo de tungsteno
- ▶ Alta frecuencia en soldadura lo que permite un 50% más resistencia al desprendimiento



DIENTES ALTERNADOS IZQUIERDA-DERECHA. CORTES MÁS SUAVES



CÓDIGO	Ø	DIENTES	📦	📦	DISTRIB.	MAYOREO	LISTA
118501	7 1/4"	16	3	12	\$85.00	\$121.00	\$150.00
118502	7 1/4"	24	3	12	\$95.00	\$136.00	\$170.00
118503	7 1/4"	40	3	12	\$125.00	\$180.00	\$220.00
118504	7 1/4"	60	3	12	\$135.00	\$195.00	\$240.00
118511	10"	40	3	12	\$205.00	\$295.00	\$360.00
118512	10"	60	3	12	\$230.00	\$330.00	\$405.00
118513	10"	80	3	12	\$250.00	\$355.00	\$440.00

Sierras para madera, centro 1"

BLÍSTER

- ▶ Dientes de carburo de tungsteno
- ▶ Alta frecuencia en soldadura lo que permite un 50% más resistencia al desprendimiento



DIENTES ALTERNADOS IZQUIERDA-DERECHA. CORTES MÁS SUAVES



CÓDIGO	Ø	DIENTES	📦	📦	DISTRIB.	MAYOREO	LISTA
118516	10"	40	3	12	\$200.00	\$285.00	\$355.00
118517	10"	60	3	12	\$230.00	\$330.00	\$405.00
118518	10"	80	3	12	\$310.00	\$445.00	\$545.00
118521	12"	40	3	12	\$310.00	\$445.00	\$545.00
118522	12"	60	3	12	\$340.00	\$485.00	\$600.00
118523	12"	80	3	12	\$390.00	\$555.00	\$690.00
118524	12"	100	3	12	\$400.00	\$570.00	\$705.00

Segueta para caladora zanco "T" para cortes rectos en madera y PVC

BLÍSTER DE 5 PIEZAS

► Fabricadas en acero Cromo Vanadio

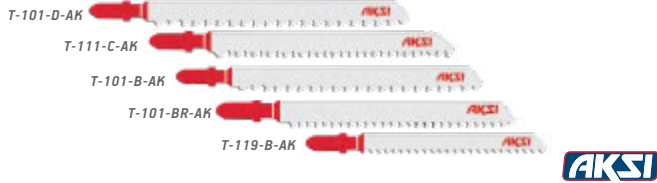

CÓDIGO	MODELO	DPP	ACABADO			DISTRIB.	MAYOREO	LISTA
115901	T-101-D-AK	6	Grueso	12	144	\$40.00	\$57.00	\$71.00
115902	T-111-C-AK	8	Estándar	12	144	\$30.00	\$43.00	\$53.00
115903	T-101-B-AK	10	Fino	12	144	\$40.00	\$57.00	\$71.00
115904	T-101-BR-AK	10	Fino	12	144	\$40.00	\$57.00	\$71.00
115905	T-119-B-AK	12	Fino	12	144	\$30.00	\$43.00	\$53.00

Segueta para caladora zanco "T" para cortes curvos en madera

BLÍSTER DE 5 PIEZAS

► Fabricadas en acero Cromo Vanadio

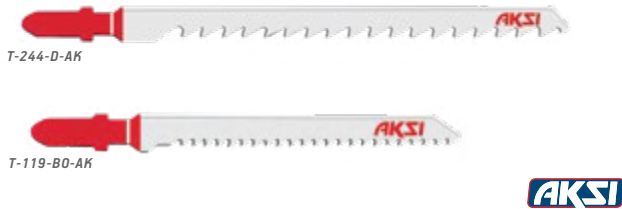

CÓDIGO	MODELO	DPP	ACABADO			DISTRIB.	MAYOREO	LISTA
115910	T-244-D-AK	6	Grueso	12	144	\$40.00	\$57.00	\$71.00
115911	T-119-B0-AK	12	Fino	12	144	\$30.00	\$43.00	\$53.00

Segueta para caladora zanco "T" para cortes rectos en metales, plástico y aluminio

BLÍSTER DE 5 PIEZAS

► Fabricadas en acero de alta velocidad

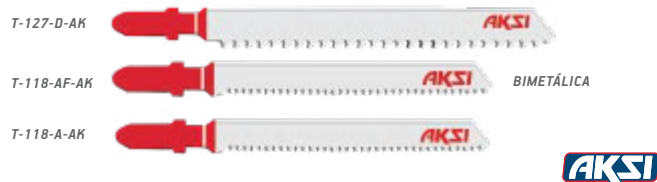

CÓDIGO	MODELO	DPP	ACABADO			DISTRIB.	MAYOREO	LISTA
115920	T-127-D-AK	8	Estándar	12	144	\$43.00	\$61.00	\$76.00
115921	T-118-AF-AK	21	Super fino	12	144	\$40.00	\$57.00	\$71.00
115922	T-118-A-AK	21	Super fino	12	144	\$40.00	\$57.00	\$71.00

Segueta para caladora zanco "U" para cortes rectos en madera y PVC

BLÍSTER DE 5 PIEZAS

► Fabricadas en acero Cromo Vanadio

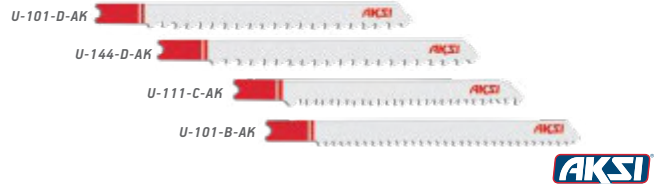

CÓDIGO	MODELO	DPP	ACABADO			DISTRIB.	MAYOREO	LISTA
115930	U-101-D-AK	6	Grueso	12	144	\$40.00	\$57.00	\$71.00
115931	U-144-D-AK	6	Grueso	12	144	\$40.00	\$57.00	\$71.00
115932	U-111-C-AK	8	Grueso	12	144	\$30.00	\$43.00	\$53.00
115933	U-101-B-AK	10	Fino	12	144	\$40.00	\$57.00	\$71.00

Segueta para caladora zanco "U" para cortes curvos en madera

BLÍSTER DE 5 PIEZAS

► Fabricadas en acero Cromo Vanadio



CÓDIGO	MODELO	DPP	ACABADO			DISTRIB.	MAYOREO	LISTA
115940	U-19-B0-AK	14	Fino	12	144	\$30.00	\$43.00	\$53.00

Segueta para caladora zanco "U" para cortes rectos en metales

BLÍSTER DE 5 PIEZAS

► Fabricadas en acero de alta velocidad



CÓDIGO	MODELO	DPP	ACABADO			DISTRIB.	MAYOREO	LISTA
115950	U-118-B-AK	12	Fino	12	144	\$45.00	\$64.00	\$79.00
115951	U-118-A-AK	21	Super fino	12	144	\$45.00	\$64.00	\$79.00

Segueta para sierra sable, cortes en metal

PROX.

BLÍSTER DE 2 PIEZAS

- ▶ Para corte de metal (lámina, canaleta y tubería)
- ▶ Zanco de 1/2"

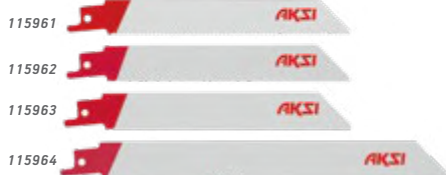

AKSI

CÓDIGO	DPP	LONGITUD			DISTRIB.	MAYOREO	LISTA
115961	14	6"	10	100	\$52.00	\$74.00	\$92.00
115962	18	6"	10	100	\$52.00	\$74.00	\$92.00
115963	24	6"	10	100	\$52.00	\$74.00	\$92.00
115964	18	8"	10	100	\$68.00	\$97.00	\$120.00

Segueta para sierra sable, cortes en madera

PROX.

BLÍSTER DE 2 PIEZAS

- ▶ Para corte en madera
- ▶ Zanco de 1/2"



AKSI

CÓDIGO	DPP	LONGITUD			DISTRIB.	MAYOREO	LISTA
115971	6	6"	10	100	\$60.00	\$86.00	\$106.00
115972	6	9"	10	100	\$84.00	\$120.00	\$148.00
115973	6	12"	10	100	\$92.00	\$131.00	\$160.00

Segueta para sierra sable, cortes para uso en general

PROX.

BLÍSTER DE 2 PIEZAS

- ▶ Para corte en metal, plástico y madera
- ▶ Zanco de 1/2"



AKSI

CÓDIGO	DPP	LONGITUD			DISTRIB.	MAYOREO	LISTA
115981	10 - 14	6"	10	100	\$52.00	\$74.00	\$92.00
115982	10 - 14	9"	10	100	\$76.00	\$109.00	\$134.00
115983	10 - 14	12"	10	100	\$100.00	\$143.00	\$175.00

Seguetas bimetalicas de 18 y 24 dpp

CAJA PLÁSTICA / BLÍSTER

- ▶ Dientes fabricados en acero alta velocidad
- ▶ Cuerpo altamente flexible, brinda resistencia y durabilidad



AKSI

CAJA con 50 piezas

PRECIO POR SEGUETA

CÓDIGO	SEGUETA	DIENTES		DISTRIB.	MAYOREO	LISTA
107501	12"	18 dpp	20 cajas	\$12.00	\$17.10	\$21.20
107502	12"	24 dpp	20 cajas	\$12.00	\$17.10	\$21.20

Mínimo a surtir 1 caja con 50 seguetas

BLÍSTER - set de 2 piezas

CÓDIGO	SEGUETA	DIENTES			DISTRIB.	MAYOREO	LISTA
107503	12"	18 dpp	15	150	\$35.00	\$50.00	\$62.00
107504	12"	24 dpp	15	150	\$35.00	\$50.00	\$62.00

Separador de loseta

CABALLETE

- ▶ Diseñados para la colocación exacta de loseta y azulejos
- ▶ Reutilizables



AKSI

CÓDIGO	MEDIDA	EMPAQUE			DISTRIB.	MAYOREO	LISTA
110201	1.5 mm	Bolsa c/200 pzas	36 Bolsas	144 Bolsas	\$15.00	\$21.40	\$26.00
110202	2 mm	Bolsa c/200 pzas	36 Bolsas	144 Bolsas	\$15.00	\$21.40	\$26.00
110203	3 mm	Bolsa c/150 pzas	36 Bolsas	144 Bolsas	\$15.00	\$21.40	\$26.00
110204	5 mm	Bolsa c/100 pzas	36 Bolsas	144 Bolsas	\$15.00	\$21.40	\$26.00
110206	8 mm	Bolsa c/65 pzas	36 Bolsas	144 Bolsas	\$15.00	\$21.40	\$26.00

Tarja para sobreponer 4 quemadores

CAJA

- ▶ Fabricada en acero inoxidable 304, resistente a oxidación
- ▶ 4 Quemadores italianos
- ▶ Uso con gas LP
- ▶ Perillas laterales, para mayor seguridad
- ▶ 8 soportes, mayor resistencia en peso a cacerolas grandes
- ▶ Esquinas dobladas para evitar filtraciones en los gabinetes
- ▶ Tarja con perforación para mezcladora o monomando

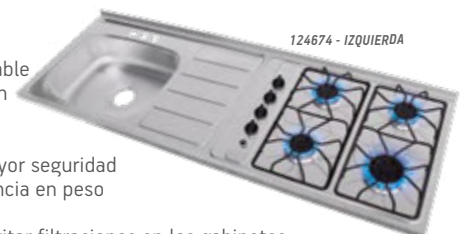

124674 - IZQUIERDA

3 años GARANTÍA

AKSI

NOM

CÓDIGO	DESCRIPCIÓN	MEDIDA	CALIBRE		DISTRIB.	MAYOREO	LISTA
124673	Derecha	150 x 52 cm	22	1	\$4,750.00	\$6,785.00	\$8,380.00
124674	Izquierda	150 x 52 cm	22	1	\$4,750.00	\$6,785.00	\$8,380.00

Sellador de silicón uso general

BLÍSTER

- ▶ Para uso en interiores y exteriores
- ▶ Excelente adherencia en vidrio, aluminio azulejo, madera, etc.



CÓDIGO	COLOR	CONTENIDO			DISTRIB.	MAYOREO	LISTA
105211	Transparente	85 g	6	48	\$27.00	\$39.00	\$48.00

Sellador de silicón cartucho para calafateadora

TUBO

- ▶ Uso general
- ▶ Para uso en interiores y exteriores
- ▶ Excelente adherencia en vidrio, aluminio, azulejo, madera, etc.
- ▶ Contenido: 280 ml



CÓDIGO	COLOR		DISTRIB.	MAYOREO	LISTA
105201	Transparente	12	\$45.00	\$64.00	\$79.00
105202	Blanco	12	\$45.00	\$64.00	\$79.00
105203	Negro	12	\$45.00	\$64.00	\$79.00

Sellador de silicón automotriz

BLÍSTER

- ▶ Resistencia a fluidos de transmisión, agua, aceite y anticongelantes
- ▶ Resiste temperaturas desde 0° C hasta 310° C.



CÓDIGO	COLOR	CONT.			DISTRIB.	MAYOREO	LISTA
105221	Negro	70 g	6	48	\$27.00	\$39.00	\$48.00
105222	Rojos	70 g	6	48	\$27.00	\$39.00	\$48.00

Taquete de plástico

CABALLETE

- ▶ Fabricados en polietileno de alta resistencia
- ▶ Lengüetas de anclaje que da mejor sujeción al taquete dentro del barreno
- ▶ Ideal para concreto



CÓDIGO	Ø	PZAS X BOLSA			DISTRIB.	MAYOREO	LISTA
106304	3/16"	50	12 Bolsas	96 Bolsas	\$5.00	\$7.10	\$8.80
106305	1/4"	50	12 Bolsas	96 Bolsas	\$8.00	\$11.40	\$14.10
106306	5/16"	50	12 Bolsas	96 Bolsas	\$12.00	\$17.10	\$21.20
106307	3/8"	50	12 Bolsas	96 Bolsas	\$18.00	\$26.00	\$32.00

Taquete expansivo con tornillo

CABALLETE

- ▶ Fabricado en acero al carbono con acabado galvanizado
- ▶ Para concreto



CÓDIGO	Ø	BOLSA			DISTRIB.	MAYOREO	LISTA
119001	1/4"	4 pzas	6	72	\$14.00	\$20.00	\$24.70
119002	5/16"	4 pzas	6	72	\$17.00	\$24.30	\$30.00

Taquete expansivo sin tornillo

CABALLETE

- ▶ Fabricado en zamac con acabado tropicalizado
- ▶ Para concreto



CÓDIGO	Ø	BOLSA			DISTRIB.	MAYOREO	LISTA
119003	1/4"	4 pzas	6	72	\$23.00	\$33.00	\$41.00
119004	5/16"	4 pzas	6	72	\$32.00	\$46.00	\$56.00
119005	3/8"	4 pzas	6	72	\$40.00	\$57.00	\$71.00

Tiralíneas plástico con nivel

BLÍSTER

- ▶ Precisión de trazo
- ▶ Gis de alta visibilidad color azul
- ▶ No se deshilacha



CÓDIGO	LONGITUD			DISTRIB.	MAYOREO	LISTA
119402	30 m	6	36	\$65.00	\$93.00	\$115.00

Tiralíneas plástico

BLÍSTER

- ▶ Precisión de trazo
- ▶ Gis de alta visibilidad color azul
- ▶ No se deshilacha



CÓDIGO	LONGITUD			DISTRIB.	MAYOREO	LISTA
309401	15 m	6	36	\$50.00	\$71.00	\$88.00

Gis azul para tiralíneas

BOTE

- ▶ Gis de alta visibilidad
- ▶ Práctico dosificador para un fácil llenado
- ▶ Se recomienda el uso en el tiralíneas AKSI® o similares



CÓDIGO			DISTRIB.	MAYOREO	LISTA
119415	6	36	\$20.00	\$29.00	\$35.00

Tijera de costura

PROX.

FUNDA PLÁSTICA

- ▶ Hojas de acero inoxidable
- ▶ Mangos ergonómicos
- ▶ Ideal para corte de varias capas de tela
- ▶ Acabado pulido brillante

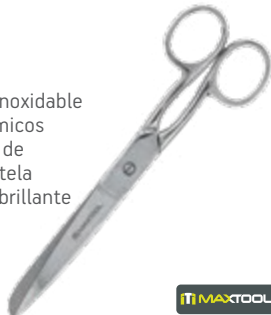

ITI MAXTOOL

CÓDIGO	TAMAÑO			DISTRIB.	MAYOREO	LISTA
310401	4"	12	60	\$35.00	\$50.00	\$62.00
310402	5"	12	60	\$45.00	\$64.00	\$79.00
310403	6"	12	60	\$50.00	\$71.00	\$88.00
310404	7"	12	60	\$65.00	\$93.00	\$115.00
310405	8"	12	60	\$75.00	\$107.00	\$132.00

Tijera de costura, ojo grande

PROX.

FUNDA PLÁSTICA

- ▶ Forjada en acero inoxidable
- ▶ Ligera
- ▶ Ideal para cortes finos
- ▶ Acabado pulido brillante

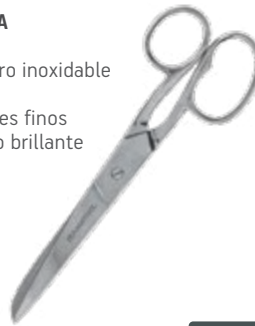

ITI MAXTOOL

CÓDIGO	TAMAÑO			DISTRIB.	MAYOREO	LISTA
310411	6"	12	60	\$65.00	\$93.00	\$115.00
310412	7"	12	60	\$72.00	\$103.00	\$127.00

Tijera para bordar

PROX.

FUNDA PLÁSTICA

- ▶ Forjada en acero inoxidable
- ▶ Ligera
- ▶ Ideal para bordado
- ▶ Acabado pulido brillante

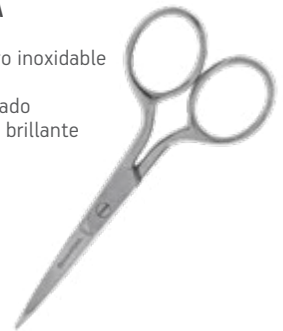

ITI MAXTOOL

CÓDIGO	TAMAÑO			DISTRIB.	MAYOREO	LISTA
310421	4"	12	60	\$38.00	\$54.00	\$67.00

Tijera para sastre

PROX.

FUNDA PLÁSTICA

- ▶ Hojas rectificadas y templadas para mayor duración de filo
- ▶ Mangos ergonómicos
- ▶ Tuerca ajustable
- ▶ Cortes limpios y precisos
- ▶ Acabado pulido brillante

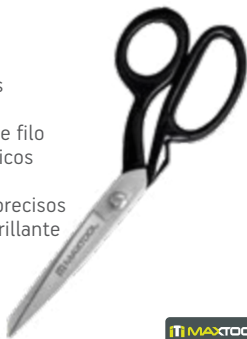

ITI MAXTOOL

CÓDIGO	TAMAÑO			DISTRIB.	MAYOREO	LISTA
310425	8"	12	36	\$130.00	\$185.00	\$230.00
310426	10"	6	36	\$150.00	\$215.00	\$265.00
310427	12"	6	36	\$215.00	\$305.00	\$380.00

Tijera para peluquero, sin gancho

PROX.

FUNDA PLÁSTICA

- ▶ Forjada en acero inoxidable
- ▶ Ligera
- ▶ Ideal para estilistas y barberos



ITI MAXTOOL

CÓDIGO	TAMAÑO	ACABADO			DISTRIB.	MAYOREO	LISTA
310431	5 1/2"	Pulida	12	60	\$48.00	\$69.00	\$85.00
310432	7 1/2"	Pulida	12	60	\$68.00	\$97.00	\$120.00
310433	5"	Satinada	12	60	\$50.00	\$71.00	\$88.00
310434	7"	Satinada	12	60	\$72.00	\$103.00	\$127.00

Tijera para peluquero, con gancho

PROX.

FUNDA PLÁSTICA

- ▶ Forjada en acero inoxidable
- ▶ Con gancho para control y descanso en su uso
- ▶ Cortes de cabello preciso
- ▶ Ligera
- ▶ Ideal para estilistas y barberos

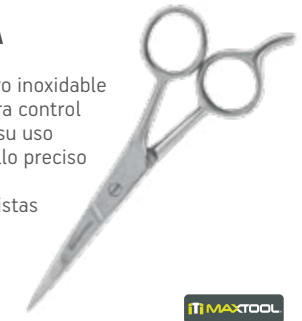

ITI MAXTOOL

CÓDIGO	TAMAÑO	ACABADO			DISTRIB.	MAYOREO	LISTA
310441	5"	Pulida	12	60	\$50.00	\$71.00	\$88.00
310442	7"	Pulida	12	60	\$70.00	\$100.00	\$123.00
310443	5"	Satinada	12	60	\$50.00	\$71.00	\$88.00
310444	7"	Satinada	12	60	\$70.00	\$100.00	\$123.00

Tijera para manicura

PROX.

FUNDA PLÁSTICA

- ▶ Forjada de acero inoxidable
- ▶ Punta fina para cortes precisos
- ▶ Acabado pulido brillante



ITI MAXTOOL

CÓDIGO	TAMAÑO	USO			DISTRIB.	MAYOREO	LISTA
310461	3 1/2"	Cutícula	12	60	\$35.00	\$50.00	\$62.00
310462	3 1/2"	Uñas	12	60	\$35.00	\$50.00	\$62.00

Alicates para manicura o pedicura

PROX.

FUNDA PLÁSTICA

- ▶ Forjado de acero inoxidable
- ▶ Punta curva que se adapta a la forma de la uña
- ▶ El alicate para pedicura cuenta con un resorte de barril para reducir el esfuerzo al cortar uñas gruesas
- ▶ Acabado brillante



ITI MAXTOOL

CÓDIGO	TAMAÑO	USO			DISTRIB.	MAYOREO	LISTA
310471	5 1/2"	Pedicura	12	60	\$138.00	\$195.00	\$245.00
310472	4 3/4"	Manicura	12	60	\$90.00	\$129.00	\$160.00

Tijera de entresacar

PROX.

FUNDA PLÁSTICA

- ▶ Hojas de acero inoxidable
- ▶ Texturiza y reduce el volumen del cabello
- ▶ Acabado satinado

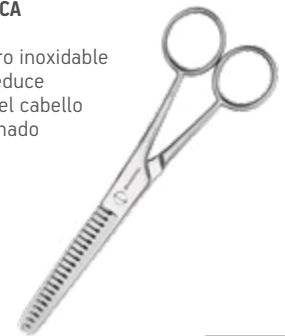

ITI MAXTOOL

CÓDIGO	TAMAÑO			DISTRIB.	MAYOREO	LISTA
310451	7 1/2"	12	60	\$75.00	\$107.00	\$132.00

Tijeras para hojalatero

TARJETA

- ▶ Forjadas en acero al carbono
- ▶ Recubrimiento satinado mucho más resistente a la corrosión
- ▶ Mango acojinado



RECUBRIMIENTO SATINADO



CÓDIGO	TAMAÑO			DISTRIB.	MAYOREO	LISTA
100802	8"	4	24	\$135.00	\$195.00	\$240.00
100803	10"	4	24	\$160.00	\$230.00	\$280.00
100805	12"	4	24	\$200.00	\$285.00	\$355.00

Tijeras para hojalatero 14"

CAJA

- ▶ Forjadas en acero al carbono
- ▶ Recubrimiento satinado mucho más resistente a la corrosión
- ▶ Mango acojinado

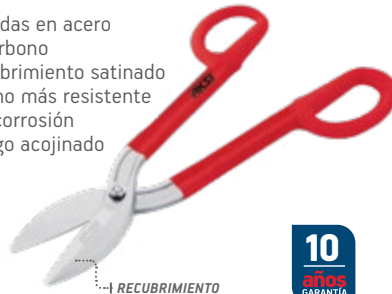

RECUBRIMIENTO SATINADO



CÓDIGO	TAMAÑO			DISTRIB.	MAYOREO	LISTA
100806	14"	1	12	\$240.00	\$345.00	\$425.00

Tijeras para hojalatero

TARJETA

- ▶ Forjadas en acero al alto carbono
- ▶ Mango acojinado



ACERO AL ALTO CARBONO



CÓDIGO	TAMAÑO			DISTRIB.	MAYOREO	LISTA
309801	8"	4	24	\$85.00	\$121.00	\$150.00
309802	10"	4	24	\$110.00	\$155.00	\$195.00
309803	12"	4	24	\$130.00	\$185.00	\$230.00

Tenaza armador 9"

BLÍSTER

- ▶ Filos endurecidos para retocar y cortar alambre



MANGOS DE VINIL



CÓDIGO	TAMAÑO			DISTRIB.	MAYOREO	LISTA
104681	9"	6	36	\$95.00	\$136.00	\$170.00

Tijeras multiusos con resorte

BLÍSTER

- ▶ Hojas de acero inoxidable
- ▶ Mango ergonómico
- ▶ Excelente filo
- ▶ Hoja dentada para prevenir que el objeto se deslice
- ▶ Sistema de resorte, reduce el esfuerzo
- ▶ Corta: cable, lámina, cartón, cuero, plástico



ACERO INOXIDABLE



CÓDIGO	MEDIDA			DISTRIB.	MAYOREO	LISTA
100852	8"	6	36	\$105.00	\$150.00	\$185.00

Tijeras multiusos

FUNDA PLÁSTICA

- ▶ Hojas de acero inoxidable
- ▶ Mango ergonómico
- ▶ Excelente filo
- ▶ Hoja dentada para prevenir que el objeto se deslice
- ▶ Corta: lámina, cable, cartón, cuero, plástico



ACERO INOXIDABLE



CÓDIGO	MEDIDA			DISTRIB.	MAYOREO	LISTA
100851	8 1/2"	6	36	\$52.00	\$74.00	\$92.00

Tijeras de aviación 9 1/2"

NUEVO

BLÍSTER

- ▶ Hojas de aleación de molibdeno
- ▶ Mango ergonómico
- ▶ Corte recto, derecho o izquierdo
- ▶ Corta cualquier tipo de lámina

CAPACIDAD DE CORTE

Cobre	1.2 mm
Acero	1.2 mm
Acero inox.	0.8 mm



RECTO

DERECHO

IZQUIERDO



CÓDIGO	CORTE			DISTRIB.	MAYOREO	LISTA
100811	Recto	3	36	\$140.00	\$200.00	\$245.00
100812	Derecho	3	36	\$140.00	\$200.00	\$245.00
100813	Izquierdo	3	36	\$140.00	\$200.00	\$245.00

Tijera de poda ligera a dos manos, mango de poliamida

TARJETA

- ▶ Mangos fabricados de poliamida
- ▶ Cuchillas fabricadas en acero al carbono SAE 1050
- ▶ Cuchillas protegidas con tecnología antiadherente
- ▶ Perilla para ajuste de tensión
- ▶ Resorte de apertura automática para cortes suaves



CÓDIGO	TAMAÑO			DISTRIB.	MAYOREO	LISTA
101404	6"	6	12	\$325.00	\$465.00	\$575.00

Tijera de poda a dos manos, mango tubular recubierto

GRANEL

- ▶ Mangos con recubrimiento para un mejor agarre
- ▶ Cuchillas fabricadas en acero al carbono
- ▶ Diseño de hojas en punta que permite cortes en esquina y lugares reducidos
- ▶ Tuerca de ajuste de fácil acción
- ▶ Hojas alabeadas que garantizan cortes parejos

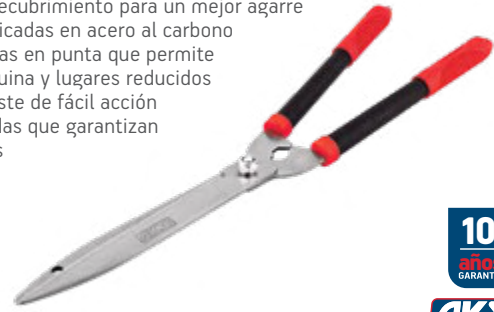

CÓDIGO	TAMAÑO			DISTRIB.	MAYOREO	LISTA
101405	56 cm	6	12	\$150.00	\$215.00	\$265.00

Tijera de poda para ramas, mango de madera

GRANEL

- ▶ Mangos ergonómicos de madera estufada, pulida y laqueada
- ▶ Cuchillas fabricadas en acero al carbono
- ▶ Mango largo para facilitar el corte
- ▶ Tope amortiguador de impactos
- ▶ Hoja con doble filo rectificad



CÓDIGO	TAMAÑO			DISTRIB.	MAYOREO	LISTA
101403	21"	6	12	\$210.00	\$300.00	\$370.00

Tijera de poda a dos manos, mango de madera

GRANEL

- ▶ Mangos ergonómicos de madera estufada, pulida y laqueada
- ▶ Cuchillas fabricadas en acero al carbono
- ▶ Diseño de hojas en punta que permite cortes en esquina y lugares reducidos
- ▶ Tuerca de ajuste de fácil acción
- ▶ Hojas alabeadas que garantizan cortes parejos



CÓDIGO	TAMAÑO			DISTRIB.	MAYOREO	LISTA
101401	10"	6	12	\$115.00	\$165.00	\$205.00
101402	12"	6	12	\$140.00	\$200.00	\$245.00

Tijera para jardinería y floricultura

BLÍSTER

- ▶ Cuchilla fabricada en acero templado mucho más durable
- ▶ Cómodos mangos ergonómicos cubiertos con vinil
- ▶ Con seguro de apertura y cierre



CÓDIGO	TAMAÑO			DISTRIB.	MAYOREO	LISTA
302001	8"	6	48	\$70.00	\$100.00	\$123.00

Removedor de espinas

BLÍSTER

- ▶ Perfecto para quitar espinas y hojas en los tallos de las flores
- ▶ Mango con resorte para ajustar la apertura a medida del tallo



CÓDIGO			DISTRIB.	MAYOREO	LISTA
302011	12	96	\$30.00	\$43.00	\$53.00

Torres para automóvil

NUEVO

GRANEL

- ▶ Juego de 2 torres
- ▶ Capacidad de 3 toneladas
- ▶ Base fabricada de acero al carbono
- ▶ Asiento con diseño antideslizante

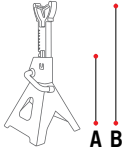

ALTURA	
A: Mínima	28 cm
B: Máxima	41 cm



1 año GARANTÍA

AKSI

CÓDIGO	PAQUETES	DISTRIB.	MAYOREO	LISTA
118871	2 Juegos	\$535.00	\$765.00	\$945.00

Herramientas para jardín 6" juego de 4 piezas

PROX.

CAJA

- ▶ Cabezas de acero al carbono
- ▶ Mangos de madera con orificios para colgar
- ▶ Para jardinería y horticultura

- 1 CULTIVADOR:** Afloja tierra y remueve maleza
- 2 CUCHARA:** Excava, quita planyas y remueve tierra
- 3 TRANSPLANTADOR:** Transplanta flores y plantas pequeñas
- 4 BIELDO:** Deshierba y cultiva la tierra alrededor de las plantas



10 años GARANTÍA

AKSI

CÓDIGO	PAQUETES	DISTRIB.	MAYOREO	LISTA
101411	6	\$130.00	\$185.00	\$230.00

Herramientas para jardín 11" juego de 3 piezas

PROX.

CABALLETE

- ▶ Fabricado en polipropileno con fibra de vidrio
- ▶ Para jardinería y horticultura

- 1 CULTIVADOR:** Afloja tierra y remueve maleza
- 2 CUCHARA:** Excava, quita planyas y remueve tierra
- 3 TRANSPLANTADOR:** Transplanta flores y plantas pequeñas



12 meses GARANTÍA

IT MAXTOOL

CÓDIGO	PAQUETES	DISTRIB.	MAYOREO	LISTA
302021	6	\$47.00	\$67.00	\$83.00

Talacho hacha

GRANEL

- ▶ Forjada en acero 1045 con doble tratamiento térmico
- ▶ Dureza 48 – 57 HRC
- ▶ Área de filo pulida y laqueada
- ▶ Escoplo de 110 mm
- ▶ Ancho de hacha 64 mm



AKSI

CÓDIGO	PESO	PAQUETES	DISTRIB.	MAYOREO	LISTA
111905	5 Lbs	1	\$260.00	\$370.00	\$460.00
111906	5 Lbs	6	\$180.00	\$255.00	\$320.00

Talacho pico

GRANEL

- ▶ Forjada en acero 1045 con doble tratamiento térmico
- ▶ Dureza 48 – 57 HRC
- ▶ Afilado en puntas
- ▶ Escoplo de 110 mm



AKSI

CÓDIGO	PESO	PAQUETES	DISTRIB.	MAYOREO	LISTA
111903	5 Lbs	1	\$260.00	\$370.00	\$460.00
111904	5 Lbs	6	\$180.00	\$255.00	\$320.00

Zapapico

GRANEL

- ▶ Cabeza de 5 lb forjada en acero 1045 con dureza 48 - 57 HRC
- ▶ Mango de madera pulido y laqueado de 36"
- ▶ Escoplo de 40 mm



AKSI

CÓDIGO	DESCRIPCIÓN	PAQUETES	DISTRIB.	MAYOREO	LISTA
111901	Con mango	1	\$250.00	\$355.00	\$440.00
111902	Sin mango	1	\$160.00	\$230.00	\$280.00
109303	Mango	1	\$98.00	\$140.00	\$175.00

Tela mosquitera plástica verde

BOLSA

- ▶ Fabricada con polietileno de alta densidad
- ▶ Alta resistencia en exteriores
- ▶ Efectiva contra el paso de insectos en terrazas, ventanas, cancelas, etc.
- ▶ 100% lavable
- ▶ Protección de cultivos en invernaderos, cultivos de flores, frutales, etc.



CÓDIGO	TAMAÑO	DISTRIB.	MAYOREO	LISTA
124501	0.60 x 30 m	\$215.00	\$305.00	\$380.00
124502	0.75 x 30 m	\$275.00	\$395.00	\$485.00
124503	0.90 x 30 m	\$325.00	\$465.00	\$575.00
124504	1.05 x 30 m	\$365.00	\$520.00	\$645.00
124505	1.20 x 30 m	\$425.00	\$605.00	\$750.00
124506	1.50 x 30 m	\$520.00	\$745.00	\$915.00
124507	1.70 x 30 m	\$590.00	\$845.00	\$1,040.00

Tela mosquitera plástica gris

BOLSA

- ▶ Fabricada con polietileno de alta densidad
- ▶ Alta resistencia en exteriores
- ▶ Efectiva contra el paso de insectos en terrazas, ventanas, cancelas, etc.
- ▶ 100% lavable
- ▶ Protección de cultivos en invernaderos, cultivos de flores, frutales, etc.



CÓDIGO	TAMAÑO	DISTRIB.	MAYOREO	LISTA
124511	0.60 x 30 m	\$215.00	\$305.00	\$380.00
124512	0.75 x 30 m	\$275.00	\$395.00	\$485.00
124513	0.90 x 30 m	\$325.00	\$465.00	\$575.00
124514	1.05 x 30 m	\$365.00	\$520.00	\$645.00
124515	1.20 x 30 m	\$425.00	\$605.00	\$750.00
124516	1.50 x 30 m	\$520.00	\$745.00	\$915.00
124517	1.70 x 30 m	\$590.00	\$845.00	\$1,040.00

Toldo para sombra

BOLSA

- ▶ Malla para sombra color negro de uso casero
- ▶ Fácil de instalar, con ojillos cada 50 cm
- ▶ Vaporiza las gotas de lluvia
- ▶ Con cinta de refuerzo
- ▶ Filtro UV
- ▶ Ideal para utilizarse en: toldo, cortina, terrazas, rompevientos, invernaderos, cubre domos, protección de sol para coches o mascotas
- ▶ 5 años de garantía contra degradación solar



CÓDIGO	TAMAÑO			DISTRIB.	MAYOREO	LISTA
124551	3 x 3,6 m	1	1	\$600.00	\$855.00	\$1,060.00
124552	5 x 3,6 m	1	1	\$850.00	\$1,215.00	\$1,500.00

Válvula de esfera roscable y soldable

GRANEL

- ▶ Para agua, aceite y gas
- ▶ Cuerpo fabricado en latón sólido
- ▶ Presión máxima 200 PSI



CÓDIGO	TIPO	DIÁMETRO			DISTRIB.	MAYOREO	LISTA
113201	Roscable	1/2"	6	48	\$50.00	\$71.00	\$88.00
113202	Roscable	3/4"	6	48	\$75.00	\$107.00	\$132.00
113203	Soldable	1/2"	6	48	\$48.00	\$69.00	\$85.00
113204	Soldable	3/4"	6	48	\$70.00	\$100.00	\$123.00

Válvula ahorradora

BLÍSTER

BENEFICIOS:

- ▶ Ahorro de hasta un 50% ó más, en la facturación de agua
- ▶ Vida útil de más de 20 años
- ▶ No requiere mantenimiento
- ▶ Fácil instalación

Funcional en todo tipo de tubería



CÓDIGO	DIÁMETRO		DISTRIB.	MAYOREO	LISTA
128391	1/2"	125	\$950.00	\$1,355.00	\$1,675.00
128392	3/4"	125	\$2,450.00	\$3,500.00	\$4,320.00

Válvula de compuerta roscable y soldable

GRANEL

- ▶ Para agua, aceite y gas
- ▶ Cuerpo fabricado en latón sólido
- ▶ Presión máxima 150 PSI



CÓDIGO	TIPO	DIÁMETRO			DISTRIB.	MAYOREO	LISTA
113205	Roscable	1/2"	6	48	\$70.00	\$100.00	\$123.00
113206	Roscable	3/4"	6	48	\$90.00	\$129.00	\$160.00
113207	Soldable	1/2"	6	48	\$70.00	\$100.00	\$123.00
113208	Soldable	3/4"	6	48	\$90.00	\$129.00	\$160.00

Válvula roscable para gas

GRANEL

- ▶ Cuerpo fabricado en latón sólido
- ▶ Presión máxima 200 PSI



CÓDIGO	MEDIDA H/PT	M/FLARE	TIPO			DISTRIB.	MAYOREO	LISTA
109701	1/2"	X 3/8"	Roscable	10	100	\$45.00	\$64.00	\$79.00
109702	1/2"	X 5/16"	Roscable	10	100	\$45.00	\$64.00	\$79.00

Ventilador de techo 56"

CAJA

- ▶ 5 Velocidades
- ▶ Cuerpo de acero, esmaltado en color blanco
- ▶ Control periférico empotrable en pared
- ▶ Aspas reforzadas
- ▶ Incluye gancho para montaje en techo



NOM

VELOCIDADES	
Velocidad 1	280 rpm
Velocidad 2	260 rpm
Velocidad 3	220 rpm
Velocidad 4	185 rpm
Velocidad 5	160 rpm

CARACTERÍSTICAS	
Tensión / frecuencia:	127 V~ / 60 Hz
Potencia:	85 W



HOME

CÓDIGO	MEDIDA	DISTRIB.	MAYOREO	LISTA
127304	56"	\$600.00	\$855.00	\$1,060.00

Ventilador de piso 15"

CAJA

- ▶ 3 Velocidades
- ▶ Motor termoprotegido y reforzado
- ▶ Inclínable



INCLINABLE



NOM

CARACTERÍSTICAS	
Tensión / frecuencia:	127 V~ / 60 Hz
Potencia:	55 W



HOME

CÓDIGO	MEDIDA	DISTRIB.	MAYOREO	LISTA
127303	15"	\$550.00	\$785.00	\$970.00

Ventilador de pedestal 24"

NUEVO

Industrial

CAJA

- ▶ 3 Velocidades
- ▶ Motor termoprotegido y reforzado
- ▶ Con movimiento oscilatorio
- ▶ Inclínable

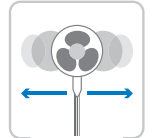

OSCILATORIO

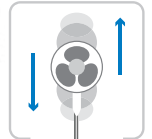

INCLINABLE

NOM

CARACTERÍSTICAS	
Tensión / frecuencia:	127 V~ / 60 Hz
Potencia:	130 W



AKSI

CÓDIGO	MEDIDA	DISTRIB.	MAYOREO	LISTA
127314	24"	\$3,550.00	\$5,070.00	\$6,260.00

Ventilador de pared 20"

NUEVO

Industrial

CAJA

- ▶ 2 Velocidades
- ▶ Motor termoprotegido y reforzado
- ▶ Con movimiento oscilatorio
- ▶ Inclínable

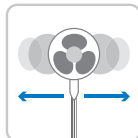

OSCILATORIO

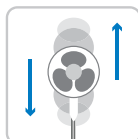

INCLINABLE



NOM

CARACTERÍSTICAS	
Tensión / frecuencia:	127 V~ / 60 Hz
Potencia:	130 W



AKSI

CÓDIGO	MEDIDA	DISTRIB.	MAYOREO	LISTA
127313	20"	\$2,000.00	\$2,855.00	\$3,530.00

Ventilador de pedestal 16"

CAJA

- ▶ 3 Velocidades
- ▶ Motor termoprotegido y reforzado
- ▶ Con movimiento oscilatorio
- ▶ Inclínable

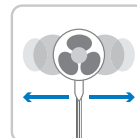

OSCILATORIO

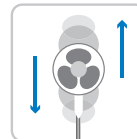

INCLINABLE



NOM

CARACTERÍSTICAS	
Tensión / frecuencia:	127 V~ / 60 Hz
Potencia:	50 W



HOME

CÓDIGO	MEDIDA	DISTRIB.	MAYOREO	LISTA
127301	16"	\$650.00	\$930.00	\$1,145.00

Ventilador 3 en 1 18" piso, pedestal y pared

CAJA

- ▶ 3 Velocidades
- ▶ Ventilador de 18"
- ▶ Modelo versátil con 3 posiciones de uso

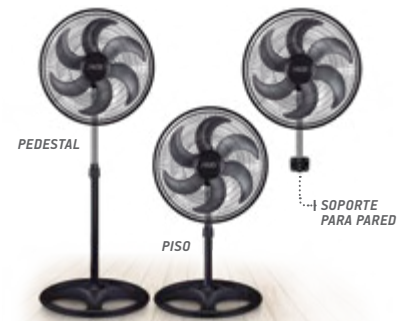

NOM

CARACTERÍSTICAS	
Tensión / frecuencia:	127 V~ / 60 Hz
Potencia:	75 W



HOME

CÓDIGO	MEDIDA	DISTRIB.	MAYOREO	LISTA
127302	18"	\$890.00	\$1,270.00	\$1,570.00

Sr. Limpio®

AL CUIDADO DE TUS ESPACIOS



▶ Sanitizantes . fibras . cepillos . escobas . guantes . cubetas . jaladores . bombas . toallas... y más.

Bote con tapa balancin, 19 l

PROX.

GRANEL (ETIQUETA)

- ▶ Plástico rígido virgen
- ▶ Varios colores



Sr. Limpio

CÓDIGO	COLOR		DISTRIB.	MAYOREO	LISTA
800901	Rosa	6	\$150.00	\$215.00	\$265.00
800902	Rojo	6	\$150.00	\$215.00	\$265.00
800903	Azul	6	\$150.00	\$215.00	\$265.00
800904	Turquesa	6	\$150.00	\$215.00	\$265.00
800905	Verde	6	\$150.00	\$215.00	\$265.00

Bote con tapa balancin

PROX.

GRANEL (ETIQUETA)

- ▶ Plástico rígido reciclado
- ▶ Chico - 11 litros
- ▶ Mediano - 19 litros



Sr. Limpio

CÓDIGO	TAMAÑO		DISTRIB.	MAYOREO	LISTA
800906	19 l	6	\$125.00	\$180.00	\$220.00
800911	11 l	10	\$80.00	\$114.00	\$141.00

Bote con pedal, 8 l

PROX.

GRANEL (ETIQUETA)

- ▶ Plástico rígido virgen
- ▶ Varios colores



Sr. Limpio

CÓDIGO	COLOR		DISTRIB.	MAYOREO	LISTA
800921	Rosa	8	\$120.00	\$170.00	\$210.00
800922	Rojo	8	\$120.00	\$170.00	\$210.00
800923	Azul	8	\$120.00	\$170.00	\$210.00
800924	Turquesa	8	\$120.00	\$170.00	\$210.00
800925	Verde	8	\$120.00	\$170.00	\$210.00

Guantes de látex

BOLSA

- ▶ Orilla con refuerzo ribeteado para mayor resistencia al uso
- ▶ Textura antiderrapante para mejorar la sujeción



CÓDIGO	TAMAÑO	COLOR			DISTRIB.	MAYOREO	LISTA
800601	CH	Rojo	12	144	\$19.00	\$27.00	\$34.00
800602	M	Rojo	12	144	\$19.00	\$27.00	\$34.00
800603	G	Rojo	12	144	\$19.00	\$27.00	\$34.00
800604	CH	Verde	12	144	\$19.00	\$27.00	\$34.00
800605	M	Verde	12	144	\$19.00	\$27.00	\$34.00
800606	G	Verde	12	144	\$19.00	\$27.00	\$34.00
800607	CH	Azul	12	144	\$19.00	\$27.00	\$34.00
800608	M	Azul	12	144	\$19.00	\$27.00	\$34.00
800609	G	Azul	12	144	\$19.00	\$27.00	\$34.00
800611	CH	Amarillo	12	144	\$19.00	\$27.00	\$34.00
800612	M	Amarillo	12	144	\$19.00	\$27.00	\$34.00
800613	G	Amarillo	12	144	\$19.00	\$27.00	\$34.00

Recogedor plástico con mango

GRANEL (ETIQUETA)

- ▶ Recogedor de plástico con mango de 70 cm
- ▶ Paredes altas para mejor contención de desechos



CÓDIGO		DISTRIB.	MAYOREO	LISTA
800501	18	\$28.00	\$40.00	\$49.00

Cubeta plástica de 10 litros

GRANEL (ETIQUETA)

- ▶ Plástico rígido
- ▶ Varios colores



CÓDIGO	PRESENTACIÓN		DISTRIB.	MAYOREO	LISTA
800504	Roja -10 litros	1	\$30.00	\$43.00	\$53.00
800505	Verde -10 litros	1	\$30.00	\$43.00	\$53.00
800506	Azul -10 litros	1	\$30.00	\$43.00	\$53.00

Cubeta con exprimidor

GRANEL (ETIQUETA)

- ▶ Plástico rígido con asa metálica
- ▶ Varios colores



CÓDIGO	PRESENTACIÓN			DISTRIB.	MAYOREO	LISTA
800510	14 litros	1	12	\$95.00	\$136.00	\$170.00

Recogedor grande con mango metálico

GRANEL (ETIQUETA)

- ▶ Recogedor de plástico con mango metálico
- ▶ Paredes altas para mejor contención de desechos



CÓDIGO		DISTRIB.	MAYOREO	LISTA
800512	24	\$50.00	\$71.00	\$88.00

Escoba económica

GRANEL (ETIQUETA)

- ▶ Fibras flexibles, más resistencia
- ▶ Útil para cualquier tipo de limpieza
- ▶ Mango intercambiable
- ▶ Varios colores



Sr. Limpio

CÓDIGO	MANGO	HECHO EN MÉXICO	DISTRIB.	MAYOREO	LISTA
800101	Madera	N/A	\$40.00	\$57.00	\$71.00
800102	Sin mango	24	\$25.00	\$36.00	\$44.00

Escoba de pelo largo

GRANEL (ETIQUETA)

- ▶ Fibras flexibles, más resistencia
- ▶ Útil para cualquier tipo de limpieza
- ▶ Mango intercambiable



Sr. Limpio

CÓDIGO	MANGO	HECHO EN MÉXICO	DISTRIB.	MAYOREO	LISTA
800103	Madera	N/A	\$50.00	\$71.00	\$88.00
800104	Sin mango	24	\$35.00	\$50.00	\$62.00

Jalador plástico mango madera

GRANEL (ETIQUETA)

- ▶ Mango de madera intercambiable
- ▶ Varios colores



Sr. Limpio

CÓDIGO	MANGO	HECHO EN MÉXICO	DISTRIB.	MAYOREO	LISTA
800401	Madera	N/A	\$40.00	\$57.00	\$71.00
800402	Sin mango	60	\$20.00	\$29.00	\$35.00

Jalador metálico mango metálico o madera

GRANEL (ETIQUETA)

- ▶ Jalador de 40 cm de ancho
- ▶ Mango intercambiable



Sr. Limpio

CÓDIGO	MANGO	HECHO EN MÉXICO	DISTRIB.	MAYOREO	LISTA
800403	Metálico	N/A	\$65.00	\$93.00	\$115.00
800404	Madera	N/A	\$55.00	\$79.00	\$97.00
800405	Sin mango	24	\$35.00	\$50.00	\$62.00

Uso múltiple

Mango metálico

GRANEL (ETIQUETA)

- ▶ Perfecto para utilizar con los productos Señor Limpio®



Sr. Limpio

CÓDIGO	HECHO EN MÉXICO	DISTRIB.	MAYOREO	LISTA
800511	100	\$32.00	\$46.00	\$56.00

Mango de madera

GRANEL

- ▶ Mango de madera perfilada



CÓDIGO	LARGO	DISTRIB.	MAYOREO	LISTA
109308	1,2 m	\$22.00	\$31.00	\$39.00

Mango de madera, sin cuerda

GRANEL

- ▶ Mango de madera perfilada



CÓDIGO	DISTRIB.	MAYOREO	LISTA
109301	\$25.00	\$36.00	\$44.00

Mop de microfibra

GRANEL (BOLSA)

- ▶ Proporciona gran absorción
- ▶ Ideal para la industria, hogar o comercio



CÓDIGO	MANGO		DISTRIB.	MAYOREO	LISTA
800111	Metálico	N/A	\$90.00	\$129.00	\$160.00
800112	Madera	N/A	\$80.00	\$114.00	\$141.00
800113	Sin mango	24	\$60.00	\$86.00	\$106.00

Mechudo de 320 g

GRANEL (ETIQUETA)

- ▶ Proporciona gran absorción
- ▶ Ideal para la industria, hogar o comercio



CÓDIGO	MANGO		DISTRIB.	MAYOREO	LISTA
800201	Madera	12	\$50.00	\$71.00	\$88.00

Fibra esponja doble acción

BOLSA

- ▶ Para uso general
- ▶ Pack de 2 piezas
- ▶ 7 x 10 cm



CÓDIGO	PRESENTACIÓN		DISTRIB.	MAYOREO	LISTA
800703	2 piezas	50	\$14.00	\$20.00	\$24.70

Mop magitel de 150 g

GRANEL (BOLSA)

- ▶ Ideal para la industria, hogar o comercio



CÓDIGO	MANGO		DISTRIB.	MAYOREO	LISTA
800114	Metálico	N/A	\$60.00	\$86.00	\$106.00
800115	Madera	N/A	\$50.00	\$71.00	\$88.00
800116	Sin mango	24	\$27.00	\$39.00	\$48.00

Cepillo para WC con base

GRANEL (ETIQUETA)

- ▶ Cepillo para inodoro con mango sólido
- ▶ Fibras de polipropileno
- ▶ Base plana para mayor soporte al cepillo



CÓDIGO		DISTRIB.	MAYOREO	LISTA
800508	24	\$30.00	\$43.00	\$53.00

Fibra clásica 2 pack

BOLSA

- ▶ Para uso general
- ▶ Remueve la grasa pegada sin rayar
- ▶ Pack de 2 piezas
- ▶ 9 x 15 cm



CÓDIGO	PRESENTACIÓN		DISTRIB.	MAYOREO	LISTA
800702	2 piezas	50	\$8.00	\$11.40	\$14.10

Bomba destapacaños de hule

GRANEL (ETIQUETA)

- ▶ Bomba de PVC con mango de madera
- ▶ No permite la fuga de aire lo que proporciona mejor succión



CÓDIGO		DISTRIB.	MAYOREO	LISTA
800502	24	\$30.00	\$43.00	\$53.00

Bomba para destapar lavabo

GRANEL (ETIQUETA)

- ▶ Mini bomba para destapar lavabo o fregadero



CÓDIGO		DISTRIB.	MAYOREO	LISTA
800509	24	\$19.00	\$27.00	\$34.00

Fibra esponja doble acción

BOLSA

- ▶ Para uso general
- ▶ Doble fibra que ayuda a limpiar superficies delicadas o resistentes
- ▶ 8 x 12 cm



CÓDIGO	PRESENTACIÓN		DISTRIB.	MAYOREO	LISTA
800704	1 pieza	50	\$9.00	\$12.90	\$15.90

Tela lavatrastes

FAJILLA

- ▶ Para uso general
- ▶ 18 x 22 cm
- ▶ Ideal en cristalería y sartenes



CÓDIGO	PRESENTACIÓN	HECHO EN MÉXICO	DISTRIB.	MAYOREO	LISTA
800701	1 pieza	50	\$10.00	\$14.30	\$17.60

Fibra esponja multiusos

FAJILLA

- ▶ Para uso general
- ▶ Ideal para lavado de utensilios de teflón®
- ▶ 8 x 12 cm



CÓDIGO	PRESENTACIÓN	HECHO EN MÉXICO	DISTRIB.	MAYOREO	LISTA
800705	1 pieza	50	\$9.00	\$12.90	\$15.90

Toalla de microfibra

BOLSA

- ▶ Máxima absorción
- ▶ Súper compacta
- ▶ Fácil de lavar
- ▶ Se seca en muy poco tiempo



CÓDIGO	TAMAÑO	HECHO EN MÉXICO	DISTRIB.	MAYOREO	LISTA
125301	30 x 30 cm	48	\$10.00	\$14.30	\$17.60

Toalla de microfibra

FAJILLA

- ▶ Máxima absorción
- ▶ Compacta
- ▶ Fácil de lavar
- ▶ Se seca en muy poco tiempo

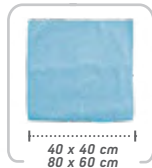

CÓDIGO	TAMAÑO	HECHO EN MÉXICO	DISTRIB.	MAYOREO	LISTA
125302	40 x 40 cm	96	\$13.00	\$18.60	\$22.90
125303	80 x 60 cm	30	\$30.00	\$43.00	\$53.00

Toalla de microfibra 3 pack

FAJILLA

- ▶ Máxima absorción
- ▶ Compacta
- ▶ Fácil de lavar
- ▶ Se seca en muy poco tiempo

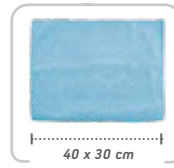

CÓDIGO	TAMAÑO	HECHO EN MÉXICO	DISTRIB.	MAYOREO	LISTA
125304	40 x 30 cm	100	\$30.00	\$43.00	\$53.00

Fibra galvanizada

BOLSA

- ▶ Ideal para superficies resistentes
- ▶ Gran desempeño al limpiar parrillas y asadores



CÓDIGO	PRESENTACIÓN	HECHO EN MÉXICO	DISTRIB.	MAYOREO	LISTA
800801	1 pieza de 35 g	50	\$11.00	\$15.70	\$19.40
108902	1 pieza de 60 g	50	\$20.00	\$29.00	\$35.00

Sanitizante

BOTELLA

- ▶ Elimina bacterias, virus, hongos y algas
- ▶ Sanitiza superficies, equipo médico, herramientas, etc.



CÓDIGO	PRESENTACIÓN	HECHO EN MÉXICO	DISTRIB.	MAYOREO	LISTA
801001	125 ml	24	\$30.00	\$43.00	\$53.00
801003	1 L	12	\$115.00	\$165.00	\$205.00

Desengrasante multiusos

BOTELLA

- ▶ Limpiador y desengrasante multiusos
- ▶ Fórmula a base de agua
- ▶ Quita la grasa y suciedad pegada
- ▶ Disuelve y elimina la grasa sin esfuerzo
- ▶ Excelente para combatir el cochambre



CÓDIGO	PRESENTACIÓN	HECHO EN MÉXICO	DISTRIB.	MAYOREO	LISTA
127452	1 L	10	\$75.00	\$107.00	\$132.00
127453	4 L	10	\$220.00	\$315.00	\$390.00

Fibra metálica mini

BLISTER

- ▶ Ideal para superficies resistentes
- ▶ Gran desempeño al limpiar espacios reducidos
- ▶ Pack de 12 piezas de 20 g c/u



CÓDIGO	PRESENTACIÓN	HECHO EN MÉXICO	DISTRIB.	MAYOREO	LISTA
800802	12 piezas	12	\$100.00	\$143.00	\$175.00

Jalador con esponja

GRANEL

- ▶ Práctico limpiador para vidrios de casa y automóvil
- ▶ Con paleta aplicador y limpiador de goma



Si Limpio.

CÓDIGO		DISTRIB.	MAYOREO	LISTA
800301	24	\$40.00	\$57.00	\$71.00

Escoba cepillo lavacoches

GRANEL (ETIQUETA)

- ▶ Ideal para la limpieza de interiores, tapetes y neumáticos



HECHO EN MÉXICO

CARRÖK AKSI

CÓDIGO		DISTRIB.	MAYOREO	LISTA
800191	10	\$90.00	\$129.00	\$160.00

NUEVA LINEA

Conoce la nueva colección AKSI® Clean

Jabón desengrasante y exfoliante para manos

PROX.

BOTELLA

- ▶ Ideal para tenerlo en tu taller
- ▶ Limpia las manos profundamente



CÓDIGO	PRESENTACIÓN		DISTRIB.	MAYOREO	LISTA
127461	1 L	10	\$120.00	\$170.00	\$210.00
127462	500 ml	10	\$75.00	\$107.00	\$132.00

Crema desengrasante y exfoliante para manos

PROX.

BOTELLA

- ▶ Ideal como complemento del jabón desengrasante AKSI® Clean



CÓDIGO	PRESENTACIÓN		DISTRIB.	MAYOREO	LISTA
127463	1 L	10	\$135.00	\$195.00	\$240.00
127464	500 ml	10	\$79.00	\$113.00	\$139.00

Desengrasante para asadores

PROX.

BOTELLA

- ▶ Limpieza profunda para asadores y parrillas
- ▶ Fórmula a base de agua
- ▶ Remueve la grasa al contacto
- ▶ No tóxico



CÓDIGO	PRESENTACIÓN		DISTRIB.	MAYOREO	LISTA
127455	1 L	10	\$89.00	\$127.00	\$155.00

Impermeabilizante de telas

PROX.

BOTELLA

- ▶ Ayuda a repeler líquidos de los textiles
- ▶ No modifica el aspecto, la sensación al tacto ni la respiración de las telas
- ▶ Ideal para proteger tapizados de muebles, cojines, cortinas, ropa, mochilas, interiores de automóvil, zapatos de lona, etc.



CÓDIGO	PRESENTACIÓN		DISTRIB.	MAYOREO	LISTA
127466	500 ml	10	\$280.00	\$400.00	\$495.00



CROME
AKSI

CARRÖK
AKSI

MAXTOOL

Sr. Limpio

**LA SOLUCIÓN
PARA TU EXHIBICIÓN**

Mini tótem foco ahorrador o LED

Incluye:

- ▶ 18 Focos ahorradores o LED en distintas presentaciones
- ▶ Conexión eléctrica
- ▶ 3 Repisas

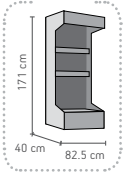

Incluye los productos exhibidos

CÓDIGO	MINI TÓTEM	DISTRIB.	MAYOREO	LISTA
220440	LED	\$13,325.00	\$19,035.00	\$23,505.00
220441	Ahorrador	\$13,325.00	\$19,035.00	\$23,505.00

Exhibidor vintage dimeable

Incluye:

- ▶ Conexión eléctrica
- ▶ Botón de encendido
- ▶ Para focos dimeables

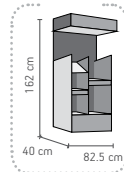

El precio no incluye los productos exhibidos

CÓDIGO	DISTRIB.	MAYOREO	LISTA
220371	\$15,025.00	\$21,465.00	\$26,505.00

Góndola con caja de luz

Incluye:

- ▶ 20 Ganchos con portaprecios ajustables
- ▶ 1 Charola móvil
- ▶ 1 Base fija

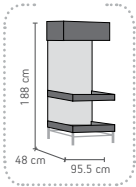

El precio no incluye los productos exhibidos

CÓDIGO	DISTRIB.	MAYOREO	LISTA
220444	\$19,800.00	\$28,285.00	\$34,925.00

Exhibidor genérico de panel multiperforado

Incluye:

- ▶ 1 Charola fija
- ▶ 1 Charola ajustable
- ▶ 25 Ganchos para exhibición

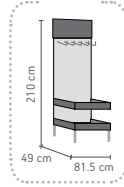

El precio no incluye los productos exhibidos

CÓDIGO	DISTRIB.	MAYOREO	LISTA
220372	\$8,100.00	\$11,570.00	\$14,290.00

Exhibidor de viga vintage dimeable

Incluye:

- ▶ 6 Sockets vintage dimeables
- ▶ Conexión eléctrica
- ▶ Para focos dimeables

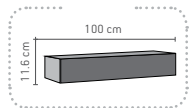

CÓDIGO	DISTRIB.	MAYOREO	LISTA
220446	\$4,620.00	\$6,600.00	\$8,150.00

Exhibidor de viga blanco

NUEVO

Incluye:

- ▶ 6 Sockets
- ▶ Conexión eléctrica
- ▶ Para focos regulares (no dimeable)

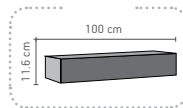

CÓDIGO	DISTRIB.	MAYOREO	LISTA
220463	\$5,000.00	\$7,145.00	\$8,820.00

Exhibidor artefactos eléctricos

Incluye:

- ▶ 7 Ganchos ajustables por barra
- ▶ 8 barras
- ▶ Charola fija inferior

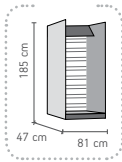

El precio no incluye los productos exhibidos



CÓDIGO	DISTRIB.	MAYOREO	LISTA
220438	\$4,950.00	\$7,070.00	\$8,730.00

Probador de focos

- ▶ Capacidad para probar 4 focos
- ▶ Incluye un socket sin cuerda para probar focos nuevos
- ▶ Ideal para negocios pequeños y cualquier tipo de ferretería
- ▶ Probador de focos de pared, fácil de instalar
- ▶ Incluye: 3 metros de cable y cinta adhesiva al reverso

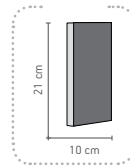

CÓDIGO		DISTRIB.	MAYOREO	LISTA
220364	2	\$960.00	\$1,370.00	\$1,695.00

Exhibidor placas, contactos y apagadores, línea Altimus

- ▶ Práctico exhibidor con producto incluido
- ▶ Fabricado en madera y forrado en laminado plástico

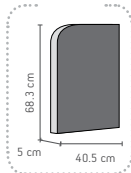

Incluye el producto exhibido



CÓDIGO	DISEÑO	DISTRIB.	MAYOREO	LISTA
220449	Cuadrada	\$1,100.00	\$1,570.00	\$1,940.00

Exhibidor placas, contactos y apagadores, línea Classic / Bassic

- ▶ Práctico exhibidor con producto incluido
- ▶ Fabricado en madera y forrado en laminado plástico

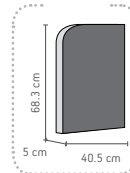

Incluye el producto exhibido



CÓDIGO	DISEÑO	DISTRIB.	MAYOREO	LISTA
220430	Cuadrada	\$1,250.00	\$1,785.00	\$2,205.00

Exhibidor de conexiones PPR

- ▶ Práctico exhibidor con producto incluido
- ▶ Información de las diferentes conexiones
- ▶ Fabricado en madera y forrado en laminado plástico

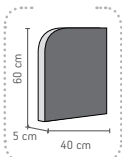

Incluye los productos exhibidos



CÓDIGO	DISTRIB.	MAYOREO	LISTA
220445	\$1,415.00	\$2,020.00	\$2,495.00

Exhibidor de conexiones CPVC

- ▶ Práctico exhibidor con producto incluido
- ▶ Información de las diferentes conexiones
- ▶ Fabricado en madera y forrado en laminado plástico

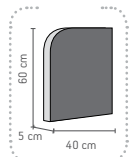

Incluye los productos exhibidos



CÓDIGO	DISTRIB.	MAYOREO	LISTA
220464	\$1,415.00	\$2,020.00	\$2,495.00

Glorificador - foco LED

- ▶ Cuenta con 12 espacios para exhibición de focos LED
- ▶ Práctico exhibidor y probador para mostrador
- ▶ Incluye cabecera

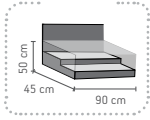

El precio no incluye los productos exhibidos



CÓDIGO	DISTRIB.	MAYOREO	LISTA
220417	\$12,500.00	\$17,855.00	\$22,050.00

Panel exhibidor

- ▶ Práctico módulo que permite realizar una exhibición con diferentes productos
- ▶ Incluye cabecera
- ▶ El material puede ser exhibido con ganchos o cinchos

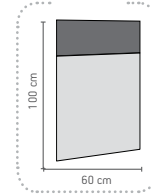

CÓDIGO	DISTRIB.	MAYOREO	LISTA
220381	\$1,300.00	\$1,855.00	\$2,295.00

Muestrario de abrazaderas

- ▶ Útil muestrario con diferentes medidas de abrazaderas
- ▶ Información de medidas
- ▶ Incluye caimán para colgarse en pared

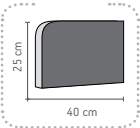

El precio no incluye los productos exhibidos



CÓDIGO	DISTRIB.	MAYOREO	LISTA
220427	\$395.00	\$565.00	\$695.00

Exhibidor de serruchos

- ▶ Práctico exhibidor para panel ranurado
- ▶ Permite organizar y exhibir 6 serruchos
- ▶ Copete desmontable
- ▶ Fabricado en alambroón

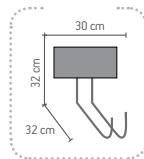

El precio no incluye los productos exhibidos



CÓDIGO	DISTRIB.	MAYOREO	LISTA
220423	\$285.00	\$405.00	\$505.00

Exhibidor de mazos y martillos

- ▶ Práctico exhibidor para panel ranurado
- ▶ Permite organizar y exhibir 5 martillos o mazos
- ▶ Copete desmontable
- ▶ Fabricado en alambroón

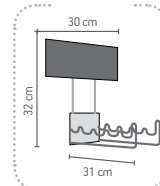

El precio no incluye los productos exhibidos



CÓDIGO	DISTRIB.	MAYOREO	LISTA
220422	\$310.00	\$445.00	\$545.00

Exhibidor para brocas de alta velocidad

- ▶ Fabricado en madera MDF
- ▶ No incluye brocas



El precio no incluye los productos exhibidos

CÓDIGO	COLOR	DISTRIB.	MAYOREO	LISTA
220428	Negras	\$565.00	\$805.00	\$995.00

Despachador para brocas de alta velocidad

NUEVO

- ▶ No incluye brocas



CÓDIGO	DISTRIB.	MAYOREO	LISTA
220429	\$1,900.00	\$2,715.00	\$3,350.00

Exhibidor de palas y zapapicos

- ▶ Práctico exhibidor para panel ranurado
- ▶ Permite organizar y exhibir 3 palas o picos
- ▶ Copete desmontable
- ▶ Fabricado en alambroón

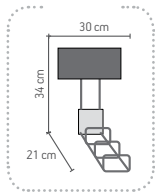

El precio no incluye los productos exhibidos



AKSI

CÓDIGO	DISTRIB.	MAYOREO	LISTA
220424	\$310.00	\$445.00	\$545.00

Exhibidor de cucharas

- ▶ Práctico exhibidor que permite organizar y exhibir 6 cucharas de albañil
- ▶ Incluye material gráfico impreso en estireno

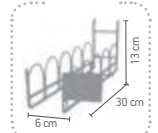

El precio no incluye los productos exhibidos

MAXTOOL

CÓDIGO	DISTRIB.	MAYOREO	LISTA
220413	\$350.00	\$500.00	\$615.00

Exhibidor para escaleras

- ▶ Práctico exhibidor de piso para escaleras
- ▶ Ideal para negocios pequeños
- ▶ Capacidad para 5 escaleras
- ▶ Despacha fácil y rápido
- ▶ Incluye tornillería

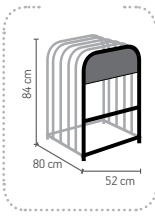

El precio no incluye los productos exhibidos



AKSI

CÓDIGO	DISTRIB.	MAYOREO	LISTA
220403	\$4,600.00	\$6,570.00	\$8,115.00

Exhibidor para botes de cadena

- ▶ Exhibidor de piso para botes de cadena
- ▶ Permite exhibir y despachar
- ▶ Capacidad para 5 y 6 botes

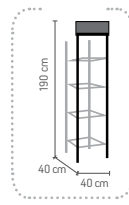

El precio no incluye los productos exhibidos



AKSI

CÓDIGO	BOTES	DISTRIB.	MAYOREO	LISTA
220409	5	\$4,650.00	\$6,645.00	\$8,200.00

Exhibidor para lazo

- ▶ Práctico exhibidor de piso para rollos de lazo
- ▶ Ideal para negocios pequeños y cualquier tipo de ferretería
- ▶ Despacha fácil y rápido los productos exhibidos
- ▶ Incluye material gráfico impreso

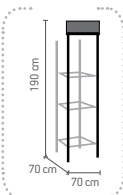

El precio no incluye los productos exhibidos



AKSI

CÓDIGO	ROLLOS	DISTRIB.	MAYOREO	LISTA
220408	3	\$7,000.00	\$10,000.00	\$12,345.00

Exhibidor para manguera

NUEVO

- ▶ Práctico exhibidor de piso
- ▶ Ideal para negocios pequeños y cualquier tipo de ferretería
- ▶ Incluye material gráfico impreso

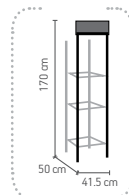

El precio no incluye los productos exhibidos



AKSI

CÓDIGO	DISTRIB.	MAYOREO	LISTA
220462	\$6,100.00	\$8,715.00	\$10,760.00

Exhibidor de mostrador para 4 y 8 aromatizantes



El precio no incluye los productos exhibidos

CÓDIGO	AROMATIZANTES	DISTRIB.	MAYOREO	LISTA
220331	4	\$113.00	\$160.00	\$200.00
220332	8	\$240.00	\$345.00	\$425.00



Tableros para exhibición

PROX. ○

- ▶ Exhibidor de cartón para colgar en pared
- ▶ Ahorra espacio en tus exhibiciones



Productos exhibidos incluidos

CÓDIGO	AROMATIZANTES	DISTRIB.	MAYOREO	LISTA
133901	36 piezas	\$612.00	\$875.00	\$1,080.00
133902	24 piezas	\$1,560.00	\$2,230.00	\$2,750.00
133903	18 piezas	\$864.00	\$1,235.00	\$1,525.00
133904	36 piezas	\$576.00	\$825.00	\$1,015.00
133905	18 piezas	\$828.00	\$1,185.00	\$1,460.00
133906	18 piezas	\$756.00	\$1,080.00	\$1,335.00



Exhibidor de piso para 42 aromatizantes

PROX. ○

- ▶ Exhibidor metálico
- ▶ 5 Repisas para exhibición

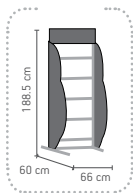

El precio no incluye los productos exhibidos



CÓDIGO	AROMATIZANTES	DISTRIB.	MAYOREO	LISTA
220333	42	\$2,270.00	\$3,245.00	\$4,005.00

Exhibidor de metal para Areon Home

PROX. ○

- ▶ Exhibidor metálico
- ▶ 5 Repisas para exhibición

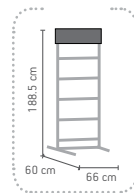

El precio no incluye los productos exhibidos

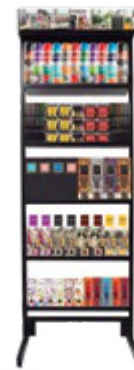

CÓDIGO	DISTRIB.	MAYOREO	LISTA
220334	\$3,500.00	\$5,000.00	\$6,175.00

Exhibidor CARRÖK

NUEVO

- ▶ Exhibidor metálico
- ▶ 5 Repisas para exhibición
- ▶ Capacidad para 42 botellas Carr0k

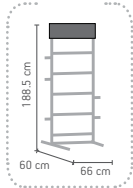

El precio no incluye los productos exhibidos



CARRÖK

CÓDIGO	AROMATIZANTES	DISTRIB.	MAYOREO	LISTA
220335	42	\$3,500.00	\$5,000.00	\$6,175.00

Exhibidor para discos de corte y desbaste

NUEVO

- ▶ Exhibidor ideal para mantener de pie o colgar en la pared
- ▶ Incluye nueve ganchos fijos

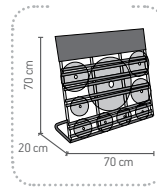

El precio no incluye los productos exhibidos



AKSI

CÓDIGO	TEMA	DISTRIB.	MAYOREO	LISTA
220410	Discos	\$1,950.00	\$2,785.00	\$3,440.00

Exhibidor para cerraduras

Incluye:

- ▶ 4 Barras para colocación de ganchos
- ▶ 7 Ganchos móviles por barra
- ▶ Charola fija
- ▶ Base para exhibición

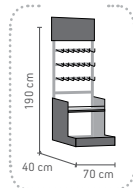

El precio no incluye los productos exhibidos



SEGURIDAD

CÓDIGO	DISTRIB.	MAYOREO	LISTA
220435	\$3,700.00	\$5,285.00	\$6,525.00

Exhibidor para carretillas

- ▶ Práctico exhibidor de piso para 3 carretillas
- ▶ Ideal para negocios pequeños y cualquier tipo de ferretería
- ▶ Incluye material gráfico impreso sobre estireno

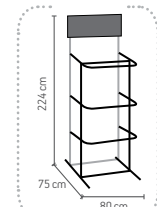

El precio no incluye los productos exhibidos



AKSI

CÓDIGO	DISTRIB.	MAYOREO	LISTA
220412	\$6,400.00	\$9,145.00	\$11,290.00

Exhibidores de cerraduras

- ▶ Ideal para negocios con poco espacio para exhibir
- ▶ Fabricado en madera y forrado en laminado plástico

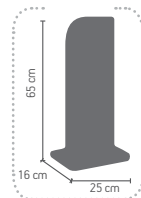

220342
INCLUYE 1 CERRADURA DE ENTRADA PRINCIPAL Y 1 CERROJO

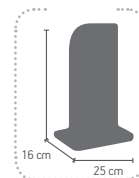

220343
INCLUYE 2 CERRADURAS



CÓDIGO	TIPO DE CERRADURA	DISTRIB.	MAYOREO	LISTA
220342	Cerradura de gatillo	\$965.00	\$1,380.00	\$1,700.00
220343	Cerradura sobreponer y barra	\$850.00	\$1,215.00	\$1,500.00

AKSI

Exhibidor de pintura en aerosol para 108 piezas

- ▶ Ideal para negocios pequeños y cualquier tipo de ferretería
- ▶ Incluye material gráfico impreso sobre estireno
- ▶ Despacha fácil y rápido

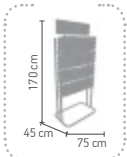

El precio no incluye los productos exhibidos



CÓDIGO	DISTRIB.	MAYOREO	LISTA
220323	\$3,550.00	\$5,070.00	\$6,260.00

Exhibidor de pintura en aerosol para 64 piezas

- ▶ Ideal para negocios pequeños y cualquier tipo de ferretería
- ▶ Incluye material gráfico impreso sobre estireno
- ▶ Despacha fácil y rápido

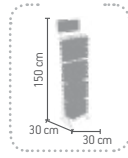

El precio no incluye los productos exhibidos



CÓDIGO	DISTRIB.	MAYOREO	LISTA
220322	\$2,400.00	\$3,430.00	\$4,235.00

Exhibidor para productos de pintura

- ▶ Exhibidor de piso para más de 150 productos
- ▶ Ideal para espacios pequeños
- ▶ Despacha fácil y rápido
- ▶ Incluye material gráfico impreso sobre estireno

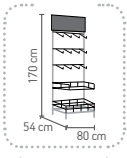

El precio no incluye los productos exhibidos

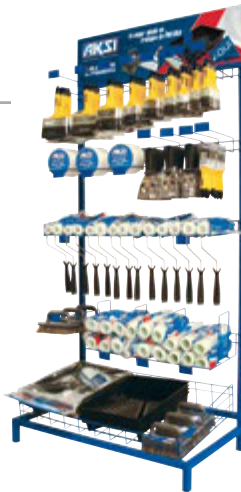

CÓDIGO	DISTRIB.	MAYOREO	LISTA
220411	\$4,750.00	\$6,785.00	\$8,380.00

Mini exhibidor de pintura en aerosol para 32 piezas

- ▶ Novedoso exhibidor y organizador de pinturas en aerosol
- ▶ Ideal para espacios reducidos o en mostrador
- ▶ Incluye material gráfico impreso sobre estireno

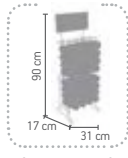

El precio no incluye los productos exhibidos



CÓDIGO	DISTRIB.	MAYOREO	LISTA
220321	\$1,050.00	\$1,500.00	\$1,850.00

Exhibidor para brochas

- ▶ Cuenta con 9 ganchos para exhibición de producto con porta precio
- ▶ Práctico exhibidor para mostrador y pared
- ▶ Incluye cabecera

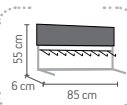

El precio no incluye los productos exhibidos



CÓDIGO	MARCA	DISTRIB.	MAYOREO	LISTA
220418	MAXTOOL®	\$2,650.00	\$3,785.00	\$4,675.00

Exhibidor de lijas

- ▶ Práctico exhibidor despachador con ocho compartimientos
- ▶ Ideal para mostrador
- ▶ Ligera inclinación en cada charola
- ▶ Con sujetador

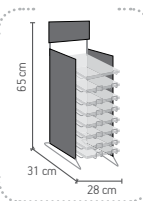

El precio no incluye los productos exhibidos



CÓDIGO	TEMA	DISTRIB.	MAYOREO	LISTA
220405	Lijas	\$1,300.00	\$1,855.00	\$2,295.00

Mesa de exhibición

- ▶ Pintada electrostáticamente
- ▶ Color azul
- ▶ Logos impresos en vinil en ambos lados
- ▶ Para exhibir 10 máquinas máximo
- ▶ Incluye tornillería de instalación

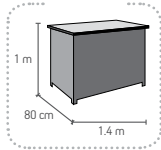

El precio no incluye los productos exhibidos



AKSI

CÓDIGO	DISTRIB.	MAYOREO	LISTA
220458	\$14,300.00	\$20,430.00	\$25,225.00

Cabecera de 120 cm x 30 cm

- ▶ Cabecera impresa en estireno
- ▶ Práctica cabecera que impulsa el desplazamiento del producto

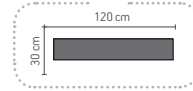

CÓDIGO	TEMA	DISTRIB.	MAYOREO	LISTA
220797	AKSI®	\$285.00	\$405.00	\$505.00
220798	MAXTOOL®	\$285.00	\$405.00	\$505.00

Base metálica para exhibición de herramienta eléctrica

- ▶ Pintadas electrostáticamente
- ▶ Color negro mate
- ▶ Cuenta con orificios para fijación y aseguramiento de la herramienta



EL PRECIO NO INCLUYE EL PRODUCTO EXHIBIDO

AKSI

CÓDIGO	HERRAMIENTA	DISTRIB.	MAYOREO	LISTA
220451	Base para esmeriladora industrial	\$160.00	\$230.00	\$280.00
220452	Base para rotomartillo	\$160.00	\$230.00	\$280.00
220453	Base para multipro / esmeriladora	\$160.00	\$230.00	\$280.00
220454	Base para pistola de calor / sierra caladora	\$160.00	\$230.00	\$280.00
220455	Base para taladro	\$160.00	\$230.00	\$280.00
220459	Base para sierra circular	\$160.00	\$230.00	\$280.00
220460	Base para lijadora de banda	\$160.00	\$230.00	\$280.00
220461	Base para lijadora industrial	\$160.00	\$230.00	\$280.00

Catálogo de productos

- ▶ Identifica fácil y rápido todos los productos AKSI® y MAXTOOL®
- ▶ Dentro encontrarás las principales características y ventajas de cada producto
- ▶ Portada laminada para mayor resistencia al uso rudo



¡DESCARGA TU CATÁLOGO!



AKSI

CÓDIGO	TEMA	Icono	DISTRIB.	MAYOREO	LISTA
220991	Con precios	15	\$175.00	\$250.00	\$310.00
220994	Sin precios	15	\$175.00	\$250.00	\$310.00

Muestrario de pintura

- ▶ Identifica fácil y rápido todos los colores de pintura disponibles.



AKSI

CÓDIGO	PINTURA	Icono	DISTRIB.	MAYOREO	LISTA
220993	Aerosol	50	\$28.00	\$40.00	\$49.00
220998	Vinílica	50	\$12.00	\$17.10	\$21.20
220999	Esmalte	50	\$12.00	\$17.10	\$21.20

Cilindros para agua

- ▶ Elaborados en PVC de alta calidad
- ▶ Capacidad de 1 L



CÓDIGO	DISTRIB.	MAYOREO	LISTA
220505	\$42.00	\$60.00	\$74.00

Los colores pueden variar dependiendo del stock.

Plumas

- ▶ Tinta negra
- ▶ Punto medio



CÓDIGO	COLOR	DISTRIB.	MAYOREO	LISTA
220586	Blanca	\$11.00	\$15.70	\$19.40

Los colores pueden variar dependiendo del stock.

Dominó

- ▶ Estuche en Curpiel grabado
- ▶ Logotipo de AKSI® al reverso de cada ficha
- ▶ Medidas de ficha:
 - altura 54.5 mm
 - base 27.1 mm
 - profundidad 16.4 mm



CÓDIGO	DISTRIB.	MAYOREO	LISTA
220511	\$935.00	\$1,335.00	\$1,650.00

Paraguas

- ▶ Paraguas de ocho gajos
- ▶ Diámetro de apertura 1.20 m



CÓDIGO	DISTRIB.	MAYOREO	LISTA
220514	\$330.00	\$470.00	\$580.00

Los colores pueden variar dependiendo del stock.

Libreta AKSI®

- ▶ 100 hojas de raya



CÓDIGO	DISTRIB.	MAYOREO	LISTA
220509	\$430.00	\$615.00	\$760.00

Pluma ejecutiva

- ▶ Grabado láser
- ▶ Tinta negra



CÓDIGO	DISTRIB.	MAYOREO	LISTA
220585	\$495.00	\$705.00	\$875.00

Bolsa ecológica

- ▶ Tela non woven 100% polipropileno
- ▶ 40 x 35 x 10 cm
- ▶ Capacidad de carga máxima 6 kg



CÓDIGO	DISTRIB.	MAYOREO	LISTA
221019	\$60.00	\$86.00	\$106.00

Mochila roja

- ▶ Mochila básica con dos compartimentos
- ▶ En color rojo



CÓDIGO	DISTRIB.	MAYOREO	LISTA
220518	\$220.00	\$315.00	\$390.00

Mochila triangular

- ▶ Mochila triangular con compartimento para celular y cartera
- ▶ Cierre frontal
- ▶ En color rojo



CÓDIGO	DISTRIB.	MAYOREO	LISTA
220517	\$225.00	\$320.00	\$395.00

Morral

- ▶ Morral impreso
- ▶ Con jaretas
- ▶ Confeccionado con materiales de alta calidad



CÓDIGO	DISTRIB.	MAYOREO	LISTA
220516	\$108.00	\$155.00	\$190.00

Los colores pueden variar dependiendo del stock.

Camisa y blusa manga larga

- ▶ Camisas de gran calidad con 4 logotipos bordados
- ▶ Ideal para uniformar empleados que atienden en mostrador



CÓDIGO	TALLA	CORTE	COLOR	DISTRIB.	MAYOREO	LISTA
220201	S	Caballero	Azul	\$680.00	\$970.00	\$1,200.00
220202	M	Caballero	Azul	\$680.00	\$970.00	\$1,200.00
220203	L	Caballero	Azul	\$680.00	\$970.00	\$1,200.00
220204	XL	Caballero	Azul	\$680.00	\$970.00	\$1,200.00
220205	XXL	Caballero	Azul	\$680.00	\$970.00	\$1,200.00
220206	XXXL	Caballero	Azul	\$680.00	\$970.00	\$1,200.00
220207	S	Caballero	Gris	\$680.00	\$970.00	\$1,200.00
220208	M	Caballero	Gris	\$680.00	\$970.00	\$1,200.00
220209	L	Caballero	Gris	\$680.00	\$970.00	\$1,200.00
220210	XL	Caballero	Gris	\$680.00	\$970.00	\$1,200.00
220211	XXL	Caballero	Gris	\$680.00	\$970.00	\$1,200.00
220212	XXXL	Caballero	Gris	\$680.00	\$970.00	\$1,200.00

CÓDIGO	TALLA	CORTE	COLOR	DISTRIB.	MAYOREO	LISTA
220221	S	Dama	Azul	\$680.00	\$970.00	\$1,200.00
220222	M	Dama	Azul	\$680.00	\$970.00	\$1,200.00
220223	L	Dama	Azul	\$680.00	\$970.00	\$1,200.00
220224	XL	Dama	Azul	\$680.00	\$970.00	\$1,200.00
220226	S	Dama	Gris	\$680.00	\$970.00	\$1,200.00
220227	M	Dama	Gris	\$680.00	\$970.00	\$1,200.00
220228	L	Dama	Gris	\$680.00	\$970.00	\$1,200.00
220229	XL	Dama	Gris	\$680.00	\$970.00	\$1,200.00

Sudadera con capucha y cierre

- ▶ Sudadera con capucha y cordón en un mismo color
- ▶ Corte unisex
- ▶ Bolsas delanteras
- ▶ Cierre de metal
- ▶ En colores azul y gris



CÓDIGO	TALLA	COLOR	DISTRIB.	MAYOREO	LISTA
220181	S	Azul	\$740.00	\$1,055.00	\$1,305.00
220182	M	Azul	\$740.00	\$1,055.00	\$1,305.00
220183	L	Azul	\$740.00	\$1,055.00	\$1,305.00
220184	XL	Azul	\$740.00	\$1,055.00	\$1,305.00
220186	S	Gris	\$740.00	\$1,055.00	\$1,305.00
220187	M	Gris	\$740.00	\$1,055.00	\$1,305.00
220188	L	Gris	\$740.00	\$1,055.00	\$1,305.00
220189	XL	Gris	\$740.00	\$1,055.00	\$1,305.00



Playera cuello redondo

- ▶ Playeras de gran calidad con logotipo impreso en frente y espalda
- ▶ Ideal para uniformar empleados que atienden en mostrador con actividades pesadas



CÓDIGO	TALLA	COLOR	DISTRIB.	MAYOREO	LISTA
220111	S	Marino	\$170.00	\$245.00	\$300.00
220112	M	Marino	\$170.00	\$245.00	\$300.00
220113	L	Marino	\$170.00	\$245.00	\$300.00
220114	XL	Marino	\$170.00	\$245.00	\$300.00
220119	XXL	Marino	\$170.00	\$245.00	\$300.00
220115	M	Gris	\$170.00	\$245.00	\$300.00
220116	L	Gris	\$170.00	\$245.00	\$300.00
220117	XL	Gris	\$170.00	\$245.00	\$300.00
220118	XXL	Gris	\$170.00	\$245.00	\$300.00



Playera tipo polo

- ▶ Playeras de gran calidad con logotipos bordados en pecho y manga
- ▶ Ideal para uniformar empleados que atienden en mostrador
- ▶ Disponible en corte para dama y caballero



CÓDIGO	TALLA	CORTE	DISTRIB.	MAYOREO	LISTA
220141	S	Caballero	\$340.00	\$485.00	\$600.00
220142	M	Caballero	\$340.00	\$485.00	\$600.00
220143	L	Caballero	\$340.00	\$485.00	\$600.00
220144	XL	Caballero	\$340.00	\$485.00	\$600.00
220145	XXL	Caballero	\$340.00	\$485.00	\$600.00
220151	S	Dama	\$340.00	\$485.00	\$600.00
220152	M	Dama	\$340.00	\$485.00	\$600.00
220153	L	Dama	\$340.00	\$485.00	\$600.00
220154	XL	Dama	\$340.00	\$485.00	\$600.00



Mandil AKSI®

- ▶ Mandil de algodón - poliéster
- ▶ 3 Bolsas frontales
- ▶ Corte unisex



CÓDIGO	DISTRIB.	MAYOREO	LISTA
220161	\$395.00	\$565.00	\$695.00

Gorra bordada

- ▶ Logotipos bordados
- ▶ Ligera
- ▶ Lavable
- ▶ Ajustable



CÓDIGO	COLOR	DISTRIB.	MAYOREO	LISTA
221002	Azul	\$115.00	\$165.00	\$205.00
221000	Negra	\$115.00	\$165.00	\$205.00

ROTULACIÓN

- ▶ AKSI® te ayuda con la adaptación estructural y dimensional de la rotulación de tu negocio, potencializa la venta de productos AKSI® con un toque distintivo.
- ▶ Dale imagen y color a tu negocio con nuestra rotulación, ideal para todo tipo de tlapalerías y ferreterías.
- ▶ Pintura vinílica para exteriores, resistente al sol y la lluvia. Garantía de pintura en rotulación sin deterioro ambiental por un año.
- ▶ Solicítalo a través de tu agente de ventas.



Góndola con caja de luz

NUEVO

- 20 Ganchos con portaprecios
- 1 Charola móvil
- 1 Base fija

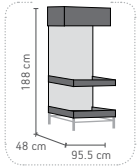

El precio no incluye los productos exhibidos



Petit

CÓDIGO	DISTRIB.	MAYOREO	LISTA
230071	\$19,800.00	\$28,285.00	\$34,925.00

Exhibidor genérico

NUEVO

- 1 Charola fija
- 1 Charola ajustable
- 25 Ganchos para exhibición

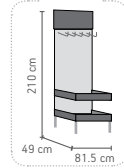

El precio no incluye los productos exhibidos



Petit

CÓDIGO	DISTRIB.	MAYOREO	LISTA
230072	\$7,700.00	\$11,000.00	\$13,580.00

Panel exhibidor

PROX.

- ▶ Práctico módulo que permite realizar una exhibición con diferentes productos
- ▶ Incluye cabecera
- ▶ El material puede ser exhibido con ganchos o cinchos

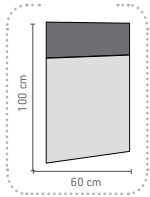

Petit

CÓDIGO	DISTRIB.	MAYOREO	LISTA
220387	\$1,300.00	\$1,855.00	\$2,295.00

Catálogo Petit®

- Encontrarás las principales características y ventajas de cada producto
- Portada laminada para mayor resistencia al uso



Petit

CÓDIGO	DETALLES	DISTRIB.	MAYOREO	LISTA
230091	Con precios	\$145.00	\$205.00	\$255.00
230092	Sin precios	\$145.00	\$205.00	\$255.00

Taza medidora

PROX.

- Taza de plástico policarbonato, cómoda y fácil de usar
- Fabricadas en plástico grado alimenticio



Petit

CAPACIDAD		CÓDIGO	CAPACIDAD	DISTRIB.	MAYOREO	LISTA
250 ml - 1 tza		230041	250 ml	\$125.00	\$180.00	\$220.00

Mandil

NUEVO

- Fabricado en loneta, repelente al agua
- Mandil unisex
- Logo bordado



Petit

CÓDIGO	DISTRIB.	MAYOREO	LISTA
230021	\$320.00	\$455.00	\$565.00

Bolsa ecológica

PROX. ●

- ▶ Tela non woven 100% polipropileno
- ▶ 40 x 35 x 10 cm
- ▶ Capacidad máxima 6 kg



Petit

CÓDIGO	DISTRIB.	MAYOREO	LISTA
221020	\$60.00	\$86.00	\$106.00

Mochila triangular

PROX. ●

- Mochila triangular con compartimento
- Cierre frontal



Petit

CÓDIGO	DISTRIB.	MAYOREO	LISTA
230051	\$225.00	\$320.00	\$395.00

Morral

PROX. ●

- Morral impreso en serigrafía
- Cierre frontal



Petit

CÓDIGO	DISTRIB.	MAYOREO	LISTA
230052	\$108.00	\$155.00	\$190.00

Los colores pueden variar dependiendo del stock.

Filipina

- Antifluidos
- Disponible para dama y caballero
- Logo bordado

CÓDIGO	CARACT.	DISTRIB.	MAY.	LISTA
TURQUESA				
230001	CH Dama	\$900.00	\$1,285.00	\$1,590.00
230002	M Dama	\$900.00	\$1,285.00	\$1,590.00
230003	G Dama	\$900.00	\$1,285.00	\$1,590.00
230011	CH Caballero	\$900.00	\$1,285.00	\$1,590.00
230012	M Caballero	\$900.00	\$1,285.00	\$1,590.00
230013	G Caballero	\$900.00	\$1,285.00	\$1,590.00

CÓDIGO	CARACT.	DISTRIB.	MAY.	LISTA
MORADA				
230005	CH Dama	\$900.00	\$1,285.00	\$1,590.00
230006	M Dama	\$900.00	\$1,285.00	\$1,590.00
230007	G Dama	\$900.00	\$1,285.00	\$1,590.00
230015	CH Caballero	\$900.00	\$1,285.00	\$1,590.00
230016	M Caballero	\$900.00	\$1,285.00	\$1,590.00
230017	G Caballero	\$900.00	\$1,285.00	\$1,590.00



ROTULACIÓN

- ▶ PETIT® te ayuda con la adaptación estructural y dimensional de la rotulación de tu negocio, potencializa la venta de productos con un toque distintivo.
- ▶ Pintura vinílica para exteriores, resistente al sol y la lluvia. Garantía de pintura en rotulación sin deterioro ambiental por un año.
- ▶ Solicítalo a través de tu agente de ventas.



Stoppers

Viniles

Posters



ÍNDICE —

CÓDIGO	PÁGINA	CÓDIGO	PÁGINA	CÓDIGO	PÁGINA	CÓDIGO	PÁGINA	CÓDIGO	PÁGINA	CÓDIGO	PÁGINA
100101	115	100331	54	100395	54	100470	56	100711	116	101309	387
100102	115	100332	54	100399	54	100471	56	100712	116	101310	387
100103	115	100333	54	100401	56	100472	56	100802	399	101311	387
100104	115	100334	54	100402	56	100473	56	100803	399	101312	387
100105	115	100335	54	100403	56	100474	56	100805	399	101313	387
100106	115	100336	54	100404	56	100475	56	100806	399	101314	387
100107	115	100337	54	100405	56	100476	56	100811	399	101401	400
100108	115	100338	54	100406	56	100477	56	100812	399	101402	400
100109	115	100339	54	100407	56	100478	56	100813	399	101403	400
100121	115	100340	54	100408	56	100479	56	100851	399	101404	400
100201	57,86	100341	54	100409	56	100480	56	100852	399	101405	400
100202	57,86	100342	54	100410	56	100481	56	100911	360	101411	401
100203	57,86	100343	54	100411	56	100482	56	100912	360	101501	86
100204	57,86	100344	54	100412	56	100483	56	101001	352	101502	86
100205	57,86	100345	54	100413	56	100484	56	101002	352	101503	86
100301	55	100346	54	100414	56	100485	56	101003	352	101504	86
100302	55	100347	54	100415	56	100491	56,86	101004	352	101505	86
100303	55	100348	54	100441	56	100492	57	101005	352	101506	86
100304	55	100349	54	100442	56	100501	55	101006	352	101507	86
100305	55	100350	54	100443	56	100502	55	101007	352	101508	86
100306	55	100351	54	100444	56	100503	55	101008	352	101509	86
100307	55	100352	54	100445	56	100504	55	101009	352	101510	86
100308	55	100353	54	100446	56	100505	55	101011	352	101511	86
100309	55	100354	54	100447	56	100506	55	101012	352	101512	86
100310	55	100355	54	100448	56	100511	57	101013	352	101513	86
100311	55	100356	54	100449	56	100512	57	101101	94	101514	86
100312	55	100357	54	100451	56	100513	57	101102	94	101515	86
100313	55	100358	54	100452	56	100514	57	101103	94	101516	86
100314	55	100359	54	100453	56	100515	57	101104	94	101517	86
100315	55	100361	55	100454	56	100516	57	101105	94	101518	86
100316	55	100362	55	100455	56	100517	57	101106	94	101601	351
100317	55	100365	54	100456	56	100518	57	101111	94	101602	351
100318	55	100366	54	100457	56	100519	57	101112	94	101603	351
100319	55	100367	54	100458	56	100520	57	101113	94	101604	351
100320	55	100373	54	100459	56	100521	57	101114	94	101605	351
100321	55	100374	54	100460	56	100522	57	101115	94	101606	351
100322	55	100375	54	100461	56	100531	54	101116	94	101607	351
100323	55	100376	54	100462	56	100602	117,391	101207	120	101608	351
100324	55	100377	54	100463	56	100605	117,391	101208	120	101609	351
100325	55	100378	54	100464	56	100701	116	101209	120	101610	351
100326	55	100379	54	100465	56	100702	116	101210	230	101702	234
100327	55	100381	54	100466	56	100703	116	101211	230	101703	234
100328	55	100383	54	100467	56	100704	116	101212	230	101704	234
100329	55	100387	54	100468	56	100706	116	101304	387	101705	234
100330	55	100391	54	100469	56	100707	116	101308	387	101706	234
										101707	234

CÓDIGO	PÁGINA	CÓDIGO	PÁGINA	CÓDIGO	PÁGINA	CÓDIGO	PÁGINA	CÓDIGO	PÁGINA	CÓDIGO	PÁGINA
101708	234	102306	43	102931	349	103501	49	104215	232	104909	98
101709	234	102307	43	102932	349	103502	49	104216	232	104910	98
101901	392	102308	43	102933	349	103503	122,273	104321	92	104911	98
101902	392	102309	43	102934	349	103504	122,273	104331	92	104912	98
101903	392	102310	43	102941	350	103515	122,273	104332	92	104913	98
101904	391	102311	43	102942	350	103516	122	104392	92	104914	98
101905	391	102312	43	102943	350	103517	122	104393	92	104915	98
102101	95	102313	43	102951	348	103518	122	104501	364	104916	98
102102	95	102314	43	103001	87	103519	122	104502	364	104917	98
102103	95	102401	91	103002	87	103520	122	104614	361	104918	98
102104	95	102402	91	103003	87	103521	122	104615	360	104919	98
102105	96	102403	91	103004	87	103601	48	104616	360	104920	98
102106	96	102404	91	103005	87	103701	125	104617	360	104921	98
102107	96,355	102405	91	103006	87	103702	125	104631	361	104922	98
102108	96,355	102410	47	103007	87	103703	125	104632	361	104923	98
102109	96,355	102411	91,349	103008	87	103704	125	104633	361	104924	98
102110	96,355	102412	91	103009	87	103705	126	104634	361	104925	98
102121	96,115	102413	91	103010	87	103706	125	104636	361	104926	98
102122	96,115	102414	91	103011	87	103707	125	104637	361	104927	98
102201	43	102415	91	103012	87	103710	125	104638	361	104928	98
102202	43	102416	47	103013	87	103711	125	104639	361	104929	98
102203	43	102417	47	103014	87	103712	125	104640	361	104930	98
102204	43	102418	91,349	103015	87	103713	126	104681	399	104932	98
102205	43	102419	91	103016	87	103714	126	104731	354	104941	98
102206	43	102420	91	103017	87	103715	126	104732	354	104942	98
102207	43	102504	365	103018	87	103716	126	104733	354	104943	98
102208	43	102505	365	103019	87	103718	125	104741	354	104944	98
102209	43	102507	365	103020	87	103719	126	104742	354	104945	98
102210	43	102801	87	103021	87	103720	126	104743	354	104946	98
102211	43	102802	87	103022	87	103801	394	104751	354	104947	98
102212	43	102803	87	103023	87	103802	394	104752	354	104948	98
102213	43	102811	87	103111	121	103803	394	104753	354	104949	98
102214	43	102812	87	103112	121	103804	394	104761	354	104950	98
102215	43	102813	87	103113	121	103805	394	104762	354	104951	98
102216	43	102903	350	103121	121	103806	394	104763	354	104952	98
102217	43	102904	350	103122	121	103807	394	104804	356	104961	98
102218	43	102905	350	103123	121	103808	394	104805	356	104962	98
102219	43	102906	350	103307	339,347	103809	394	104806	356	104963	98
102220	43	102907	350	103308	339,347	103810	394	104811	356	104964	98
102221	43	102909	348	103310	339,347	103811	394	104812	356	104965	98
102222	43	102910	348	103311	339,347	103812	394	104813	356	104966	98
102223	43	102911	348	103312	339,347	103813	394	104901	98	104971	98
102224	43	102912	348	103313	339,347	103814	394	104902	98	104972	98
102225	43	102913	348	103321	348	104001	91,349,365	104903	98	104973	98
102301	43	102921	348	103322	348	104002	91,349,365	104904	98	104974	98
102302	43	102922	348	103323	348	104211	232	104905	98	104975	98
102303	43	102923	348	103324	348	104212	232	104906	98	104976	98
102304	43	102924	348	103325	348	104213	232	104907	98	104977	98
102305	43	102925	348	103326	348	104214	232	104908	98	104978	98

CÓDIGO	PÁGINA	CÓDIGO	PÁGINA	CÓDIGO	PÁGINA	CÓDIGO	PÁGINA	CÓDIGO	PÁGINA	CÓDIGO	PÁGINA
104979	98	105378	392	106419	66	106904	373	107808	226	108307	69
104980	98	105402	97	106420	66	106905	373	107809	226	108308	69
105001	352	105403	97	106421	66	106906	373	107810	226	108309	69
105002	352	105701	128	106422	66	106907	373	107811	226	108310	69
105003	352	105702	128	106423	66	106908	86,372	107812	226	108311	69
105004	352	105801	81	106424	66	106909	86,372	107821	226	108312	69
105005	352	105802	81,124,226	106425	66	106910	373	107822	226	108313	69
105006	352	105811	81	106426	66	106911	114,372	107823	226	108314	69
105009	352	105812	81	106427	66	106912	114,372	107831	81,356	108315	69
105101	89	105813	81	106428	66	106920	372	107832	81,356	108316	69
105102	89	105814	81	106429	66	106921	372	107841	80	108321	68
105103	89	105815	81	106430	66	106922	372	107901	81,353	108322	68
105104	89	105820	81	106431	66	106926	372	107904	81,353	108323	68
105105	89	105821	81	106432	66	106927	372	107918	81,353	108324	68
105106	89	105831	81,124,226	106433	66	106931	373	107931	51,356	108331	68
105107	89	105832	81,124,226	106434	66	106932	373	107932	51,356	108332	68
105201	364,397	106001	90	106435	66	106933	373	107933	51,356	108333	68
105202	364,397	106002	90	106436	66	106941	373	107934	51,356	108334	68
105203	364,397	106003	90	106437	66	106942	373	108001	387	108501	229
105211	364,397	106006	90	106438	66	106943	373	108002	387	108502	229
105221	364,397	106011	90	106439	66	107301	127	108003	387	108503	229
105222	364,397	106012	90	106440	66	107302	127	108004	80,356	108504	229
105351	392	106013	90	106441	66	107303	127	108101	80	108505	229
105352	392	106021	90	106442	66	107304	127	108102	80	108506	229
105353	392	106031	90	106443	66	107311	127	108103	80	108507	229
105354	392	106032	90	106444	66	107312	127	108111	80,123	108508	229
105355	392	106033	90	106502	66	107313	127	108112	80,123	108509	229
105356	392	106304	397	106504	66	107314	127	108113	80,123	108510	229
105357	392	106305	397	106506	66	107315	127	108114	80,123	108511	229
105358	392	106306	397	106601	44,116,354	107316	127	108115	80,123	108512	229
105359	392	106307	397	106602	44,116,354	107401	93	108116	80,123	108513	229
105360	392	106401	66	106603	44,116,354	107402	93	108117	80,123	108514	229
105361	392	106402	66	106604	44,116,354	107501	48,396	108118	80,123	108515	229
105362	392	106403	66	106605	44,116,354	107502	48,396	108119	80,123	108516	229
105363	392	106404	66	106606	44,116,354	107503	48,396	108120	80,123	108517	229
105364	392	106405	66	106607	44,116,354	107504	48,396	108121	80,123	108518	229
105365	392	106406	66	106611	44,116,354	107601	231	108181	51,80	108519	229
105366	392	106407	66	106612	44,116,354	107602	231	108182	51,80	108520	229
105367	392	106408	66	106613	44,116,354	107603	231	108201	80,123	108521	229
105368	392	106409	66	106614	44,116,354	107604	231	108202	80,123	108522	229
105369	392	106410	66	106615	44,116,354	107705	123	108203	80,123	108523	229
105370	392	106411	66	106617	44,116,354	107706	123	108204	80,123	108524	229
105371	392	106412	66	106706	65	107711	387	108205	80,123	108525	229
105372	392	106413	66	106707	65	107712	387	108301	69	108526	229
105373	392	106414	66	106708	65	107801	226	108302	69	108527	230
105374	392	106415	66	106709	65	107802	226	108303	69	108528	230
105375	392	106416	66	106901	373	107803	226	108304	69	108529	230
105376	392	106417	66	106902	373	107806	226	108305	69	108530	230
105377	392	106418	66	106903	373	107807	226	108306	69	108531	229

CÓDIGO	PÁGINA	CÓDIGO	PÁGINA	CÓDIGO	PÁGINA	CÓDIGO	PÁGINA	CÓDIGO	PÁGINA	CÓDIGO	PÁGINA
108532	229	109113	88	109924	83	110373	75	111252	50,73	111842	72
108533	229	109114	88	109925	83	110374	75	111253	50,73	111843	72
108534	229	109115	88	109931	83	110376	75	111256	50,73	111844	71
108535	230	109201	114	109932	83	110377	75	111257	50,73	111849	72
108536	230	109202	114	109933	83	110378	75	111258	50,73	111901	401
108537	230	109203	114	109934	83	110379	75	111611	216	111902	401
108538	230	109204	114,124	109935	83	110381	75	111612	216	111903	401
108539	230	109205	114,124	110001	52	110382	75	111613	216	111904	401
108540	230	109206	114,124	110002	52	110383	75	111614	216	111905	401
108541	230	109207	114,124	110003	52	110384	75	111615	216	111906	401
108542	230	109208	114,124	110004	52	110460	132	111621	223	112101	47,93
108543	230	109209	114,124	110005	52	110462	134	111622	224	112102	47,93
108544	229	109210	114,124	110006	52	110464	133	111631	223	112103	93
108545	229	109301	350,406	110101	303	110466	133	111632	223	112110	93
108546	229	109303	350,401	110201	396	110606	132	111641	222	112120	47,94
108547	229	109304	77,127,350	110202	396	110616	132	111651	218	112122	47,94
108613	126	109306	77,350,360	110203	396	110622	132	111652	220	112201	57
108614	126	109307	350,360	110204	396	110635	134	111653	220	112209	57
108617	126	109308	85,129,350,371	110206	396	110639	134	111654	218	112210	57
108618	126	109309	50,73	110301	75,120	110647	133	111655	219	112211	57
108703	353	109501	94	110302	75,120	110685	135	111656	218	112601	233
108902	408	109502	94	110303	75,120	110687	135	111657	218	112602	233
109001	88	109601	231	110304	75,120	110691	136	111658	218	112701	67
109002	88	109603	231	110305	75,120	110693	136	111660	219	112702	67
109003	88	109701	231,402	110306	75,120	110694	136	111661	219	112711	67
109004	88	109702	231,402	110307	75,120	110983	133	111662	219	112712	67
109005	88	109801	85,371	110315	75,120	111101	58,370	111663	220	112713	67
109006	88	109802	85,371	110316	75,120	111102	58,370	111682	222	112801	69
109014	89	109803	85,371	110317	75,120	111103	58,370	111683	222	112802	69
109015	89	109804	85,371	110318	75,120	111104	58,370	111695	224	112901	87
109021	90	109805	85,371	110319	75,120	111105	58,370	111711	77	112902	87
109035	90	109806	85,371	110320	75,120	111106	58,370	111712	77	112903	87
109036	90	109807	85,371	110321	75,120	111107	58,370	111713	77	112911	87
109037	90	109808	84	110322	75,120	111108	58,370	111801	71	112912	87
109038	90	109811	85,129,371	110323	75,120	111109	58,370	111802	71	113001	315
109039	90	109812	85,129,371	110324	75,120	111201	360	111803	71	113002	315
109051	88	109901	83	110334	75,120	111202	360	111821	71	113003	315
109052	88	109902	83	110335	75,120	111203	360	111822	71	113004	314
109053	88	109903	83	110336	75,120	111204	360	111823	71	113005	315
109061	88	109904	83	110337	75,120	111205	360	111831	72	113006	315
109062	88	109905	83	110338	75,120	111206	360	111832	72	113007	315
109091	88	109911	83	110339	75,120	111221	73	111834	72	113008	315
109101	88	109912	83	110340	75,120	111222	73	111835	72	113009	313
109102	88	109913	83	110351	75	111231	117,391	111836	72	113010	313
109103	88	109914	83	110352	75	111232	117,391	111837	72	113113	127
109104	88	109915	83	110353	75	111241	50	111838	72	113201	231,402
109105	88	109921	83	110354	75	111242	50	111839	72	113202	231,402
109111	88	109922	83	110371	75	111243	50	111840	71	113203	231,402
109112	88	109923	83	110372	75	111251	50,73	111841	71	113204	231,402

CÓDIGO	PÁGINA	CÓDIGO	PÁGINA	CÓDIGO	PÁGINA	CÓDIGO	PÁGINA	CÓDIGO	PÁGINA	CÓDIGO	PÁGINA
113205	231,402	113359	228	113617	226	114004	101	114415	51	114803	346,390
113206	231,402	113360	228	113618	226	114005	101	114416	51	114804	346,390
113207	231,402	113371	227	113701	75,120	114101	101	114421	51	114805	346,390
113208	231,402	113372	227	113801	82	114111	100	114422	51	114806	339
113301	227	113374	228	113802	82	114251	367	114423	51	114807	346,390
113302	227	113375	228	113803	82	114252	367	114424	51	114891	345,389
113303	227	113376	227	113804	82	114253	367	114425	51	114892	345,389
113304	227	113381	228	113805	82	114255	367	114426	51	114895	345,389
113305	227	113382	228	113806	82	114256	367	114501	62	114896	345,389
113306	227	113383	228	113807	82	114257	367	114502	62	114897	345,389
113307	227	113501	319	113808	82	114258	367	114503	62	114899	345,389
113308	227	113502	319	113809	82	114259	367	114504	62	114922	359
113309	227	113503	319	113901	63	114261	367	114505	62	115001	337
113310	227	113504	319	113902	63	114262	367	114506	62	115002	337
113311	227	113505	319	113903	63	114263	367	114602	108	115003	337
113312	227	113506	319	113904	63	114264	367	114603	108	115004	337
113313	227	113507	319	113905	63	114265	367	114604	108	115101	336
113314	227	113508	319	113906	63	114266	367	114605	107	115102	336
113315	227	113509	319	113907	63	114267	367	114606	107	115103	336
113316	227	113510	319	113908	63	114268	367	114630	108	115104	336
113317	227	113511	319	113909	63	114269	367	114631	108	115105	337
113318	227	113512	319	113910	63	114271	367	114632	108	115106	337
113319	227	113513	319	113911	65	114273	367	114633	108	115111	335
113320	227	113514	319	113912	65	114274	367	114634	108	115112	335
113321	227	113515	319	113913	65	114275	367	114635	108	115113	335
113322	227	113516	319	113914	65	114276	367	114651	109	115191	336,337
113323	227	113517	319	113915	65	114277	367	114652	109	115192	336,337
113324	227	113518	319	113916	65	114278	367	114653	109	115193	336
113325	227	113519	319	113921	67	114279	367	114654	109	115194	336,337
113326	227	113520	319	113922	67	114281	367	114680	109	115195	337
113327	227	113521	319	113923	67	114282	367	114681	109	115221	157
113328	228	113522	319	113961	64	114283	367	114682	109	115274	157
113329	228	113523	319	113962	64	114284	367	114684	109	115284	157
113330	228	113524	319	113963	64	114285	367	114685	109	115533	154
113331	228	113525	319	113981	67	114286	367	114701	266,388	115534	154
113332	228	113526	319	113982	67	114291	367	114702	266,388	115535	154
113333	228	113527	319	113983	67	114292	367	114703	266,388	115536	154
113334	228	113528	319	113984	67	114293	367	114704	266,388	115543	151
113335	228	113541	319	113985	67	114294	367	114705	266,388	115544	151
113336	228	113542	319	113986	67	114401	51	114706	266,388	115565	151
113337	228	113543	319	113991	65	114402	51	114707	266,388	115566	151
113351	228	113544	319	113992	65	114403	51	114711	266,388	115585	151
113352	228	113545	319	113993	65	114404	51	114712	266,388	115586	151
113353	228	113606	393	113994	65	114405	51	114721	388	115591	145
113354	228	113611	226	113995	65	114406	51	114722	388	115592	145
113355	228	113612	226	113996	65	114411	51	114731	388	115593	145
113356	228	113613	226	114001	101	114412	51	114732	388	115594	145
113357	228	113614	226	114002	101	114413	51	114801	346,390	115595	145
113358	228	113615	226	114003	101	114414	51	114802	346,390	115596	145

CÓDIGO	PÁGINA	CÓDIGO	PÁGINA	CÓDIGO	PÁGINA	CÓDIGO	PÁGINA	CÓDIGO	PÁGINA	CÓDIGO	PÁGINA
115597	146	116006	358	116426	169,176	116646	78	116883	22	117108	84
115598	146	116012	358	116427	169,176	116651	79	116884	22	117109	84
115599	146	116013	358	116428	169,176	116652	79	116885	22	117120	84
115600	146	116021	77,359	116429	169,176	116653	79	116902	119	117121	84
115601	111	116031	358	116436	172	116654	79	116903	119	117122	84
115602	111	116032	358	116437	172	116661	79	116904	119	117123	84
115603	111	116033	358	116438	172	116662	79	116905	119	117124	84
115604	111	116041	358	116451	169,176	116663	79	116951	118	117125	84
115605	111	116042	358	116452	169,176	116671	79	116952	118	117126	84
115606	111	116043	358	116453	169,176	116672	79	116953	118	117127	84
115607	111	116101	42	116454	169,176	116681	79	116971	118	117130	84
115608	111	116102	42	116456	169,176	116682	79	116972	118	117131	84
115609	111	116112	42	116457	169,176	116683	79	117031	351	117132	84
115701	108	116113	42	116458	169,176	116684	79	117041	50	117133	84
115702	108	116114	42	116459	169,176	116685	79	117042	50	117134	84
115703	108	116123	42	116541	166	116691	79	117043	50	117135	84
115704	108	116125	42	116542	166	116701	20	117044	50	117136	84
115801	234	116140	43	116543	166	116702	20	117045	50	117137	84
115802	234	116141	43	116544	166	116703	20	117046	50	117151	84
115901	395	116142	43	116545	166	116721	20	117051	50	117201	23
115902	395	116143	43	116546	166	116722	20	117052	50	117202	23
115903	395	116144	43	116547	166	116723	20	117053	50	117203	23
115904	395	116150	124	116551	166	116724	20	117054	50	117204	23
115905	395	116151	124	116552	166	116741	22	117055	50	117211	26
115910	395	116152	124	116553	166	116742	22	117056	50	117212	26
115911	395	116153	124	116554	166	116743	22	117061	124	117213	26
115920	395	116154	124	116562	165,175	116744	22	117062	124	117241	43
115921	395	116155	124	116563	165,175	116761	20	117063	124	117242	43
115922	395	116156	124	116564	165,175	116771	22	117064	124	117245	29
115930	395	116161	124	116571	165,175	116772	22	117071	351	117251	30
115931	395	116162	124	116601	78	116781	22	117072	351	117252	30
115932	395	116163	124	116602	78	116801	20	117073	351	117261	20
115933	395	116171	44	116603	78	116802	21	117081	351	117262	20
115940	395	116172	44	116611	78	116803	21	117082	351	117271	21
115950	395	116173	44	116612	78	116804	20	117091	351	117272	21
115951	395	116301	233	116613	78	116811	20	117092	351	117301	26
115961	396	116302	233	116621	78	116812	21	117093	351	117302	26
115962	396	116311	233	116622	78	116813	21	117094	351	117303	26
115963	396	116321	46	116623	78	116814	20	117095	351	117311	26
115964	396	116331	46	116626	78	116815	20	117096	351	117312	26
115971	396	116401	170	116627	78	116823	21	117097	351	117321	27
115972	396	116402	170	116628	78	116824	21	117098	351	117351	26
115973	396	116403	170	116631	78	116825	21	117101	84	117352	26
115981	396	116405	171	116632	78	116831	21	117102	84	117353	26
115982	396	116406	171	116633	78	116832	21	117103	84	117361	26
115983	396	116421	167	116635	78	116833	21	117104	84	117362	26
116003	358	116422	168	116636	78	116834	21	117105	84	117371	26
116004	358	116423	168	116637	78	116881	22	117106	84	117372	27
116005	358	116424	168	116641	78	116882	22	117107	84	117373	27

CÓDIGO	PÁGINA	CÓDIGO	PÁGINA	CÓDIGO	PÁGINA	CÓDIGO	PÁGINA	CÓDIGO	PÁGINA	CÓDIGO	PÁGINA
117374	27	117621	374	117937	162	118204	198	118345	17	118521	112,394
117381	27	117622	374	117938	162	118205	198	118346	17	118522	112,394
117382	27	117623	374	117951	160	118206	198	118347	17	118523	112,394
117383	27	117631	375	117952	160	118211	198	118348	18	118524	112,394
117401	25	117632	375	117953	160	118212	198	118351	19	118531	112,394
117402	25	117633	375	117954	160	118213	198	118352	19	118532	112,394
117403	25	117634	375	117962	162	118214	198	118353	19	118541	112,394
117404	25	117635	375	117964	162	118215	198	118354	19	118542	112,394
117405	25	117636	375	117966	162	118216	198	118361	18	118551	112,394
117411	25	117637	374	117968	162	118231	199	118362	18	118601	385
117412	25	117638	374	117972	162	118232	199	118363	18	118602	385
117413	25	117639	374	117974	162	118251	199	118364	18	118603	385
117414	25	117654	375	117976	162	118252	199	118365	19	118611	385
117421	25	117655	375	117978	162	118253	199	118366	18	118612	385
117501	28	117656	375	117981	164	118271	188	118367	19	118613	385
117502	28	117657	376	117982	164	118272	188	118368	18	118621	385
117503	28	117658	376	117983	164	118273	188	118369	18	118622	385
117504	28	117659	376	117984	164	118274	188	118370	18	118623	385
117506	28	117660	376	117985	164	118275	12,188	118371	18	118631	385
117512	27	117661	376	117986	164	118301	16	118372	19	118632	385
117513	27	117662	376	117987	164	118302	16	118373	18	118633	385
117521	28	117663	376	117988	164	118303	16	118374	19	118641	386
117522	28	117664	376	117991	164	118304	16	118381	19	118642	386
117531	28	117665	376	117992	164	118305	16	118382	19	118643	386
117541	28	117681	377	117993	164	118306	16	118383	19	118651	386
117542	28	117682	377	117994	164	118307	16	118384	19	118652	386
117546	29	117683	377	117995	164	118308	16	118385	19	118653	386
117551	30	117685	377	117996	164	118309	16	118386	19	118661	386
117553	29	117691	377	117997	164	118310	16	118406	128	118662	386
117554	29	117721	377	117998	164	118311	16	118407	128	118663	386
117561	30	117731	377	118001	159	118312	16	118416	128	118701	385
117562	30	117801	137	118002	159	118313	16	118417	128	118702	385
117563	30	117803	137	118003	159	118314	16	118441	129	118703	385
117564	29	117811	137	118004	159	118316	17	118442	129	118711	385
117565	30	117812	137	118011	159	118317	17	118451	129	118712	385
117571	30	117821	137	118012	159	118321	17	118452	129	118713	385
117572	30	117831	138	118021	159	118322	17	118461	128	118721	386
117573	30	117841	138	118022	159	118323	17	118471	128	118722	386
117575	30	117842	138	118032	158	118324	17	118472	128	118731	386
117581	29	117913	162	118038	158	118325	17	118501	112,394	118732	386
117582	29	117914	162	118039	158	118326	17	118502	112,394	118733	386
117583	29	117915	162	118081	158	118331	17	118503	112,394	118741	386
117591	29,75,120	117916	162	118082	158	118332	17	118504	112,394	118742	386
117592	29,75,120	117917	162	118101	224	118333	17	118511	112,394	118743	386
117593	29,75,120	117918	162	118103	224	118334	17	118512	112,394	118751	386
117601	374	117933	162	118105	222	118341	17	118513	112,394	118752	386
117602	374	117934	162	118201	198	118342	17	118516	112,394	118753	386
117603	374	117935	162	118202	198	118343	17	118517	112,394	118761	386
117604	374	117936	162	118203	198	118344	18	118518	112,394	118762	386

CÓDIGO	PÁGINA	CÓDIGO	PÁGINA	CÓDIGO	PÁGINA	CÓDIGO	PÁGINA	CÓDIGO	PÁGINA	CÓDIGO	PÁGINA
118763	386	119204	393	119601	370	119676	369	120073	142	122001	153
118797	385	119206	393	119602	370	119677	369	120075	143	122003	153
118798	385	119207	393	119603	370	119678	369	120077	144	122012	153
118799	385	119208	393	119605	370	119679	369	120079	144	122014	153
118801	127	119209	393	119606	370	119691	369	120081	144	122021	153
118802	127	119211	393	119608	370	119692	369	120901	174	122023	153
118871	401	119213	393	119609	370	119693	369	120911	174,223	122032	153
118901	23	119217	393	119610	370	119694	369	121001	148	122034	153
118902	23	119218	393	119611	370	119701	370	121003	147	122041	153
118906	23	119221	393	119613	370	119702	370	121005	149	122042	153
118907	23	119222	393	119614	370	119703	370	121011	148	122043	153
118909	24	119231	393	119616	370	119704	370	121013	147	122044	153
118911	23	119232	393	119617	370	119705	370	121015	149	122101	183
118912	23	119233	393	119618	370	119706	370	121021	148	122102	184
118921	23	119236	393	119619	370	119707	370	121023	147	122105	183
118922	23	119237	393	119620	370	119708	370	121025	149	122106	183
118963	24	119238	393	119621	369	119709	370	121031	148	122111	181
118971	24	119301	393	119622	369	119710	370	121033	147	122112	181
118972	24	119302	393	119623	369	119711	370	121035	149	122113	182
119001	397	119311	393	119624	369	119712	370	121041	148	122114	181
119002	397	119312	393	119625	369	119713	370	121043	147	122115	180
119003	397	119316	393	119626	369	119714	370	121045	149	122121	184
119004	397	119317	393	119627	369	119715	370	121051	148	122122	184
119005	397	119321	393	119628	369	119753	369	121053	147	122131	178
119011	44	119322	393	119629	369	119754	369	121055	149	122132	180
119012	44	119324	393	119630	369	119755	369	121101	150	122133	180
119013	44	119325	393	119631	369	119756	369	121102	150	122135	179
119014	44	119327	393	119632	369	119757	369	121103	150	122141	182
119015	44	119328	393	119633	369	119758	369	121104	150	122142	182
119016	44	119402	397	119634	369	119765	369	121111	150	122151	185
119017	44	119415	124,397	119635	369	119766	369	121112	150	122152	185
119021	44	119501	368	119636	369	119767	369	121113	150	122161	186
119022	44	119502	368	119637	369	119801	82,129	121114	150	122162	186
119023	44	119511	368	119644	369	119802	82,129	121121	150	122163	185
119024	44	119512	368	119645	369	119804	82,129	121122	150	122164	186
119025	44	119521	367	119646	369	119805	82,129	121123	150	122171	178
119026	44	119531	49	119650	369	119901	230	121124	150	122172	178
119027	44	119532	49	119651	369	119902	230	121131	150	122173	179
119031	44	119533	49	119652	369	119903	230	121132	150	122174	179
119032	44	119541	49	119653	369	119904	230	121133	150	122211	189
119033	44	119542	49	119654	369	120001	142	121134	150	122212	189
119034	44	119551	49	119655	369	120021	142	121501	152	122213	189
119035	44	119571	53,77,353	119656	369	120023	142	121502	152	122214	189
119036	44	119572	53,77,353,359	119657	369	120025	143	121511	152	122215	189
119037	44	119576	377	119671	369	120027	144	121512	152	122216	189
119038	44	119577	42	119672	369	120029	144	121521	152	122217	189
119201	393	119581	49,130	119673	369	120031	144	121522	152	122218	189
119202	393	119583	49,130	119674	369	120061	142	121531	161	122222	189
119203	393	119591	49,124,130	119675	369	120071	142	121533	161	122223	189

CÓDIGO	PÁGINA	CÓDIGO	PÁGINA	CÓDIGO	PÁGINA	CÓDIGO	PÁGINA	CÓDIGO	PÁGINA	CÓDIGO	PÁGINA
122224	189	122407	163	124328	34	124451	36	124804	13	124921	31
122225	189	122408	163	124330	34	124452	36	124805	13	124922	31
122226	189	122411	163	124331	34	124453	36	124806	13	124923	31
122231	193	122412	163	124332	34	124454	36	124807	13	124924	165,174
122241	152,193	122413	163	124333	34	124455	36	124808	14	124925	165,174
122242	152,193	122414	163	124334	34	124461	37	124809	13	124931	31
122243	152,193	122415	163	124335	34	124462	37	124810	13	124991	31
122244	152,193	122416	163	124336	34	124463	37	124811	13	125001	203
122251	191	122417	163	124337	34	124464	37	124812	13	125002	203
122252	191	122418	163	124351	35	124465	37	124813	14	125003	203
122253	191	123001	144	124352	35	124466	37	124814	13	125004	203
122254	191	123002	144	124353	35	124467	37	124815	13	125011	203
122255	191	123113	155	124354	35	124468	37	124821	14	125012	203
122256	191	123114	155	124357	35	124469	37	124822	14	125013	203
122257	191	123221	156	124358	35	124471	38	124823	14	125014	203
122261	191	123223	156	124359	35	124472	38	124824	14	125021	203
122262	191	123228	156	124361	37	124473	38	124825	15	125022	203
122263	191	123301	156	124362	37	124481	35	124826	15	125023	203
122264	191	123302	156	124363	37	124482	35	124827	14	125024	203
122265	191	123901	195	124364	37	124483	35	124831	14	125101	213
122266	191	123911	194	124365	37	124484	35	124832	14	125102	213
122267	191	123921	194	124366	37	124494	39	124833	14	125103	213
122271	190	124101	53,77,116,353	124367	37	124495	39	124834	14	125104	213
122272	190	124109	53,77,116,353	124368	37	124496	39	124835	15	125111	213
122281	192	124201	53,353	124375	37	124497	39	124836	15	125112	213
122282	192	124202	53,353	124376	37	124501	402	124837	14	125114	213
122283	192	124211	53,353	124377	37	124502	402	124841	14	125121	212
122284	192	124212	53,353	124381	36	124503	402	124842	14	125122	212
122285	192	124221	53	124382	36	124504	402	124843	14	125123	212
122286	192	124222	53	124385	36	124505	402	124844	14	125124	212
122287	192	124301	35	124386	36	124506	402	124845	15	125131	211
122288	192	124302	35	124387	36	124507	402	124846	15	125132	211
122291	192	124303	35	124388	36	124511	402	124847	14	125133	211
122292	192	124304	35	124401	36	124512	402	124851	15	125134	211
122293	192	124305	35	124404	36	124513	402	124852	15	125141	211
122294	192	124306	35	124411	35	124514	402	124853	15	125142	211
122295	192	124307	35	124412	35	124515	402	124854	15	125143	211
122296	192	124308	35	124413	35	124516	402	124856	15	125144	211
122297	192	124309	35	124414	35	124517	402	124857	15	125151	214
122298	192	124310	34	124415	35	124551	402	124858	15	125152	214
122301	161	124312	34	124431	34	124552	402	124859	15	125153	214
122302	161	124313	34	124432	34	124673	359,396	124861	15	125154	214
122303	161	124314	34	124433	34	124674	359,396	124862	15	125161	207
122401	163	124315	34	124435	34	124704	13	124863	15	125162	207
122402	163	124317	34	124437	34	124709	13	124864	15	125163	207
122403	163	124318	34	124438	34	124714	13	124901	12	125166	207
122404	163	124322	34	124447	39	124801	13	124902	12	125172	209
122405	163	124326	34	124448	39	124802	13	124903	12	125176	209
122406	163	124327	34	124449	39	124803	14	124911	12	125177	209

CÓDIGO	PÁGINA	CÓDIGO	PÁGINA	CÓDIGO	PÁGINA	CÓDIGO	PÁGINA	CÓDIGO	PÁGINA	CÓDIGO	PÁGINA
125181	208	127536	38	128023	383	128448	34	130004	340	130505	74
125186	210	127541	38	128031	381	128501	221	130005	340	130506	74
125187	210	127542	38	128032	381	128502	221	130006	340	130507	74
125301	408	127543	38	128033	381	128503	221	130007	341	130508	74
125302	61,408	127544	38	128041	382	128511	221	130008	341	130511	74
125303	61,408	127545	38	128042	382	128512	221	130009	341	130512	74
125304	61,408	127546	38	128043	382	128601	197	130021	344	130513	74
125305	61	127551	38	128051	382	128602	197	130022	344	130514	74
125306	61	127552	38	128052	382	128603	197	130023	344	130515	74
125307	61,126	127553	38	128053	382	128611	197	130031	344	130521	74
125401	113	127561	39	128061	382	128612	197	130032	344	130523	74
125402	113	127562	39	128071	382	128613	197	130041	341	130531	74
127301	403	127563	39	128072	382	128621	197	130051	343	130532	74
127302	403	127564	39	128081	383	128631	200	130052	344	130533	74
127303	403	127565	39	128082	383	128632	200	130053	343	130534	74
127304	403	127566	39	128091	382	128639	202	130054	343	130535	74
127313	403	127567	39	128092	382	128641	200	130061	342	130541	74
127314	403	127568	39	128093	382	128642	200	130062	342	130542	74
127401	60	127569	39	128101	383	128649	202	130063	342	130543	74
127402	60	127581	40	128102	383	128651	201	130066	342	130544	74
127403	60	127582	40	128111	381	128661	201	130067	342	130545	74
127411	60	127601	105	128121	382	128681	202	130071	342	130551	74
127421	60	127602	105	128122	382	128682	202	130072	342	130552	74
127431	60	127611	105	128123	382	128701	49	130081	342	130553	74
127441	60	127612	105	128131	382	128801	127	130091	343	130554	74
127451	60	127621	103	128141	381	128802	127	130092	343	130555	74
127452	408	127622	103	128142	381	128811	127	130093	343	130556	74
127453	408	127623	103	128143	381	128812	127	130094	343	130557	74
127455	61,409	127631	106	128151	383	128813	127	130095	343	130558	74
127461	61,409	127632	106	128161	383	128814	127	130101	363	130561	74
127462	61,409	127641	104	128171	382	129001	140	130102	363	130562	74
127463	61,409	127642	104	128172	382	129002	140	130111	363	130563	74
127464	61,409	127643	104	128181	382	129004	140	130112	363	130564	74
127465	60	127646	104	128182	382	129006	140	130301	113,363	130571	74
127466	61,409	127647	104	128191	381	129012	140	130302	113,363	130572	74
127501	40	127648	104	128192	381	129014	140	130303	113,363	130573	74
127502	40	127651	104	128193	381	129016	140	130311	113,363	130574	74
127503	40	127652	103	128301	383	129021	141	130312	113,363	130581	74
127504	40	127661	104	128302	383	129023	141	130313	113,363	130582	74
127505	40	127662	104	128303	383	129024	141	130321	113,363	130583	74
127506	40	127663	104	128311	383	129026	141	130322	113,363	130584	74
127521	39	128001	381	128321	383	129032	141	130323	113,363	131001	104
127522	39	128002	381	128331	383	129034	141	130401	116	131002	104
127523	39	128003	381	128391	378,402	129041	141	130402	116	131011	104
127531	38	128011	381	128392	378,402	129043	141	130403	116	131012	104
127532	38	128012	381	128401	49,84	129044	141	130501	74	131101	105
127533	38	128013	381	128411	102	130001	340	130502	74	131102	105
127534	38	128021	383	128446	34	130002	340	130503	74	131103	105
127535	38	128022	383	128447	34	130003	340	130504	74	131104	105

CÓDIGO	PÁGINA	CÓDIGO	PÁGINA	CÓDIGO	PÁGINA	CÓDIGO	PÁGINA	CÓDIGO	PÁGINA	CÓDIGO	PÁGINA
131105	105	131205	106	131322	217	132003	379	132083	380	133808	36
131106	105	131206	106	131323	217	132004	379	132084	380	133809	36
131107	105	131207	106	131401	82	132005	379	132085	380	133901	35,415
131108	105	131208	106	131402	82	132006	379	132086	380	133902	34,415
131109	105	131209	106	131403	82	132011	379	132101	379	133903	34,415
131110	105	131210	106	131404	82	132012	379	132102	379	133904	36,415
131111	105	131211	106	131405	82	132013	379	132103	379	133905	35,415
131112	105	131212	106	131406	82	132014	379	132104	379	133906	35,415
131113	105	131213	106	131407	82	132015	379	132105	379	133907	33
131121	105	131214	106	131411	82	132016	379	132106	379	133908	33
131122	105	131215	106	131412	82	132021	379	132111	379	133999	40
131123	105	131221	106	131413	82	132022	379	132112	379	190101	250
131124	105	131222	106	131414	82	132023	379	132113	379	190102	250
131125	105	131223	106	131415	82	132024	379	132114	379	190121	249
131126	105	131224	106	131416	82	132025	379	132115	379	190123	249
131127	105	131225	106	131417	82	132026	379	132116	379	190151	251
131128	105	131226	106	131421	82	132031	380	133001	35	190201	251
131129	105	131227	106	131422	82	132032	380	133002	35	190302	254
131130	105	131228	106	131423	82	132033	380	133003	35	190305	254
131131	105	131229	106	131424	82	132034	380	133101	33	190321	253
131132	105	131230	106	131425	82	132035	380	133102	33	190324	253
131133	105	131231	106	131426	82	132036	380	133103	33	190325	253
131141	105	131232	106	131427	82	132041	380	133104	33	190401	262
131142	105	131233	106	131501	232	132042	380	133105	33	190402	262
131143	105	131234	106	131502	232	132043	380	133106	33	190411	263
131144	105	131235	106	131503	232	132044	380	133107	33	190412	263
131151	105	131236	106	131504	232	132045	380	133121	33	190451	261
131152	105	131241	106	131511	232	132046	380	133122	33	190452	261
131153	105	131242	106	131512	232	132047	380	133123	33	190501	257
131154	105	131243	106	131513	232	132051	380	133131	33	190502	257
131155	105	131244	106	131514	232	132052	380	133132	33	190503	257
131156	105	131245	106	131601	130	132053	380	133133	33	190521	258
131157	105	131246	106	131602	130	132054	380	133141	33	190522	258
131158	105	131247	106	131603	130	132055	380	133142	33	190551	260
131159	105	131261	106	131621	130	132056	380	133143	33	190571	259
131171	105	131262	106	131622	130	132061	380	133144	33	190581	259
131172	105	131263	106	131623	130	132062	380	133145	33	190601	265
131173	105	131264	106	131701	204	132063	380	133146	33	190651	58,265,373
131174	105	131265	106	131702	204	132064	380	133147	33	190701	264
131175	105	131266	106	131711	204	132065	380	133161	33	190702	264
131176	105	131267	106	131712	204	132066	380	133162	33	190781	264
131177	105	131268	106	131716	205	132071	380	133163	33	190801	271
131178	105	131269	106	131717	205	132072	380	133801	36	190821	247
131179	105	131270	106	131721	205	132073	380	133802	36	190831	271
131180	105	131301	217	131722	205	132074	380	133803	36	190851	247
131201	106	131302	217	131731	206	132075	380	133804	36	190901	268
131202	106	131311	217	131732	206	132076	380	133805	36	190902	269
131203	106	131312	217	132001	379	132081	380	133806	36	190903	268
131204	106	131321	217	132002	379	132082	380	133807	36	190904	269

CÓDIGO	PÁGINA	CÓDIGO	PÁGINA	CÓDIGO	PÁGINA	CÓDIGO	PÁGINA	CÓDIGO	PÁGINA	CÓDIGO	PÁGINA
190907	269	196004	242	197812	252	220152	421	220408	414	220999	418
190908	270	196012	236	197813	252	220153	421	220409	414	221000	422
190909	270	196013	242	197902	300	220154	421	220410	416	221002	422
190991	270	196021	237	197911	296	220161	422	220411	417	221019	419
190992	270	196031	237	197912	296	220181	421	220412	416	221020	424
191001	272	196041	238	197923	296	220182	421	220413	414	230001	424
191002	272	196061	238	197924	297	220183	421	220417	413	230002	424
191003	272	196071	239	197925	297	220184	421	220418	417	230003	424
191004	272	196081	239	197931	299	220186	421	220422	41	230005	424
191021	267	196201	240	197932	299	220187	421	220423	413	230006	424
191031	122,273	196501	245	197933	298	220188	421	220424	414	230007	424
191101	289	196502	245	197934	298	220189	421	220427	413	230011	424
191102	289	196503	245	198001	305	220201	420	220428	413	230012	424
191202	290	196504	245	198002	305	220202	420	220429	55,413	230013	424
191301	279	196505	246	198011	305	220203	420	220430	412	230015	424
191302	279	196511	245	198021	305	220204	420	220435	416	230016	424
191303	279	196512	245	198031	306	220205	420	220438	412	230017	424
191311	278	196513	246	198032	306	220206	420	220440	411	230021	423
191312	278	197001	266	198041	306	220207	420	220441	411	230041	423
191313	278	197002	266,388	198102	307	220208	420	220445	412	230051	424
191321	276	197003	266,388	198111	307	220209	420	220446	411	230052	424
191322	276	197101	281	198112	307	220210	420	220449	412	230071	423
191323	276	197102	281	198201	309	220211	420	220451	418	230072	423
191341	277	197202	256	198202	309	220212	420	220452	418	230091	423
191342	277	197302	256	198301	310	220221	420	220453	418	230092	423
191343	277	197401	255	198302	310	220222	420	220454	418	300101	115
191361	280	197503	283	198311	310	220223	420	220455	418	300102	115
191362	280	197506	283	198321	311	220224	420	220458	418	300103	115
191363	280	197511	282	198401	312	220226	420	220459	418	300104	115
191371	275	197512	282	198411	312	220227	420	220460	418	300105	115
191372	275	197513	282	198502	308	220228	420	220461	418	300106	115
191381	275	197601	287	198511	308	220229	420	220462	414	300107	115
191382	275	197602	287	198512	308	220321	417	220463	411	300131	97,115
191391	281	197611	286	198601	311	220322	417	220464	412	300201	99
191451	255	197612	286	220111	421	220323	417	220505	419	300202	99
191501	302	197631	284	220112	421	220331	415	220509	419	300203	99
191511	303	197632	284	220113	421	220332	415	220511	419	300204	99
191571	303	197633	284	220114	421	220333	415	220514	419	300205	99
191601	267	197641	285	220115	421	220334	415	220516	420	300206	99
191701	292	197651	285	220116	421	220335	416	220517	420	300207	99
191702	292	197652	285	220117	421	220342	416	220518	420	300208	99
191751	291	197691	288	220118	421	220343	416	220585	419	300209	99
191752	291	197692	288	220119	421	220364	412	220586	419	300210	99
191801	301,384	197701	293	220141	421	220371	411	220797	418	300211	99
191803	301,384	197702	293	220142	421	220372	411	220798	418	300212	99
191821	301,384	197703	293	220143	421	220381	413	220991	418	300213	99
191822	301,384	197704	293	220144	421	220387	423	220993	418	300214	99
191823	301,384	197801	252	220145	421	220403	414	220994	418	300215	99
196003	236	197811	252	220151	421	220405	417	220998	418	300216	99

CÓDIGO	PÁGINA	CÓDIGO	PÁGINA	CÓDIGO	PÁGINA	CÓDIGO	PÁGINA	CÓDIGO	PÁGINA	CÓDIGO	PÁGINA
300217	99	301611	121	302201	392	303308	43	303501	231	304512	362
300218	99	301612	121	302202	392	303309	43	303502	231	304513	362
300219	99	301613	121	302301	47	303310	43	303601	67	304514	362
300220	99	301614	121	302302	91	303311	45	303602	67	304515	362
300221	99	301615	121	302303	91	303312	45	303603	67	304516	362
300301	352	301616	121	302304	91	303313	45	303802	387	304517	362
300302	352	301617	121	302305	91	303314	46	303803	387	304518	362
300303	352	301618	121	302306	91	303315	46	303804	387	304519	362
300304	352	301619	121	302307	91	303316	46	303805	387	304520	362
300305	352	301620	121	302312	91	303317	46	303901	364	304521	362
300401	120	301621	121	302313	91	303318	45	303902	364	304522	362
300501	47	301622	121	302422	234	303319	45	304003	95	304602	76
300502	47	301623	121	302423	234	303320	45	304004	95	304603	76
300601	91,365	301624	121	302424	234	303321	45	304011	95	304604	76
300701	90	301625	121	302425	234	303322	45	304101	361	304605	76
300702	90	301631	121	302426	234	303323	45	304102	361	304606	76
300801	365	301632	121	302427	234	303324	45	304103	361	304607	76
300802	365	301633	121	302428	234	303325	45	304104	361	304701	99
300803	365	301640	121	302430	234	303326	45	304105	361	304702	100
300804	365	301641	121	302431	234	303327	45	304106	361	304703	100
300805	365	301642	121	302432	234	303328	45	304107	361	304704	100
300901	92	301643	121	302433	234	303329	45	304108	362	304705	100
300902	92	301644	121	302434	234	303330	45	304301	97	304706	99
300903	92	301645	121	302435	234	303331	45	304302	97	304707	102
300911	92	301801	76	302436	234	303332	45	304303	97	304708	102
300912	92	301802	76	302441	234	303333	45	304304	97	304709	102
301001	48	302001	400	302442	234	303334	45	304305	97	304901	76
301003	48	302011	400	302443	234	303335	45	304306	97	304902	76
301004	48	302021	401	302444	234	303336	45	304307	97	305001	89
301101	122,273	302101	232	302445	234	303337	45	304308	97	305002	89
301201	232	302102	232	302446	234	303338	45	304309	97	305004	89
301202	232	302103	232	302447	234	303339	45	304310	97	305005	89
301203	232	302104	232	302502	117,391	303340	45	304401	128	305006	89
301204	232	302105	232	302503	117,391	303341	45	304402	128	305007	89
301205	232	302106	232	302504	117,391	303342	45	304421	128	305008	89
301206	232	302107	232	302505	117,391	303343	45	304422	128	305009	89
301501	58,370	302108	232	302901	52	303344	45	304423	128	305010	89
301502	58,370	302109	232	302911	52	303345	45	304424	128	305011	89
301503	58,370	302110	232	303101	356	303346	45	304501	362	305012	89
301504	58,370	302111	232	303102	356	303347	45	304502	362	305013	89
301505	58,370	302112	232	303103	356	303348	45	304503	362	305014	89
301506	58,370	302113	232	303104	356	303349	45	304504	362	305021	89
301507	58,370	302114	232	303301	46	303350	45	304505	362	305022	89
301508	58,370	302115	232	303302	46	303351	45	304506	362	305031	89
301509	58,370	302116	232	303303	46	303352	45	304507	362	305032	89
301511	86,372	302117	232	303304	46	303353	45	304508	362	305101	68
301512	86,372	302118	232	303305	43	303354	45	304509	362	305102	68
301514	58,370	302119	232	303306	43	303355	45	304510	362	305103	68
301515	58,370	302120	232	303307	43	303356	45	304511	362	305111	67

CÓDIGO	PÁGINA	CÓDIGO	PÁGINA	CÓDIGO	PÁGINA	CÓDIGO	PÁGINA	CÓDIGO	PÁGINA	CÓDIGO	PÁGINA
305120	68	305525	354	306501	94	307631	347	308392	338,339	309401	397
305121	68	305531	354	306502	94	307632	347	308393	338	309701	220
305122	68	305532	354	306503	94	307633	347	308394	339	309702	220
305123	68	305533	354	306504	94	307641	347	308395	338	309703	220
305124	68	305534	354	306505	94	307642	347	308396	339	309704	220
305125	68	305535	354	306506	94	307643	347	308401	338	309705	220
305130	68	305701	76	306601	124,226	307651	347	308402	338	309706	220
305141	68	305702	76	306651	81	307652	347	308403	338	309707	220
305142	68	305703	76	306701	360	307701	80	308404	338	309708	220
305143	68	305704	76	306702	360	307702	80	308501	111	309801	399
305205	224	305705	76	306901	87	307703	80	308502	111	309802	399
305206	224	305706	76	307001	104	307711	387	308503	111	309803	399
305207	224	305707	76	307002	104	307712	387	308511	111	309901	123,355
305208	220	305708	76	307003	104	307713	387	308512	111	309911	123,355
305209	220	305709	76	307004	104	307801	110	308513	111	309912	123,355
305210	219	305710	76	307101	65	307802	110	308521	111	309913	123,355
305211	218	305711	76	307102	65	307803	110	308522	111	310001	357
305212	219	305712	76	307103	65	307804	110	308523	111	310002	357
305214	219	305713	76	307104	65	307805	110	308601	234	310011	357
305215	219	305714	76	307105	65	307806	110	308602	234	310012	357
305217	220	305715	76	307106	65	307807	110	308701	103	310021	357
305231	223	305716	76	307107	65	307808	110	308702	103	310022	357
305232	223	305717	76	307108	65	307809	110	308801	79	310023	357
305241	216	305801	93	307109	65	307821	110	308802	79	310024	357
305251	222	305802	93	307121	65	307822	110	308811	79	310025	357
305252	222	305911	88	307122	65	307823	110	308812	79	310026	357
305253	222	305912	88	307123	65	307824	110	308902	119	310027	357
305254	222	305913	88	307124	65	307901	126	308903	119	310028	357
305255	222	306001	81,353	307125	65	308001	71	308904	119	310029	357
305261	222	306002	81,353	307126	65	308039	72	308911	119	310030	357
305281	223	306101	231	307127	65	308041	71	309121	368	310031	357
305301	233	306102	231	307128	65	308043	72	309122	368	310041	357
305302	233	306201	127	307129	65	308111	226	309123	368	310042	357
305321	233	306301	364	307201	64	308112	226	309124	368	310043	357
305401	353	306303	364	307202	64	308113	226	309125	368	310044	357
305501	354	306304	364	307203	64	308114	226	309126	368	310045	357
305502	354	306401	314	307204	64	308115	226	309127	368	310046	357
305503	354	306402	314	307205	64	308116	226	309128	368	310047	357
305504	354	306403	313	307206	64	308117	226	309129	368	310048	357
305505	354	306404	313	307401	101	308201	346,390	309130	368	310049	357
305511	354	306405	314	307501	101	308202	346,390	309131	368	310051	357
305512	354	306406	313	307502	101	308203	339	309132	368	310052	357
305513	354	306407	313	307601	347	308301	338	309133	368	310053	357
305514	354	306408	313	307602	347	308302	338	309201	359	310054	357
305515	354	306409	314	307604	347	308303	339	309202	359	310055	357
305521	354	306410	314	307605	347	308304	339	309301	80,123	310056	357
305522	354	306411	314	307606	347	308305	339	309302	80,123	310057	357
305523	354	306412	315	307620	348	308306	339	309303	80,123	310058	357
305524	354	306413	315	307621	348	308391	338,339	309304	80,123	310059	357

CÓDIGO	PÁGINA	CÓDIGO	PÁGINA	CÓDIGO	PÁGINA	CÓDIGO	PÁGINA	CÓDIGO	PÁGINA	CÓDIGO	PÁGINA
310061	357	310442	398	600222	318	612307	323	621306	320	630308	324
310062	357	310443	398	600223	318	612308	323	621309	320	630402	324
310063	357	310444	398	600401	317	612309	323	621310	320	630406	324
310064	357	310451	398	600402	317	612402	323	621401	320	630408	324
310065	357	310461	398	600403	317	612403	323	621404	320	631202	323
310066	357	310462	398	600601	317	612406	323	621406	320	631203	323
310067	357	310471	398	600602	317	612407	323	621409	320	631206	323
310068	357	310472	398	600603	317	612408	323	621410	320	631207	323
310069	357	390101	250	600801	317	612409	323	622201	319	631208	323
310071	357	390102	250	600802	317	613108	324	622206	319	631209	323
310072	357	390301	254	600803	317	613208	324	622208	319	631302	323
310073	357	390401	262	608001	318	613308	324	622301	319	631303	323
310074	357	390501	257	608002	318	613408	324	622306	319	631306	323
310075	357	390701	264	608011	318	614202	321	622308	319	631307	323
310076	357	390781	264	608012	318	614203	321	622401	319	631308	323
310077	357	390801	271	609001	318	614204	321	622406	319	631309	323
310078	357	391202	290	609002	318	614205	321	622408	319	631402	323
310079	357	391301	276	609003	318	614206	321	623202	319	631403	323
310081	357	391401	300	609004	318	614302	321	623206	319	631406	323
310082	357	391402	300	609005	318	614303	321	623207	319	631407	323
310083	357	396101	247	611101	320	614304	321	623208	319	631408	323
310084	357	396111	244	611104	320	614305	321	623302	319	631409	323
310085	357	396112	244	611106	320	614306	321	623306	319	632202	322
310086	357	396121	243	611109	320	614402	321	623307	319	632206	322
310087	357	396122	243	611110	320	614403	321	623308	319	632208	322
310088	357	396211	246	611201	320	614404	321	623402	319	632302	322
310089	357	396212	246	611204	320	614405	321	623406	319	632306	322
310201	363	396551	246	611206	320	614406	321	623407	319	632308	322
310202	363	396552	246	611209	320	615202	322	623408	319	632402	322
310211	363	397401	283	611210	320	615206	322	624202	321	632406	322
310212	363	600001	317	611301	320	615208	322	624203	321	632408	322
310301	77,117	600002	317	611304	320	615302	322	624204	321	641201	325
310302	77,117	600003	317	611306	320	615306	322	624205	321	641202	325
310401	398	600011	317	611309	320	615308	322	624206	321	641205	325
310402	398	600012	317	611310	320	615402	322	624302	321	641206	325
310403	398	600013	317	611401	320	615406	322	624303	321	641207	325
310404	398	600021	317	611404	320	615408	322	624304	321	641208	325
310405	398	600022	317	611406	320	621101	320	624305	321	641301	325
310411	398	600023	317	611409	320	621104	320	624306	321	641302	325
310412	398	600031	317	611410	320	621106	320	624402	321	641305	325
310421	398	600032	317	612202	323	621109	320	624403	321	641306	325
310425	398	600033	317	612203	323	621110	320	624404	321	641307	325
310426	398	600201	318	612206	323	621201	320	624405	321	641308	325
310427	398	600202	318	612207	323	621204	320	624406	321	641401	325
310431	398	600203	318	612208	323	621206	320	630202	324	641402	325
310432	398	600211	318	612209	323	621209	320	630206	324	641405	325
310433	398	600212	318	612302	323	621210	320	630208	324	641406	325
310434	398	600213	318	612303	323	621301	320	630302	324	641407	325
310441	398	600221	318	612306	323	621304	320	630306	324	641408	325

CÓDIGO	PÁGINA	CÓDIGO	PÁGINA	CÓDIGO	PÁGINA	CÓDIGO	PÁGINA	CÓDIGO	PÁGINA	CÓDIGO	PÁGINA
642202	325	654309	326	663206	330	679302	316	800114	407	800923	404
642205	325	654311	326	663301	329	679303	316	800115	407	800924	404
642206	325	655201	325	663302	329	680101	331	800116	407	800925	404
642302	325	655202	325	663306	329	680102	331	800191	61,409	801001	408
642305	325	655205	325	664101	329	680201	332	800201	407	801003	408
642306	325	655206	325	664202	329	680202	332	800301	61,409		
642402	325	655207	325	664206	329	680301	331	800401	406		
642405	325	655208	325	664208	329	680302	331	800402	406		
642406	325	655301	325	664301	329	680303	331	800403	406		
651201	326	655302	325	664302	329	680401	332	800404	406		
651301	326	655305	325	664401	329	680402	332	800405	406		
651401	326	655306	325	664402	329	680403	332	800501	405		
652208	326	655307	325	664501	333	680404	332	800502	407		
652308	326	655308	325	664502	333	680501	332	800504	405		
652408	326	655401	325	664601	328	680502	332	800505	405		
653201	326	655402	325	664602	328	680503	332	800506	405		
653202	326	655405	325	664606	328	680601	331	800508	407		
653205	326	655406	325	664607	328	680602	331	800509	407		
653206	326	655407	325	664608	328	680603	331	800510	405		
653207	326	655408	325	664701	328	680701	331	800511	406		
653208	326	661401	327	664702	328	680801	333	800512	405		
653301	326	661405	327	664801	328	680802	333	800601	405		
653302	326	661407	327	664802	328	680901	333	800602	405		
653305	326	661501	327	664803	328	680902	333	800603	405		
653306	326	661505	327	664901	328	681001	332	800604	405		
653307	326	661507	327	665001	328	681002	332	800605	405		
653308	326	662201	327	665002	328	681003	332	800606	405		
653401	326	662202	327	671301	330	681004	331	800607	405		
653402	326	662205	327	671302	330	681005	333	800608	405		
653405	326	662206	327	671303	330	681006	334	800609	405		
653406	326	662207	327	671304	330	681007	334	800611	405		
653407	326	662208	327	671305	330	681008	334	800612	405		
653408	326	662301	327	671306	330	681101	333	800613	405		
654201	326	662302	327	672301	330	681102	333	800701	408		
654202	326	662305	327	672302	330	681103	333	800702	407		
654203	326	662306	327	672303	330	681104	333	800703	407		
654204	326	662307	327	672304	330	681105	333	800704	407		
654205	326	662308	327	672305	330	681106	334	800705	408		
654206	326	662401	327	672306	330	681107	334	800801	408		
654208	326	662402	327	672401	330	681108	334	800802	408		
654209	326	662405	327	672402	330	681109	331	800901	404		
654211	326	662406	327	672403	330	681110	331	800902	404		
654301	326	662407	327	672404	330	800101	406	800903	404		
654302	326	662408	327	672405	330	800102	406	800904	404		
654303	326	662501	327	672406	330	800103	406	800905	404		
654304	326	663101	330	679101	316	800104	406	800906	404		
654305	326	663102	330	679102	316	800111	407	800911	404		
654306	326	663103	330	679201	316	800112	407	800921	404		
654308	326	663203	330	679301	316	800113	407	800922	404		

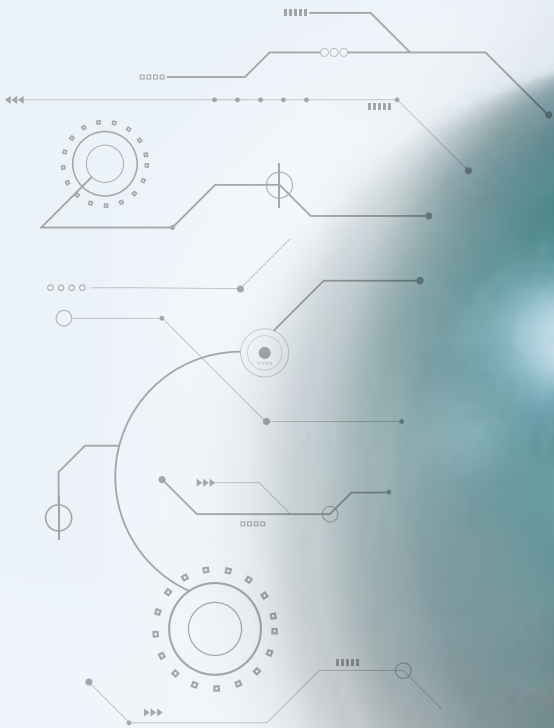

Laboratorios AKSI®



Porque la calidad es nuestra prioridad, en AKSI® te invitamos a conocer sus diferentes laboratorios de calidad.

¡VISÍTANOS!



Cliente AKSI®

Regístrate como nuestro cliente y obtén múltiples beneficios, consulta a nuestros asesores - 55.5383.4412

SABADELL	Beneficiario: No. de Cuenta: Clabe interbancaria: Referencia: su número de cliente más dígito verificador (este dato se lo proporciona su asesor comercial)	AKSI Herramientas S.A. de C.V. 00000240101 156180000002401015 014180655066659468
SANTANDER	Beneficiario: No. de Cuenta: Clabe interbancaria: Referencia: su número de cliente más dígito verificador (este dato se lo proporciona su asesor comercial)	AKSI Herramientas S.A. de C.V. 65-50666594-6 014180655066659468 0002524 + Su número de cliente
BANBAJÍO	Beneficiario: No. de Cuenta: Clabe interbancaria: Referencia: su número de cliente más dígito verificador (este dato se lo proporciona su asesor comercial)	AKSI Herramientas S.A. de C.V. 0380631860201 030456900033287080
BANAMEX	Beneficiario: No. de Cuenta: Sucursal: Clabe interbancaria: Referencia: su número de cliente más dígito verificador (este dato se lo proporciona su asesor comercial)	AKSI Herramientas S.A. de C.V. 7537676 218 002455021875376766
BANORTE	Beneficiario: Clabe interbancaria: CIE: Referencia: su número de cliente más dígito verificador (este dato se lo proporciona su asesor comercial)	AKSI Herramientas S.A. de C.V. 072180006792081302 1663

HSBC

Beneficiario:
Clabe interbancaria:
RAP:
Referencia: su número de cliente más dígito verificador (este dato se lo proporciona su asesor comercial)

AKSI Herramientas S.A. de C.V.
021456040433962418
1052

INBURSA

Beneficiario:
No. de Cuenta:
Clabe interbancaria:
Referencia: su número de cliente más dígito verificador (este dato se lo proporciona su asesor comercial)

AKSI Herramientas S.A. de C.V.
50031237070
036180500312370702

BBVA Bancomer

Beneficiario:
Clabe interbancaria:
CIE:
Referencia: su número de cliente más dígito verificador (este dato se lo proporciona su asesor comercial)

AKSI Herramientas S.A. de C.V.
012180001554540855
794155

Acceso directo a clientes
www.aksi.com.mx/cliente/





☎ 55 5383 4412

📞 +52 55 5383 4412

✉ ventas@aksi.com.mx

aksi.com.mx

Catálogo Décimo Aniversario

Catálogo 2018

Catálogo 2019

Catálogo 2020

Catálogo 2021

Catálogo 2022

Catálogo 23.24



HERRAMIENTA PROFESIONAL

Armándola
Juntos

