

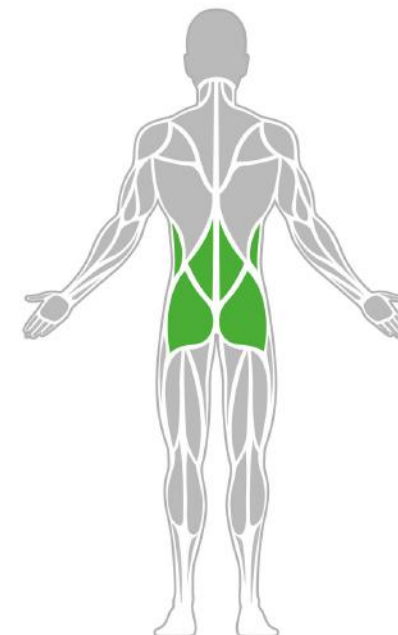

Muscle Groups Focus

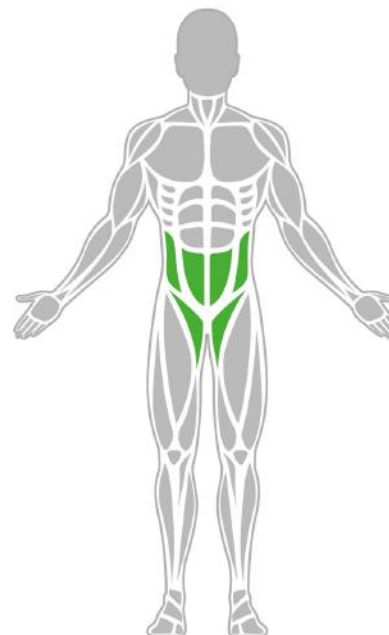

Leg Abductor

This outdoor functional training device helps tone the waist, hip and thigh muscles and improves overall strength, balance and coordination. The leg support allows the user to gently move through the aforementioned muscle groups without straining the joints making this outdoor recreation tool perfect for all age groups.

Attributes

Product code	1-1-301
Certificate	EN 16630, ASTM F3101
Age group	14 + years
Capacity	1 person
Max. weight load	286.60 lbs
Type	Recreational
Difficulty level	Easy

Side View

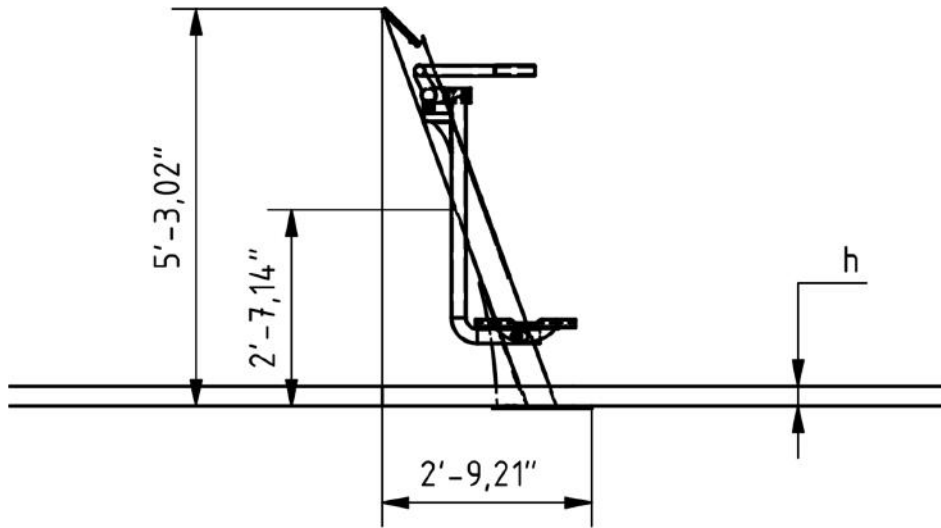

Plan View

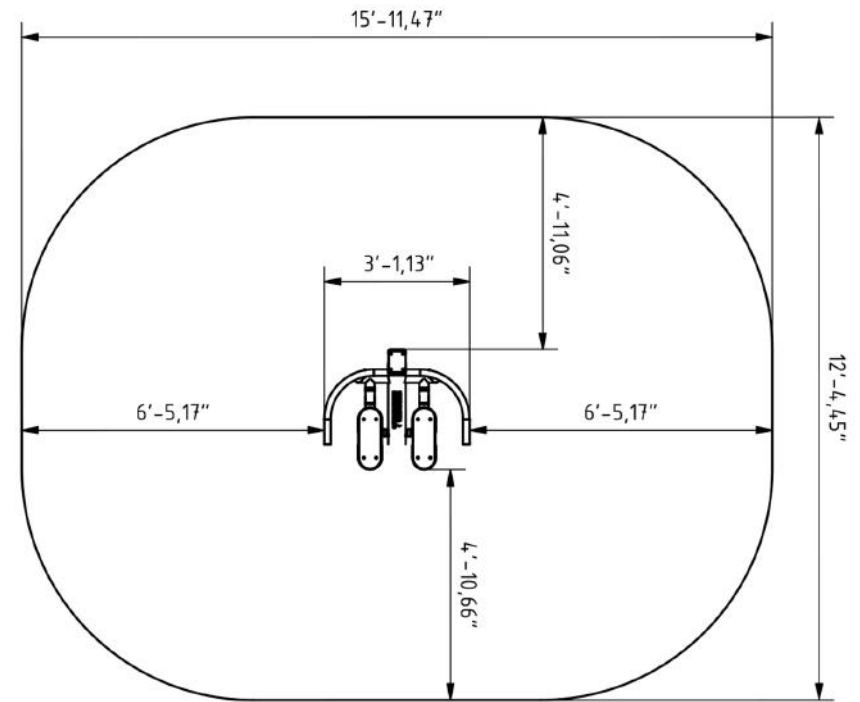

Installation information

Number of installers (concrete)	At least 2 people
Total installation time (concrete)	45-90 min.
Number of installers (equipment)	At least 2 people
Total installation time (equipment)	30-60 min.
Excavation volume	17,66 ft ³
Concrete volume	17,66 ft ³
Size of the base structure	31.5 x 31.5 x 31.5 „
Anchoring options	Surface mounted
In combined structures, the volume of concrete required varies.	

Technical specification

Safety surface area	Around 4.92 ft radius
Net weight	149.91 lbs
Material	S235, KO33
Critic fall height	31.5"
Color options	
For more color options, discuss with your sales representative.	

Warranty

Structure	25 years
Steel	15 years
Paint	2 years
Plastic	5-10 years
Rubber	1-3 years
Moving parts	2 years
Detailed information in the warranty document	

Material specification

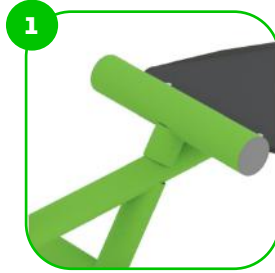

The element is made of high quality S235 steel, which has been cleaned via sandblasting. A corrosion resistant powder coating finish is then applied. Also available with galvanized surface for even greater protection and longevity!



The footrests are made of premium quality non-slip HDPE with a high wear resistance.



The device is equipped with an ergonomic non-slip HDPE phone holder for convenience.

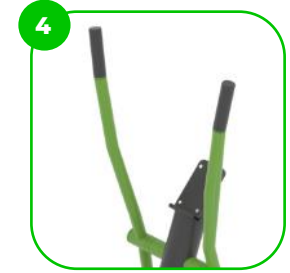

At the end of the arms, the handle is rubber-coated for a more comfortable and secure grip.

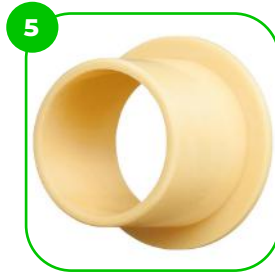

The device is fitted with composite bearings that are weather-resistant. The bearing does not require regular maintenance.



The bumpers of the devices are made of durable rubber material.

BESTRONG

bestrongworld bestrongworld usa.bestrong.com usa@bestrong.com

