

2026



**DALI**



Dali

**EM**



Emergency

**SEN**



HF-Sensor

**PIR**



PIR-Sensor

**ON/OFF**



on/off

**SWI**



CCT switch

**DIM**



TRIAC dimmable

**CE**

**CE**



tunable white



uplight



CASAMBI compatible

## WAND-/DECKENLEUCHE

lampada da parete/soffitto | applique/plafonnier



SLICE CIRCLE  
page 8 - 23



SLICE SQUARE  
page 24 - 30



SLICE 90/120/150  
page 32 - 25



PASO  
page 54 - 57



ATARI  
page 58 - 61

## DECKENLEUCHE

lampada da soffitto | plafonnier

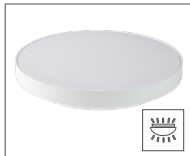

STRIPE+  
page 38



LIVING  
page 40 - 43



SHIFT  
page 44 - 49



BLADE  
page 50 - 53

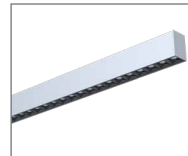

OCULUS OFFICE  
page 62 - 67



ULYSSE UPLIGHT  
page 70 - 79

## PENDELLEUCHE

lampada a sospensione | lampe suspendue



SHIFT  
page 44



BLADE  
page 50

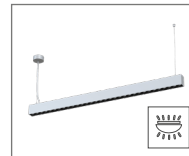

OCULUS  
OFFICE UPLIGHT  
page 63



ULYSSE  
UPLIGHT  
page 70

## STEHLEUCHE

lampada da terra | lampadaire



OCULUS  
OFFICE UPLIGHT  
page 66



NOVA  
UPLIGHT  
page 68

## WANDLEUCHE

lampada da parete | applique

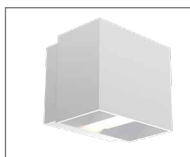

QUADRO  
page 82



FLAT  
page 84



SPHERA  
page 86

## EINBAULEUCHE

faretto da incasso rete | spot encastré



LUNA  
page 88

## INDUSTRIE-/HALLENLEUCHTEN

industria e capanoni | industrie et les entrepôts

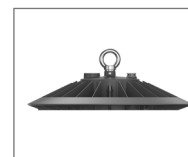

HIRAY  
page 94



LINO  
page 92



# EOLED

Designed & assembled by  Ledeshi

## SLICE.

### **DIE SLICE LEUCHTEN BIETEN IHNEN QUALITÄT, MODERNES DESIGN UND AKTUELLE LED TECHNOLOGIE.**

Die wartungsfreien LED Leuchten sind fast überall einsetzbar. Dank verschiedener Größen, rund oder eckig und verschiedener Funktionen, eignen sie sich für innen und aussen IP54. Einsetzbar in Treppenhäuser, Korridore, Garagen, Terrassen oder auch im Home Bereich. Einfache und schnelle Montage zeichnen unsere Leuchten aus.

### **LE LAMPADE SLICE TI OFFRONO QUALITÀ, DESIGN MODERNO E LA PIÙ RECENTE TECNOLOGIA LED.**

Le luci a LED esenti da manutenzione possono essere utilizzate quasi ovunque. Grazie alle loro diverse dimensioni, tonde o quadrate e alle diverse funzioni, sono adatte per interni ed esterni IP54. Ideali per vano scala, corridoi, garage, terrazze o nell'ambiente domestico. Le nostre luci sono facili e veloci da montare.

### **LES LAMPES SLICE VOUS OFFRENT LA QUALITÉ, UN DESIGN MODERNE ET LA DERNIÈRE TECHNOLOGIE LED.**

Les lampes LED sans entretien peuvent être utilisées presque partout. Grâce à leurs différentes tailles, rondes ou carrées, et à leurs différentes fonctions, elles conviennent à l'intérieur et à l'extérieur IP54. Elles sont idéales pour les cages d'escalier, les couloirs, les garages, les terrasses ou la maison. Nos luminaires sont faciles et rapides à monter.

**EOLED**

Designed & assembled by  **Ledeshi**

# SLICE CIRCLE.

**SLICE  
CIRCLE II N**

Ø220x55 mm / Ø220x48,5 mm



**SLICE  
CIRCLE III N**

Ø270x49 mm

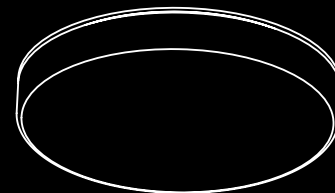

**SLICE  
CIRCLE II N PIR**

Ø220x63 mm

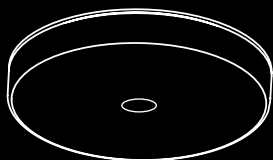

**SLICE  
CIRCLE III N PIR**

Ø270x57 mm

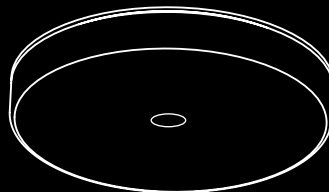

**Seilabhängung**  
Sospensione a filo  
suspension filaire

**SLICE  
CIRCLE IV**

Ø400x63 mm

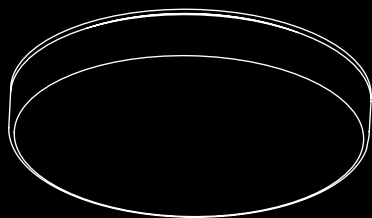

**SLICE  
CIRCLE IV PLUS**

Ø400x65 mm



**UPLIGHT**



**SLICE  
CIRCLE VI**

Ø600x65 mm

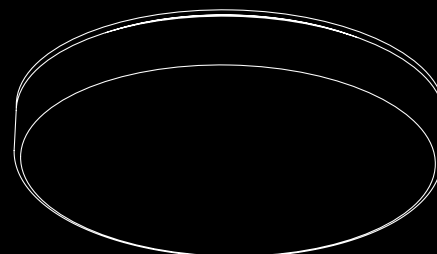



# SLICE N2 II CIRCLE.

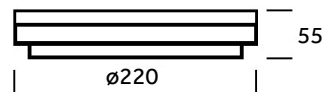

WAND-/DECKENLEUCHT  
 Diffusor opal, Polycarbonat,  
 power switch, color switch,  
 Funktion: ein/aus,  
 dimmbar TRIAC, HF-Sensor, Not

LAMPADA DA PARETE/SOFFITTO  
 diffusore opale, polycarbonato,  
 power switch, color switch,  
 funzione: on/off, dimmerabile TRIAC,  
 rilevatore di movimento, emergenza

APPLIQUE/PLAFONNIER  
 diffuseur opale, polycarbonate,  
 interrupteur, interrupteur de couleur,  
 fonction: on/off, TRIAC dimmable,  
 détecteur de mouvement, urgence

**eOLED**

Designed & assembled by  Ledeshi

## SLICE N2 II CIRCLE



LSH.SLICE2.C.W. <b>3.10W</b>	RCA2.10WW.Q230W	white	Ø220x55mm	10W	3000K	1000lm	IP54	ON/OFF
LSH.SLICE2.C.W. <b>SWI</b>	RCA2.15WW/NW.Q230W	white	Ø220x55mm	10/15W	3000/4000K	1100/1700lm	IP54	ON/OFF
LSH.SLICE2.C.W. <b>SWIDIM</b>	RCA2.15WW/NW.Y230W	white	Ø220x55mm	10/15W	3000/4000K	1100/1700lm	IP54	TRIAC DIM
LSH.SLICE2.C.W. <b>SWISEN</b>	RCA2.15WW/NW.P230W	white	Ø220x55mm	10/15W	3000/4000K	1100/1700lm	IP54	SENSOR
LSH.SLICE2.C.W. <b>SWINOT</b>	RCA2.15WW/NW.E230W	white	Ø220x55mm	10/15W	3000/4000K	1100/1700lm	IP20	EM



**eOLED**

Designed & assembled by  Ledeshi

**SLICE N2 II  
CIRCLE**



LSH.SLICE2.C.S. <b>SWI</b>	RCA2.15WW/NW.Q230S	silver	Ø220x55mm	10/15W	3000/4000K	1100/1700lm	IP54	ON/OFF
LSH.SLICE2.C.S. <b>SWIDIM</b>	RCA1.15WW/NW.Y230W	silver	Ø220x55mm	10/15W	3000/4000K	1100/1700lm	IP54	TRIAC DIM
LSH.SLICE2.C.S. <b>SWISEN</b>	RCA2.15WW/NW.P230S	silver	Ø220x55mm	10/15W	3000/4000K	1100/1700lm	IP54	SENSOR
LSH.SLICE2.C.S. <b>SWINOT</b>	RCA2.15WW/NW.E230S	silver	Ø220x55mm	10/15W	3000/4000K	1100/1700lm	IP20	EM
LSH.SLICE2.C.B. <b>SWI</b>	RCA2.15WW/NW.Q230B	black	Ø220x55mm	10/15W	3000/4000K	1100/1700lm	IP54	ON/OFF
LSH.SLICE2.C.B. <b>SWINOT</b>	SHLS.100.000.01.012.01.NE	black	Ø220x55mm	10/15W	3000/4000K	1100/1700lm	IP20	EM

# SLICE N2 II CIRCLE.

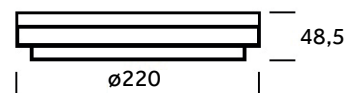

**EOLED**

Designed & assembled by  Ledeshi

## SLICE N2 II CIRCLE

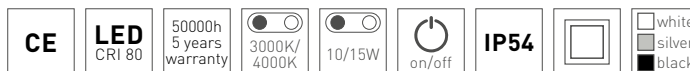

LSH.SLICE2.C.W.SW2	SHLS.100.0000.01.010.02.EA	white	Ø220x48.5mm	10/15W	3000/4000K	1200/1700lm	IP54	ON/OFF
LSH.SLICE2.C.B.SW2	SHLS.100.0000.01.012.02.EA	black	Ø220x48.5mm	10/15W	3000/4000K	1200/1700lm	IP54	ON/OFF
LSH.SLICE2.C.S.SW2	SHLS.100.0000.01.011.02.EA	silver	Ø220x48.5mm	10/15W	3000/4000K	1200/1700lm	IP54	ON/OFF

WAND-/DECKENLEUCHE  
Diffusor opal, Polycarbonat,  
Alu Druckguss, power switch,  
color switch,  
Funktion: ein/aus,

LAMPADA DA PARETE/SOFFITTO  
diffusore opale, polycarbonato,  
alluminio pressofuso,  
power switch, color switch,  
funzione: on/off,

APPLIQUE/PLAFONNIER  
diffuseur opale, polycarbonate,  
aluminium moulé sous pression,  
interrupteur, interrupteur de couleur,  
fonction: on/off

**NEW MODEL**

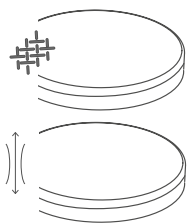

**NEW**

**Alu Druckguss, schmaler Diffusor  
Opal, neue Leuchtenhöhe  
nur mehr 48.5mm.**

**Corpo in pressofusione di alluminio,  
diffusore opale stretto, nuova altezza  
del corpo lampada solo 48,5 mm.**

**Corps en aluminium moulé  
sous pression, diffuseur opale étroit,  
nouvelle hauteur du luminaire  
seulement 48,5 mm.**



# SLICE N2 II PIR CIRCLE.

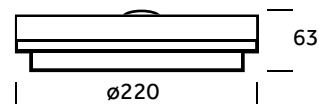

WAND-/DECKENLEUCHE  
Diffusor opal, Aluminium Druckguss  
Funktion: ein/Aus, PIR-Sensor,

LAMPADA DA PARETE/SOFFITTO  
diffusore opale, alluminio pressofuso  
funzione: on/off, sensore infrarossi PIR,

APPLIQUE/PLAFONNIER  
diffuseur opale, aluminium moulé  
sous pression,  
fonction: on/off, PIR Sensor,

**EOLED**

Designed & assembled by  Ledeshi

## SLICE N2 II PIR CIRCLE



LSH.SLICE2.C.W. <b>SWIPIR</b>	RCA2.15WW/NW.R230W	white	Ø220x63mm	10/15W	3000/4000K	1100/1700lm	IP54	PIR SENSOR
LSH.SLICE2.C.S. <b>SWIPIR</b>	RCA2.15WW/NW.R230S	silver	Ø220x63mm	10/15W	3000/4000K	1100/1700lm	IP54	PIR SENSOR
LSH.SLICE2.C.B. <b>SWIPIR</b>	RCA2.15WW/NW.R230B	black	Ø220x63mm	10/15W	3000/4000K	1100/1700lm	IP54	PIR SENSOR

# SLICE N2 III PIR CIRCLE.

WAND-/DECKENLEUCHTE  
Diffusor opal, Aluminium Druckguss  
Funktion: ein/Aus, PIR-Sensor,  
Master Slave

LAMPADA DA PARETE/SOFFITTO  
diffusore opale, alluminio pressofuso  
funzione: on/off, sensore infrarossi PIR,  
Master-Slave

APPLIQUE/PLAFONNIER  
diffuseur opale,  
aluminium moulé sous pression,  
fonction: on/off, PIR Sensor,  
Maitre-Esclave

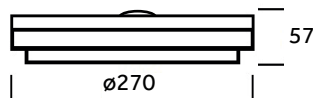

**EOLED**

Designed & assembled by  Ledeshi

## SLICE N2 III PIR CIRCLE



LSH.SLICE.C.W. <b>SWIPIR</b>	RCA2.24WW/NW.R230W	white	Ø270x57mm	10/18/24W	3000/4000K	1100/2100/2600lm	IP54	PIR SENSOR
LSH.SLICE.C.W. <b>SWINOTPIR</b>	SHLS.100.0002.01.010.01.PSNE	silver	Ø270x57mm	10/18/24W	3000/4000K	1100/2100/2600lm	IP20	EM/PIR SENSOR
LSH.SLICE.C.S. <b>SWIPIR</b>	RCA2.24WW/NW.R230S	silver	Ø270x57mm	10/18/24W	3000/4000K	1100/2100/2600lm	IP54	PIR SENSOR
LSH.SLICE.C.B. <b>SWIPIR</b>	RCA2.24WW/NW.R230B	black	Ø270x57mm	10/18/24W	3000/4000K	1100/2100/2600lm	IP54	PIR SENSOR
LSH.SLICE.C.B. <b>SWINOTPIR</b>	SHLS.100.0002.01.012.01.PSNE	black	Ø270x57mm	10/18/24W	3000/4000K	1100/2100/2600lm	IP54	EM/PIR SENSOR

# SLICE N2 III CIRCLE.



WAND-/DECKENLEUCHTE  
Diffusor opal, Polycarbonat,  
Alu Druckguss, power switch,  
color switch,  
Funktion: ein/aus, dimmbar TRIAC,  
Dali, HF-Sensor, Not

LAMPADA DA PARETE/SOFFITTO  
diffusore opale, polycarbonato,  
alluminio pressofuso,  
power switch, color switch  
funzione: on/off, dimmabile  
TRIAC, dali, rilevatore di movimento,  
emergenza

APPLIQUE/PLAFONNIER  
diffuseur opale, polycarbonate,  
aluminium moulé sous pression,  
interrupteur de couleur,  
fonction: on/off, TRIAC dimmable,  
dali, détecteur de mouvement,  
urgence

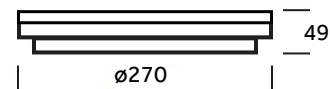

**EOLED**

Designed & assembled by  Ledeshi

## SLICE N2 III CIRCLE



LSH.SLICE.C.W. <b>SWI</b>	RCA2.24WW/NW.Q230W	white	Ø270x49	10/18/24W	3000/4000K	1150/2100/2800lm	IP54	ON/OFF
LSH.SLICE.C.W. <b>SWIDIM</b>	RCA2.24WW/NW.Y230W	white	Ø270x49	10/18/24W	3000/4000K	1150/2100/2800lm	IP54	TRIAC DIM
LSH.SLICE.C.W. <b>SWISEN</b>	RCA2.24WW/NW.P230W	white	Ø270x49	10/18/24W	3000/4000K	1150/2100/2800lm	IP54	SENSOR
LSH.SLICE.C.W. <b>SWINOT</b>	RCA2.24WW/NW.E230W	white	Ø270x49	10/18/24W	3000/4000K	1150/2100/2800lm	IP20	EM
LSH.SLICE.C.W. <b>SWIDAL</b>	RCA2.24WW/NW.D230W	white	Ø270x49	10/18/24W	3000/4000K	1150/2100/2800lm	IP54	DALI
LSH.SLICE.C.W. <b>SWIDALNOT</b>	SHLS.100.0002.0101001.DTDNE	white	Ø270x49	10/18/24W	3000/4000K	1150/2100/2800lm	IP20	DALI/EM

# eOLED

Designed & assembled by  Ledeshi

## SLICE N2 III CIRCLE



LSH.SLICE.C.S. <b>SWI</b>	RCA2.24WW/NW.Q230S	silver	Ø270x49	10/18/24W	3000/4000K	1150/2100/2800lm	IP54	ON/OFF
LSH.SLICE.C.S. <b>SWIDIM</b>	RCA2.24WW/NW.Y230S	silver	Ø270x49	10/18/24W	3000/4000K	1150/2100/2800lm	IP54	TRIAC DIM
LSH.SLICE.C.S. <b>SWISEN</b>	RCA2.24WW/NW.P230S	silver	Ø270x49	10/18/24W	3000/4000K	1150/2100/2800lm	IP54	SENSOR
LSH.SLICE.C.S. <b>SWINOT</b>	RCA2.24WW/NW.E230S	silver	Ø270x49	10/18/24W	3000/4000K	1150/2100/2800lm	IP20	EM
LSH.SLICE.C.S. <b>SWIDAL</b>	RCA2.24WW/NW.D230S	silver	Ø270x49	10/18/24W	3000/4000K	1150/2100/2800lm	IP54	DALI
LSH.SLICE.C.B. <b>SWI</b>	RCA2.24WW/NW.Q230B	black	Ø270x49	10/18/24W	3000/4000K	1150/2100/2800lm	IP54	ON/OFF
LSH.SLICE.C.B. <b>SWISEN</b>	SHLS.100.0002.01.012.01.HS	black	Ø270x49	10/18/24W	3000/4000K	1150/2100/2800lm	IP54	SENSOR
LSH.SLICE.C.B. <b>SWIDIM</b>	RCA2.24WW/NW.Y230B	black	Ø270x49	10/18/24W	3000/4000K	1150/2100/2800lm	IP54	TRIAC DIM
LSH.SLICE.C.B. <b>SWINOT</b>	RCA2.24WW/NW.E230B	black	Ø270x49	10/18/24W	3000/4000K	1150/2100/2800lm	IP20	EM
LSH.SLICE.C.B. <b>SWIDAL</b>	SHLS.100.0002.01.012.01.DTD	black	Ø270x49	10/18/24W	3000/4000K	1150/2100/2800lm	IP54	DALI
LSH.SLICE.C.B. <b>SWIDALNOT</b>	SHLS.100.0002.01.012.01.DTDNE	black	Ø270x49	10/18/24W	3000/4000K	1150/2100/2800lm	IP20	DALI/EM

# SLICE IV CIRCLE.

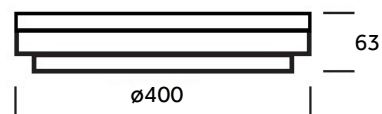

**EOLED**

Designed & assembled by  Ledeshi

## SLICE IV CIRCLE



LSH.SLICE4.C.W. <b>SWIDIM</b>	RCA2.38WW/NW.Y230W	white	Ø400x63mm	29/38W	3000/4000K	3300/4200lm	IP20	TRIAC dim
LSH.SLICE4.C.W. <b>SWIDAL</b>	RCA2.38WW/NW.D230W	white	Ø400x63mm	29/38W	3000/4000K	3300/4200lm	IP20	DALI
LSH.SLICE4.C.W. <b>SWINOT</b>	RCA2.38WW/NW.E230W	white	Ø400x63mm	29/38W	3000/4000K	3300/4200lm	IP20	EM

WAND-/DECKENLEUCHE  
Diffusor opal, Polycarbonat,  
power switch, color switch,  
Funktion: dimmbar TRIAC, Dali, Not

LAMPADA DA PARETE/SOFFITTO  
diffusore opale, polycarbonato,  
power switch, color switch,  
funzione: dimmerabile TRIAC,  
Dali, emergenza

APPLIQUE/PLAFONNIER  
diffuseur opale, polycarbonate,  
interrupteur de couleur,  
fonction: TRIAC gradable, Dali,  
urgence



**EOLED**

Designed & assembled by  **Ledeshi**

**SLICE IV  
CIRCLE**

<b>CE</b>	<b>LED</b> CRI 80	50000h 5 years warranty	 3000K/ 4000K	 29/38W	 TRIAC dim	 1,5h EM	 DALI 2 Push	<b>IP20</b>		<input type="checkbox"/> white <input type="checkbox"/> silver <input type="checkbox"/> black
-----------	----------------------	-------------------------------	---	---	---	---	--	-------------	---	---

LSH.SLICE4.C.S. <b>SWIDIM</b>	RCA2.38WW/NW.Y230S	silver	Ø400x63mm	29/38W	3000/4000K	3300/4200lm	IP20	TRIAC dim
LSH.SLICE4.C.S. <b>SWIDAL</b>	RCA2.38WW/NW.D230S	silver	Ø400x63mm	29/38W	3000/4000K	3300/4200lm	IP20	DALI
LSH.SLICE4.C.S. <b>SWINOT</b>	RCA2.38WW/NW.E230S	silver	Ø400x63mm	29/38W	3000/4000K	3300/4200lm	IP20	EM
LSH.SLICE4.C.B. <b>SWIDIM</b>	RCA2.38WW/NW.Y230B	black	Ø400x63mm	29/38W	3000/4000K	3300/4200lm	IP20	TRIAC dim
LSH.SLICE4.C.B. <b>SWINOT</b>	SHLS.100.0001.01.012.01.NE	black	Ø400x63mm	29/38W	3000/4000K	3300/4200lm	IP20	EM

# SLICE IV PLUS CIRCLE.



**UPLIGHT**

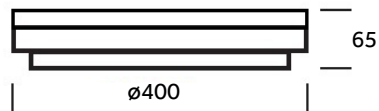

**eOLED**

Designed & assembled by **Ledeshi**

## SLICE IV PLUS CIRCLE

<b>CE</b>	<b>LED</b> CRI 80	50000h 5 years warranty	3000K/ 4000K	24/32W	TRIAC dim	1,5h EM	Sensor	DALI 2 Push	<b>IP54 IP20</b>	uplight	white
-----------	----------------------	-------------------------------	-----------------	--------	-----------	---------	--------	----------------	----------------------	---------	-------

Model	Code	Color	Dimensions	Power	Temp	Beam	IP	Function
LSH.SLICE4+.C.W. <b>SWIDIM</b>	RCP2.32WW/NW.Y230W	white	Ø400x65mm	24/32W	3000/4000K	2800/3600lm	IP54	TRIAC dim
LSH.SLICE4+.C.W. <b>SWISEN</b>	RCP2.32WW/NW.P230W	white	Ø400x65mm	24/32W	3000/4000K	2800/3600lm	IP54	SENSOR
LSH.SLICE4+.C.W. <b>SWINOT</b>	RCP2.32WW/NW.E230W	white	Ø400x65mm	24/32W	3000/4000K	2800/3600lm	IP20	EM
LSH.SLICE4+.C.W. <b>SWIDAL</b>	SHLS.100.0400.01.010.01.DTD	white	Ø400x65mm	24/32W	3000/4000K	2800/3600lm	IP54	DALI
SLICE4+.C.W. <b>SWINOTSEN</b>	RCP2.32WW/NW.EP230W	white	Ø400x65mm	24/32W	3000/4000K	2800/3600lm	IP20	EM/ SENSOR

WAND-/DECKENLEUCHE  
Diffusor opal, Polycarbonat,  
power switch, color switch,  
Indirektlicht schaltbar,  
Funktion: dimmbar TRIAC,  
HF-Sensor, Dali, Not

LAMPADA DA PARETE/SOFFITTO  
diffusore opale, polycarbonato,  
power switch, color switch,  
luce indiretta commutabile,  
funzione: dimmerabile TRIAC,  
rilevatore di movimento, Dali,  
emergenza

APPLIQUE/PLAFONNIER  
diffuseur opale, polycarbonate,  
interrupteur de couleur,  
lumière indirecte commutable,  
fonction: TRIAC gradable,  
détecteur de mouvement, Dali,  
urgence





WAND-/DECKENLEUCHE  
 Diffusor opal, Polycarbonat,  
 power switch, color switch,  
 Funktion: DALI, Not

LAMPADA DA PARETE/SOFFITTO  
 diffusore opale, polycarbonato,  
 power switch, color switch,  
 funzione: Dali, emergenza

APPLIQUE/PLAFONNIER  
 Diffuseur opale, polycarbonate,  
 interrupteur de couleur,  
 fonction: Dali, urgence

LichTec | Beleuchtung & Technik

# SLICE VI CIRCLE.

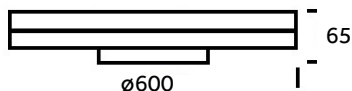

**eOLED**

Designed & assembled by  Ledeshi

## SLICE VI CIRCLE

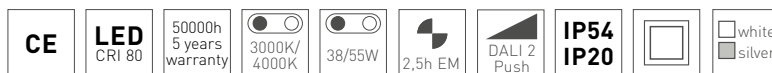

LSH.SLICE6.C.W. <b>SWIDAL</b>	RCA2.55WW/NW.D230W	white	Ø600x65mm	38/55W	3000/4000K	5000/6600lm	IP54	DALI
LSH.SLICE6.C.W. <b>SWINOT</b>	RCA2.55WW/NW.E230W	white	Ø600x65mm	38/55W	3000/4000K	5000/6600lm	IP20	EM
LSH.SLICE6.C.W. <b>SWIDALNOT</b>	RCA2.55WW/NW.DE230W	white	Ø600x65mm	38/55W	3000/4000K	5000/6600lm	IP54	DALI/ EM
LSH.SLICE6.C.S. <b>SWIDAL</b>	RCA2.55WW/NW.D230S	silver	Ø600x65mm	38/55W	3000/4000K	5000/6600lm	IP54	DALI
LSH.SLICE6.C.S. <b>SWINOT</b>	RCA2.55WW/NW.E230S	silver	Ø600x65mm	38/55W	3000/4000K	5000/6600lm	IP20	EM

# EOLED

Designed & assembled by  Ledeshi

# SLICE SQUARE.

## SLICE SQUARE II N

210x210x56 mm

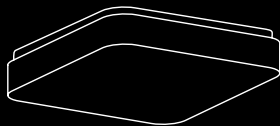

## SLICE SQUARE III N

260x260x52 mm

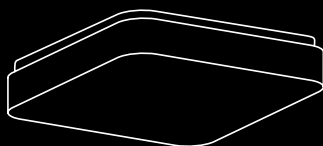

## SLICE SQUARE IV

400x400x63 mm

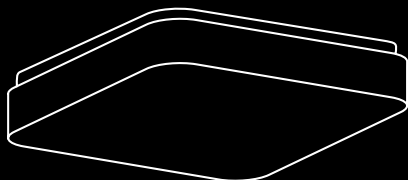

## SLICE 90

900x130x55 mm



## SLICE 120

1200x130x55 mm



## SLICE 150

1500x130x55 mm



### Seilabhängung

Sospensione a filo  
suspension filaire

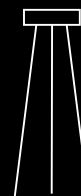



# SLICE N2 II SQUARE.



WAND-/DECKENLEUCHT  
Diffusor opal, Polycarbonat,  
power switch, color switch, Funktion:  
dimmbar TRIAC, HF-Sensor, Not

LAMPADA DA PARETE/SOFFITTO  
diffusore opale, polycarbonato,  
power switch, color switch,  
funzione: dimmabile TRIAC,  
rilevatore di movimento, emergenza

APPLIQUE/PLAFONNIER  
diffuseur opale, polycarbonate,  
interrupteur de couleur,  
fonction: on/off, TRIAC dimmable,  
détecteur de mouvement, urgence

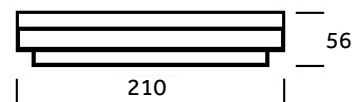

**eOLED**

Designed & assembled by  Ledeshi

## SLICE N2 II SQUARE



LSH.SLICE2.S.S. <b>SWI</b>	RCA1.15WW/NW.Q230S	silver	210x210x56	10/15W	3000/4000K	1100/1600lm	IP54	ON/OFF
LSH.SLICE2.S.S. <b>SWIDIM</b>	RCA1.15WW/NW.Y230S	silver	210x210x56	10/15W	3000/4000K	1100/1600lm	IP54	TRIAC DIM
LSH.SLICE2.S.S. <b>SWISEN</b>	RCA1.15WW/NW.P230S	silver	210x210x56	10/15W	3000/4000K	1100/1600lm	IP54	SENSOR
LSH.SLICE2.S.S. <b>SWINOT</b>	RCA1.15WW/NW.E230S	silver	210x210x56	10/15W	3000/4000K	1100/1600lm	IP20	EM
LSH.SLICE2.S.W. <b>SWI</b>	RCA1.15WW/NW.Q230W	white	210x210x56	10/15W	3000/4000K	1100/1600lm	IP54	ON/OFF
LSH.SLICE2.S.W. <b>SWIDIM</b>	RCA1.15WW/NW.Y230W	white	210x210x56	10/15W	3000/4000K	1100/1600lm	IP54	TRIAC DIM
LSH.SLICE2.S.W. <b>SWISEN</b>	RCA1.15WW/NW.P230W	white	210x210x56	10/15W	3000/4000K	1100/1600lm	IP54	SENSOR
LSH.SLICE2.S.W. <b>SWINOT</b>	RCA1.15WW/NW.E230W	white	210x210x56	10/15W	3000/4000K	1100/1600lm	IP20	EM
LSH.SLICE2.S.B. <b>SWI</b>	RCA1.15WW/NW.Q230B	black	210x210x56	10/15W	3000/4000K	1100/1600lm	IP54	ON/OFF



# SLICE N2 III SQUARE.

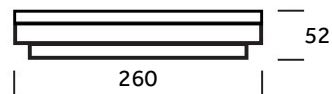

WAND-/DECKENLEUCHTEN  
Diffusor opal, Polycarbonat,  
power switch, color switch,  
Funktion: ein/aus, dimmbar TRIAC,  
HF-Sensor, Not

LAMPADA DA PARETE/SOFFITTO  
diffusore opale, polycarbonato,  
power switch, color switch,  
funzione: on/off, dimmabile  
TRIAC, rilevatore di movimento,  
emergenza

APPLIQUE/PLAFONNIER  
diffuseur opale, polycarbonate,  
interrupteur de couleur,  
fonction: on/off, TRIAC dimmable,  
détecteur de mouvement, urgence

**EOLED**

Designed & assembled by  Ledeshi

## SLICE N2 III SQUARE



LSH.SLICE.S.W. <b>SWI</b>	RCA1.24WW/NW.Q230W	white	260x260x52	10/18/24W	3000/4000K	1150/2100/2800lm	IP54	ON/OFF
LSH.SLICE.S.W. <b>SWIDIM</b>	RCA1.24WW/NW.Y230W	white	260x260x52	10/18/24W	3000/4000K	1150/2100/2800lm	IP54	TRIAC DIM
LSH.SLICE.S.W. <b>SWISEN</b>	RCA1.24WW/NW.P230W	white	260x260x52	10/18/24W	3000/4000K	1150/2100/2800lm	IP54	SENSOR
LSH.SLICE.S.W. <b>SWINOT</b>	RCA1.24WW/NW.E230W	white	260x260x52	10/18/24W	3000/4000K	1150/2100/2800lm	IP20	EM



# EOLED

Designed & assembled by  Ledeshi

## SLICE N2 III SQUARE



LSH.SLICE.S.S. <b>SWI</b>	RCA1.24WW/NW.Q230S	silver	260x260x52	10/18/24W	3000/4000K	1150/2100/2800lm	IP54	ON/OFF
LSH.SLICE.S.S. <b>SWIDIM</b>	RCA1.24WW/NW.Y230S	silver	260x260x52	10/18/24W	3000/4000K	1150/2100/2800lm	IP54	TRIAC DIM
LSH.SLICE.S.S. <b>SWISEN</b>	RCA1.24WW/NW.P230S	silver	260x260x52	10/18/24W	3000/4000K	1150/2100/2800lm	IP54	SENSOR
LSH.SLICE.S.S. <b>SWINOT</b>	RCA1.24WW/NW.E230S	silver	260x260x52	10/18/24W	3000/4000K	1150/2100/2800lm	IP20	EM

# SLICE IV SQUARE.

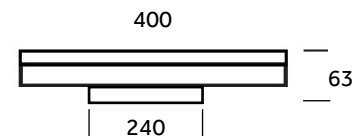

**EOLED**

Designed & assembled by  Ledeshi

## SLICE IV SQUARE



LSH.SLICE4.S.W. <b>SWIDIM</b>	RCA1.38WW/NWY230W	white	400x400x63	29/38W	3000/4000K	3300/4200lm	IP20	TRIAC DIM
LSH.SLICE4.S.W. <b>SWIDAL</b>	RCA1.38WW/NW.D230W	white	400x400x63	29/38W	3000/4000K	3300/4200lm	IP20	DALI
LSH.SLICE4.S.W. <b>SWINOT</b>	RCA1.38WW/NW.E230W	white	400x400x63	29/38W	3000/4000K	3300/4200lm	IP20	EM
LSH.SLICE4.S.S. <b>SWIDIM</b>	RCA1.38WW/NWY230S	silver	400x400x63	29/38W	3000/4000K	3300/4200lm	IP20	TRIAC DIM
LSH.SLICE4.S.S. <b>SWIDAL</b>	RCA1.38WW/NW.D230S	silver	400x400x63	29/38W	3000/4000K	3300/4200lm	IP20	DALI
LSH.SLICE4.S.S. <b>SWINOT</b>	RCA1.38WW/NW.E230S	silver	400x400x63	29/38W	3000/4000K	3300/4200lm	IP20	EM

WAND-/DECKENLEUCHTE  
Diffusor opal, Polycarbonat,  
power switch, color switch,  
Funktion: dimmbar TRIAC, Dali, Not

LAMPADA DA PARETE/SOFFITTO  
diffusore opale, polycarbonato,  
power switch, color switch,  
funzione: dimmerabile TRIAC,  
Dali, emergenza

APPLIQUE/PLAFONNIER  
diffuseur opale, polycarbonate,  
interrupteur de couleur,  
fonction: TRIAC gradable,  
Dali, urgence



# SLICE 90.

WAND-/DECKENLEUCHTE  
Diffusor opal, Polycarbonat,  
power switch, color switch,  
Funktion: dimmbar TRIAC, Dali,  
HF-Sensor, Not

LAMPADA DA PARETE/SOFFITTO  
diffusore opale, polycarbonato,  
power switch, color switch,  
funzione: dimmerabile TRIAC,  
Dali, emergenza

APPLIQUE/PLAFONNIER  
diffuseur opale, polycarbonate,  
interrupteur de couleur,  
fonction: TRIAC dimmable,  
Dali, urgence

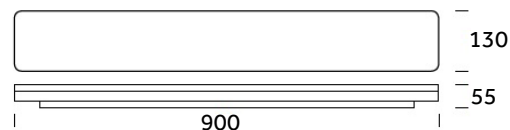

**EOLED**

Designed & assembled by **Ledeshi**

**SLICE  
90**



LSH.SLICE90.W.SWI	RCL.32WW/NW900.Q230W	white	900x130x55	24/32W	3000/4000K	2700/3500lm	IP54	ON/OFF
LSH.SLICE90.W.SWIDIM	RCL.32WW/NW900.Y230W	white	900x130x55	24/32W	3000/4000K	2700/3500lm	IP54	TRIAC DIM
LSH.SLICE90.W.SWIDAL	RCL.32WW/NW900.D230W	white	900x130x55	24/32W	3000/4000K	2700/3500lm	IP54	DALI
LSH.SLICE90.W.SWIEN	RCL.32WW/NW900.P230W	white	900x130x55	24/32W	3000/4000K	2700/3500lm	IP54	SENSOR
LSH.SLICE90.S.SWIDIM	RCL.32WW/NW900.Y230S	silver	900x130x55	24/32W	3000/4000K	2700/3500lm	IP54	TRIAC DIM



C1

C1

# SLICE 120.

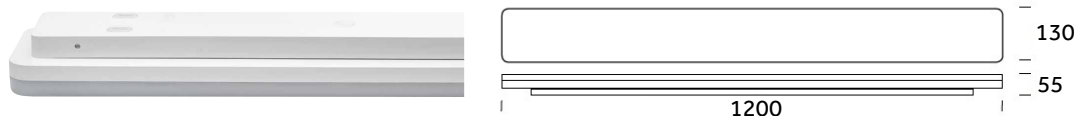

WAND-/DECKENLEUCHTE  
Diffusor opal, Polycarbonat,  
power switch, color switch,  
Funktion: dimmbar TRIAC,  
Dali, HF-Sensor, Not

LAMPADA DA PARETE/SOFFITTO  
diffusore opale, polycarbonato,  
power switch, color switch,  
funzione: dimmerabile TRIAC,  
Dali, rilevatore di movimento,  
emergenza

APPLIQUE/PLAFONNIER  
diffuseur opale, polycarbonate,  
interrupteur de couleur,  
fonction: TRIAC dimmable, Dali,  
détecteur de mouvement, urgence

**EOLED**

Designed & assembled by  Ledeshi

## SLICE 120



LSH.SLICE120.W. <b>SWI</b>	RCL.38WW/NW1200.Q230W	white	1200x130x55	29/38W	3000/4000K	3200/4200lm	IP54	ON/OFF
LSH.SLICE120.W. <b>SWIDIM</b>	RCL.38WW/NW1200.Y230W	white	1200x130x55	29/38W	3000/4000K	3200/4200lm	IP54	TRIAC DIM
LSH.SLICE120.W. <b>SWIDAL</b>	RCL.38WW/NW1200.D230W	white	1200x130x55	29/38W	3000/4000K	3200/4200lm	IP54	DALI
LSH.SLICE120.W. <b>SWISEN</b>	RCL.38WW/NW1200.P230W	white	1200x130x55	29/38W	3000/4000K	3200/4200lm	IP54	SENSOR
LSH.SLICE120.W. <b>SWINOT</b>	RCL.38WW/NW1200.E230W	white	1200x130x55	29/38W	3000/4000K	3200/4200lm	IP20	EM

WAND-/DECKENLEUCHTE  
Diffusor opal, Polycarbonat,  
Power switch, Color switch,  
Funktion: dimmbar TRIAC, Dali

LAMPADA DA PARETE/SOFFITTO  
diffusore opale, polycarbonato,  
power switch, color switch,  
funzione: dimmerabile TRIAC, Dali

APPLIQUE/PLAFONNIER  
diffuseur opale, polycarbonate,  
interrupteur, interrupteur de couleur,  
fonction: TRIAC dimmable, Dali

# SLICE 150.

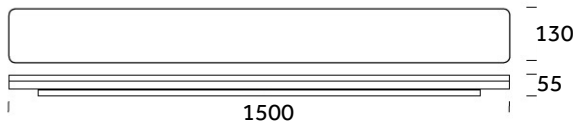

## EOLED

Designed & assembled by  Ledeshi

### SLICE 150

CE	LED CRI 80	50000h 5 years warranty	3000K/ 4000K	30/40/ 50W	TRIAC dim	DALI 2 Push	IP54		 on/off	<input type="checkbox"/> white
----	---------------	-------------------------------	-----------------	---------------	-----------	----------------	------	---	---	--------------------------------

LSH.SLICE150.W. <b>SWIDIM</b>	RCL.50WW/NW1500.D230W	white	1500x130x55	30/40/50W	3000/4000K	3500/4500/ 5800lm	IP54	TRIAC DIM
LSH.SLICE150.W. <b>SWIDAL</b>	RCL.50WW/NW1500.Y230W	white	1500x130x55	30/40/50W	3000/4000K	3500/4500/ 5800lm	IP54	DALI

# SLICE ZUBEHÖR.

accessori | accessoires

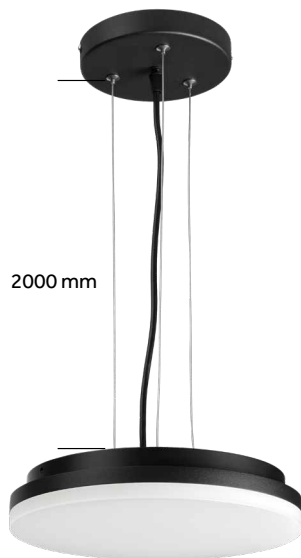

2000 mm

**EOLED**

Designed & assembled by  Ledeshi

## SEILABHÄNGUNG

suspensione a filo | suspension filaire



LSH.PENDEL.B.270	SLICE3	black	L-2000mm	ON/OFF
LSH.PENDEL.W.270	SLICE3	white	L-2000mm	ON/OFF
LSH.PENDEL.B.400	SLICE4	black	L-2000mm	ON/OFF
LSH.PENDEL.W.400	SLICE4	white	L-2000mm	ON/OFF
LSH.PENDEL.B.600	SLICE6	black	L-2000mm	ON/OFF
LSH.PENDEL.W.600	SLICE6	white	L-2000mm	ON/OFF
LSH.PENDEL.B.600.DAL	SLICE6	black	L-2000mm	DALI
LSH.PENDEL.W.600.DAL	SLICE6	white	L-2000mm	DALI
LSH.PENDEL.B.LONG	90/120/150	black	L-2000mm	ON/OFF
LSH.PENDEL.W.LONG	90/120/150	white	L-2000mm	ON/OFF



SLICE3



SLICE4



SLICE6



LONG

## ERSATZAKKU

### Batteria di ricambio | Batterie de remplacement

Kompatibel mit Leuchten ab 06/2022. Ältere Modelle auf Anfrage.

Compatibile con apparecchi di illuminazione a partire da 06/2022. Modelli più vecchi su richiesta.

Compatible avec les luminaires à partir de 06/2022. Modèles plus anciens sur demande.



CE

LSH.999.001	Lithium 500mAh 9.6V	SLICE N2 II, SLICE N2 III, SLICE IV, SLICE 90, SLICE 120, STRIPE+
LSH.999.002	Lithium 1000mAh 9.6V	SLICE VI

## CASAMBI FERNBEDIENUNG & MODUL

### Telecomando & modulo | Télécommande & module

CASAMBI Fernbedienung, weiss  
ØxHDrehkopf: 53x20mm  
5 Taster & 1 Drehregler

CASAMBI Telecomando, bianco  
ØxH testina girevole: 53x20mm  
5 pulsanti e 1 manopola

CASAMBI Télécommande, blanche  
Ø x H tête rotative : 53 x 20 mm  
5 boutons et 1 molette

CASAMBI Modul  
Dimmbar: DALI2 & 0/1-10V  
Info 1: Inkl. Relay (5A)

CASAMBI Modulo  
Dimmerabile: DALI2 e 0/1-10V  
relè incluso (5 A)

CASAMBI module  
Intensité variable : DALI2 & 0/1-10 V  
relais inclus (5 A)

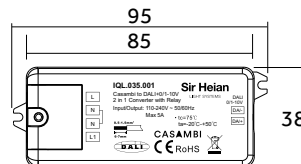
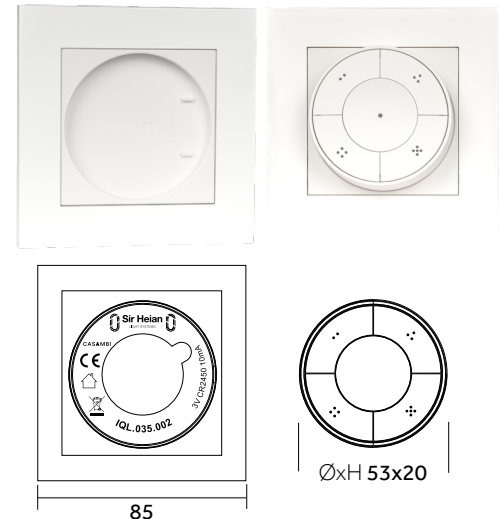

Casambi <b>Fernbedienung</b> Telecomando   Télécommande	IQL.035.002	white	LxBxH Base: 85x85x10mm ØxH: 53x20mm	IP20	
Casambi <b>Modul</b> Modulo   Module	IQL.035.001		LxBxH: 95x38x20mm	IP20	DALI2 & 0/1-10V

# STRIPE+

**Die STRIPE+ LED-Deckenleuchte verbindet schlichtes Design mit innovativer Technik.**

Sie verfügt über eine umschaltbare Farbtemperatur und Leistung, sowie IP54-Schutz gegen Feuchtigkeit. Das indirekte Licht sorgt für sanfte und gleichmäßige Beleuchtung.

**La plafoniera a LED STRIPE+ unisce un design semplice a una tecnologia innovativa.**

Dispone di una temperatura del colore e di una potenza regolabili, oltre a una protezione IP54 contro l'umidità. La luce indiretta garantisce un'illuminazione morbida e uniforme.

**Le plafonnier LED STRIPE+ combine design épuré et technologie innovante.**

Il offre une température de couleur et une puissance ajustables, ainsi qu'une protection IP54 contre l'humidité. La lumière indirecte garantit un éclairage doux et homogène.



WAND-/DECKENLEUCHTE  
Diffusor opal, Polycarbonat und Alu  
Power switch, Color switch,  
Funktion: dimmbar TRIAC, Dali,

LAMPADA DA PARETE/SOFFITTO  
diffusore opale, polycarbonato e  
alluminio, power switch, color switch,  
funzione: dimmerabile TRIAC, Dali,

APPLIQUE/PLAFONNIER  
diffuseur opale, polycarbonate et  
aluminium, interrupteur, interrupteur de  
couleur, fonction: TRIAC gradable, Dali,

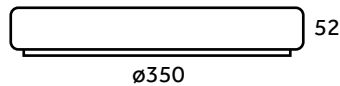

UPLIGHT



EOLED

Designed & assembled by  Ledeshi

STRIPE+

CE	LED CRI 90	50000h 5 years warranty	 3000K/ 4000K	 18/24/ 32W	IP54	IK10	 uplight		 TRIAC dim	 DALI 2 Push	<input type="checkbox"/> white <input type="checkbox"/> black brushed
----	---------------	-------------------------------	---	---	------	------	---	---	---	--	---

LSH.STRIPE+.F.BB. <b>SWIDAL</b>	SHLS.100.0100.01.112.01.DTD	black brushed	Ø350x52	18/24/32W	3000/4000K	2150/2750/3550lm	IP54	DALI
LSH.STRIPE+.F.BB. <b>SWIDIM</b>	SHLS.100.0100.01.112.01.PD	black brushed	Ø350x52	18/24/32W	3000/4000K	2150/2750/3550lm	IP54	TRIAC
LSH.STRIPE+.F.BB. <b>SWINOT</b>	SHLS.100.0100.01.112.01.NE	black brushed	Ø350x52	18/24/32W	3000/4000K	2150/2750/3550lm	IP20	NOT
LSH.STRIPE+.F.W. <b>SWIDIM</b>	RCE.2.32WW/NWY230W	white	Ø350x52	18/24/32W	3000/4000K	2150/2750/3550lm	IP54	TRIAC
LSH.STRIPE+.F.W. <b>SWIDAL</b>	SHLS.100.0100.01.010.01.DTD	white	Ø350x52	18/24/32W	3000/4000K	2150/2750/3550lm	IP54	DALI
LSH.STRIPE+.F.W. <b>SWINOT</b>	SHLS.100.0100.01.010.01.NE	white	Ø350x52	18/24/32W	3000/4000K	2150/2750/3550lm	IP20	NOT

# EOLED

Designed & assembled by  Ledeshi

# LIVING.

## UPLIGHT



### LIVING 4

Ø430x115 mm

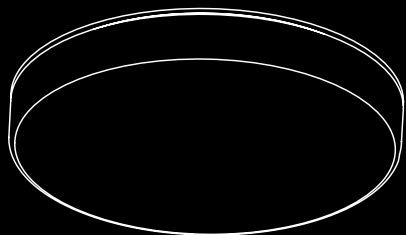

### LIVING 6

Ø630x115 mm

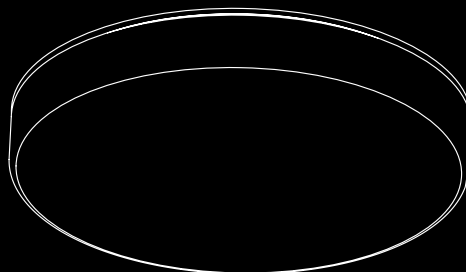

# LIVING.

Diese Deckenleuchte integriert sich dank einem Stoffschirm als wahres Designstück in Wohnzimmer, Schlafzimmer oder Hotelzimmer. **Erhältlich als dimmbare Variante oder mit Sensor.**

Questa lampada da soffitto si integra come un vero e proprio pezzo di design nel soggiorno, nella camera da letto o nella stanza d'albergo grazie al paralume in tessuto. **Disponibile in versione dimmerabile o con sensore.**

Ce plafonnier s'intègre comme une véritable pièce de design dans le salon, la chambre à coucher ou la chambre d'hôtel grâce à son abat-jour en tissu. **Disponibile en version dimmable ou à détecteur.**



# LIVING 4.



taupe



Umбра

## UPLIGHT



Weitere Stoff-Farben auf Anfrage  
Altri colori di tessuto su richiesta  
Autres couleurs de tissu sur demande

## EOLED

Designed & assembled by  Ledeshi

### LIVING 4



LSH.LIVING4.7166. <b>DIM</b>	taupe	Ø430x115mm	24/32W	3000/4000K	2240/2560lm	IP20	TRIAC DIM
LSH.LIVING4.7166. <b>SEN</b>	taupe	Ø430x115mm	24/32W	3000/4000K	2240/2560lm	IP20	SENSOR
LSH.LIVING4.7167. <b>DIM</b>	Umбра	Ø430x115mm	24/32W	3000/4000K	2240/2560lm	IP20	TRIAC DIM
LSH.LIVING4.7167. <b>SEN</b>	Umбра	Ø430x115mm	24/32W	3000/4000K	2240/2560lm	IP20	SENSOR



### DECKENLEUCHTE

Diffusor opal, Polycarbonat und Stoff,  
Power switch, Color switch,  
Funktion: dimmbar TRIAC, HF-Sensor

### LAMPADA DA SOFFITTO

diffusore opale, polycarbonato e  
tessuto, power switch, color switch  
funzione: dimmerabile TRIAC,  
rilevatore di movimento

### PLAFONNIER

diffuseur opale, polycarbonate et tissu,  
interrupteur, interrupteur de couleur,  
fonction: TRIAC gradable, détecteur de  
mouvement

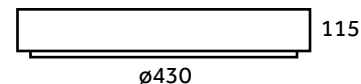

# LIVING 6.

## DECKENLEUCHTE

Diffusor opal, Polycarbonat und Stoff,  
Power switch, Color switch,  
Funktion: Dali

## LAMPADA DA SOFFITTO

diffusore opale, polycarbonato e  
tessuto, power switch, color switch  
funzione: Dali

## PLAFONNIER

diffuseur opale, polycarbonate et tissu,  
interrupteur, interrupteur de couleur,  
fonction: Dali

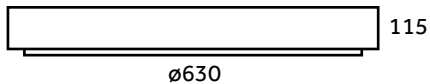

taupe



Umbra



Weitere Stoff-Farben auf Anfrage  
Altri colori di tessuto su richiesta  
Autres couleurs de tissu sur demande



**EOLED**

Designed & assembled by **Ledeshi**

**LIVING 6**

<b>CE</b>	<b>LED</b> CRI 80	50000h 5 years warranty	3000K/ 4000K	38/55W	DALI	<b>IP20</b>		taupe Umbra
-----------	----------------------	-------------------------------	-----------------	--------	------	-------------	--	----------------

LSH.LIVING6.7166.DAL	taupe	Ø630x115mm	38/55W	3000/4000K	4000/5280lm	IP20	DALI		
LSH.LIVING6.7167.DAL	Umbra	Ø630x115mm	38/55W	3000/4000K	4000/5280lm	IP20	DALI		

# EOLED

Designed & assembled by  Ledeshi

# SHIFT.

## UPLIGHT



### SHIFT 3+

ØxH: 320x64/79 mm

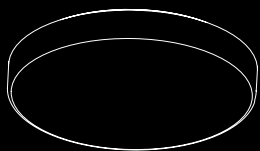

### SHIFT 4+

ØxH: 450x64/79 mm

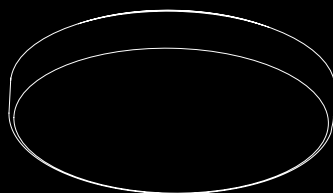

### SHIFT 6+

ØxH: 600x64/79mm

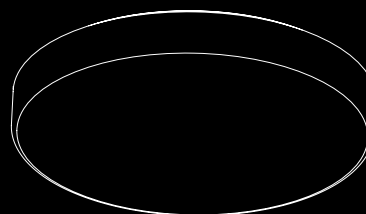

Seilabhängung  
mit Baldachin

Sospensione a filo  
suspension filaire

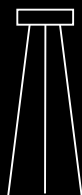

# SHIFT.

**Entdecken Sie unsere neueste Deckenleuchte SHIFT – ein klassisches Design, das sich durch unübertroffene Vielseitigkeit auszeichnet.** Mit mikroprismatischer Abdeckung erfüllt Sie die UGR-Anforderungen für blendfreies Arbeiten. Die werkzeuglose Verstellbarkeit von 64 auf 79 mm macht sie vielseitig und perfekt an unterschiedliche Raumgegebenheiten anpassbar und ermöglicht volle Kontrolle über direkte und indirekte Beleuchtung. Effizienz und Komfort – unsere Deckenleuchte SHIFT definiert Funktionalität und Stil in Büroumgebungen neu.

**Scopri la nostra ultima lampada da soffitto SHIFT - un design classico che si distingue per la sua versatilità senza eguali.** Con una copertura microprismatica che soddisfa i requisiti UGR per un lavoro privo di abbagliamento. La regolazione senza attrezzi da 64 a 79 mm la rende versatile e perfettamente adattabile a diverse configurazioni di spazio, consentendo un controllo totale sull'illuminazione diretta e indiretta. Efficienza e comfort - la nostra lampada da soffitto SHIFT ridefinisce la funzionalità e lo stile negli ambienti di lavoro.

**Découvrez notre dernière suspension SHIFT - un design classique qui se distingue par sa polyvalence inégalée.** Avec son couvercle microprismatique, elle répond aux exigences UGR pour un travail sans éblouissement. Sa possibilité d'ajustement sans outil de 64 à 79 mm la rend polyvalente et parfaitement adaptable à différentes configurations d'espace, tout en offrant un contrôle total sur l'éclairage direct et indirect. Efficacité et confort - notre suspension SHIFT redéfinit la fonctionnalité et le style dans les environnements de bureau.



# SHIFT.



werkzeuglos höhenverstellbar  
regolazione senza attrezzi  
possibilité d'ajustement sans outil



## eOLED

Designed & assembled by Ledeshi

### SHIFT 3+

<b>CE</b>	<b>LED</b> CRI 90	50000h 5 years warranty	3000K/ 4000K	10/18/ 24W	on/off	DALI 2 Push	<b>IP20</b>	IK07	1,5h EM	<b>UGR</b> <19 Micro- prismatic	uplight		McAdam ≤3
-----------	----------------------	-------------------------------	-----------------	---------------	--------	----------------	-------------	------	---------	--	---------	--	--------------



LSH.SHIFT3+ <b>C.B.SWI</b>	RCS2.24WW/NW.Q230B	black	320x64/79mm	10/18/24W	3000/4000K	920/1600/2100lm	IP20	ON/OFF
LSH.SHIFT3+ <b>C.W.SWI</b>	RCS2.24WW/NW.Q230W	white	320x64/79mm	10/18/24W	3000/4000K	920/1600/2100lm	IP20	ON/OFF
LSH.SHIFT3+ <b>C.B.SWIDAL</b>	SHLS.100.0300.01.012.01.DTD	black	320x64/79mm	10/18/24W	3000/4000K	920/1600/2100lm	IP20	DALI
LSH.SHIFT3+ <b>C.W.SWIDAL</b>	SHLS.100.0300.01.010.01.DTD	white	320x64/79mm	10/18/24W	3000/4000K	920/1600/2100lm	IP20	DALI
LSH.SHIFT3+ <b>C.W.SWINOT</b>	SHLS.100.0300.01.010.01.NE	white	320x64/79mm	10/18/24W	3000/4000K	920/1600/2100lm	IP20	EM

#### DECKENLEUCHTE

Diffusor Mikroprisma, Aluminium,  
direkt/indirekt strahlend, LED,  
weiß oder schwarz, Funktion: ein/aus, DALI

#### LAMPADA DA SOFFITTO

diffusore microprismatico, alluminio,  
luce diretta/ indiretta, LED,  
bianco o nero, funzione: on/off, DALI

#### PLAFONNIER

diffuseur microprismatique, aluminium,  
lumière directe/indirecte, LED,  
blanc ou noir, fonction: on/off, DALI

werkzeuglos höhenverstellbar  
regolazione senza attrezzi  
possibilité d'ajustement sans outil

LichTec | Beleuchtung & Technik

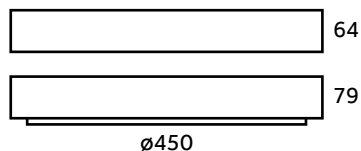

# SHIFT.



## UPLIGHT



### EOLED

Designed & assembled by Ledeshi

#### SHIFT 4+



LSH.SHIFT4+ <b>C.B.SWI</b>	RCS2.30WW/NW.Q230B	black	450x64/79mm	17/22/30W	3000/4000K	1800/2300/3100lm	IP20	ON/OFF
LSH.SHIFT4+ <b>C.W.SWI</b>	RCS2.30WW/NW.Q230W	white	450x64/79mm	17/22/30W	3000/4000K	1800/2300/3100lm	IP20	ON/OFF
LSH.SHIFT4+ <b>C.B.SWIDAL</b>	SHLS.100.0301.01.012.01.DTD	black	450x64/79mm	17/22/30W	3000/4000K	1800/2300/3100lm	IP20	DALI
LSH.SHIFT4+ <b>C.W.SWIDAL</b>	SHLS.100.0301.01.010.01.DTD	white	450x64/79mm	17/22/30W	3000/4000K	1800/2300/3100lm	IP20	DALI

LSH.BL4 <b>BB</b>	SHZB.100.0201.01.112.01	black brushed	ØxH: 450x64mm
LSH.BL4 <b>BG</b>	SHZB.100.0201.01.114.01	gold brushed	ØxH: 450x64mm
LSH.BL4 <b>BS</b>	SHZB.100.0201.01.111.01	silver brushed	ØxH: 450x64mm
LSH.BL4 <b>BV</b>	SHZB.100.0201.01.115.01	violet brushed	ØxH: 450x64mm

### BLENDE DEKORRING

Anello decorativo | Anneau décoratif



**NEW**

# SHIFT.



werkzeuglos höhenverstellbar  
regolazione senza attrezzi  
possibilité d'ajustement sans outil

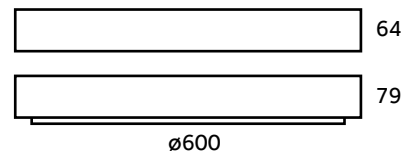

## UPLIGHT



### SHIFT 6+

<b>CE</b>	<b>LED</b> CRI 90	50000h 5 years warranty	3000K/ 4000K	38/55W	on/off	DALI 2 Push	<b>IP20</b>	IK07	<b>UGR &lt;19</b> Micro- prismatic	uplight	McAdam ≤3	white black
-----------	----------------------	-------------------------------	-----------------	--------	--------	----------------	-------------	------	--	---------	--------------	----------------

LSH.SHIFT6+ <b>C.B.SWI</b>	RCS2.55WW/NW.Q230B	black	600x64/79mm	38/55W	3000/4000K	4000/5500lm	IP20	ON/OFF
LSH.SHIFT6+ <b>C.W.SWI</b>	RCS2.55WW/NW.Q230W	white	600x64/79mm	38/55W	3000/4000K	4000/5500lm	IP20	ON/OFF
LSH.SHIFT6+ <b>C.B.SWIDAL</b>	SHLS.100.0302.01.012.01.DTD	black	600x64/79mm	38/55W	3000/4000K	4000/5500lm	IP20	DALI
LSH.SHIFT6+ <b>C.W.SWIDAL</b>	SHLS.100.0302.01.010.01.DTD	white	600x64/79mm	38/55W	3000/4000K	4000/5500lm	IP20	DALI

LSH.BL6 <b>BB</b>	SHZB.100.0200.01.112.01	black brushed	ØxH: 600x64mm
LSH.BL6 <b>BG</b>	SHZB.100.0200.01.114.01	gold brushed	ØxH: 600x64mm
LSH.BL6 <b>BS</b>	SHZB.100.0200.01.111.01	silver brushed	ØxH: 600x64mm
LSH.BL6 <b>BV</b>	SHZB.100.0201.01.115.01	violet brushed	ØxH: 600x64mm

### BLENDE DEKORRING

Anello decorativo | Anneau décoratif



Seilabhängung mit Baldachin  
 Sospensione a filo  
 suspension filaire

LichTec | Beleuchtung & Technik

# SHIFT. PENDEL.

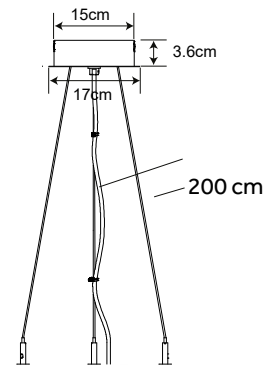
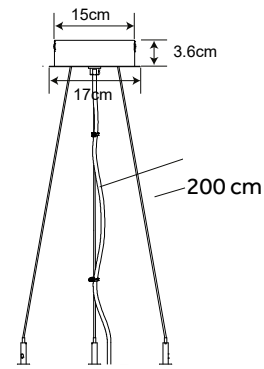
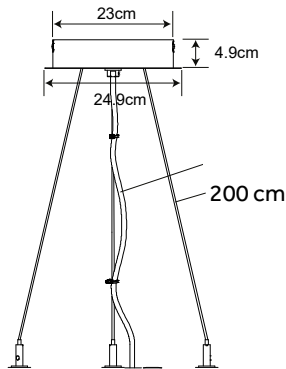
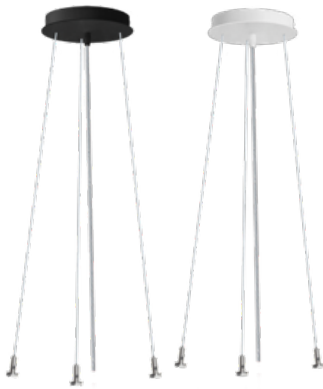

**EOLED**

Designed & assembled by  Ledeshi

**SHIFT. Seilabhängung mit Baldachin | Sospensione a filo | suspension filaire**



LSH.PENDEL.W.SHIFT3+ <b>DAL</b>	SHZB.100.0003.01.010.01.DTD	white	L-2000mm	DALI
LSH.PENDEL.B.SHIFT3+ <b>DAL</b>	SHZB.100.0003.01.012.01.DTD	black	L-2000mm	DALI
LSH.PENDEL.W.SHIFT4+ <b>DAL</b>	SHZB.100.0004.01.010.01.DTD	white	L-2000mm	DALI
LSH.PENDEL.B.SHIFT4+ <b>DAL</b>	SHZB.100.0004.01.012.01.DTD	black	L-2000mm	DALI
LSH.PENDEL.W.SHIFT6+ <b>DAL</b>	SHZB.100.0005.01.010.01.DTD	white	L-2000mm	DALI
LSH.PENDEL.B.SHIFT6+ <b>DAL</b>	SHZB.100.0005.01.012.01.DTD	black	L-2000mm	DALI

# EOLED

Designed & assembled by  Ledeshi

# BLADE.

## UPLIGHT



### BLADE 120

1200 x 145 x 55 mm



### BLADE 150

1500 x 145 x 55 mm



Seilabhängung  
mit Baldachin

Sospensione a filo  
suspension filaire



# BLADE.

**Erleben Sie moderne Bürobeleuchtung mit der EOLED Blade Pendel/Deckenleuchte.** Ihre elegante Form passt perfekt in jede Arbeitsumgebung. Wählen Sie zwischen Mikroprismen- oder Opalabdeckung für optimale Lichtverteilung. Mit dem CCT Switch passen Sie die Farbtemperatur an, während der Power Switch eine einfache Leistungsumschaltung ermöglicht. Die EOLED Blade vereint Stil und Funktionalität in perfekter Harmonie.

**Scopri la modernità con la lampada a sospensione/plafoniera EOLED Blade.** La sua forma elegante si adatta a qualsiasi ufficio. Scegli tra diffusore microprismatico o opale per una luce ottimale. Regola la temperatura del colore con il CCT Switch e cambia facilmente la potenza con il Power Switch. L'EOLED Blade unisce stile e funzionalità in perfetta armonia. EOLED Blade - Suspension/Plafonnier

**Découvrez la modernité avec la suspension/plafonnier EOLED Blade.** Sa forme élégante s'intègre parfaitement dans tout bureau. Choisissez entre un diffuseur micro-prismatique ou opale pour une lumière optimale. Ajustez la température de couleur avec le CCT Switch et changez la puissance facilement avec le Power Switch. L'EOLED Blade allie style et fonctionnalité en parfaite harmonie.



# BLADE 120/150.

NEW



DECKENLEUCHTE/PENDELLEUCHTE,  
Diffusor opal/Mikroprisma,  
Polycarbonat/Alluminium,  
Power switch, Color switch, Funktion: Dali

Plafoniera/Lampada a Sospensione,  
diffusore opale/ microprismatico,  
policarbonato/alluminio, power switch, color  
switch, funzione: dimmerabile Dali

Plafonnier/Suspension,  
diffuseur opale/ microprismatique,  
polycarbonate/aluminium, interrupteur,  
interrupteur de couleur, fonction: Dali

UPLIGHT

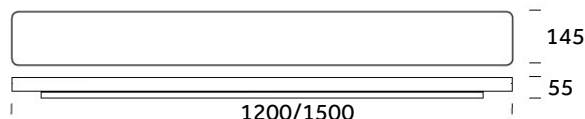

EOLED

Designed & assembled by  Ledeshi

BLADE 120



LSH.BLADE120. <b>BB.SWIDAL</b>	SHLS.100.0200.03.112.01.DTD	black brushed	1200x145x55	20/30/38W	3000/4000K	2000/2900/3850lm	IP20	DALI
LSH.BLADE120. <b>BS.SWIDAL</b>	SHLS.100.0200.03.111.01.DTD	silver brushed	1200x145x55	20/30/38W	3000/4000K	2000/2900/3850lm	IP20	DALI

BLADE 150



LSH.BLADE150. <b>BB.SWIDAL</b>	SHLS.100.0201.03.112.01.DTD	black brushed	1500x145x55	30/40/50W	3000/4000K	2850/3750/4650lm	IP20	DALI
LSH.BLADE150. <b>BS.SWIDAL</b>	SHLS.100.0201.03.111.01.DTD	silver brushed	1500x145x55	30/40/50W	3000/4000K	2850/3750/4650lm	IP20	DALI

Seilabhängung mit Baldachin  
 Sospensione a filo  
 suspension filaire

LichTec | Beleuchtung & Technik

# BLADE. PENDEL.

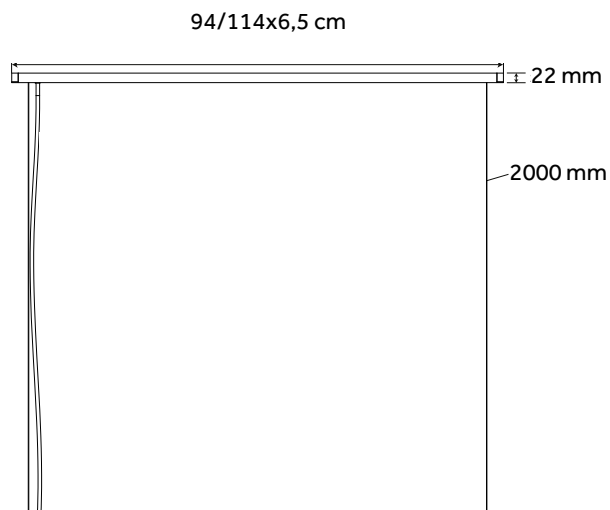

**EOLED**

Designed & assembled by  Ledeshi

**SHIFT. Seilabhängung mit Baldachin | Sospensione a filo | suspension**



LSH.PENDEL. <b>BB.120.DAL</b>	SHZB.100.0001.03.112.01.DTD	black brushed	L-2000mm	DALI
LSH.PENDEL. <b>BB.150.DAL</b>	SHZB.100.0002.03.112.01.DTD	black brushed	L-2000mm	DALI
LSH.PENDEL. <b>BS.120.DAL</b>	SHZB.100.0001.03.111.01.DTD	silver brushed	L-2000mm	DALI
LSH.PENDEL. <b>BS.150.DAL</b>	SHZB.100.0002.03.111.01.DTD	silver brushed	L-2000mm	DALI

# iQLED S PASO.

## PASO 2

Ø275x65 mm

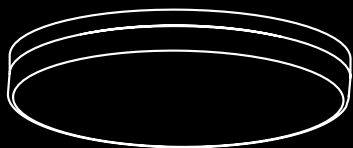

## PASO 3

Ø350x65 mm

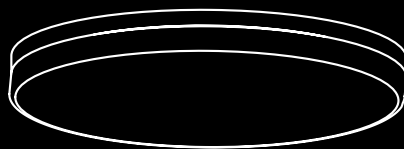

# PASO.

## **Das Multitalent für alle Fälle.**

Eine Leuchte mit 24 Möglichkeiten. Silber oder weiss, klein oder gross, power switch, CCT switch, Sensor- oder Notleuchte. Einsetzbar im Innen- oder Aussenbereich. Ideal für Durchgänge, Keller, Tiefgaragen, Treppenhäuser, Terrassen.

## **Lampada plafoniera tuttofare con 24 possibilità.**

Argento o bianco, piccolo o grande, power switch, CCT switch, sensore o luce d'emergenza. Può essere utilizzato all' interno o all' esterno. Ideale per corridoi, scantinati, garage, vani scala, terrazzi.

## **Plafonnier polyvalent offrant 24 possibilités.**

Argenté ou blanc, petit ou grand, interrupteur, interrupteur CCT, détecteur ou lampe de secours. Peut être utilisé à l'intérieur ou à l'extérieur. Idéal pour les couloirs, les caves, les garages, les cages d'escalier et les terrasses.



# iQLED S PASO 2.



WAND-/DECKENLEUCHTE  
Diffusor opal, Polycarbonat  
power switch, color switch,  
Funktion: ein/aus, HF-Sensor,  
Not (kein power switch)

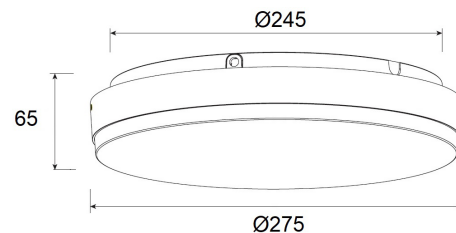

## IQL PASO2 R



IQL.PASO2.R. <b>W</b>	white	Ø275x65	10/15/20/25W	3000/4000/5700K	1000/1500/2000/2500lm	IP54	ON/OFF
IQL.PASO2.R. <b>W.NOT</b>	white	Ø275x65	18W	3000/4000/5700K	1800lm	IP54	EM
IQL.PASO2.R. <b>W.SEN</b>	white	Ø275x65	10/15/20/25W	3000/4000/5700K	1000/1500/2000/2500lm	IP54	SENSOR
IQL.PASO2.R. <b>S</b>	silber	Ø275x65	10/15/20/25W	3000/4000/5700K	1000/1500/2000/2500lm	IP54	ON/OFF
IQL.PASO2.R. <b>S.NOT</b>	silber	Ø275x65	18W	3000/4000/5700K	1800lm	IP54	EM
IQL.PASO2.R. <b>S.SEN</b>	silber	Ø275x65	10/15/20/25W	3000/4000/5700K	1000/1500/2000/2500lm	IP54	SENSOR

LAMPADA DA PARETE/SOFFITTO  
diffusore opale, polycarbonato  
power switch, color switch,  
funzione: on/off,  
rilevatore di movimento,  
emergenza (senza power switch)

APPLIQUE/PLAFONNIER  
diffuseur opale, polycarbonate  
interrupteur, interrupteur de couleur,  
fonction: marche/arrêt, détecteur de  
mouvement, urgence (sans interrupteur)

LichTec | Beleuchtung & Technik

# iQLED S PASO 3.

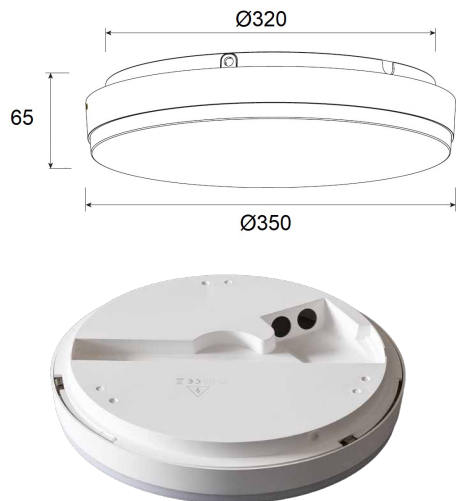

## IQL PASO 3 R



IQL.PASO3.R. <b>W</b>	white	Ø350x65	15/20/25/30W	3000/4000/5700K	1500/2000/2500/3000lm	IP54	ON/OFF
IQL.PASO3.R. <b>W.NOT</b>	white	Ø350x65	30W	3000/4000/5700K	3000lm	IP54	EM
IQL.PASO3.R. <b>W.SEN</b>	white	Ø350x65	15/20/25/30W	3000/4000/5700K	1500/2000/2500/3000lm	IP54	SENSOR
IQL.PASO3.R. <b>S</b>	silber	Ø350x65	15/20/25/30W	3000/4000/5700K	1500/2000/2500/3000lm	IP54	ON/OFF
IQL.PASO3.R. <b>S.NOT</b>	silber	Ø350x65	30W	3000/4000/5700K	3000lm	IP54	EM
IQL.PASO3.R. <b>S.SEN</b>	silber	Ø350x65	15/20/25/30W	3000/4000/5700K	1500/2000/2500/3000lm	IP54	SENSOR

# iQLED S ATARI.

## ATARI S

ØxH: 220 x 46 mm



**PRICE  
BREAKER**

## ATARI M

ØxH: 275 x 48 mm



**PRICE  
BREAKER**

## ATARI L

ØxH: 350 x 48 mm



**PRICE  
BREAKER**

# ATARI.

Entdecken Sie unsere schlichte Deckenleuchte, perfekt für Treppenhäuser und Keller. Mit einem integrierten Sensor passt sie sich automatisch Ihrer Anwesenheit an und spart Energie. Die Dimmfunktion ermöglicht es Ihnen, die Helligkeit nach Bedarf anzupassen – von sanftem Licht bis zu hellem Strahlen.

Scoprite il nostro semplice lampadario a soffitto, perfetto per scale e cantine. Dotato di un sensore integrato, si adatta automaticamente alla vostra presenza e risparmia energia. Con la funzione di dimmerazione, potrete regolare l'intensità luminosa a vostro piacimento, da una luce soffusa a una luce brillante.

Découvrez notre plafonnier simple et épuré, parfait pour les escaliers et les caves. Doté d'un capteur intégré, il s'ajuste automatiquement à votre présence et permet des économies d'énergie. Grâce à sa fonction de variation d'intensité, vous pouvez ajuster la luminosité selon vos besoins, passant d'une lumière douce à une lumière plus vive.



# iQLED S ATARI.



## WAND-/DECKENLEUCHTE

Diffusor opal, Polycarbonat,  
color switch, Funktion: ein/aus,  
dimmbar Triac, HF-Sensor

## LAMPADA DA PARETE/SOFFITTO

diffusore opale, policarbonato,  
color switch, funzione: on/off,  
dimmerabile Triac, rilevatore di movimento

## APPLIQUE/PLAFONNIER

diffuseur opale, polycarbonate,  
interrupteur de couleur,  
fonction : on/off, TRIAC dimmable,  
dali, détecteur de mouvement

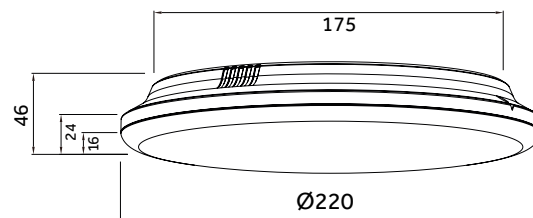

**PRICE  
BREAKER**

## ATARI S

CE	LED CRI 80 220-240V	50000h 5 years warranty	3000K/ 4000K/ 5700K	12/18/ 25W	TRIAC dim	on/off	Sensor	IP54	white
----	---------------------------	-------------------------------	---------------------------	---------------	-----------	--------	--------	------	-------

IQL.103.021	white	ØxH: 220 x 46 mm	12 W	3000/4000/5700 K	1100-1300 lm	IP54	ON/OFF
IQL.103.022	white	ØxH: 220 x 46 mm	12 W	3000/4000/5700 K	1100-1300 lm	IP54	TRIAC DIM



**PRICE  
BREAKER**

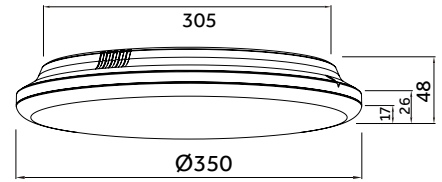
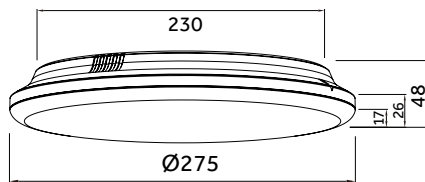

**ATARI M/L**

<b>CE</b>	<b>LED</b> CRI 80 220-240V	50000h 5 years warranty	3000K/ 4000K/ 5700K	12/18/ 25W	TRIAC dim	on/off	Sensor	<b>IP54</b>		<input type="checkbox"/> white
-----------	----------------------------------	-------------------------------	---------------------------	---------------	-----------	--------	--------	-------------	--	--------------------------------

IQL.103.041	white	ØxH: 275 x 48 mm	18 W	3000/4000/5700 K	1660-1900 lm	IP54	TRIAC DIM
IQL.103.042	white	ØxH: 275 x 48 mm	18 W	3000/4000/5700 K	1660-1900 lm	IP54	SENSOR
IQL.103.061	white	ØxH: 350 x 48 mm	25 W	3000/4000/5700 K	2300-2650 lm	IP54	TRIAC DIM
IQL.103.062	white	ØxH: 350 x 48 mm	25 W	3000/4000/5700 K	2300-2650 lm	IP54	SENSOR

# iQ LEDS OCULUS.

OFFICE  
Premium

## OCULUS SURFACE

1450x53x78mm



## UPLIGHT



## OCULUS PENDANT

1445 x 48 x 76 mm

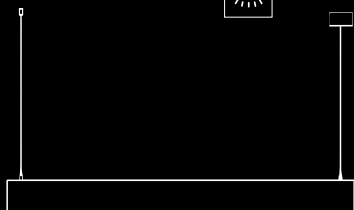

## OCULUS STAND

1960 x 1203 x 52 mm



# OCULUS.

**Hochwertige Büroleuchten mit höchster Entblendung dank der Linsentechnik.**

Erhältlich als Deckenleuchte, Pendelleuchte oder Stehleuchte. Die Oculus Leuchten ermöglichen ein angenehmes Arbeiten dank der direkt/indirekt Ausleuchtung.

**Le luci per ufficio di alta qualità sono prive di abbagliamento grazie alla tecnologia delle lenti.**

Disponibile come plafoniera, lampada a sospensione o lampada da terra. Le luci Oculus ti permettono di lavorare comodamente grazie all'illuminazione diretta/indiretta.

**Les lampes de bureau de haute qualité ne sont pas éblouissantes grâce à la technologie des lentilles.**

Elles sont disponibles sous forme de plafonnier, de suspension ou de lampadaire. Les lampes Oculus vous permettent de travailler confortablement grâce à un éclairage direct/indirect.





# IQ LED S OCULUS.

SURFACE

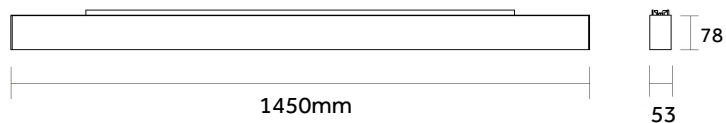
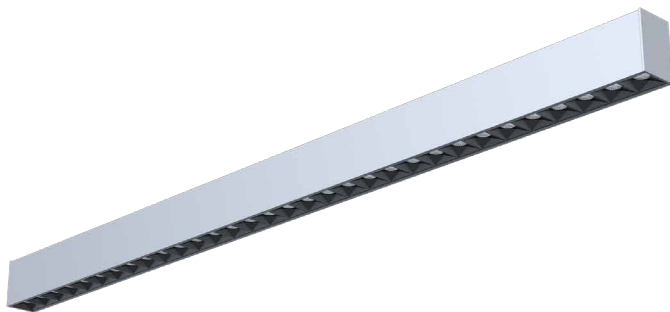

## OCULUS SURFACE

CE	LED CRI 80 220-240V	50000h 5 years warranty	3000K 4000K	35W	DALI	IP20		UGR >9	80°	<input type="checkbox"/> white <input type="checkbox"/> silver
----	---------------------------	-------------------------------	----------------	-----	------	------	--	-----------	-----	---

Model	Color	Dimensions (mm)	Power (W)	Color Temp (K)	Light Output (lm)	Beam Angle	Control
IQL.OCW1.3.DAL	white	1450 x 53 x 78 mm	35 W	3000 K	3100 lm	IP20	DALI
IQL.OCW1.4.DAL	white	1450 x 53 x 78 mm	35 W	4000 K	3250 lm	IP20	DALI
IQL.OCS1.3.DAL	silver	1450 x 53 x 78 mm	35 W	3000 K	3100 lm	IP20	DALI
IQL.OCS1.4.DAL	silver	1450 x 53 x 78 mm	35 W	4000 K	3250 lm	IP20	DALI

OFFICE ANBAULEUCHT E OCULUS  
Aluminium, Linsenoptik Entblendung,  
UGR <9, LED weiss oder Silber,  
Funktion: Dali dimmbar

PLAFONIERA OCULUS  
ideale per ufficio, alluminio,  
Lente retrocessa, UGR <9  
LED bianco o argento,  
funzione: dimmerabile dali

PLAFONNIER OCULUS  
idéal pour les bureaux, aluminium,  
Lentille inversée, UGR <9  
LED blanc ou argent,  
fonction: dali dimmable

OFFICE PENDELLEUCHTE OCULUS  
Aluminium, Linsenoptik Entblendung  
UGR <9, direkt/indirekt Beleuchtung,  
LED, Funktion: Dali dimmbar

LAMPADA A SOSPENSIONE OCULUS  
ideale per ufficio, alluminio, Lente retrocessa,  
UGR <9, luce diretta/indiretta, LED  
funzione: dimmerabile dali

LAMPE SUSPENDUE OCULUS  
idéale pour le bureau, aluminium,  
Lentille inversée, UGR <9,  
lumière directe/indirecte, LED,  
fonction: dali dimmable

OFFICE  
**Premium**

LichTec | Beleuchtung & Technik

**iQLED S**  
**OCULUS.**

PENDANT

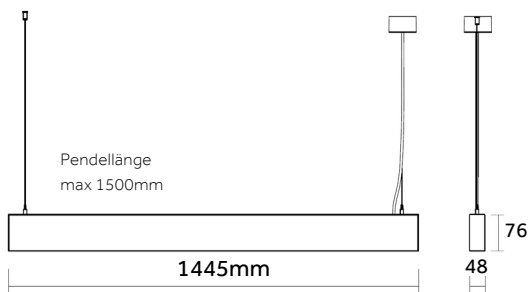

**UPLIGHT**

**OCULUS PENDANT**

CE
LED CRI 80 220-240V
50000h 5 years warranty
3000K 4000K
70W
DALI
IP20
UGR >9
140° / 80°
white silver black
uplight

IQL.OCW <b>2.3.DAL</b>	white	1445 x 48 x 76 mm	70 W	3000 K	7150 lm	IP20	DALI
IQL.OCW <b>2.4.DAL</b>	white	1445 x 48 x 76 mm	70 W	4000 K	7550 lm	IP20	DALI
IQL.OCS <b>2.3.DAL</b>	silver	1445 x 48 x 76 mm	70 W	3000 K	7150 lm	IP20	DALI
IQL.OCS <b>2.4.DAL</b>	silver	1445 x 48 x 76 mm	70 W	4000 K	7550 lm	IP20	DALI
IQL.OCB <b>2.3.DAL</b>	black	1445 x 48 x 76 mm	70 W	3000 K	7150 lm	IP20	DALI
IQL.OCB <b>2.4.DAL</b>	black	1445 x 48 x 76 mm	70 W	4000 K	7550 lm	IP20	DALI



# iQ LEDS OCULUS.

STAND



**UPLIGHT**

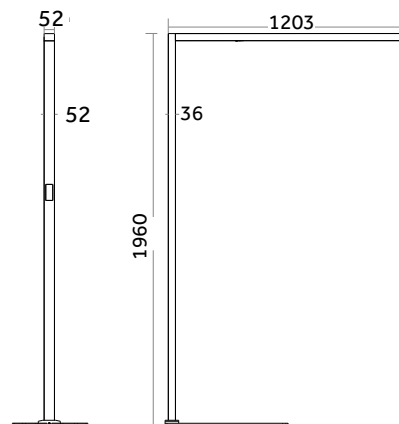

OFFICE STEHLEUCHTE OCULUS  
Aluminium, Linsenoptik Entblendung  
UGR <9, direkt/indirekt Beleuchtung LED,  
Funktion: dimmbar, Tageslichtsensor,  
Bewegungsmelder, tunable white

LAMPADA DA TERRA OCULUS  
alluminio, lente retrocessa, UGR <9,  
luce diretta/indiretta LED,  
funzione: dimmerabile, sensore  
di luce diurna, rilevatore di movimento,  
tunable white

Lampadaire OCULUS  
aluminium, lentille inversée, UGR <9,  
lumière directe/indirecte, LED  
Fonction: gradable, capteur de lumière  
du jour, détecteur de mouvement,  
blanc réglable

## OCULUS STAND



IQL.OC <b>W3.CCTSEN</b>	white	1203 x 52 x 1960 mm	80 W	3000-6000 K	9600 lm	IP20	SEN / DIM / CCT
IQL.OC <b>S3.CCTSEN</b>	silver	1203 x 52 x 1960 mm	80 W	3000-6000K	9600 lm	IP20	SEN / DIM / CCT
IQL.OC <b>B3.CCTSEN</b>	black	1203 x 52 x 1960 mm	80 W	3000-6000 K	9600 lm	IP20	SEN / DIM / CCT



# NOVA.

Die NOVA Stehleuchte kombiniert klassisches Design mit blendfreier Beleuchtung (UGR 13) und direkter/indirekter Lichtverteilung. Mit Tageslichtsensor und Bewegungsmelder passt sie sich flexibel an und spart Energie.

La lampada da terra NOVA combina design classico e illuminazione senza abbagliamento (UGR 13) con una distribuzione diretta e indiretta della luce. Grazie al sensore di luce diurna e al rilevatore di movimento, si adatta in modo flessibile e consente di risparmiare energia.

La lampe sur pied NOVA allie design classique et éclairage sans éblouissement (UGR 13) avec une répartition directe et indirecte de la lumière. Grâce au capteur de lumière du jour et au détecteur de mouvement, elle s'adapte de manière flexible et économise de l'énergie.



## STEHLEUCHTE NOVA

Aluminium, Mikroprismen, diffusor  
Entblendung, UGR 13, direkt/indirekt  
Beleuchtung, LED, Funktion: dimmbar,  
Tageslichtsensor, Bewegungsmelder



## LAMPADA NOVA

alluminio, diffusore microprismatico,  
UGR 13, luce diretta/ indiretta  
LED, funzione: dimmerabile, sensore di  
luce diurna, rilevatore di movimento

## LAMPADAIRE NOVA

idéal pour le bureau, aluminium  
Lentille inversée, UGR 13,  
lumière directe/indirecte, LED,  
Fonction: gradable, capteur de lumière  
du jour, détecteur de mouvement

692 mm

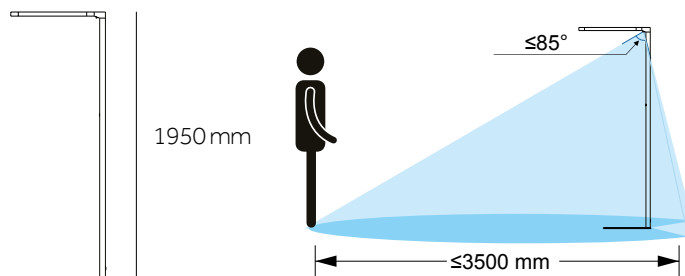

LichTec | Beleuchtung & Technik

# IQ LEDS NOVA.



UPLIGHT



## NOVA



CE

LED  
CRI 80  
220-240V

50.000h  
5 years  
warranty

UGR  
>13

4000K

100 W

IP20



NOVA	Color	Dimensions	Power	Light Output	Color Temp	Voltage	IP	Features
IQL.NOW3.040.SEN	white	692x310x1950mm	100W	14965lm	4000K	220-240V	IP 20	SEN / DIM
IQL.NOS3.040.SEN	silver	692x310x1950mm	100W	14965lm	4000K	220-240V	IP 20	SEN / DIM
IQL.NOB3.040.SEN	black	692x310x1950mm	100W	14965lm	4000K	220-240V	IP 20	SEN / DIM

# iQLED S ULYSSE

OFFICE  
Premium

UPLIGHT



## ULYSSE 3

Ø350 mm x 82 mm



## ULYSSE 4

Ø450 mm x 82 mm



## ULYSSE 6

Ø600 mm x 82 mm



## ULYSSE 9

Ø900 mm x 82 mm



Stangenabhängung  
mit Baldachin  
Sospensione a stelo  
suspension tube



Seilabhängung  
mit Baldachin  
Sospensione a filo  
suspension filaire



# ULYSSE.

## **HOCHWERTIGE PROJEKTLEUCHE MIT EINFACHER MONTAGEART.**

Einsetzbar als Aufbauleuchte sowie als Pendelleuchte. Seilabhängung oder Stangenabhängung separat zu bestellen. Durch die feine mikroprismatische Abdeckung und das zusätzliche Indirektlicht ergibt sich eine angenehme Ausleuchtung und daher ideal für Büro, Laden, Schule usw.

## **LAMPADA DA PROGETTO DI ALTA QUALITÀ CON INSTALLAZIONE SEMPLICE.**

Può essere utilizzata come lampada plafoniera o come lampada a sospensione. Sospensione a filo o a stelo da ordinare a parte. La sottile copertura microprismatica e la luce indiretta aggiuntiva garantiscono un'illuminazione piacevole e sono quindi ideali per uffici, negozi, scuole, ecc.

## **LAMPE DESIGN DE HAUTE QUALITÉ À L'INSTALLATION SIMPLE.**

Peut être utilisée comme plafonnier ou comme lampe suspendue. La suspension encastrée ou sur pied doit être commandée séparément. Le fin couvercle microprismatique et la lumière indirecte supplémentaire procurent un éclairage agréable et sont donc idéaux pour les bureaux, les magasins, les écoles, etc.

# iQLED S ULYSSE 3.

## DECKENLEUCHTE/ PENDELLEUCHTE

Diffusor Mikroprisma oder opal,  
Aluminium, direkt/indirekt strahlend,  
LED, Funktion: ein/aus, dimmbar Dali,  
Not, Zubehör: Seil- oder Stangen-  
abhängung separat zu bestellen

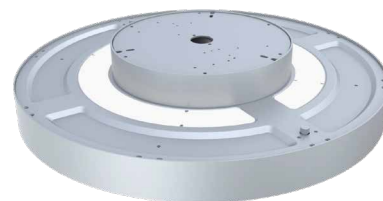
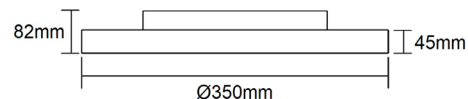

**UPLIGHT**



**OFFICE  
Premium**



### ULYSSE 3

#### (M) DIFFUSER

E = Microprismatic  
O = opal

#### (C) COLOR

B = black, W = white  
S = silver



ULYSSE 3	(M) DIFFUSER	(C) COLOR	CE	LED CRI 85 220-240V	50000h 5 years warranty	3000K 4000K	18W	IP20	DALI/EM	UGR <18 Micro- prismatic	
<b>IQL.UY(M)3.(C).3.DA</b>	E   O	B   S   W				3000K	18 W	Ø350x82mm	1595lm	IP 20	DALI
<b>IQL.UY(M)3.(C).3.ND</b>	E   O	B   S   W				3000K	18 W	Ø350x82mm	1595lm	IP 20	ON/OFF
<b>IQL.UY(M)3.(C).3.DA.EM</b>	E   O	B   S   W				3000K	18 W	Ø350x82mm	1595lm	IP 20	DALI / EM
<b>IQL.UY(M)3.(C).4.DA</b>	E   O	B   S   W				4000K	18 W	Ø350x82mm	1776lm	IP 20	DALI
<b>IQL.UY(M)3.(C).4.ND</b>	E   O	B   S   W				4000K	18 W	Ø350x82mm	1776lm	IP 20	ON/OFF
<b>IQL.UY(M)3.(C).4.DA.EM</b>	E   O	B   S   W				4000K	18 W	Ø350x82mm	1776lm	IP 20	DALI / EM

LAMPADA DA PARETE/SOFFITTO  
diffusore microprismatico o opale,  
alluminio, luce diretta/indiretta, LED,  
funzione: on/off, dimmabile dali,  
emergenza, accessori: sospensione  
filo/ tubo da ordinare a parte

APPLIQUE/PLAFONNIER  
diffuseur microprismatique ou opale,  
aluminium, lumière directe/indirecte,  
LED fonction: on/off, dali dimmable,  
emergency, accessoires: suspension  
filaire/tube à commander séparément

LichTec | Beleuchtung & Technik

# iQLED S ULYSSE 4.

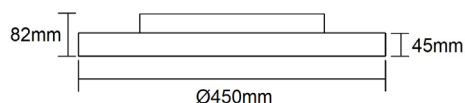

**UPLIGHT**



OFFICE  
**Premium**



## ULYSSE 4

**(M) DIFFUSER**

E = Microprismatic  
O = opal

**(C) COLOR**

B = black, W = white  
S = silver

CE

LED  
CRI 85  
220-240V

50000h  
5 years  
warranty

3000K  
4000K

18W

IP20



UGR  
<18  
Micro-  
prismatic

Model	(M) DIFFUSER	(C) COLOR	Color	Size	Power	Light Output	IP	Control
<b>IQL.UY(M)4.(C).3.DA</b>	E   O	B   S   W	3000K	Ø450x82mm	30 W	2978lm	IP 20	DALI
<b>IQL.UY(M)4.(C).3.ND</b>	E   O	B   S   W	3000K	Ø450x82mm	30 W	2978lm	IP 20	ON/OFF
<b>IQL.UY(M)4.(C).3.DA.EM</b>	E   O	B   S   W	3000K	Ø450x82mm	30 W	2978lm	IP 20	DALI / EM
<b>IQL.UY(M)4.(C).4.DA</b>	E   O	B   S   W	4000K	Ø450x82mm	30 W	3490lm	IP 20	DALI
<b>IQL.UY(M)4.(C).4.ND</b>	E   O	B   S   W	4000K	Ø450x82mm	30 W	3490lm	IP 20	ON/OFF
<b>IQL.UY(M)4.(C).4.DA.EM</b>	E   O	B   S   W	4000K	Ø450x82mm	30 W	3490lm	IP 20	DALI / EM

# iQ LEDS ULYSSE 6.

OFFICE  
Premium

## DECKENLEUCHTE/ PENDELLEUCHTE

Diffusor Mikroprisma oder opal, Aluminium, direkt/indirekt strahlend, LED, Funktion: ein/aus, dimmbar Dali, Not, Zubehör: Seil- oder Stangenabhängung separat zu bestellen

## LAMPADA DA PARETE/SOFFITTO

diffusore microprismatico o opale, alluminio, luce diretta/indiretta, LED, funzione: on/off, dimmberabile dali, emergenza, accessori: sospensione filo/tubo da ordinare a parte

## APPLIQUE/PLAFONNIER

diffuseur microprismatique ou opale, aluminium, lumière directe/indirecte, LED fonction: on/off, dali dimmable, secours accessoires: suspension filaire/tube à commander séparément

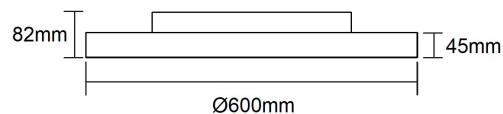

UPLIGHT



### ULYSSE 6

#### (M) DIFFUSER

E = Microprismatic  
O = opal

#### (C) COLOR

B = black, W = white  
S = silver

CE

LED  
CRI 85  
220-240V

50000h  
5 years  
warranty

3000K  
4000K

48W

IP20



UGR  
<18  
Micro-  
prismatic

ULYSSE 6	(M) DIFFUSER	(C) COLOR	CE	LED	50000h 5 years warranty	3000K 4000K	48W	IP20	UGR <18 Micro- prismatic
IQL.UY(M)6.(C).3.DA	E   O	B   S   W							
IQL.UY(M)6.(C).3.ND	E   O	B   S   W							
IQL.UY(M)6.(C).3 DA.EM	E   O	B   S   W							
IQL.UY(M)6.(C).4.DA	E   O	B   S   W							
IQL.UY(M)6.(C).4.ND	E   O	B   S   W							
IQL.UY(M)6.(C).4 DA EM	E   O	B   S   W							



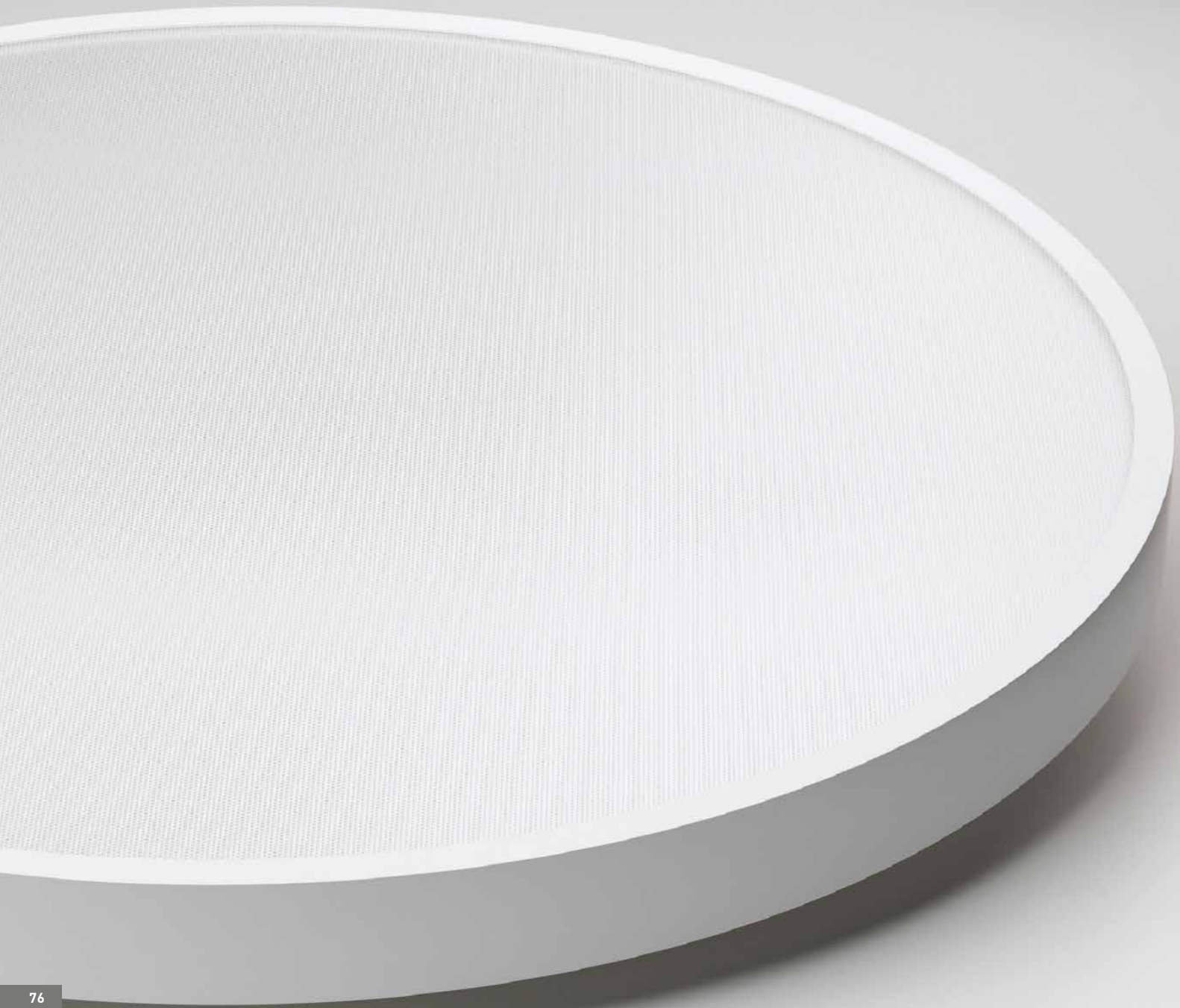

## DECKENLEUCHTE/ PENDELLEUCHTE

Diffusor Mikroprisma oder opal  
Aluminium, direkt/indirekt strahlend,  
LED, Funktion: ein/aus, dimmbar Dali,  
Zubehör: Seil- oder Stangen-  
abhängung separat zu bestellen



LichTec | Beleuchtung & Technik

# iQLED S ULYSSE 9.

## LAMPADA DA PARETE/SOFFITTO

diffusore microprismatico o opale,  
alluminio, luce diretta/indiretta, LED  
funzione: on/off, dimmabile dali,  
accessori: sospensione filo/tubo  
da ordinare a parte

## APPLIQUE/PLAFONNIER

diffuseur microprismatique ou opale,  
aluminium, lumière directe/indirecte, LED  
fonction: on/off, dimmable dali,  
accessoires: suspension filaire/tube à  
commander séparément

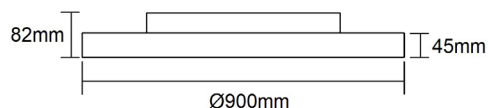

## UPLIGHT



ULYSSE 9	(M) DIFFUSER E = Microprismatic O = opal	(C) COLOR B = black, W = white S = silver	CE	LED CRI 85 220-240V	50000h 5 years warranty	3000K 4000K	80W	IP20	UGR <18 Micro- prismatic		
	<b>IQL.UY(M)9. (C).3.DA</b>	E   O	B   S   W				3000 K	Ø900 x 82 mm	80 W	9122 lm	IP 20
<b>IQL.UY(M)9. (C).3.ND</b>	E   O	B   S   W				3000 K	Ø900 x 82 mm	80 W	9122 lm	IP 20	ON/OFF
<b>IQL.UY(M)9. (C).4.DA</b>	E   O	B   S   W				4000 K	Ø900 x 82 mm	80 W	9350 lm	IP 20	DALI
<b>IQL.UY(M)9. (C).4.DA</b>	E   O	B   S   W				4000 K	Ø900 x 82 mm	80 W	9350 lm	IP 20	ON/OFF

# iQ LED S

## ULYSSE PM/SC.

Stangenabhängung  
mit Baldachin

Sospensione a stelo  
suspension tube



Seilabhängung  
mit Baldachin

Sospensione a filo  
suspension filaire

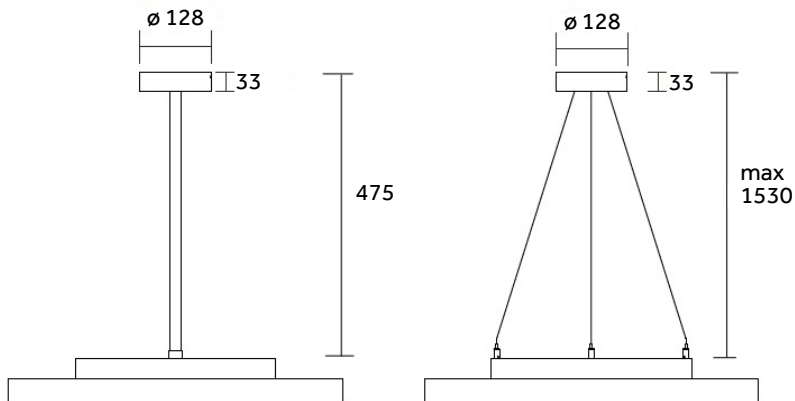
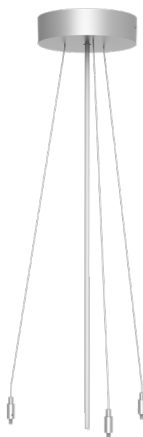

	(C) COLOR B = black, W = white S = silver			CE	DALI	white silver black
IQL.UYPD.PM.(C).DA	B   S   W	Stangenabhängung mit Baldachin Sospensione a stelo	L- 475 mm		DALI	
IQL.UYPD.SC.(C).DA	B   S   W	Seilabhängung mit Baldachin Sospensione a filo	L-1500 mm		DALI	



# iQLED S

## WANDLEUCHTEN.

LAMPADA DA PARETE.

APPLIQUE.

### QUADRO

BxHxT: 120 x 100 x 97 mm

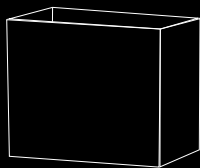

### FLAT

BxHxT: 175 x 90 x 30.5 mm

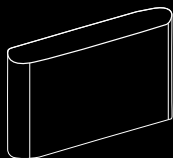

### SPHERA

ØxH: 100 x 95 mm

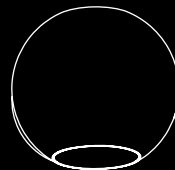



**AKZENDE,  
WO UND WIE  
SIE MÖCHTEN.**

ACCENTI DOVE  
E COME VUOI.

METTEZ L'ACCENT  
OÙ ET COMME VOUS  
LE SOUHAITEZ.

# iQLED S QUADRO.

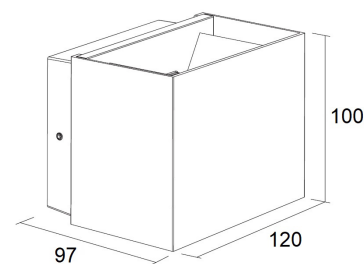
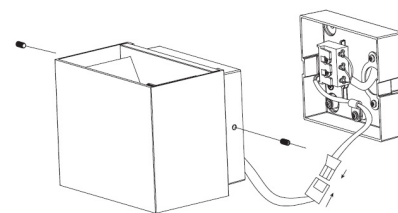
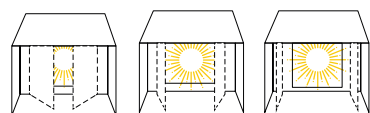
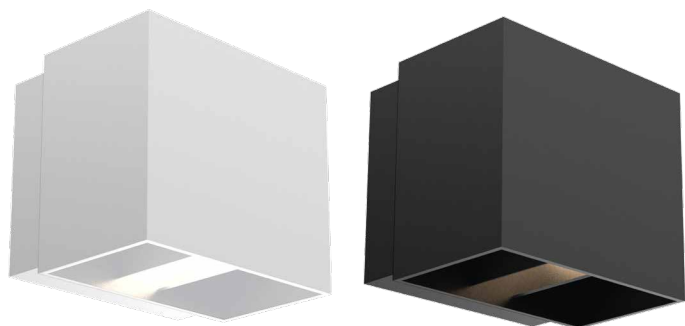

WANDLEUCHTE  
Aluminium, weiss oder schwarz  
Abstrahlwinkel verstellbar: 2x 15°-120°  
Funktion: ein/aus

LAMPADA DA PARETE  
alluminio, bianco o nero  
Angolo del fascio regolabile: 2x 15°-120°  
Funzione: on/off

APPLIQUE  
aluminium, blanc ou noir  
Angle de rayonnement  
réglable: 2x 15°-120°  
Fonction: on/off

## QUADRO

CE	LED CRI 80 220-240V	50000h 5 years warranty	3000K	10W	IK06	IP65	⏻	15°-120° 15°-120°	⏻ on/off	□ white ■ black
----	---------------------------	-------------------------------	-------	-----	------	------	---	----------------------	-------------	--------------------

IQL.QUADRO.W	white	120 x 100 x 97 mm	10 W	3000 K	900 lm	IP 65	ON/OFF
IQL.QUADRO.B	black	120 x 100 x 97 mm	10 W	3000 K	900 lm	IP 65	ON/OFF

# QUADRO.

## **Akzente, wo und wie Sie möchten.**

Die Wandleuchte QUADRO mit verstellbaren Abstrahlwinkeln 15°-120°. **Im Innen- und Aussenbereich montierbar.** Langlebigkeit im Aussenbereich, hohe Qualität und grösste Flexibilität. Durch ihr schmales Design und die vier separat verstellbaren Lamellen, können Sie die Leuchte genau so einstellen, wie Sie es wünschen.

## **Accenti dove e come vuoi.**

Lampada da parete QUADRO con angoli di emissione regolabili 15°-120°. **Può essere installata all'interno e all'esterno.** Alta qualità e massima flessibilità. Grazie al suo design sottile e alle quattro lamelle separatamente regolabili, è possibile impostare la lampada esattamente come desiderato.

## **Mettez l'accent où et comme vous le souhaitez.**

Applique QUADRO avec angles de rayonnement réglables 15°-120°. **Peut être installée à l'intérieur et à l'extérieur.** Haute qualité et flexibilité maximale. Grâce à son design étroit et aux quatre lamelles réglables séparément, vous pouvez régler la lampe exactement comme vous le souhaitez.

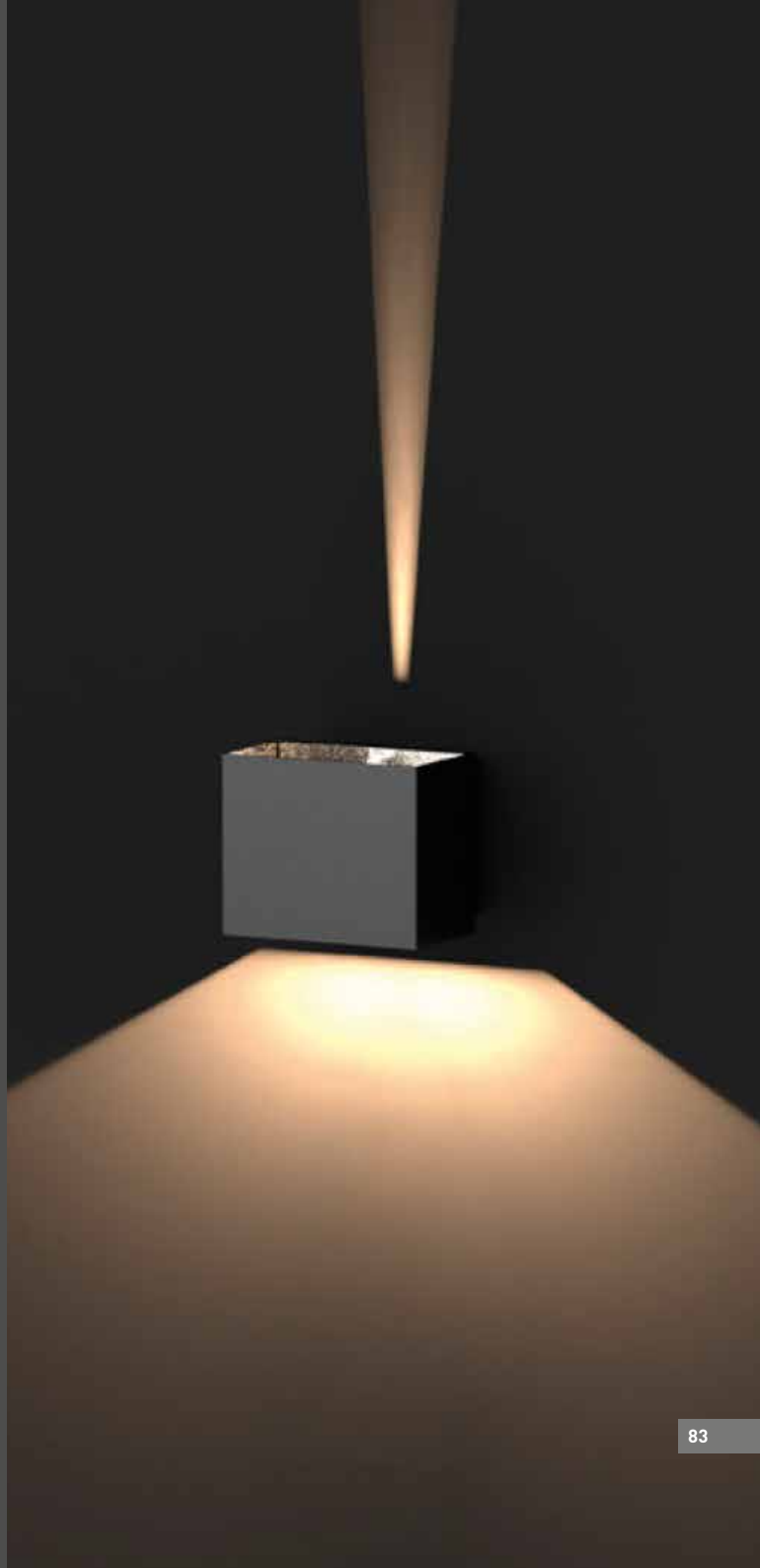

# iQLED S FLAT.



## WANDLEUCHTE

Aluminium, weiss oder schwarz  
Funktion: ein/aus, color switch,  
wallwasher

## LAMPADA DA PARETE

alluminio, bianco o nero  
Funzione: on/off, color switch,  
wallwasher

## APPLIQUE

aluminium, blanc ou noir  
Fonction: on/off, interrupteur de couleur,  
wallwasher

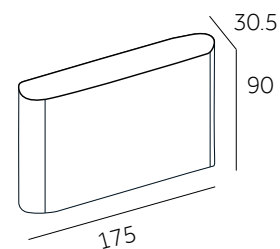

## FLAT

<b>CE</b>	<b>LED</b> CRI 80 220-240V	50000h 5 years warranty	3/4 5700K	10W	IK08	<b>IP65</b>		wallwasher wallwasher	on/off	<input type="checkbox"/> white <input type="checkbox"/> black
-----------	----------------------------------	-------------------------------	--------------	-----	------	-------------	--	--------------------------	--------	--

IQL.FLAT. <b>W</b>	white	175 x 90 x 30.5 mm	10 W	CCT 3/4/5700 K	950/1000/1060 lm	IP 65	ON/OFF
IQL.FLAT. <b>B</b>	black	175 x 90 x 30.5 mm	10 W	CCT 3/4/5700 K	950/1000/1060 lm	IP 65	ON/OFF

# FLAT.

**Die Wandleuchte FLAT passt dank flachem Design an jede Wand.**

Schlicht und elegant wirft sie durch die Wallwasher Optik einen angenehmen Lichtwurf nach oben und unten an die Wand. Dank der CCT switch Funktion können Sie die Lichtfarbe ändern. **Sie kann im Innen- und Aussenbereich eingesetzt werden.**

**Grazie al suo design piatto, l'applique FLAT si adatta a qualsiasi parete.**

Semplice ed elegante, proietta una piacevole luce su e giù sulla parete, grazie all' ottica wallwasher. Grazie alla funzione CCT switch, puoi cambiare il colore della luce.

**Può essere utilizzato all'interno e all'esterno.**

**Grâce à son design plat, l'applique FLAT s'adapte à tous les murs.**

Simple et élégante, elle projette une lumière agréable vers le haut et le bas du mur, grâce à son optique lèche-mur. Grâce à la fonction interrupteur CCT, vous pouvez changer la couleur de la lumière.

**Peut être utilisée à l'intérieur et à l'extérieur.**



# iQLED S SPHERA.

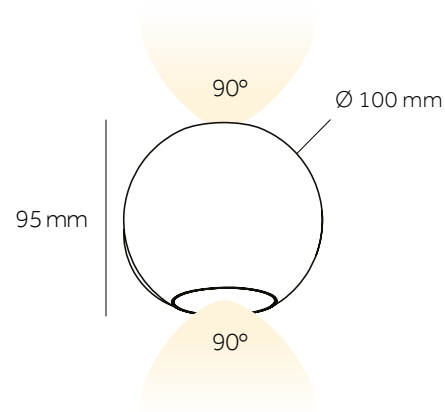
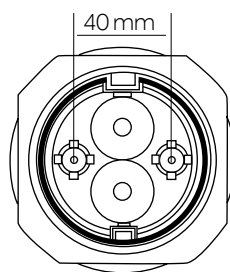

WANDLEUCHTE  
Aluminium,  
Abstrahlwinkel: 2x 90°  
Funktion: Triac dimmbar

LAMPADA DA PARETE  
alluminio,  
Angolo del fascio: 2x 90°  
Funzione: dimmerabile Triac

APPLIQUE  
aluminium,  
Angle de rayonnement  
réglable: 2x 90°  
Fonction : TRIAC dimmable

## SPHERA



IQL.SPHERA. <b>W</b>	white	ØxH: 100x95mm	6W	600 - 875 lm	3000/4000/5700K	>80	TRIAC dim
IQL.SPHERA. <b>B</b>	black	ØxH: 100x95mm	6W	600 - 875 lm	3000/4000/5700K	>80	TRIAC dim

# SPHERA.

**Up/Down-Wandleuchte:** Mit ihrem kugelförmigen Design und einer leistungsstarken COB-Lichtquelle setzt sie sowohl nach oben als auch nach unten strahlende Lichtakzente an jeder Fassade. Das robuste Aluminiumgehäuse und der praktische CCT-Schiebeschalter zur Einstellung der Farbtemperatur (3000K, 4000K, 5700K) sorgen für Flexibilität und Langlebigkeit. In Schwarz (RAL9005) und Weiß (RAL9016) erhältlich, ist die Leuchte dank ihrer IP65-Schutzklasse wetterfest und ideal für den Außenbereich geeignet.

**Up/Down lampada da parete:** Con il suo design sferico e una potente sorgente luminosa COB, proietta luce sia verso l'alto che verso il basso, creando accenti luminosi su ogni facciata. Il robusto corpo in alluminio e il pratico interruttore a slitta CCT per la regolazione della temperatura del colore (3000K, 4000K, 5700K) garantiscono flessibilità e durata nel tempo. Disponibile in nero (RAL9005) e bianco (RAL9016), la lampada è impermeabile grazie alla classe di protezione IP65, ideale per l'uso esterno

**Applique Up/Down:** Avec son design sphérique et une source lumineuse COB puissante, elle diffuse la lumière vers le haut et vers le bas, créant des accents lumineux sur chaque façade. Le boîtier en aluminium robuste et le commutateur coulissant CCT pratique pour régler la température de couleur (3000K, 4000K, 5700K) offrent flexibilité et durabilité. Disponible en noir (RAL9005) et blanc (RAL9016), cette applique est étanche grâce à la certification IP65, idéale pour une utilisation en extérieur.

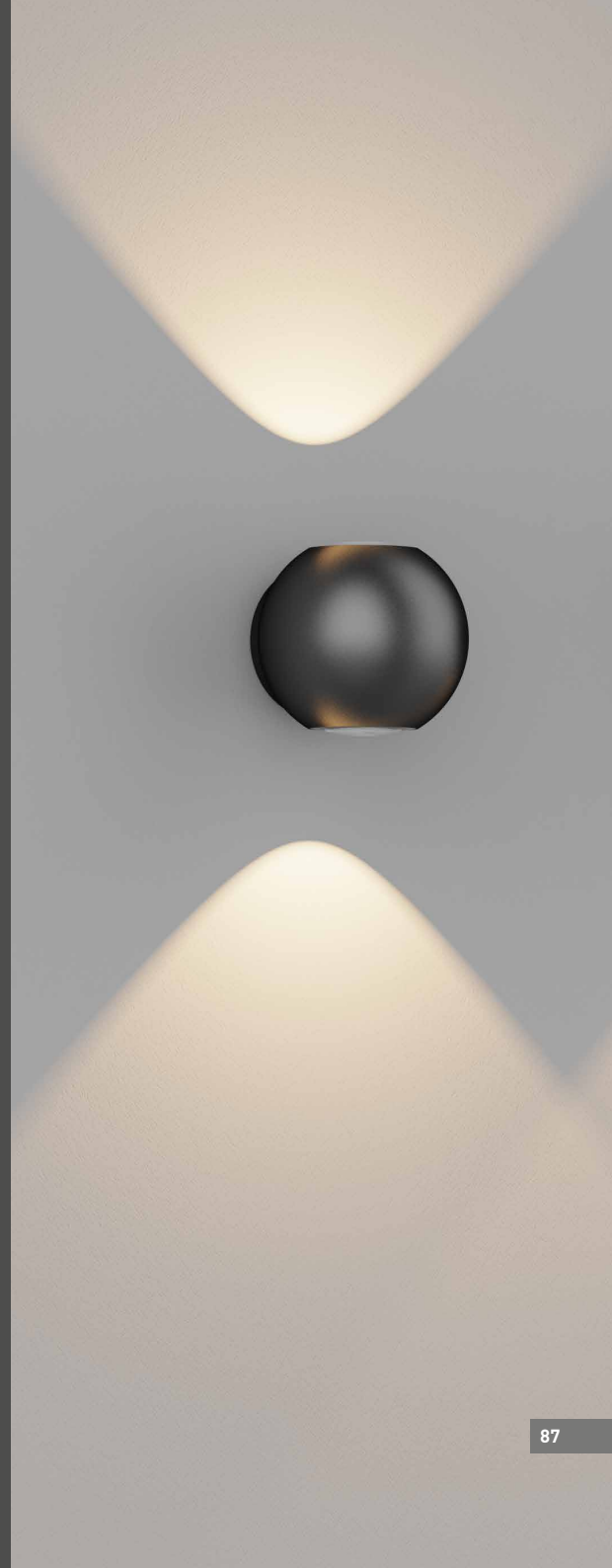

# iQLED S LUNA.



EINBAULEUCHTE  
Aluminium, Funktion: TRIAC dimmbar

FARETTO DA INCASSO  
alluminio, funzione: dimmerabile Triac

SPOT ENCASTRÉ  
aluminium, fonction: TRIAC dimmable

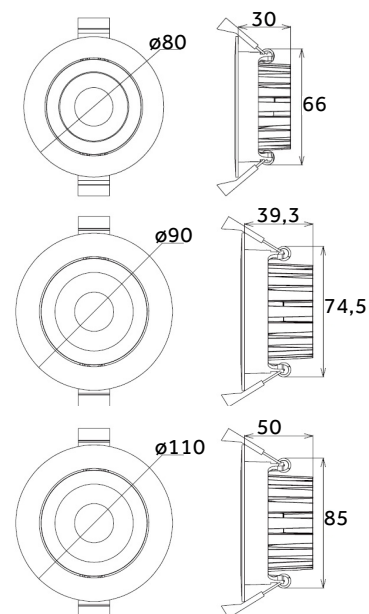

## LUNA

<b>CE</b>	<b>LED</b> CRI 80 220-240V	40.000h 5 years warranty	3000K	5W/ 10W	<b>IP65</b>	60° 36°	TRIAC dim	white black
-----------	----------------------------------	--------------------------------	-------	------------	-------------	------------	-----------	----------------

Model	Color	Size	Power	Beam Angle	Color Temp	Lumen	IP Rating	Function
IQL.101.201	white	Ø80 x ET30	5 W	60°	3000 K	475 lm	IP 65	TRIAC DIM
IQL.101.202	white	Ø80 x ET30	5 W	36°	3000 K	475 lm	IP 65	TRIAC DIM
QL.101.213	white	Ø90 x ET39,3	10 W	36°	3000 K	870 lm	IP 65	TRIAC DIM
IQL.101.228	white	Ø90 x ET39,3	10 W	60°	3000 K	870 lm	IP 65	TRIAC DIM
QL.101.216	black	Ø90 x ET39,3	10 W	60°	3000 K	870 lm	IP 65	TRIAC DIM
QL.101.213.XL	white	Ø110 x ET49,5	10 W	36°	3000 K	870 lm	IP 65	TRIAC DIM

# LUNA.

Die Luna Einbauleuchte von iqLEDS überzeugt mit hochwertiger Linsentechnik und einer wasserdichten Front. **Einfache Montage mit Steckverbindung zum Konverter.**

Faretto da incasso Luna di iqLEDS convince grazie alla tecnologia delle lenti di alta qualità e al frontale impermeabile. **Montaggio semplice con connessione plug-in al convertitore.**

Le luminaire encastré Luna d'iqLEDS convainc par sa technique de lentilles de haute qualité et sa façade étanche. **Montage facile avec connexion enfichable au convertisseur.**



# IQLEDS

## INDUSTRIE-/HALLENLEUCHTEN.

APPARECCHI DI ILLUMINAZIONE  
PER INDUSTRIA E CAPANONI.

LUMINAIRES POUR L'INDUSTRIE  
ET LES ENTREPÔTS.



### LINO M

1203x71x64mm



### LINO L

1503x71x64mm



### HIRAY

ØxH: 282x140mm

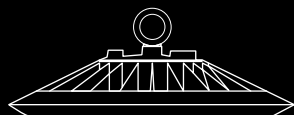

### HIRAY

ØxH: 325x140mm

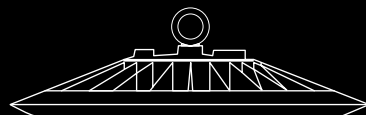



# iQLED S LINO.



## DECKENLEUCHTE

Opal Diffusor, Kunststoff/Eisen,  
Funktion: ein/aus, color switch  
Notlicht

## LAMPADA DA SOFFITTO

diffusore opale, plastica, ferro,  
funzione: on/off, color switch,  
emergenza

## PLAFONNIER

diffuseur opale, plastique, fer,  
fonction: on/off, secours

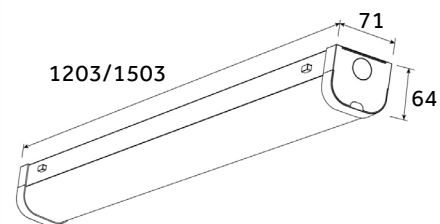
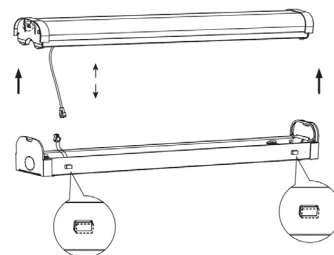

## LINO

CE	LED CRI 80 220-240V	50000h 5 years warranty	3/4/ 5700K	40W/ 50W	IP20	3h EM	on/off	white
----	---------------------------	-------------------------------	---------------	-------------	------	-------	--------	-------

Model	Color	Dimensions (mm)	Power (W)	Light Output (lm)	Color Temperature (K)	IP Rating	Emergency Function
IQL.LINO.M	white	1203 x 71 x 64 mm	40 W	4000 - 4600 lm	3/4/5700 K	IP 20	ON/OFF
IQL.LINO.M. <b>NOT</b>	white	1203 x 71 x 64 mm	40 W	4000 - 4600 lm	3/4/5700 K	IP 20	EM
IQL.LINO.L	white	1503 x 71 x 64 mm	50 W	4800 - 6000 lm	3/4/5700 K	IP 20	ON/OFF
IQL.LINO.L. <b>NOT</b>	white	1503 x 71 x 64 mm	50 W	4800 - 6000 lm	3/4/5700 K	IP 20	EM

# LINO.

Die Balkenleuchte Lino ersetzt eine herkömmliche T8 Fassung und deckt deren vorherigen Montagebereich ab. Durchgangsverdrahtung integriert. Schlagfestes Gehäuse.

L'apparecchio a barra Lino sostituisce un portalampada T8 convenzionale e copre l'area di montaggio precedente. Cablaggio passante integrato. Corpo resistente agli urti.

Le luminaire sur poutre Lino remplace une douille T8 traditionnelle et couvre sa zone de montage précédente. Câblage traversant intégré. Boîtier résistant aux chocs.



# iQLED S HIRAY.

**5 YEARS WARRANTY**

**180 lm/W**



**STRAHLER LED**  
Strahler LED, Aluminium Druckguss, graphit, IK08, 141'000h  
Funktion: 1-10V, Sensor

**FARO LED**  
pressofusione alluminio, grafite  
IK08, 141'000h, Funzione: 1-10V,  
rilevatore di movimento

**PROJECTEUR LED**  
aluminium moulé sous pression,  
graphite, IK08, 141'000h  
Fonction : 1-10V, détecteur  
de mouvement

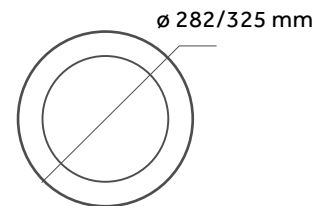
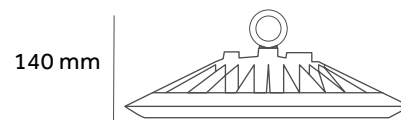
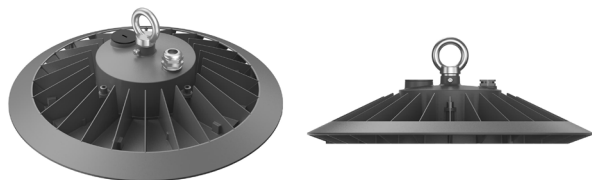

**Power selectable**

high mid low

**CCT selectable**

5000 K  
4000 K  
3000 K

## HIRAY

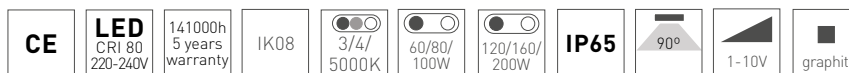

IQL.100.500	SHLS.400.0001.01.012.01.VV	graphit	ØxH:282x140mm	60/80/100W	12/16/20000lm	3/4/5000K	IP 65	1-10V
IQL.100.550	SHLS.400.0002.01.012.01.VV	graphit	ØxH:325x140mm	120/160/200W	24/32/40000lm	3/4/5000K	IP 65	1-10V

# HIRAY.

Der HiRay LED Hallenstrahler überzeugt mit einer Effizienz von bis zu 200 lm/W und flexiblen Leistungseinstellungen (60-100W oder 120-200W). Die umschaltbaren Farbtemperaturen (3000K, 4000K, 5000K) machen ihn ideal für Lager-, Industrie- und Sporthallen. Mit Zubehör wie Montagebügel, HF-Sensor, PIR-Sensor und Fernbedienung bietet er zusätzliche Flexibilität für verschiedenste Anwendungen.

Il faro a LED HiRay offre un'efficienza fino a 200 lm/W e impostazioni di potenza flessibili (60-100W o 120-200W). Le temperature di colore regolabili (3000K, 4000K, 5000K) la rendono ideale per magazzini, impianti industriali e palestre. Con accessori come staffa di montaggio, sensore HF, sensore PIR e telecomando, offre una maggiore flessibilità per diverse applicazioni.

Le projecteur LED HiRay offre une efficacité allant jusqu'à 200 lm/W et des réglages de puissance flexibles (60-100W ou 120-200W). Les températures de couleur ajustables (3000K, 4000K, 5000K) le rendent idéal pour les entrepôts, les installations industrielles et les gymnases. Avec des accessoires comme un support de montage, un capteur HF, un capteur PIR et une télécommande, il offre une flexibilité accrue pour diverses applications.



# iQLED S HIRAY ZUBEHÖR.

accessori | accessoires



IQL.010.600



IQL.010.601



IQL.010.602



IQL.010.603



IQL.010.604

## HIRAY.

Zubehör: Montagebügel,  
HF- Sensor, PIR- Sensor,  
Fernbedienung

Accessori: staffa di montaggio,  
sensore HF, sensore PIR,  
telecomando

Accessoires : support de  
montage, capteur HF,  
capteur PIR, télécommande

IQL.010.600	SHZB.400.0200.01.012.01.HS	black	HF- Sensor sensore HF capteur HF	ØxH: 50x37.5mm
IQL.010.602	SHZB.400.0201.03.010.01.HS	white	Fernbedienung zu HF- Sensor telecomando per sensore HF télécommande capteur HF	
IQL.010.601	SHZB.400.0200.01.012.01.PS	black	PIR- Sensor sensore PIR capteur PIR	ØxH: 50x37.5mm
IQL.010.603	SHZB.400.0201.03.012.01.PS	black	Fernbedienung zu PIR-Sensor telecomando per sensore PIR télécommande capteur PIR	
IQL.010.604	SHZB.400.0202.03.011.01.NR		Montagebügel, Alu staffa di montaggio support de montage	

**SCHLICHT  
UND ELEGANT.**

SEMPLICE  
ED ELEGANTE.

SOBRE ET ÉLÉGANT.

Die Angaben und Maße der Leuchten können sich mit jedem Update geringfügig ändern. Wir übernehmen keine Haftung für etwaige Abweichungen und empfehlen, die neuesten Spezifikationen vor dem Kauf zu überprüfen.

Alle Angaben ohne Gewähr. Irrtümer, Änderungen und Druckfehler vorbehalten. Für Richtigkeit und Vollständigkeit wird keine Haftung übernommen.

Le indicazioni e le dimensioni delle lampade possono variare leggermente con ogni aggiornamento. Decliniamo ogni responsabilità per eventuali discordanze e raccomandiamo di verificare le specifiche più recenti prima dell'acquisto. Tutte le informazioni senza garanzia. Errori, modifiche e errori di stampa sono riservati. Non si assume alcuna responsabilità per accuratezza e completezza.

Les indications et les dimensions des luminaires peuvent légèrement varier à chaque mise à jour. Nous déclinons toute responsabilité pour d'éventuelles divergences et recommandons de vérifier les spécifications les plus récentes avant l'achat.

Toutes les informations sans garantie. Erreurs, modifications et erreurs d'impression réservées. Aucune responsabilité n'est assumée pour l'exactitude et l'exhaustivité.



**LichTec GmbH**

Fürtistrasse 7/9

CH – 8832 Wollerau SZ

T: +41 55 410 43 36

[Info@lichtec.ch](mailto:Info@lichtec.ch)

[www.lichtec.ch](http://www.lichtec.ch)