

## BONE SURGERY



**Hemostats**

**Mallets**

**Bone Currettes**

**Periosteal Raspatories**

**Bone Files**

**Elevators**

**Bone Levers**

**Meniscotomy Knives**

**Bone Holding Forceps**

**Bone Rongeur Forceps**

**Bone Cutting Forceps**

**Nail Instruments, Finger Ring Saws**

Bone Surgery - Knochenchirurgie  
Meißel und Osteotome  
Bone Chisels and Gouges

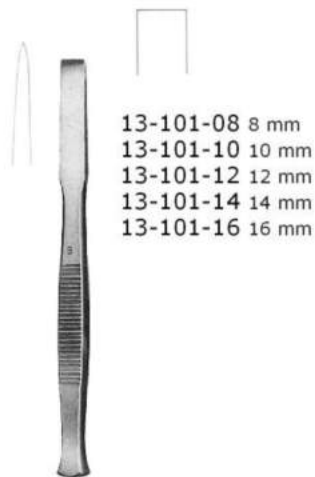

13-101-08 8 mm  
13-101-10 10 mm  
13-101-12 12 mm  
13-101-14 14 mm  
13-101-16 16 mm

13-101-08 - 13-101-16  
13.5 cm/ 5 1/4"

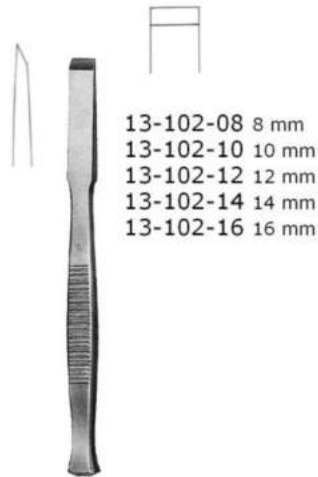

13-102-08 8 mm  
13-102-10 10 mm  
13-102-12 12 mm  
13-102-14 14 mm  
13-102-16 16 mm

13-102-08 - 13-102-16  
13.5 cm/ 5 1/4"

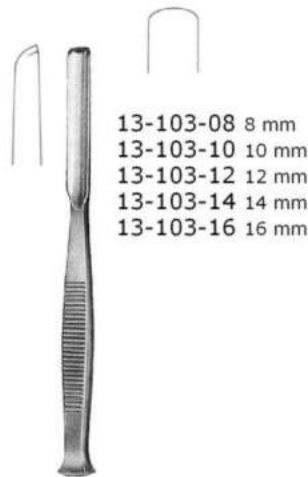

13-103-08 8 mm  
13-103-10 10 mm  
13-103-12 12 mm  
13-103-14 14 mm  
13-103-16 16 mm

13-103-08 - 13-103-16  
13.5 cm/ 5 1/4"

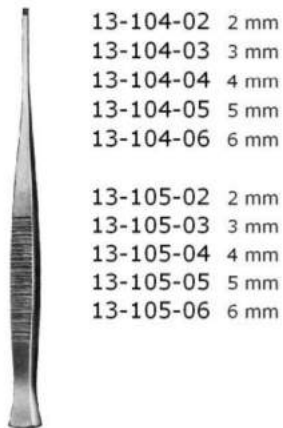

13-104-02 2 mm  
13-104-03 3 mm  
13-104-04 4 mm  
13-104-05 5 mm  
13-104-06 6 mm

13-105-02 2 mm  
13-105-03 3 mm  
13-105-04 4 mm  
13-105-05 5 mm  
13-105-06 6 mm

Partsch  
13-104-02 - 13-104-06  
13.5 cm/ 5 1/4"

13-105-02 - 13-105-06  
17 cm/ 6 3/4"

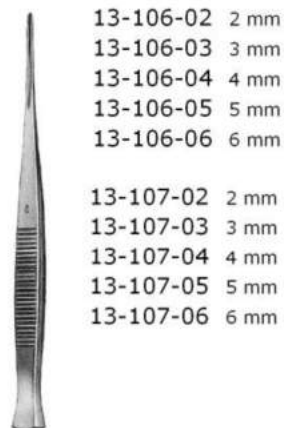

13-106-02 2 mm  
13-106-03 3 mm  
13-106-04 4 mm  
13-106-05 5 mm  
13-106-06 6 mm

13-107-02 2 mm  
13-107-03 3 mm  
13-107-04 4 mm  
13-107-05 5 mm  
13-107-06 6 mm

Partsch  
13-106-02 - 13-106-06  
13.5 cm/ 5 1/4"

13-107-02 - 13-107-06  
17 cm/ 6 3/4"

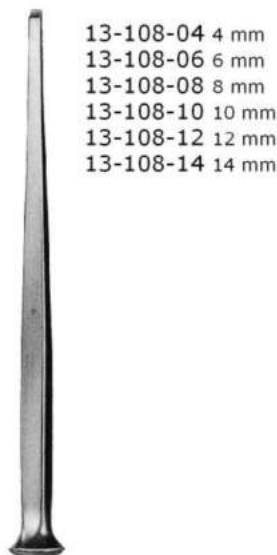

13-108-04 4 mm  
13-108-06 6 mm  
13-108-08 8 mm  
13-108-10 10 mm  
13-108-12 12 mm  
13-108-14 14 mm

Alexander  
13-108-04 - 13-108-14  
18 cm/ 7"

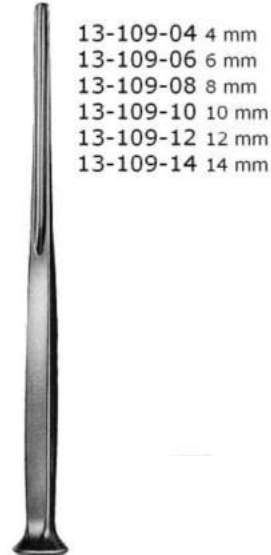

13-109-04 4 mm  
13-109-06 6 mm  
13-109-08 8 mm  
13-109-10 10 mm  
13-109-12 12 mm  
13-109-14 14 mm

Alexander  
13-109-04 - 13-109-14  
18 cm/ 7"

Bone Surgery - Knochenchirurgie  
 Meißel und Osteotome  
 Bone Chisels and Gouges



13-110-10 10 mm  
 13-110-15 15 mm  
 13-110-20 20 mm  
 13-110-25 25 mm

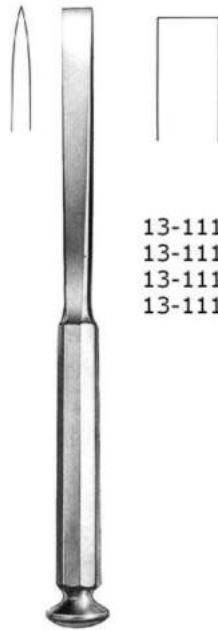

13-111-10 10 mm  
 13-111-15 15 mm  
 13-111-20 20 mm  
 13-111-25 25 mm



13-112-10 10 mm  
 13-112-15 15 mm  
 13-112-20 20 mm  
 13-112-25 25 mm

Stille  
 13-110-10 - 13-112-25  
 20 cm/ 8"



13-113-03 3 mm  
 13-113-04 4 mm  
 13-113-06 6 mm  
 13-113-08 8 mm  
 13-113-10 10 mm  
 13-113-12 12 mm  
 13-113-15 15 mm

Mini-Lambotte  
 13-113-03 - 13-113-15  
 13 cm/ 5"

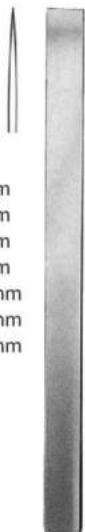

13-114-03 3 mm  
 13-114-04 4 mm  
 13-114-06 6 mm  
 13-114-08 8 mm  
 13-114-10 10 mm  
 13-114-12 12 mm  
 13-114-15 15 mm

Mini-Lambotte  
 13-114-03 - 13-114-15  
 17 cm/ 6 1/2"



13-115-15  
 13-116-15 15 mm  
 13-115-20  
 13-116-20 20 mm  
 13-115-25  
 13-116-25 25 mm  
 13-115-30  
 13-116-30 30 mm  
 13-115-38  
 13-116-38 38 mm  
 13-115-44  
 13-116-44 44 mm  
 13-115-50  
 13-116-50 50 mm

Lambotte  
 13-115-15 13-115-50  
 24 cm/ 9 1/2"

Lambotte  
 13-116-15 - 13-116-50  
 23 cm/ 9"

Bone Surgery - Knochenchirurgie  
Meißel und Osteotome  
Bone Chisels and Gouges



13-117-05 05 mm  
13-117-10 10 mm  
13-117-15 15 mm

Lexer  
13-117-05 - 13-117-15  
25 cm/ 10"



13-118-05 05 mm  
13-118-10 10 mm  
13-118-15 15 mm

Lexer  
13-118-05 - 13-118-15  
25 cm/ 10"

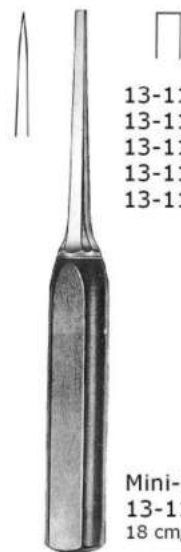

13-119-04 4 mm  
13-119-06 6 mm  
13-119-08 8 mm  
13-119-10 10 mm  
13-119-12 12 mm

Mini-Lexer  
13-119-04 - 13-119-12  
18 cm/ 7"



13-120-04 4 mm  
13-120-06 6 mm  
13-120-08 8 mm  
13-120-10 10 mm  
13-120-12 12 mm

Mini-Lexer  
13-120-04 - 13-120-12  
18 cm/ 7"



13-121-07 7 mm  
13-121-10 10 mm  
13-121-15 15 mm  
13-121-20 20 mm  
13-121-25 25 mm  
13-121-30 30 mm

Lexer  
13-121-07 - 13-121-30  
22 cm/ 8 1/4"



13-122-07 7 mm  
13-122-10 10 mm  
13-122-15 15 mm  
13-122-20 20 mm  
13-122-25 25 mm  
13-122-30 30 mm

Lexer  
13-122-07 - 13-122-30  
22 cm/ 8 1/4"

Handles from artificial wood



Bone Surgery - Knochenchirurgie  
Meißel und Osteotome  
Bone Chisels and Gouges

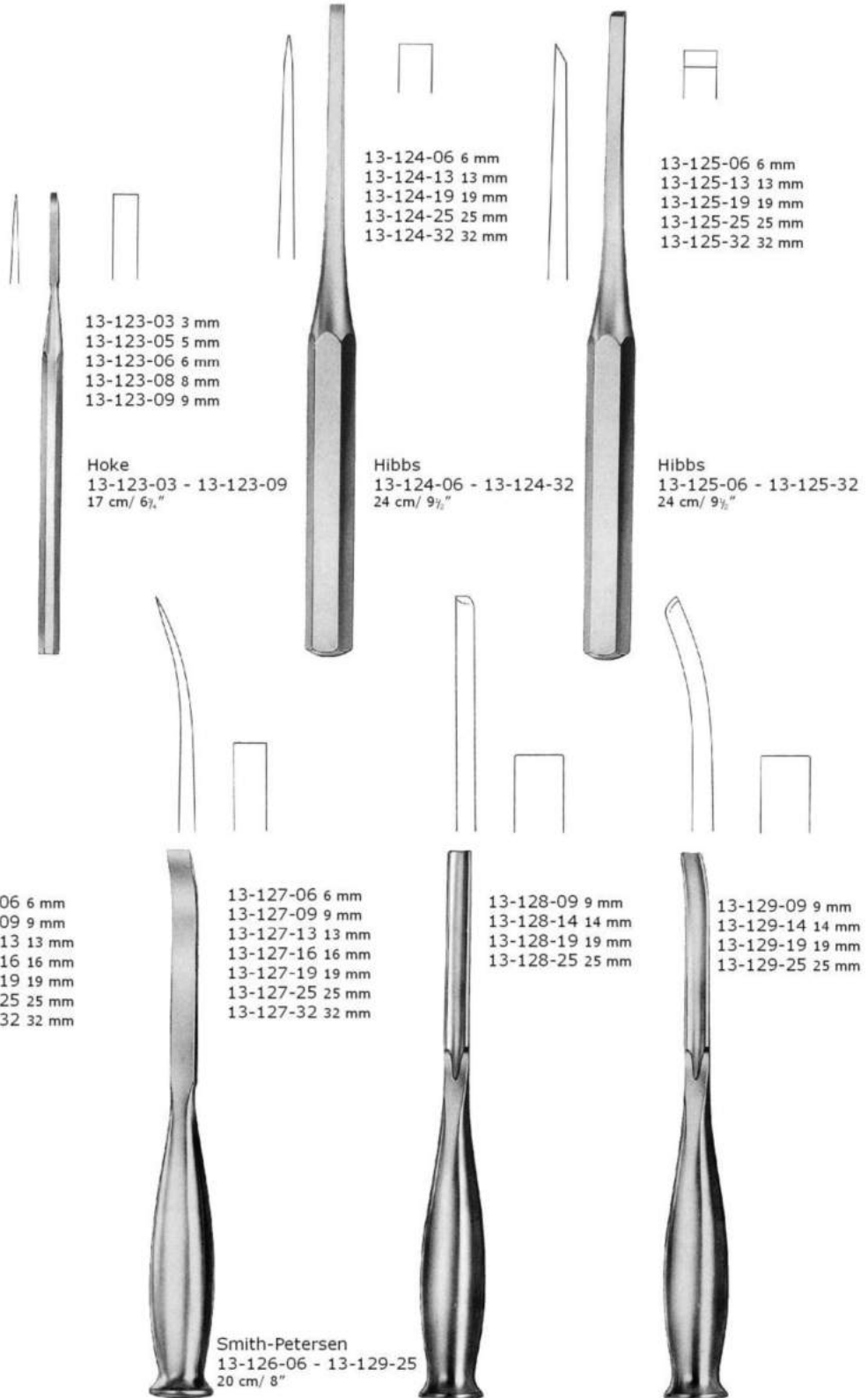

Bone Surgery - Knochenchirurgie  
 Stößel-Raspeln  
 Hemostats



Putti  
 13-130-30  
 30 cm / 12"



Putti  
 13-131-27  
 27 cm / 10½"

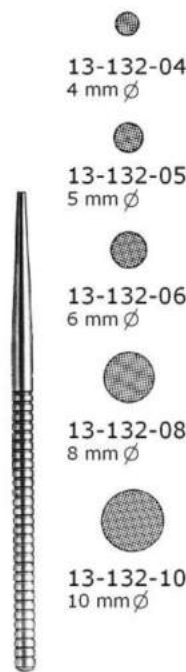

13-132-04  
 4 mm  $\varnothing$

13-132-05  
 5 mm  $\varnothing$

13-132-06  
 6 mm  $\varnothing$

13-132-08  
 8 mm  $\varnothing$

13-132-10  
 10 mm  $\varnothing$

13-132-04 - 13-132-10  
 15 cm / 6"

Bone Surgery - Knochenchirurgie  
Hämmer  
Mallets

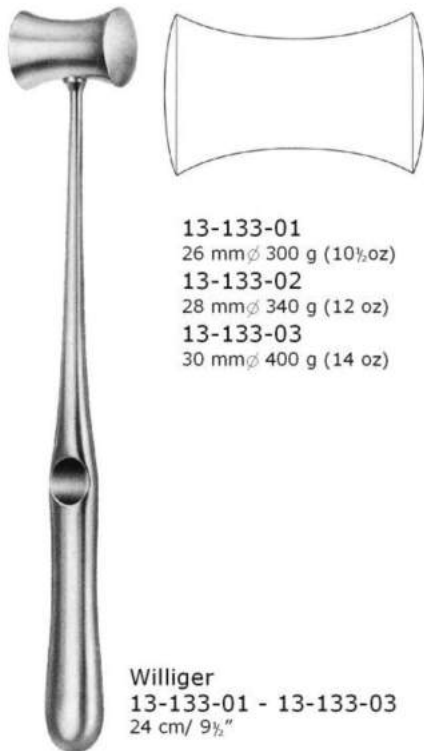

13-133-01  
26 mm  $\phi$  300 g (10 1/2 oz)  
13-133-02  
28 mm  $\phi$  340 g (12 oz)  
13-133-03  
30 mm  $\phi$  400 g (14 oz)

Williger  
13-133-01 - 13-133-03  
24 cm / 9 1/2"



13-134-01  
25 mm  $\phi$  120 g (4 1/4 oz)  
13-134-02  
30 mm  $\phi$  180 g (6 1/2 oz)  
13-134-03  
35 mm  $\phi$  260 g (9 oz)

Doyen  
13-134-01 - 13-134-03  
21 cm / 8 1/4"

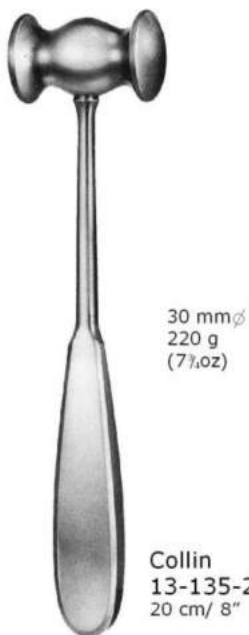

30 mm  $\phi$   
220 g  
(7 1/2 oz)

Collin  
13-135-20  
20 cm / 8"

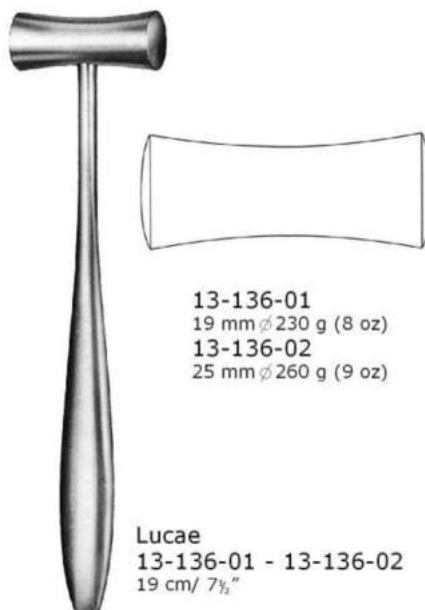

13-136-01  
19 mm  $\phi$  230 g (8 oz)  
13-136-02  
25 mm  $\phi$  260 g (9 oz)

Lucae  
13-136-01 - 13-136-02  
19 cm / 7 1/2"

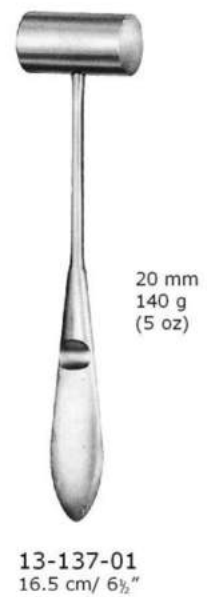

20 mm  
140 g  
(5 oz)

13-137-01  
16.5 cm / 6 1/2"

Bone Surgery - Knochenchirurgie  
Hämmer  
Mallets



22 mm  $\phi$   
200 g  
(7 oz)

Partsch  
13-138-18  
18 cm/ 7"



30 mm  $\phi$   
510 g (18 oz)

13-140-26  
26 cm/ 10½"



26 mm  $\phi$   
320 g (11 oz)

Mead  
13-139-17  
17 cm/ 6½"  
Solid with tuftol tips



Bone Surgery - Knochenchirurgie  
Scharfe Löffel  
Bone Curettes



Volkman  
13-141-40 - 13-141-06  
Handle from artificial wood

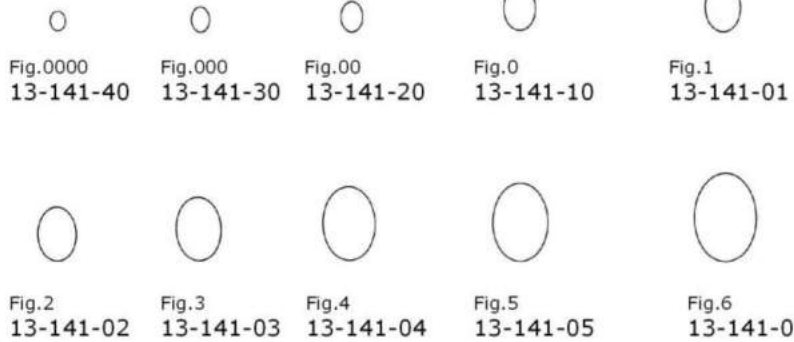

Volkman  
13-142-00 - 13-142-04  
Handle from artificial wood

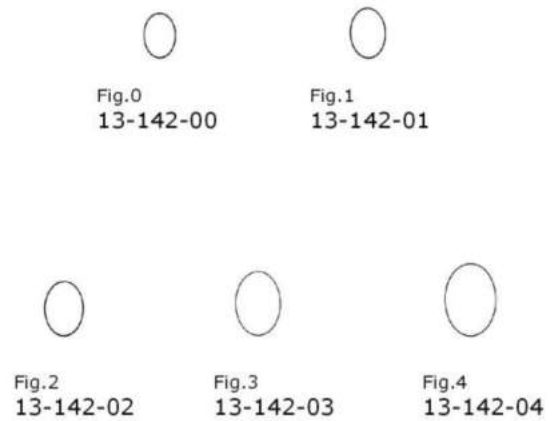

Bone Surgery - Knochenchirurgie  
Scharfe Löffel  
Bone Curettes

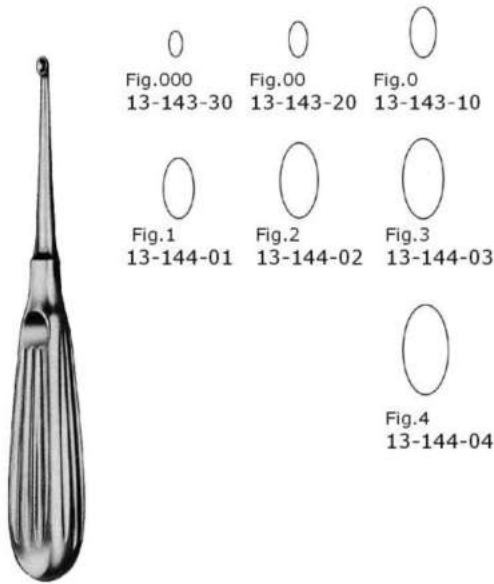

Schede  
13-143-30 - 13-144-04

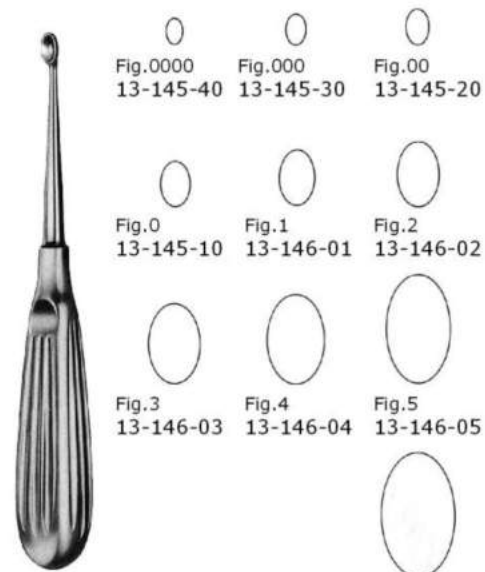

Volkmann  
13-145-40 - 13-146-06

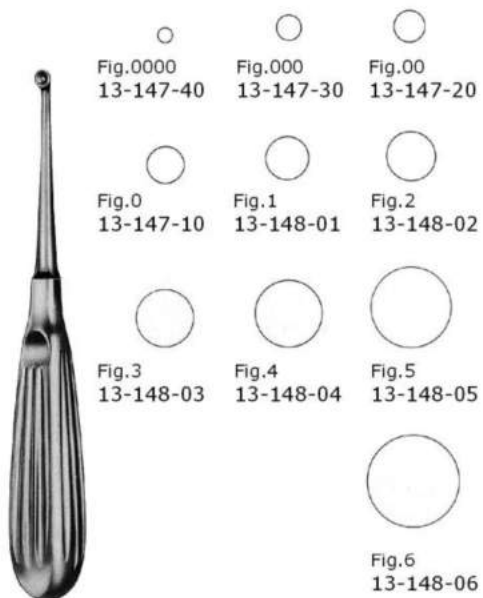

Bruns  
13-147-40 - 13-148-06

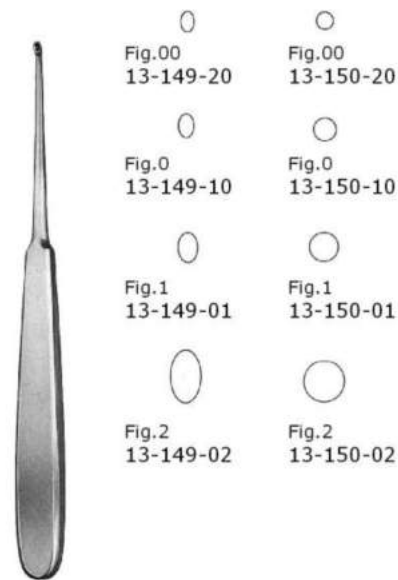

Williger  
13-149-20 - 13-150-02  
18 cm/ 7"

Bone Surgery - Knochenchirurgie  
Scharfe Löffel  
Bone Currettes



13-153-25



13-154-25



13-155-25

13-153-25 - 13-155-25  
25 cm/ 10"



- |           |           |           |
|-----------|-----------|-----------|
| 0         | 0         | 0         |
| Fig.0000  | Fig.000   | Fig.00    |
| 13-151-40 | 13-151-30 | 13-151-20 |
| 0         | 0         | 0         |
| Fig.0     | Fig.1     | Fig.2     |
| 13-151-10 | 13-152-01 | 13-152-02 |
| 0         | 0         | 0         |
| Fig.3     | Fig.4     | Fig.5     |
| 13-152-03 | 13-152-04 | 13-152-05 |

Spratt  
13-151-40 - 13-152-05



- |           |           |           |
|-----------|-----------|-----------|
| 0         | 0         | 0         |
| 13-156-30 | 13-156-20 | 13-156-10 |
| 0         | 0         | 0         |
| 13-156-01 | 13-156-02 | 13-156-03 |
| 0         | 0         | 0         |
| 13-156-04 | 13-156-05 | 13-156-06 |

Bruns  
13-156-30 - 13-156-06  
23 cm/ 9"

Bone Surgery - Knochenchirurgie  
Scharfe Löffel  
Bone Curettes

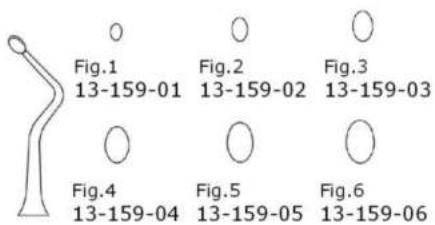
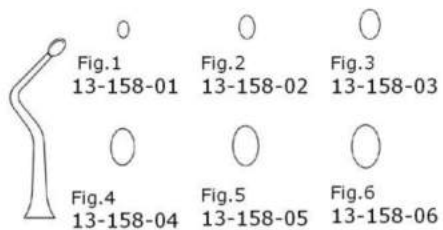
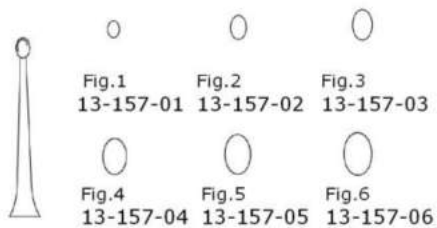

13-157-01 - 13-159-06  
16 cm/ 6 1/4"

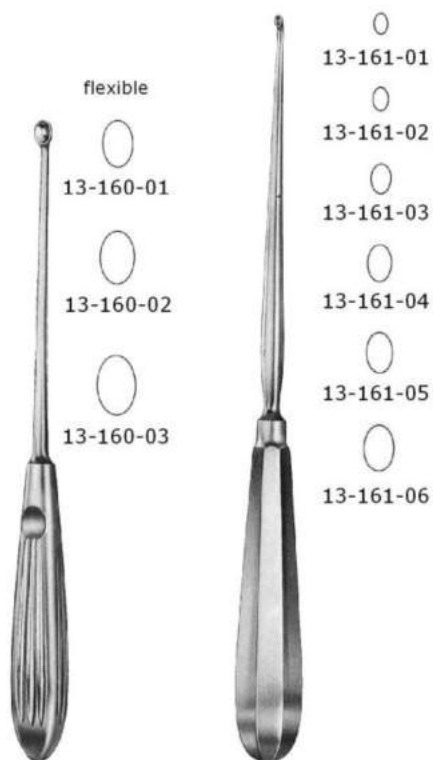

Halle  
13-160-01 - 13-160-03  
21 cm/ 8 1/4"

Simon  
13-161-01 - 13-161-06  
24 cm/ 9 1/2"



Bone Surgery - Knochenchirurgie  
Scharfe Löffel  
Bone Currettes



13-162-21  
21 cm / 8 1/4"

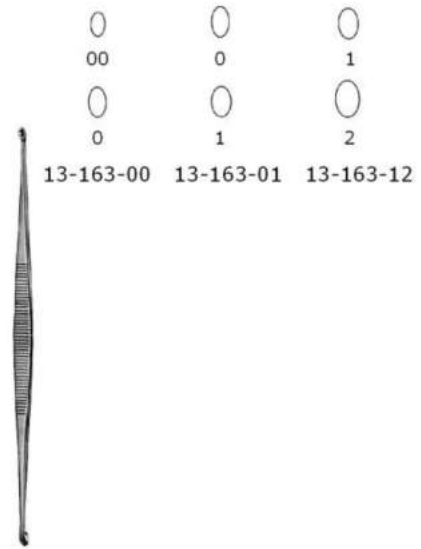

13-163-00 13-163-01 13-163-12

Williger  
13-163-00 - 13-163-12  
13.5 cm / 5 1/4"

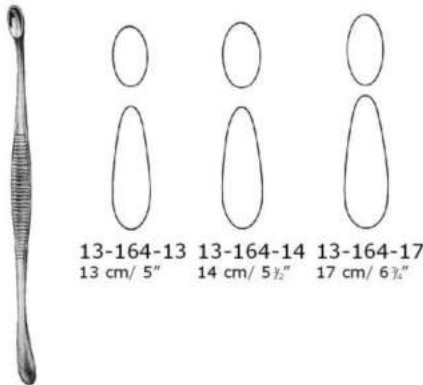

13-164-13 13-164-14 13-164-17  
13 cm / 5" 14 cm / 5 1/2" 17 cm / 6 1/2"

Volkman  
13-164-13 - 13-164-17

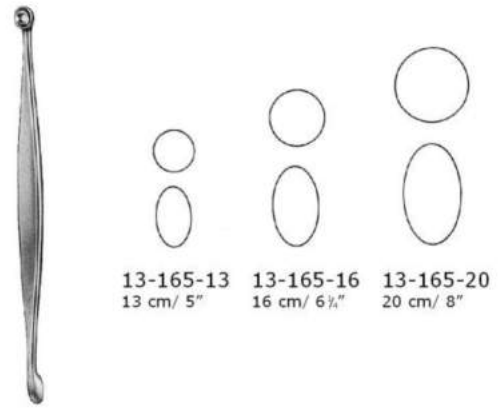

13-165-13 13-165-16 13-165-20  
13 cm / 5" 16 cm / 6 1/4" 20 cm / 8"

Volkman  
13-165-13 - 13-165-20

Bone Surgery - Knochenchirurgie  
Raspatorien  
Periosteal Raspatories

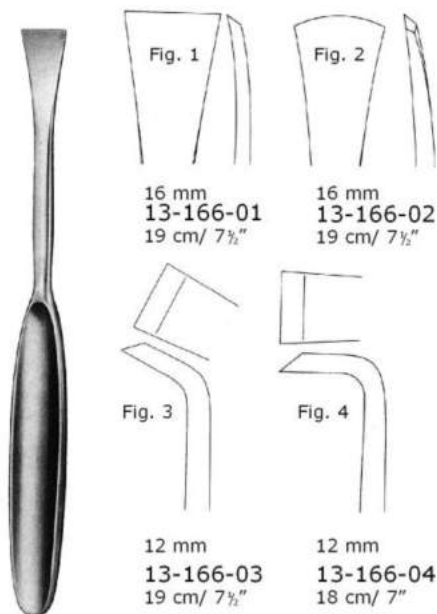

Langenbeck  
13-166-01 - 13-166-04

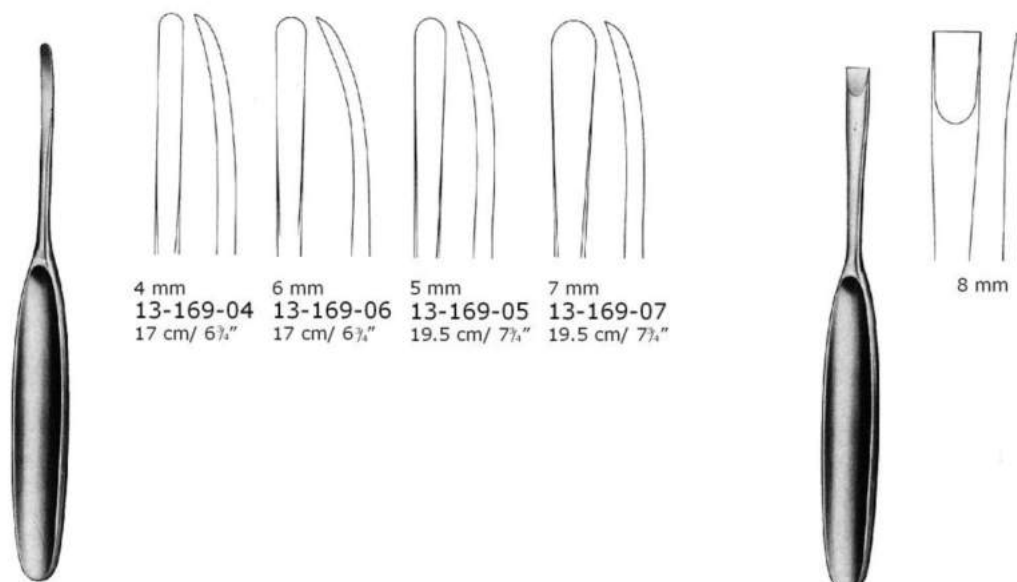

Cushing  
13-169-04 - 13-169-07

Cushing  
13-170-08  
17 cm / 6¾"

Bone Surgery - Knochenchirurgie  
 Raspatorien  
 Periosteal Raspatories

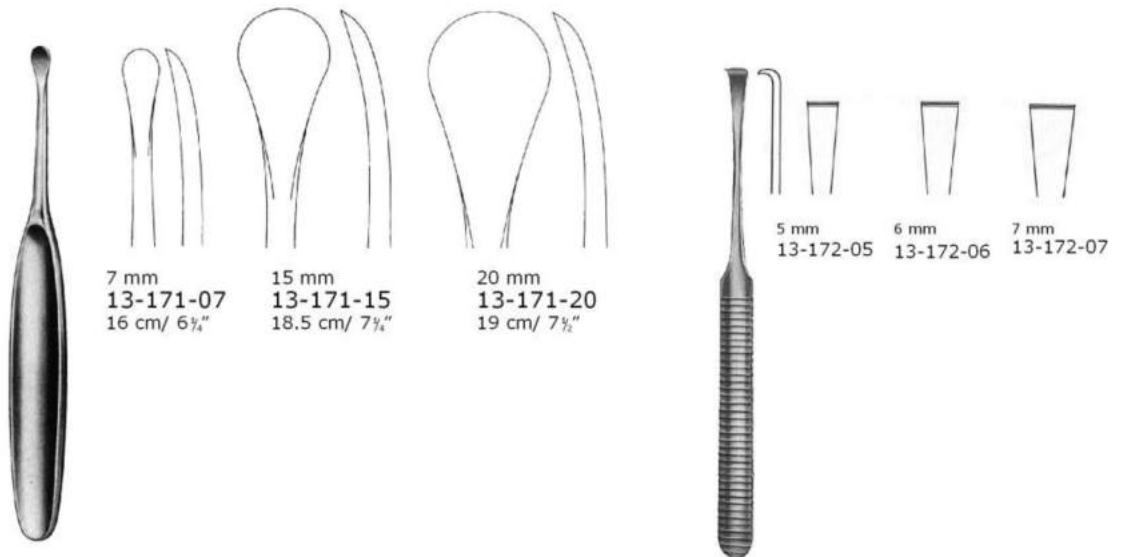

Hoen  
 13-171-07 - 13-171-20

13-172-05 - 13-172-07  
 16 cm/ 6 1/4"

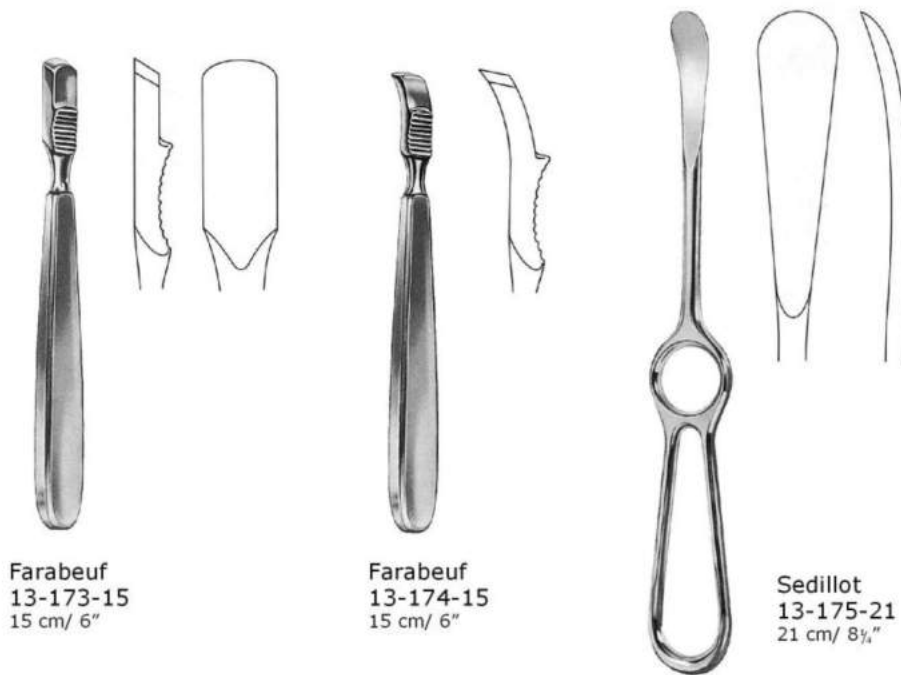

Farabeuf  
 13-173-15  
 15 cm/ 6"

Farabeuf  
 13-174-15  
 15 cm/ 6"

Sedillot  
 13-175-21  
 21 cm/ 8 1/4"

Bone Surgery - Knochenchirurgie  
Raspatorien  
Periosteal Raspatories



13-176-01  
18.5 cm / 7 1/4"



13-176-02  
23 cm / 9"



13-176-03  
18.5 cm / 7 1/4"



13-176-04  
23 cm / 9"



13-176-05  
21.5 cm / 8 1/2"



Semb  
13-176-01 - 13-176-05



13-177-20  
20 cm / 8"



13-178-20  
20 cm / 8"

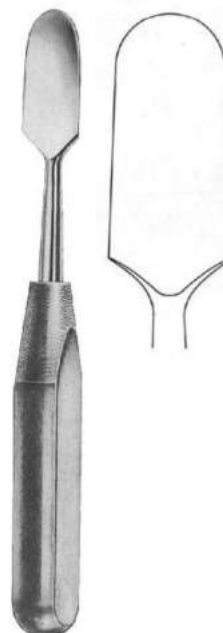

13-179-20  
20 cm / 8"

Handle from artificial wood





Bone Surgery - Knochenchirurgie  
 Raspatorien  
 Periosteal Raspatories



13-180-18  
 18 cm/ 7"



13-181-18  
 18 cm/ 7"



13-182-18  
 18 cm/ 7"

Handle from artificial wood



Williger  
 13-183-13  
 13 cm/ 5"



Williger  
 13-184-16  
 16 cm/ 6 1/4"

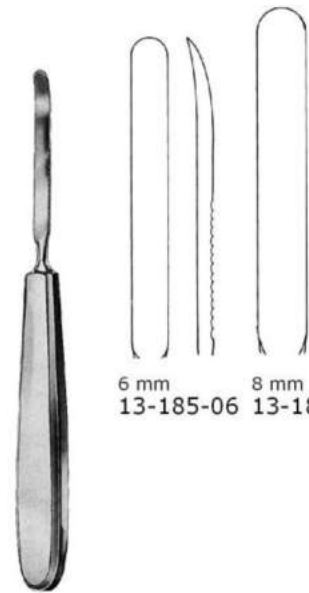

6 mm 8 mm  
 13-185-06 13-185-08

13-185-06 - 13-185-08  
 17 cm/ 6 3/4"



Bone Surgery - Knochenchirurgie  
 Raspatorien  
 Periosteal Raspatories



Doyen  
 13-186-17 - 13-189-17  
 17 cm/ 6 3/4"

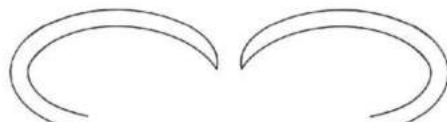

13-186-17

13-187-17



13-188-17

13-189-17



Lambotte  
 13-190-10 - 13-190-25  
 21 cm/ 8 1/4"

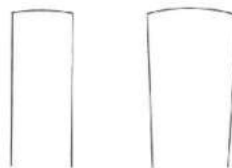

10 mm  
 13-190-10

15 mm  
 13-190-15

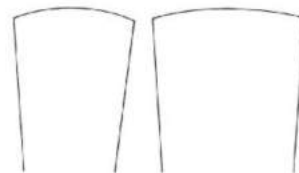

20 mm  
 13-190-20

25 mm  
 13-190-25

Bone Surgery - Knochenchirurgie  
knochenfeile  
Bone Files

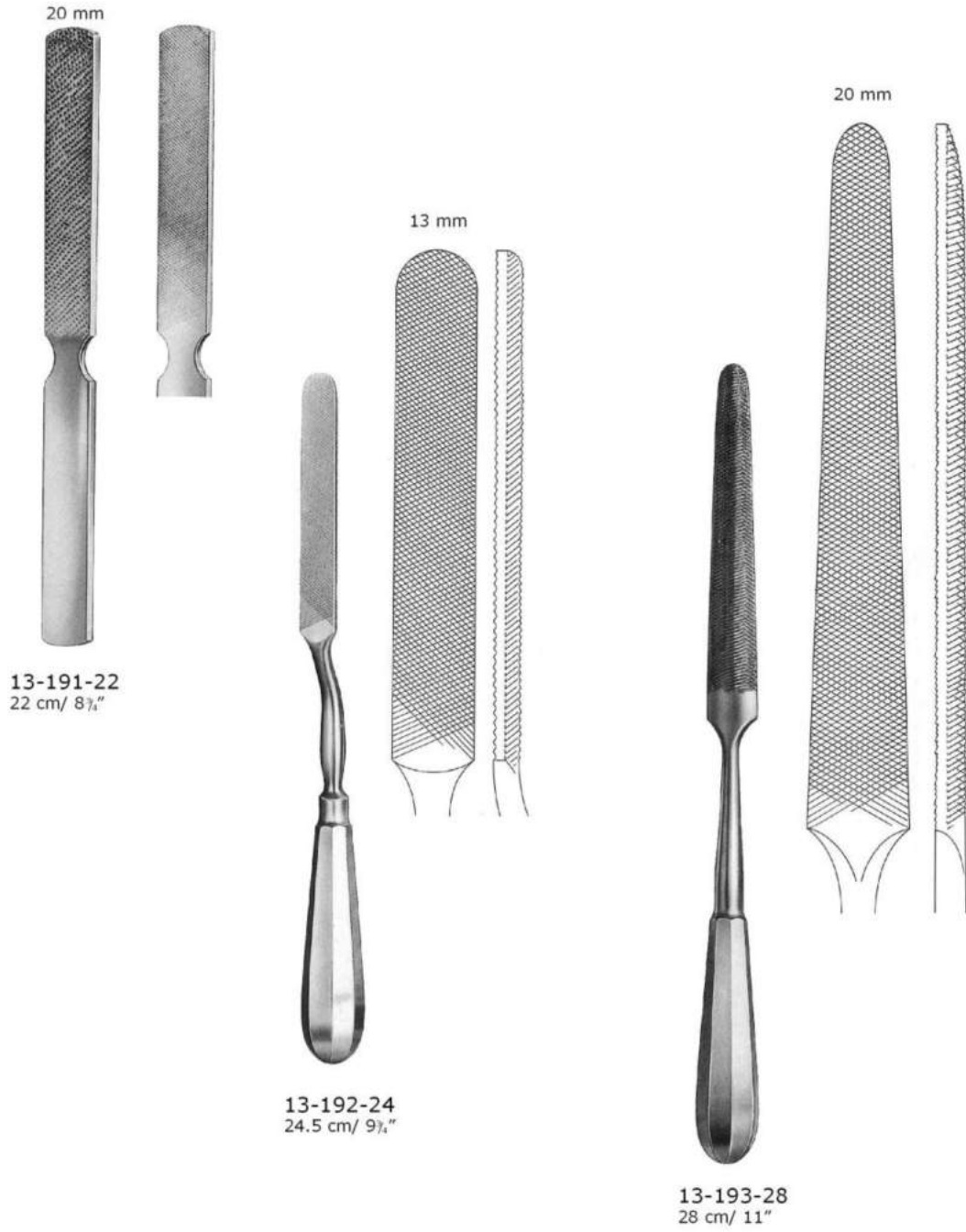

Bone Surgery - Knochenchirurgie  
Elevatoren  
Elevators

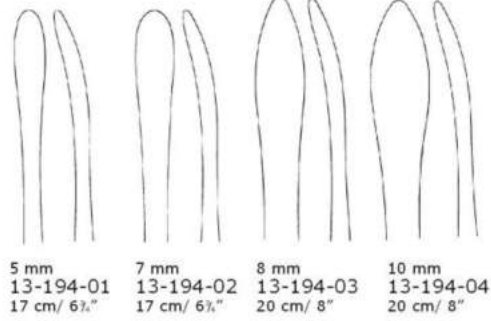

Langenbeck  
13-194-01 - 13-194-04

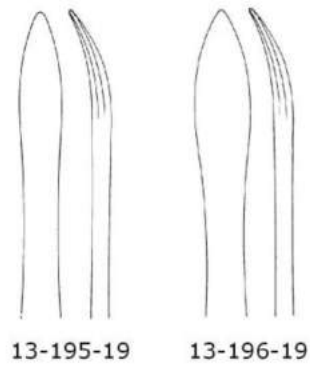

Langenbeck  
13-195-19 - 13-196-19  
19 cm/7 1/2"



Williger  
13-197-17  
17 cm/ 6 1/4"



Williger  
13-198-16  
16 cm/ 6 1/4"

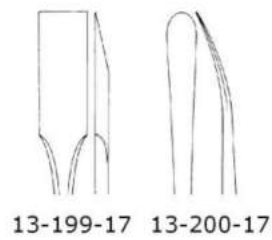

Adson  
13-199-17 - 13-202-17  
17 cm/ 6 1/4"

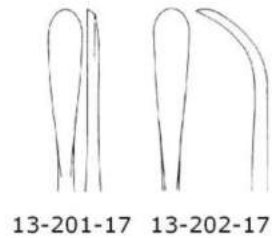



Bone Surgery - Knochenchirurgie  
Elevatoren  
Elevators



Vickers  
13-203-17  
17 cm/ 6 $\frac{3}{4}$ "



Vickers  
13-204-17  
17 cm/ 6 $\frac{3}{4}$ "



13-205-17  
17 cm/ 6 $\frac{3}{4}$ "



13-206-16  
16 cm/ 6 $\frac{3}{4}$ "



Alderdyce  
13-207-21  
21 cm/ 8 $\frac{1}{4}$ "



McDonald  
13-208-19  
19 cm/ 7 $\frac{1}{2}$ "



Bone Surgery - Knochenchirurgie  
Knochenheber  
Bone Levers



13-209-16  
16 mm

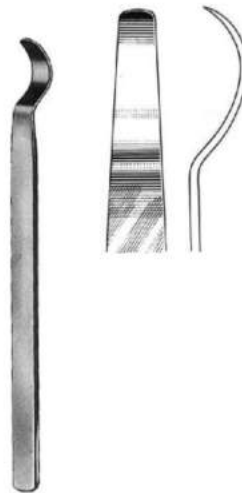

13-210-06  
14 cm/ 5½"



13-211-06



13-211-08



Mini-Hohmann  
13-211-06 - 13-211-08  
16 cm/ 6½"



13-212-15  
15 mm



Bone Surgery - Knochenchirurgie  
Knochenheber  
Bone Levers



Hohmann  
13-213-08  
8mm  
13-213-18  
18mm

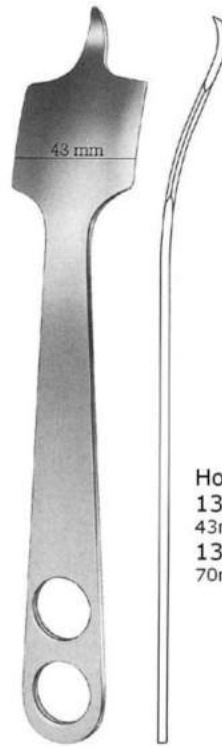

Hohmann  
13-214-43  
43mm  
13-214-70  
70mm

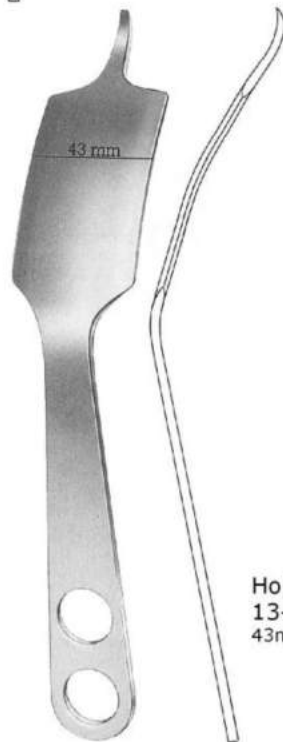

Hohmann  
13-215-43  
43mm



Hohmann  
13-216-35  
35mm  
13-216-24  
24mm

Bone Surgery - Knochenchirurgie  
Knochenheber  
Bone Levers



13-217-24 43mm  
13-218-24 60mm

**Bennett**  
13-217-24 - 13-218-24  
24 cm/ 9½"



**Blount**  
13-219-26  
26 cm/ 10¼"



**Blount**  
13-220-26  
26 cm/ 10¼"

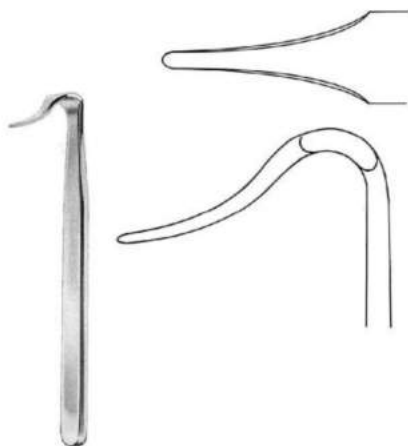

**Blount**  
13-221-18  
18 cm/ 7"

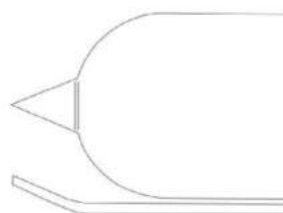

13-222-16 75x30mm  
13-223-16 100x30mm



**Taylor**  
13-222-16 - 13-223-16  
16.5 cm/ 6½"



Bone Surgery - Knochenchirurgie  
Meniskotome  
Meniscotomy Knives



13-224-22 13-225-22

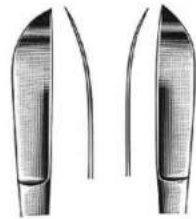

Salenius  
13-226-22  
22 cm/ 8 7/8"



Salenius  
13-227-22  
22 cm/ 8 7/8"



13-228-18  
18 cm/ 7"

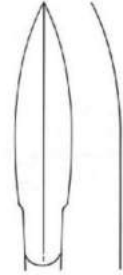

Neff  
13-224-22 - 13-225-22  
22 cm/ 8 7/8"

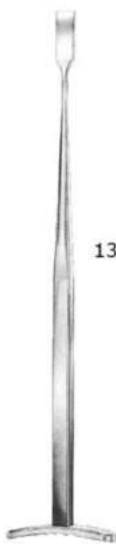

Smillie  
13-229-17 - 13-231-17  
17 cm/ 6 1/4"



13-229-17

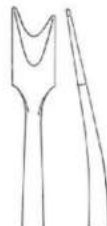

13-230-17



13-231-17



Bircher  
13-232-19 - 13-233-19  
19 cm/ 7 1/2"



13-232-19



13-233-19

Bone Surgery - Knochenchirurgie  
Knochenhaltezangen  
Bone Holding Forceps

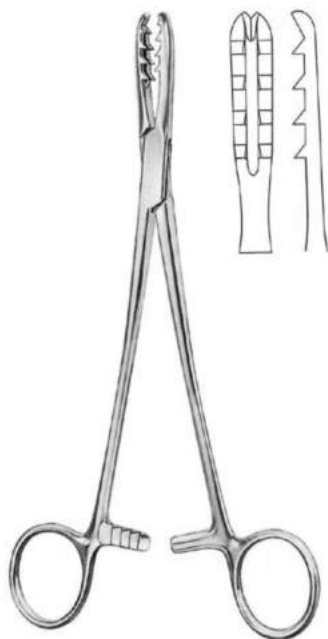

Bircher-Ganske  
13-234-20  
20 cm/ 8"

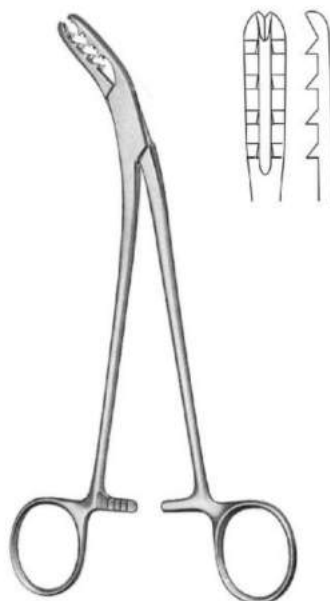

Bircher-Ganske  
13-235-20  
20 cm/ 8"



13-236-14  
14 cm/ 5½"

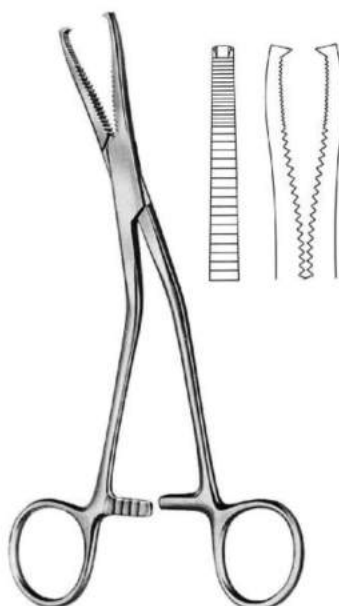

Dingmann  
13-237-19  
19 cm/ 7½"



Bone Surgery - Knochenchirurgie  
Knochenhalte­zangen  
Bone Holding Forceps



13-238-12  
12 cm/ 4 1/4"



13-239-14  
14 cm/ 5 1/2"



13-240-14  
14 cm/ 5 1/2"



13-241-16 16 cm/ 6 1/4"  
13-241-24 24 cm/ 9 1/2"



Lewin  
13-242-18  
18 cm/ 7"

13-241-16 - 13-241-24

228



Bone Surgery - Knochenchirurgie  
Knochenhaltezangen  
Bone Holding Forceps



13-243-17 17 cm/ 6 3/4"  
13-243-21 21 cm/ 8 1/4"

Kern  
13-243-17 - 13-243-21

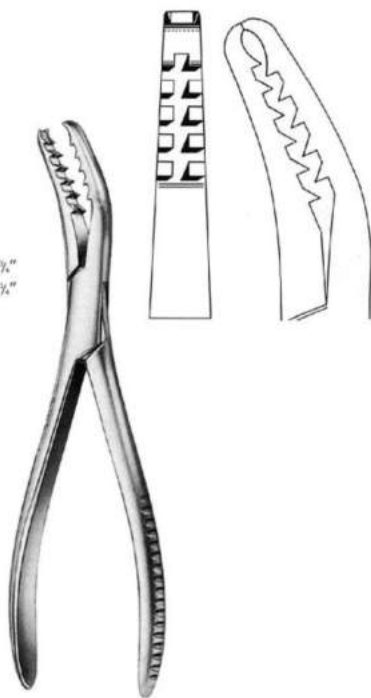

Semb  
13-244-19  
19 cm/ 7 1/2"



Langenbeck  
13-245-21  
21 cm/ 8 1/4"



Fergusson  
13-246-21  
21 cm/ 8 1/4"



Frosch  
13-247-18  
18 cm/ 7"



13-248-20  
20 cm/ 8"





Bone Surgery - Knochenchirurgie  
Knochenhaltezangen  
Bone Holding Forceps



Farabeuf  
13-249-23 23 cm/ 9"  
13-249-26 26cm/ 10½"



Lambotte  
13-250-22 22 cm/ 8½"  
13-250-27 27 cm/ 10½"  
13-250-30 30 cm/ 12"



Farabeuf-Lambotte  
13-251-26  
26 cm/ 10½"



Bone Surgery - Knochenchirurgie  
Knochenhaltezangen  
Bone Holding Forceps

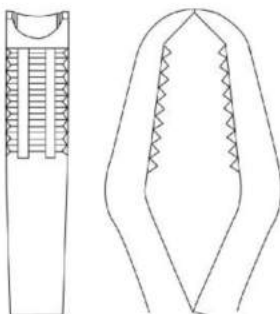

13-252-33 33 cm/ 13"  
without ratchet

13-253-33 33 cm/ 13"  
with ratchet



13-254-15 15 cm/ 6" 2.5mm  
13-254-19 19 cm/ 7 1/2" 6.5mm  
13-254-24 24 cm/ 9 1/2" 9.5mm  
13-254-26 26 cm/ 10 1/2" 10mm  
13-254-28 28 cm/ 11" 11mm

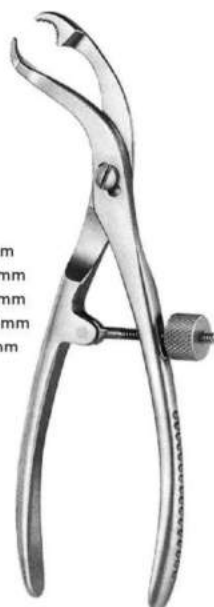

13-254-15 - 13-254-28  
Self-Centering forceps  
with thread fixation

Bone Surgery - Knochenchirurgie  
 Knochenhaltezangen, Retraktoren  
 Bone Holding Forceps, Retractors



13-255-01 25 cm/ 10" 9.5mm  
 13-255-02 26 cm/ 10 1/2" 10.5mm  
 13-255-03 27 cm/ 11" 12mm

Verbrugge  
 13-255-01 - 13-255-03



Verbrugge  
 13-256-01  
 17.5 cm/ 6 1/2"



Amputating Retractors

Percy  
 13-257-30

Bone Surgery - Knochenchirurgie  
Hohlmeißelzangen  
Bone Rongeur Forceps

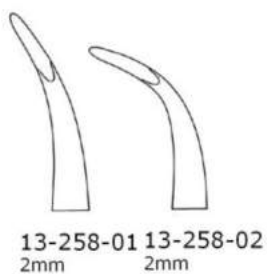

Stellbrink  
13-258-01 - 13-258-02  
17 cm/ 6 3/4"



Hartmann  
13-259-18  
18.5 cm/ 7 1/2"



Friedman  
13-260-14  
14 cm/ 5 1/2"



Friedman-Vickers  
13-261-14  
14 cm/ 5 1/2"



Lempert  
13-262-19  
19 cm/ 7 1/2"



Cleveland  
13-263-17  
17 cm/ 6 3/4"



Mead  
13-264-16  
16.5 cm/ 6 1/2"



Bone Surgery - Knochenchirurgie  
Hohlmeißelzangen  
Bone Rongeur Forceps

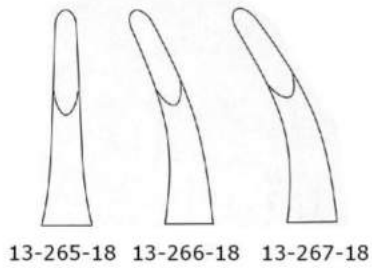

13-265-18 13-266-18 13-267-18

Jansen  
13-265-18 - 13-267-18  
18 cm/ 7"

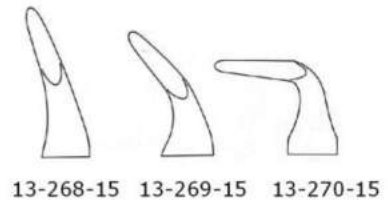

13-268-15 13-269-15 13-270-15

Blumenthal  
13-268-15 - 13-270-15  
15 cm/ 6"

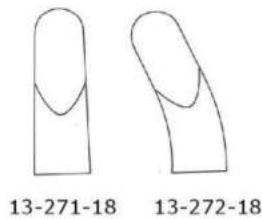

13-271-18 13-272-18

Luer  
13-271-18 - 13-272-18  
18 cm/ 7"

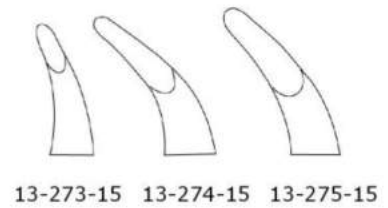

13-273-15 13-274-15 13-275-15

Luer  
13-273-15 - 13-275-15  
15 cm/ 6"

Bone Surgery - Knochenchirurgie  
Hohlmeißelzangen  
Bone Rongeur Forceps

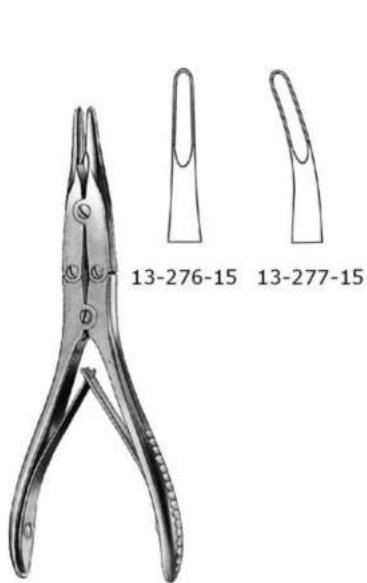

**Bohler**  
13-276-15 - 13-277-15  
15 cm/ 6"



**Beyer**  
13-278-18  
18 cm/ 7"



**Zaufal-Jansen**  
13-279-18  
18 cm/ 7"



**Mayfield**  
13-280-17  
17 cm/ 6 1/2"



**Marquardt**  
13-281-20  
20 cm/ 8"



**Ruskin**  
13-282-18  
18 cm/ 7"  
13-282-23  
23 cm/ 9"



Bone Surgery - Knochenchirurgie  
Hohlmeißelzangen  
Bone Rongeur Forceps



Frykholm  
13-283-24  
24 cm/ 9 1/2"



Stille  
13-284-23  
23 cm/ 9"



13-285-02    13-285-03    13-285-04

Echlin  
13-285-02 - 13-285-04  
23 cm/ 9"



Stille-Ruskin  
13-286-23  
23 cm/ 9"



Bone Surgery - Knochenchirurgie  
Hohlmeißelzangen  
Bone Rongeur Forceps

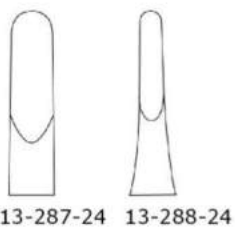

Leksell-Stille  
13-287-24 - 13-288-24  
24 cm/ 9½"



Semb  
13-289-22  
22.5 cm/ 9"

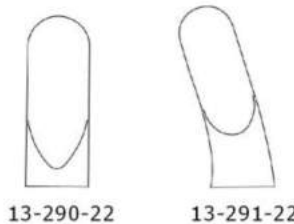

Stille-Luer  
13-290-22 - 13-291-22  
22 cm/ 8¾"





**Markwalder**  
13-292-20  
20 cm/ 8"



**Cottle-Kazanjian**  
13-293-19  
19 cm/ 7½"



13-294-14 14 cm/ 5½"  
13-294-17 17 cm/ 6¾"  
13-294-19 19 cm/ 7½"  
13-294-22 22 cm/ 8¾"



13-295-14 14 cm/ 5½"  
13-295-17 17 cm/ 6¾"  
13-295-19 19 cm/ 7½"  
13-295-22 22 cm/ 8¾"



Bone Surgery - Knochenchirurgie  
 Knochensplitterzangen  
 Bone Cutting Forceps



Cleveland  
 13-296-17  
 17 cm/ 6 7/8"



Cleveland  
 13-297-15  
 15 cm/ 6"



13-298-15

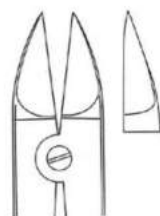

13-299-15



13-300-18 13-301-18

13-298-15 - 13-299-15  
 15 cm/ 6"

Ruskin-Liston  
 13-300-18 - 13-301-18  
 18.5 cm/ 7 1/2"

Bone Surgery - Knochenchirurgie  
Hohlmeißelzangen  
Bone Rongeur Forceps



13-302-23 23 cm/ 9"str  
13-302-27 27 cm/ 10½"str

13-303-23 23 cm/ 9"cvd  
13-303-27 27 cm/ 10½"cvd

Stille-Luer  
13-302-23 - 13-303-27



13-305-30

Sauerbruch  
13-304-30 - 13-305-30  
30 cm/ 12"

Bone Surgery - Knochenchirurgie  
Knochensplitterzangen  
Bone Cutting Forceps



Stille-Liston  
13-306-27  
27 cm/ 10½"



Stille-Liston  
13-307-27  
27 cm/ 10½"



13-308-23  
23 cm/ 9"  
13-308-27  
27 cm/ 10½"

Stille-Liston  
13-308-23 - 13-308-27



Bone Surgery - Knochenchirurgie  
Knochensplitterzangen  
Bone Cutting Forceps



Semb  
13-309-24  
24 cm / 9½"



Liston-Key  
13-310-27  
27 cm / 10½"

Bone Surgery - Knochenchirurgie  
 Instrumente für Finger- und Zehennägel  
 Nail instruments, Finger Ring Saws

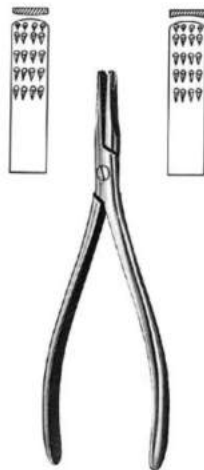

Radolf  
 13-311-13  
 13.5 cm/ 5 1/4"

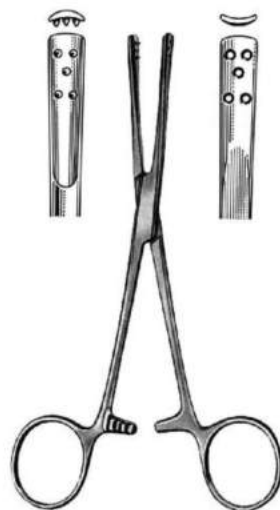

Penner  
 13-312-15  
 15 cm/ 6"



Plier Action  
 13-313-17  
 17 cm/ 6 3/4"  
 Spare blade  
 13-314-01



Thumb Action  
 13-315-16  
 16 cm/ 6 1/4"  
 Spare blade  
 13-316-01

## CARDIOVASCULAR SURGERY



Rib Contractors, Lung Spatula

Bronchus Forceps

Tissue & Organ Holding Forceps

Atrauma Bulldog Clamps

Atrauma Hamostatic Forceps

Atrauma Cardiovascular Forceps

Atrauma Tissue Forceps

Vascular Dilators

Intim Spatula

Cardiovascular Surgery - Cardiovascular  
Knochen- und Rippenscheren  
Bone and Rib Shears



Gluck  
14-101-22  
22 cm/ 8 $\frac{3}{4}$ "



14-102-22  
22 cm/ 8 $\frac{3}{4}$ "



14-103-23  
23 cm/ 9"





Surgery - Cardiovascular-Chirurgie  
Sternumschere, Sternummeißel  
Sternum Scissors, Sternum Chisel



Lebsche  
14-104-24  
24.5 cm/ 9 $\frac{1}{4}$ "

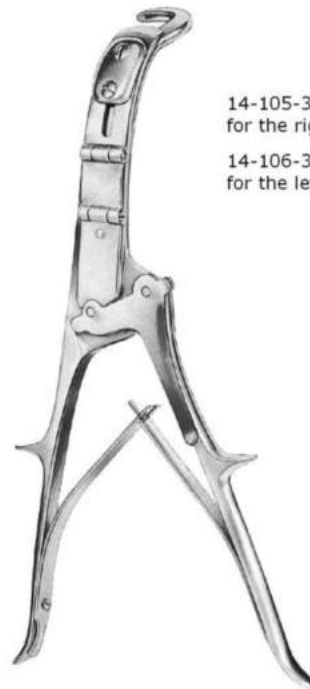

14-105-32  
for the right hand  
14-106-32  
for the left hand

Brunner  
14-105-32 - 14-106-32  
32 cm/ 12 $\frac{1}{2}$ "



Giertz-Stille  
14-107-27  
27 cm/ 10 $\frac{1}{2}$ "



Sauerbruch  
14-108-26  
26 cm/ 10 $\frac{1}{4}$ "



Cardiovascular Surgery - Cardiovascular  
Rippensperrer  
Rib Spreaders



Finocchietto	a	b	c
14-109-01	40mm	45mm	135mm
14-109-02	58mm	62mm	175mm
14-109-03	64mm	65mm	175mm

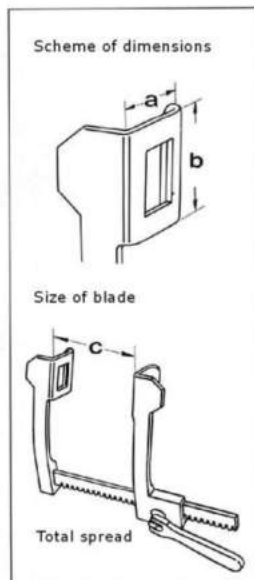
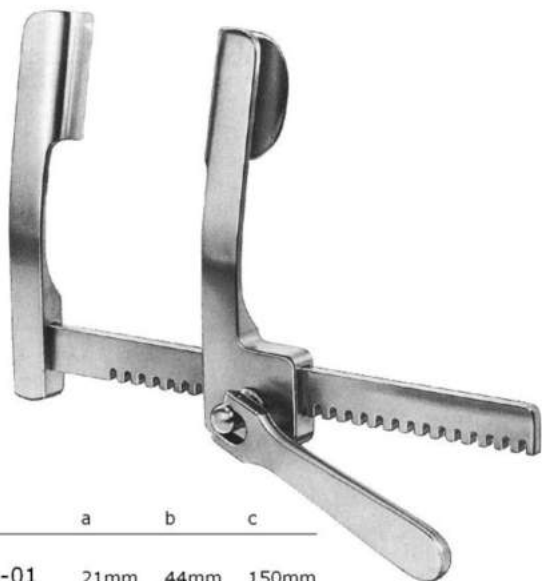

Cooley	a	b	c
for child			
14-110-01	21mm	44mm	150mm
for adults			
14-110-02	35mm	50mm	200mm



Surgery - Cardiovascular-Chirurgie  
Rippensperrer  
Rib Spreaders

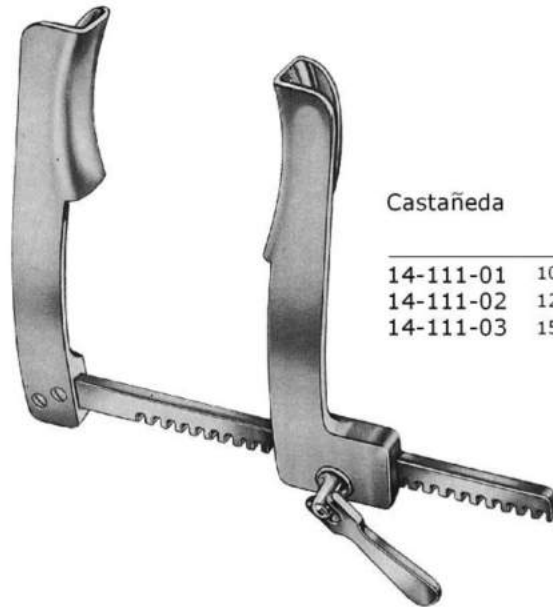

Castañeda

	a	b	c	
14-111-01	10.5 mm	32 mm	65 mm	new born size
14-111-02	12 mm	45 mm	70 mm	infant size
14-111-03	15 mm	60 mm	120 mm	child size



Burford

with 2 pairs of blades

	a	b	c
14-112-01	65mm 47mm	62mm 62mm	200mm
14-112-02	65mm 47mm	62mm 62mm	250mm
14-112-03	65mm 47mm	62mm 62mm	300mm

for adults



Cardiovascular Surgery - Cardiovascular  
Rippensperrer  
Rib Spreaders

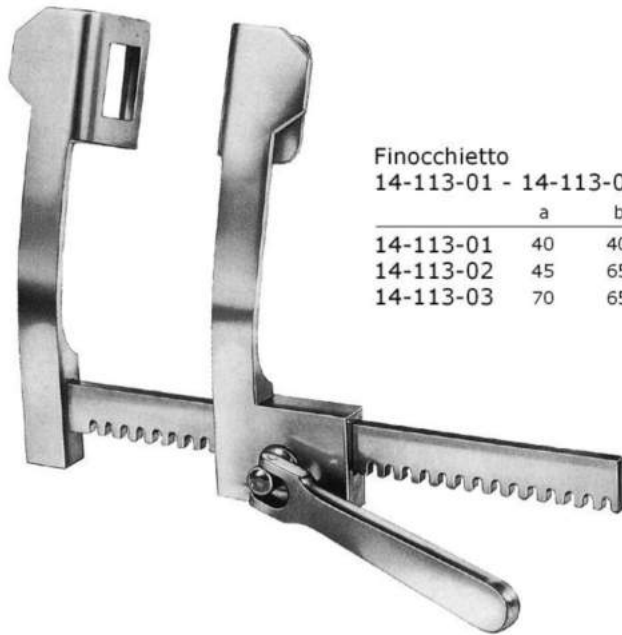

Finocchetto  
14-113-01 - 14-113-03

	a	b	c
14-113-01	40	40	165 mm
14-113-02	45	65	200 mm
14-113-03	70	65	250 mm



Tuffier

	a	b	c
14-114-02	45mm	45mm	160mm

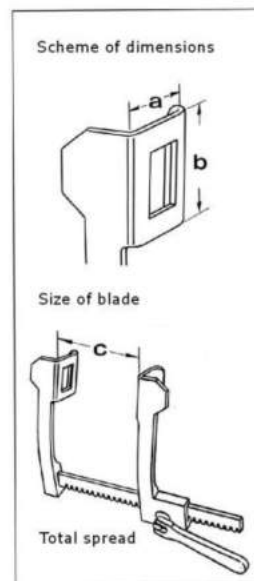





Surgery - Cardiovascular-Chirurgie  
Rippensperrer  
Rib Spreaders

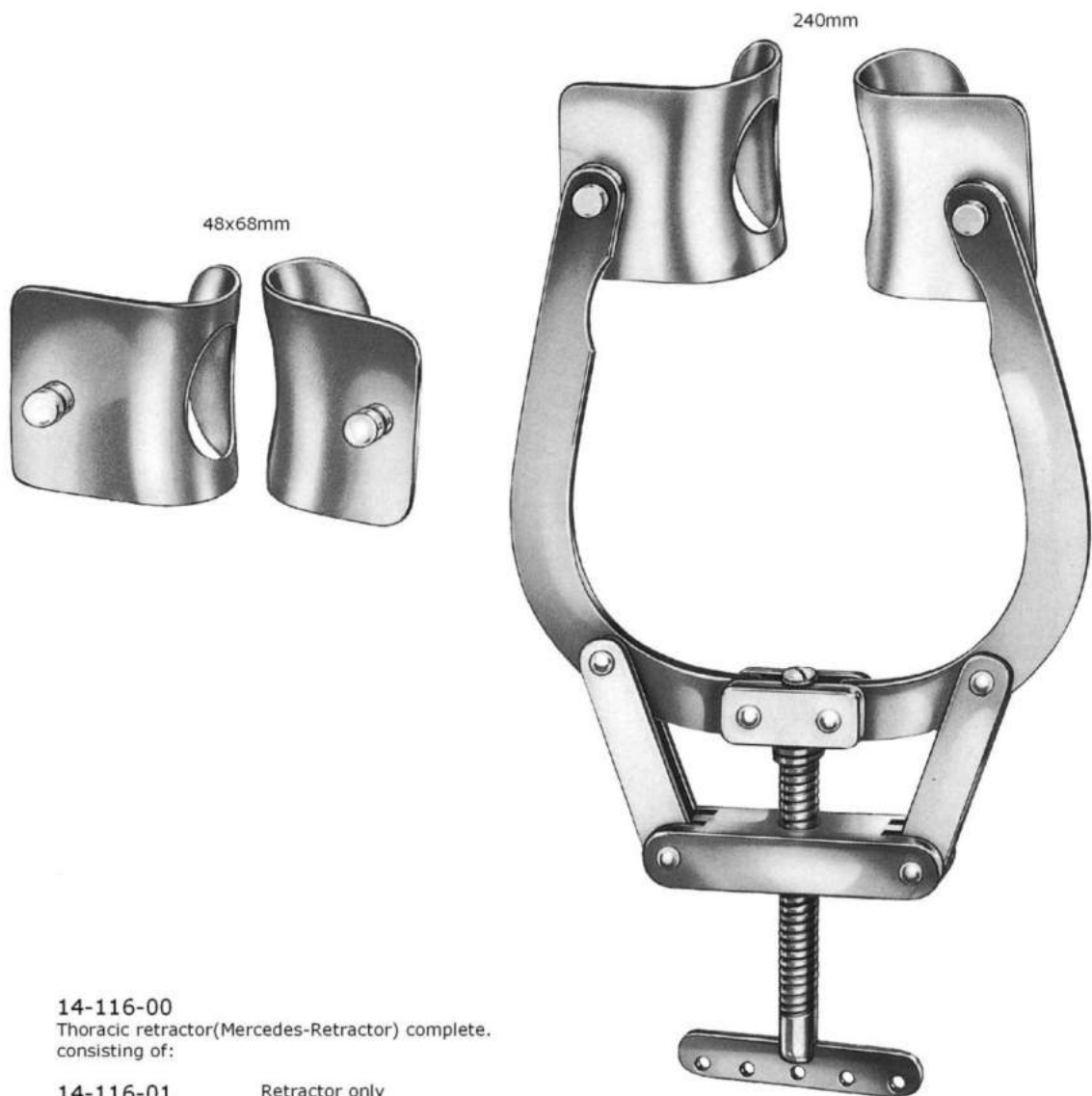

14-116-00  
Thoracic retractor(Mercedes-Retractor) complete,  
consisting of:

- |           |                          |
|-----------|--------------------------|
| 14-116-01 | Retractor only           |
| 14-116-68 | 1 Pair of blades 48x68mm |
| 14-116-75 | 1 pair of blades 70x75mm |



Cardiovascular Surgery - Cardiovascular  
Rippenkontraktoren, Lungenspatel  
Rib Contractors, Lung Spatula



Allison  
14-117-30 30 cm/12"  
14-117-32 32 cm/12½"



Bailey  
14-118-16  
16 cm/ 6¼"



14-119-19  
19 cm/ 7½"



Bailey-Baby  
14-120-14  
14 cm/ 5½"



Surgery - Cardiovascular-Chirurgie  
Bronchusklemmen  
Bronchus Forceps

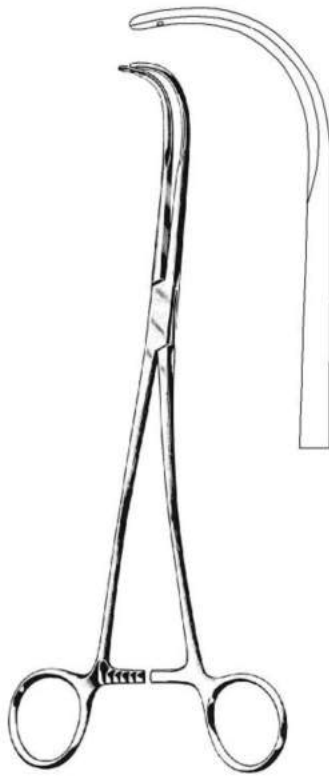

Semb  
14-121-24  
24 cm/ 9½ "



Price-Thomas  
14-122-22  
22 cm/ 8¾ "

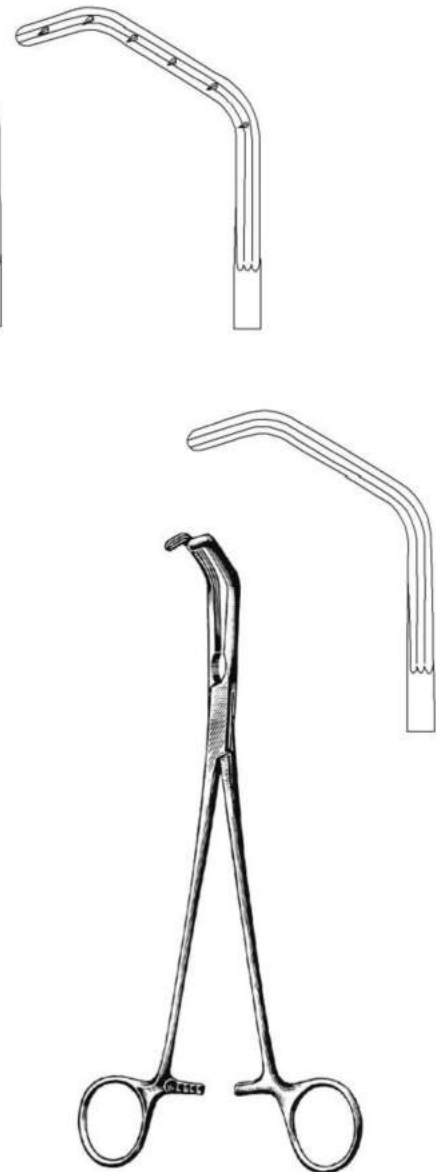

Price-Thomas  
14-123-22  
22 cm/ 8¾ "



Cardiovascular Surgery - Cardiovascular  
Gewebe- und organ-Faßzangen  
Tissue and organ Holding Forceps



Lovelace  
14-124-20  
20 cm/ 8"



Lovelace  
14-125-20  
20 cm/ 8"



Surgery - Cardiovascular-Chirurgie  
 Atrauma Bulldogklemmen  
 Atrauma Bulldog Clamps

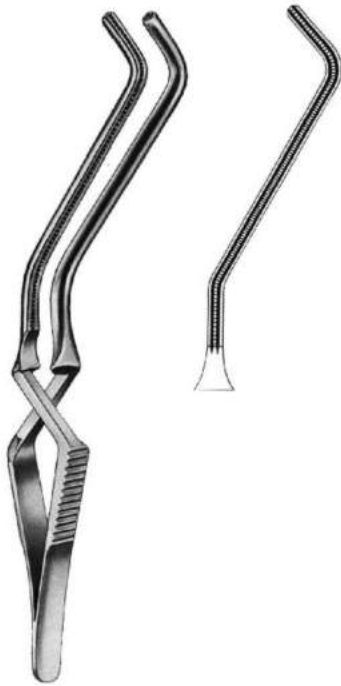

Gregory-Soft  
 14-126-11  
 11.5 cm/ 4½"



14-127-09 9 cm/ 3½"  
 14-127-11 11.5 cm/ 4½"

Gregory-Soft



De Bakey-Satinsky  
 14-128-07  
 7 cm/ 2¾"



Glover  
 14-129-05  
 5 cm/ 2"



Santulli  
 14-130-07  
 7 cm/ 2¾"

Cardiovascular Surgery - Cardiovascular  
 Atrauma Arterienklemmen  
 Atrauma Hemostatic Forceps

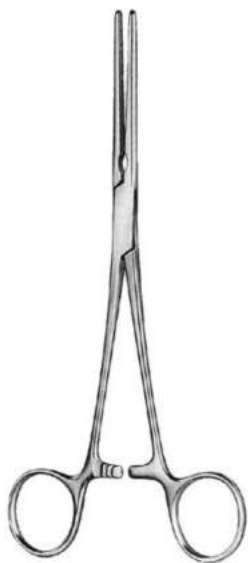

De Bakey-Pean  
 14-131-14 - 14-132-20



- |           |            |           |            |
|-----------|------------|-----------|------------|
| 14-131-14 | 14 cm/ 5½" | 14-132-14 | 14 cm/ 5½" |
| 14-131-16 | 16 cm/ 6¼" | 14-132-16 | 16 cm/ 6¼" |
| 14-131-18 | 18 cm/ 7"  | 14-132-18 | 18 cm/ 7"  |
| 14-131-20 | 20 cm/ 8"  | 14-132-20 | 20 cm/ 8"  |

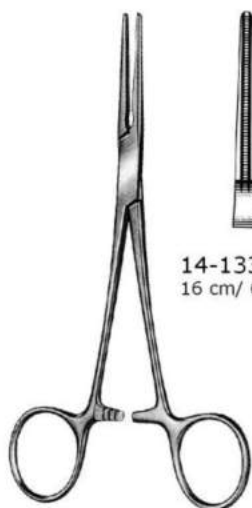

De Bakey-Rankin  
 14-133-16 - 14-134-16



- |           |            |           |            |
|-----------|------------|-----------|------------|
| 14-133-16 | 16 cm/ 6¼" | 14-134-16 | 16 cm/ 6¼" |
|-----------|------------|-----------|------------|



De Bakey-Mosquito  
 14-135-15 - 14-136-15



- |           |           |           |           |
|-----------|-----------|-----------|-----------|
| 14-135-15 | 15 cm/ 6" | 14-136-15 | 15 cm/ 6" |
|-----------|-----------|-----------|-----------|



Surgery - Cardiovascular-Chirurgie  
Atrauma Cardiovascular-Klemmen  
Atrauma Cardiovascular Forceps



Dietrich  
14-137-21  
21 cm/ 8 1/4"



Ochsner  
14-138-23  
23.5 cm/ 9 1/4"



Cardiovascular Surgery - Cardiovascular  
 Atrauma Cardiovascular-Klemmen  
 Atrauma Cardiovascular Forceps



Dardik  
 14-139-00 - 14-139-90

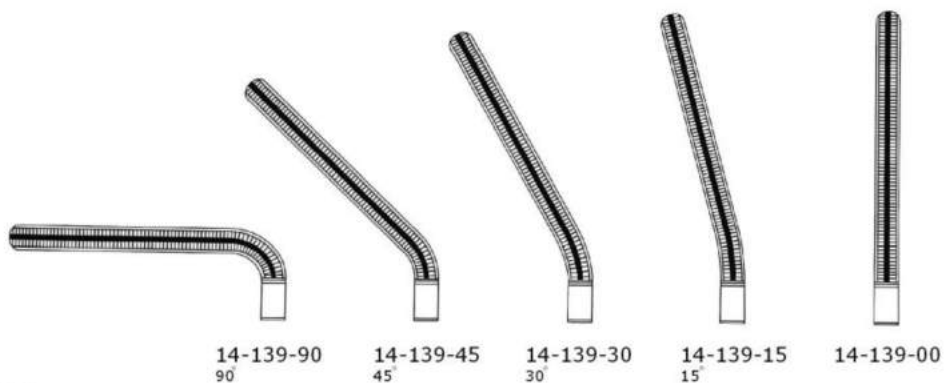

14-139-90  
 90°

14-139-45  
 45°

14-139-30  
 30°

14-139-15  
 15°

14-139-00

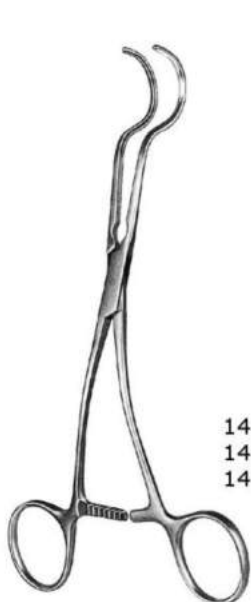

Dale  
 14-140-17 - 14-140-19

- 14-140-17 17 cm/ 6 3/4"
- 14-140-18 18 cm/ 7"
- 14-140-19 18.5 cm/ 7 1/4"

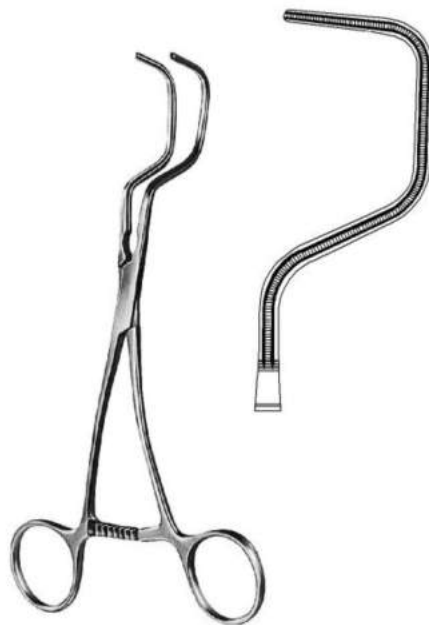

Dale  
 14-141-18  
 18.5 cm/ 7 1/4"





Surgery - Cardiovascular-Chirurgie  
 Atrauma Cardiovascular-Klemmen  
 Atrauma Cardiovascular Forceps



14-142-17  
 Husfeldt  
 17 cm/ 6 3/4"



14-143-18  
 Husfeldt  
 18 cm/ 7"



14-144-18  
 Husfeldt  
 18 cm/ 7"

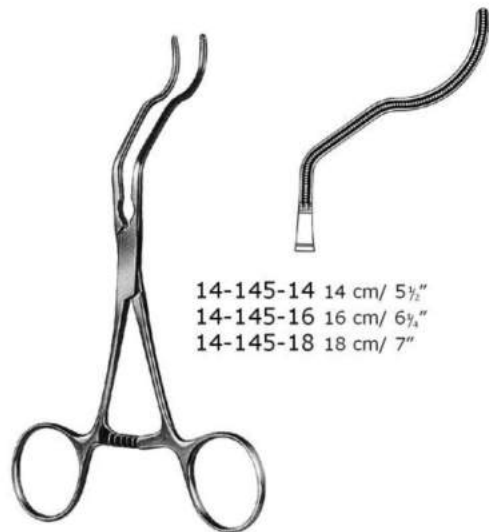

14-145-14 14 cm/ 5 1/2"  
 14-145-16 16 cm/ 6 1/4"  
 14-145-18 18 cm/ 7"

Gregory  
 14-145-14 - 14-145-18



Cardiovascular Surgery - Cardiovascular  
Atrauma Pinzetten  
Atrauma Tissue forceps



2.0mm



Cooley  
14-146-16 16 cm/ 6 1/4"  
14-146-20 20 cm/ 8"



2.0mm



De Bakley  
14-147-16 16 cm/ 6 1/4"  
14-147-20 20 cm/ 8"  
14-147-24 24 cm/ 9 1/2"  
14-147-30 30 cm/ 12"



3.5mm



De Bakley  
14-148-16 16 cm/ 6 1/4"  
14-148-20 20 cm/ 8"  
14-148-24 24 cm/ 9 1/2"  
14-148-30 30 cm/ 12"



1.5mm



De Bakley  
14-149-16 16 cm/ 6 1/4"  
14-149-20 20 cm/ 8"  
14-149-24 24 cm/ 9 1/2"



2.7mm



De Bakley  
14-150-16 16 cm/ 6 1/4"  
14-150-20 20 cm/ 8"  
14-150-24 24 cm/ 9 1/2"  
14-150-30 30 cm/ 12"



2.0mm



De Bakley  
14-151-16 16 cm/ 6 1/4"  
14-151-20 20 cm/ 8"  
14-151-24 24 cm/ 9 1/2"  
14-151-30 30 cm/ 12"



Surgery - Cardiovascular-Chirurgie  
 Atrauma Bulldogklemmen  
 Atrauma Bulldog Clamps

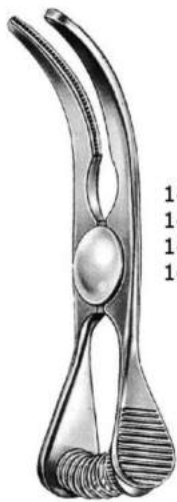

- 14-152-05 5.5 cm/ 2 1/4"
- 14-152-06 6.5 cm/ 2 1/2"
- 14-152-08 8.5 cm/ 3 1/4"
- 14-152-10 10.5 cm/ 4 1/4"

Glover  
 14-152-05 - 14-152-10



- 14-153-06 6 cm/ 2 1/2"
- 14-153-07 7 cm/ 2 3/4"
- 14-153-09 9 cm/ 3 1/2"
- 14-153-11 11.5 cm/ 4 1/2"

Glover  
 14-153-06 - 14-153-11



- 14-154-07 7 cm/ 2 3/4"
- 14-154-08 8 cm/ 3 1/4"
- 14-154-10 10 cm/ 4"
- 14-154-12 11.5 cm/ 4 1/2"

14-154-07 - 14-154-12



- 14-155-07 7.5 cm/ 3"
- 14-155-08 8.5 cm/ 3 1/2"
- 14-155-10 10.5 cm/ 4 1/4"
- 14-155-12 12 cm/ 4 3/4"

14-155-07 - 14-155-12



14-156-23  
 23 cm/ 9"



Cardiovascular Surgery - Cardiovascular  
Atrauma Cardiovascular-Klemmen  
Atrauma Cardiovascular Forceps



Potts  
14-157-22  
22 cm/ 8 7/8"



Potts  
14-158-22  
22 cm/ 8 7/8"

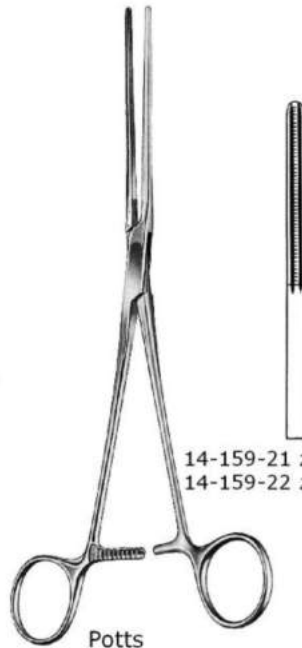

14-159-21 21 cm/ 8 1/4"  
14-159-22 22 cm/ 8 7/8"

Potts  
14-159-21 - 14-159-22



14-160-21 21 cm/ 8 1/4"  
14-160-22 22 cm/ 8 7/8"

Potts  
14-160-21 - 14-160-22



14-161-21 21 cm/ 8 1/4"  
14-161-22 22 cm/ 8 7/8"

Potts  
14-161-21 - 14-161-22





Surgery - Cardiovascular-Chirurgie  
 Atrauma Cardiovascular-Klemmen  
 Atrauma Cardiovascular Forceps



14-162-15 15 cm/ 6"  
 14-162-18 18 cm/ 7"

Bainbridge  
 14-162-15 - 14-162-18

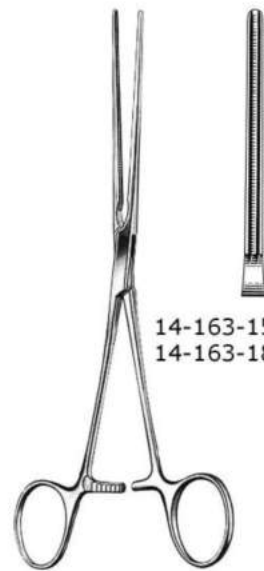

14-163-15 15 cm/ 6"  
 14-163-18 18 cm/ 7"

Bainbridge  
 14-163-15 - 14-163-18

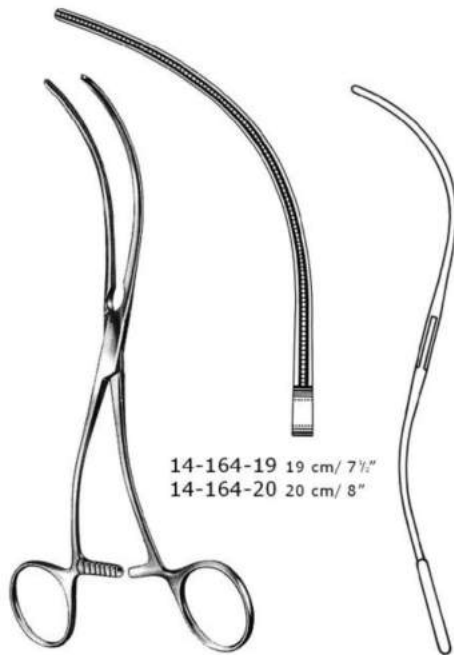

14-164-19 19 cm/ 7 1/2"  
 14-164-20 20 cm/ 8"

De Bakey  
 14-164-19 - 14-164-20



De Bakey  
 14-165-16  
 16 cm/ 6 1/4"



Cardiovascular Surgery - Cardiovascular  
Atrauma Cardiovascular-Klemmen  
Atrauma Cardiovascular Forceps



Satinsky  
14-166-20 - 14-166-26

- 14-166-20 20 cm/ 8"
- 14-166-24 24 cm/ 9½"
- 14-166-25 25 cm/ 10"
- 14-166-26 26.5 cm/ 10½"

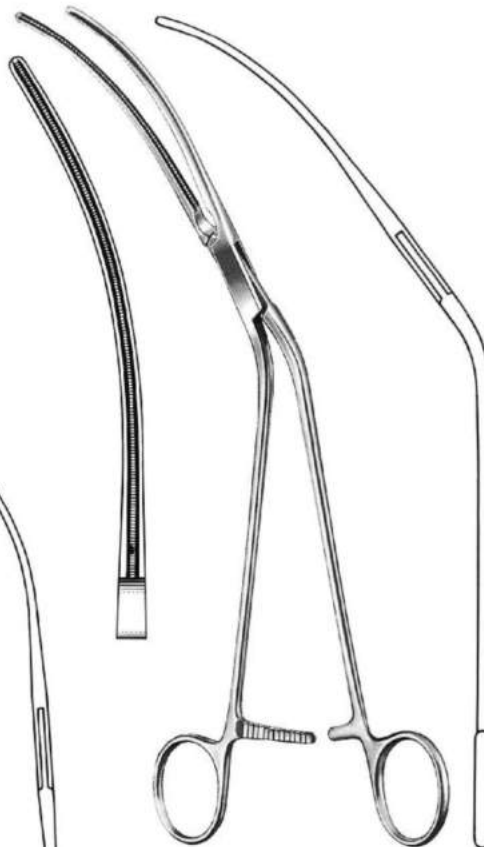

De Bakey  
14-167-28  
28 cm/ 11"



- 14-168-26 26 cm/ 10¼"
- 14-168-27 27 cm/ 10¾"
- 14-168-31 31 cm/ 12¼"
- 14-168-33 33 cm/ 13"

De Bakey  
14-168-26 - 14-168-33

Surgery - Cardiovascular-Chirurgie  
Atrauma Cardiovascular-Klemmen  
Atrauma Cardiovascular Forceps

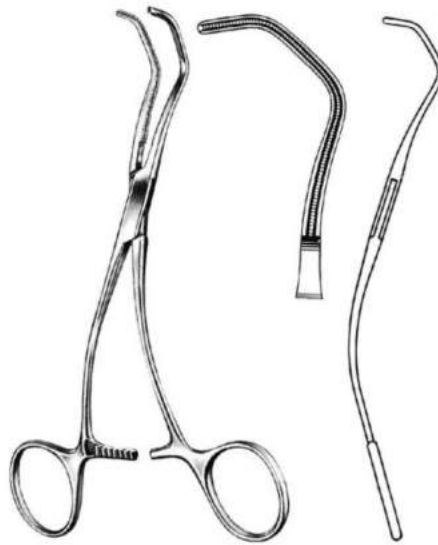

De Bakey  
14-169-17  
17 cm/ 6 7/8"



264

Lambert-kay  
14-170-21 - 14-170-22



14-170-21



14-170-22

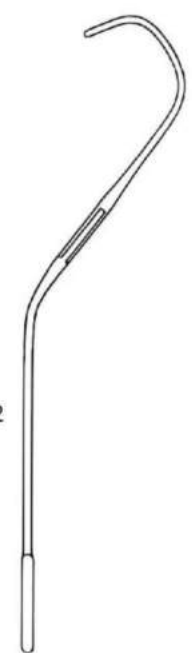

Cardiovascular Surgery - Cardiovascular-  
Gefäß-Dilatatoren  
Vascular Dilators

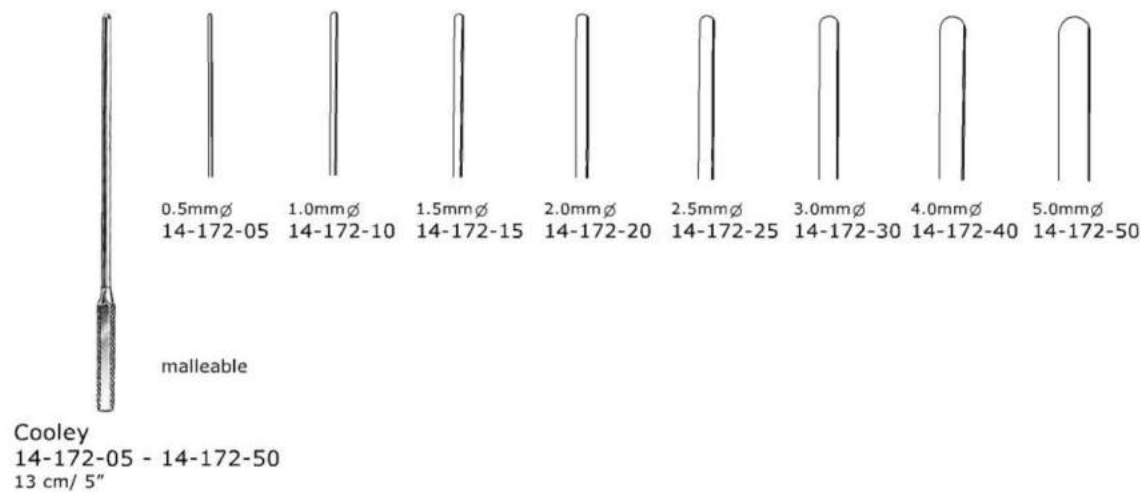
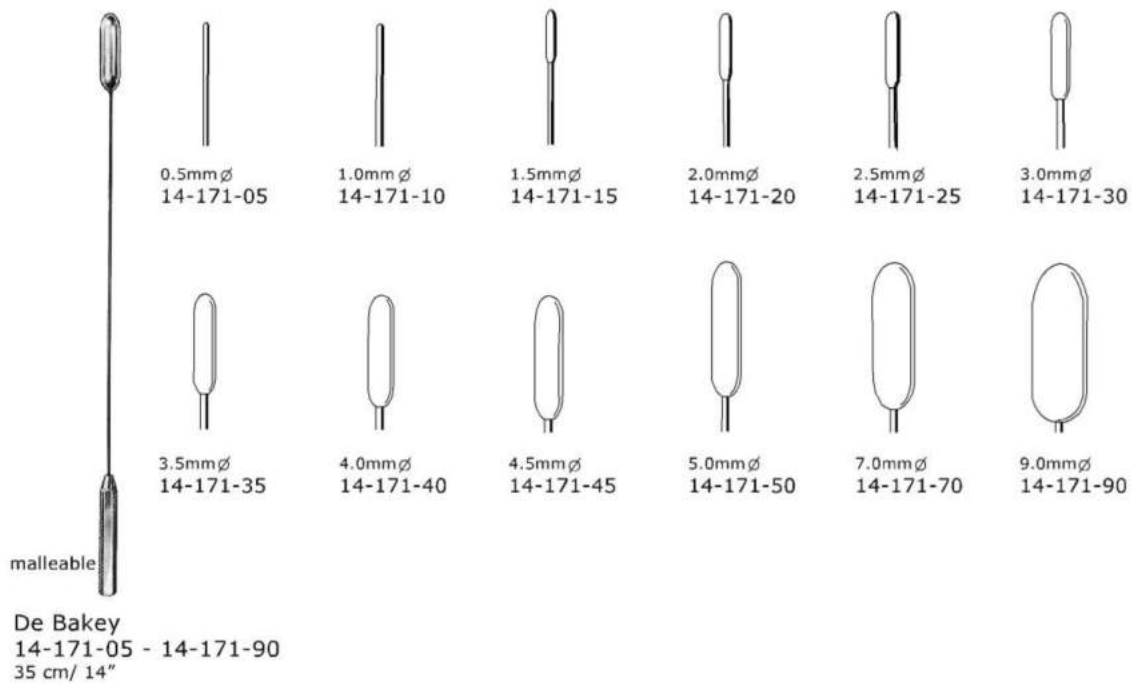





Surgery - Cardiovascular-Chirurgie  
Intima Spatel  
Intima Spatula

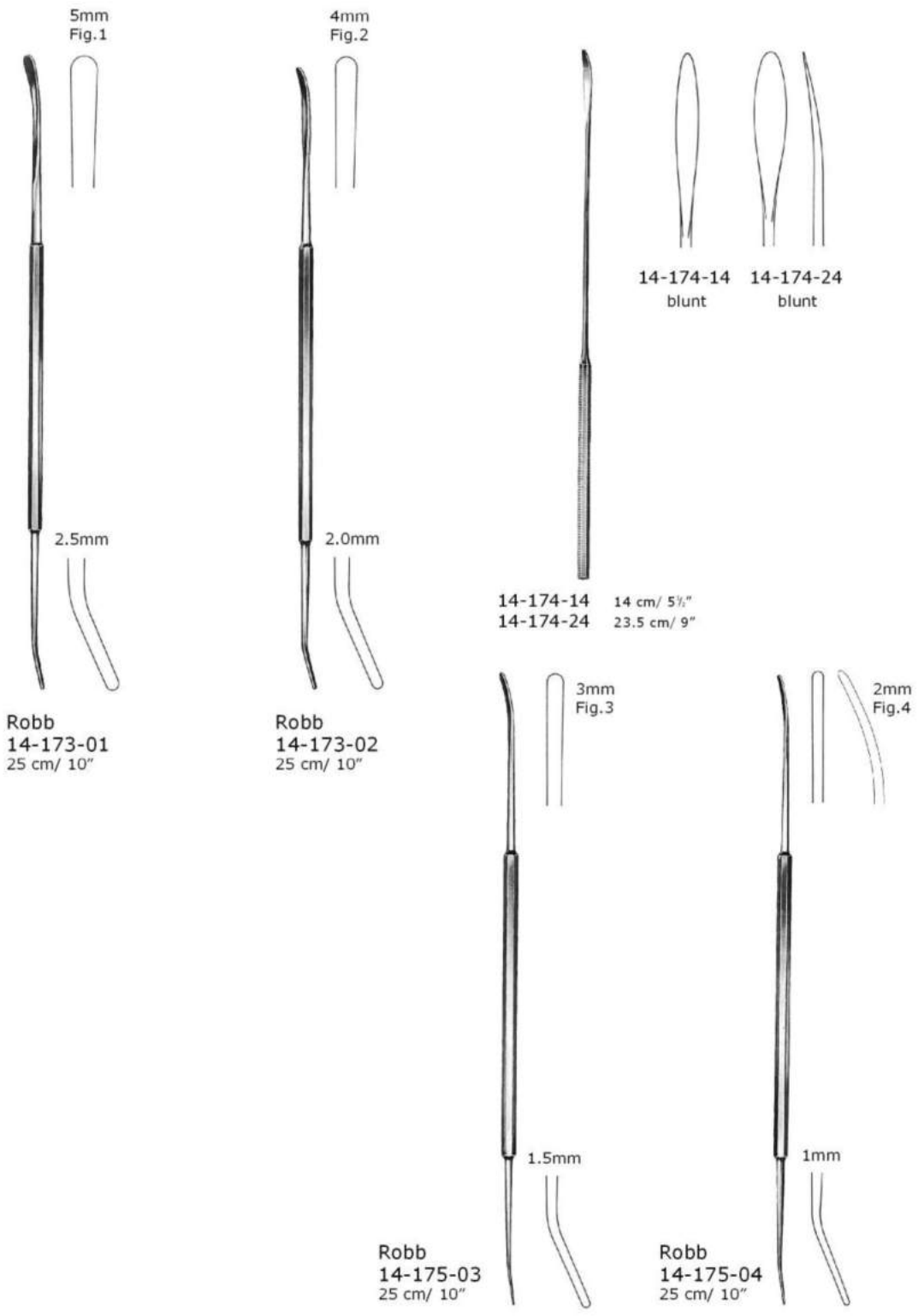

## NEUROSURGERY & LAMINECTOMY



Cranial Rongeurs, Wire Saws

Cervical Traction Tongs

Clips & Applying Forceps

Dura-Dissectors

Brain Spatulas

Nerve Root Retractors

Nerve Hooks

Knives, Dura Hooks

Micro Instruments

Laminar Spreaders

Intervertebral Disc Rongeurs

Laminectomy Rongeurs

Neurochirurgie und Laminektomie  
Schädelzangen, Drahtsägen  
Cranial Rongeurs, Wire Saws



De Vilbiss  
15-101-21  
21 cm/ 8½"



Dahlgren  
15-102-20  
20 cm/ 8"



Martel  
15-103-33  
33 cm/ 13"



Olivecrona  
15-104-30 - 15-104-70

- |           |            |
|-----------|------------|
| 15-104-30 | 30 cm/ 12" |
| 15-104-40 | 40 cm/ 16" |
| 15-104-50 | 50 cm/ 20" |
| 15-104-60 | 60 cm/ 24" |
| 15-104-70 | 70 cm/ 28" |



15-105-01  
Gigli Saw Handle

Neurosurgery and Laminectomy  
Schädelhalter  
Cervical Traction Tongs



Large Size  
15-106-01  
Pins adjustable



Crutchfield  
15-107-01  
small size



Crutchfield  
15-108-02  
Medium size



15-109-04  
3.5mm $\varnothing$   
Drill Pins



15-109-05  
5mm $\varnothing$   
Drill Pins



Neurochirurgie und Laminektomie  
Clips und Anlegezangen  
Clips and Applying Forceps



Raney  
15-110-00

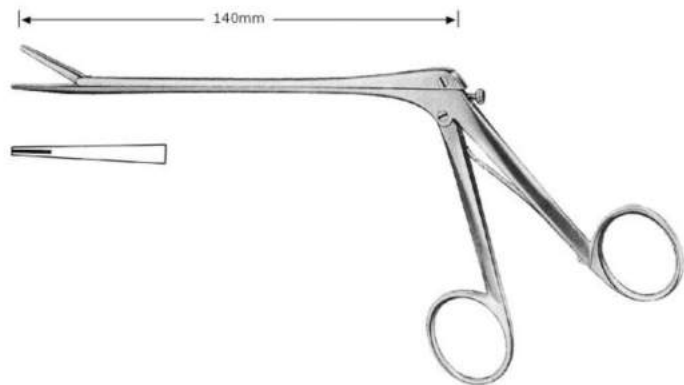

Olivecrona-Toennis  
(Scoville)  
15-111-14



McKenzie  
15-112-15 15 cm/ 6"  
15-112-19 19 cm/ 7½"



McKenzie  
15-113-15 15 cm/ 6"  
15-113-19 19 cm/ 7½"

Neurosurgery and Laminectomy  
Dura-Dissektoren  
Dura-Dissectors



Milligan  
15-114-21  
21 cm/ 8½"



Sachs  
15-115-21  
21 cm/ 8½"



Olivecrona  
15-116-18 18 cm/ 7"  
15-116-24 24 cm/ 9½"



Olivecrona  
15-117-18 18 cm/ 7"  
15-117-24 24 cm/ 9½"

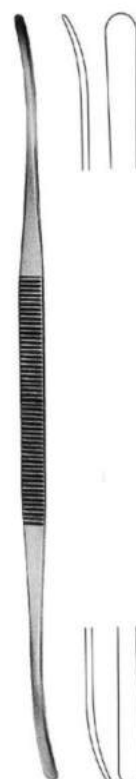

Toennis  
15-118-25  
25 cm/ 10"

Neurochirurgie und Laminektomie  
Dura- Dissektoren  
Dura-Dissectors

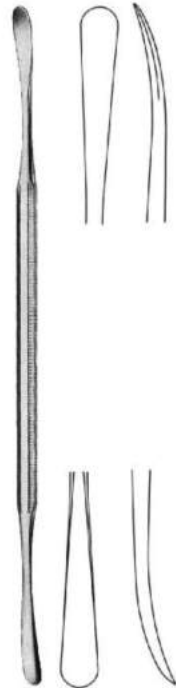

15-119-22  
22 cm/ 8 1/2"



Sachs  
15-120-21  
21 cm/ 8 1/4"



Penfield  
15-121-04  
21.5 cm/ 8 1/2"



Penfield  
15-121-03  
19.5 cm/ 7 1/2"



Penfield  
15-121-02  
19.5 cm/ 7 1/2"

Neurosurgery and Laminectomy  
Dura-Dissektoren  
Dura Dissectors



Penfield  
15-121-01  
18 cm/ 7"



Penfield  
15-122-05  
29 cm/ 11½"



Frazier  
15-123-01  
15 cm/ 6"



Hoen  
15-124-02  
15 cm/ 6"



Hoen  
15-125-03  
15 cm/ 6"



Neurochirurgie und Laminektomie  
Dura-Dissektoren  
Dura Dissectors



Davis  
15-126-24  
24.5 cm/ 9 7/8"



Horsley  
15-127-20  
20 cm/ 8"



Sachs  
15-128-21  
21 cm/ 8 1/2"

Neurosurgery and Laminectomy  
Hirnspatel  
Brain Spatulas

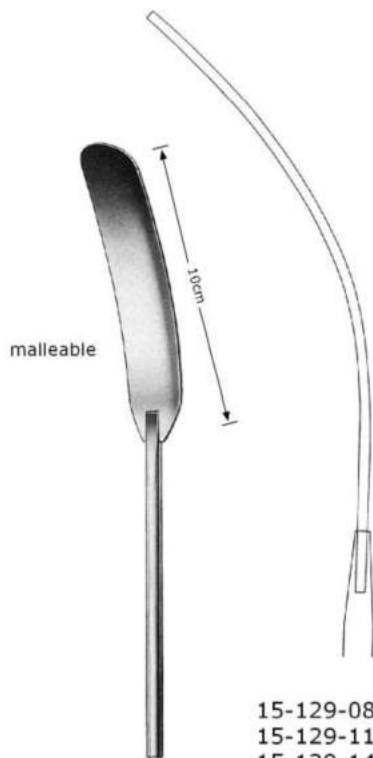

- 15-129-08 08mm
- 15-129-11 11mm
- 15-129-14 14mm
- 15-129-17 17mm

Heifetz  
20 cm/ 8"

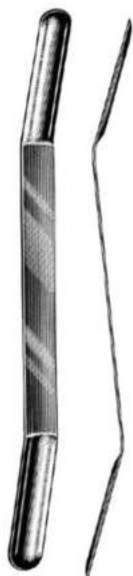

Olivecrona  
18 cm/ 7"  
Width of spatulas



Concave	upper end mm	lower end mm	Convex
15-130-07	7	9	15-130-09
15-131-11	11	13	15-131-13
15-132-15	15	18	15-132-18
15-133-18	18	22	15-133-18

Neurochirurgie und Laminektomie  
Nervwurzelhaken  
Nerve Root Retractors

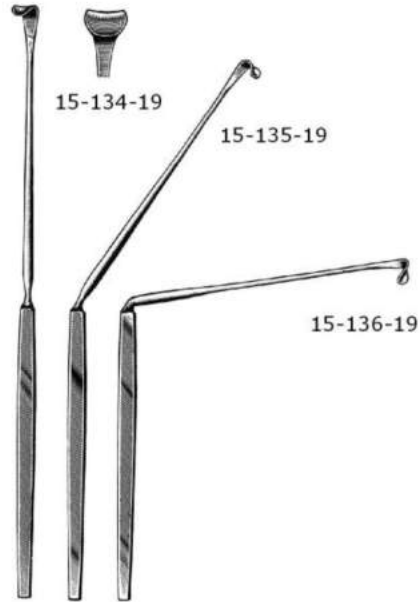

Love  
15-134-19 - 15-136-19

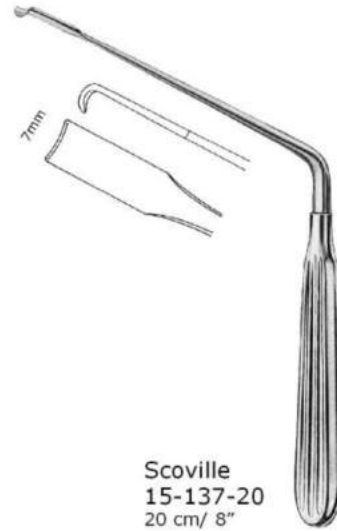

Scoville  
15-137-20  
20 cm/ 8"



Scoville  
15-139-23  
23 cm/ 9"



Holsher  
15-140-24  
24 cm/ 9 1/2"



Neurosurgery and Laminectomy  
Nervhaken  
Nerve Hooks



Groningen  
15-144-26  
26 cm/ 10 1/2"



Groningen  
15-145-26  
26 cm/ 10 1/2"



Graham  
15-141-16  
16 cm/ 6 1/4"



Sachs  
15-142-18  
18 cm/ 7"



Toennis  
15-143-15  
15 cm/ 6"



Cushing  
15-146-19 19 cm/ 7 3/4"  
15-146-28 28 cm/ 11"



Cushing  
15-147-19 19 cm/ 7 3/4"  
15-147-28 28 cm/ 11"





Neurochirurgie und Laminektomie  
Messer, Durahaken  
Knives, Dura Hooks

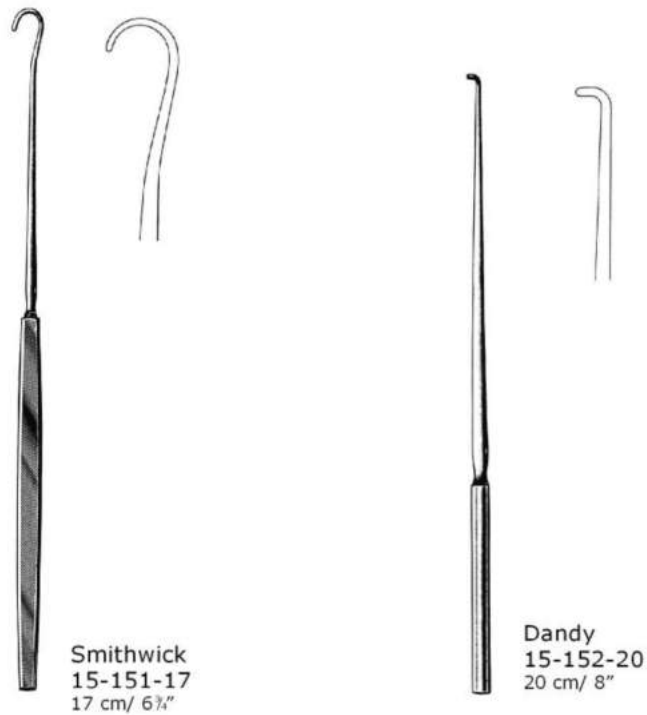
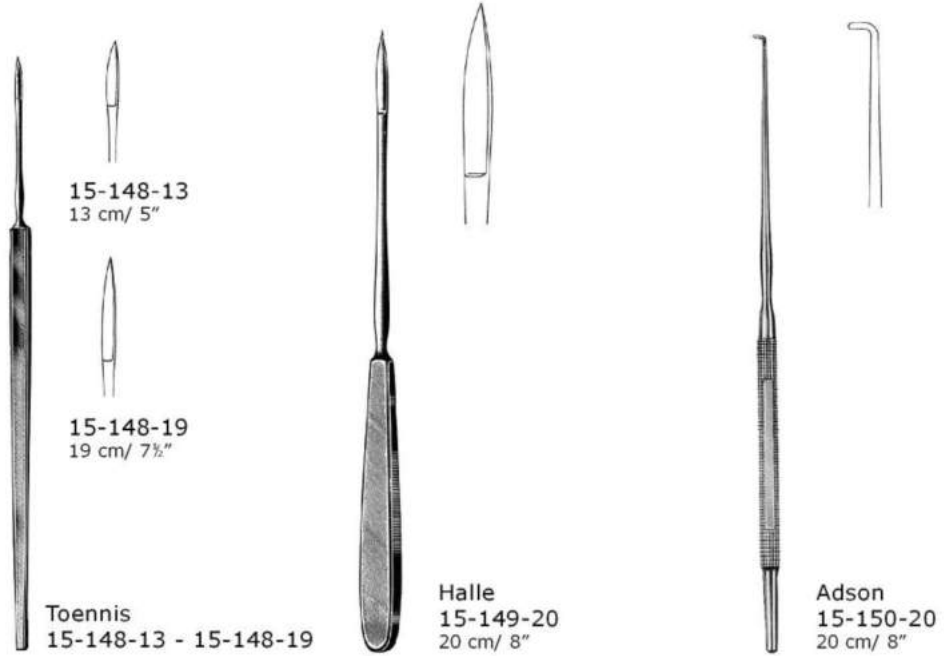

Neurosurgery and Laminectomy  
Durahaken  
Dura Hook



Adson  
15-153-20  
20 cm/ 8"



Cushing  
15-154-14  
14 cm/ 5½"



Frazier  
15-155-13 - 15-155-18

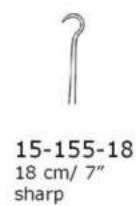



Neurochirurgie und Laminektomie  
Mikro-Instrumente  
Micro Instruments



Suture Pusher  
Yasargil  
15-156-01  
19 cm/ 7½"

15-156-02  
19 cm/ 7½"

15-156-03  
19 cm/ 7½"

15-156-04  
19 cm/ 7½"

15-157-19  
19 cm/ 7½"



Jacobson  
15-158-19  
19 cm/ 7½"



Koos  
15-159-19  
19 cm/ 7½"

Koos  
15-160-19  
19 cm/ 7½"

Koos  
15-161-19  
19 cm/ 7½"

Kraus  
15-162-19  
19 cm/ 7½"

Koos  
15-163-19  
19 cm/ 7½"



Neurosurgery and Laminectomy  
Mikro-Instrumente  
Micro Instruments



15-164-19 Fisch  
19 cm/ 7½"  
Dura Hook

15-165-19  
19 cm/ 7½"  
Delicate Hook

15-166-01 15-166-02 15-166-03 15-166-04  
19 cm/ 7½" 19 cm/ 7½" 19 cm/ 7½" 19 cm/ 7½"

Krayenbuhl  
Nerve and Vessel Hooks

15-168-01

15-168-02

15-168-03

15-168-04

Ligature Guides and  
Carriers, probe pointed



Yasargil 15-167-01 15-167-02 15-167-03 15-167-04 15-167-05 15-167-06  
19 cm/ 7½" 19 cm/ 7½" 19 cm/ 7½" 19 cm/ 7½" 19 cm/ 7½" 19 cm/ 7½"

Yasargil 15-168-01 - 15-168-04  
19 cm/ 7½"



Neurochirurgie und Laminektomie  
Wirbelkörperspreizer  
Lamina Spreaders

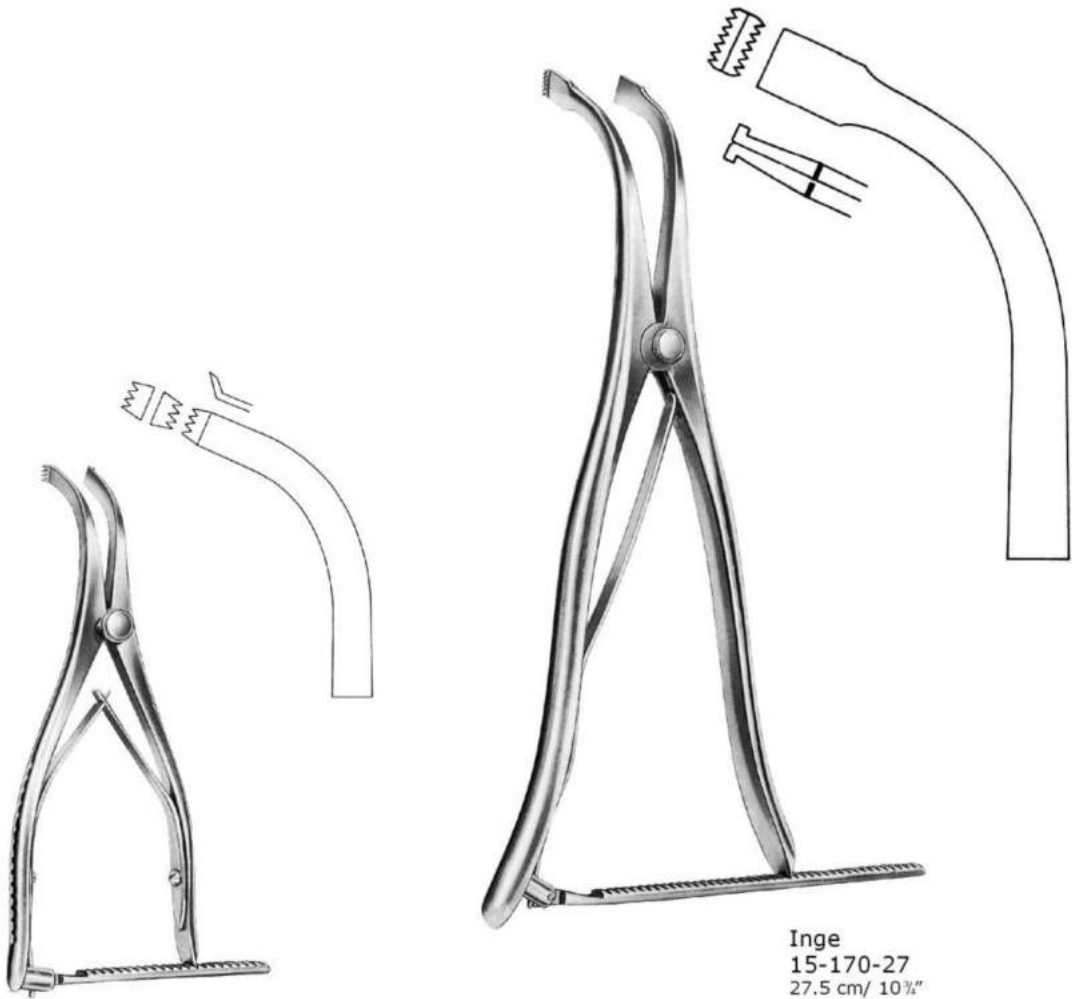

Inge  
15-169-17  
17 cm / 6 $\frac{3}{4}$ "

Inge  
15-170-27  
27.5 cm / 10 $\frac{3}{4}$ "



Cloward  
15-171-15  
15 cm / 6"

Neurosurgery and Laminectomy  
 Bandscheibenstanzen  
 Intervertebral Disc Rongeurs



Length of shaft	150mm 6"	190mm 7½"	150mm 6"	190mm 7½"
Width of bite	3mm	3mm	5mm	5mm
Cat. Ref.	15-171-03	15-172-03	15-171-05	15-172-05

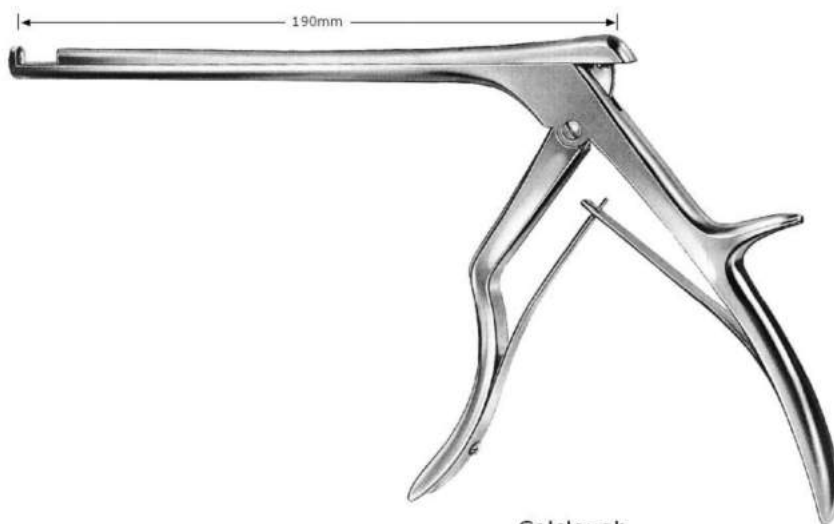

Colclough  
 15-171-03 - 15-172-05

Neurochirurgie und Laminektomie  
Bandscheibenstanzen  
Intervertebral Disc Rongeurs

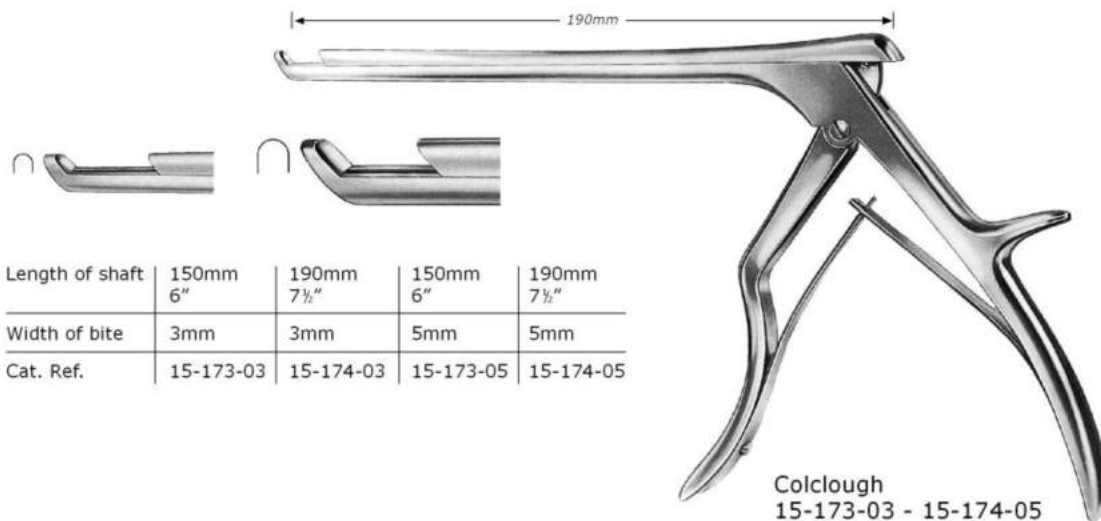

Length of shaft	150mm 6"	190mm 7½"	150mm 6"	190mm 7½"
Width of bite	3mm	3mm	5mm	5mm
Cat. Ref.	15-173-03	15-174-03	15-173-05	15-174-05

Colclough  
15-173-03 - 15-174-05

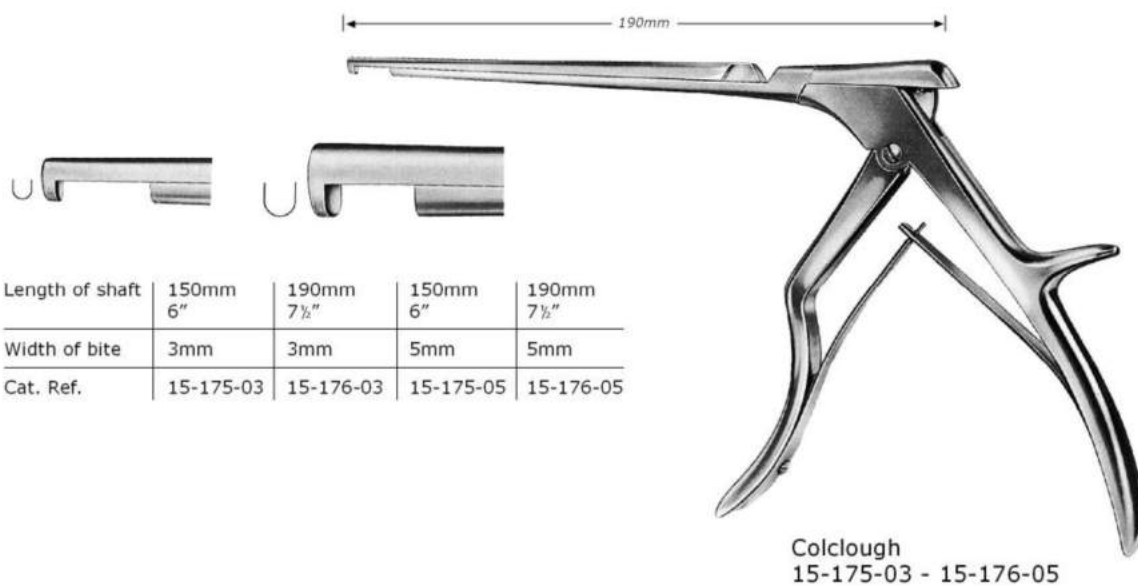

Length of shaft	150mm 6"	190mm 7½"	150mm 6"	190mm 7½"
Width of bite	3mm	3mm	5mm	5mm
Cat. Ref.	15-175-03	15-176-03	15-175-05	15-176-05

Colclough  
15-175-03 - 15-176-05

Neurosurgery and Laminectomy  
 Bandscheibenstanzen  
 Intervertebral Disc Rongeurs

cutting upward



- 15-177-01 1mm
- 15-177-02 2mm
- 15-177-03 3mm
- 15-177-04 4mm
- 15-177-05 5mm

cutting downward

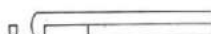

- 15-178-01 1mm
- 15-178-02 2mm
- 15-178-03 3mm
- 15-178-04 4mm
- 15-178-05 5mm

cutting 40° forward

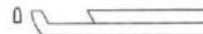

- 15-179-01 1mm
- 15-179-02 2mm
- 15-179-03 3mm
- 15-179-04 4mm
- 15-179-05 5mm

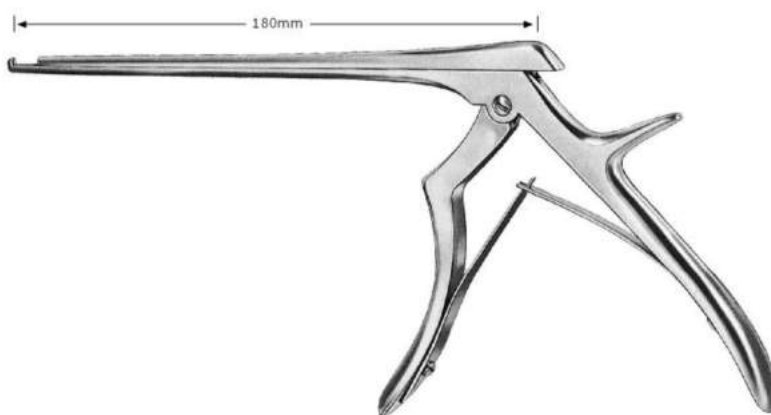

Ferris-Smith-Kerrison  
 15-177-01 - 15-179-05



Neurochirurgie und Laminektomie  
Laminektomie-Zangen  
Laminectomy Rongeurs

Cushing  
2mm

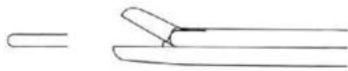

2x10mm	
15-180-01	13 cm
15-180-02	15 cm
15-180-03	18 cm

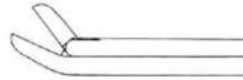

2x10mm/ 45°	
15-181-01	13 cm
15-181-02	15 cm
15-181-03	18 cm

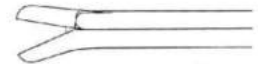

2x10mm/ 45°	
15-182-01	13 cm
15-182-02	15 cm
15-182-03	18 cm

Love-Gruenwald  
3mm



3x10mm	
15-180-04	13 cm
15-180-05	15 cm
15-180-06	18 cm

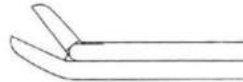

3x10mm/ 45°	
15-181-04	13 cm
15-181-05	15 cm
15-181-06	18 cm



3x10mm/ 45°	
15-182-04	13 cm
15-182-05	15 cm
15-182-06	18 cm

Spurling  
4mm



4x10mm	
15-180-07	13 cm
15-180-08	15 cm
15-180-09	18 cm

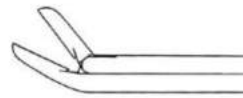

4x10mm/ 45°	
15-181-07	13 cm
15-181-08	15 cm
15-181-09	18 cm



4x10mm/ 45°	
15-182-07	13 cm
15-182-08	15 cm
15-182-09	18 cm

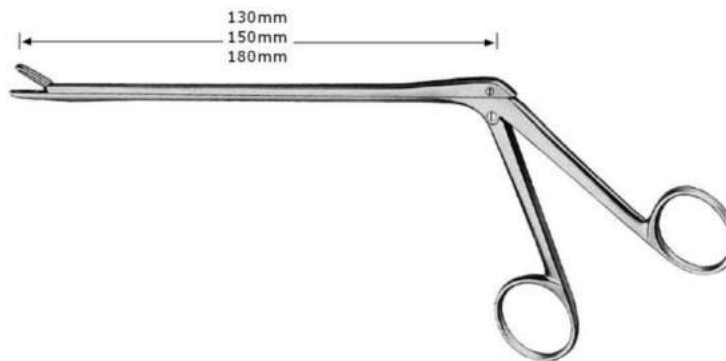

15-180-01 - 15-182-09

Neurosurgery and Laminectomy  
 Laminektomie-Zangen  
 Laminectomy Rongeurs

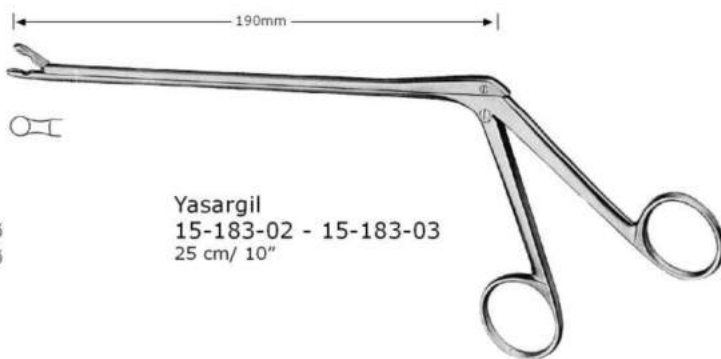

Cup Size  
 15-183-02 2.2 mm  $\varnothing$   
 15-183-03 3.5 mm  $\varnothing$

Yasargil  
 15-183-02 - 15-183-03  
 25 cm/ 10"

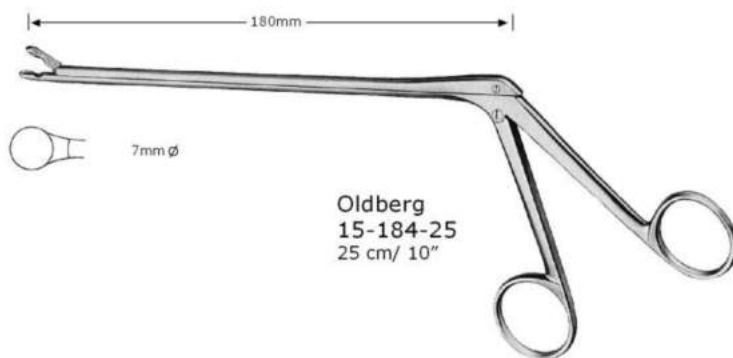

Oldberg  
 15-184-25  
 25 cm/ 10"

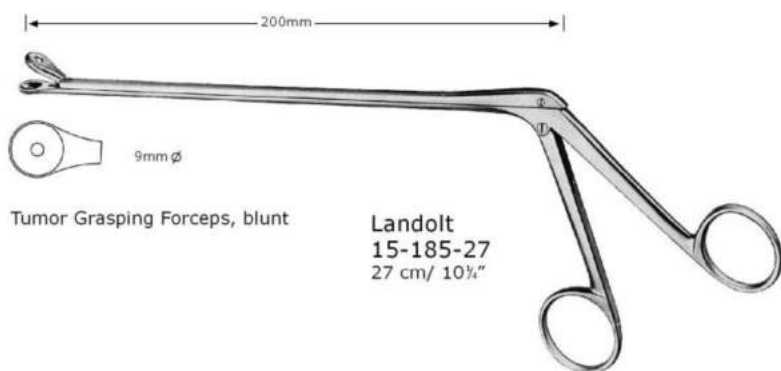

Tumor Grasping Forceps, blunt

Landolt  
 15-185-27  
 27 cm/ 10 1/2"

## TRACHEOTOMY



**Trachea Retractors, Trocas**

**Trachea Retractors**

**Trachea Tubes, Dilators**

**Directors-Enucleators**

Tracheotomy - Tracheotomie  
Tracheal Häkchen, Trokare  
Trachea Retractors, Trocars



Lukens  
16-101-17  
17 cm/ 6 3/4"



Jackson  
16-102-17  
17 cm/ 6 3/4"

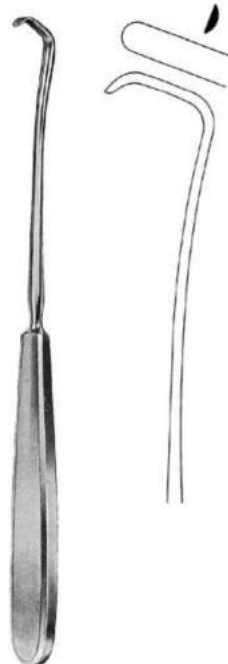

Schoenborn  
16-103-21  
20 cm/ 8"

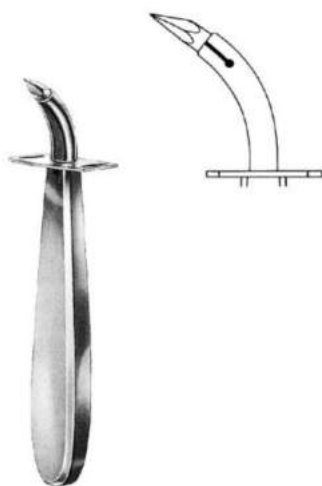

Uckermann  
16-104-13 - 16-105-13  
13 cm/ 5"



16-104-13  
7.5mm $\phi$



16-105-13  
9mm $\phi$



Tracheotomy - Tracheotomie  
 Tracheal Häkchen  
 Trachea Retractors

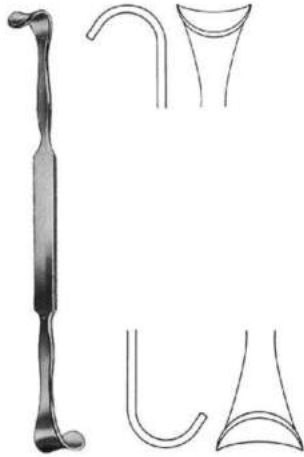

Rose  
 16-106-13  
 13.5 cm / 5"

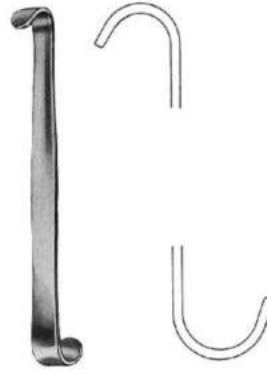

Luer  
 16-107-11  
 11 cm / 4 1/2"

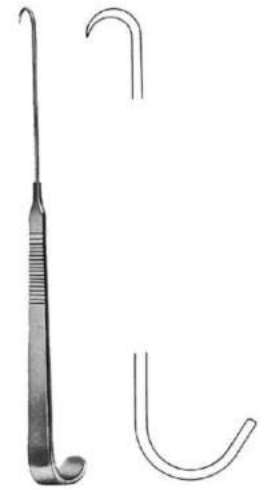

16-108-15  
 15 cm / 6"



Iterson  
 16-109-17 - 16-110-17  
 17 cm / 6 1/2"



Bose  
 16-111-16  
 16.5 cm / 6 1/2"



Bose  
 16-112-16  
 16.5 cm / 6 1/2"

Tracheotomy - Tracheotomie  
Tracheal-Kanülen, Dilatatoren  
Trachea Tubes, Dilators



**Luer**  
16-113-05 - 16-113-14  
German Silver, Silver Plated

Fig. mm  $\phi$  45-90mm

1	5	16-113-05
2	6	16-113-06
3	7	16-113-07
4	8	16-113-08
5	9	16-113-09
6	10	16-113-10
7	11	16-113-11
8	12	16-113-12
9	13	16-113-13
10	14	16-113-14



**Chevalier-Jackson**  
16-114-05 - 16-114-14  
German Silver, Silver Plated

Fig. mm  $\phi$  45-90mm

1	5	16-114-05
2	6	16-114-06
3	7	16-114-07
4	8	16-114-08
5	9	16-114-09
6	10	16-114-10
7	11	16-114-11
8	12	16-114-12
9	13	16-114-13
10	14	16-114-14



**Laborde**  
16-115-14  
14 cm/ 5½"



**Trousseau**  
16-116-14  
14 cm/ 5½"



Tracheotomy - Tracheotomie  
Sonden  
Directors-Enucleators

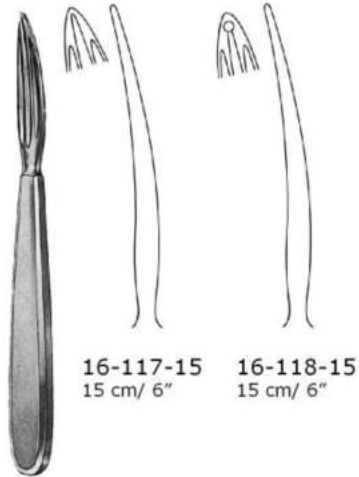

16-117-15 15 cm/ 6"  
16-118-15 15 cm/ 6"

Kocher  
16-117-15 - 16-118-15

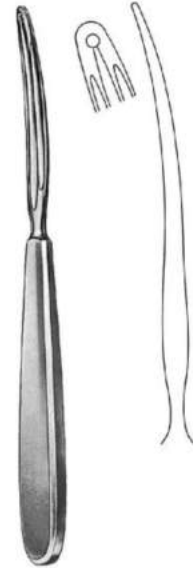

Kocher  
16-119-18  
18 cm/ 7"

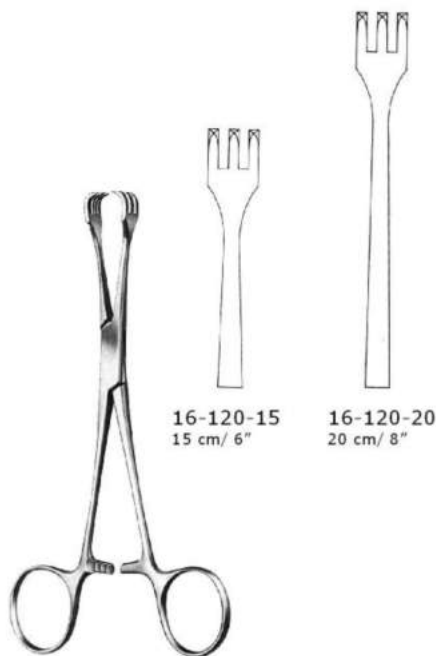

16-120-15 15 cm/ 6"  
16-120-20 20 cm/ 8"

Lahey  
16-120-15 - 16-120-20



Mastin  
16-121-17  
17 cm/ 6 1/2"



## INTESTINE



Tissue & Organ Holding Forceps

Intestinal Clamps Forceps

Intestinal & Stomach Clamps (Crushing Clamps)

Atrauma Intestinal Clamps Forceps

Atrauma Sigmoid Anastomosis Forceps

Rectal Specula

Rectal Speculun

Rectal Biopsy Specimen Forceps



Stomach, Rectum, Darm, Magen, Mastdarm  
 Gewebe- und organ-Faßzangen  
 Tissue and Organ Holding Forceps



Judd-Allis  
 17-101-15 15 cm/ 6"  
 17-101-19 19 cm/ 7½"  
 3:4 teeth



Boys-Allis  
 17-102-15  
 15 cm/ 6"  
 5:6 teeth



Allis-Adair  
 17-103-15  
 15 cm/ 6"  
 10:11 teeth



Allis-Baby  
 17-104-12  
 12 cm/ 4½"  
 4:5 teeth

4:5



17-105-45  
 15 cm/ 6"

5:6

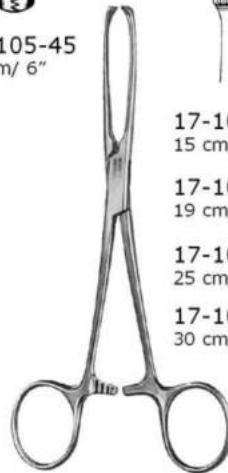

Allis  
 17-105-15 - 17-105-45

17-105-15  
 15 cm/ 6"

17-105-19  
 19 cm/ 7½"

17-105-25  
 25 cm/ 10"

17-105-30  
 30 cm/ 12"

Intestines, Stomach, Rectum, Darm, Magen  
 Gewebe- und organ-Faßzangen  
 Tissue and Organ Holding Forceps



**Williams**  
 17-106-16  
 16 cm/ 6 1/4"  
 plain/ serrated



**Lockwood**  
 17-107-20  
 20 cm/ 8"



**Allis**  
 17-108-20  
 20 cm/ 8"



**Allis-Thomas**  
 17-109-20  
 20 cm/ 8"  
 6:7 teeth

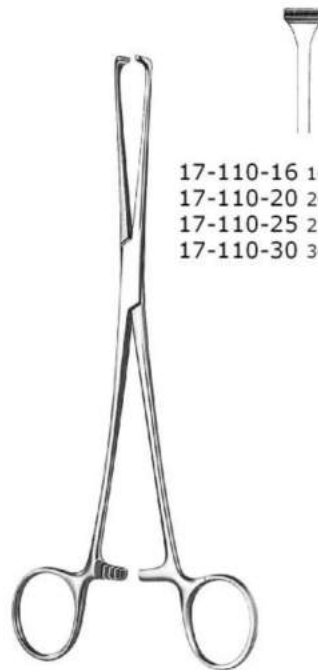

**Allis-Atrauma**  
 17-110-16 - 17-110-30

- 17-110-16 16 cm/ 6 1/4"
- 17-110-20 20 cm/ 8"
- 17-110-25 25 cm/ 10"
- 17-110-30 30 cm/ 12"



Stomach, Rectum, Darm, Magen, Mastdarm  
 Gewebe- und organ-Faßzangen  
 Tissue and Organ Holding Forceps

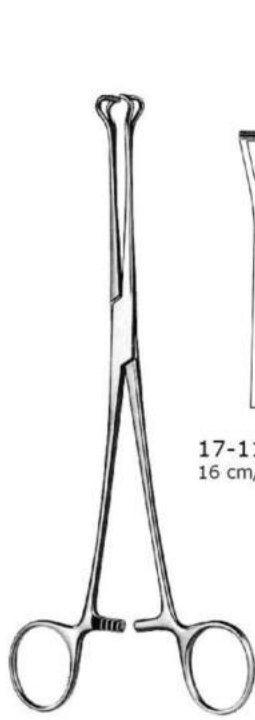

17-111-16 17-111-20  
 16 cm/ 6½" 20 cm/ 8"

Babcock-Atrauma  
 17-111-16 - 17-111-20



17-112-20 17-113-23  
 20 cm/ 8" 23 cm/ 9"

Duval  
 17-112-20 - 17-113-23



17-114-16 17-114-18 17-114-20 17-114-24  
 16 cm/ 6½" 18 cm/ 7" 20 cm/ 8" 24 cm/ 9½"

Babcock  
 17-114-16 - 17-114-24



Intestines, Stomach, Rectum, Darm,  
Darmklemmen  
Intestinal Clamp Forceps

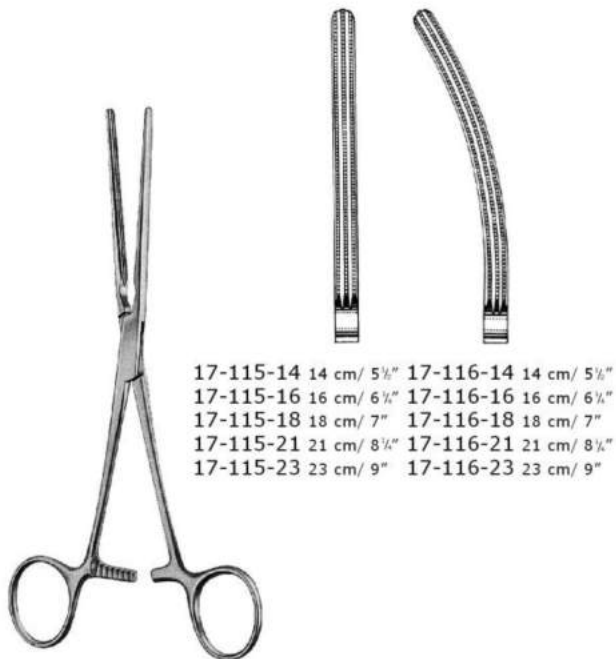

- |           |            |           |            |
|-----------|------------|-----------|------------|
| 17-115-14 | 14 cm/ 5½" | 17-116-14 | 14 cm/ 5½" |
| 17-115-16 | 16 cm/ 6½" | 17-116-16 | 16 cm/ 6½" |
| 17-115-18 | 18 cm/ 7"  | 17-116-18 | 18 cm/ 7"  |
| 17-115-21 | 21 cm/ 8½" | 17-116-21 | 21 cm/ 8½" |
| 17-115-23 | 23 cm/ 9"  | 17-116-23 | 23 cm/ 9"  |

Doyen-Atrauma  
17-115-14 - 17-116-23

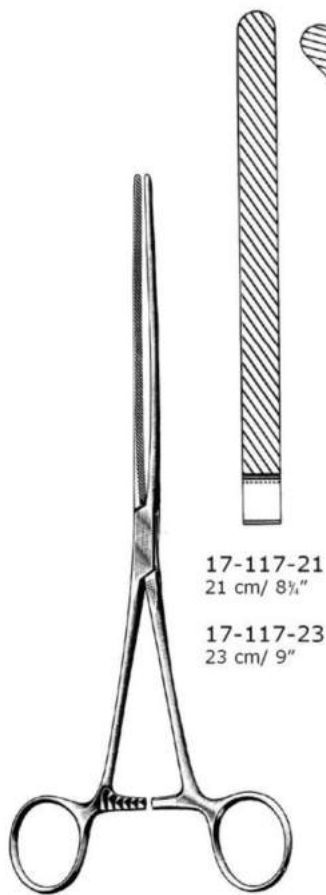

17-117-21  
21 cm/ 8½"

17-117-23  
23 cm/ 9"

Doyen  
17-117-21 - 17-118-23

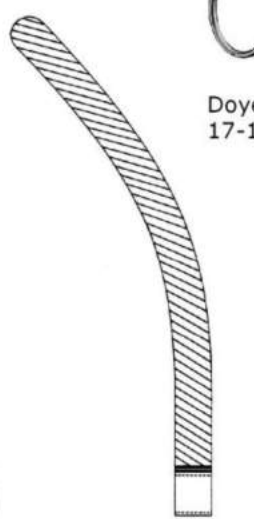

17-118-21  
21 cm/ 8½"

17-118-23  
23 cm/ 9"

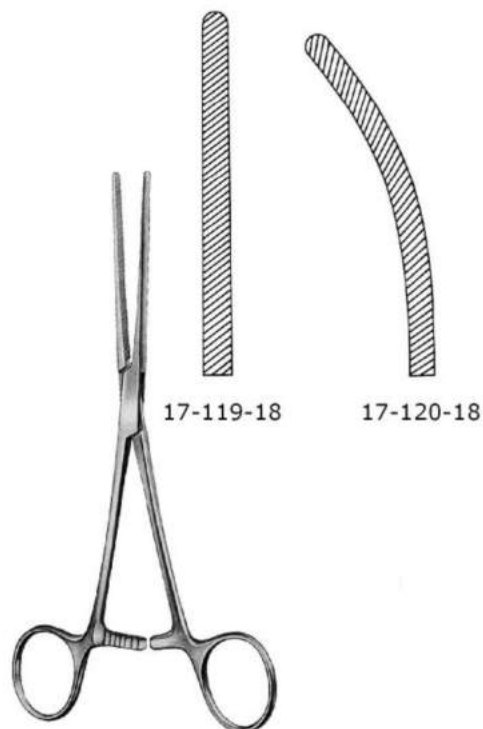

17-119-18

17-120-18

Baby-Doyen  
17-119-18 - 17-120-18  
18 cm/ 7"



Stomach, Rectum, Darm, Magen, Mastdarm  
Darmklemmen  
Intestinal Clamp Forceps



17-121-21  
21 cm/ 8 1/4"

17-121-23  
21 cm/ 9"



17-122-21  
21 cm/ 8 1/4"

17-122-23  
23 cm/ 9"

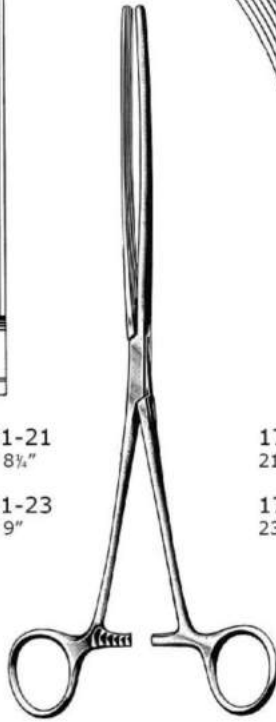

Mayo-Robson  
17-121-21 - 17-122-23



Mayo Robson-Atrauma  
17-123-25 25 cm/ 10" Str  
17-123-10 25 cm/ 10" Cvd



Mayo Robson  
17-124-25 25 cm/ 10" Str  
17-125-25 25 cm/ 10" Cvd

Intestines, Stomach, Rectum, Darm,  
Darmklemmen  
Intestinal Clamp Forceps

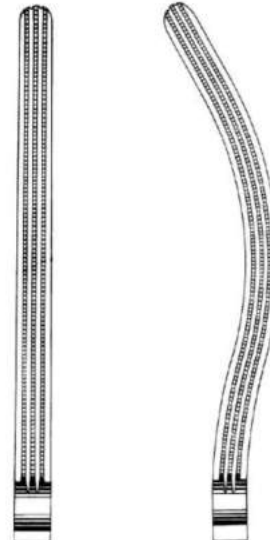

17-126-22 22 cm/ 8 7/8"    17-127-22 22 cm/ 8 7/8"  
 17-126-25 25 cm/ 10"    17-127-25 25 cm/ 10"  
 17-126-28 28 cm/ 11"    17-127-28 28 cm/ 11"

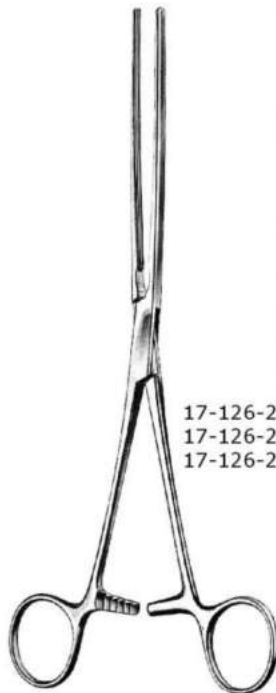

Kocher-Atrauma  
17-126-22 - 17-127-28



17-128-22 22 cm/ 8 7/8"    17-129-22 22 cm/ 8 7/8"  
 17-128-25 25 cm/ 10"    17-129-25 25 cm/ 10"  
 17-128-28 28 cm/ 11"    17-129-28 28 cm/ 11"

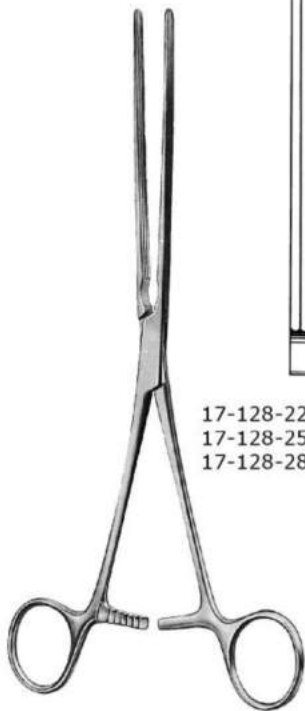

Kocher  
17-128-22 - 17-129-28  
Very elastic

Stomach, Rectum, Darm, Magen, Mastdarm  
 Darm-und Magenquetschklemmen  
 Intestinal and Stomach Clamps (Crushing Clamps)



17-133-31  
 31.5 cm/ 12½"  
 with pin

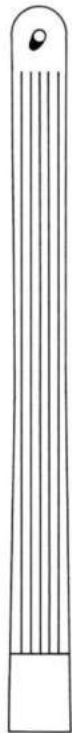

17-132-27  
 27.5 cm/ 10¾"  
 with pin



17-131-20  
 20 cm/ 8"  
 with pin



17-130-15  
 with pin



Payr-Baby  
 17-130-15  
 15 cm/ 6"



Payr  
 17-131-20 - 17-133-31

Intestines, Stomach, Rectum, Darm,  
Atrauma Darmklemmer  
Atrauma Intestinal Clamp Forceps

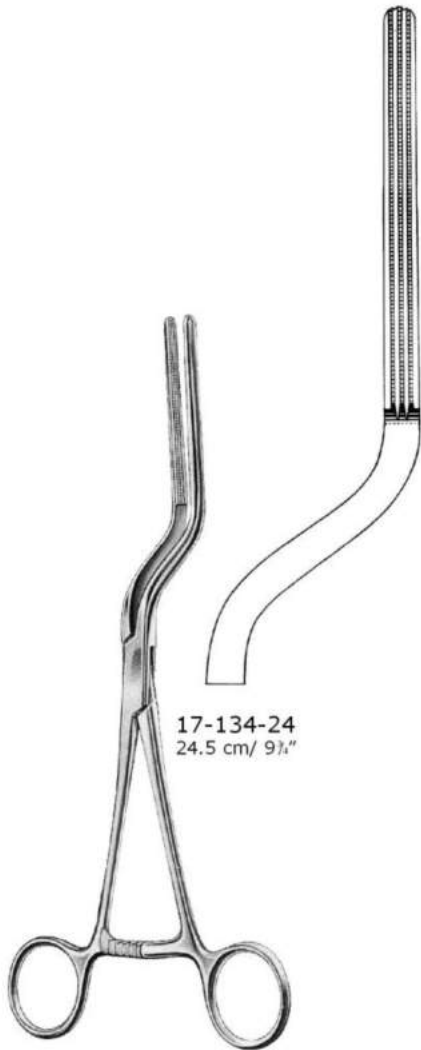

17-134-24  
24.5 cm/ 9 1/2"

Brunner  
17-134-24

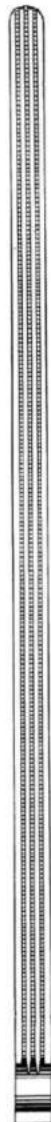

17-135-33

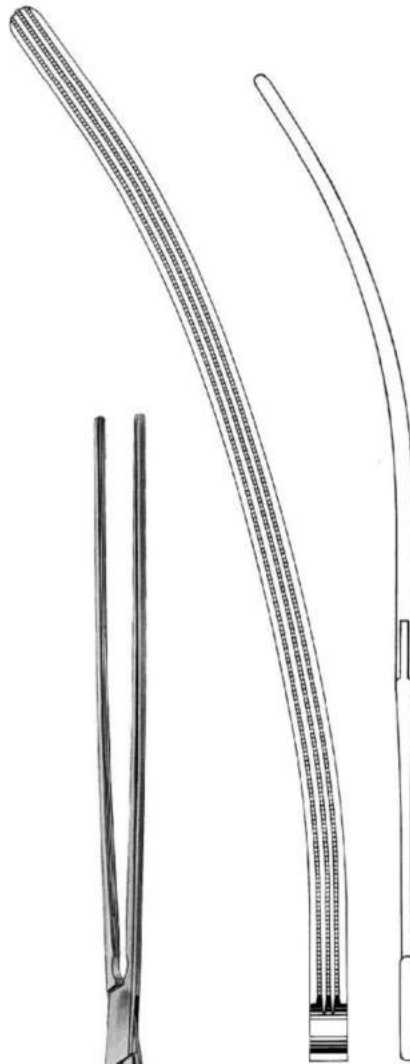

17-136-33



Scudder-Atrauma  
17-135-33 - 17-136-33  
33 cm/ 13"



Stomach, Rectum, Darm, Magen, Mastdarm  
Atrauma Rektum-Anastomosenklemmen  
Atrauma Sigmoid Anastomosis Forceps



Fehland  
17-137-24  
24 cm/ 9½"

Resano  
17-138-30  
30 cm/ 12"



Veidenheimer  
17-139-23  
23 cm/ 9"

Intestines, Stomach, Rectum, Darm,  
Mastdarm-Spekula  
Rectal Specula



Sims  
17-140-16  
16 cm/ 6 1/4"



Sims  
17-141-16  
16 cm/ 6 1/4"



Mathieu  
17-142-20  
20 cm/ 8"



Ives-Fansler  
17-143-15  
15 cm/ 6"  
22mm $\varnothing$

Stomach, Rectum, Darm, Magen, Mastdarm  
Analspreizer  
Rectal Speculum



Alan Parks  
17-144-00  
Complete With  
2 pair of blades  
1 center blade



Czerny  
17-145-23  
23 cm/ 9"

Intestines, stomach, Rectum, Darm,  
Mastdarm-Biopsiezangen  
Rectal Biopsy Specimen Forceps

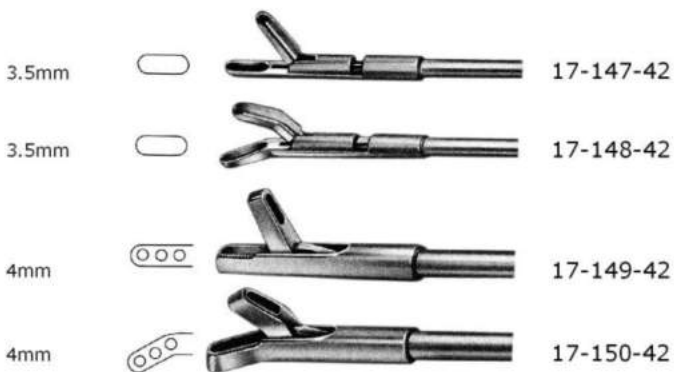
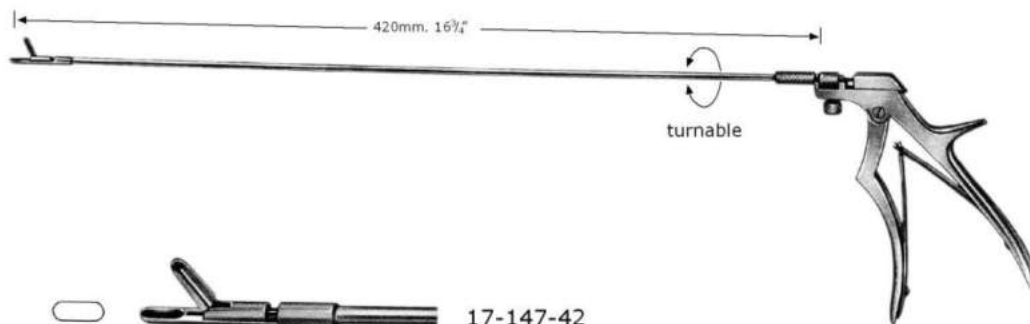
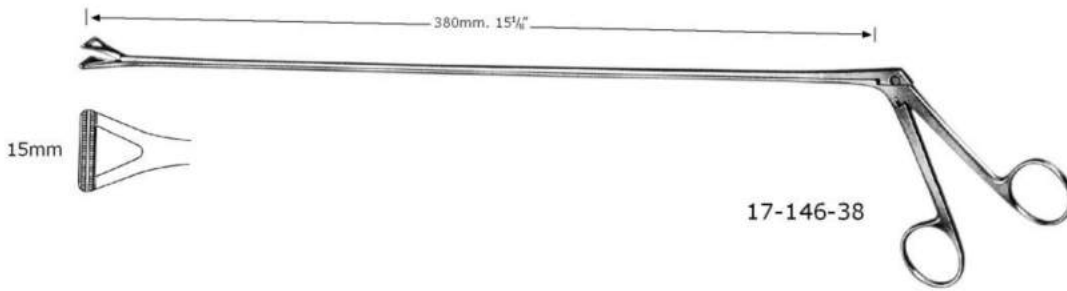





## UROLOGY

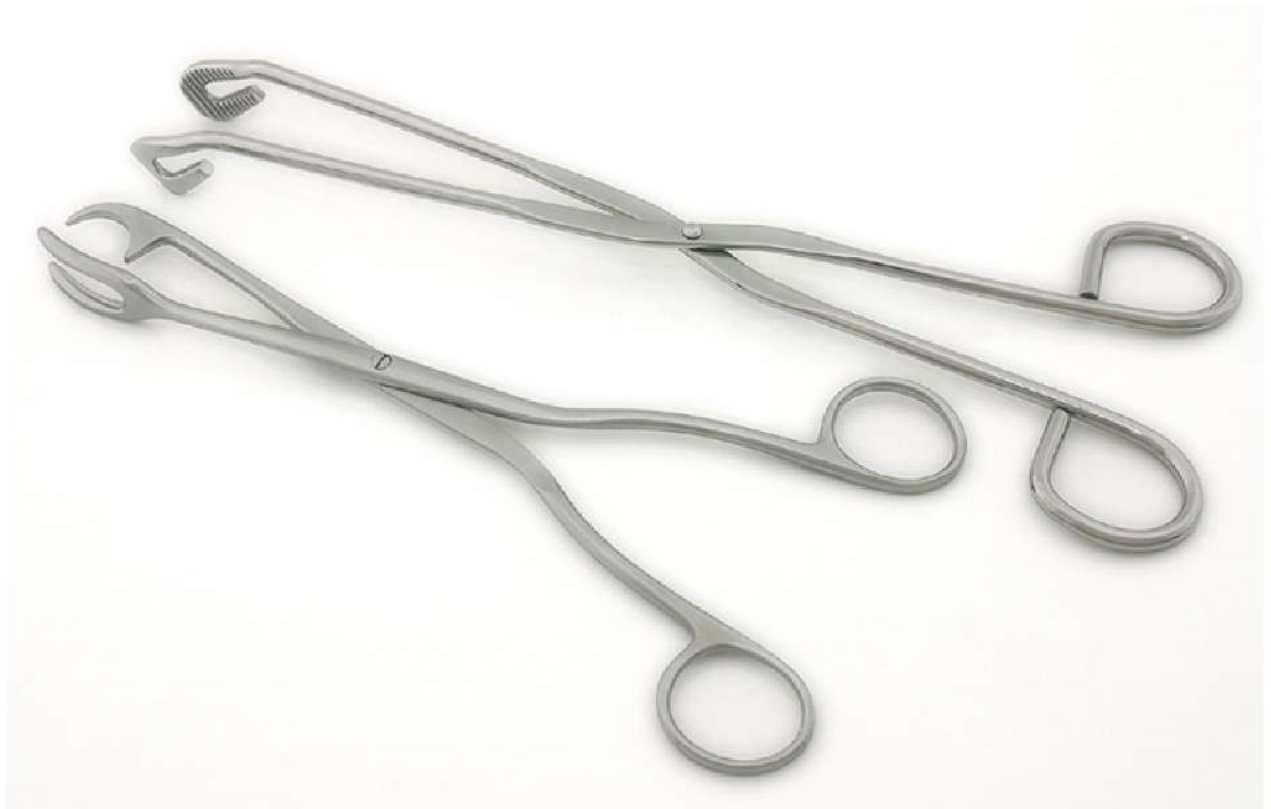

**Kindeg Stone Forceps**

**Dilating Bougies, Metal Catheters**

**Gall Stone Forceps**

**Gall Stone Probes, Gall Duck Dilators**

**Gall Stone Scoops**

**Prostatic Rectators**

**Prostatectomy Instruments**

**Bladder Rectators**



Liver, Gall Bladder, Kidney, Leber, Galle,  
Nierensteinzangen  
Kidney Stone Forceps

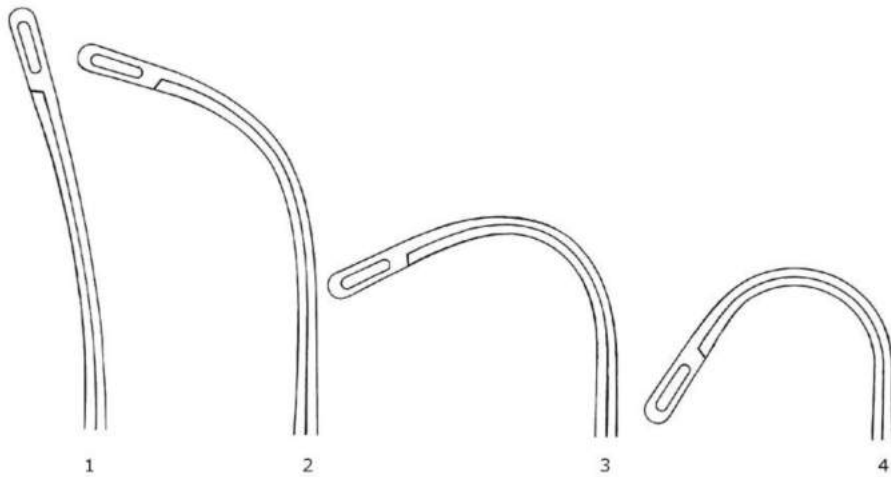

1  
18-101-23  
23 cm/ 9"

2  
18-102-22  
22 cm/ 8½"

3  
18-103-22  
22 cm/ 8½"

4  
18-104-22  
22 cm/ 8½"



Randall  
18-101-23 - 18-106-19

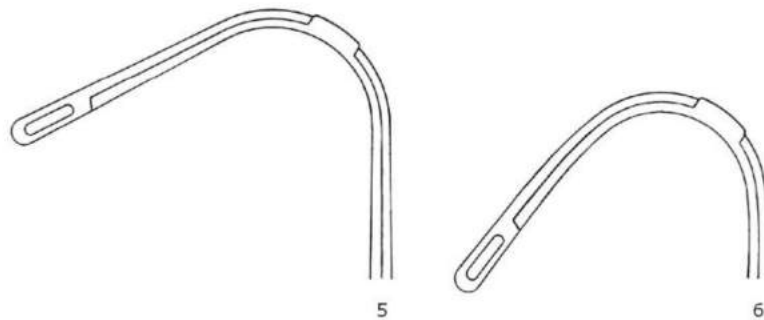

5  
18-105-19  
19 cm/ 7½"

6  
18-106-19  
19 cm/ 7½"



Gall Bladder, Kidney, Leber, Galle, Niere  
Gallensteinzangen  
Gall Stone Forceps

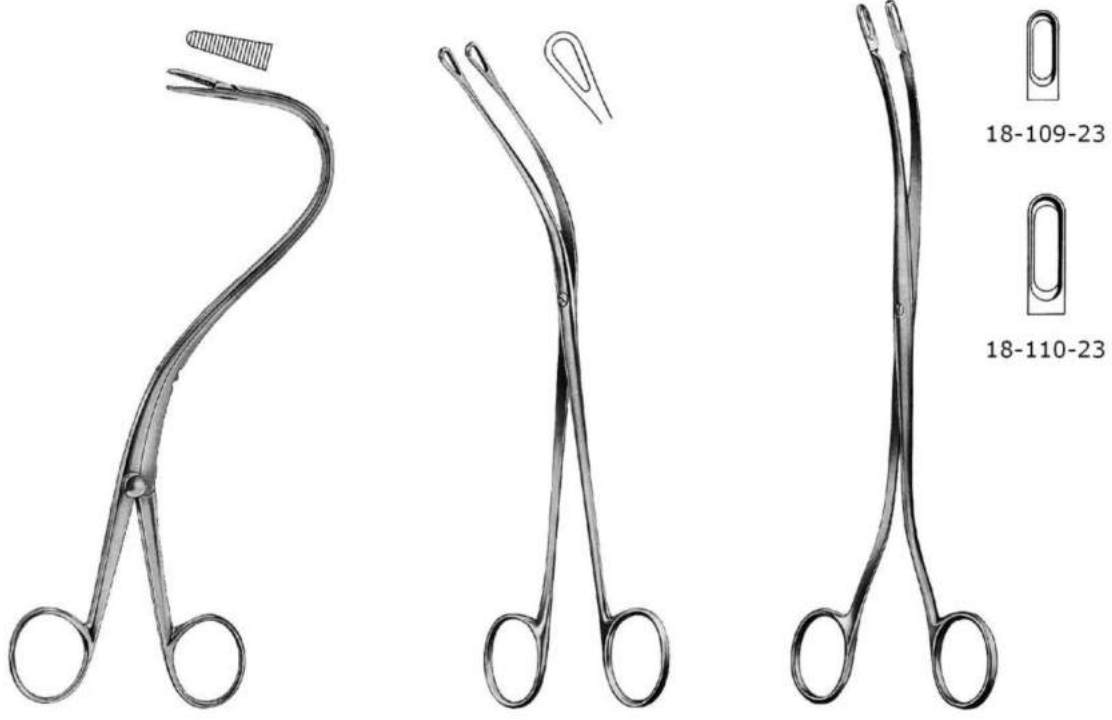

**Elsasser**  
18-107-20  
20 cm/ 8"

**Mixer**  
18-108-22  
22 cm/ 8 1/2"

**Desjardins**  
18-109-23 - 18-110-23  
23 cm/ 9"

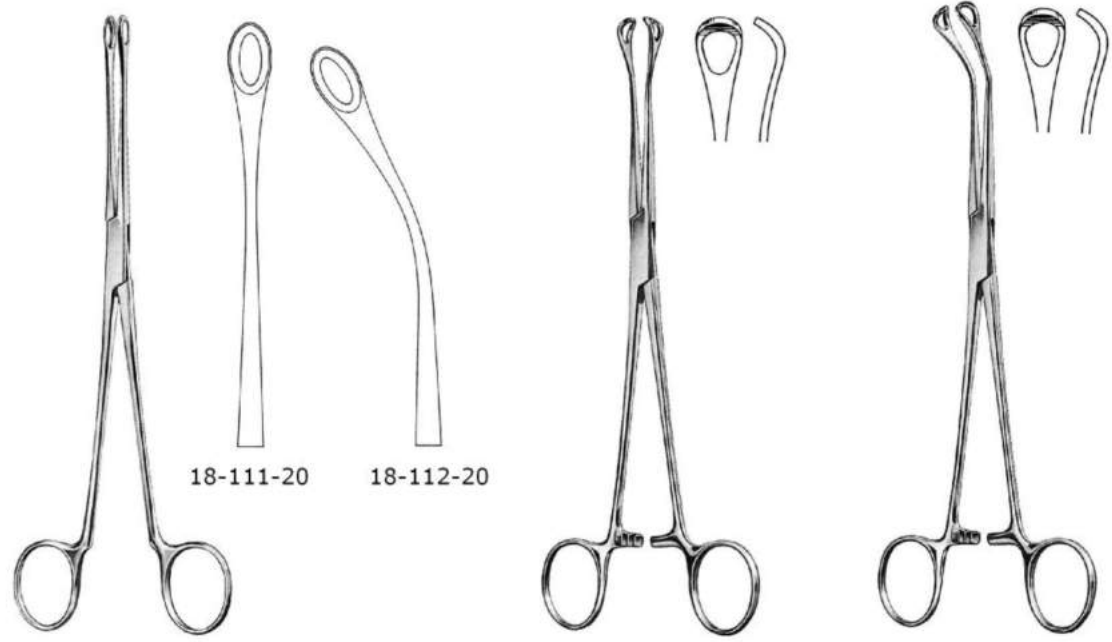

**Blake**  
18-111-20 - 18-112-20  
20 cm/ 8"

**Mayo-Blake**  
18-113-20  
20 cm/ 8"

**Mayo-Blake**  
18-114-20  
20 cm/ 8"



Liver, Gall Bladder, Kidney, Leber, Galle,  
Gallensteinsonden, Gallenkanal-Dilatoren  
Gall stone Probes, Gall Duct Dilators

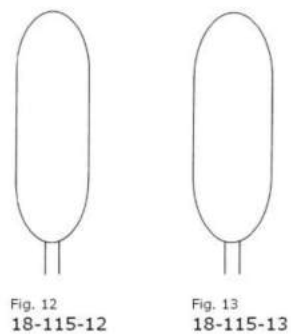
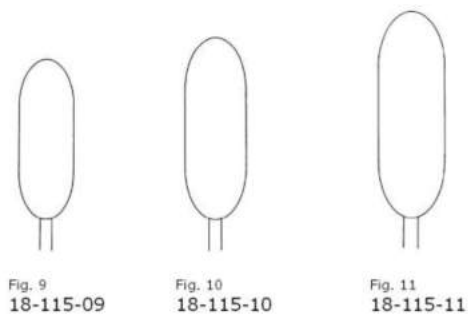
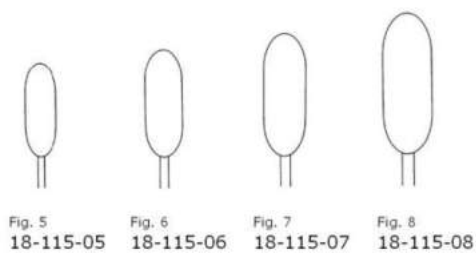
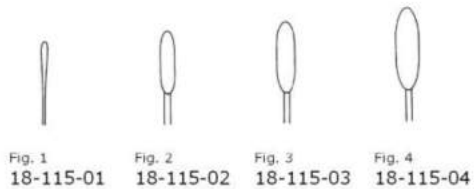

**Bakes**  
18-115-01 - 18-115-13  
32 cm/ 13"  
malleable shaft

**Desjardins**  
18-116-28 - 18-118-28  
28 cm/ 11"  
elastic



Gall Bladder, Kidney, Leber, Galle, Niere  
 Gallensteinlöffel  
 Gall Stone Scoops

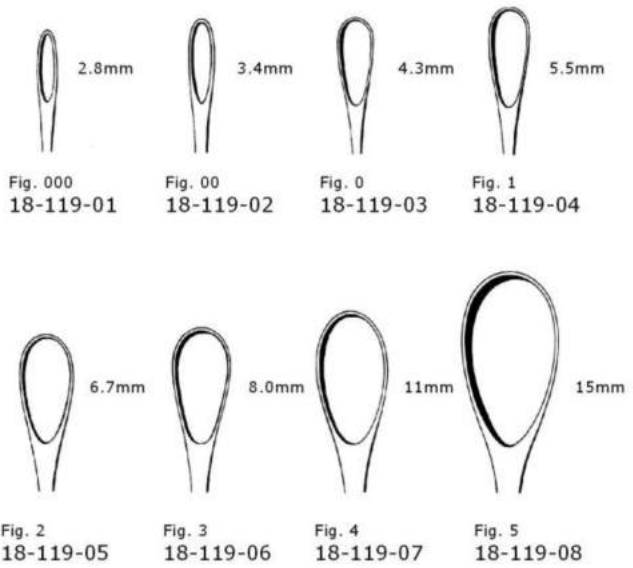

Luer-Koerte  
 18-119-01 - 18-119-08  
 31 cm/ 12"  
 Malleable shaft

310

Urology, Urologie  
Prostatahaken  
Prostatic Retractors



Young  
18-120-22  
22 cm/ 8½"



Young  
18-121-21  
21 cm/ 8½"

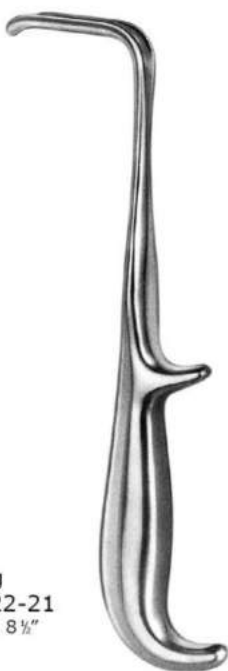

Young  
18-122-21  
21 cm/ 8½"



Young  
18-123-21  
21 cm/ 8½"

Urology, Urologie  
Instrumente für Prostata-Operationen  
Prostatectomy Instruments



Millin  
18-124-24  
24.5 cm/ 9 1/2"



Atrauma  
18-125-23  
23 cm/ 9"

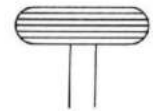

18-126-23  
23 cm/ 9"



18-127-23  
23 cm/ 9"

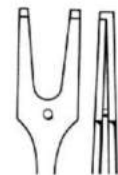

18-128-24  
24 cm/ 9 1/2"

Urology, Urologie  
Blasen-Wundspreizer  
Bladder Retractors



Millin  
18-129-00 Complete  
2 blades 57mmx25mm  
2 blades 82mmx25mm  
1 blade 120mmx45mm



Millin  
18-130-00



Urology. Urologie  
Blasen-Wundspreizer  
Bladder Retractors



Thomson-Walker  
18-131-00



Legueu  
18-132-26  
26 cm/ 10 $\frac{1}{4}$ "  
blade size  
90x35mm

Urology, Urologie  
Dilatationsbougies, Metall-Katheter  
Dilating Bougies, Metal Catheters



**Van Buren**  
**18-134-00**  
Charriere (French)  
No. 8-36



**Guyon**  
**18-135-00**  
Charriere (French)  
No. 10-30



**18-136-39**  
39 cm/ 15½"



**18-133-06**  
Charriere (French)  
15 cm/ 6"  
No: 6-16



**18-137-08 - 18-137-32**  
**Circumcision Clamp**

- 18-137-08 8mm, baby size
- 18-137-11 11mm, child size
- 18-137-13 13mm, child size
- 18-137-16 16mm, adult size
- 18-137-21 21mm, adult size
- 18-137-26 26mm, men's size
- 18-137-32 32mm, men's size

## GYNECOLOGY



**Tenaculum Forceps**

**Vaginal Specula & Retractors**

**Uterien Polypus Forceps**

**Uterine Elevating Forceps**

**Endospecula**

**Suction Biopsy Curettes**

**Uterien Curettes**

**Uterien Scoops**

**Scervical Biopsy & Specimen Forceps**

**Uterien Dilators**

**Vaginal Specula**

Gynecology - Gynäkologie  
Hakenzangen  
Tenaculum Forceps



Staude-Moore  
19-101-17  
17 cm/ 6 $\frac{1}{2}$ "

Pozzi  
19-102-25  
25 cm/ 10"

Duplay  
19-103-28  
28 cm/ 11"

Beacham  
19-104-26  
26 cm/ 10 $\frac{1}{2}$ "

317



Gynecology - Gynäkologie  
Hakenzangen  
Tenaculum Forceps



Schroeder  
19-105-25  
25 cm/ 10"



Braun  
19-106-25  
25 cm/ 10"



Skene  
19-107-24  
24 cm/ 9½"



Gynecology - Gynäkologie  
Hakenzangen  
Tenaculum Forceps

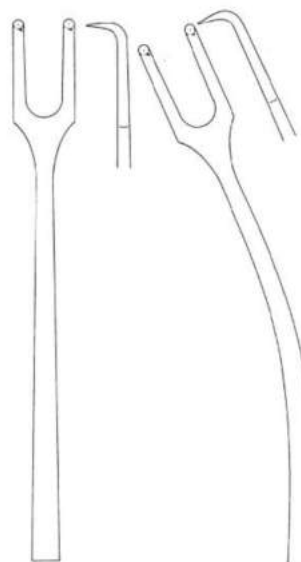

19-108-25

19-109-25

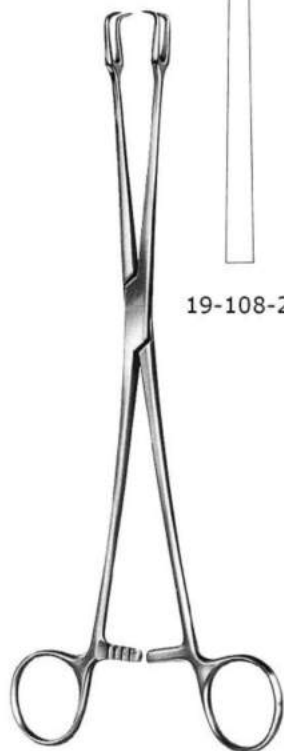

Schroeder  
19-108-25 - 19-109-25  
25 cm/ 10"



Museux  
19-110-24 - 19-112-24  
24 cm/ 9½"



6mm  
19-110-24



8mm  
19-111-24



10mm  
19-112-24

Gynecology - Gynäkologie  
Hakenzangen  
Tenaculum Forceps

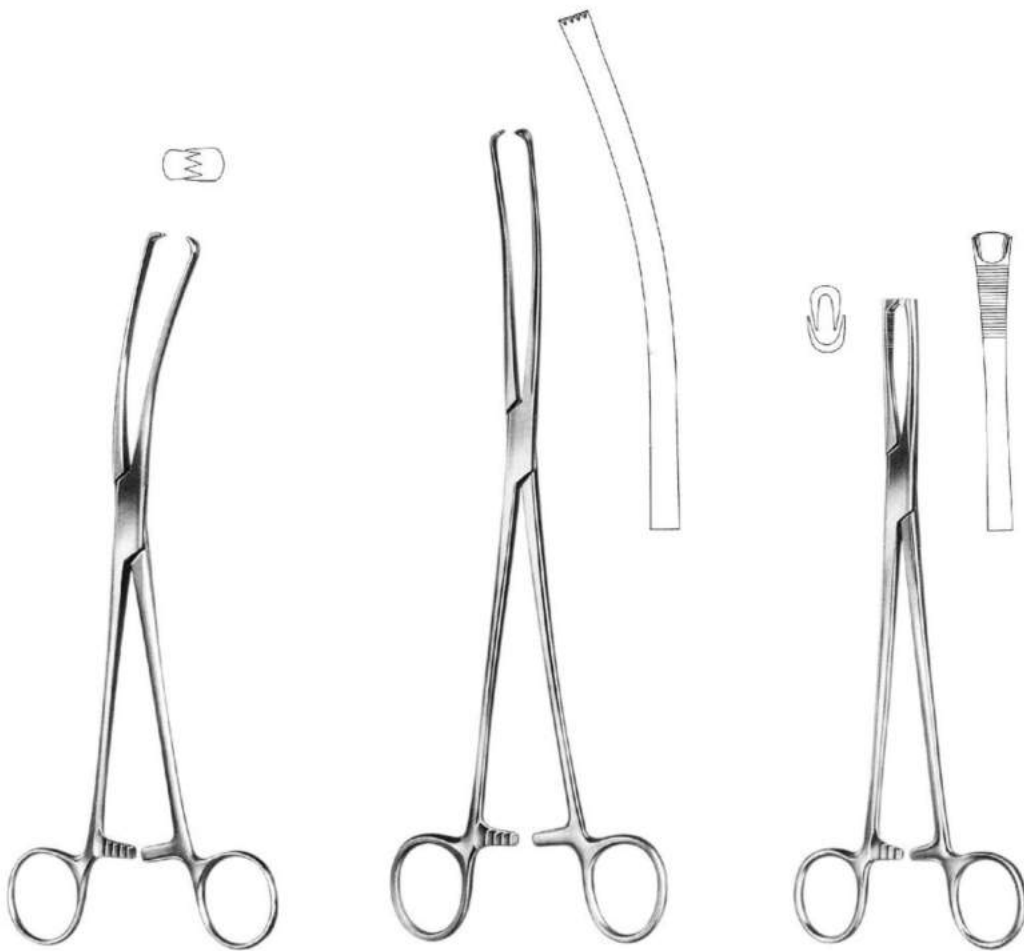

**Teale**  
19-113-23  
23 cm/ 9"

**Iow**  
19-114-26  
26 cm/ 10 1/4"

**Jacobs**  
19-115-21  
21.5 cm/ 8 1/2"

Gynecology - Gynäkologie  
Hakenzangen  
Tenaculum Forceps



Braun  
19-116-15  
15 cm/ 6"



Czerny  
19-117-20  
20 cm/ 8"

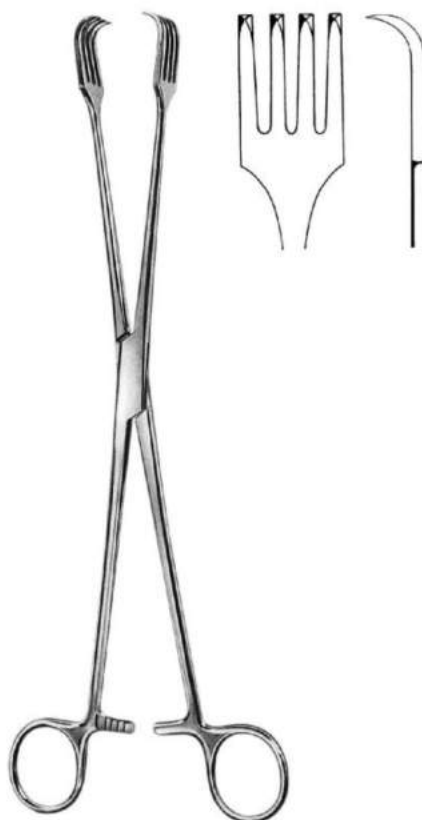

19-118-26  
26 cm/ 10 1/4"



Gynecology - Gynäkologie  
Uterus-Polypenzangen  
Uterine Polypus Forceps



Doyen  
19-119-20  
20 cm/ 8"



Noto  
19-120-27  
28 cm/ 11"



Kelly  
19-121-32  
32 cm/ 12½"







Gynecology - Gynäkologie  
Uterus-Faßzangen  
Uterine Elevating Forceps



Somer  
19-122-23  
23.5 cm/ 9 1/4"

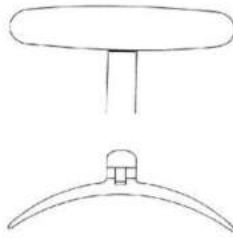

Collin  
19-123-26  
26 cm/ 10 1/4"



Dartigues  
19-124-25  
25 cm/ 10"



Gynecology - Gynäkologie  
Endospekula  
Endospecula



Kogan  
19-125-24  
24 cm / 9½"

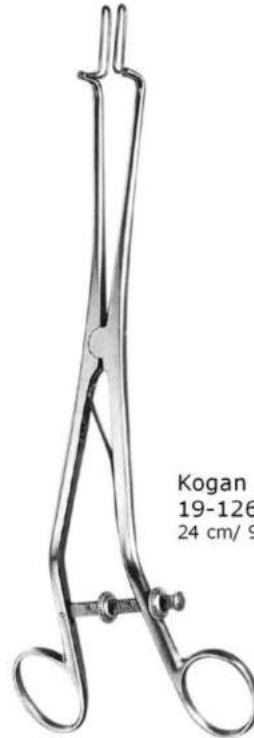

Kogan  
19-126-24  
24 cm / 9½"



Myoma Instruments

Doyen  
19-127-17  
17 cm / 6¾"



Doyen  
19-128-17  
17 cm / 6¾"



Segond  
19-129-27  
27 cm / 10½"

Gynecology - Gynäkologie  
Saug- und Biopsieküretten  
Suction Biopsy Curettes



Novak  
19-132-24  
24 cm/ 9½"  
4mmφ



Simon  
19-130-22  
22 cm/ 8½"



Kevorkian  
19-133-30  
30 cm/ 12"



Ayre  
19-131-23  
23 cm/ 9"



Mod. Muenchen  
19-134-27  
27 cm/ 10½"



Gynecology - Gynäkologie  
 Uterusküretten  
 Uterine Curettes



Sims  
 19-135-05 - 19-135-40  
 26 cm/ 10½"  
 Recamier  
 19-136-05 - 19-136-40  
 31 cm/ 12"  
 Rigid, Sharp



Sims  
 19-137-05 - 19-137-40  
 26 cm/ 10½"  
 Recamier  
 19-138-05 - 19-138-40  
 31 cm/ 12"  
 Malleable, Sharp



Sims  
 19-139-05 - 19-139-40  
 26 cm/ 10½"  
 Recamier  
 19-140-05 - 19-140-40  
 31 cm/ 12"  
 Rigid, Blunt



Sims  
 19-141-05 - 19-141-40  
 26 cm/ 10½"  
 Recamier  
 19-142-05 - 19-142-40  
 31 cm/ 12"  
 Malleable, Blunt



Gynecology - Gynäkologie  
Uterusküretten  
Uterine Curettes

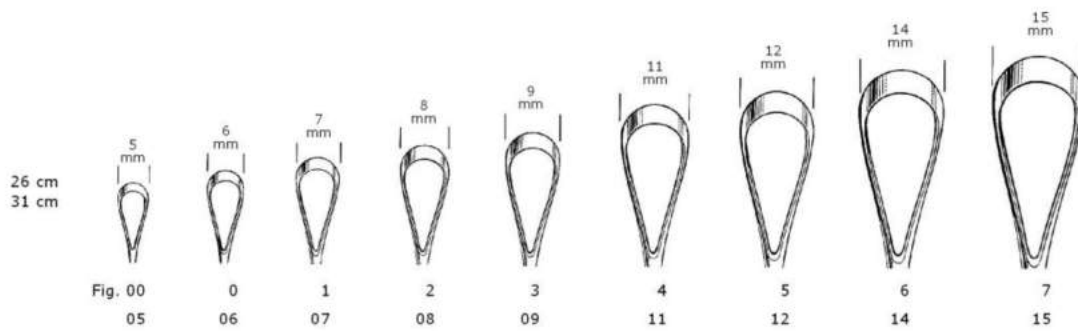

Last two digits

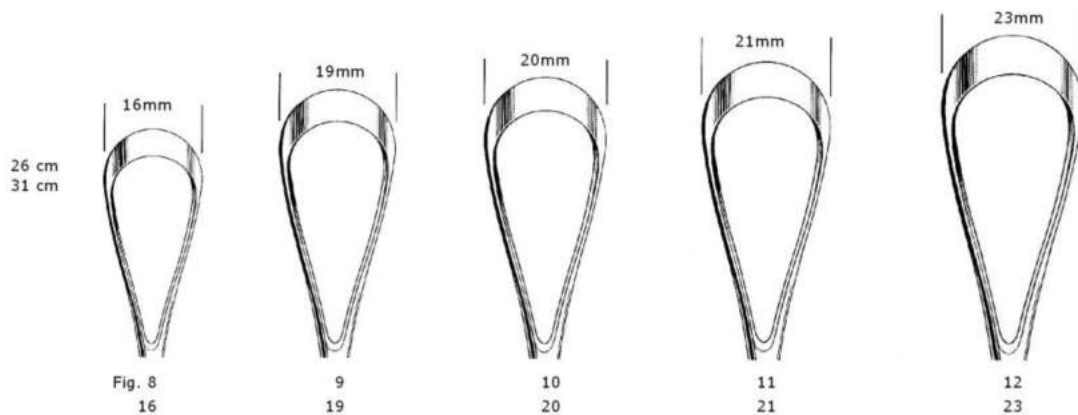

Last two digits

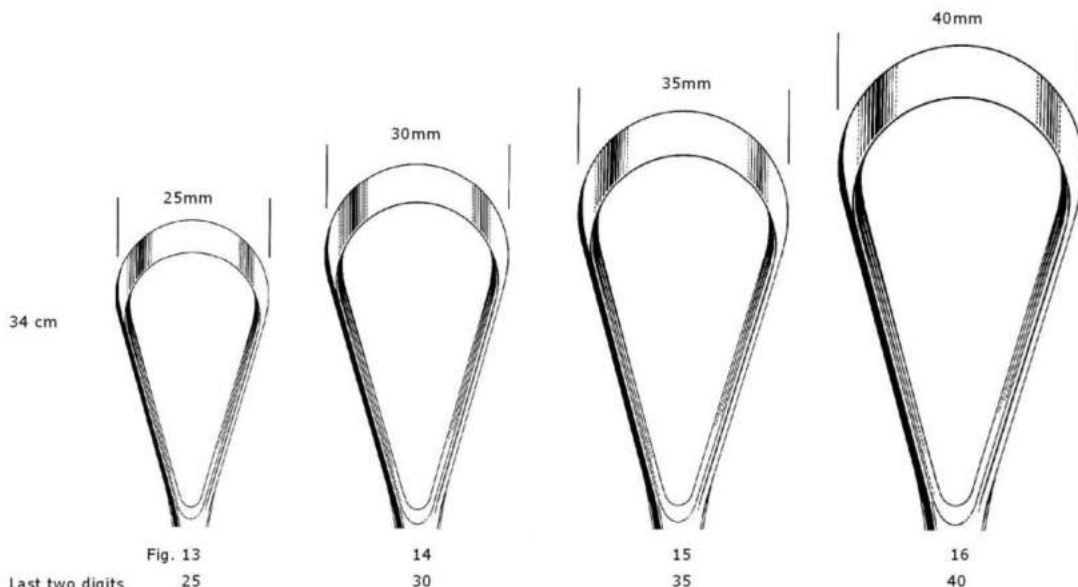

Last two digits

Recamier- Sims





Gynecology - Gynäkologie  
 Uteruslöffel  
 Uterine Scoops



19-143-01



19-143-02



19-143-03



19-143-04



19-143-05



19-143-06



Simon  
 19-143-01 - 19-143-06  
 24 cm / 9½"  
 sharp, rigid



19-144-01



19-144-02



19-144-03



19-144-04



19-144-05



19-144-06



Schroeder  
 19-144-01 - 19-144-06  
 31 cm / 12¼"  
 sharp, rigid



Gynecology - Gynäkologie  
 Probeexzisionszangen  
 Cervical Biopsy and Specimen Forceps

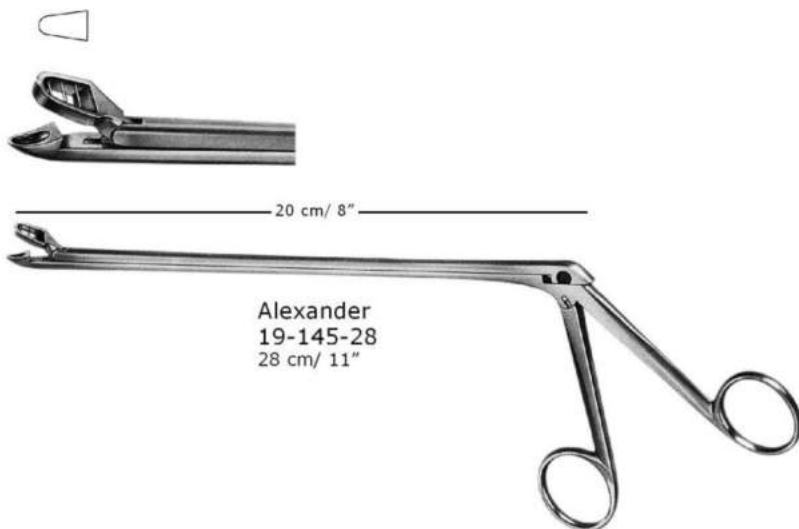

Alexander  
 19-145-28  
 28 cm / 11"



Schubert  
 19-146-21 21 cm / 8 1/4"  
 19-146-29 29 cm / 11 1/2"



Gellhorn  
 19-147-23  
 23 cm / 9"



Faure  
 19-148-21  
 21 cm / 8 1/4"



Gynecology - Gynäkologie  
 Probeexzisionszangen  
 Cervical Biopsy and Specimen Forceps



Van Doren  
 19-149-25  
 25 cm/ 10"



Van Doren  
 19-150-24  
 24 cm/ 9½"



Schubert  
 19-151-26  
 26 cm/ 10¼"



Thoms-Gaylor  
 19-152-22 22 cm/ 8½"  
 19-152-24 24 cm/ 9½"



Gynecology - Gynäkologie  
 Probeexzisionszangen  
 Cervical Biopsy and Specimen Forceps

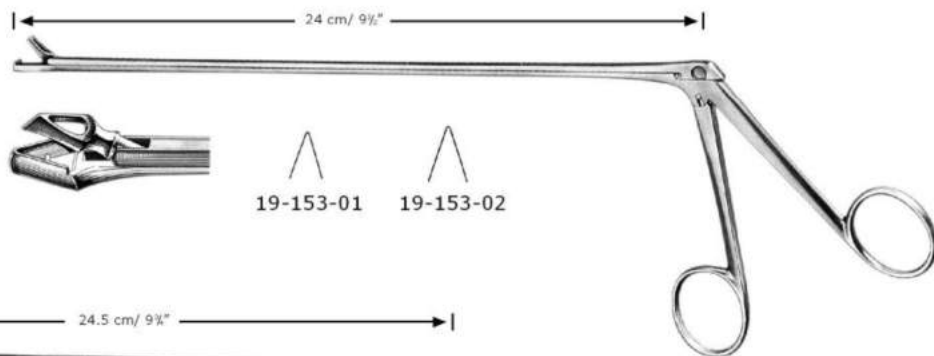

Schumacher  
 19-153-01 - 19-153-02

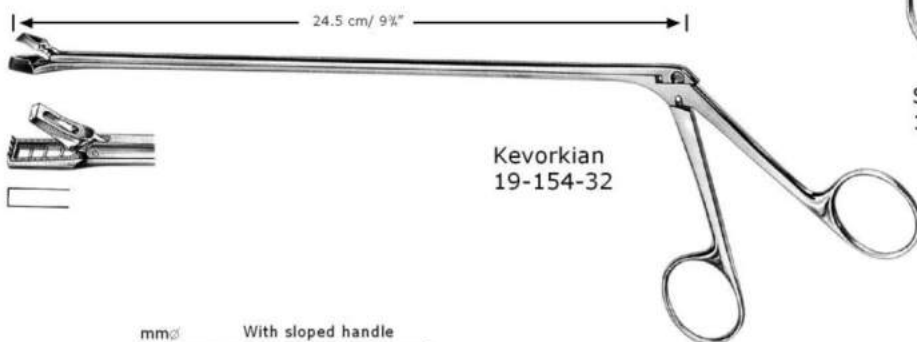

Kevorkian  
 19-154-32

mm∅	With sloped handle
1.0	19-155-01
1.5	19-156-01
2.0	19-155-02
2.5	19-156-02
3.0	19-155-03
3.5	19-156-03
4.0	19-155-04
4.5	19-156-04
5.0	19-155-05
5.5	19-156-05
6.0	19-155-06
6.5	19-156-06
7.0	19-155-07
7.5	19-156-07
8.0	19-155-08
8.5	19-156-08
9.0	19-155-09
9.5	19-156-09
10.0	19-155-10
10.5	19-156-10
11.0	19-155-11
11.5	19-156-11
12.0	19-155-12
12.5	19-156-12
13.0	19-155-13
13.5	19-156-13
14.0	19-155-14
14.5	19-156-14
15.0	19-155-15
15.5	19-156-15
16.0	19-155-16
16.5	19-156-16
17.0	19-155-17
17.5	19-156-17
18.0	19-155-18
18.5	
19.0	19-155-19
19.5	
20.0	19-155-20
21.0	19-155-21
22.0	19-155-22
23.0	19-155-23
24.0	19-155-24
25.0	19-155-25
26.0	19-155-26

With Artificial  
 Leather Pouch  
 19-155-00  
 Set of 26

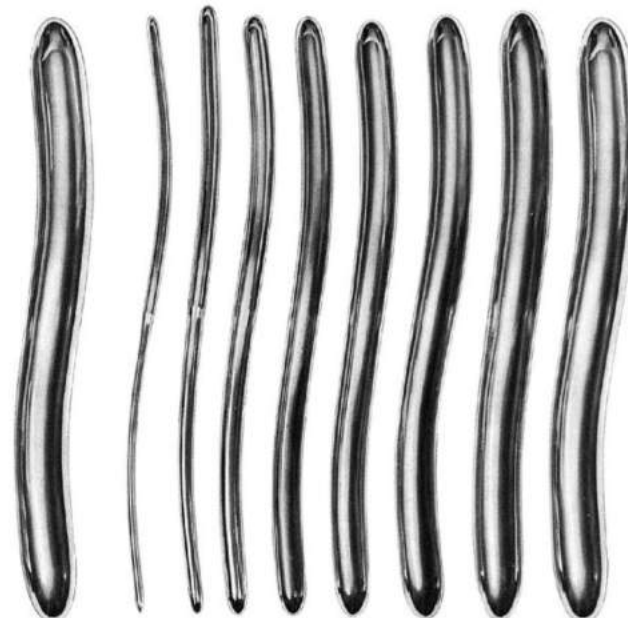

19-157-00  
 Uterine Dilators  
 Set of 8  
 In Artificial  
 Leather Pouch

mm∅	
3.0/4.0	19-157-04
5.0/6.0	19-157-06
7.0/8.0	19-157-08
9.0/10.0	19-157-10
11.0/12.0	19-157-12
13.0/14.0	19-157-14
15.0/16.0	19-157-16
17.0/18.0	19-157-18

19-156-00  
 Set of 17





Gynecology - Gynäkologie  
 Uterus-Dilatatoren  
 Uterine Dilators

**Hank**

- Fig. 9/10 19-158-10 4.5/5 mm
- Fig. 11/12 19-158-12 5.5/6 mm
- Fig. 13/14 19-158-14 6.5/7 mm
- Fig. 15/16 19-158-16 7.5/8 mm
- Fig. 17/18 19-158-18 8.5/9 mm
- Fig. 19/20 19-158-20 9.5/10 mm

**Uterine Sounds**



**Hank**  
 19-159-00  
 Set of 6  
 In Artificial leather  
 pouch



**Braun**  
 19-160-27  
 27 cm/ 10 3/4"



**Valleix**  
 19-161-25  
 25 cm/ 10"



**Sims**  
 19-162-32  
 32 cm/ 12 1/2"  
 Malleable



**Martin**  
 19-163-30  
 30 cm/ 12"  
 Malleable





Gynecology - Gynäkologie  
Scheidenspekula  
Vaginal Specula



Cusco  
19-164-01 75x32mm  
19-164-02 85x35mm  
19-164-03 100x37mm  
Centre Screw



Cusco  
19-165-01 90x22mm  
19-165-02 100x25mm  
19-165-03 105x27mm  
Side Screw



Cusco  
19-166-01  
75x17mm  
Swiss Pattern



Cusco  
19-167-01 75x32mm  
19-167-02 85x35 mm  
19-167-03 100x35 mm  
Side Screw



Gynecology - Gynäkologie  
Scheidenspekula  
Vaginal Specula



Winterton  
19-168-00



Semm  
19-169-01 100x17/20mm  
19-169-02 100x25/30mm



Collin  
19-170-01 85x30mm  
19-170-02 100x35mm  
19-170-03 110x40mm

Pederson  
19-171-01 75x13mm  
19-171-02 100x22mm  
19-171-03 120x25mm

Grave  
19-172-01 75x20mm  
19-172-02 95x35mm  
19-172-03 115x35mm



Gynecology - Gynäkologie  
Scheidenspekula  
Vaginal Specula



**Kristeller**  
Set of 1 Speculum and  
1 Retractor each  
Fig. 1 19-173-01  
Fig. 2 19-173-02  
Fig. 3 19-173-03



**Kristeller**  
Retractors  
Fig. 1 19-174-01 75x23mm  
Fig. 2 19-174-02 85x26mm  
Fig. 3 19-174-03 100x32mm



**Kristeller**  
Specula  
Fig. 1 19-175-01 70x27mm  
Fig. 2 19-175-02 80x30mm  
Fig. 3 19-175-03 90x36mm



**Kristeller**  
Set of 1 Speculum and  
1 Retractor each  
19-176-01  
19-176-02



**Kristeller**  
Retractors  
19-177-01 110x14mm  
19-177-02 110x17mm



**Kristeller**  
Specula  
19-178-01 105x18mm  
19-178-02 105x21mm

Gynecology - Gynäkologie  
Scheidenspekula und-halter  
Vaginal Specula and Retractors



**Kristeller**  
Set of 1 Speculum and  
1 Retractor each  
Fig. 1 19-179-01  
Fig. 2 19-179-02  
Fig. 3 19-179-03



**Kristeller**  
Retractors  
Fig. 1 19-180-01 115x22mm  
Fig. 2 19-180-02 115x24mm  
Fig. 3 19-180-03 115x29mm



**Specula**  
Fig. 1 19-181-01 105x26mm  
Fig. 2 19-181-02 105x28mm  
Fig. 3 19-181-03 105x33mm

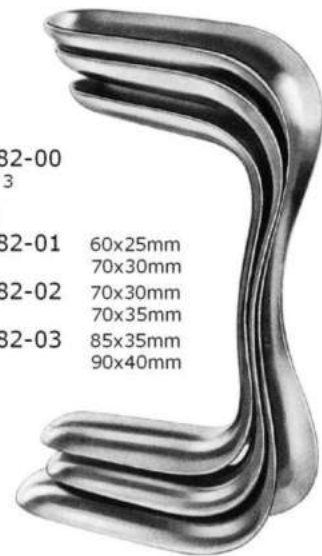

**19-182-00**  
Set of 3  
**Sims**  
19-182-01 60x25mm  
70x30mm  
19-182-02 70x30mm  
70x35mm  
19-182-03 85x35mm  
90x40mm



Gynecology, Gynäkologie  
Scheidenspekula und-halter  
Vaginal Specula and Retractors



Vaginal Retractors

- 19-183-01 100x11mm  
100x20mm
- 19-183-02 100x14mm  
100x26mm

21 cm/ 8 1/4"



Mathieu  
Vaginal Specula

- 19-184-01 95x16mm  
95x26mm
- 19-184-02 95x16mm  
95x30mm

21 cm/ 8 1/4"



Vaginal Retractors

- 19-185-01 70x33mm
- 19-185-02 90x33mm

17 cm/ 6 3/4"



Kallmorgen  
Vaginal Specula

- 19-187-01 70x40mm
- 19-187-02 90x40mm

17 cm/ 6 3/4"

set of 1 specula and 1 retractor each  
19-186-01  
19-186-02



Gynecology, Gynäkologie  
Scheidenspekula  
Vaginal Specula

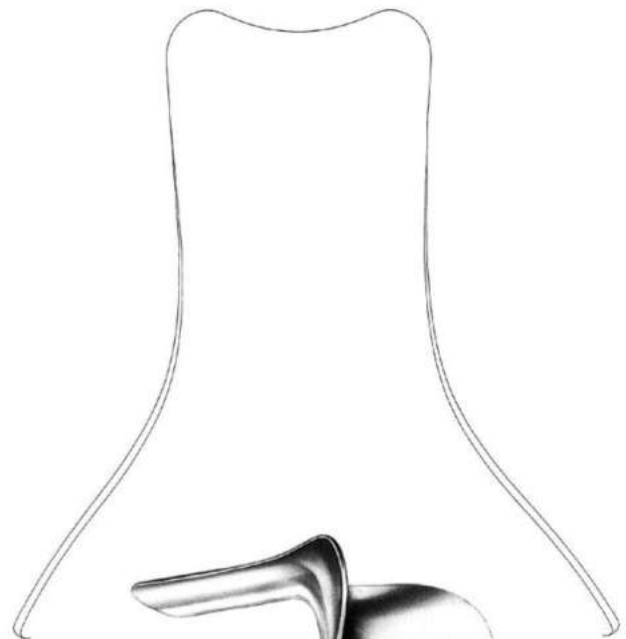
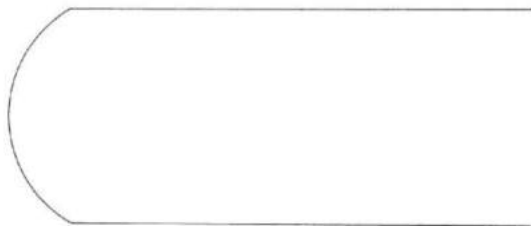
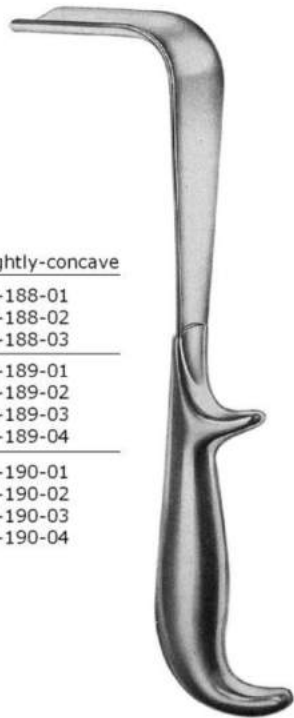

Fig.	a mm	b mm	slightly-concave
1	55	35	19-188-01
2	58	35	19-188-02
3	115	35	19-188-03
1	55	45	19-189-01
2	85	45	19-189-02
3	115	45	19-189-03
4	160	45	19-189-04
1	55	60	19-190-01
2	85	60	19-190-02
3	115	60	19-190-03
4	160	60	19-190-04



Doyen  
18-188-01 - 18-190-04  
23.5 cm/ 9 1/4"



Auvard  
19-191-22

-complete, with removable weight

Gynecology - Gynäkologie  
Scheidenspekula und-halter  
Vaginal Specula and Retractors



O'Sullivan-O'Connor  
19-195-00



**Breisky**  
19-192-20 - 19-193-40

19-192-20	100x20mm
19-192-25	100x25mm
19-192-30	100x30mm
19-192-35	100x35mm
19-192-40	100x40mm
19-193-20	130x20mm
19-193-25	130x25mm
19-193-30	130x30mm
19-193-35	130x35mm
19-193-40	130x40mm

**Doyen**  
19-194-24  
24 cm/ 9 1/2"

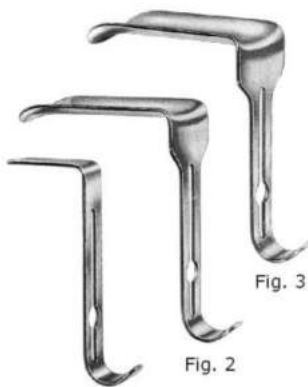

Fig. 1

Fig. 2

Fig. 3

Fig. 1 45x17mm  
Fig. 2 90x37mm  
Fig. 3 90x45mm

19-195-00 - Vaginal Speculum, Complete  
self-retaining, with adjustable frame,  
Loktite ratchet, 2 mobile lateral blades  
and 3 interchangeable blades fig. 1-3

## OBSTETRICS



Pelvimeters, Obstetrical (Midwifery) Forceps

Scalp Flap Forceps, Elevating Spoon, Etc

Ovum Curettes, Abortion Scoops

Obstetrics - Geburtshilfe  
 Beckenzirkel, Geburtszangen  
 Pelvimeters, Obstetrical (Midwifery) Forceps



Simpson  
 20-101-30  
 30 cm/ 12"

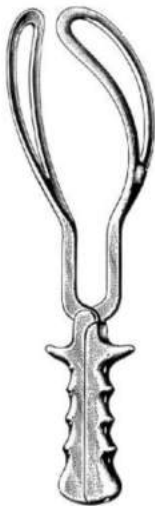

Simpson-Braun  
 20-102-30 30 cm/ 12"  
 20-102-36 36 cm/ 14"



Sellheim  
 20-103-28  
 28 cm/ 11"



Kielland  
 20-104-41  
 41 cm/ 16"



Naegele  
 20-105-36 36 cm/ 14"  
 20-105-40 40 cm/ 16"



20-106-34  
 34 cm/ 13 1/2"  
 cm/ inch scale





Obstetrics - Geburtshilfe  
Kopfschwartenzangen, Geburtslöffel usw.  
Scalp Flap Forceps, Elevating Spoon, etc.

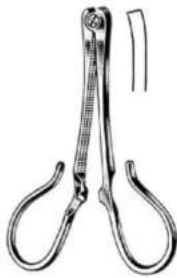

Kane  
20-107-08  
8.5 cm/ 3 1/2"



Collin  
20-108-09  
9 cm/ 3 1/2"

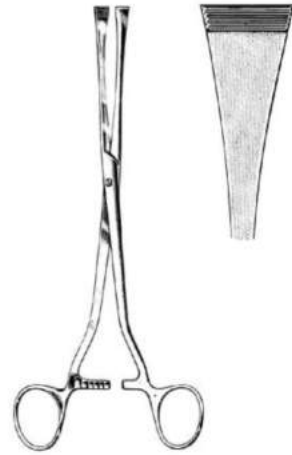

Green-Armytage  
20-109-21  
21 cm/ 8 1/4"

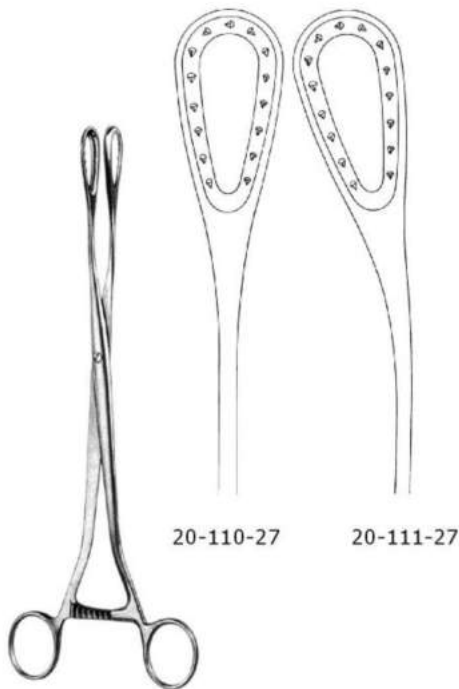

Saenger  
20-110-27 - 20-111-27  
27 cm/ 10 1/2"

Winter  
20-112-01 - 20-113-02  
29 cm/ 11 1/2"

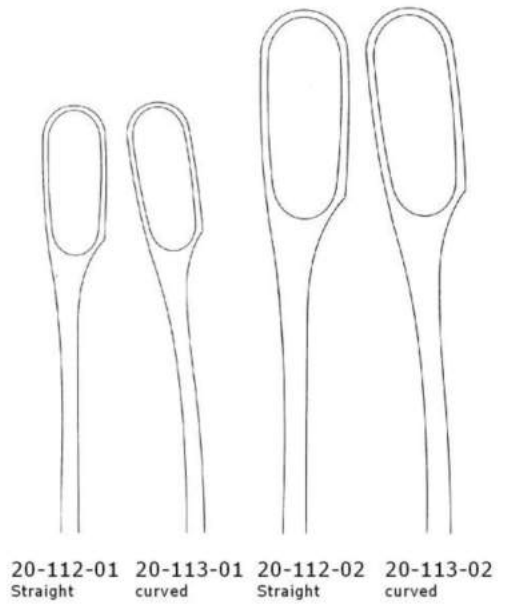

20-112-01 Straight  
20-113-01 curved  
20-112-02 Straight  
20-113-02 curved





Obstetrics, Geburtshilfe  
 Abortusküretten und -löffel  
 Ovum Curettes, Abortion Scoops

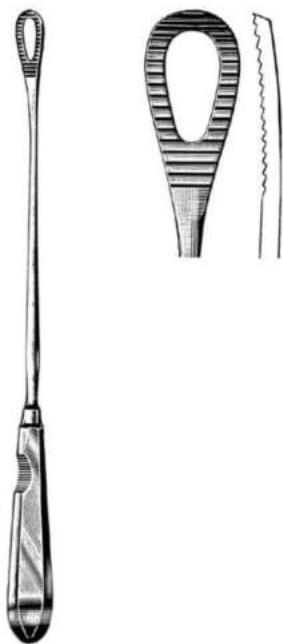

Pestalozza  
 20-114-01  
 30 cm/ 12"



Cuzzi  
 20-115-01 - 20-115-03  
 30 cm/ 12"



20-115-01



20-115-02



20-115-03

## OTOLOGY



Tuning Forks

Ear Spatula

Ear Dressing Forceps

Ear Polypus Forceps

Micro Ear Forceps

Micro Ear Scissors

Crettes

Loops, Foreign Body Instruments, Hooks

Ear Syringes, Ear Polypus Forceps

Paracentesis Needles-Needles Knives

Otology, Otologie  
Stimmgabeln  
Tuning Forks

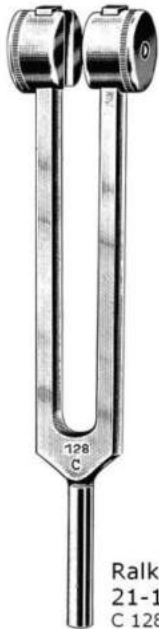

Ralks  
21-101-10  
C 128



Ralks  
21-102-11  
C 256

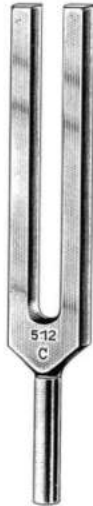

Ralks  
21-103-12  
C 512



Ralks  
21-104-13  
C 1024



Ralks  
21-105-14  
C 2048



Lucae  
21-106-10  
C 128



Lucae  
21-107-11  
C 256



Lucae  
21-108-12  
C 512



Lucae  
21-109-13  
C 1024



Lucae  
21-110-14  
C 2048



Lucae  
21-111-15  
C 4096



Otology, Otologie  
Stimmgabeln  
Tuning Forks



Hartmann  
21-112-10  
C 128

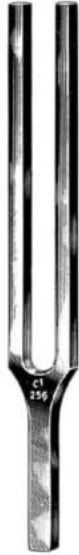

Hartmann  
21-113-11  
C 256



Hartmann  
21-114-12  
C 512



Hartmann  
21-115-13  
C 1024



Hartmann  
21-116-14  
C 2048



Hartmann  
21-117-15  
C 4096

Eustachian Catheters, Ear Polypus Snares



Hartmann  
21-118-00 - 21-118-03

- 21-118-00
- 21-118-02
- 21-118-03



Krause  
21-119-16



Krause-Voss  
21-120-16



Otology - Otologie  
Ohrspekula  
Ear Specula

mmØ  
= 3  
21-121-01

= 4.0  
21-121-02

= 5.0  
21-121-03



Hartmann  
for Children

21-121-01 - 21-121-03

Set of 3

mmØ  
= 4.0  
21-122-11

= 5.0  
21-122-12

= 6.0  
21-122-13

= 7.5  
21-122-14



Hartmann  
for adults

21-122-11  
21-122-14

mmØ  
= 4.0  
21-123-11

= 5.0  
21-123-12

= 6.0  
21-123-13

= 7.5  
21-123-14



Toynbee  
for adults

21-123-11  
21-123-14

4.5mm  
21-124-01

5.5mm  
21-124-02

6.5mm  
21-124-03

7.5mm  
21-124-04



Gruber  
21-124-01  
21-124-04



Farrior  
21-125-01  
21-125-07  
black

5.5mm  
21-125-01

6.5mm  
21-125-02

7.5mm  
21-125-03

8.5mm  
21-125-04

9.5mm  
21-125-05

10.5mm  
21-125-06

11.5mm  
21-125-07

Otology - Otologie  
Ohrpinzetten  
Ear Dressing Forceps

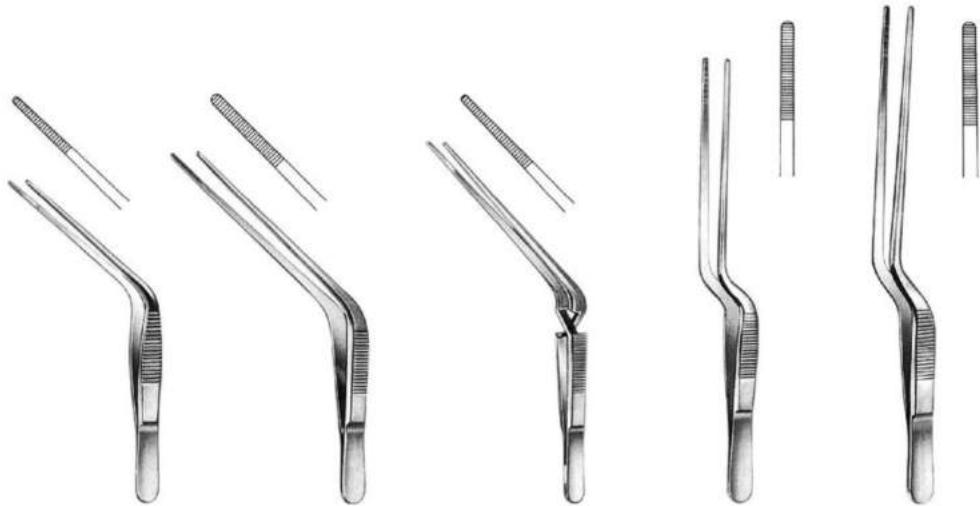

Troeltsch  
21-126-11  
11 cm/ 4 1/2"

Troeltsch  
21-127-12  
12 cm/ 4 3/4"

Troeltsch  
21-128-13  
13 cm/ 5"

Lucae  
21-129-14  
14 cm/ 5 1/2"

Jansen  
21-130-16 16 cm/ 6 1/4"  
21-130-20 20 cm/ 8"

Punches

☐ 21-131-02 2mm  
☐ 21-131-03 3mm

☐ 2mm

☐ 1mm



Citelli  
21-131-02 - 21-131-03  
17 cm/ 6 3/4"

Beyer  
21-132-19  
19 cm/ 7 1/2"

Beyer  
21-133-14

Otology - Otologie  
Ohr-Polypenzangen  
Ear Polypus Forceps



Hartmann-  
Wullstein  
21-134-08  
8.5 cm/ 3½"



Hartmann-  
Wullstein  
21-135-08  
8.5 cm/ 3½"



Hartmann  
21-136-08 8.5 cm/ 3½"  
21-136-14 14 cm/ 5½"  
21-136-16 16.5 cm/ 6½"



Hartmann  
21-137-08 8.5 cm/ 3½"



Hartmann-  
Noyes  
21-138-09  
9 cm/ 3½"



Hartmann-  
Noyes  
21-139-09  
9 cm/ 3½"



Hartmann-  
Weingartner  
21-140-08  
8.5 cm/ 3½"



Hartmann  
21-141-08  
8.5 cm/ 3½"



Hartmann  
21-142-01 2mm ø  
21-142-02 2.5mm ø  
21-142-03 3mm ø  
8.5 cm/ 3½"



Hartmann  
21-143-08 3mm ø  
8.5 cm/ 3½"



Struempel  
21-144-08  
8.5 cm/ 3½"



Hartmann  
21-145-08  
8.5 cm/ 3½"

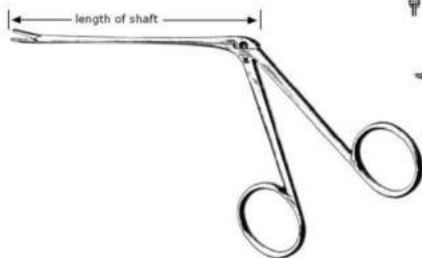

21-134-08 - 21-145-08

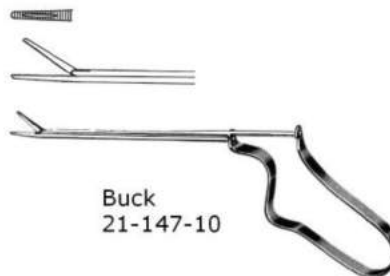

Otology - Otologie  
Mikro-Ohrzängchen  
Micro Ear Forceps

		smooth		21-148-01 Straight
		serrated		21-148-02 Straight
21-148-01 - 21-148-05				21-148-03 curved up
				21-148-04 right
				21-148-05 left
		serrated		21-148-06 4.0x0.6mm Straight
				21-148-07 3.0x0.6mm curved up
				21-148-08 3.0x0.6mm right
21-148-06 - 21-148-09				21-148-09 3.0x0.6mm left



Otology, Otologie  
Mikro-Ohrzangchen  
Micro Ear Forceps



Mini McGee Alligator  
21-149-11 - 21-149-16

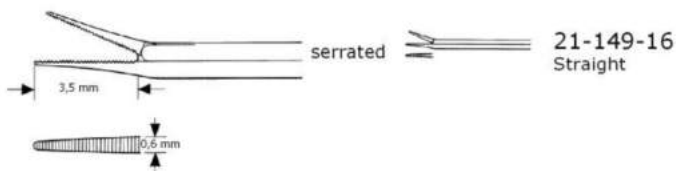
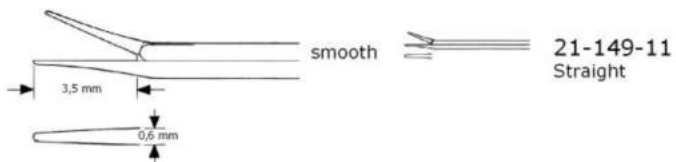

21-150-01 - 21-150-04

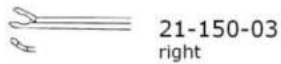
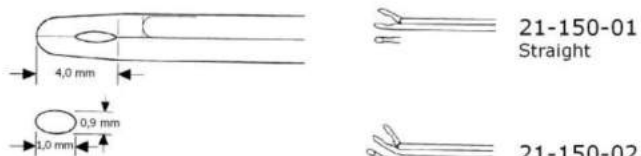

Otology, Otologie  
Mikro-Ohrscheren  
Micro Ear Scissors



**Bellucci**  
21-151-01 - 21-151-04  
8 cm/ 3 1/4"

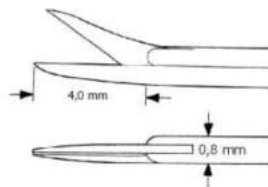

21-151-01  
Straight

21-151-02  
Curved up

21-151-03  
right

21-151-04  
left

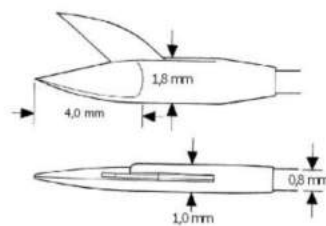

21-151-05  
Straight

21-151-06  
Curved up

21-151-07  
right

21-151-08  
left



**Wullstein**  
21-151-05 - 21-151-08

Otology, Otologie  
Küretten  
Curettes



**Jansen**  
21-153-15  
15 cm/ 6"  
sharp



**Buck**  
21-154-10 - 21-155-14  
16.5 cm/ 6½"

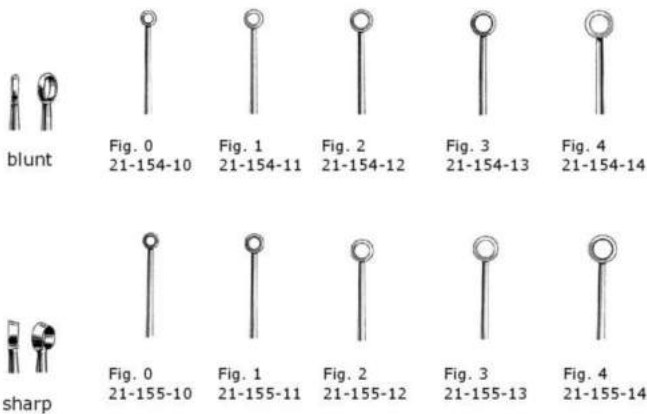

**Barth**  
21-156-18  
18 cm/ 7¼"  
sharp



**Buck**  
21-157-10 - 21-158-14  
16.5 cm/ 6½"

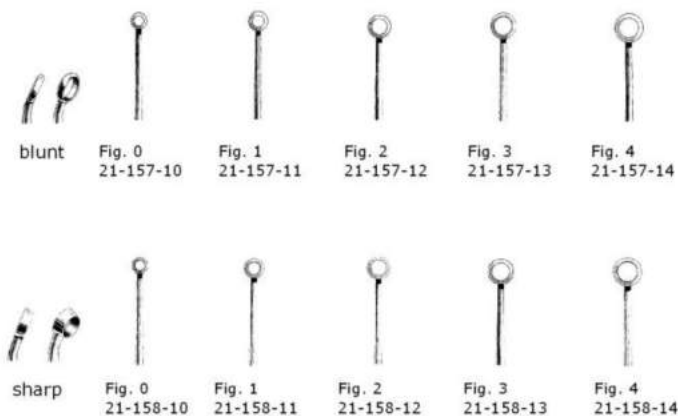

Otology, Otologie  
Küretten  
Curettes

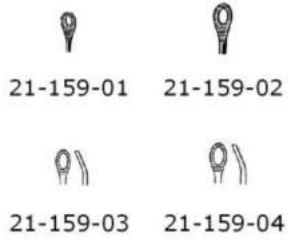

**Shapleigh**  
21-159-01 - 21-159-04  
13 cm/ 5 1/4"

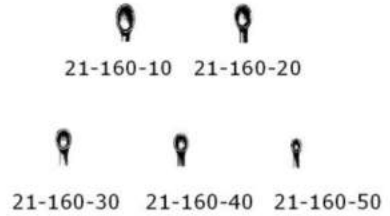

**Lempert**  
21-160-10 - 21-160-50  
18 cm/ 7"



**Langenbeck**  
21-161-13  
13 cm/ 5 1/4"

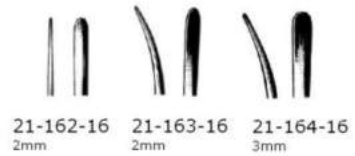

**Lempert**  
21-162-16 - 21-164-16  
16.5 cm/ 6 1/2"



Otology, Otologie  
Schlingen, Fremdkörperinstrumente, Haken  
Loops, Foreign Body Instruments, Hooks



Gross  
21-165-12  
12 cm/ 4 1/2"  
blunt



21-166-16  
16 cm/ 6 1/4"



Billeau  
21-167-16  
16.5 cm/ 6 1/2"



Lucae  
21-168-14  
14 cm/ 5 1/2"

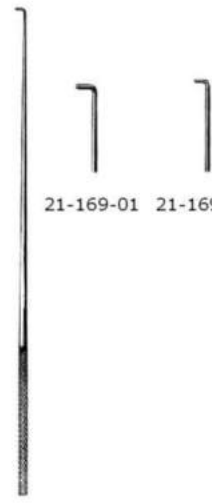

21-169-01 21-169-02

Day  
21-169-01 - 21-169-02  
16 cm/ 6 1/2"



Moldenhauer  
21-170-16  
16.5 cm/ 6 1/2"



Zaufal  
21-171-16  
16.5 cm/ 6 1/2"



Hartmann  
21-172-16  
16.5 cm/ 6 1/2"



Wagener  
21-173-14  
14 cm/ 5 1/2"

Otology, Otologie  
 Ohrspritzen, Polypenzängchen  
 Ear Syringes, Ear Polypus Forceps



21-174-00 50 ml  
 21-174-03 75 ml  
 21-174-04 100 ml  
 Ear Syringe, complete



Littauer  
 21-175-12  
 12 cm/ 4 1/2"



Hartmann  
 21-176-12  
 12 cm/ 4 1/2"  
 fine pattern



Hartmann  
 21-177-14  
 14 cm/ 5 1/2"  
 standard pattern

Otologie, Otologie  
 Parazentesenadeln-Messer  
 Paracentesis Needles-Knives

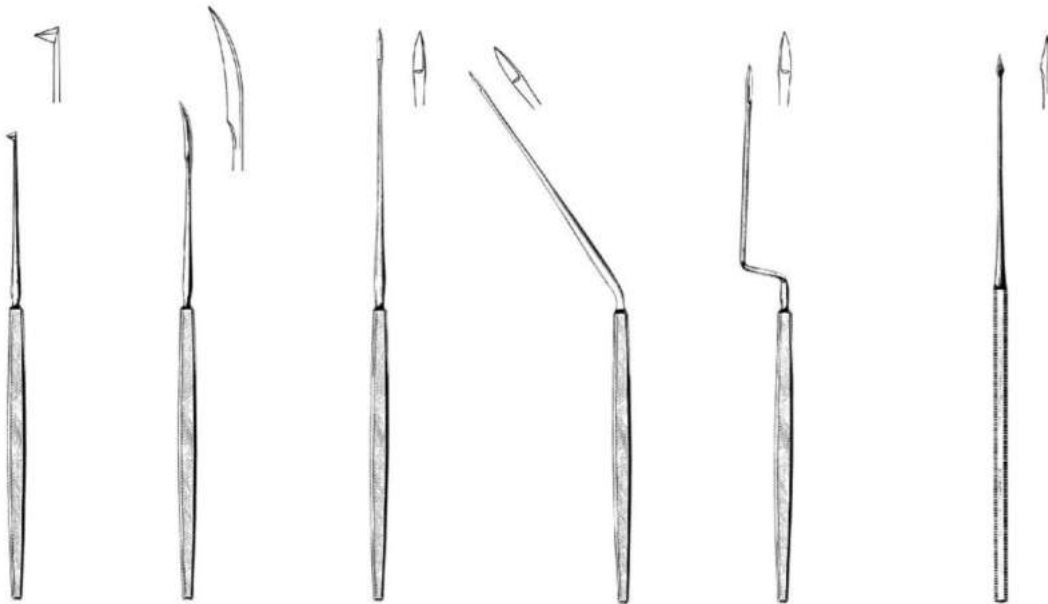

Politzer  
 21-178-16  
 16.5 cm/ 6½"

Buck  
 21-179-15  
 15 cm/ 6"

Sexton  
 21-180-18  
 18 cm/ 7"

Sexton  
 21-181-17  
 17 cm/ 6¾"

Gerzog-Sexton  
 21-182-17  
 17 cm/ 6¾"

Politzer  
 21-183-16  
 16.5 cm/ 6½"

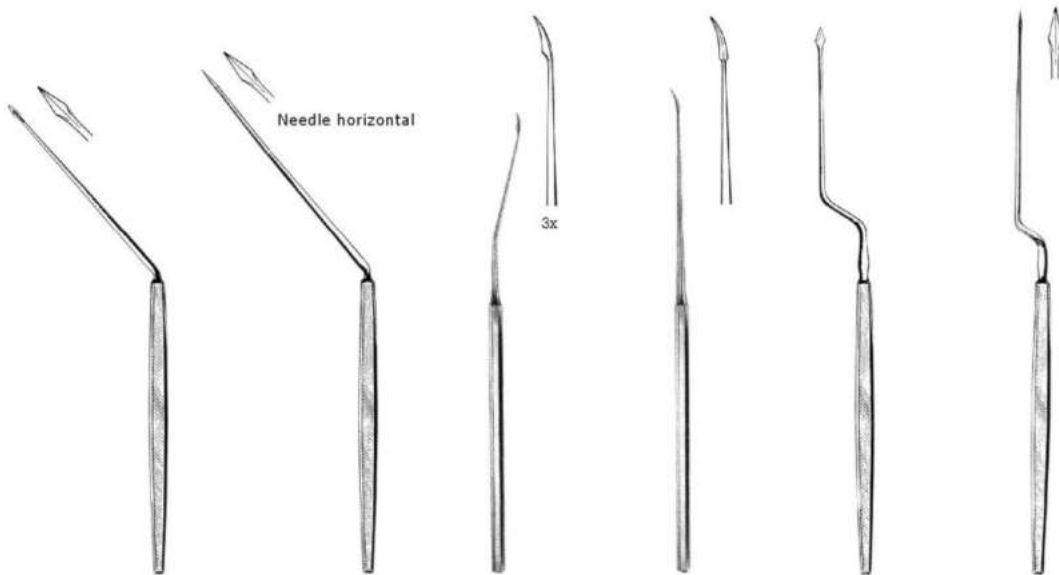

Politzer  
 21-184-16  
 16.5 cm/ 6½"

Politzer  
 21-185-16  
 16.5 cm/ 6½"

Schuknecht  
 21-186-06

Wullstein  
 21-187-11

Lucae  
 21-188-18  
 18 cm/ 7"

Lucae  
 21-189-18  
 18 cm/ 7"

## RHINOLOGY



**Nasal Spatula**

**Rhinoplastic Instruments etc**

**Nasal Snares**

**Tampon Forceps, Nasal Polypus Forceps**

**Nasal & Polypus & Septum Compression Forceps**

**Nasal Cutting Forceps**

**Septum Scissors & Septum Forceps**

**Sphenoid Punches, Antrum Punch Forceps**

**Sphenoid Punches & Rongeur Forceps**

**Septum Knives**

**Septum & Periosteal Elevators**



Rhinology, Rhinologie  
Nasenspekula  
Nasal Specula

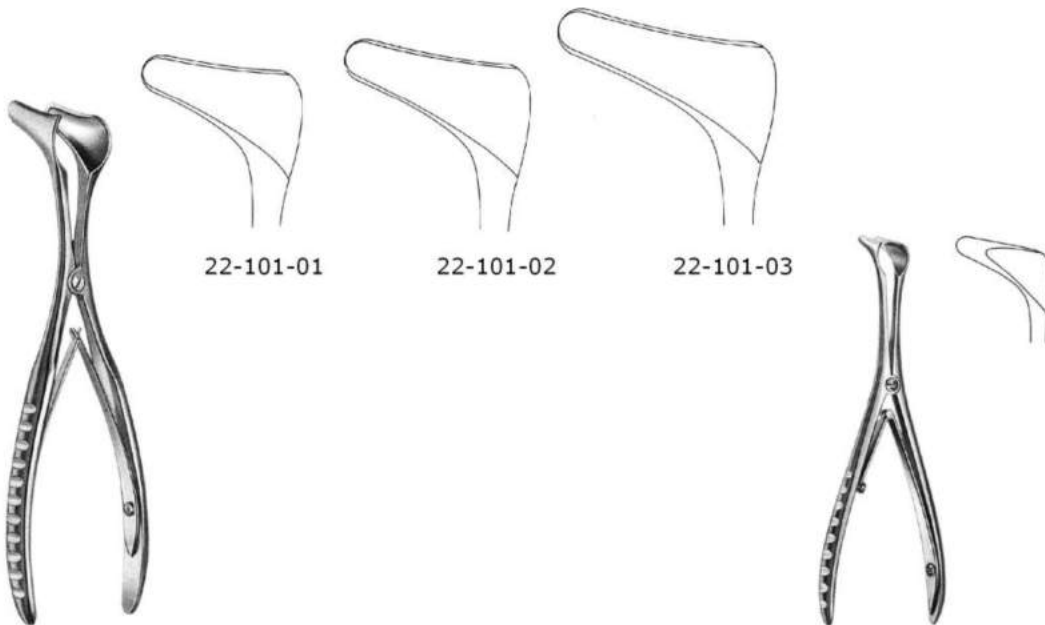

Hartmann-Halle  
22-101-01 - 22-101-03  
15 cm/ 6"

Tieck-Halle  
22-102-13  
13.5 cm/ 5 1/4"



22-103-13  
13 cm/ 5"

22-104-13  
13 cm/ 5"

Mod. Wien  
22-105-14  
14.5 cm/ 5 1/2"

Rhinology, Rhinologie  
Nasenspekula  
Nasal Specula



Voltolini  
22-106-01 - 22-106-03

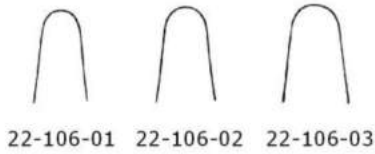

22-106-01 22-106-02 22-106-03



22-107-01 22-107-02 22-107-03



Killian  
22-108-35 - 22-108-90  
13 cm/ 5"

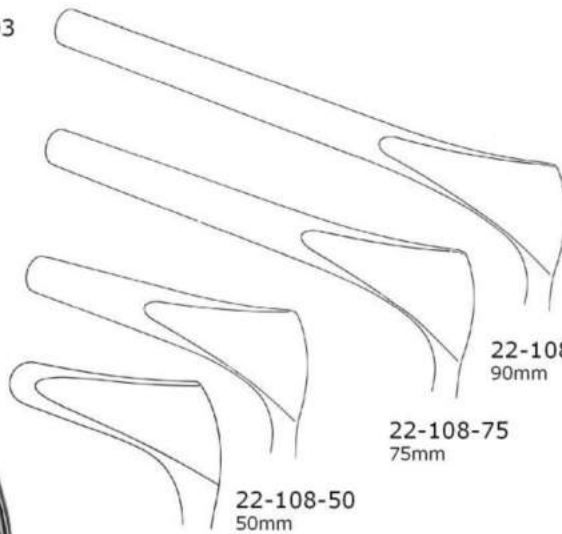

22-108-35  
35mm

22-108-50  
50mm

22-108-75  
75mm

22-108-90  
90mm



Thudichum  
22-107-01 - 22-107-03



Cottle  
22-109-35 - 22-109-90  
15 cm/ 6"

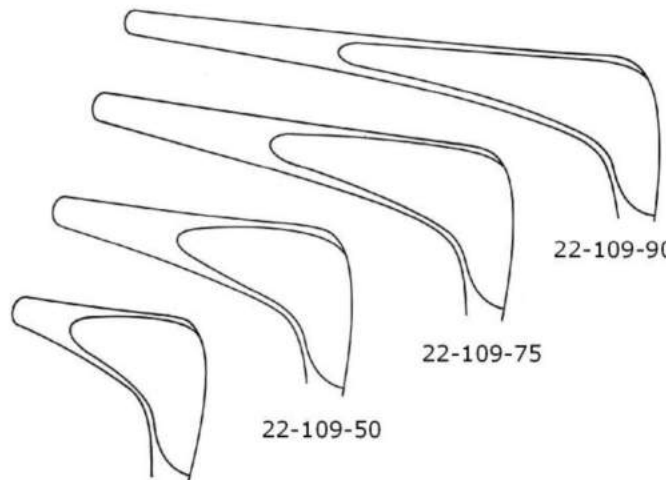

22-109-35

22-109-50

22-109-75

22-109-90

Rhinology, Rhinologie  
Polypenschnürer  
Nasal Snares

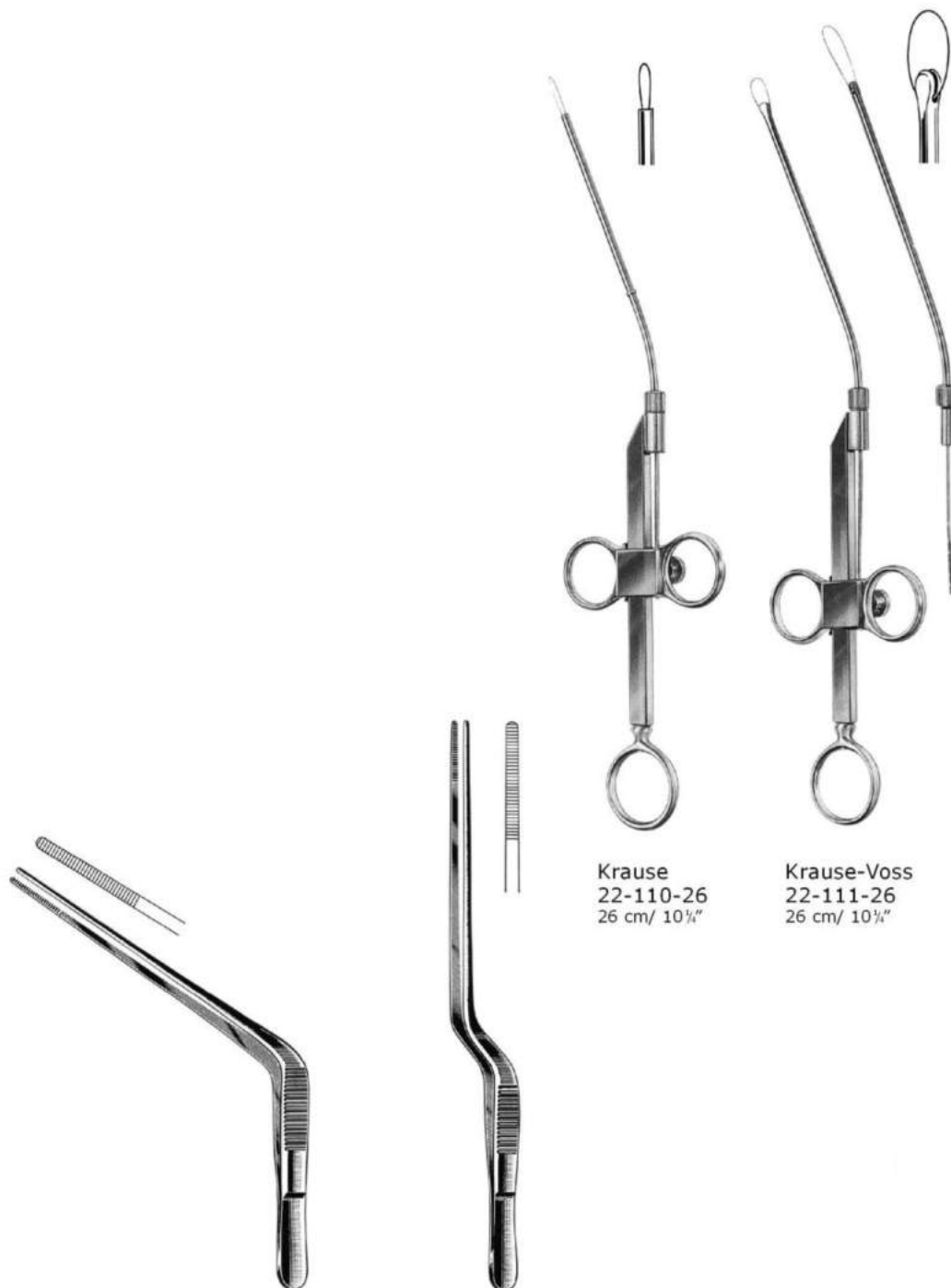

Troeltsch  
22-112-15 15 cm/ 6"  
22-112-18 18 cm/ 7"

Gruenwald(Jansen)  
22-113-20 20 cm/ 8"

Krause  
22-110-26 26 cm/ 10 1/4"

Krause-Voss  
22-111-26 26 cm/ 10 1/4"



Rhinology, Rhinologie  
zangen, Polypenzangen  
Tampon Forceps, Nasal Polypus Forceps

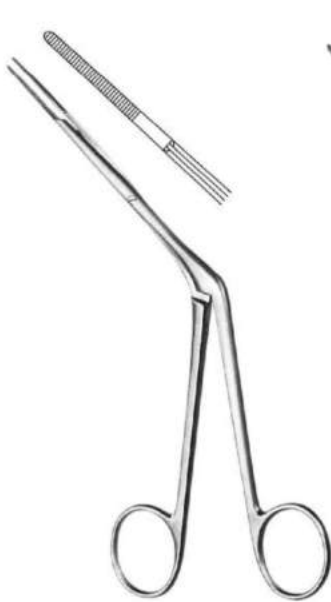

Westmacott  
22-114-20  
20 cm/ 8"



Lubet-Barbon  
22-115-20  
20 cm/ 8"



Hartmann  
22-116-16  
16 cm/ 6 1/2"



Heymann-Knight  
22-117-18  
18 cm/ 7"

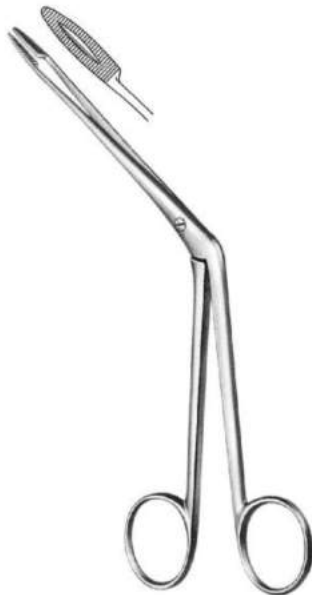

Hartmann  
22-118-20  
20 cm/ 8"



Littauer  
22-119-18  
18 cm/ 7"



Killian  
22-120-17  
17 cm/ 6 3/4"





Rhinology, Rhinologie  
 Polypenzangen, Septumzangen  
 Nasal Polypus and Septum Compression Forceps

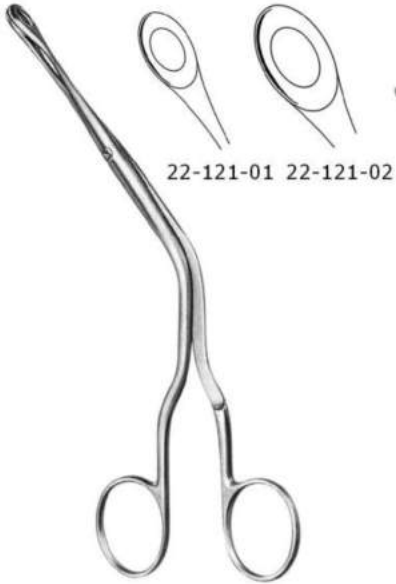

Luc  
 22-121-01 - 22-121-02  
 20 cm/ 8"

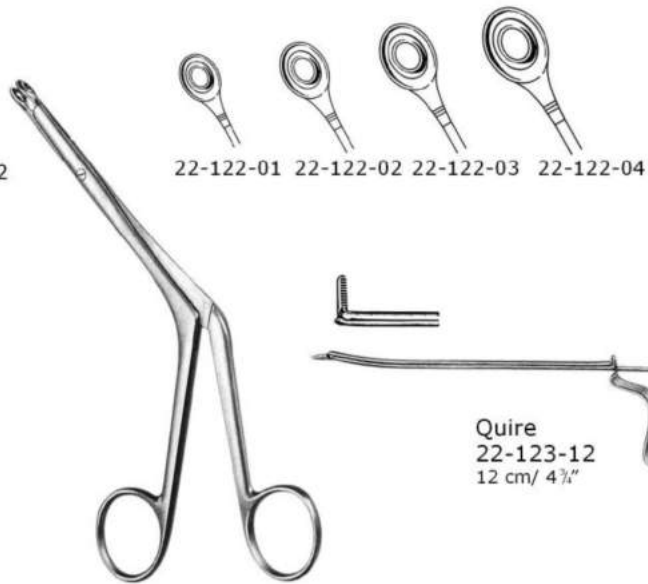

Bruenings  
 22-122-01 - 22-122-04  
 19 cm/ 7½"

Quire  
 22-123-12  
 12 cm/ 4¾"

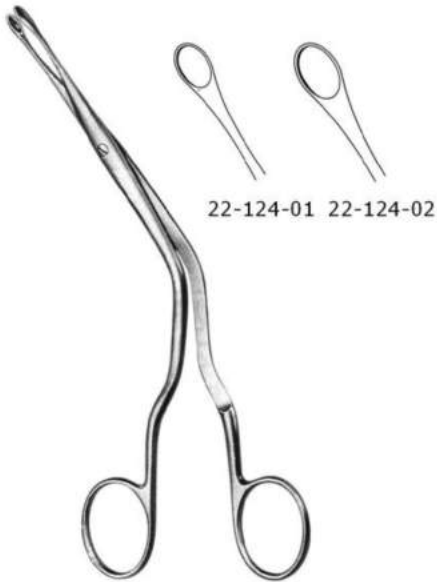

Luc  
 22-124-01 - 22-124-02  
 20 cm/ 8"

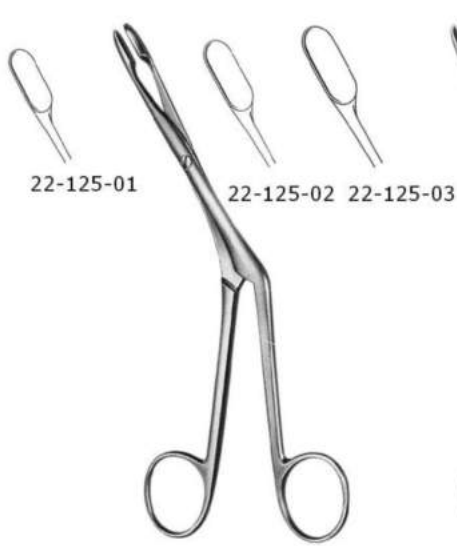

Heymann  
 22-125-01 - 22-125-03  
 18 cm/ 7"



Knight  
 22-126-18  
 18 cm/ 7"



Rhinology, Rhinologie  
Scharfe Nasenzangen  
Nasal Cutting Forceps



22-127-12

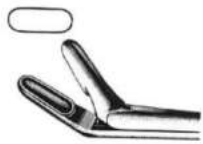

22-128-12



Takahashi  
22-127-12 - 22-128-12  
19 cm/ 7½"



22-129-01



22-129-02



22-129-03



22-129-04



22-129-05



Weil-Blakesley  
22-129-01 - 22-129-05  
19 cm/ 7½"



Rhinology, Rhinologie  
Scharfe Nasenzangen  
Nasal Cutting Forceps



**Struycken**  
22-130-01 - 22-130-02  
19 cm/ 7½"

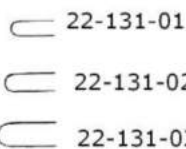

**Myles**  
22-131-01 - 22-131-03  
19 cm/ 7½"



**Hajek**  
22-132-12  
19 cm/ 7½"

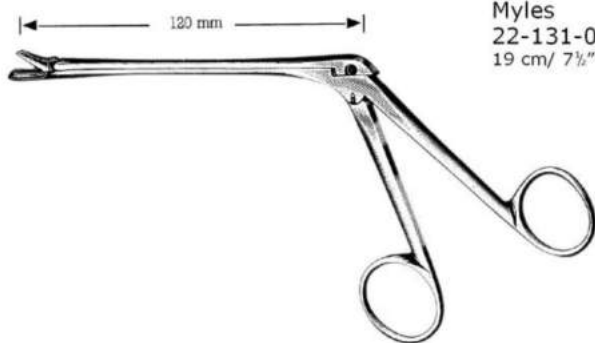

**Hartmann**  
22-133-01 - 22-133-04  
19 cm/ 7½"

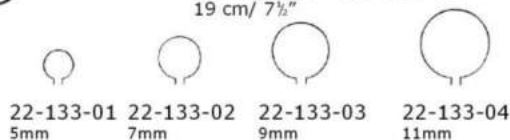



Rhinology, Rhinologie  
Septumscheren Und Septumzangen  
Septum Scissors and Septum Forceps



Middleton-Jansen  
22-136-19  
19 cm/ 7½"



Caplan  
22-134-20  
20 cm/ 8"



Rubin  
22-137-21  
21 cm/ 8½"

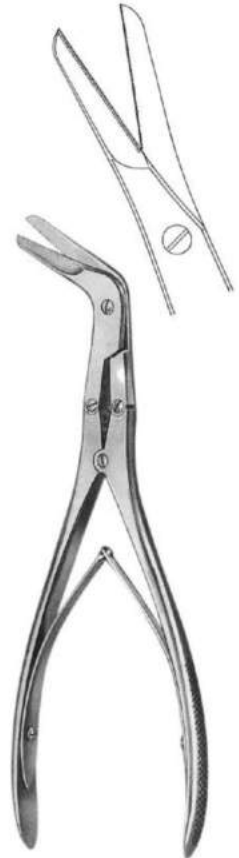

Killian  
22-135-21  
21 cm/ 8½"





Rhinology, Rhinologie  
 Keilbeinstanzen, Kieferhöhlenstanzen  
 Sphenoid Punches, Antrum Punch Forceps

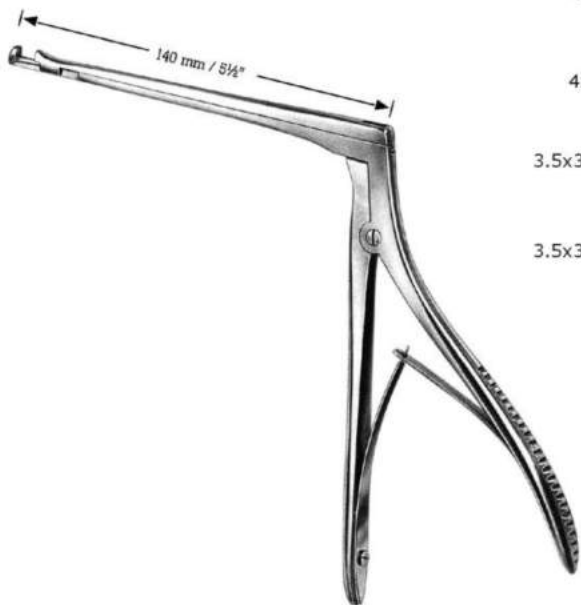

22-138-14 - 22-141-14

4x4mm  Hajek  
 22-138-14

4x4mm  Hajek  
 22-139-14

3.5x3.5mm  Hajek-Kofler  
 22-140-14

3.5x3.5mm  Hajek-Kofler  
 22-141-14



Kerrison  
 22-142-00 - 22-142-03  
 20 cm/ 8"

3x3mm  22-142-00  
 3mm

4x4mm  22-142-01  
 4mm

5x5mm  22-142-02  
 5mm

6x6mm  22-142-03  
 6mm

Rhinology, Rhinologie  
Keilbeinstanzen, Meißelzangen  
Sphenoid Punches and Rongeur Forceps

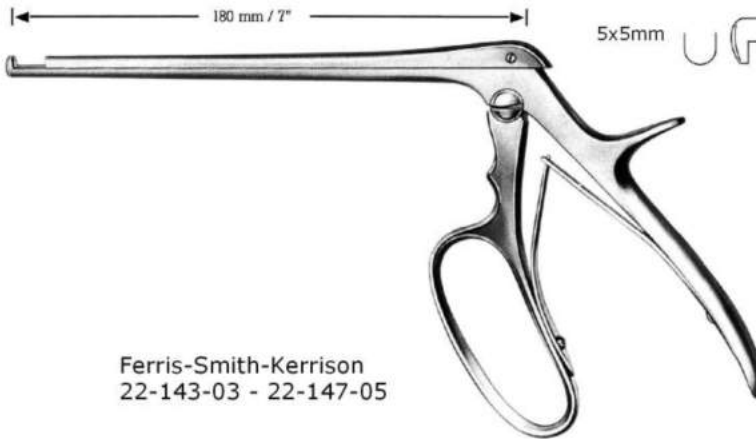
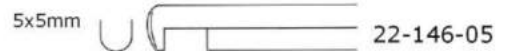
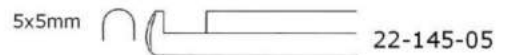
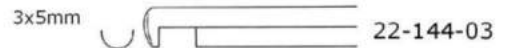
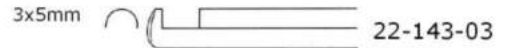
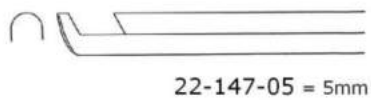
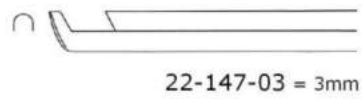

Ferris-Smith-Kerrison  
22-143-03 - 22-147-05

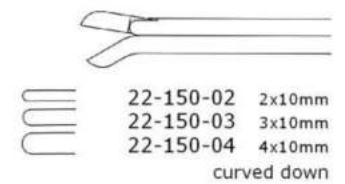
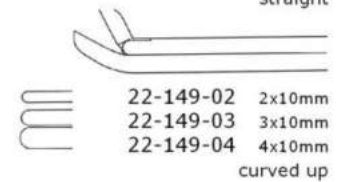
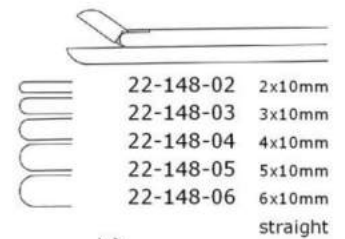
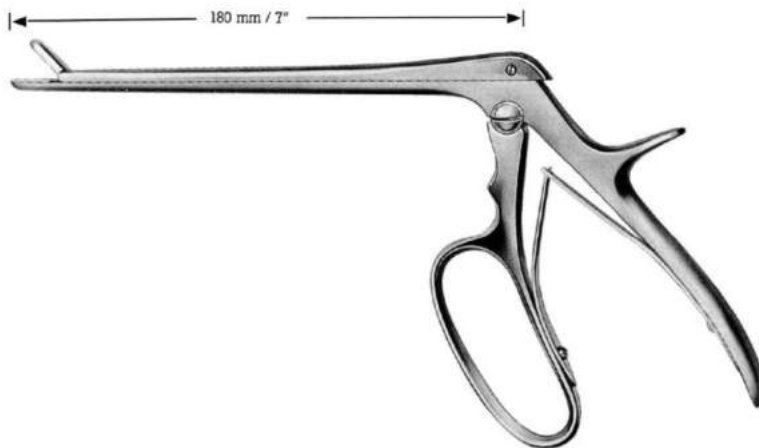

Ferris-Smith-Cushing  
22-148-02 - 22-150-04

Rhinology, Rhinologie  
Septummesser  
Septum Knives

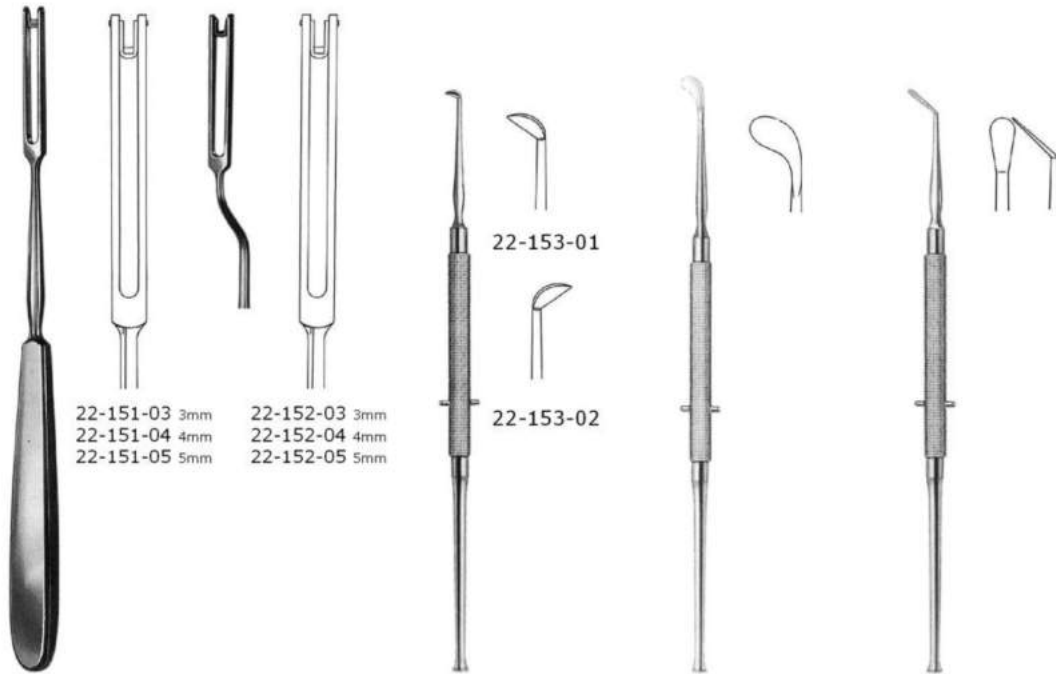

**Ballenger**  
22-151-03 - 22-152-05  
20 cm / 8"

**Freer**  
22-153-01 - 22-153-02  
19 cm / 7 1/2"

**Freer**  
22-154-19  
19 cm / 7 1/2"

**Freer**  
22-155-19  
19 cm / 7 1/2"

**RHINO - PLASTIC**

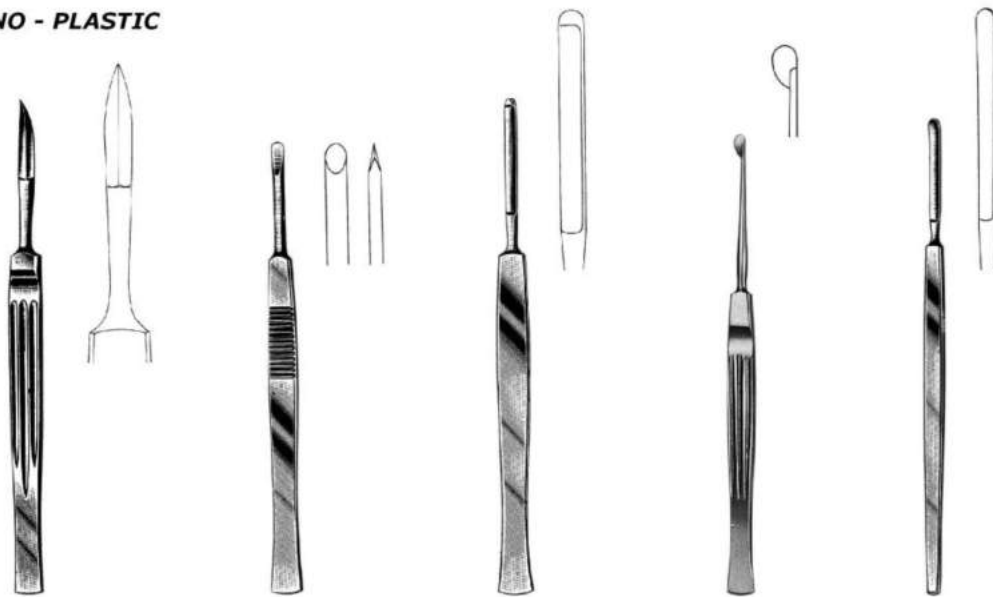

**Joseph**  
22-156-01

**Cottle**  
22-157-15  
15 cm / 6"

**Joseph**  
22-158-15  
15 cm / 6"

**Freer**  
22-159-15  
15 cm / 6"

**Cottle**  
22-160-15  
15 cm / 6"



Rhinology, Rhinologie  
Septum- und Periost-Elevatoren  
Septum and Periosteal Elevators

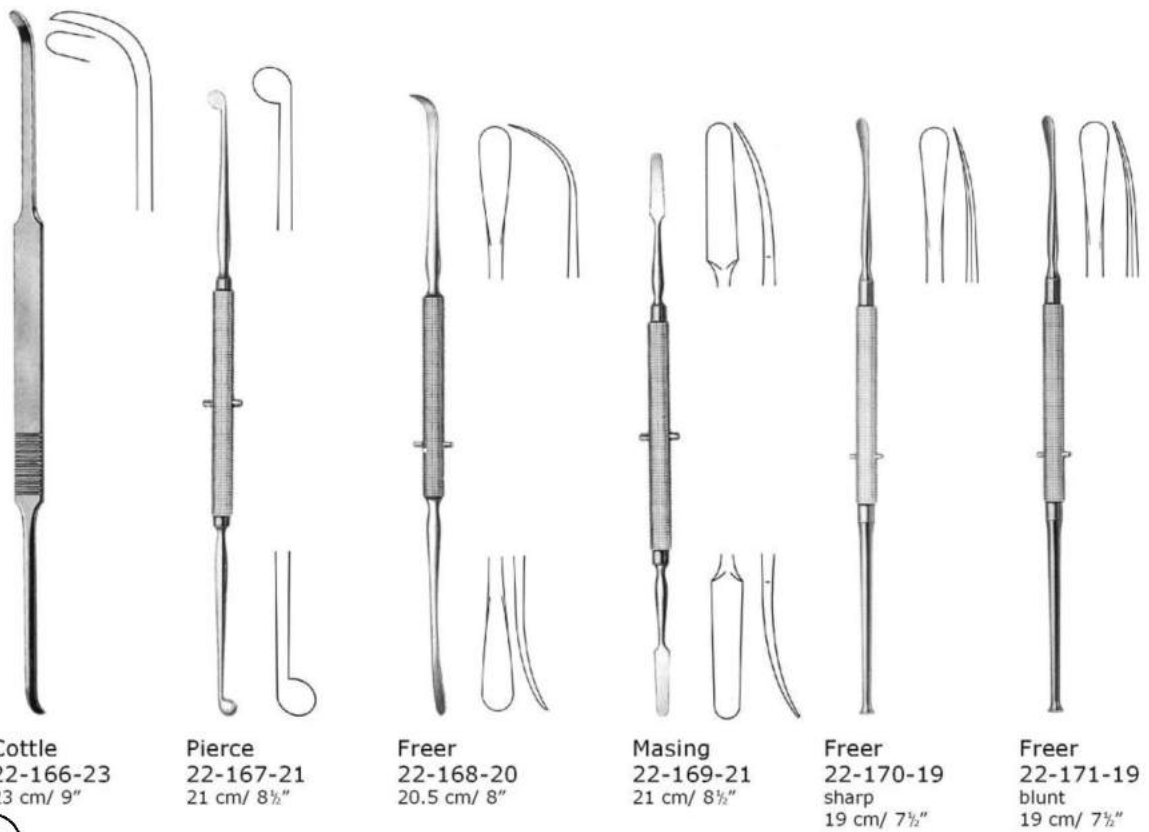
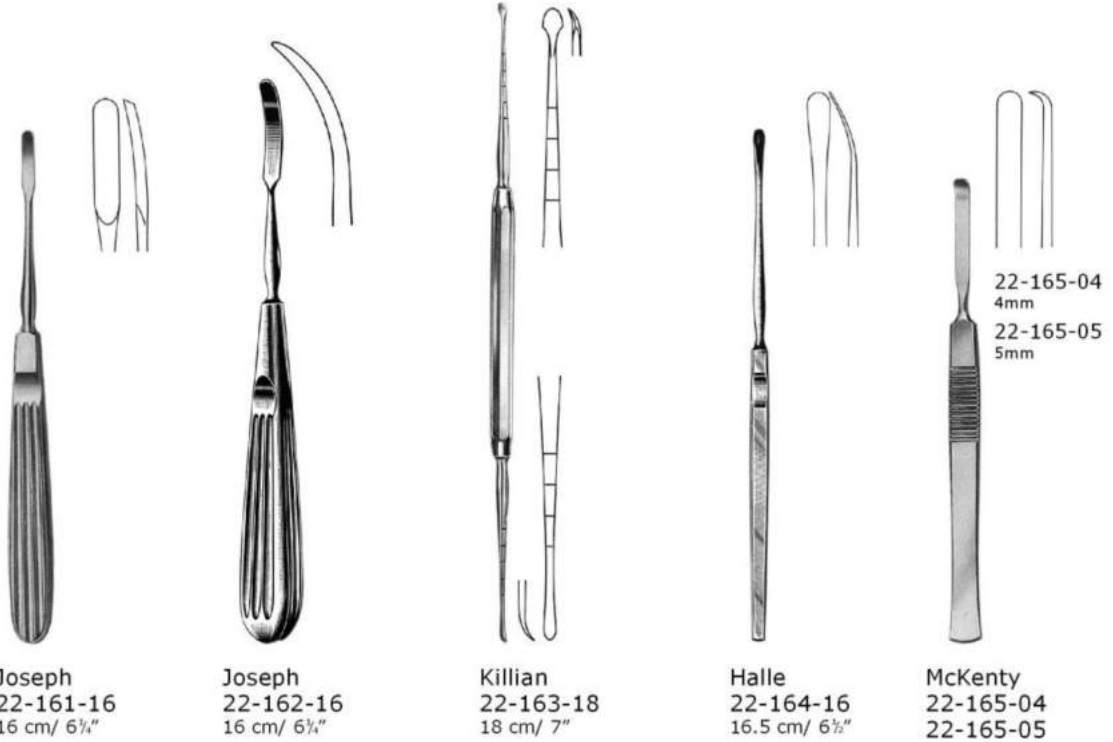

370





Rhinology, Rhinologie  
Instrumente zur Nasenplastik usw.  
Rhinoplastic Instruments etc.

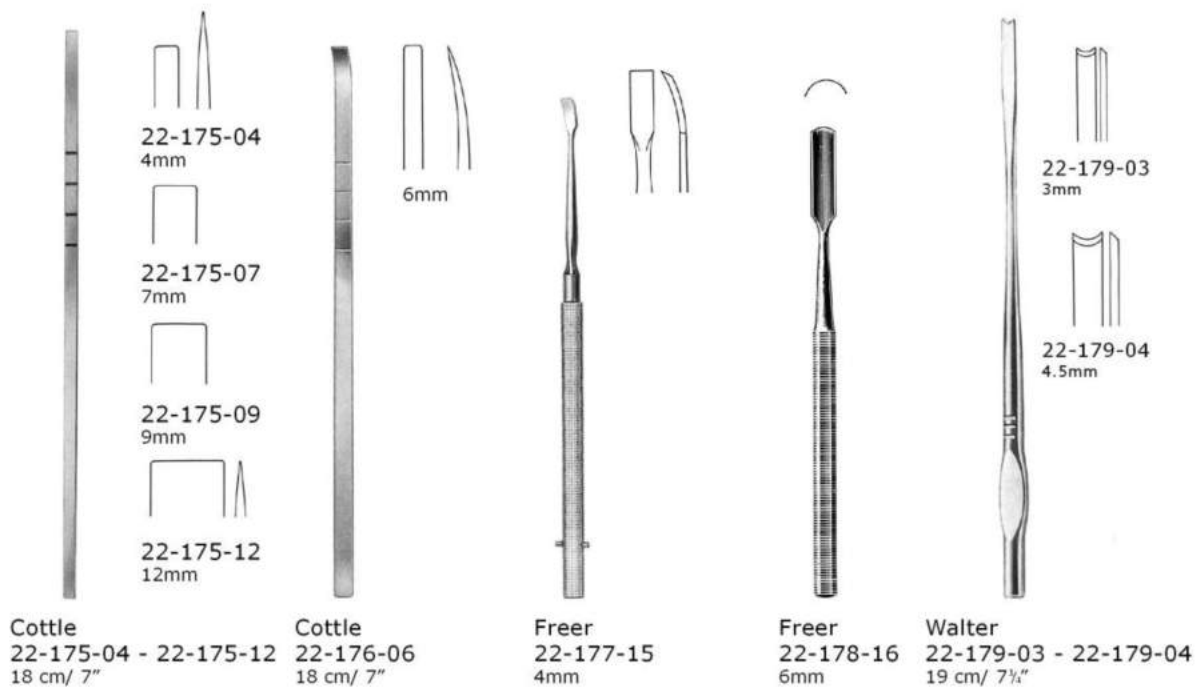
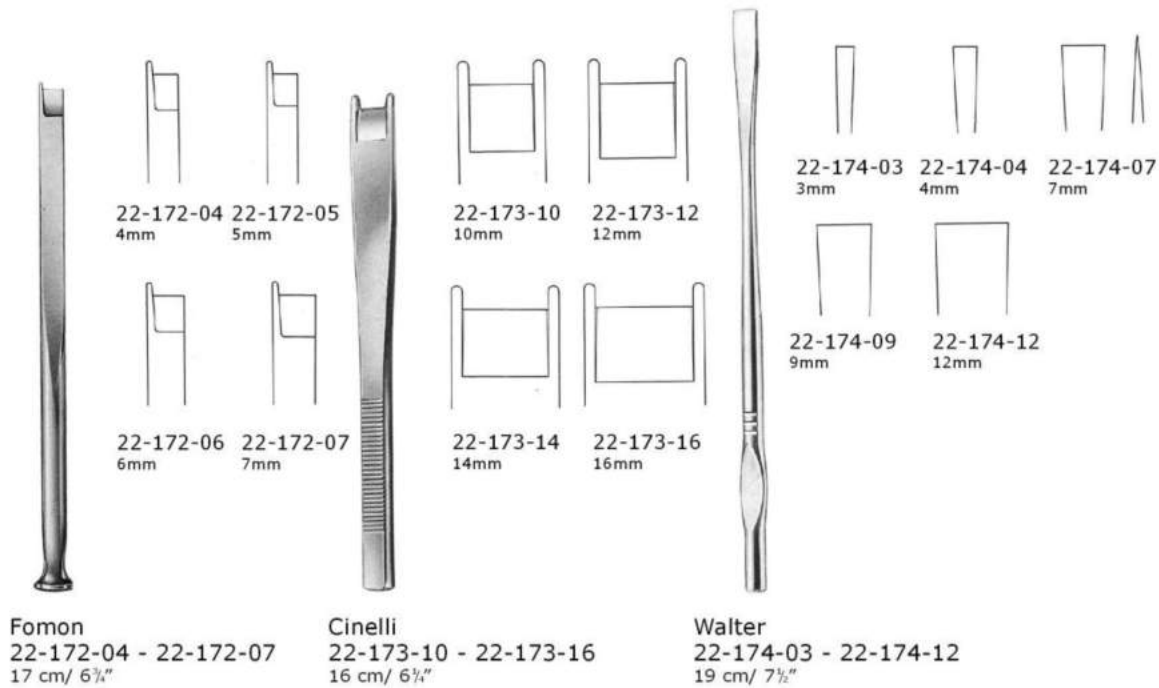



Rhinology, Rhinologie  
 Instrumente zur Nasenplastik usw.  
 Rhinoplastic Instruments etc.

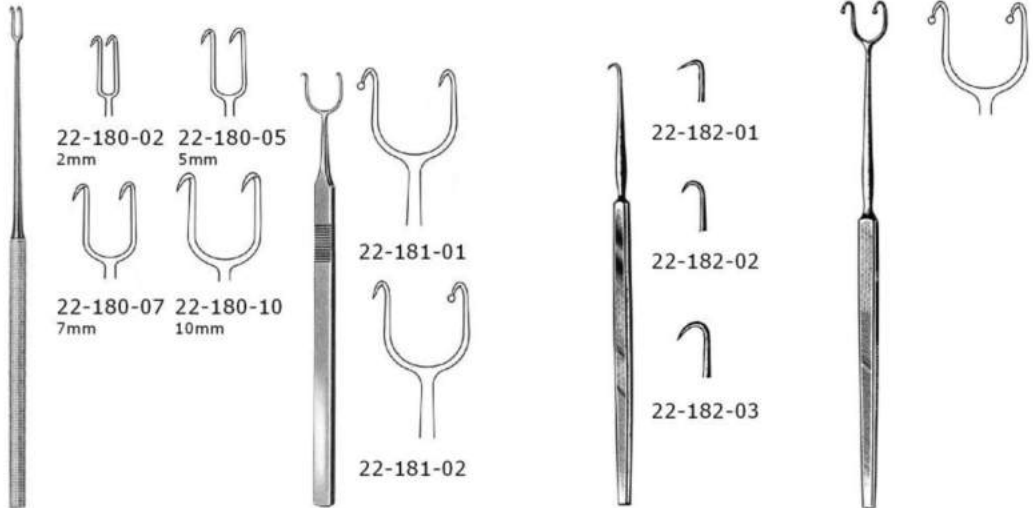

**Joseph**  
 22-180-02 - 22-180-10  
 16 cm/ 6 1/2"

**Cottle**  
 22-181-01 - 22-181-02  
 14 cm/ 5 1/2"

22-182-01 - 22-182-03  
 15 cm/ 6"

**Fomon**  
 22-183-16  
 16 cm/ 6 1/2"



**Fomon**  
 22-184-17  
 17 cm/ 6 3/4"

**Aufrecht**  
 22-185-19  
 19 cm/ 7 1/2"

**Kilner**  
 22-186-10  
 10 cm/ 4"

**Converse**  
 22-187-12  
 12 cm/ 4 1/2"

**Freer**  
 22-188-15  
 15 cm/ 6"



Rhinology, Rhinologie  
 Instrumente zur Nasenplastik usw.  
 Rhinoplastic Instruments etc.

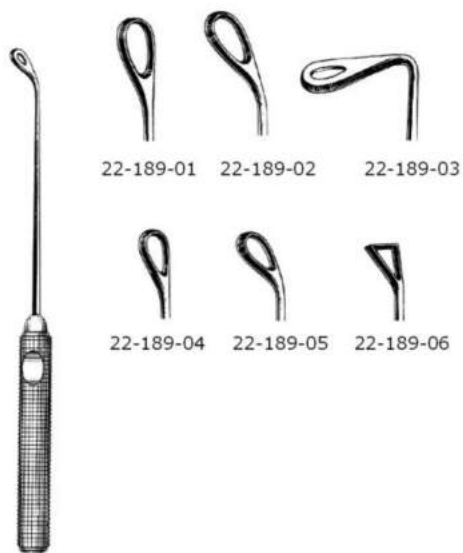

**Coakley**  
 22-189-01 - 22-189-06  
 17 cm/ 6 1/2"



**Ritter-Halle**  
 22-190-25 2.5mmø  
 22-190-30 3.0mmø  
 22-190-40 4.0mmø



**Eicken-Killian**  
 22-191-30  
 3mm  
 14 cm/ 5 1/2"



**Cottle**  
 22-192-14  
 14 cm/ 5 1/2"



**Neivert**  
 22-193-16  
 16 cm/ 6 1/2"



**Cottle**  
 22-194-15  
 15 cm/ 6"



**Cottle**  
 22-195-15  
 15 cm/ 6"



**Aufricht**  
 22-196-13  
 13.5 cm/ 5 1/2"

Rhinology, Rhinologie  
 Instrumente zur Nasenplastik usw.  
 Rhinoplastic Instruments etc.



Joseph  
 22-197-17  
 17 cm/ 6 3/4"

Lewis  
 22-198-18  
 18 cm/ 7"

22-198-18  
 fine

Aufricht  
 22-199-21 - 22-200-21  
 21 cm/ 8 1/4"

22-199-21

22-200-21

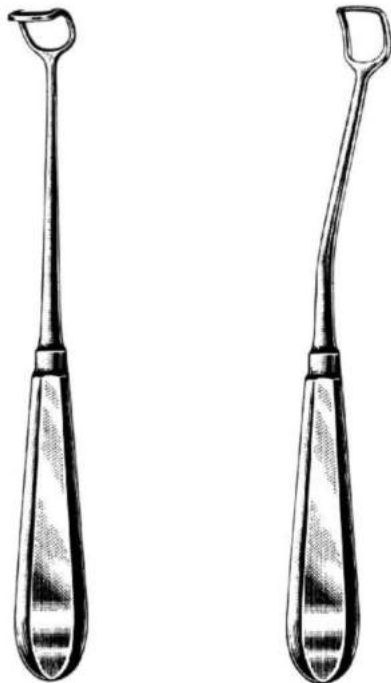

Beckmann  
 22-201-01 - 22-201-06

Beckmann  
 22-202-01 - 22-202-06

22-201-01  
 22-202-01

22-201-02  
 22-202-02

22-201-03  
 22-202-03

22-201-04  
 22-202-04

22-201-05  
 22-202-05

22-201-06  
 22-202-06



Rhinology, Rhinologie  
 Instrumente zur Nasenplastik usw.  
 Rhinoplastic Instruments etc.



Ogura  
 22-203-11  
 11 cm/ 4 1/4"



Cottle  
 22-204-14  
 14 cm/ 5 1/2"



Cottle  
 22-205-10  
 10 cm/ 4"



Kressner  
 22-206-20  
 20 cm/ 8"



Cottle-Walsham  
 22-207-23  
 23 cm/ 9"



Asch  
 22-208-23  
 23 cm/ 9"

## ORAL, MAXILLO PALATE, TONSILS



**Cheek & Lip Retractors, Tongue Depressors**

**Tongue Holding Forceps**

**Mouth Gags**

**Ramus Retractors**

**Periosteal Elevators, Osteotomes**

**Ching & Channelled Retractors**

**Disimpaction Forceps**

**Tonsil Knives, Dissectors, Enucleator, Retractors**

**Tonsil Seizing Forceps**

**Tonsil Snares**

**Tonsillectomes**

**Universal Hands & Interchangeable Tubes**

**Laryngeal Mirrors**

Oral Maxillo-Facial Surgery, Mund-,  
Wangen- und Lippenhalter, Zungendrucker  
Cheek and Lip Retractors, Tongue Depressors



Stemberg  
23-101-12 12 cm/ 4 7/8"  
23-101-14 14 cm/ 5 1/2"  
23-101-16 16 cm/ 6 1/4"



Andrew  
23-102-11  
11 cm/ 4 1/2"



Wieder  
23-103-01 - 23-103-02



23-103-01  
14 cm/ 5 1/2"



23-103-02  
15 cm/ 6"



Hartmann  
23-104-15  
15 cm/ 6"



Tobold  
23-105-14  
14 cm/ 5 1/2"

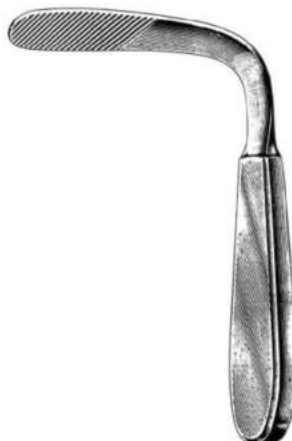

Tobold  
23-106-14  
14 cm/ 5 1/2"



Bruenings  
23-107-19  
19 cm/ 7 1/2"



Mund-, Kiefer- Und Gesichtschirurgie  
Zungenzangen  
Tongue Holding Forceps



Molt  
23-108-11 11 cm/ 4 1/2"  
23-108-14 14 cm/ 5 1/2"



Young  
23-109-17  
17 cm/ 6 1/2"

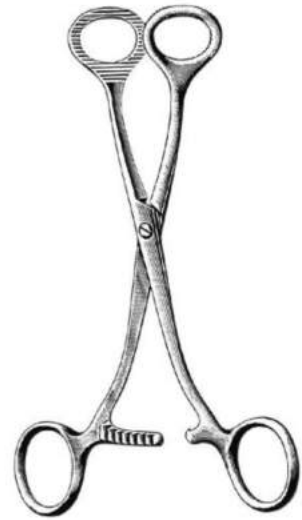

Collin  
23-110-17  
17 cm/ 6 1/2"



Heister  
23-111-13  
13 cm/ 5"



Denhart  
23-112-12  
12 cm/ 4 1/2"

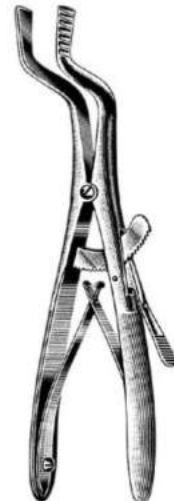

Roser-Konig  
23-113-16 16 cm/ 6 1/2"  
23-113-20 20 cm/ 8"





Oral Maxillo-Facial Surgery, Mund-,  
Mundsperrer  
Mouth Gags

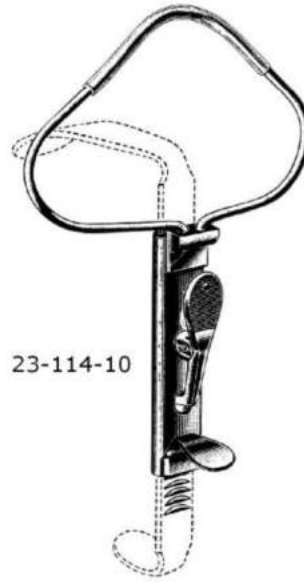

Mclvor  
23-114-00  
Complete Set

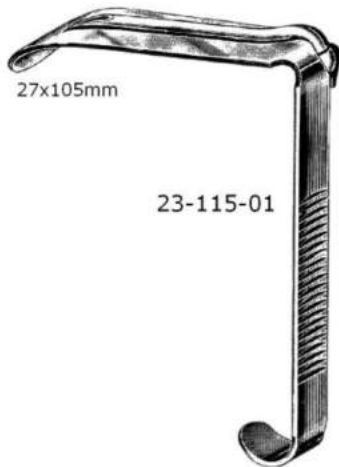

Davis-Boyle  
23-115-00  
Complete Set



Mund-, Kiefer- Und Gesichtschirurgie  
 Mundsperrer  
 Mouth Gags



23-115-20

Dingman  
 23-115-15  
 Complete Set



23-115-21

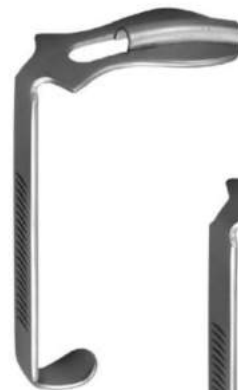

23-115-22



23-115-23



23-116-10

Kilner-Doughty  
 23-116-00  
 Complete Set



23-116-01



23-116-02



23-116-03



Oral Maxillo-Facial Surgery, Mund  
Ramushaken  
Ramus Retractors

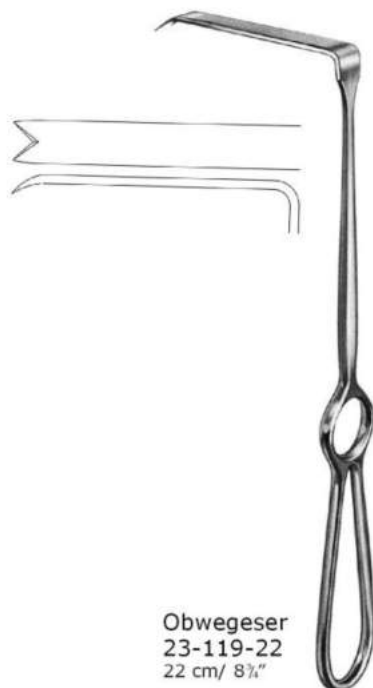
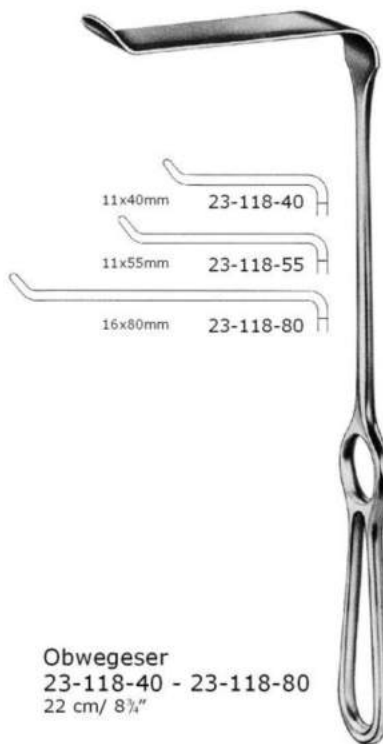
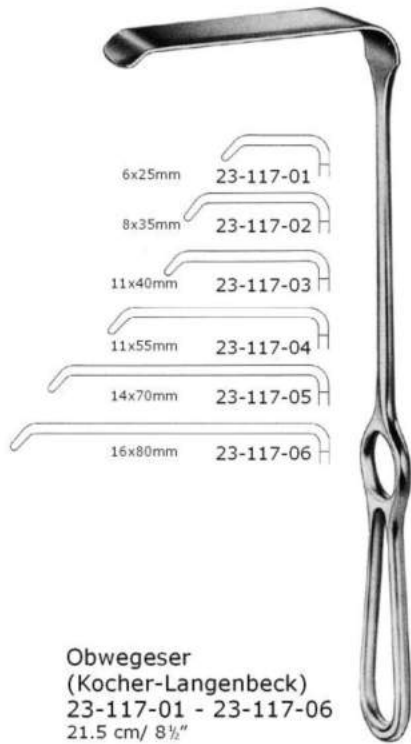

Mund-, Kiefer- Und Gesichtschirurgie  
Raspatorien, Osteotome  
Periosteal Elevators, Osteotomes

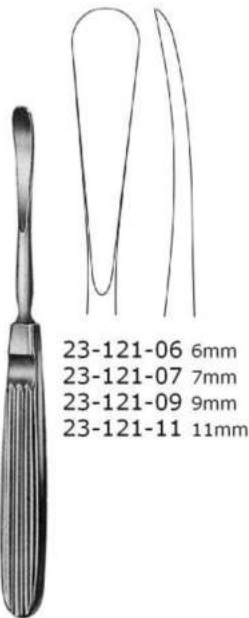

23-121-06 6mm  
23-121-07 7mm  
23-121-09 9mm  
23-121-11 11mm

Obwegeser  
23-121-06 - 23-121-11  
18 cm/ 7"

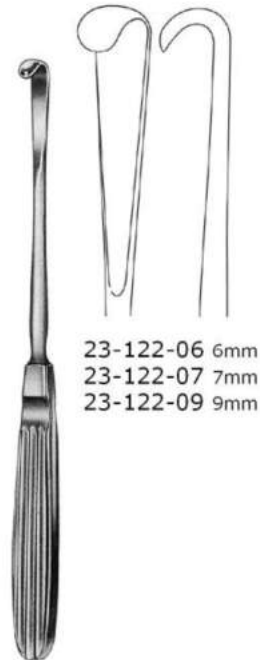

23-122-06 6mm  
23-122-07 7mm  
23-122-09 9mm

Obwegeser  
23-122-06 - 23-122-09  
20 cm/ 8"

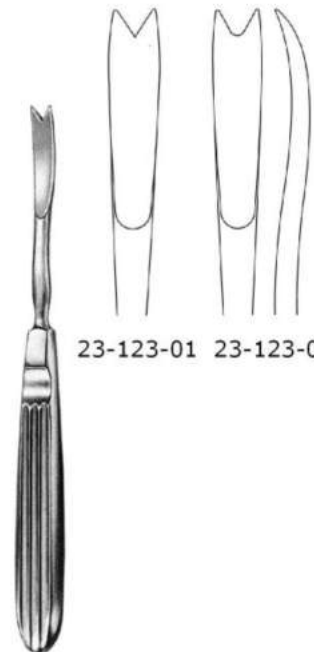

23-123-01 23-123-02

Obwegeser  
23-123-01 - 23-123-02  
18 cm/ 7"

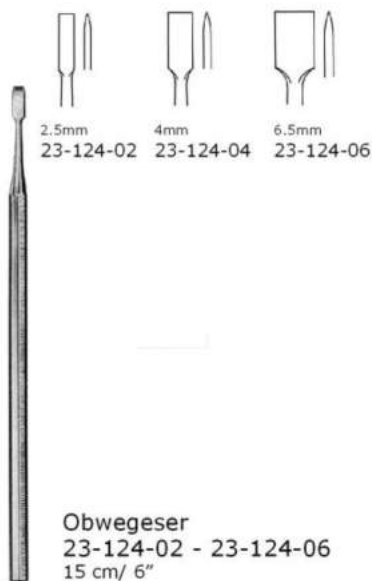

2.5mm 23-124-02  
4mm 23-124-04  
6.5mm 23-124-06

Obwegeser  
23-124-02 - 23-124-06  
15 cm/ 6"

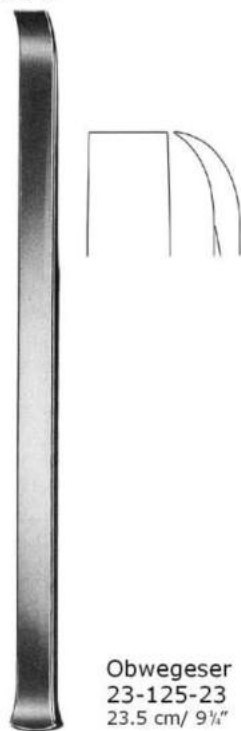

Obwegeser  
23-125-23  
23.5 cm/ 9 1/4"



23-126-19 23-127-19

Obwegeser  
23-126-19 - 23-127-19  
19 cm/ 7 1/2"



Oral Maxillo-Facial Surgery, Mund-  
Kinnhalter und Progeniehaken  
Chin and Channelled Retractors



Obwegeser  
23-128-16  
16.5 cm/ 6½"



Obwegeser  
23-129-08 8mm  
23-129-10 10mm  
16.5 cm/ 6½"



Obwegeser  
23-130-18 18 cm/ 7"  
23-130-28 28 cm/ 11"



Obwegeser  
23-131-13  
13 cm/ 5"



Kelsey-Fry  
23-132-15  
15 cm/ 6"



Kelsey-Fry  
23-132-18  
18 cm/ 7"



Mund-, Kiefer- Und Gesichtschirurgie  
Repositionszangen  
Disimpaction Forceps

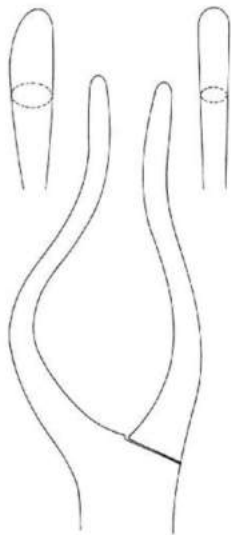

23-133-22  
23-134-22

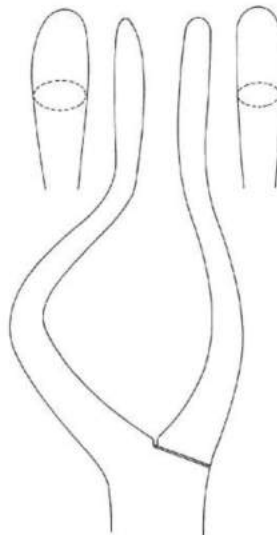

23-133-23  
23-134-23

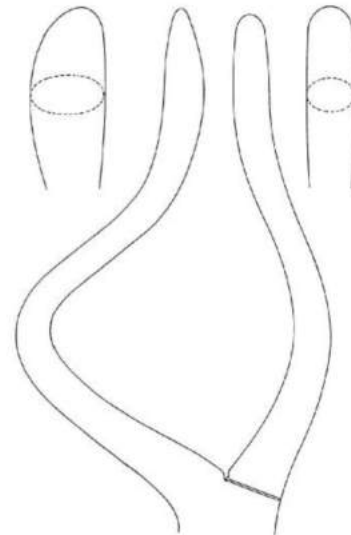

23-133-24  
23-134-24



left

23-133-22 22.5 cm/ 8 7/8"  
23-133-23 23 cm/ 9"  
23-133-24 24 cm/ 9 1/2"



right

23-134-22 22.5 cm/ 8 7/8"  
23-134-23 23 cm/ 9"  
23-134-24 24 cm/ 9 1/2"

Palate, Tonsils - Gaumen, Tonsillen  
Tonsillennmesser, Dissektoren, Eukleator,  
Tonsil Knives, Dissectors, Enucleator, Retractors

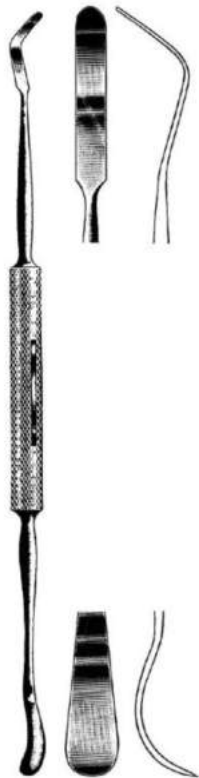

Carpenter  
23-135-25  
25 cm/ 10"



Carpenter  
23-136-24  
24 cm/ 9½"



Hurd  
23-137-22  
22.5 cm/ 9"

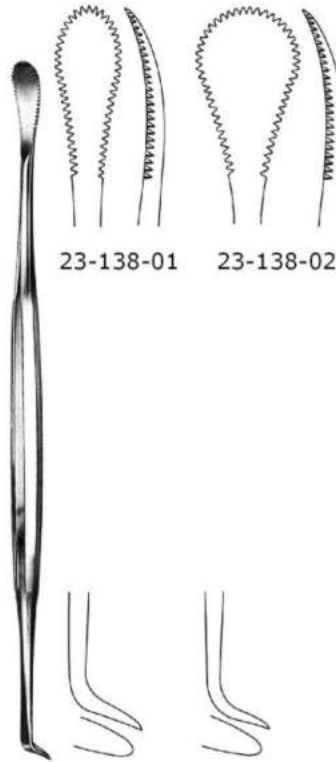

Henke  
23-138-01 - 23-138-02  
23 cm/ 9"

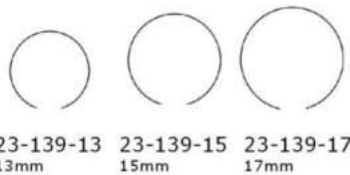

23-139-13 23-139-15 23-139-17  
13mm 15mm 17mm



Hartmann  
23-139-13 - 23-139-17



Palate, Tonsils - Gaumen, Tonsillen  
Tonsillenzangen  
Tonsil Seizing Forceps



23-140-19 23-141-19

Schnitt  
23-140-19 - 23-141-19  
19 cm / 7 1/2"



23-142-19 23-143-19

Schnitt  
23-142-19 - 23-143-19  
19 cm / 7 1/2"

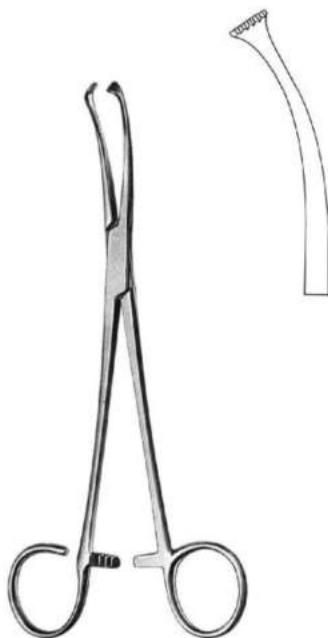

White  
23-144-18 18 cm / 7"

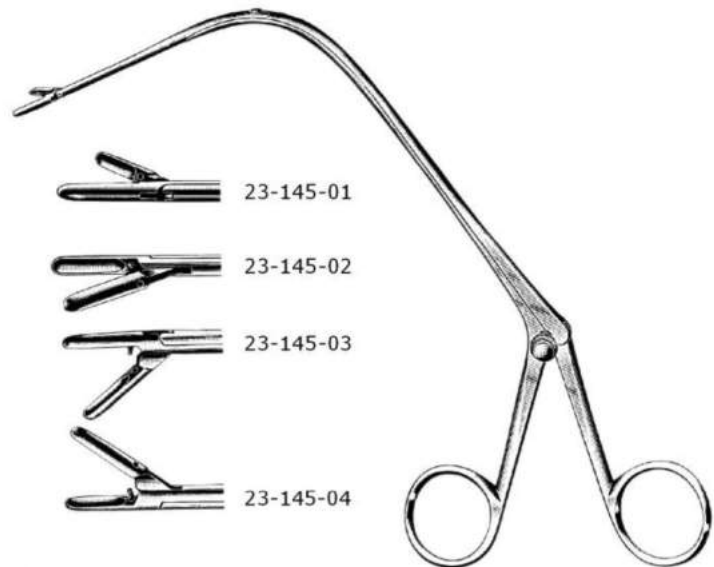

23-145-01  
23-145-02  
23-145-03  
23-145-04

Jurasz  
23-145-01 - 23-145-04  
23 cm / 9"





Palate, Tonsils - Gaumen, Tonsillen  
Tonsillenschnürer  
Tonsil Snares

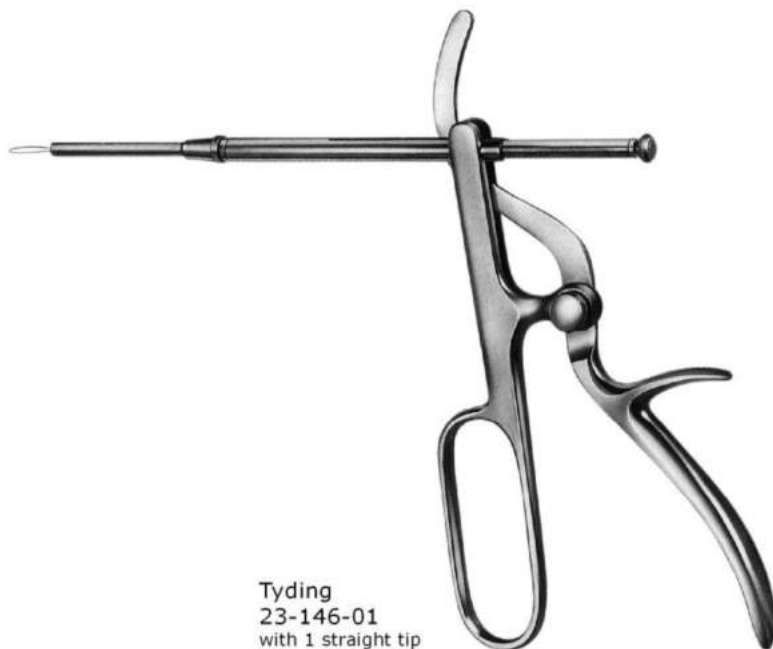

Tyding  
23-146-01  
with 1 straight tip



Eves  
23-147-28  
28 cm/ 11"



Eves  
23-148-28  
28 cm/ 11"



Bruenings  
23-149-28  
28 cm/ 11"

Palate, Tonsils - Gaumen, Tonsillen  
Tonsillotome  
Tonsillectomes

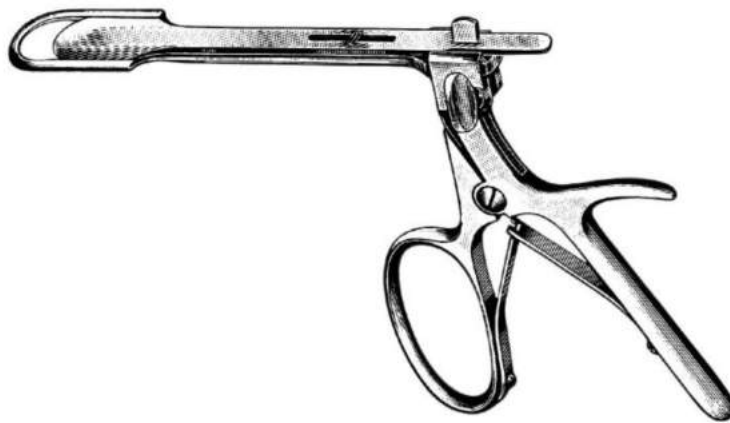
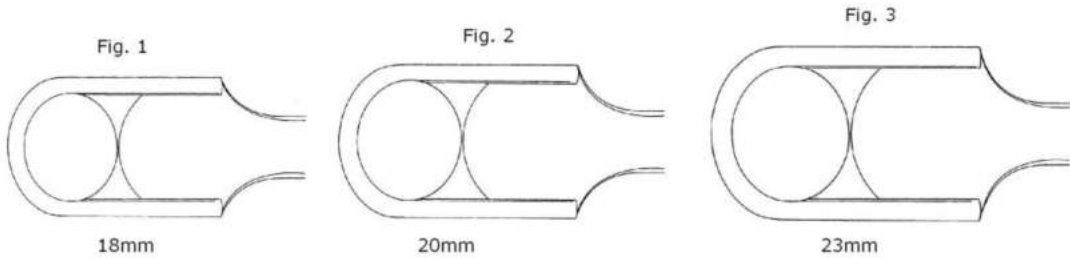

Sluder - Ballenger  
23-150-03  
complete with 3 tips

Biopsy Forceps

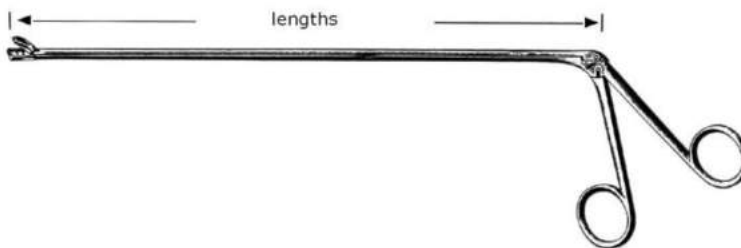

Chevalier-Jackson  
23-151-30 - 23-157-60

lengths								
cm	in.							
30	12	23-151-30	23-152-30	23-153-30	23-154-30	23-155-30	23-156-30	23-157-30
40	16	23-151-40	23-152-40	23-153-40	23-154-40	23-155-40	23-156-40	23-157-40
50	20	23-151-50	23-152-50	23-153-50	23-154-50	23-155-50	23-156-50	23-157-50
60	24	23-151-60	23-152-60	23-153-60	23-154-60	23-155-60	23-156-60	23-157-60

Palate, Tonsils - Gaumen, Tonsillen  
 Universalgriffe und Verlängerungsröhre,  
 Auswechselbare Zangenaufsätze  
 Universal Handles and Interchangeable Tubes,  
 Cutting and Grasping Forcep Tips



Bruenings  
 23-158-20  
 20 cm/ 8"



Huber  
 23-159-01



23-160-20 - 23-160-40

Straight	lengths	in.
23-160-20	20cm	8
23-160-30	30cm	12
23-160-40	40cm	16

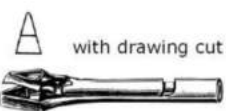

with drawing cut

Schumacher  
 23-161-01



Krause  
 23-162-01



Fraenkel  
 23-163-01



Seiffert  
 23-164-01



Fraenkel  
 23-165-01



Scheinmann  
 23-166-01



Scheinmann  
 23-167-01



Lange  
 23-168-01



Bruenings  
 23-169-02 - 23-169-03



Krause  
 23-170-01 - 23-170-02



Bruenings  
 23-171-02 - 23-171-03

Palate, Tonsils - Gaumen, Tonsillen  
Kehlkopfspiegel  
Laryngeal Mirrors

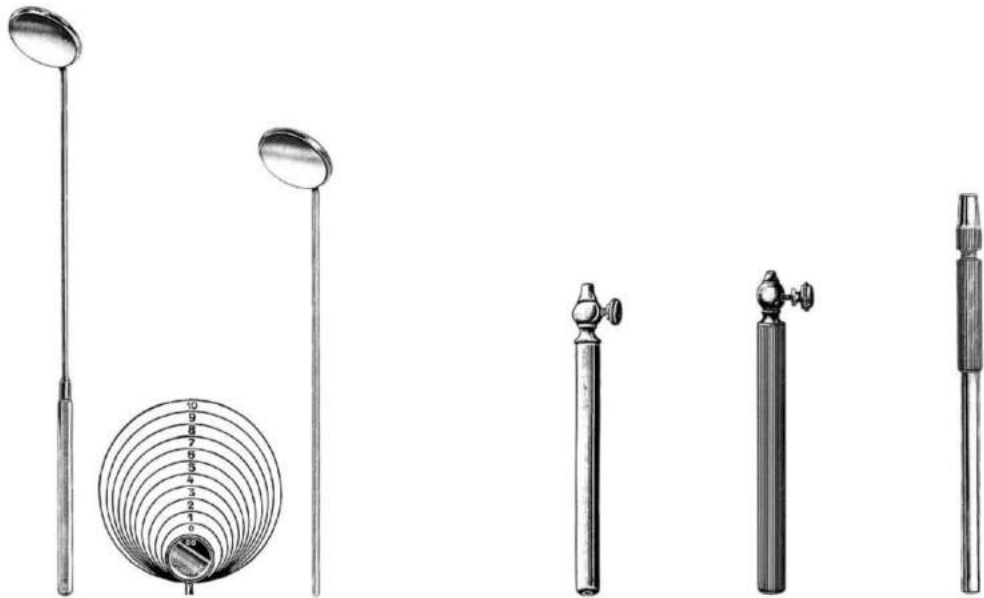

- |           |         |      |           |
|-----------|---------|------|-----------|
| 23-173-08 | Fig. 00 | 8mm  | 23-174-08 |
| 23-173-10 | Fig. 0  | 10mm | 23-174-10 |
| 23-173-12 | Fig. 1  | 12mm | 23-174-12 |
| 23-173-14 | Fig. 2  | 14mm | 23-174-14 |
| 23-173-16 | Fig. 3  | 16mm | 23-174-16 |
| 23-173-18 | Fig. 4  | 18mm | 23-174-18 |
| 23-173-20 | Fig. 5  | 20mm | 23-174-20 |
| 23-173-22 | Fig. 6  | 22mm | 23-174-22 |
| 23-173-24 | Fig. 7  | 24mm | 23-174-24 |
| 23-173-26 | Fig. 8  | 26mm | 23-174-26 |
| 23-173-28 | Fig. 9  | 28mm | 23-174-28 |
| 23-173-30 | Fig. 10 | 30mm | 23-174-30 |

23-175-10

23-176-11

23-177-12



## OPHTHALMOLOGY



Eye Specula

Hooks, Spatula

Eys Scalpels, Cataract Knives

Hooks, Hooklets

Lens Expressor, Eys Spoons

Chalazion Hooklets, Cannunas

Lacrimal Dilators, Probes

Double Ended Instruments

Iris Forceps

Capsular Forceps

Fixation Forceps, Tissue Forceps

Suture Forceps

Chalazion Forceps

Iris Scissors, Corneal Scissors

Eye Needle Holders

Ophthalmology - Ophthalmologie  
Lid Sperrer  
Eye Specula



**Baraquer**  
24-101-03 3cm/ 1¼"  
24-101-04 4cm/ 1½"



**Bowman**  
24-102-07  
7 cm/ 2¾"



**Graefe**  
24-103-06  
6 cm/ 2½"



**Knapp-Clark**  
24-104-08  
8 cm/ 3¼"



**Weiss**  
24-105-08  
8 cm/ 3¼"



**Williams**  
24-106-08  
8 cm/ 3¼"



**Arruga**  
24-107-07  
7 cm/ 2¾"



**Arruga**  
24-108-07  
7 cm/ 2¾"



**Mellinger**  
24-109-07  
7 cm/ 2¾"



**Park**  
24-110-08  
8 cm/ 3¼"



**Mueller**  
24-111-07  
7 cm/ 2¾"



**Lancaster**  
24-112-07  
7 cm/ 2¾"

Ophthalmology - Ophthalmologie  
 Haken, Spatel  
 Hooks, Spatula

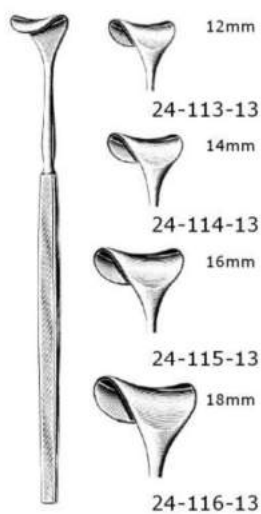

Desmarres  
 24-113-13 - 24-116-13  
 13cm/ 5"

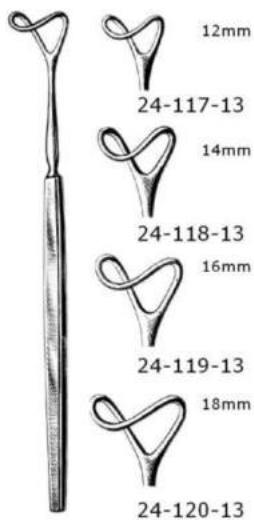

Desmarres  
 24-117-13 - 24-120-13  
 13cm/ 5"



Schepens  
 24-121-13  
 13 cm/ 5"



Scobee  
 24-122-13  
 13 cm/ 5"



Muldoon  
 24-123-08  
 8 cm/ 3 1/4"



Berens  
 24-124-09  
 9 cm/ 3 1/2"



Siniscal-Smith  
 24-125-11  
 11.5 cm/ 4 1/2"



Berens  
 24-126-13  
 13 cm/ 5"



Ophthalmology - Ophthalmologie  
Augenscalpelle, Starmesser  
Eye Scalpels, Cataract Knives

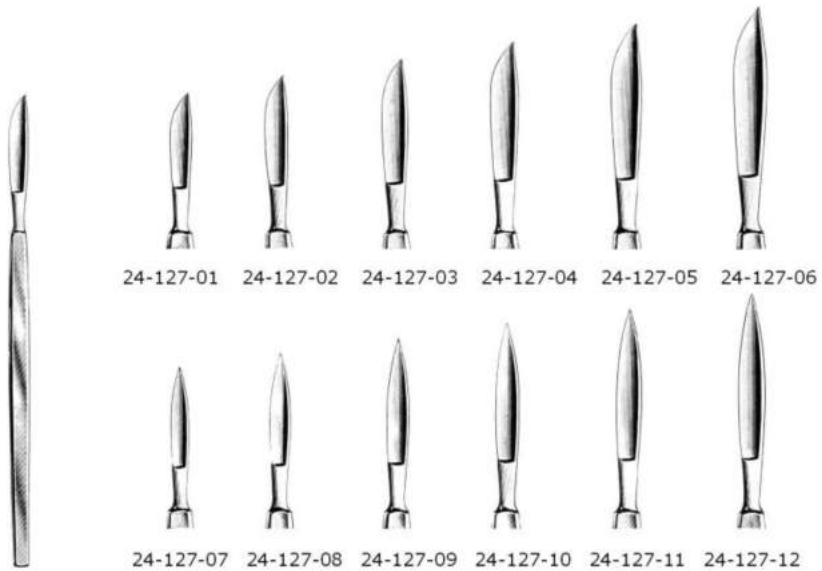

24-127-01 - 24-127-12

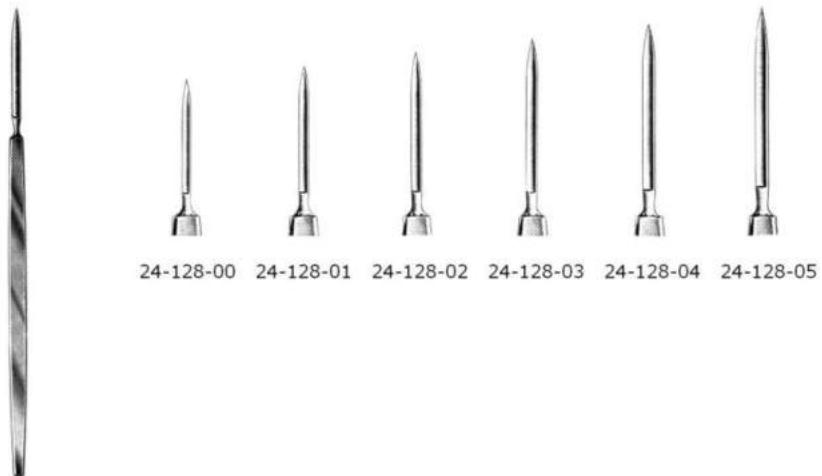

24-128-00 - 24-128-05





Ophthalmology - Ophthalmologie  
 Haken, Späkchen  
 Hooks, Hooklets



24-129-13



Graefe  
 24-130-12  
 Sharp



Graefe  
 24-131-12  
 Blunt



Panas  
 24-132-12



Panas  
 24-133-13



Knapp  
 24-134-13



Guthrie  
 24-135-12



Guthrie  
 24-136-13



Stevens  
 24-137-12



Jameson  
 24-138-13



Culler  
 24-139-12



Wiener  
 24-140-12



Graefe  
 24-140-13



Graefe  
 24-141-13



Graefe  
 24-141-14



Graefe  
 24-141-15



Jaeger  
 24-142-01



Jaeger  
 24-142-02



Arruga  
 24-143-13



Kronfeld  
 24-144-10



Kronfeld  
 24-144-15



Ophthalmology - Ophthalmologie  
 Linsen, Augenlöffel  
 Lens Expressor, Eye Spoons



24-145-13 24-146-14  
 Weber

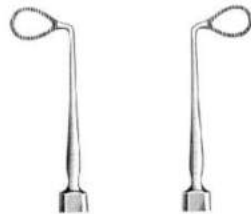

24-147-13 24-148-13  
 Elschnig

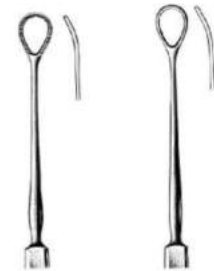

24-149-14 24-150-14  
 Lewis



24-151-01 24-151-02  
 Graefe



24-152-13 24-153-14  
 Castroviejo  
 10mm 15mm



24-154-01 24-154-02  
 Elschnig



Wells  
 24-155-00





Ophthalmology - Ophthalmologie  
Tränenkanal-Dilatatoren  
Lacrimal Dilators, Probes



Ziegler

Fig.

1/2	24-163-01
3/4	24-163-02
5/6	24-163-03



Castroviejo  
24-164-12



Wilder  
24-165-01



Wilder  
24-165-02



Wilder  
24-165-03

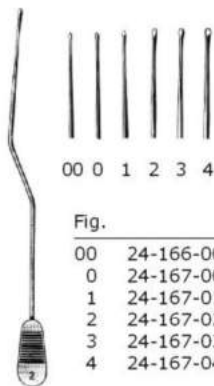

00 0 1 2 3 4

Fig.

00	24-166-00
0	24-167-00
1	24-167-01
2	24-167-02
3	24-167-03
4	24-167-04

Bowman

Fig.

0/0	24-168-00
1/1	24-168-11
2/2	24-168-22
3/3	24-168-33
4/4	24-168-44
5/5	24-168-55
6/6	24-168-66
7/7	24-168-77
8/8	24-168-88



Bowman

Fig.

00/0	24-169-00
0/1	24-169-01
1/2	24-169-12
2/3	24-169-23
3/4	24-169-34
4/5	24-169-45
5/6	24-169-56
6/7	24-169-67
7/8	24-169-78



French pattern

Fig.	00	0	1	2	3	4	5	6	7	8
mm	0.7	0.8	0.9	1.1	1.3	1.4	1.5	1.6	1.8	1.9



Ophthalmology - Ophthalmologie  
Doppelinstrumente  
Double Ended Instruments



Castroviejo  
24-170-12



Green  
24-171-12



McReynolds  
24-172-12



Wheeler  
24-173-12



Knapp  
24-174-12



Fisher  
24-175-13



24-176-12



Meyhoefer  
24-177-13



24-178-14



McNaman  
24-179-14

Ophthalmology - Ophthalmologie  
Irispinzetten  
Iris Forceps



Fischer  
24-180-07  
7 cm/ 2¾"



Fischer-Arlt  
24-181-07  
7 cm/ 2¾"



Hess  
24-182-07  
7 cm/ 2¾"



Hess  
24-183-07  
7 cm/ 2¾"



Gill-Hess  
24-184-07  
7.5 cm/ 3"



Foerster  
24-186-08  
8.5 cm/ 3½"



Foerster  
24-187-08  
8.5 cm/ 3½"



Bishop-Harman  
24-188-08  
8.5 cm/ 3½"  
Fine



Bishop-Harman  
24-189-08  
8.5 cm/ 3½"  
Fine



Fuchs  
24-191-07  
7 cm/ 2¾"

Ophthalmology - Ophthalmologie  
 Irispinzetten  
 Iris Forceps



24-192-01 24-193-01 24-194-01



24-192-02 24-193-02 24-194-02

**Graefe**  
 24-192-01 - 24-194-02  
 11 cm/ 4 1/4"



24-195-10 24-196-10 24-197-10



24-198-10 24-199-10 24-200-10

**Stevens**  
 24-195-10 - 24-200-10  
 10 cm/ 4 1/4"



**Graefe**  
 24-201-07  
 7 cm/ 2 3/4"



**Graefe**  
 24-202-07  
 7 cm/ 2 3/4"



**Graefe**  
 24-203-07  
 7 cm/ 2 3/4"



**Graefe**  
 24-204-07  
 7 cm/ 2 3/4"



**Hess**  
 24-205-09  
 9 cm/ 3 1/2"



**Hess**  
 24-206-09  
 9 cm/ 3 1/2"

Ophthalmology - Ophthalmologie  
Kaoselpinzetten  
Capsular Forceps



Arruga-Nizetic  
24-207-10  
10 cm/ 4"



Castroviejo  
24-208-10  
10 cm/ 4"



Castroviejo  
24-209-10  
10 cm/ 4"



Gill-Arruga  
24-210-07  
7.5 cm/ 3"



Elschnig  
24-211-10  
10 cm/ 4"



Safar  
24-212-07  
7 cm/ 2 7/8"



Hess  
24-213-06  
6 cm/ 2 1/2"



Hess  
24-214-06  
6.5 cm/ 2 1/2"



Fuchs  
24-215-07  
7 cm/ 2 7/8"



Elschnig  
24-216-10  
10 cm/ 4"



Arruga  
24-217-09  
9.5 cm/ 3 7/8"



Arruga  
24-218-09  
9.5 cm/ 3 7/8"



Ophthalmology - Ophthalmologie  
 Finierpinzetten, Fasspinzetten  
 Fixation Forceps, Tissue Forceps



Graefe  
 24-219-11  
 11 cm/ 4½"



Graefe  
 24-220-11  
 11 cm/ 4½"



Schmidt-Rimpler  
 24-221-11  
 11 cm/ 4½"



24-222-11  
 11 cm/ 4½"  
 2:3



24-223-11  
 11 cm/ 4½"  
 3:4



Guist  
 24-224-10  
 10.5 cm/ 4¼"



Castroviejo  
 24-225-09  
 9 cm/ 3½"



Castroviejo  
 24-226-09  
 9 cm/ 3½"



Castroviejo  
 24-227-09  
 9 cm/ 3½"



Castroviejo  
 24-228-09  
 9 cm/ 3½"



Lester  
 24-229-12 1:2  
 24-229-23 2:3  
 9 cm/ 3½"

Ophthalmology - Ophthalmologie  
 Nahtpinzetten  
 Suture Forceps



Castroviejo  
 24-230-10  
 10 cm/ 4"



Castroviejo  
 24-231-10  
 10 cm/ 4"



Dastoor  
 24-232-10  
 10 cm/ 4"



Moorfield  
 24-233-10  
 10 cm/ 4"



Kronfeld  
 24-234-08  
 8 cm/ 3 1/4"



Colibri (Barraquer)  
 24-235-07  
 7 cm/ 2 7/8"



Girard  
 24-236-10  
 10 cm/ 4"



Girard  
 24-237-10  
 10 cm/ 4"



Castroviejo  
 24-238-09  
 9 cm/ 3 1/2"



24-239-07  
 7 cm/ 2 3/4"



Barraquer  
 24-240-05  
 5 cm/ 2"

Ophthalmology - Ophthalmologie  
Chalazionspinzetten  
Chalazion Forceps



Ayer  
24-241-09  
9 cm/ 3½"



Ayer  
24-242-09  
9 cm/ 3½"



Hunt  
24-243-09  
9 cm/ 3½"



Lambert  
24-244-09  
9 cm/ 3½"



Cauer  
24-245-10  
10 cm/ 4"



Lordan  
24-246-09  
9 cm/ 3½"



Desmarres  
24-247-09 - 24-249-09  
9 cm/ 3½"



24-247-09



24-248-09



24-249-09

Ophthalmology - Ophthalmologie  
 Nahtpinzetten, Entropiumpinzetten  
 Suture Forceps, Entropium Forceps



Bonaccolto  
 24-250-10  
 10 cm/ 4"

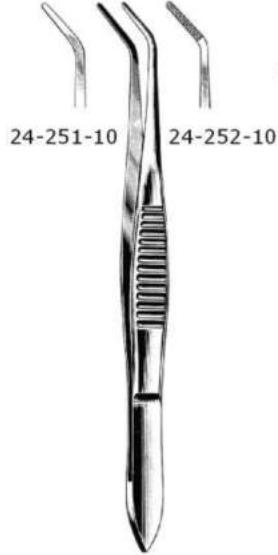

Nugent  
 24-251-10 - 24-252-10  
 10 cm/ 4"



Reese  
 24-253-10  
 10 cm/ 4"



Blascovics  
 24-254-09  
 9 cm/ 3½"



Blascovics  
 24-255-09  
 9 cm/ 3½"



24-256-11  
 11 cm/ 4½"



24-257-11  
 11 cm/ 4½"  
 1:2



Bonaccolto  
 24-258-10  
 10 cm/ 4"



Snellen  
 24-259-10  
 10 cm/ 4"

Snellen  
 24-260-10  
 10 cm/ 4"



Ophthalmology - Ophthalmologie  
Iris Scheren, Hornhautscheren  
Iris Scissors, Corneal Scissors



Castroviejo  
24-261-10  
10 cm/ 4"



Castroviejo  
24-262-09  
9 cm/ 3½"



Westcott  
24-263-11  
11 cm/ 4½"



24-264-11  
Blunt



Castroviejo  
24-265-11  
11 cm/ 4½"



Castroviejo  
24-266-11  
11 cm/ 4½"



Castroviejo  
24-267-11  
11 cm/ 4½"

Ophthalmology - Ophthalmologie  
 Irisscheren, Schnenschnenscheren  
 Iris Scissors, Tenotomy Scissors



Fig. 01



Fig. 02



Fig. 03

Noyes  
 24-268-12 - 24-270-12  
 12 cm/ 4 7/8"

Fig.	
1	24-268-12
2	24-269-12
3	24-270-12



Noyes  
 24-271-12 - 24-273-12  
 12 cm/ 4 1/2"

Fig.	
1	24-271-12
2	24-272-12
3	24-273-12



24-275-08



Vannas  
 24-274-08  
 8 cm/ 3 1/8"



Barraquer  
 24-276-05  
 5.5 cm/ 2 1/8"



24-277-11



24-278-11



24-279-11

Wecker  
 24-277-11 - 24-279-11  
 11 cm/ 4 1/2"



Berens  
 24-280-16  
 16 cm/ 6 1/4"



Noyes  
 24-281-15  
 15 cm/ 6"

Ophthalmology - Ophthalmologie  
 Augen Nadelhalter mit hart Metalleinsätzen  
 Eye Needle Holders with Tungsten Carbide Inserts

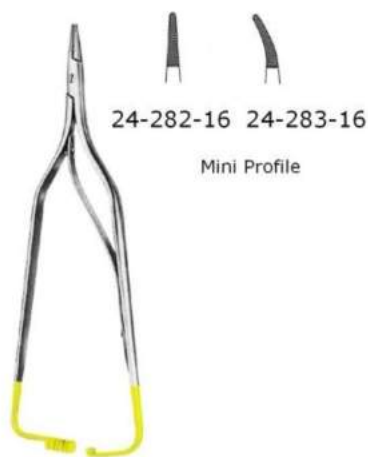

24-282-16 24-283-16  
 Mini Profile

Arruga  
 24-282-16 - 24-283-16  
 16 cm/ 6 1/2"

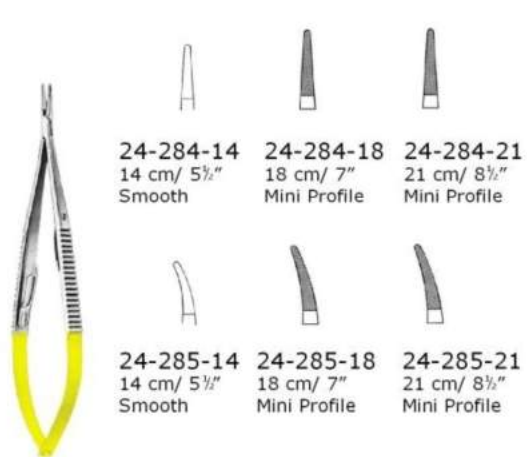

24-284-14 14 cm/ 5 1/2" Smooth	24-284-18 18 cm/ 7" Mini Profile	24-284-21 21 cm/ 8 1/2" Mini Profile
24-285-14 14 cm/ 5 1/2" Smooth	24-285-18 18 cm/ 7" Mini Profile	24-285-21 21 cm/ 8 1/2" Mini Profile

Castroviejo  
 24-284-14 - 24-285-21



Smooth

Castroviejo  
 24-286-13  
 13 cm/ 5"



Smooth

Barraquer  
 24-287-13  
 13 cm/ 5"  
 With Lock



Smooth

Barraquer  
 24-288-13  
 13 cm/ 5"

## TC INSTRUMENTS



Scissors with Tougsten Carbide Inserts

Dissecting Forceps with Tougsten Carbide

Needle Holder with Tougsten Carbide Inserts



TC Instruments  
Scheren mit Hartmetalleinsätzen  
Scissors with Tungsten Carbide Inserts

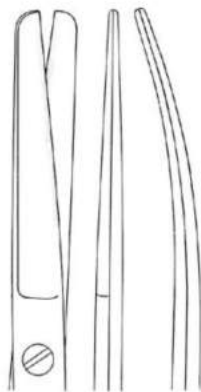

25-101-14 Str.  
25-102-14 Cvd.

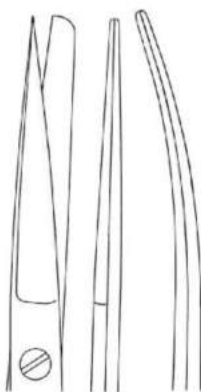

25-103-14 Str.  
25-104-14 Cvd.

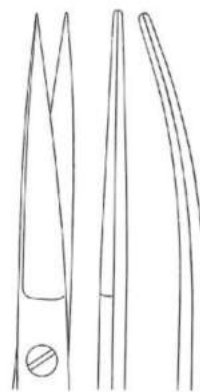

25-105-14 Str.  
25-106-14 Cvd.

Standard  
25-101-14 - 25-106-14  
14 cm/ 5½"

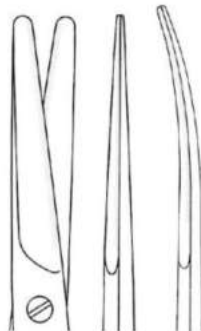

25-107-14 14 cm/ 5½"  
25-107-17 17 cm/ 6½"  
25-107-23 23 cm/ 9"  
Str.

25-108-14  
25-108-17  
25-108-23  
Cvd.

Mayo  
25-107-14 - 25-108-23

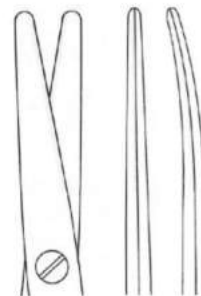

25-109-15 15 cm/ 6"  
25-109-17 17 cm/ 6½"  
Str.

25-110-15  
25-110-17  
Cvd.

Mayo-Stillé  
25-109-15 - 25-110-17

Instrumentarium mit Hartmetalleinsätzen  
 Scheren mit Hartmetalleinsätzen  
 Scissors with Tungsten Carbide Inserts

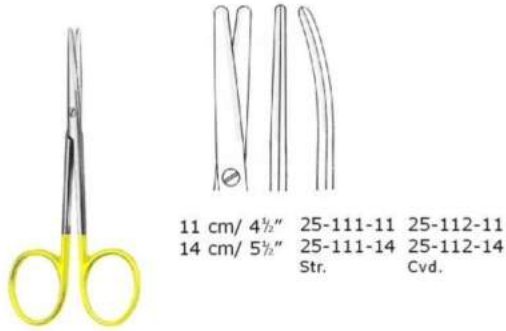

11 cm/ 4½" 25-111-11 25-112-11  
 14 cm/ 5½" 25-111-14 25-112-14  
 Str. Cvd.

Metzenbaum  
 25-111-11 - 25-112-14



27-114-11  
 11.5 cm/ 4½"  
 Cvd.

25-113-11  
 11.5 cm/ 4½"  
 Str.

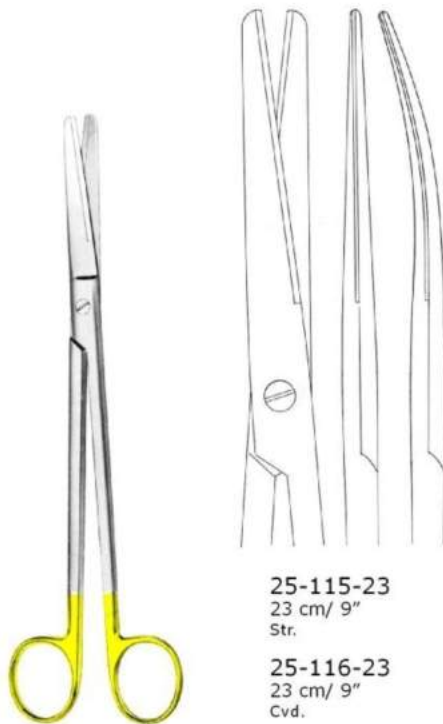

25-115-23  
 23 cm/ 9"  
 Str.

25-116-23  
 23 cm/ 9"  
 Cvd.

Sims  
 25-115-23 - 25-116-23

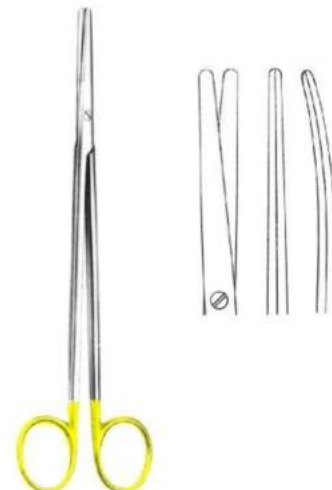

Metzenbaum  
 25-117-14 - 25-118-25  
 25-117-14 14 cm/ 5½" 25-118-14  
 25-117-18 18 cm/ 7" 25-118-18  
 25-117-20 20 cm/ 8" 25-118-20  
 25-117-23 23 cm/ 9" 25-118-23  
 25-117-25 25 cm/ 10" 25-118-25  
 Str. Cvd.

TC Instruments  
 Scheren mit Hartmetalleinsätzen  
 Scissors with Tungsten Carbide Inserts

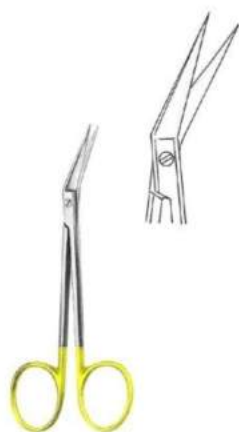

Angular  
 25-119-11  
 11.5 cm/ 4½"



25-121-16

Kelly  
 25-120-16 - 25-121-16  
 16 cm/ 6¼"

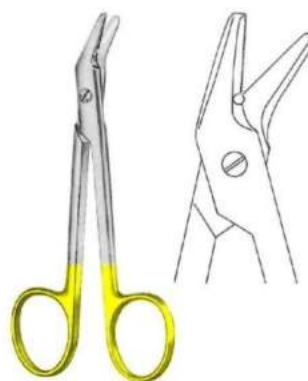

Universal  
 25-122-12  
 12 cm/ 4¾"



Lister  
 25-123-14 14 cm/ 5½"  
 25-123-18 18 cm/ 7½"

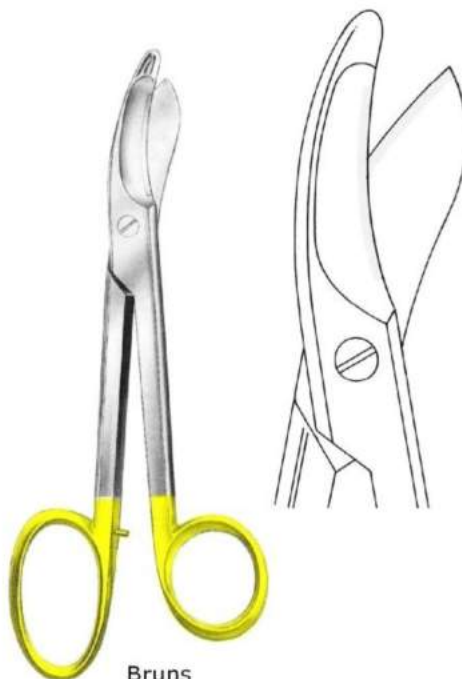

Bruns  
 25-124-24  
 24 cm/ 9½"



Instrumentarium mit Hartmetalleinsätzen  
 Pinzetten mit Hartmetalleinsätzen  
 Dissecting Forceps with Tungsten Carbide Inserts

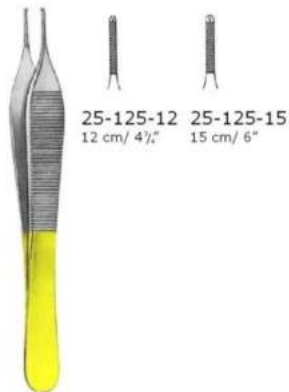

Micro-Adson  
 25-125-12 - 25-125-15  
 Mini Profile

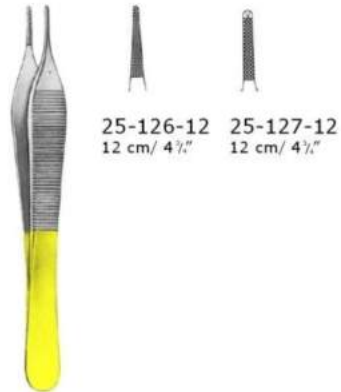

Adson  
 25-126-12 - 25-127-12  
 Normal Profile



Cushing  
 25-128-18  
 18 cm / 7"



Cushing-Taylor  
 25-129-18  
 18 cm / 7"

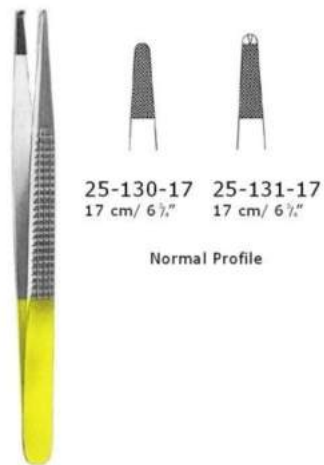

Bonney  
 25-130-17 - 25-131-17  
 Normal Profile



Gerald  
 25-132-17  
 Mini Profile





TC Instruments  
Pinzetten mit Hartmetalleinsätzen  
Dissecting Forceps with Tungsten Carbide Inserts

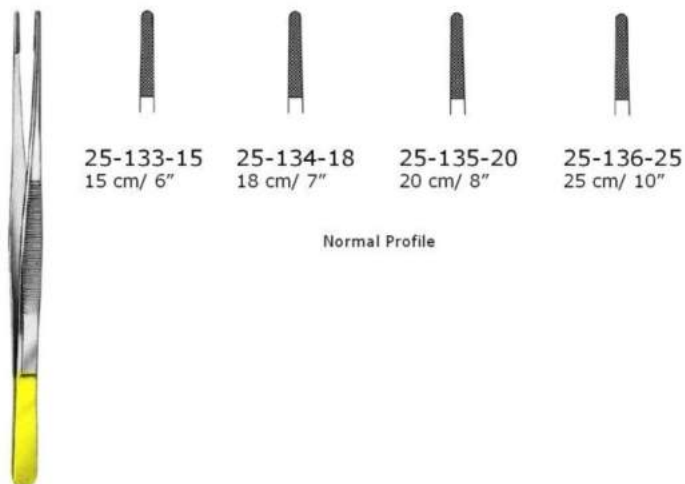

25-133-15 15 cm/ 6"  
25-134-18 18 cm/ 7"  
25-135-20 20 cm/ 8"  
25-136-25 25 cm/ 10"

Normal Profile

Potts-Smith  
25-133-15 - 25-136-25

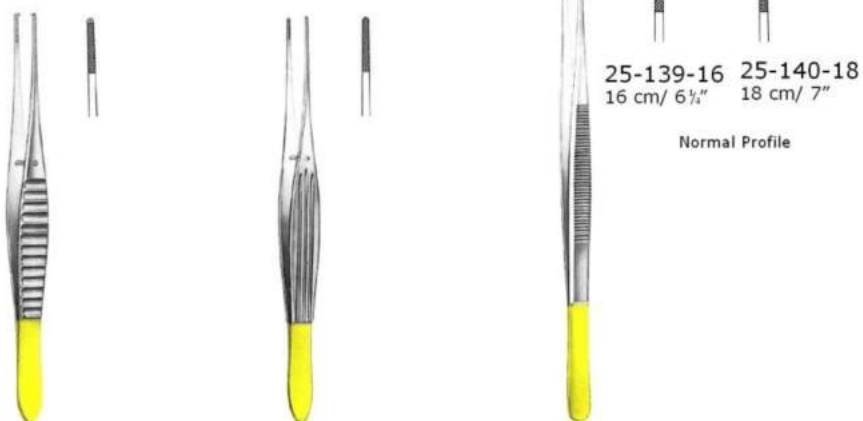

25-139-16 16 cm/ 6 1/4"  
25-140-18 18 cm/ 7"

Normal Profile

Gillies  
25-137-15  
15 cm/ 6"

Mc Indoe  
25-138-15  
15 cm/ 6"

Semken  
25-139-16 - 25-140-18

Instrumentarium mit Hartmetalleinsätzen  
Nadelhalter mit Hartmetalleinsätzen  
Needle Holders with Tungsten Carbide Inserts



Smooth

**Webster**  
25-141-13  
13 cm / 5"



Mini Profile

**Derf**  
25-142-13  
12 cm / 4 7/8"



Normal Profile

**Hegar-Baumgartner**  
25-143-14  
14 cm / 5 1/2"



Mini Profile

**Crile-Wood**  
25-144-15  
15 cm / 6"

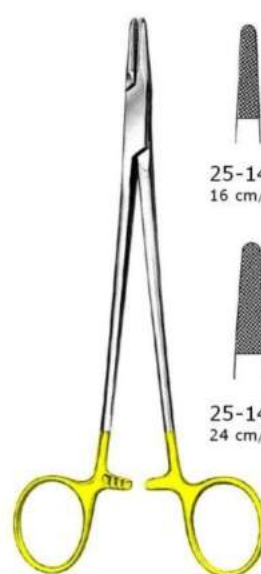

25-145-16  
16 cm / 6 1/2"



25-145-18  
18 cm / 7"



25-145-20  
20 cm / 8"



25-145-24  
24 cm / 9 1/2"



25-145-26  
26 cm / 10 1/2"



25-145-30  
30 cm / 12"

Normal Profile

**Mayo-Hegar**  
25-145-16 - 25-145-30

TC Instruments  
Nadelhalter mit Hartmetalleinsätzen  
Needle Holders with Tungsten Carbide Inserts

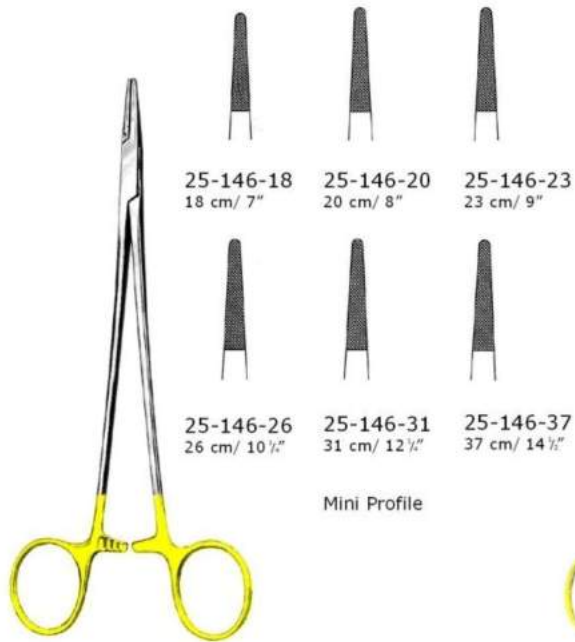

De Bakey  
25-146-18 - 25-146-37

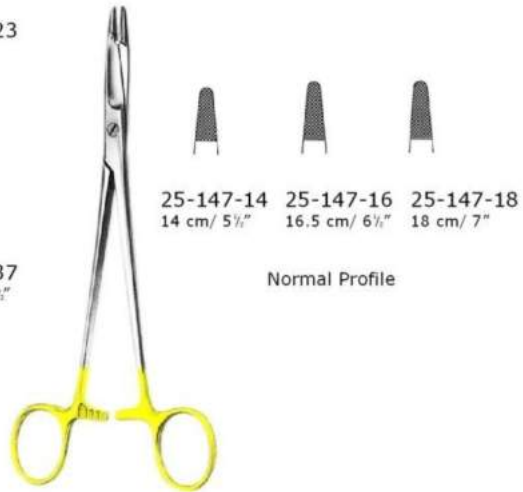

Olsen-Hegar  
25-147-14 - 25-147-18

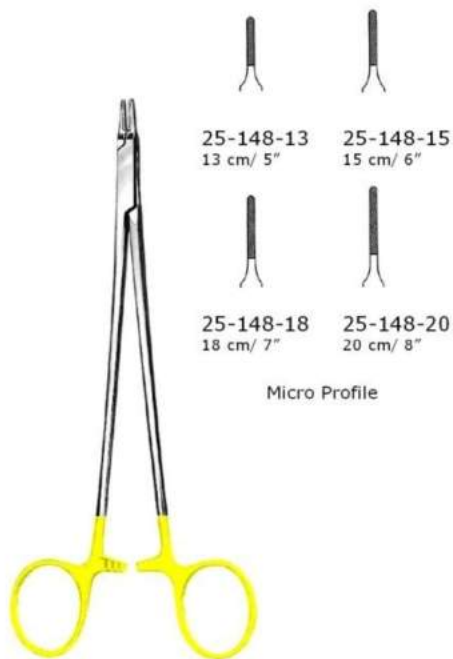

Ryder-Vascular  
25-148-13 - 25-148-20

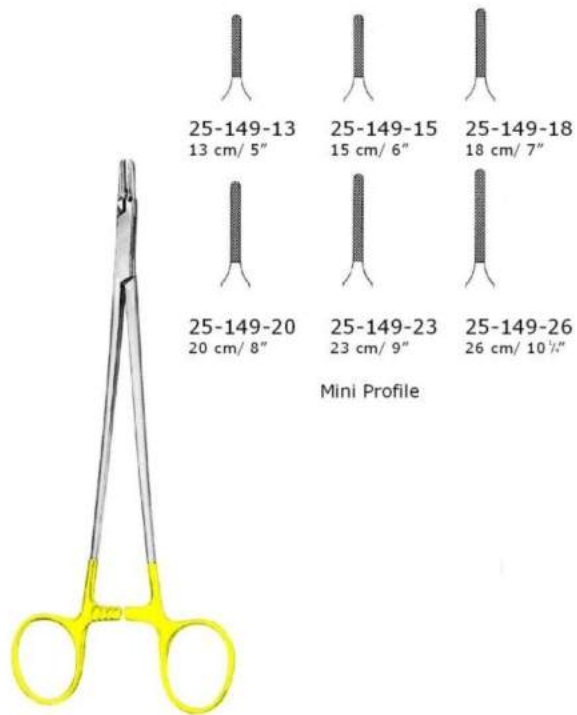

Ryder  
25-149-13 - 25-149-26

Instrumentarium mit Hartmetalleinsätzen  
Nadelhalter mit Hartmetalleinsätzen  
Needle Holders with Tungsten Carbide Inserts



Toennis  
25-150-18  
18 cm / 7"

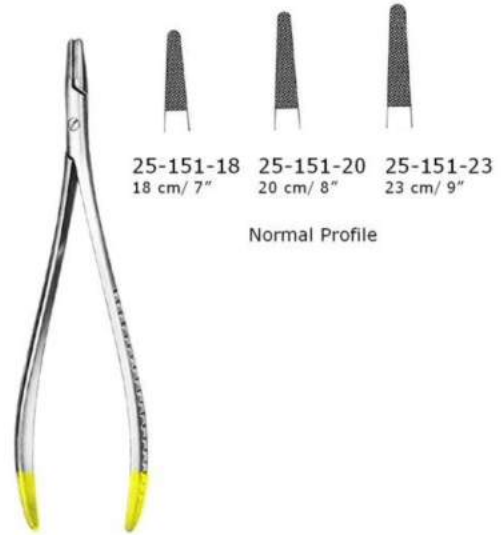

Langenbeck  
25-151-18 - 25-151-23

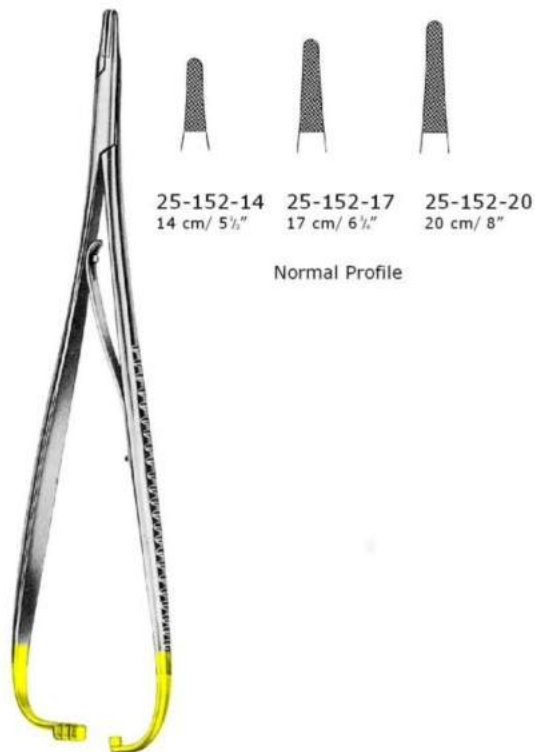

Mathieu-Kocher  
25-152-14 - 25-152-20

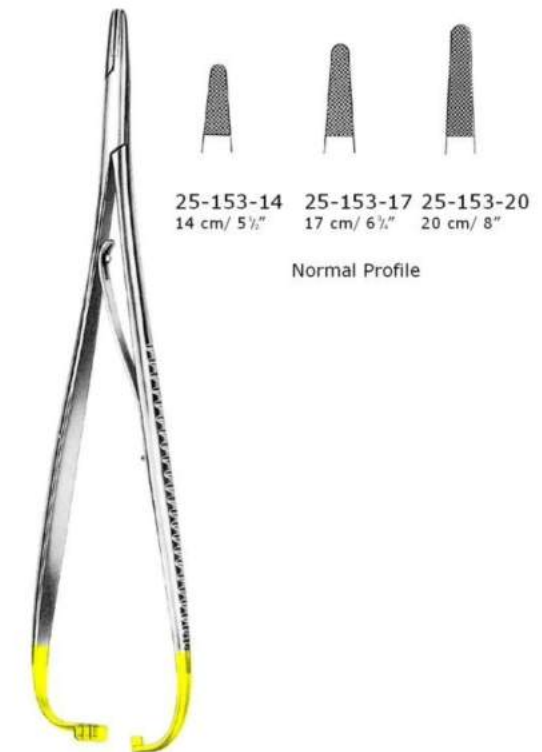

Mathieu  
25-153-14 - 25-153-20



## STERILIZATION



**Strilizing Forceps, Dressing Strilizing Drums**

**Instruments Boxes**

**Instruments Storing Trays**

**Round Bolls, Jaws, Graduatad Measures**

**Cotton Wool, Kindney Bolls, Solution Bolls**

Sterilization - Sterilisation  
Sterilisierzangen, Verbandstoffrommeln  
Sterilizing Forceps, Dressing Sterilizing Drums

With ball stop



**Cheattle**  
26-101-27  
27cm/ 10½"



26-102-20 20cm/ 8"  
26-102-30 30cm/ 12"



**Bunt (Mayo)**  
26-103-14  
14cm/ 5½"



**Bunt (Mayo)**  
26-104-14  
14cm/ 5½"

Sterilizing Drums



	Ø	H
26-105-01	80	80 mm
26-105-02	120	120 mm
26-105-03	190	140 mm
26-105-04	190	200 mm
26-105-05	160	120 mm
26-105-06	240	120 mm
26-105-07	240	160 mm
26-105-08	240	240 mm
26-105-09	290	120 mm
26-105-10	290	160 mm
26-105-11	290	240 mm
26-105-12	340	160 mm
26-105-13	340	240 mm
26-105-14	390	145 mm
26-105-15	390	200 mm
26-105-16	390	290 mm

Sterilization - Sterilisation  
Instrumentenkästen  
Instrument Boxes

Style A



Instrument Box  
Style "A"

	L	W	D
26-106-01	180 x	90 x	35 mm
26-106-02	200 x	100 x	35 mm
26-106-03	200 x	100 x	50 mm
26-106-04	220 x	120 x	50 mm
26-106-05	250 x	150 x	50 mm
26-106-06	300 x	150 x	60 mm

Style B



Instrument Box  
Style "B"

	L	W	D
26-107-01	165 x	90 x	35 mm
26-107-02	180 x	80 x	50 mm
26-107-03	200 x	100 x	35 mm
26-107-04	200 x	100 x	50 mm
26-107-05	230 x	130 x	50 mm
26-107-06	250 x	120 x	60 mm
26-107-07	250 x	150 x	50 mm
26-107-08	300 x	200 x	50 mm
26-107-09	300 x	150 x	60 mm
26-107-10	350 x	180 x	70 mm



Sterilization - Sterilisation  
 Instrumentenablageplatten  
 Instrument Storing Trays



**Instrument Trays**

26-108-01	150 x 100 x 25 mm
26-108-02	200 x 150 x 38 mm
26-108-03	250 x 200 x 50 mm
26-108-04	300 x 250 x 50 mm
26-108-05	355 x 305 x 50 mm
26-108-06	405 x 305 x 50 mm
26-108-07	460 x 300 x 50 mm

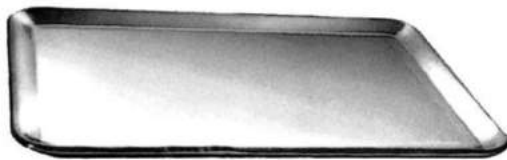

**Instrument Trays**

26-109-01	230 x 180 x 10 mm
26-109-02	300 x 150 x 10 mm
26-109-03	300 x 200 x 10 mm
26-109-04	370 x 250 x 10 mm
26-109-05	420 x 280 x 10 mm



**Spirit Lamp**  
 26-110-01  
 Double Bolt (120cc)





Sterilization - Sterilisation  
Runde Schalen, Standgefäße, Meßbecher  
Round Bowls, Jars, Graduated Measures



Round Bowls

	∅	D	Capacity
26-111-01	167 x	62 mm	0.9 L
26-111-02	200 x	75 mm	1.4 L
26-111-03	230 x	82 mm	2.2 L
26-111-04	261 x	94 mm	3.0 L
26-111-05	292 x	103 mm	4.0 L
26-111-06	328 x	111 mm	5.7 L

Forcep Jars



	∅	Height
26-112-01	30 x	90 mm
26-112-02	50 x	100 mm
26-112-03	50 x	130 mm
26-112-04	50 x	175 mm
26-112-05	75 x	100 mm
26-112-06	75 x	130 mm
26-112-07	75 x	175 mm
26-112-08	100 x	175 mm
26-112-09	100 x	200 mm

Medicine Cups



26-113-25  
25 cc



26-114-50  
50 cc



26-115-90  
∅90 x 90 mm, height



26-116-80  
∅80 x 90 mm

Sterilization - Sterilisation  
Nierenschalen, Spülschalen (Kummen)  
Cotton Wool, Kidney Bowls, Solution Bowls



Dressing Jars

	∅	Height
26-117-01	75 x 75 mm	
26-117-02	100 x 100 mm	
26-117-03	125 x 125 mm	
26-117-04	150 x 150 mm	
26-117-05	180 x 180 mm	
26-117-06	200 x 200 mm	
26-117-07	250 x 250 mm	
26-117-08	300 x 300 mm	



Kidney Trays

26-118-01	150 mm
26-118-02	170 mm
26-118-03	200 mm
26-118-04	250 mm
26-118-05	300 mm



Solution Bowl

	∅	Height
26-119-01	50 x 25 mm	
26-119-02	80 x 40 mm	
26-119-03	100 x 45 mm	
26-119-04	115 x 50 mm	
26-119-05	150 x 60 mm	
26-119-06	200 x 90 mm	
26-119-07	250 x 100 mm	
26-119-08	300 x 115 mm	



## Index

### A

Abdominal Spatulas.....	151
Abortion Scoops.....	343
Adson Artery Forceps.....	59
Adson Brown Tissue Forceps.....	92
Adson Dissecting Forceps with Tungsten Carbide Inserts.....	414
Adson Dressing Forceps.....	86
Adson Dura Hooks.....	278, 279
Adson Elevators.....	221
Adson Needle Holder.....	172
Adson Retractors.....	133, 136, 138
Adson Suction Tubes.....	159
Adson Tissue Forceps.....	90
Alan Parks Rectal Spaculum.....	304
Alderdyce Elevators.....	222
Alexander Bone Chisels and Gouges.....	203
Alexander Cervical Biopsy and Specimen Forceps.....	329
Allis Intestinal Tissue Forceps.....	294, 295
Allis-Adair Intestinal Tissue Forceps.....	294
Allis-Atrauma Intestinal Tissue Forceps.....	295
Allis-Baby Intestinal Tissue Forceps.....	294
Allison Lung Spatulas.....	251
Allis-Thomas Intestinal Tissue Forceps.....	295
Alm Retractors.....	131
Amputating Knives.....	27
Amputating Saws.....	192
Anderson-Adson Retractors.....	132
Andrew Tongue Depressor.....	377
Angular Scissors with Tungsten Carbide Inserts.....	413
Antrum Punch Forceps.....	367
Arruga.....	395
Arruga Capsular Forceps.....	402
Arruga Eye Speculas.....	392
Arruga Needle Holders with Tungsten Carbide Inserts.....	409
Arruga-Nizetic Capsular Forceps.....	402
Artery Forceps.....	55-69, 71
Asch Septum Forceps.....	375
Atrauma Bulldog Clamps.....	254, 260
Atrauma Cardiovascular Forceps.....	256, 258, 261, 264
Atrauma Hemostatic Forceps.....	255
Atrauma Tissue Forceps.....	259
Aufricht Nasal Hooks.....	373
Aufricht Nasal Rasps.....	374
Aufricht Nasal Retractors.....	372
Autopsy Knives.....	19
Autopsy Scissors.....	49
Auvard Vaginal Specula.....	338
Axenfeld Curettes.....	397
Ayer Chalazion Forceps.....	405
Ayre Cone Knife.....	325

### B

Babcock Atrauma Intestinal Tissue Forceps.....	296
Babcock Intestinal Tissue Forceps.....	296
Babinsky Hammers.....	13
Baby Adson Dissecting Forceps.....	64
Baby Mikulicz Clamp Forceps.....	74
Baby Mixer Artery Forceps.....	55
Baby Mixer Dissecting Forceps.....	64
Baby Overholt Artery Forceps.....	58
Baby-Collin Abdominal Retractors.....	142
Baby-Doyen Intestinal Tissue Forceps.....	297
Backhaus Towel Forceps.....	76
Bailey Rib Contractor.....	251
Bailey-Baby Rib Contractor.....	251
Bainbridge Atrauma Cardiovascular Forceps.....	262
Bakes Gall Duct Dilators.....	309
Balfour Abdominal Retractors.....	146, 147, 148
Balfour-Baby Retractors.....	146
Ballenger Septum Knives.....	369
Bandage Scissors.....	186, 187
Barraquer Cilia Forceps.....	95
Barraquer Eye Speculas.....	392
Barraquer Iris Scissors.....	408
Barraquer Needle Holders with Tungsten Carbide Inserts.....	409
Barraquer Suture Forceps.....	404
Barth Ear Curettes.....	353
Baumgartner Needle Holder.....	171
Beacham Tenaculum Forceps.....	317
Beckmann Adenoide Curettes.....	374
Beckmann Retractors.....	138
Beckmann-Adson Retractors.....	139
Beckmann-Eaton Retractors.....	139
Beer Cilia Forceps.....	95
Belluci Micro Ear Scissors.....	352
Bengolea Artery Forceps.....	60
Bennett Bone Levers.....	225
Berens Desmarres Lid Retractor.....	393
Berens Iris Scissors.....	408

Bergmann Plaster Shears.....	186
Bernhard Towel Forceps.....	77
Beyer Bone Rongeur Forceps.....	235
Beyer Punches.....	348
Billeau Loops.....	355
Bircher Ganske Cartilage Forceps.....	227
Bircher Menisectomy Knives.....	226
Bishop Harman Forceps.....	400
Bladder Retractors.....	313
Blake Gall Stone Forceps.....	308
Blascovics Forceps.....	406
Blood Pressure Manometers.....	16
Blount Bone Levers.....	225
Blumenthal Bone Rongeur Forceps.....	234
Bohler Bone Rongeur Forceps.....	235
Bohler Extension Bows.....	201
Bonaccollo Forceps.....	406
Bone Chisels.....	203, 204, 205, 206
Bone Curettes.....	210, 211, 212, 213, 214
Bone Cutting Forceps.....	238, 239, 241, 242
Bone Drills.....	193
Bone Elevators.....	221, 222
Bone Files.....	220
Bone Gouges.....	203, 204, 205, 206
Bone Holding Clamps.....	197
Bone Holding Forceps.....	228, 229, 230, 231, 232
Bone Levers.....	223, 224, 225
Bone Rongeur Forceps.....	233-237, 240
Bone Shears.....	245
Bonn Scissors.....	47
Bonney Dissecting Forceps with Tungsten Carbide Inserts.....	414
Bonney Tissue Forceps.....	93
Bose Trachea Retractors.....	290
Bowman Eye Speculas.....	392
Bowman Lacrimal Probes.....	398
Bowman Probes.....	153
Boys-Allis Intestinal Tissue Forceps.....	294
Bozemann Swab Forceps.....	81
Bozmann Douglas Swab Forceps.....	81
Brain Spatulas.....	275
Braun Tenaculum Forceps.....	318, 321
Braun Uterine Dilators.....	332
Braun-Stadler Scissors.....	44
Breisky Vaginal Speculas.....	339
Bronchus Clamps.....	68, 69
Bronchus Forceps.....	252
Brown Needle Holders.....	171
Bruening Septum Compression Forceps.....	363
Bruening Universal Detachable Tubes.....	389
Bruenings Cutting and Grasping Forcep Tips.....	389
Bruenings Tongue Depressor.....	377
Bruenings Tonsil Snares.....	387
Brunner Ligature Conductors.....	181, 182
Brunner Retractors.....	121
Brunner Rib Shears.....	246
Brunner-Atrauma Intestinal Clamp Forceps.....	301
Bruns Bone Curettes.....	211, 212
Bruns Plaster Shears.....	187
Bruns Scissors with Tungsten Carbide Inserts.....	413
Buck Ear Curettes.....	353
Buck Ear Polypus Forceps.....	349
Buck Hammer.....	12
Buck Knife.....	357
Buck Stitch Scissors.....	50
Buck Telescopic Hammer.....	12
Bulldog Clamps.....	52
Bunge Chalazion Curettes.....	397
Bunt (Mayo).....	420
Burford Rib Spreaders.....	248
Burrs For Hand Drills.....	195
Busch Umbilical Scissors.....	45
Butterfly Probes.....	154

### C

Cannulas.....	397
Caplan Septum Scissors.....	366
Capsula Forceps.....	402
Cardiovascular Scissors.....	40, 41
Carpenter Tonsil Knives.....	385
Cartilage Forceps.....	227
Cartilage Knives.....	19
Castroviejo Needle Holders with Tungsten Carbide Inserts.....	409
Castaneda Rib Spreaders.....	248
Castroviejo Cannulas.....	397
Castroviejo Capsular Forceps.....	402
Castroviejo Corneal Scissors.....	407
Castroviejo Lacrimal Dilators.....	398
Castroviejo Lens Expressors.....	396
Castroviejo Razor Blade Breakers.....	20
Castroviejo Razor Blade Holders.....	20
Castroviejo Spatulas.....	399
Castroviejo Suture Forceps.....	404



Castroviejo Tissue Forceps.....	403
Cataract Knives.....	394
Catheter Introducing Forceps.....	165
Catlin Amputating Knives.....	27
Cauer Chalazion Forceps.....	405
Cervical Biopsy and Specimen Forceps.....	329,330,331
Cervical Traction Tong.....	269
Chalazion Curettes,Dissectors.....	397
Chalazion Forceps.....	405
Channelled Retractors.....	383
Chaput Artery Forceps.....	53
Charriere Amputating Saw.....	192
Cheate Sterilizing Forceps.....	420
Cheek and Lip Retractors.....	377
Cheron Dressing Forceps.....	81
Chevalier-Jackson Forceps.....	388
Chevalier-Jackson Trachea Tubes.....	291
Chin Retractors.....	383
Cilia forceps.....	95
Cinelli Rhinoplastic Instruments.....	371
Circumcision Clamps.....	315
Citelli Punches.....	348
Clamp Forceps.....	72,74
Cleveland Bone Rongeur Forceps.....	233
Cleveland Bone Cutting Forceps.....	239
Clips and Applying Forceps.....	270
Cloward Lamina Spreaders.....	282
Cloward Retractors.....	137
Cloward Retractors.....	137
Coakley Sharp Curettes.....	373
Coldough Intervertebral Disc Rongeurs.....	283,284
Colibri Suture Forceps.....	404
Collier Needle Holders.....	171
Collin Abdominal Retractors.....	142,143
Collin Artery Forceps.....	54
Collin Cotton Swab Forceps.....	81
Collin Mallets.....	208
Collin Operating Knives.....	27
Collin Suture Clip Forcep.....	183
Collin Tongue Holding Forceps.....	378
Collin Umbilical Cord Clamp.....	342
Collin Uterine Elevating Forceps.....	323
Collin Vaginal Speculums.....	334
Collin-Hartmann Retractors.....	128
Collin-Loktite Abdominal Retractors.....	143
Containers For Cotton Wool.....	424
Converse Hooks.....	372
Cooley Atrauma Tissue Forceps.....	259
Cooley Rib Spreaders.....	247
Cooley Suction Tubes.....	161
Cooley Vascular Dilators.....	265
Cooper Ligature Needles.....	178
Corneal Scissors.....	407
Coryllos Retractors.....	119
Cottle Periosteal Elevators.....	370
Cottle Nasal Hooks.....	372
Cottle Nasal Hooks.....	373
Cottle Nasal Scissors.....	43
Cottle Nasal Speculums.....	360
Cottle Osteotomes.....	371
Cottle Rhinoplastic Knives.....	369
Cottle Tissue Forceps.....	375
Cottle-Kazanjan Bone Cutting Forceps.....	238
Cottle-Walsham Septum Forceps.....	375
Cotton Applicators.....	156
Cotton Swab Forceps.....	79,80,81,82,83
Crafoord Artery Forceps.....	65
Crawford Retractors.....	122
Crile Artery Forceps.....	58
Crile Needle Holder.....	176
Crile Rankin Artery Forceps.....	58
Crile-Murray Needle Holder.....	172
Crile-Wood Needle Holder.....	172
Crile-Wood Needle Holders with Tungsten Carbide Inserts.....	416
Cross Action Retractors.....	131
Cross Action Retractors.....	131
Crutchfield Cervical Traction Tongs.....	269
Culler Hooks.....	395
Curettes.....	353,354
Cusco Vaginal Speculums.....	333
Cushing Burrs For Hand Drills.....	195
Cushing Dissecting Forceps with Tungsten Carbide Inserts.....	414
Cushing Dressing Forceps.....	87
Cushing Dura Hooks.....	279
Cushing Nerve Hooks.....	277
Cushing Periosteal Raspatories.....	215
Cushing Retractors.....	103,104
Cushing Tissue Forceps.....	91
Cushing-Taylor Dissecting Forceps with Tungsten Carbide Inserts.....	414
Cuzzi Abortion Scoops.....	343
Czerny Rectal Spaculum.....	304
Czerny Tenaculum Forceps.....	321

## D

Dahlgren Rongeur Forceps.....	268
Dale Multipurpose Clamps.....	257
Dandy Artery Forceps.....	59
Dandy Dura Hooks.....	278
Dardik Multipurpose Clamps.....	257
Dartigues Uterine Elevating Forceps.....	323
Dastoor Suture Forceps.....	404
Davidson Retractors.....	120
Davis Dura Dissector.....	274
Davis-Boyle Mouth Gags.....	379
Day Ear Hooks.....	355
Dean Tonsil Scissors.....	43
Deaver Retractors.....	125,126
Deaver Scissors.....	31
DeBakey Atrauma Cardiovascular Forceps.....	262,263,264
DeBakey Atrauma Tissue Forceps.....	259
DeBakey Needle Holders with Tungsten Carbide Inserts.....	417
DeBakey Tissue Forceps Atrauma.....	88
DeBakey Vascular Dilators.....	265
DeBakey-Dietrich Atrauma Clamps.....	52
DeBakey-Mosquito Atrauma Forceps.....	255
DeBakey-Pean Atrauma Forceps.....	255
DeBakey-Rankin Atrauma Forceps.....	255
DeBakey-Satinsky Atrauma Bulldog Clamps.....	254
Dejerine Hammers.....	12
Denhart Mouth Gag.....	378
Derf Needle Holders.....	171
Derf Needle Holders with Tungsten Carbide Inserts.....	416
Dermatomes.....	28
Deschamps Ligature Needles.....	179,180
Desjardins Gall Stone Forceps.....	308
Desjardins Gall Stone Probes.....	309
Desmarres Chalazion Forceps.....	405
Desmarres Lid Retractors.....	393
Desmarres Retractors.....	101
DeVilbiss Rongeur Forceps.....	268
Diagnostic Set.....	15
Dieffenbach Bulldog Clamps.....	52
Diethrich Bulldog Clamps.....	52
Diethrich Clamps.....	256
Dietrich Vascular Scissors.....	40
Dilating Bougies.....	315
Dingman Mouth Gags.....	380
Dingmann Cartilage Forceps.....	227
Directors.....	292
Disimpaction Forceps.....	384
Dissecting Forceps.....	64,65,66,67,71
Dissecting Forceps with Tungsten Carbide Inserts.....	414,415
Dissecting Knives.....	18
Dissecting Scissors.....	32,34,35,36,37,38
Dissecting Scissors.....	39
Dissectors.....	385
Double Ended Instruments.....	399
Douglas Cilia Forceps.....	95
Doyen Mallets.....	208
Doyen Myoma Screws.....	324
Doyen Periosteal Raspatories.....	219
Doyen Polypus Forceps.....	322
Doyen Probe.....	154
Doyen Retractors.....	117
Doyen Scissors.....	33
Doyen Vaginal Speculas.....	338,339
Doyen-Atrauma Intestinal Tissue Forceps.....	297
Dressing and Tampon Forceps.....	362
Dressing Forceps.....	85,86,87
Dressing Jars.....	424
Duplay Tenaculum Forceps.....	317
Duplex Stethoscopes.....	14
Dura Dissectors.....	271,272,273,274
Dura Hooks.....	278,279
Durante Tissue Forceps.....	93
Duval Intestinal Tissue Forceps.....	296
Duval Tissue Forceps.....	54
Duval Tissue Forceps.....	92

## E

Ear Dressing Forceps.....	348
Ear Polypus Forceps.....	349
Ear Polypus Forceps.....	356
Ear Speculas.....	347
Ear Syringes.....	356
Echlin Bone Rongeur Forceps.....	236
Eicken-Killian Wash Canula.....	373
Elevating Spoons.....	342
Elsasser Gall Stone Forceps.....	308
Elschnig Capsular Forceps.....	402
Elschnig Eye Spoons.....	396
Elschnig Lens Expressors.....	396



Endospacula .....	324
Engel Plaster Saw.....	188
Enterotomy Scissors.....	49
Entropium Forceps.....	406
Enucleation Scissors.....	48
Enucleators.....	292, 385
Enucleators.....	385
Episiotomy Scissors.....	44
Errico Burrs For Hand Drills.....	195
Esmarch Plaster Knives.....	188
Esmarch Plaster Shears.....	186
Eves Tonsil Snare.....	387
Extension Bows.....	201
Eye Needle Holders with Tungsten Carbide Inserts.....	409
Eye Scalpels.....	394
Eye Speculas.....	392
Eye Spoon.....	396

## F

Farabeuf Bone Holding Forceps.....	230
Farabeuf Periosteal Raspatories.....	216
Farabeuf Retractors.....	127
Farabeuf-Lambotte Bone Holding Forceps.....	230
Farral Cotton Applicators.....	156
Farrior Ear Speculas.....	347
Faure Cervical Biopsy and Specimen Forceps.....	329
Faure Peritoneal Clamp Forceps.....	75
Fehland Rectum Forceps.....	302
Feilchenfeld Forceps.....	94
Fergusson Bone Holding Forceps.....	229
Ferris Smith Kerrison Rongeurs.....	285
Ferris-Smith-Cushing Rongeurs.....	368
Ferris-Smith-Kerrison Rongeurs.....	368
Fine Operating Scissors.....	39
Fine Operating Scissors.....	46, 47, 48
Finger Ring Saws.....	243
Finocchietto Artery Forceps.....	69, 174
Finocchietto Needle Holder.....	174
Finocchietto Rib Spreaders.....	247, 249
Finsen Retractors.....	130
Fischer Iris Forceps.....	400
Fischer-Arit Iris Forceps.....	400
Fisher Needle and Spatula.....	399
Fixation Forceps.....	403
Flat Nose Plier.....	198, 199
Flat Nose Pliers With TC Inserts.....	200
Foerster Iris Forceps.....	400
Foerster Swab Forceps.....	82, 83
Fomon Chisels.....	371
Fomon Dissecting Scissors.....	36
Fomon Hooks.....	372
Fomon Nasal Scissors.....	43
Forcep Jars.....	423
Foregger Laryngoscope Set.....	169
Foreign Body Instruments.....	355
Fraenkel Cutting and Grasping Forcep Tips.....	389
Frazier Dura Dissectors.....	273
Frazier Dura Hooks.....	279
Frazier Suction Tubes.....	159
Freer Periosteal Elevators.....	370
Freer Mucous Hooks.....	372
Freer Rhinoplastic Knives.....	369
Freer Septum Chisels.....	371
Freer Septum Knives.....	369
Friedman Bone Rongeur Forceps.....	233
Friedman-Vickers Bone Rongeur Forceps.....	233
Fritsch Retractors.....	116
Frosch Bone Holding Forceps.....	229
Frykholm Bone Rongeur Forceps.....	236
Fuchs Capsular Forceps.....	402
Fuchs Iris Forceps.....	400
Fuchsig Artery Forceps.....	59

## G

Gall Duct Clamps.....	68, 69
Gall Duct Dilators.....	309
Gall Stone Forceps.....	308
Gall Stone Probes.....	309
Gall Stone Scoops.....	310
Geilhorn Cervical Biopsy and Specimen Forceps.....	329
Gelpi-Loktite Retractors.....	141
Gemini Dissecting Forceps.....	67
Gerald Dissecting Forceps with Tungsten Carbide Inserts.....	414
Gerald Dressing Forceps.....	86
Gerald Tissue Forceps.....	91
Gerster-Lowmann Bone Holding Clamps.....	197
Gerzong-Sexton Ear Knife.....	357
Giertz-Stille Rib Shears.....	246
Gigli Wire saw Handle.....	268
Gill-Hess Iris Forceps.....	400

Gillies Dissecting Forceps with Tungsten Carbide Inserts.....	415
Gillies Needle Holder.....	175
Gillies Tissue Forceps.....	90
Gills-Arruga Capsular Forceps.....	402
Girard Suture Forceps.....	404
Glover Atrauma Bulldog Clamps.....	254, 260
Gluck Rib Shears.....	245
Goelet Retractors.....	129
Goldmann-Fox Scissors.....	46
Good Tonsil Scissors.....	43
Gosset Abdominal Retractors.....	145
Graduated Measures.....	423
Graefe Eye Speculas.....	392
Graefe Eye Spoons.....	396
Graefe Fine Retractors.....	99
Graefe Fixation Forceps.....	403
Graefe Iris Forceps.....	401
Graefe Skin Hooks.....	395
Graham Nerve Hooks.....	277
Graves Vaginal Speculums.....	334
Green Iris Spatula.....	399
Green-Armytage Forceps.....	342
Gregory Cardiovascular Forceps.....	258
Gregory-Soft Atrauma Bulldog Clamps.....	254
Groningen Nerve Hooks.....	277
Gross Ear Hooks.....	355
Gross Maier Dressing Forceps.....	80
Gruber Ear Speculas.....	347
Gruenwald Ear Dressing Forceps.....	361
Guide Needles.....	162
Guist Fixation Forceps.....	403
Guthrie Fine Retractors.....	99
Guthrie Hooks.....	395
Guyon Dilating Bougies.....	315
Guyon Kidney Clamps.....	70
Gynecology Scissors.....	33

## H

Haberer Abdominal Spatulas.....	151
Hajak Sphenoid Punch Forceps.....	367
Hajek Nasal Cutting Forceps.....	365
Halle Periosteal Elevators.....	370
Halle Bone Curettes.....	213
Halle Knives.....	278
Halsey Needle Holder.....	171
Halstead Mosquito Forceps.....	56
Hand Drills.....	194, 195, 196
Hank Uterine Dilators.....	332
Hanke Dissectors.....	385
Harrington Retractors.....	124
Hartmann Bone Rongeur Forceps.....	233
Hartmann Artery Forceps.....	55
Hartmann Ear Polypus Forceps.....	349
Hartmann Ear Polypus Forceps.....	356
Hartmann Ear Speculas.....	347
Hartmann Eustachian Catheters.....	346
Hartmann Hook.....	355
Hartmann Nasal Cutting Forceps.....	365
Hartmann Nasal Polypus Forceps.....	362
Hartmann Tongue Depressor.....	377
Hartmann Tonsil Punch Forceps.....	385
Hartmann Tuning Forks.....	346
Hartmann-Halle Nasal Speculums.....	359
Hartmann-Noyes Ear Polypus Forceps.....	349
Hartmann-Weingartner Ear Polypus Forceps.....	349
Hartmann-Wullstein Ear Polypus Forceps.....	349
Head Mirrors.....	16
Heaney Clamp Forceps.....	72
Heaney Needle Holder.....	173
Heath Chalazion Curettes.....	397
Hegar Uterine Dilators.....	331
Hegar-Baumgartner Needle Holders with Tungsten Carbide Inserts.....	416
Hegebarth Suture Clip Forceps.....	183
Heifetz Brain Spatulas.....	275
Heiss Artery Forceps.....	64
Heister Mouth Gag.....	378
Hemostats.....	207
Henley Retractors.....	133
Hennig Plaster Cast Spreaders.....	189
Hermann Plaster Cast Bending Forceps.....	189
Hess Capsular Forceps.....	402
Hess Iris Forceps.....	400, 401
Hess Iris Forceps.....	401
Heymann Nasal Polypus Forceps.....	363
Heymann-Knight Nasal Polypus Forceps.....	362
Hibbs Bone Chisels.....	206
Hoehn Dura Dissectors.....	273
Hoehn Periosteal Raspatories.....	216
Hohmann Bone Levers.....	224
Hoke Bone Chisels.....	206
Holsher Nerve Root Retractors.....	276



Hooks.....	355
Hooks and Hooklets.....	395
Hooks and Spatulas.....	393
Hopkins Plaser Knives.....	188
Horsley Dura Dissectors.....	274
Hosel Retractors.....	115
Huber Universal Detachable Handles.....	389
Hudson Brace Hand Drills.....	195
Hunt Chalazion Forceps.....	405
Hunter Splinter Forceps.....	96
Hurd Dissectors.....	385
Husfeldt Cardiovascular Forceps.....	258
Hypodermic Needles.....	163
Hysterectomy Forceps.....	72,73,74

## I

Inge Lamina Spreaders.....	282
Instrument Boxes.....	421
Instrument Boxes Style A.....	421
Instrument Boxes Style B.....	421
Instrument Storing Trays.....	422
Instrument Trays.....	422
Interchangeable Tubes,Cutting and Grasping Forceps.....	389
Intervertebral Disc Rongeurs.....	283,284,285
Intestinal Clamp Forceps.....	297,298,299,301
Intima Spatulas.....	266
Iowa Tenaculum Forceps.....	320
Iris Forceps.....	400
Iris Scissors.....	407,408
Iris Scissors.....	47,48
Iterson Trachea Retractors.....	290
Ives-Fansler Rectal Spacula.....	303

## J

Jackson Trachea Retractors.....	289
Jacobs Tenaculum Forceps.....	320
Jacobson Vascular Hooks.....	280
Jaeger Hooks.....	395
Jameson Hooks.....	395
Jamison Needle Holder.....	173
Jansen Bone Rongeur Forceps.....	234
Jansen Ear Curette.....	353
Jansen Ear Dressing Forceps.....	348
Jansen Retractors.....	131
Johns Hopkins Bulldog Clamps.....	52
Johnson Needle Holder.....	174
Jones Towel Forceps.....	76
Joseph Periosteal Elevators.....	370
Joseph Hooks.....	372
Joseph Nasal Saw.....	374
Joseph Rhinoplastic Knives.....	369
Joseph Scissors.....	39
Judd-Allis Intestinal Tissue Forceps.....	294
Jurasz Laryngeal Polypus Forceps.....	386

## K

Kallmorgen Vaginal Specula and Retractors.....	337
Kane Umbilical Cord Clamp.....	342
Kelly Artery Forceps.....	57,71
Kelly Fine Artery Forceps.....	57
Kelly Rankin Artery Forceps.....	58
Kelly Retractors.....	114,127
Kelly Scissors.....	34
Kelly Scissors with Tungsten Carbide Inserts.....	413
Kelly Uterine Polypus Forceps.....	322
Kelsey-Fry Awls.....	383
Kern Bone Holding Forceps.....	229
Kerrison Antrum Punch Forceps.....	367
Kevoikian Biopsy Curette.....	325
Kevoikian Cervical Biopsy and Specimen Forceps.....	331
Kidney Clamps.....	70
Kidney Stone Forceps.....	307
Kidney Trays.....	424
Kielland Obstetrical Forceps.....	341
Killian Periosteal Elevators.....	370
Killian Nasal Polypus Forceps.....	362
Killian Nasal Speculums.....	360
Killian Septum Scissors.....	366
Kilner Hooks.....	372
Kilner Scissors.....	39
Kilner-Doughty Mouth Gags.....	380
Kirschner Abdominal Retractors.....	150
Kirschner Extension Bows.....	201
Kirschner Ligature Needles.....	181
Knapp Hooks.....	395
Knapp Iris Spatula.....	399

Knapp-Clark Eye Speculas.....	392
Knight Polypus Forceps.....	363
Knives.....	278
Knot Tiers.....	182
Kocher Artery Forceps.....	63
Kocher Delicate Artery Forceps.....	61
Kocher Directors.....	292
Kocher Intestinal Clamp Forceps.....	299
Kocher Retractors.....	107,112,113,117
Kocher-Atrauma Intestinal Clamp Forceps.....	299
Kocher-Langenbeck Retractors.....	112
Koerte Retractors.....	109
Kogen Forceps.....	324
Konig Ligature Conductors.....	182
Krause Antrum Trocars.....	158
Krause Cutting and Grasping Forcep Tips.....	389
Krause Ear Polypus Snares.....	346
Krause Nasal Snares.....	361
Krause-Voss Ear Polypus Snares.....	346
Krayenbuhl Nerve and Vessel Hooks.....	281
Kressner Tissue Forceps.....	375
Kristeller Vaginal Retractors.....	335,336
Kristeller Vaginal Speculas.....	335,336
Kronecker Ligature Needles.....	178
Kronfeld.....	395
Kronfeld Suture Forceps.....	404

## L

Laborde Trachea Dilators.....	291
Lacrimal Dilators.....	398
Lahay Goiter Seizing Forceps.....	292
Lahey Artery Forceps.....	69
Lambert Chalazion Forceps.....	405
Lambert-Kay Atrauma Cardiovascular Forceps.....	264
Lambotte Bone Chisels.....	204
Lambotte Bone Holding Forceps.....	230
Lambotte Periosteal Raspatories.....	219
Lamina Spreaders.....	282
Laminectomy Rongeurs.....	286,287
Lancaster Eye Speculas.....	392
Landolt Laminectomy Rongeurs.....	287
Lane Bone Holding Forceps.....	231
Lane Tissue Forceps.....	77
Lang Curettes.....	397
Lang Approximation Forceps.....	183
Lang Cutting and Grasping Forcep Tips.....	389
Langenbeck Amputating Knives.....	27
Langenbeck Bone Holding Forceps.....	229
Langenbeck Ear Curettes.....	354
Langenbeck Elevators.....	221
Langenbeck Knives.....	28
Langenbeck Needle Holders with Tungsten Carbide Inserts.....	418
Langenbeck Periosteal Raspatories.....	215
Langenbeck Resection Saw.....	192
Langenbeck Retractors.....	110,111
Laryngeal Mirrors.....	390
Laryngoscope Sets.....	167,168,169
Laryngoscopes Miller Baby.....	166
Lawrence Dissecting Forceps.....	71
Lebsche Sternum Chisel.....	246
Legueu Bladder Retractors.....	314
Leksell-Stille Bone Rongeur Forceps.....	237
Lempert Bone Rongeur Forceps.....	233
Lempert Ear Curettes.....	354
Lens Expressor.....	396
Lerche Tissue Forceps.....	90
Leriche Artery Forceps.....	57
Lester Tissue Forceps.....	403
Lewin Bone Holding Forceps.....	228
Lewis Lens Expressors.....	396
Lewis Nasal Rasps.....	374
Lexer Baby Dissecting Scissors.....	36
Lexer Bone Chisels and Gouges.....	205
Lexer Scissors.....	35
Lexer-Fino Dissecting Scissors.....	36,37
Lichtenberg Needle Holder.....	176
Lichtwitz Trocars.....	158
Ligature Catcher.....	182
Ligature Conductors.....	182
Ligature Forceps.....	64,65,66,67,71
Ligature Needles.....	178,179,180
Ligature Scissors.....	50
Lister Bandage Scissors.....	186
Lister Bandage Scissors with Tungsten Carbide Inserts.....	413
Lister Sinus Polypus Forceps.....	79
Liston Amputating Knives.....	27
Liston Bone Cutting Forceps.....	238
Liston Key Bone Cutting Forceps.....	242
Littauer Cilia Forceps.....	95
Littauer Stitch Scissors.....	50
Littaur Ear Polypus Forceps.....	356
Lockhart-Mummery Probes.....	154



Lockwood Intestinal Tissue Forceps.....	295
Loops.....	355
Lordan Chalazion Forceps.....	405
Lorna Towel Forceps.....	77
Love Nerve Retractors.....	276
Love-Gruenwald Laminectomy Rongeurs.....	286
Lovelace Artery Forceps.....	59
Lovelace Organ Holding Forceps.....	253
Lower Artery Forceps.....	69
Lubet-Barbon Nasal polypus Forceps.....	362
Luc Ethmoid Forceps.....	363
Lucae Ear Dressing Forceps.....	348
Lucae Hook.....	182
Lucae Hooks.....	355
Lucae Mallets.....	208
Lucae Tuning Forks.....	345
Lucae Tympanium Needles.....	357
Luer Bone Rongeur Forceps.....	234
Luer Trachea Retractors.....	290
Luer Trachea Tubes.....	291
Luer-Koerte Gallstone Scoops.....	310
Lukens Trachea Retractors.....	289
Lung Spatula s.....	251

## M

Magil Catheter Introducing Forceps.....	165
Mallets.....	208, 209
Markwalder Bone Cutting Forceps.....	238
Marquardt Bone Rongeur Forceps.....	235
Martel Artery Forceps.....	54
Martel Conductor For Wire Saw.....	268
Martin Retractors.....	108
Martin Uterine Sound.....	332
Masing Periosteal Elevators.....	370
Masson Needle Holder.....	173
Mastin Muscular Clamps.....	292
Mathieu Needle Holders.....	176
Mathieu Needle Holders with Tungsten Carbide Inserts.....	418
Mathieu Rectal Spaculas.....	303
Mathieu Retractors.....	129
Mathieu Vaginal Specula and Retractors.....	337
Mathieu-Kocher Needle Holders with Tungsten Carbide Inserts.....	418
Mayfield Bone Rongeur Forceps.....	235
Mayo Dissecting Scissors.....	32
Mayo Harrington Scissors.....	32
Mayo Noble Scissors.....	33
Mayo Robson-Atrauma Intestinal Clamp Forceps.....	298
Mayo Russian Tissue Forceps.....	93
Mayo Scissors with Tungsten Carbide Inserts.....	411
Mayo Stille Scissors.....	32
Mayo-Blake Gall Stone Forceps.....	308
Mayo-Hegar Needle Holders.....	172, 173
Mayohegar Needle Holders with Tungsten Carbide Inserts.....	416
Mayo-Robson Intestinal Clamp Forceps.....	298
Mayo-Stille Scissors with Tungsten Carbide Inserts.....	411
McDonald Elevators.....	222
McIndoe Dissecting Forceps with Tungsten Carbide Inserts.....	415
McIndoe Dressing Forceps.....	86
McIntosh Laryngoscope Set.....	168
McKenty Periosteal Elevators.....	370
McKenzie Burrs For Hand Drills.....	195
McKenzie Clip Applying Forceps.....	270
McIvor Mouth Gags.....	379
McNaman Spatula.....	399
McReynolds Spatulas.....	399
Mead Bone Rongeur Forceps.....	233
Mead Mallets.....	209
Medicine Cups.....	423
Meeker Dissecting Forceps.....	71
Mellinger Eye Speculas.....	392
Menghini Liver puncture Needles.....	163
Meniscotomy Knives.....	226
Mercedes Retractor.....	250
Metal Catheters.....	315
Metzenbaum fine Dissecting Scissors.....	37, 38
Metzenbaum Nelson Scissors.....	35
Metzenbaum Scissors.....	34
Metzenbaum Scissors with Tungsten Carbide Inserts.....	412
Meyerdig Retractors.....	102
Meyhoefer Chalazion Curettes.....	397
Meyhoefer Chalazion Curettes.....	399
Michel Suture Clip Forceps.....	183
Michel Suture Clips.....	184
Micro Adson Tissue Forceps.....	92
Micro Ear Forceps.....	350
Micro Ear Forceps.....	350, 351, 352
Micro Ear Scissors.....	352
Micro Instruments.....	280, 281
Micro Mosquito Forceps.....	56
Micro-Adson Dissecting Forceps with Tungsten Carbide Inserts.....	414

Middeldorpf Retractors.....	113, 116
Middleton-Jansen Septum Forceps.....	366
Mikulicz Peritoneal Clamp Forceps.....	75
Mikulicz Retractors.....	126, 127
Miller Laryngoscope Set.....	167
Milligan Dura Dissectors.....	271
Milligan Retractors.....	135
Millin Bladder Retractors.....	313
Millin Prostate Clamps.....	312
Mini Adson Dressing Forceps.....	86, 92
Mini Lambotte Bone Chisels.....	204
Mini Langenbeck Retractors.....	101
Mini McGee Alligator Micro Ear Forceps.....	351
Mini-Hohmann Bone Levers.....	223
Mini-Lexer Bone Chisels and Gouges.....	205
Mirror Handles.....	390
Mixer Atery Forceps.....	68, 69
Mixer Gall Stone Forceps.....	308
Mixer O Shaughnessy.....	68
Mod.USA Umbilical Scissors.....	45
Mod.Wien Nasal Speculums.....	359
Mod-Muenchen Biopsy Curette.....	325
Moldenhauer Foreign Body Instrument.....	355
Mollison Retractors.....	134
Molt Mouth Gags.....	378
Moore Hand Drills.....	196
Moorfield Suture Forceps.....	404
Mosquito Dandy Artery Forceps.....	59
Mouth Gags.....	378, 379, 380
Moynihan Clamp Forceps.....	74
Mueller Eye Speculas.....	392
Muldoon Desmarres Lid Retractor.....	393
Multipurpose Clamps.....	257
Museux Tenaculum Forceps.....	319
Myles Nasal Cutting Forceps.....	365

## N

Nabatoff Varicose Vein Probes Set.....	155
Naegele Obstetrical Forceps.....	341
Nail Instruments.....	243
Nasal Cutting Forceps.....	364, 365
Nasal Polypus Forceps.....	362
Nasal Polypus Forceps.....	362, 363
Nasal Scissors.....	43
Nasal Snares.....	361
Nasal Speculas.....	359, 360
National Hospital Patt Hammer.....	13
Needle Holders.....	171-176
Needle Holders with Tungsten Carbide Inserts.....	416, 417, 418
Neff Meniscotomy Knives.....	226
Negus Artery Forceps.....	75
Neivert Nasal Hooks.....	373
Nelson Tissue Forceps.....	93
Nelson Trocars.....	158
Nerve Hooks.....	277
Nerve Root Retractors.....	276
Neurosurgical Scissors.....	42
Northbent Scissors.....	50
Noto Uterine Polypus Forceps.....	322
Novak Suction Curette.....	325
Noyes Iris Scissors.....	408
Nugent Forceps.....	406

## O

O' Connor Fine Retractors.....	99
Obstetrical Forceps.....	341
Obwegeser Channelled Retractors.....	383
Obwegeser Chin Retractors.....	383
Obwegeser Osteotomes.....	382
Obwegeser Periosteal Elevators.....	382
Obwegeser Ramus Retractors.....	381
Ochsner Artery Forceps.....	63
Ochsner Clamps.....	256
Ochsner Thread Forceps.....	183
Ochsner Trocars.....	158
Ogura Tissue Forceps.....	375
Oldberg Laminectomy Rongeurs.....	287
Oliverona Dura Dissectors.....	271
Oliverona Scissors.....	42
Oliverona Wire Saw.....	268
Oliverona-Toennis Clip Applying Forceps.....	270
Oliverona Brain Spatulas.....	275
Ollier Retractors.....	109
Olsen-Hegar Needle Holder.....	175
Olsenhegar Needle Holders with Tungsten Carbide Inserts.....	417
Operating Knives.....	27
Operating Scissors.....	30, 31, 34
Operating Scissors.....	46, 47
O'Sullivan-O'Connor Abdominal Retractors.....	149



O'Sullivan-O'Connor Vaginal Speculums.....	339
Otosopes.....	15
Overholt Geissenoefer Artery Forceps.....	66
Overholt Mixer Dissecting Forceps.....	64
Ovum Curettes.....	343

## P

Panas Skin Hooks.....	395
Paracentesis Needles-Knives.....	357
Park Eye Speculas.....	392
Parker Retractors.....	128
Parker-Mott Retractors.....	128
Partsch Bone Chisels and Gouges.....	203
Partsch Mallets.....	209
Payr Intestinal Stomach Clamps.....	300
Payr Ligature Conductors.....	182
Pean (Rochester) Forceps.....	62
Pean Artery Forceps.....	55
Pean Delicate Atery Forceps.....	61
Pederson Vaginal Speculums.....	334
Peers-Bertram Towel Forceps.....	77
Peet Splinter Forceps.....	96
Pelvimeters.....	341
Penfield Dura Dissectors.....	272,273
Penner Nail Forceps.....	243
Pennington Artery Forceps.....	54
Percussion Hammers.....	12, 13
Percy Amputating Retractors.....	232
Periosteal Raspatories.....	215, 216, 217, 218, 219
Peritoneal Clamp Forceps.....	75
Perthes Bone Drills.....	193
Pestalozza Ovum Curettes.....	343
Phaneuf Clamp Forceps.....	72
Pierce Periosteal Elevators.....	370
Pinard Stethoscopes.....	14
Plaster Cast Instruments.....	189,190
Plaster Knives.....	188
Plaster Saws.....	188
Plaster Shears.....	187
Plester Retractors.....	135
Pollitzer Knife.....	357
Polloson Retractors.....	123,124
Polypus And Dressing Forceps.....	79,80,81,82,83
Poole Suction Tubes.....	161
Poppen Suction Tubes.....	159
Pott Smith Vascular Scissors.....	41
Potts Atrauma Cardiovascular Forceps.....	261
Potts Smith Dressing Forceps.....	87
Potts Smith Tissue Forceps.....	91
Potts-Smith Forceps with Tungsten Carbide Inserts.....	415
Pozzi Tenaculum Forceps.....	317
Pratt Artery Forceps.....	54
Price Thomas Bronchus Forceps.....	252
Probes.....	153,154
Probes.....	398
Prostatectomy Instruments.....	312
Prostatic Retractors.....	311
Providence Hospital Artery Forceps.....	57
Putti Bone Rasps.....	207

## Q

Quatro Plaster Cast Bending Forceps.....	190
Queen Telescopic Hammer.....	13
Quinke Lumber Puncture Needles.....	163
Quire Ear Polypus Forceps.....	349,363

## R

Radolf Nail Forceps.....	243
Ragnell-Davis Retractors.....	103
Ralk Splinter Forceps.....	96
Ralks Tuning Forks.....	345
Ramley Swab Forceps.....	80,83
Ramus Retractors.....	381
Randall Kidney Stone Forceps.....	307
Randolph Cannulas.....	397
Raney Clip Applying Forceps.....	270
Razor Blade Holders and Breakers.....	20
Razors.....	28
Reamers.....	193
Recamier Uterine Curettes.....	326,327
Rectal Biopsy Spacimen Forceps.....	305
Rectal Spaculas.....	303
Rectal Spaculum.....	304
Rectum Forceps Atrauma.....	302
Reese Forceps.....	406
Reiner Plaster Knives.....	188
Resano Rectum Forceps.....	302

Resection Saws.....	192
Retractors.....	98-150
Reverdin Abdominal Spatulas.....	151
Reverdin Needles.....	177
Reynolds Scissors.....	39
Rhinoplastic Instruments.....	369,371-375
Rib Contractors.....	251
Rib Shears.....	245
Rib Spreaders.....	247,248,249,250
Ricard Abdominal Retractors.....	144
Richardson Eastmann Retractors.....	114
Richardson Retractors.....	114
Richter-Heath Suture Clip Forcep.....	183
Ring Cutter Plier Action.....	243
Ring Cutter Thumb Action.....	243
Ring Strippers.....	156
Ritter-Halle Sinus Dilators.....	373
Robb Intima Spatulas.....	266
Roberts Artery Forceps.....	65
Rochester Carmalt Artery Forceps.....	60
Roder Towel Forceps.....	76
Rogers Atrauma Hysterectomy Forceps.....	73
Rose Trachea Retractors.....	290
Roser-Konig Mouth Gag.....	378
Ross Retractors.....	122
Round Bowls.....	423
Roux Retractors.....	128
Rowe Disimpaction Forceps.....	384
Rubin Septum Forceps.....	366
Rumal Artery Forceps.....	67
Ruskin Bone Rongeur Forceps.....	235
Ruskin-Liston Bone Cutting Forceps.....	239
Russian Model Tissue Forceps.....	93
Ryder Needle Holders with Tungsten Carbide Inserts.....	417
Ryder-Vascular Needle Holders with Tungsten Carbide nserts.....	417

## S

Sachs Dura Dissectors.....	271,272,274
Sachs Nerve Hooks.....	277
Saenger Placenta Ovum Forceps.....	342
Safar Capsular Forceps.....	402
Safty Pins.....	420
Salenius Menisotomy Knives.....	226
Santulli Atrauma Bulldog Clamps.....	254
Sanvenero Dissecting Scissors.....	38
Sarot Artery Forceps.....	65
Satinsky Atrauma Cardiovascular Forceps.....	263
Satinsky Vascular Scissors.....	40
Satterlee Amputating Saw.....	192
Sauerbruch Bone Rongeur Forceps.....	240
Sauerbruch Retractors.....	121
Sauerbruch Rib Shears.....	246
Scalp Contour Retractors.....	132
Scalp Flap Forceps.....	342
Scalpel Blades.....	25,26
Scalpel Handles.....	21,22,23, 24
Schede Bone Curettes.....	211
Scheinmann Cutting and Grasping Forcep Tips.....	389
Schepens Desmarres Lid Retractor.....	393
Schink Dermatomes.....	28
Schmidt-Rimpler Fixation Forceps.....	403
Schmieden ligature Needles.....	178
Schmieden-Dick Ligature Needles.....	178
Schmieden-Taylor Neurosurgical Scissors.....	42
Schnidt Artery Forceps.....	59
Schnidt Tonsil Seizing Forceps.....	386
Schoenborn Trachea Retractors.....	289
Schroeder Tenaculum Forceps.....	318,319
Schroeder Uterine Scoops.....	328
Schubert Cervical Biopsy and Specimen Forceps.....	329,330
Schumacher Umbilical Scissors.....	45
Schumnecht Sickle Knife.....	357
Schumacher Cervical Biopsy and Specimen Forceps.....	331
Schumacher Cutting And Grasping Forcep Tips.....	389
Scissors with Tungsten Carbide Inserts.....	411,412,413
Scobee Desmarres Lid Retractor.....	393
Scoville Abdominal Retractors.....	149
Scoville Nerve Root Retractors.....	276
Scudder-Atrauma Intestinal Clamp Forceps.....	301
Sedillot Periosteal Raspatories.....	216
Segond Myoma Knife.....	324
Seiffert Cutting and Grasping Forcep Tips.....	389
Self Centring Bone Holding Forceps.....	231
Sellheim Obstetrical Forceps.....	341
Semb Bone Cutting Forceps.....	242
Semb Bone Holding Forceps.....	229
Semb Bone Rongeur Forceps.....	237
Semb Bronchus Forceps.....	252
Semb Periosteal Raspatories.....	217
Semken Dissecting Forceps with Tungsten Carbide Inserts.....	415
Semken Dressing Forceps.....	87
Semken Tissue Forceps.....	91



Semm Vaginal Speculums.....	334
Senn-Green Retractors.....	103
Senn-Mueller Retractors.....	103
Sensibility Instruments.....	14
Septum and Periosteal Elevators.....	370
Septum Forceps and Scissors.....	363,366
Septum Knives.....	369
Sexton Knives.....	357
Shaaf Cilia Forceps.....	95
Shaedel Towel Forceps.....	76
Shapleigh Ear Curettes.....	354
Silver Dermatomes.....	28
Simon Biopsy Curette.....	325
Simon Bone Curettes.....	213
Simon Retractors.....	118
Simon Uterine Scoops.....	328
Simpson Obstetrical Forceps.....	341
Simpson-Braun Obstetrical Forceps.....	341
Sims Rectal Spaculas.....	303
Sims Scissors.....	33
Sims Scissors with Tungsten Carbide Inserts.....	412
Sims Uterine Curettes.....	326,327
Sims Uterine Sound.....	332
Sims Vaginal Speculas.....	336
Singley Tuttle Tissue Forceps.....	93
Siniscal-Smith Desmarres Lid Retractor.....	393
Skene Tenaculum Forceps.....	318
Sluder-Ballenger Tonsillectomes.....	388
Smillie Menisectomy Knives.....	226
Smith Petersen Bone Chisels.....	206
Smithwick Dura Hooks.....	278
Snellen Entropium Forceps.....	406
Solution Bowls.....	424
Somer Uterine Elevating Forceps.....	323
Special Needles.....	163
Spencer Stitch Scissors.....	50
Spencerwells Artery Forceps.....	55
Sphenoid Punches.....	367
Sphenoid Punches And Rongeur Forceps.....	368
Spirit Lamp.....	422
Splinter Forceps.....	94,96
Spratt Bone Curettes.....	212
Spurling Laminectomy Rongeurs.....	286
St.Marks Retractors.....	126
Stacke Probes.....	153
Stamberg Retractors.....	377
Standard Trocars.....	158
Staud-Moore Tenaculum Forceps.....	317
Stellbrink Bone Rongeur Forceps.....	233
Sterilizing Drums.....	420
Sterilizing Forceps.....	420
Sternum Chisel.....	246
Sternum Scissors.....	246
Stethoscopes.....	14
Stevens Hooks.....	395
Stevens Iris Forceps.....	401
Stieglitz Splinter Forceps.....	96
Stille Bone Chisels and Gouges.....	204
Stille Bone Rongeur Forceps.....	236
Stille Dressing Forceps.....	86
Stille Hand Drills.....	194
Stille Plaster Shears.....	187
Stille Tissue Forceps.....	90
Stille-Liston Bone Cutting Forceps.....	241
Stille-Luer Bone Rongeur Forceps.....	237,240
Stille-Ruskin Bone Rongeur Forceps.....	236
Stille-Sherman Hand Drills.....	194
Stomach Clamps.....	300
Stone Tissue Forceps.....	90
Strabismus Scissors.....	48
Strandell-Stille Retractors.....	104
Stratte Needle Holder.....	175
Struempel Ear Polypus Forceps.....	349
Strully Neurosurgical Scissors.....	42
Struycken Nasal Cutting Forceps.....	365
Suction Biopsy Curettes.....	325
Suction Tubes.....	159,160,161
Suture Forceps.....	404
Suture Instruments.....	183
<b>T</b>	
Takahashi Nasal Cutting Forceps.....	364
Tangential Forceps.....	70
Taylor Abdominal Retractors.....	149
Taylor Bone Levers.....	225
Taylor Dressing Forceps.....	87
Taylor Hammer.....	12
Taylor Tissue Forceps.....	91
Teale Tenaculum Forceps.....	320
Tenaculum Forceps.....	317,318,319,320,321
Tenotomy Scissors.....	408
Tenotomy Scissors.....	48
Thomas-Gaylor Cervical Biopsy and Specimen Forceps.....	330
Thomson-Walker Bladder Retractors.....	314
Thorek Dissecting Scissors.....	36
Thudichum Nasal Speculums.....	360
Tieck-Halle Nasal Speculums.....	359
Tissue and Organ Holding Forceps.....	253,294,295,296
Tissue and Organ Holding Forceps.....	294,295,296
Tissue Forceps.....	403
Tissue Forceps.....	89,90,91,92,93
Tissue Forceps Atrauma.....	88
Tissue Holding Forceps.....	53,54
Tobold Tongue Depressor.....	377
Toensil Adson Neurosurgical Scissors.....	42
Toennis Dura Dissectors.....	271
Toennis Knives.....	278
Toennis Needle Holder.....	176
Toennis Needle Holders with Tungsten Carbide Inserts.....	418
Toennis Nerve Hooks.....	277
Tohoku Towel Forceps.....	77
Tong Holding Forceps.....	378
Tongue Depressors.....	377
Tonsil Knives.....	385
Tonsil Scissors.....	43
Tonsil Seizing Forceps.....	386
Tonsil Seizing Forceps.....	386
Tonsil Snare.....	387
Tonsillectomes.....	388
Towel Forceps.....	76,77
Toynbee Ear Speculas.....	347
Trachea Dilators.....	291
Trachea Retractors.....	289,290
Trachea Tubes.....	291
Trocars.....	289
Troeltsch Ear Dressing Forceps.....	348,361
Trochars.....	158
Trousseau Trachea Dilators.....	291
Troutman Chris Razor Blade Breakers.....	20
Troutman Chris Razor Blade Holders.....	20
Tubing Clamps.....	78
Tuffier Artery Forceps.....	53
Tuffier Rib Spreaders.....	249
Tumor Forceps.....	82,83
Tuning Forks.....	345,346
Tuohy Lumber Puncture Needles.....	163
Tyding Tonsil Snare.....	387
<b>U</b>	
Uckermann Trocars.....	289
Ulrich Cotton Swab Forceps.....	79
Umbilical cord Clamps.....	342
Umbilical Scissors.....	45
Universal Handles.....	389
Universal Scissors.....	49
Universal Scissors with Tungsten Carbide Inserts.....	413
Universal Trocars.....	158
Uro-Tangential Forceps.....	70
US Army Retractors.....	129
Uterine Curettes.....	326
Uterine Dilators.....	331,332
Uterine Elevating Forceps.....	323
Uterine Polypus Forceps.....	322
Uterine Scoops.....	328
<b>V</b>	
Vaginal Forceps.....	72,74
Vaginal Retractors.....	335-339
Vaginal Speculas.....	333-339
Valleix Uterine Sound.....	332
Van Buren Dilating Bougies.....	315
Van Doren Cervical Biopsy and Specimen Forceps.....	330
Vannas Iridectomy Scissors.....	408
Vascular Dilators.....	265
Veidenheimer Rectum Forceps.....	302
Venenhaken Brom Retractors.....	104
Verbrugge Bone Holding Forceps.....	232
Veress Pneumoperitoneum Needles.....	163
Vernon Hammer.....	13
Vickers Elevators.....	222
Vickers Fine Retractors.....	98
Virchow Brain Knives.....	19
Volkman Retractors.....	105,106
Volkmann Bone Curettes.....	210,211,214
Vollmar Ring Strippers.....	156
Voltoilini Nasal Speculums.....	360
<b>W</b>	
Wachenfeldt Suture Clip Forceps.....	183

Wagener Hook.....	355
Wagner Scissors.....	46
Walb Postmortem Knives.....	19
Waldmann Scissors.....	44
Walter Osteotomes.....	371
Wangenstein Needle Holder.....	174
Wartenberg Pinwheel.....	14
Wassmund Retractors.....	109
Watch Maker No. 3&7.....	92
Weber Lens Expressors.....	396
Webster Needle Holder.....	171
Webster Needle Holders with Tungsten Carbide Inserts.....	416
Wecker Iris Scissors.....	408
Weilblakesley Nasal Cutting Forceps.....	364
Weiss Eye Speculas.....	392
Weitlaner Retractors.....	132,134
Weitlaner-Baby Retractors.....	135
Weitlaner-Wullstein Retractors.....	134
Wells Enucleation Spoon.....	396
Wertheim Cullen Clamp Forceps.....	72,74
Westcott Tenotomy Scissors.....	407
Westmacott Tampon Forceps.....	362
Wheeler Spatula.....	399
White Tonsil Seizing Forceps.....	386
Wickstrom Artery Forceps.....	69
Wieder Tongue Depressor.....	377
Wiener Hooks.....	395
Wilder Lacrimal Dilators.....	398
Williams Eye Speculas.....	392
Williams Intestinal Tissue Forceps.....	295
Williger Bone Curettes.....	211,214
Williger Elevators.....	221
Williger Mallets.....	208
Williger Periosteal Raspatories.....	218
Winter Placenta Ovum Forceps.....	342
Winterton Vaginal Speculum.....	334
Wire Cutting Pliers.....	198,199
Wire Cutting Pliers With TC Inserts.....	199,200
Wire Scissors.....	49
Wolff Plaster Cast Bending Forceps.....	190
Wullstein Micro Ear Scissors.....	352
Wullstein Sickle Knives.....	357
Wullstein Suction Tubes.....	159

## Y

Yankauer Suction Tubes.....	160
Yankauer Universal Suction Tubes.....	160
Yasargil Laminectomy Rongeurs.....	287
Yasargil Suction Tubes.....	159
Yasargil Micro Knives.....	280,281
Young Prostatic Retractors.....	311
Young Tongue Holding Forceps.....	378

## Z

Zaufal Foreign Body Instrument.....	355
Zaufal-Jansen Bone Rongeur Forceps.....	235
Zenker Retractors.....	112
Ziegler Lacrimal Probes.....	398