

SIGN MART

Supplies & Fabrications

2026

CATALOG



Table of Contents

1 - 9	Vinyl Films
10 - 32	Digital Media
33 - 39	Lamination
40 - 43	Heat Transfer
44 - 53	Adhesives and Tape
54 - 58	Regulatory Signs
59 - 64	Real Estate
65 - 110	Sign Stands and Displays
111 - 149	Supplies and Tools
150 - 159	Banners and Flags
160 - 165	Equipment
166 - 171	Substrates

SIGNMART

How to Order

Please Call, Email or Fax your order Monday thru Friday 8am - 5pm or Saturday 9am - 12:30pm PST. We will respond as quickly as possible to all orders. Quotes and inquiries.

Toll Free

1-800-533-9099

Local

1-714-532-7100

Fax

1-714-744-0077

Prices and Products

All prices are WHOLESALE and are for Trade only. PRODUCT SPECIFICATIONS AND PRICING MAY CHANGE WITHOUT NOTICE.

Order Changes

Any Order changes made during production must be in writing. This can both delay final completion date and incur addition costs.

Sales Tax

California customers will be charged state tax, unless a valid exemption certificate is on file with all your current company information. Tax I.D. numbers will not be accepted

Email

Info@sign-mart.com

sales@sign-mart.com

Orders@sign-mart.com

Website / Online Orders

www.sign-mart.com

Payment Methods

All orders are **C.O.D.** unless other arrangements are made at the time of the order. Some orders may require a 50% deposit at the time of order. Sign-Mart accepts Visa, MasterCard, Discover, Company check and cash.

Return Policy

If an item is to be returned call 800-533-9099 and ask for your sales person. You must have an RMA (return material authization) number before sending any items back to us. RMA numbers are good for 7 days from the date it is issued. Please furnish the invoice number and date.

Item returned that are not due to our error will be subject to a 25% restocking fee.

You must inform us about defects, shortages and exceptions within 5 days or orders will be considered complete. There are no returns after 15 days, unless approved by management. Any changes in the return policy must be approved by management

Technical Support

Our staff of factory trained technicians are ready to assist you please call, email Monday thru Friday 8am - 5pm or Saturday 9am - 12:30pm PST. We will respond as quickly as possible.

Customer Supplied Material

Sign-Mart welcomes work produced or cut on customer supplied materials and will discount our prices accordingly. However, **SIGN-MART WILL NOT ACCEPT RESPONSIBILITY FOR RE-PLACEMENT MATERIALS DUE TO ERRORS OR COMPUTER FAILURE BEYOND OUR CONTROL.** Excess material should always be supplied to ensure complete order.

Shipping

Standard shipping for most orders is **UPS** unless otherwise requested. Shipping and handling rates are based on order weight and UPS zones. We are not responsible for FedEx or other carrier errors. **IF CRATING OR SPECIAL PACKAGING IS REQUIRED FOR PROPER SHIPPING, CUSTOMERS WILL BE CHARGED ACCORDINGLY.** FedEx will not accept cash for a COD order. Payments can be made with a company check or money order

Ground Time-in-Transit Map for UPS

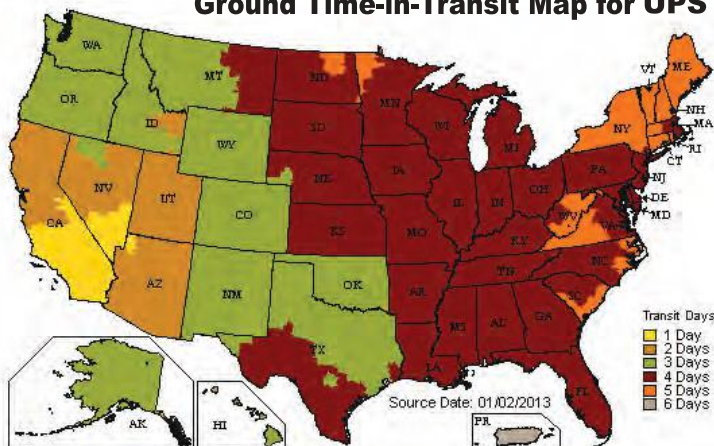



We aim to be your single, trusted source for sign supplies, fabrication, service, and expert advice.

To Our Valued Customers,

Over the last 48 years of service to the sign and graphics industries, Sign-Mart has grown and diversified into one of the most complete graphic / sign production facilities in the country, offering you a truly single source for all your graphics and sign requirements. Our new catalog is the most extensive accumulation of supplies, banner and fabrication information Sign-Mart has ever assembled. We hope our “Best Single Source” motto is reflected in our new catalog. Your comments are always welcomed and appreciated.

Today, as one of new owners and CEO, I’m honored to carry forward the legacy built by Gene Sobel and the incredible team that shaped Sign Mart’s foundation. Our mission remains clear to empower sign professionals with the highest quality products, cutting-edge technology, and unmatched service. We continue to innovate, expand, and support our customers—because at Sign Mart, your success is our sign of excellence.

*Yours Truly,
JD Savaliya, CEO*





Series
631

Exhibition Calendered Matte

Oracal 631 Series is a 3mil. 3 year calendered PVC film with a residue free adhesive, removable up to 2 years.

Formulated for short term and medium term applications as well as display, trade shows and point of sale application.

- ☒ 000 Transparent
- ☐ 010 White
- 019 Signal Yellow
- 020 Golden Yellow
- 021 Yellow
- 022 Light Yellow
- 025 Brimstone Yellow
- 030 Dark Red
- 031 Red
- 032 Light Red
- 034 Orange
- 047 Orange Red
- 035 Pastel Orange
- 036 Light Orange
- 040 Violet
- 041 Pink
- 042 Lilac
- 043 Lavender
- 045 Soft Pink
- 049 King Blue
- 050 Dark Blue
- 051 Gentian Blue
- 098 Gentian
- 052 Azure Blue
- 053 Light Blue
- 392 Dahlia
- 391 Persimmon
- 430 Lip Stick
- 428 Bubble Gum
- 173 Geyser Blue
- 172 Powder Blue
- 054 Turquoise
- 055 Mint
- 056 Ice Blue
- 057 Traffic Blue
- 060 Dark Green
- 061 Green
- 062 Light Green
- 063 Lime Tree Green
- 064 Yellow Green
- 066 Turquoise Blue
- 070 Black
- 071 Grey
- 072 Light Grey
- 073 Dark Grey
- 074 Medium Grey
- 080 Brown
- 081 Light Brown
- 082 Beige
- 083 Nut Brown
- 086 Brilliant Blue
- 090 Silver Grey
- 091 Gold
- 092 Copper
- 174 Teal
- 429 Carnation Pink
- 493 Olive
- 494 Celadon
- 495 Key Lime Pie
- 752 Storm Grey
- 751 Warm Grey
- 838 Maize

Size	Black White Transparent	Colors	Metallics
24" x 50yds	\$113.99	\$127.99	\$149.99
30" x 50yds	\$144.99	\$159.99	\$186.99
48" x 50yds	\$224.99	\$261.99	\$307.99

Revised 5-2025



Intermediate Gloss Vinyl

Another
SIGNMART
Exclusive



PRICE | VALUE | QUALITY

- Superior weeding and cutting
- 2.7 mil Intermediate with up to 5 year durability

- ☒ 503 Transparent •
- ☐ 501 White •
- 502 Black •
- 505 Grey ▲
- 506 Midnight Blue ▲
- 508 Sapphire Blue •
- 510 Vivid Blue •
- 513 Ocean Blue ▲
- 514 Olympic Blue ▲
- 515 Sky Blue ▲
- 516 Teal ▲
- 517 Dark Green ▲
- 518 Forest Green ▲
- 519 Green •
- 520 Kelly Green ▲
- 522 Sunflower Yellow ▲
- 523 Lemon ▲
- 524 Yellow •
- 530 Brown ▲
- 531 Beige ▲
- 534 Burgundy ▲
- 536 Dark Red ▲
- 537 Cherry Red •
- 538 Tomato Red •
- 541 Pink ▲
- 544 Orange ▲
- 546 Purple ▲
- 548 Plum ▲
- 550 Gold •
- 551 Silver •

- Available in 15" / 24" / 30" & 60"
- ▲ Available in 24" only

Revised 5-2025

Black/White

15" x 50yds	\$ 68.99
24" x 50yds	\$108.99
30" x 50yds	\$135.99
60" x 50yds	\$271.99

Colors/Transparent

15" x 50yds	\$ 78.99
24" x 50yds	\$119.99
30" x 50yds	\$141.99
60" x 50yds	\$282.99



Series **651**

Intermediate Vinyl Glossy

[MORE INFO AT THE BOTTOM OF THE PAGE]

Up to 6 year durability / calendered. Orafol series 651 has become the industry standard for high performance calendered films at only 2.5 mil thick. Flexibility, thermal print compatibility and a choice of over 60 colors are available. This high quality film is a good choice for moderately complex jobs that don't require the extra conformability provided by cast films.

	000 Transparent [...]		098 Gentian
	010 White [.. ...]		052 Azure Blue
	020 Golden Yellow [...]		084 Sky Blue [• 24"]
	019 Signal Yellow [• 24"]		053 Light Blue
	021 Yellow [...]		056 Ice Blue [• 24"]
	022 Light Yellow [• 24"]		066 Turquoise Blue
	025 Brimstone Yellow [• 24"]		054 Turquoise [• 24"]
	026 Purple Red [24"]		055 Mint [• 24"]
	312 Burgundy [...]		060 Dark Green [• 24"]
	030 Dark Red [• 24"]		613 Forest Green
	031 Red [...]		061 Green
	032 Light Red		068 Grass Green [• 24"]
	047 Orange Red [• 24"]		062 Light Green
	034 Orange		064 Yellow Green [• 24"]
	036 Light Orange [• 24"]		063 Lime Tree Green
	035 Pastel Orange [• 24"]		080 Brown
	404 Purple		083 Nut Brown [• 24"]
	040 Violet		081 Light Brown [• 24"]
	043 Lavender [• 24"]		082 Beige [• 24"]
	042 Lilac [• 24"]		023 Cream [• 24"]
	041 Pink		070 Black [.. ...]
	045 Soft Pink [• 24"]		073 Dark Grey [• 24"]
	562 Deep Sea Blue [• 24"]		071 Grey
	518 Steel Blue [• 24"]		076 Telegrey [• 24"]
	050 Dark Blue [• 24"]		074 Middle Grey [• 24"]
	065 Cobalt Blue [• 24"]		072 Light Grey
	049 King Blue [...]		090 Silver Grey (metallic) [...]
	086 Brilliant Blue		091 Gold (metallic) [...]
	067 Blue [• 24"]		092 Copper (metallic) [• 24"]
	057 Traffic Blue [...]		824 Imitation Gold
	051 Gentian Blue [• 24"]		341 Coral

Black | White | Transparent *Revised 5-2025*

Size	Cost	
15" x 10yds	\$ 23.99	PUNCHED
15" x 50yds	\$ 72.99	PUNCHED
24" x 10yds	\$ 32.99	
24" x 50yds	\$115.99	
30" x 10yds	\$ 38.99	
30" x 50yds	\$144.99	
48" x 10yds	\$ 67.99	
48" x 50yds	\$235.99	

Colors *Revised 5-2025*

Size	Cost	
15" x 10yds	\$ 27.99	PUNCHED
15" x 50yds	\$ 77.99	PUNCHED
24" x 10yds	\$ 36.99	
24" x 50yds	\$127.99	
30" x 10yds	\$ 41.99	
30" x 50yds	\$151.99	
48" x 10yds	\$ 74.99	
48" x 50yds	\$265.99	

Metallics 090 - 091 - 092 *Revised 5-2025*

Size	Cost	
15" x 10yds	\$ 28.99	PUNCHED
15" x 50yds	\$ 98.99	PUNCHED
24" x 10yds	\$ 39.99	
24" x 50yds	\$140.99	
30" x 10yds	\$ 50.99	
30" x 50yds	\$177.99	
48" x 10yds	\$ 89.99	
48" x 50yds	\$310.99	

[1 • only available in 24" x 10yds and 24" x 50yds] [2 •• available in matte] [3 ••• available in 48"]



Series 751



High Performance Cast 2 mil up to 8 year Durability

- | | |
|-------------------------|----------------------------------|
| ☒ 000 Transparent [•] | 086 Brilliant Blue |
| ☐ 010 White [• • • •] | 536 Middle Blue |
| 020 Golden Yellow | 067 Blue |
| 021 Sun Yellow | 057 Traffic Blue |
| 019 Signal Yellow | 051 Gentian Blue |
| 021 Yellow [•] | 052 Azure Blue [•] |
| 022 Light Yellow | 517 Euro Blue |
| 025 Brimstone Yellow | 053 Light Blue |
| 023 Cream | 056 Ice Blue |
| 018 Light Ivory | 608 Petrol |
| 026 Purple Red | 066 Turquoise Blue |
| 030 Dark Red | 054 Turquoise |
| 031 Red [• • •] | 055 Mint |
| 027 Tomato Red | 060 Dark Green [•] |
| 028 Cardinal Red [•] | 078 Foliage |
| 032 Light Red | 617 Emerald |
| 324 Blood Red | 607 Turquoise Green |
| 325 Middle Red | 061 Green [•] |
| 326 Signal Red | 068 Grass Green |
| 047 Orange Red | 062 Light Green |
| 033 Red Orange | 064 Yellow Green |
| 034 Orange | 063 Lime Tree Green |
| 035 Pastel Orange | 080 Brown |
| 048 Bordeaux | 079 Red Brown |
| 040 Violet | 083 Nut Brown |
| 403 Light Violet | 081 Light Brown |
| 043 Lavender | 070 Black [• • • •] |
| 042 Lilac | 720 Komatsu Grey |
| 041 Pink | 093 Anthracite (metallic) |
| 077 Telemagenta | 073 Dark Grey |
| 044 Magenta | 713 Iron Grey |
| 045 Soft Pink | 071 Grey |
| 532 Black Blue | 721 Slate Grey |
| 518 Steel Blue | 076 Telegrey |
| 050 Dark Blue | 074 Middle Grey |
| 058 Ultramarine Blue | 072 Light Grey |
| 537 Deep Blue | 090 Silver Grey (metallic) [•] |
| 065 Cobalt Blue | 930 New Gold (metallic) [•] |
| 049 King Blue [• • •] | 824 Imitation Gold |

Size	Black White	Colors	Metallic
15" x 10yds	\$ 40.99	\$ 45.99	\$ 51.99
15" x 50yds	\$146.99	\$172.99	\$188.99
24" x 10yds	\$ 64.99	\$ 71.99	\$ 78.99
24" x 50yds	\$239.99	\$277.99	\$299.99
30" x 10yds	\$ 78.99	\$ 88.99	\$ 98.99
30" x 50yds	\$294.99	\$340.99	\$404.99
48" x 10yds	\$128.99	\$145.99	
48" x 50yds	\$481.99	\$581.99	

Revised 5-2025

AVERY 950

Ultimate Cast Opaque 2 mil.

- Smooth surface with a higher gloss for a paint-like finish
- Permanent adhesive with options for long-term removability
- Enhanced conformability without the need for primer for easy installation
- Outdoor durability of up to 12 years (black & white) and 10 years (colors)
- 83# kraft liner for more efficient sign cutting and a smoother backside to help retain film gloss

- | | |
|---|--|
|  A134725 Tomato Red |  A134728 Fire Red |
|  A022646 White |  A134712 Medium Yellow |
|  A134802 Palm Oyster |  A134812 Dark Beige |
|  A134701 Gloss Black |  A134758 Butterfly Blue |

Size	Black White	Colors	
15" x 10yds	\$ 50.99	\$ 56.99	PUNCHED

Revised 5-2025

[• available in 50 yards] [•• available in matte] [••• available 48"



Series
7510

Fluorescent Films

With the longest outdoor durability rating in the industry (2 YEARS) this premium cast, high-gloss fluorescent film is ideal for graphics requiring special, high impact visibility. ORAFOL® 7510 is a cast film with excellent cutting, weeding, application and conformability characteristics. Especially effective in twilight and poor visibility conditions, it's ideal for short term vehicle and bus advertising, point-of-purchase displays, labels, decals, and other retail applications.

- 029 Fluorescent Yellow
- 038 Fluorescent Red Orange - 1 year durability
- 039 Fluorescent Red
- 046 Fluorescent Pink - 1 year durability
- 069 Fluorescent Green

Size Cost

15" x 10yds	\$ 131.99	PUNCHED
15" x 50yds	\$ 522.99	PUNCHED
30" x 10yds	\$ 264.99	PUNCHED
30" x 50yds	\$1053.99	PUNCHED

Revised 5-2025



Series
8500

Translucent 3mil High Performance Film

This high performance calendered film features the lowest shrinkage of any translucent film. Orafol 8500 has been especially designed for producing high quality illuminated signs on rigid surfaces. Available in 55 vivid colors.

• Additional colors can be special ordered

- 010 White
- 049 King Blue
- 020 Golden Yellow
- 066 Turquoise Blue
- 031 Red
- 068 Grass Green
- 030 Dark Red
- 060 Dark Green
- 052 Azure Blue
- 074 Middle Grey
- 051 Gentle Blue
- 090 Silver
- 005 Middle Blue
- 091 Gold



Size Cost

15" x 1yds	\$ 12.99	PUNCHED
15" x 10yds	\$ 63.99	PUNCHED
15" x 50yds	\$220.99	PUNCHED
30" x 1yd	\$ 20.99	
30" x 10yds	\$127.99	
30" x 50yds	\$439.99	

Revised 5-2025



Series
651

Glossy Intermediate Metallic Vinyl

- 4 year Durability
- Thermal print compatible
- Gloss intermediate calendered vinyl

Orafol Series 651 has become the industry standard for high performance calendered films. This high quality 2.5mil thick film also offers flexibility and is a good choice for moderately complex jobs that do not require the extra conformability provided by our cast films.

- 091 Gold
- 090 Silver Grey

Revised 5-2025

15" x 10yds	\$ 28.99	PUNCHED
15" x 50yds	\$ 98.99	PUNCHED
24" x 10yds	\$ 39.99	
24" x 50yds	\$ 140.99	
30" x 10yds	\$ 50.99	
30" x 50yds	\$ 178.99	
48" x 10yds	\$ 89.99	
48" x 50yds	\$ 310.99	



2.7 mil Intermediate with up to 5 year durability, superior weeding and cutting.

- Gold
- Silver

Revised 5-2025

15" x 50yds	\$ 56.99
24" x 50yds	\$ 90.99
30" x 50yds	\$ 112.99
60" x 50yds	\$ 209.99



Series
751

Glossy High Performance Cast Metallic Film

- 7 year durability
- Thermal print compatible

This value priced 2mil cast film offers impressive cutting and weeding properties as well as minimal shrinkage for durable and dimensionally stable applications such as architectural signage, vehicle and fleet graphics. Applies well to irregular surfaces, including corrugations and rivets.

- 090 Silver Grey
- 930 New Gold

15" x 10yds	\$ 51.99	PUNCHED
15" x 50yds	\$188.99	PUNCHED
24" x 10yds	\$ 78.99	
24" x 50yds	\$299.99	
30" x 10yds	\$ 98.99	
30" x 50yds	\$404.99	

Revised 5-2025



Cast Metallic High Performance

951 is a 2 mil. Cast High Performance vinyl with an outdoor durability of up to 3 - 10 years depending on colors (See Tech data sheet on website for more details). Specially designed for use with computer-aided sign making (CAS) equipment for the widest array of applications including those with high durability requirements. Ideal for high quality vehicle and fleets graphics. It's a conformable film, especially suitable for uneven and curved surfaces; as well on corrugations and rivets.

- 091 Gold
- 192 Deep Blue
- 196 Night Blue
- 197 Azure Blue
- 406 Violet
- 704 Black
- 906 Silver
- 908 Aluminum
- 935 Cast Iron
- 937 Charcoal
- 676 Wood Green
- 679 Foliage Green
- 367 Red

Size 24" x 10 yds
\$115.99 | 10-951-24 + COLOR #

Revised 5-2025

Nikkalite

Reflective

Prismatic High Intensity White

Designed for use on:

- Construction zone devices
- Up to 10 year mfg. warranty
- Permanent traffic control signs

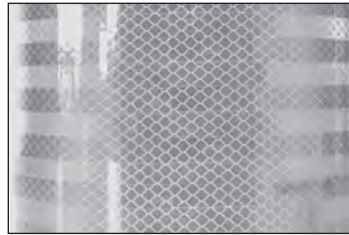

UV, Eco-Solvent and Latex

Please note if there is a line through the material, This is not a defect. IT IS PART OF THE MANUFACTURING PROCESS.

24" x 1 Foot	\$ 9.99	#PH2401
24" x 10yds	\$ 163.99	#PH2410
24" x 50yds	\$ 711.99	#PH2450
48" x 1 Foot	\$ 14.99	#PH4801
48" x 10yds	\$ 285.99	#PH4810
48" x 50yds	\$1354.99	#PH4050

Revised 5-2025

Nikkalite

Reflective

Reflective

- 5mil thickness
- **7 year durability**
- Engineer grade I
- For flat surfaces only
- Thermal or screen printable

- T1500 White
- T1505 Blue
- T1501 Yellow
- T1507 Green
- T1502 Red
- T1508 Black
- T1504 Orange

Revised 5-2025

Size	2 yard min Cost per yard	10 yards	50 yards
15"	\$ 7.99	\$ 66.99	\$288.99
24"	\$10.99	\$100.99	\$430.99
48"	\$19.99	\$182.99	\$792.99



5600 Reflective

- **7 year durability**
- 5mil Engineering grade
- Ideal for applications over curved surfaces rivets and corrugations
- Use with Oraguard 290 | 290GF | 293

Solvent | Latex | Eco Solvent | Screen Print

- 010 White
- 020 Yellow
- 070 Black
- 035 Orange
- 091 Gold
- 030 red
- 060 Green

Size Cost Revised 5-2025

15" x 10yds	\$146.99	PUNCHED
15" x 50yds	\$581.99	PUNCHED

Meets ASTM D 4956 specifications for Type 1 | Class 1 retroreflective sheeting



5650RA Reflective

- 5 mil
- White reflective
- Not for wet application
- 7 year outdoor durability
- 89lb PE coated silicone paper
- Meets or exceeds Federal Specifications ASTM D 4956
- Print compatibility: Solvent, Eco Solvent, UV, Latex and Screen Print
- Clear repositionable, solvent based, permanent adhesive with air release
- Clean removability for up to 4 years

Size Cost Item #

30" x 10yds	\$ 321.99	5650RA30-10
54" x 10yds	\$ 583.99	5650RA54-10
30" x 50yds	\$1938.00	5650RA30-50
54" x 50yds	\$2161.99	5650RA54-50

cast PVC reflective film

Revised 5-2025



ORALUX 9300 Luminescent Cast



Create long - lasting, glow-in-the-dark indoor safety and emergency exit signage with Series 9300. This 6-mil, 5 - year off - white film features a multi -layered, cadmium - free PVC gloss surface with a permanent, solvent-based adhesive. Series 9300 is great for indoor safety and exit signage in buildings, cruise ships, and airplanes.

Item #9300 - 48 - 1
48" x yds | \$ 77.99

Item #9300 - 48 - (25)
48" x 25 yds | \$1664.99

Revised 5-2025



Water based Permanent Adhesive
Up to 5 Year
Outdoor Durability

- Fine Brushed Silver
- Fine Brushed Gold
- Large Engine Turn Silver
- Large Engine Turn Gold
- Sequins Silver
- Coarse Brushed Silver
- Small Engine Turn Silver
- Small Engine Turn Gold
- Chrome Polish Silver
- Chrome Polish Gold
- Rainbow Silver
- Textured Leaf Silver
- Textured Leaf Gold
- Holo Glitter Silver

Size	Cost	
24" x 1 Foot	\$ 3.99	SILVER
24" x 10yds	\$ 65.99	SILVER
24" x 50yds	\$283.99	SILVER
24" x 1 Foot	\$ 4.99	GOLD
24" x 10yds	\$ 75.99	GOLD
24" x 50yds	\$326.99	GOLD

Revised 5-2025

**[DO NOT WET APPLY
 ANY METALIZED VINYL]**



Series
Ultraleaf 383

Cast 3.5mil, 5 year film is a cost effective alternative to 24 karat gold or silver leaf film. It features a three dimensional visual texture surface. The durable dimensional stability of this film makes it ideal for lettering, vehicles marking, window decoration and signs requiring long term outdoor durability.



Gold Leaf	Cost	
15" x 1ft	\$ 17.99	GL10ft
15" x 10yds	\$158.99	GL10
15" x 50yds	\$619.99	GL50

Silver Leaf	Cost	
15" x 1ft	\$ 17.99	SL10ft
15" x 10yds	\$158.99	SL10
15" x 50yds	\$619.99	SL50

Revised 5-2025



Genuine Gold Vinyl

- 10-14 year Exterior Life
- Durable, won't delaminate or fade
- 1 mil thick conforms easily to rivets and other irregular surfaces

- SG1-FS-02
15" Florentine Swirl
- SG1-FS-42
24" Florentine Swirl
- SG1-SET-02
15" Small Engine Turn
- SG1-LET-02
15" Large Engine Turn
- SG1-LET-42
24" Large Engine Turn
- SG1-XLET-02
15" XL Engine Turn

15" x 2yds	\$330.99	Punched
24" x 2yds	\$529.99	Unpunched

Revised 12-2025

Easy Dot Chalkboard Film

- Wet and dry cleaning
- Works with both chalk and liquid chalk
- Designed for frequently changing lettering
- Dot shaped adhesive allows easy and bubble free positioning
- Designed for Schools, Offices, Restaurants, Hotels, Retail, Conference Rooms and more
- **Printable with Eco-Solvent, Solvent, UV and Latex but printer must be able to print with White Ink**

\$9.99 [by the foot] | Item #EDCBF

54" x 98' | **\$378.99** | Item #EDCB

Revised 5-2025



**UP TO 5 YEAR
 DURABILITY WHEN
 APPLIED VERTICALLY
 INDOORS**

Specialty Vinyl



- 2mil Polyester
- Recommended use on Flat Surfaces

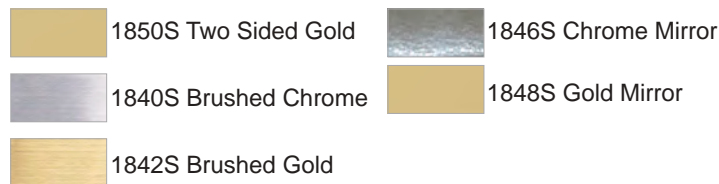

Revised 5-2025

Size		Cost
15" x 10yds	Gold Mirror	\$ 80.99
15" x 10yds	Brushed Chrome	\$ 68.99
15" x 50yds	Brushed Chrome	\$307.99
15" x 10yds	Brushed Gold	\$ 96.99
15" x 50yds	Brushed Gold	\$400.99
15" x 10yds	2 Sided Gold	\$144.99
15" x 10yds	Chrome Mirror	\$ 61.99
15" x 50yds	Chrome Mirror	\$254.99

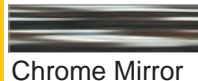

Chrome Mirror

Revised 5-2025

Chrome Mirror 1mil	Cost	
15" x 10yds	\$ 35.99	PUNCHED
15" x 50yds	\$118.99	PUNCHED
24" x 10yds	\$ 53.99	
24" x 50yds	\$211.99	
30" x 10yds	\$ 65.99	
30" x 50yds	\$261.99	

Oracal 352

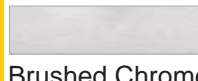

Brushed Chrome

Revised 5-2025

Brushed Chrome 2mil	Cost	
15" x 10yds	\$ 76.99	PUNCHED
15" x 50yds	\$278.99	PUNCHED
24" x 10yds	\$116.99	
24" x 50yds	\$432.99	
30" x 10yds	\$146.99	
30" x 50yds	\$584.99	



Glass Deco with Air Release for easy installation

- Printable 3 mil
- Indoor use 10 years
- Outdoor use 7 years
- Suitable for cutting plotters
- Digital printing with (Eco) solvent | Latex | UV inks
- Decoration and labelling film
- Nearly residue and tear free removal
- Dry install with no bubbles or wrinkles
- Installs 50% faster than wet apply films

6039784 - Glass Deco Frosted sand blasted glass finish

Size	Cost	Size	Cost
27" x 41'	\$ 113.99	54" x 41'	\$216.99
27" x 82'	\$216.99	54" x 82'	\$410.99
27" x 164'	\$391.99	54" x 164'	\$745.99

6039785 - Glass Deco Dusted milk-glass finish

Size	Cost	Size	Cost
27" x 24'	\$ 103.99	54" x 24'	\$164.99
27" x 49'	\$168.99	54" x 49'	\$262.99
27" x 98'	\$273.99	54" x 98'	\$479.99

Revised 5-2025



Etched Cast Films

2mil films offer excellent cutting, weeding and transfer. Your productivity will increase as you realize the benefits of fast, more consistent weeding, even the smallest characters.

- 121 Etched
- 125 Diamond Etched

GREAT PRICE | GREAT QUALITY

Etched Item #	Diamond Etched Item#	Size	Cost
1211510	1251510	15" x 10yds	\$ 63.99
1211550	1251550	15" x 50yds	\$275.99
1212410	1252410	24" x 10yds	\$ 93.99
1212450	1252450	24" x 50yds	\$407.99
1214810	1254810	48" x 10yds	\$179.99
1214850	1254850	48" x 50yds	\$781.99

Revised 01-2026



PAINT MASK

- White
- 3 mil series 811
- Low tac adhesive
- Use for stencils on flat, smooth, rigid surfaces

Size	Cost	Item #
15" x 10 yds	\$ 34.99	10-811-15
15" x 50 yds	\$ 93.99	811-15
24" x 10 yds	\$ 49.99	10-811-24
24" x 50 yds	\$132.99	811-24
30" x 10 yds	\$ 52.99	10-811-30
30" x 50 yds	\$158.99	811-30
48" x 50 yds	\$260.99	811-48

ALL 15" ROLLS ARE PUNCHED

Revised 5-2025



SANDBLAST MASK

- 9 mil series 831
- Great for glass, plastic and wood
- Removable water based adhesive
- Release liner - Silicone coated paper

Size	Cost	Item #
15" x 10 yds	\$ 52.99	10-831-15
15" x 50 yds	\$160.99	831-15
24" x 10 yds	\$ 80.99	10-831-24
24" x 50 yds	\$255.99	831-24
30" x 10 yds	\$ 99.99	10-831-30
30" x 50 yds	\$312.99	831-30
48" x 10 yds	\$161.99	10-831-48
48" x 50 yds	\$510.99	831-48

Revised 5-2025



Sandblast Mask



T226- 22 Mil High-Tack BlastLite™ is a specially-formulated rubber mask that is long-lasting and easy to use. Natural flexibility properties and impact resistance makes it ideal for all substrates where shallow blasting is required. BlastLite™ High-tack Stencils are coated with an acrylic adhesive for use on raw wood, unprimed HDU, brick or unglazed tile. Available punch or friction feed

15" x 10 yds	\$ 106.99	Item #84227
20" x 10 yds	\$142.99	Item #84229
25" x 10 yds	\$167.99	Item #84230
30" x 10 yds	\$201.99	Item #84233

Revised 5-2025

PROGLOVE

- Machine washable
- Touch screen friendly
- Red double stitched cuff
- Includes one pair (two gloves)
- Available in (S) (L) and (XL) sizes
- Superior breathability to keep hands cool and sweat free
- Reinforced stitching in the valley of the index finger & thumb



Item #PROG (S) | Item #PROG (LG) | Item #PROG (XL)

\$20.99 each pair | 2 pairs for \$18.99 each *Revised 5-2025*

PROSQUEEGEE



Includes:
One wet PROBUFFER strip
One dry PROBUFFER strip



Revised 5-2025

\$16.99 each | Item #PROPS

PROBUFFER

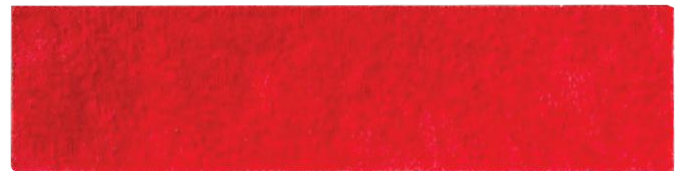

4" DRY PROBUFFER

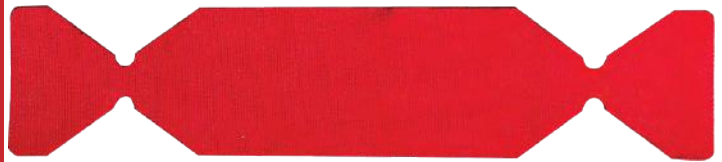

- **Micro fiber product**
- Pre-cut adhesive backed
- Fit standard 4" squeegees
- Improves installation speed
- Sold in packs of 20 (10 of each)
- Protects the vinyl during installation
- Leaves little to no adhesive when removed
- Wet buffers are perfect for PPF and Chrome applications
- Dry buffers are perfect for matte, satin & gloss applications

\$31.99 each | Item #PROBU

PROBLADE RED



- Ultra Sharp
- Blade Size: 9mm
- 30 degree blade tip
- For Use with: PROKNIFE
- Comes in a 10 pack of blades
- Easy to use back blade snapper
- RED stainless steel snap off Blade

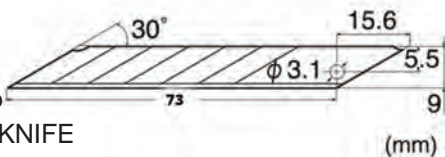

Revised 5-2025

\$17.99 each | Item #PROBL

10

PROKNIFE



- Blade Size: 9mm
- 1 Red 30 degree PROBLADE
- Easy to use back blade snapper
- Smart Lock blade lock technology



Revised 5-2025

\$11.99 each | Item #PROKN

ORAFOL® Series 970RA

Wrapping Cast with Rapid Air NOT FOR PRINTING

4mil Cast Wrapping Film with Rapid Air Technology, Repositionable Solvent Adhesive and an 84lb Silicone coated liner. 970RA offers a fast and reliable way to fully wrap vehicles in standard matte & glossy, glossy matte metallic, and super matte (Black only). This durable film is ideal for long term fleet and motorsport marketing applications and provides a lightweight, economical alternative to paint. Multi-layered, high performance cast PVC film, engineered to the highest technological standards. Designed for car wrapping applications, without the need for top lamination. The RapidAir® technology enables easy and quick application, without air inclusion, especially in large scale applications. The special adhesive enables adhesion onto lacquered surfaces, as well as uneven and corrugated surfaces. For more curved surfaces, or corrugations and rivets, the product should be worked in, cut and applied with an overlap at the edge. The material is easy to remove with the appropriate removal equipment. Durability for Black and White 10 years. Available in 96 colors and 8 Metallic colors – we can Special Order

4 mil thick



60" x 1yd. | \$ 47.99 | Item #970 (M or G) RA-60(COLOR)-1

60" x 75' | \$ 754.99 | Item #970 (M or G) RA-60(25)-(COLOR)

Revised 5-2025

We carry Black (070) | White (010) in both gloss and matte

ORAFOL® Series 975

Carbon Fiber

Transparent solvent based, repositionable adhesive backed 90lb. PE coated silicone liner. 975 Carbon Fiber provides exceptional dimensional stability and conformability over uneven, arched or curved surfaces, as well as flat applications.

This 5mil Cast film offers an easy, fast and reliable way for professional restylers and sign shops to customize standard vehicles with high tech effects. This 975 series has a textured surface specially developed for exterior automotive accent restyling and interior applications for fine detailing. 975 is also recommended for many other Carbon Fiber applications within interior design, craft & hobby and surface effects markets.

*All other colors are available by special order.

5 year durability



60" x 1 yard | \$ 95.99 | tem #975CA - 60 - 070 - 1

60" x 25 yards | \$1,782.99 | Item #975CA - 60- (25) - 070

Revised 5-2025

dragon wrap™ CARBON FIBER

Carbon Fiber

New Product!

Dragon Wrap is a 5.6mil calendered vinyl film featuring a clear repositionable permanent acrylic adhesive on an air-egress liner. This film has excellent dimensional stability, outstanding durability and outdoor performance. This repositionable permanent adhesive offers minimal initial bond growing to permanent bonds that facilitates application of large graphics. The air egress liner also aids in large graphic applications.

UP TO 5 YEARS DURABILITY, DEPENDING ON UV EXPOSURE



60" x 1 yard | \$ 29.99 | Item #780 - 60 - 1

60" x 150' | \$1,320.99 | Item #780-60



Revised 5-2025



with Proslide® Adhesive

What does that mean? Proslide® adhesive is a very repositionable vehicle wrap cast material. The adhesive has low initial tack to the vehicle surface, allowing it to slide up and down, and side to side easily.

Orafol offers a wide range of professional films for complete and partial vehicle wraps, including Commandform films for the most demanding applications (including boat wraps) and new RapidAir films with advanced air channel technology for quick and easy installations. All Orafol wrapping films are splice free and feature a repositionable grey tinted adhesive, removability for up to 4 years with outstanding print quality.



3951GPS-RA

Cast wrap film Rapid Air with Proslide® Adhesive

Print Compatibility:

Latex | Solvent | Eco-Solvent | UV Curable

- Repositionable
- 10 year durability
- **2 mil cast, glossy white**
- Premium high performance vinyl
- Up to 4 year removable solvent adhesive
- For best results, use Oraguard 290 Cast Lam
- Advance RA technology for quicker, easier application
- Designed specifically to conform to irregular surfaces

Size	Cost	Item#
54" x 150'	\$921.99	3951GPS-RA

Size	Cost	Special order
30" x 150'	\$511.99	special order
60" x 150'	\$1022.99	special order

Combo Pack

1 Roll of 54" x 50yds Orajet Media 3951GPS-RA

1 Roll of 54" x 50yds Orajet 290 Gloss Lam

\$1,387.99 | Item #3951GPS-RA *Revised 5-2025*



Wrap your vehicle with
3951GPS-RA
 now with **Proslide® Adhesive**

AVERY MPI 1105

Supercast Easy Apply RS MPI1105SCEZRS

- 2.1mil high gloss finish
- Up to 9 year durability outdoor performance
- Dimensionally stable liner for easy converting
- Air egress technology on Easy Apply and Easy Apply RS films helps to eliminate wrinkles and bubbles

The ultimate in easy application with air regress, long term removability, slide-ability and repositionability. Saves time and money during installation. Ideal for vehicle and fleet graphics requiring high gloss appearance and superior conformability.

Combo Pack

MPI 1105 Supercast easy apply RS media and DOL 1060Z Gloss lamination

Revised 2-2026

Combo Pack 54" x 150' | **\$1293.99** | Item #ASCCOMBO1

54" x 150' | **\$787.99** | Item #A006O94



Print Compatibility:
Latex | Solvent
Eco-Solvent | UV Curable



Premium calendered wrap vinyl with air release

- Air free application • Up to 7 year durability
- UV inkjet should be used on flat surfaces
- Excellent print quality with todays popular solvent, eco solvent, latex and UV printers

Surface characteristics include:

- Rivets • Corrugations • flat areas to slight / moderate curves

The General Formulations Concept 230 Automark premium 2.4mil calendered gloss white vinyl digital media is specifically engineered for use in most vehicle wrap and decal applications. Along with the Concept 231Automark premium clear lamination.

Revised 5-2025

Combo Pack

1 Roll of 54" media #230

1 Roll of 54" Lam #231

\$675.99 | Item #CMBOAUTO

Automark 54" x 150'
\$404.99 | Item #230-54

Autolam 54" x 150'
\$271.99 | Item #231-54



orajet **3551RA**

Calendered Wrap Film Rapid Air

- 2.75 mil thick
- 7 year durability
- Intermediate vinyl
- Repositionable / Permanent
- Up to 4 year removable solvent adhesive
- Advanced RA technology to facilitate quicker, easier application
- Designed specifically to conform to flat surfaces, simple curves, corrugations and rivets

For best results on vehicle wraps use Oraguard 290 Cast Lamine

Size	Cost	Item #
30" x 150'	\$312.99	3551GRA-30-101
54" x 150'	\$563.99	3551GRA-54-101
60" x 150'	\$625.99	3551GRA-60-101

Revised 5-2025



Print Compatibility:
Latex | Solvent
Eco-Solvent | UV Curable



3mil. General Digital Vinyl Gloss White Permanent Air Egress Lay Flat Liner

COMPARABLE TO ORAFOL 3165GRA

- For general signage, decals, point-of-purchase, exhibits, and architectural graphics (interior / exterior)
- Air-egress Technology allows for quick "bubble free" dry application
- **Grey adhesive for added opacity**
- Excellent printability with Solvent | Eco-Solvent | UV curable | Latex Inks
- 5 year durability *Revised 5-2025*

54" x 150' | **\$250.99** | Item #203OAPAE-54



NOT FOR VEHICLES

4mil Intermediate white calendered vinyl

- 5 year outdoor durability
- Rapid air release technology
- Permanent grey solvent based adhesive
- 4mil intermediate calendered vinyl glossy
- Best results use with Oraguard 210 / 215
- General signage, flat surface, medium term outdoor use

Print Compatibility:

Latex | Solvent | Eco-Solvent | UV Curable

Size	Cost	Item #
30" x 150'	\$182.99	3165GRA-30-010
54" x 150'	\$326.99	3165GRA-54-010
60" x 150'	\$361.99	3165GRA-60-010

All Come in Gloss only *Revised 5-2025*



NOT FOR VEHICLES

Intermediate white PVC film

- 5 year outdoor durability
- Permanent grey adhesive
- 3.75mil intermediate PVC
- 3" cores and forward wound
- Available in glossy and matte
- Best results use with Oraguard 210 / 215

Print Compatibility:

Latex | Solvent | Eco-Solvent | UV Curable

Size	Cost	Item #
54" x 150' G	\$257.99	3165G-54-010
54" x 150' M	\$257.99	3165M-54-010
60" x 150' M	\$285.99	3165G-60-010

G = Gloss (comes in 54" ONLY) *Revised 5-2025*
M = Matte (comes in 54" and 60")



**3164RA
3164XRA**

Soft white calendered PVC with Rapid Air Technology

- Available in glossy
- 4mil Economy PVC
- 4 year outdoor durability
- 3" Cores and forward wound
- Permanent clear adhesive for 3164RA
- Permanent grey adhesive for 3164XRA
- General signage, flat surface, medium term indoor / outdoor applications

NOT FOR VEHICLES

Print Compatibility:

Latex | Solvent *Revised 5-2025*
Eco-Solvent | UV Curable

54" x 150' | **\$259.99**

Item #3164GRA54 or 3164XGRA54

Water Resistant Adhesive Vinyl

- 6mil face stock
- Matte white finish
- Water and fade resistant
- Waterfast without lamination
- High gamut, brilliant color saturation
- Permanent pressure sensitive adhesive
- Short term flexible or mounted signs / banners



USE WATER BASED INKS

With it's stay-flat PE coated liner and our signature matte porous coating, this is sure to be your go-to. Best for any mounted application where tight curves and clean cutting need to be addressed. Highly water resistant and instant dry times for faster production.

	Cost	Item #
36" x 100'	\$136.99	QM-WRMVAD-36
42" x 100'	\$159.99	QM-WRMVAD-42
50" x 100'	\$189.99	QM-WRMVAD-50
60" x 100'	\$226.99	QM-WRMVAD-60

Revised 5-2025



Economy Rapid Air Vinyl

- All purpose 3.9mil calendered film
- Orajet 200 / 210 lamination recommended
- Up to 2 years outdoor durability with lamination
- Glossy / matte white finish with superior color reproduction
- Compatible with solvent, eco solvent and UV
- Removable grey adhesive with air release technology

NOT FOR LATEX

54" x 164' | *Pending - PRODUCT & Pricing coming soon*

Item #RAV54 (G=Gloss M=Matte)
Revised 5-2025



Economy white PVC **3164**

- 4mil Economy PVC
- 4 year outdoor durability
- Available in glossy / matte
- 3" core and forward wound
- Latex | Solvent | Eco-Solvent | UV Curable
- Clear, water based Permanent adhesive
- Best results use with Oraguard 200 / 210

Economical short to medium term general signage and other flat indoor and outdoor applications including decals, name plates, die-cut letters and POP

Size	Cost
30" x 150'	\$101.99
54" x 150'	\$172.99

Revised 5-2025

Item #3164
(G =Gloss or M=Matte) (HGT) - 010



Economy white PVC **3640**

- 3mil Economy PVC
- 4 year outdoor durability
- Available in glossy / matte
- 3" core and forward wound
- Clear, water-based, permanent adhesive
- Latex | Solvent | Eco-Solvent | UV Curable
- Best results use with Oraguard 200 / 210

Economical short to medium term general signage and other flat indoor and outdoor applications including decals, name plates, die-cut letters and POP

Size	Cost
30" x 150'	\$ 92.99
54" x 150'	\$163.99

Revised 5-2025

Item #3640
(G = Gloss or M = Matte) (HGT) - 010



Intermediate white and clear PVC **3651**

- Solvent based adhesive
- 5 year outdoor durability
- 2.5mil Intermediate PVC
- 3" core and forward wound
- Available in gloss and matte
- Permanent grey adhesive (on white only)
- Best results use with Oraguard 215 / 210
- Latex | Solvent | Eco-Solvent | UV curable

General signage and other medium-term, flat, indoor and outdoor applications Grey, solvent-based, permanent adhesive (transparent offers clear adhesive)

Size	Cost
30" x 150'	\$154.99
36" x 150'	\$184.99
54" x 150'	\$276.99

Revised 5-2025

Item #3651
(HGT) (010 or 000)
Clear is available in gloss only

201

Calendered matte white vinyl

- 3.4mil thickness
- Polymeric film type
- Up to 5 years outdoor durability
- Solvent | Eco-Solvent | UV Curable

General Formulations 201 is designed for interior or exterior signage, decals, nameplates, die - cut letters and point - of - purchase displays.This film is designed to accept a variety of solvent-based inkjet and UV curable inks .Completely evaporate inkjet solvents before application. Failure to do so may facilitate solvent penetration resulting in vinyl degradation. (54" X 150' roll, reverse wound / notched core) Adhesive 200-5000 produces permanent bond to a variety of common substrates used in the graphics applications. The 90# Lay flat liner offers excellent product lay flat in a variety of ambient conditions.

Expected Exterior Exposure: Up to 5 years

Item #201 (HGT)

30" x 150'	\$133.99
54" x 150'	\$201.99
60" x 150'	\$229.99

Revised 5-2025

203

Gloss white vinyl permanent adhesive

- 3mil thickness
- Polymeric film type
- Clear permanent adhesive
- Solvent | Eco-Solvent | UV Curable

General Formulations 203 is designed for interior or exterior signage, decals, nameplates, die-cut letters and point-of-purchase displays.This film is designed to accept a variety of solvent-based inkjet and UV curable inks .Completely evaporate inkjet solvents before application. Failure to do so may facilitate solvent penetration resulting in vinyl degradation. (54" X 150' roll, reverse wound/notched core) Adhesive 200-5000 produces permanent bond to a variety of common substrates used in the graphics applications. The 90# Lay flat liner offers excellent product lay flat in a variety of ambient conditions.

Expected Exterior Exposure: Up to 5 years

Item #203 (HGT)

30" x 150'	\$133.99
54" x 150'	\$201.99
60" x 150'	\$229.99

Revised 5-2025

222

White PVC vinyl

- 6mil
 - 90# digital liner
 - Non-topcoated
 - Semi rigid white pvc vinyl
 - Latex | Solvent | Eco-Solvent | UV Curable
- General Formulations 222 is a 6mil Matte White semi-rigid calendared PVC film coated with 200-4990 permanent acrylic pressure sensitive adhesive laminated to a 90# tight release digital liner designed for roll processing. This vinyl film is designed to accept a variety of solvent-based inkjet and UV curable inks common to wide format digital printing systems. Concept® 222 is general purpose decal film designed for interior or exterior signage, decals, nameplates, die-cut letters and point-of-purchase displays.

Expected Exterior Exposure: Up to 3 years
Revised 5-2025

54" x 100' | **\$193.99** | Item #222-54

54" X 100' roll, reverse wound | notched core
Completely evaporate inkjet solvents before application. Failure to do so may facilitate solvent penetration resulting in vinyl degradation.



Removable Calendered Vinyl

- 4mil intermediate vinyl
- 5 year outdoor durability
- Rapid air release technology
- Accepts all popular printer types
- Recommended for Flat surfaces
- Short to medium term applications
- Removable grey solvent based adhesive

Latex | Solvent | Eco-Solvent | UV curable

Recommended laminate films
Oraguard 210 | Oraguard 215

Item #3169RA
54" x 150' **\$326.99**
(G = Gloss or M = Matte)

Revised 5-2025



Clear PVC Window Media

- 3 mil Economy PVC vinyl
- 4 year outdoor durability
- Available in Gloss or Matte
- Accepts all popular printer types.
- Removable, clear Based Adhesive

Latex | Solvent | Eco-Solvent | UV curable

Recommended laminate films
Oraguard 200 | Oraguard 210

Size	Cost
30" x 150'	\$ 96.99
54" x 150'	\$163.99

Item #3620
(G = Gloss or M = Matte) (HGT) - 000

Revised 5-2025



Soft Calendered PVC Digital Media

- 4 year outdoor durability
- 3 mil Economy PVC vinyl
- Available in Gloss or Matte
- Accepts all popular printer types
- Removable, grey Based Adhesive
- Short to medium term applications

Latex | Solvent | Eco-Solvent | UV Curable

Recommended laminate films
Oraguard 200 | Oraguard 210

30" x 150'	\$ 96.99
36" x 150'	\$113.99
54" x 150'	\$163.99
60" x 150'	\$182.99

Item #3621
(G = Gloss or M = Matte) (HGT) - 010 Revised 5-2025



223

Semi Rigid White Matte PVC

- 6mil thickness
- Removable Adhesive

Latex | Solvent | Eco-Solvent | UV Curable

General Formulations 223 is a 6mil premium white matte semi rigid calendared vinyl film coated with a removable acrylic pressure sensitive adhesive.

General Formulations 223 is a high performance removable decal film designed for ease of application of temporary interior or exterior signage, decals, nameplates, die-cut letters and point-of-purchase displays. General Formulations 223 is the ideal media for temporary store front applications requiring bond to windows. This media may also be used on smooth surfaces such as metals, painted metals and certain high energy plastics. Not designed for coated / sealed / treated stainless steel, brass or bronze surfaces.

Item #223 - 54
54" x 100' | **\$196.99**

Revised 5-2025



3105HT

High Tack Gloss Calendered Vinyl

- 5 years outdoor durability
 - Oracal® suggests laminating with Oraguard® series 270 | 280 | 290
 - 4 mil. calendered gloss white PVC with high tack permanent adhesive
 - Specially formulated opaque grey hpigmented adhesive with high initial tack and final adhesion
 - Great for graphics on hard to stick, low energy with a smooth or slightly textured flat surface
- Long-term graphic applications, markings and decorations with the highest degree of outdoor brilliance and durability. Especially designed for hard-to-stick, low-energy plastics (like polyethylene and polypropylene) with a smooth or slightly textured flat surface such as kayaks, ATVs, coolers and porta-johns.

Latex | Solvent | Eco-Solvent | UV Curable
Revised 5-2025

Size	Cost	Item #
54" x 10yd	\$115.99	10-3105GHT-54-010
54" x 150'	\$418.99	3105GHT-54-010



4 mil **GRIP** & 12 mil **ARMOR LAMINATE**

Step 1 Print Media

- 5 year outdoor
- 90 lb. lay flat liner
- 4 Mil matte white "GRIP"
- Clear high bond permanent adhesive
- Ink eco - solvent | Latex | Thermal

54" x 150' | \$646.99 | Item #235-54

Revised 5-2025

Step 2 Protection Laminate

- 53 lb. liner
- 5 year outdoor
- 12 Mil gloss clear laminate
- Clear permanent adhesive

For best results use 4mil GRIP and the 12mil Armor lamininate together.

54" x 75' | \$374.99 | Item #238-54

Revised 5-2025



209

Transit Graphics Vinyl

- 90# digital liner
- Approved by Viacom
- Solvent | UV Curable
- Removable acrylic adhesive
- 3.5mil opaque white PVC vinyl

General Formulations 209 is designed for temporary product markings, temporary point of purchase decals, temporary transportation advertising systems, and tri-vision indoor/outdoor billboard displays. Removable for up to one year from most smooth original equipment finishes with little or no residue remaining on the finish. Completely evaporate inkjet solvents before application. Failure to do so may facilitate solvent penetration resulting in vinyl degradation.



Revised 5-2025

54" x 150' | \$239.99 | Item #209-54



221

**SEMI-RIGID VINYL
 GLOSS WHITE
 REMOVABLE ADHESIVE**



6.0 MIL
 Clear Low-Tack Removable Adhesive
 90# Tight Release Layflat Liner

- For General Signage, Decals, Point-of-Purchase, Exhibit, Architectural and Glass Applications (interior/exterior)
- Semi-Rigid Vinyl allows for Quick & Easy Handling and Application, even without a Laminate
- 3 Year Durability

54" x 100' | \$203.99 | Item #221-54

Revised 5-2025



222

**SEMI-RIGID VINYL
 MATTE WHITE
 REMOVABLE ADHESIVE**



6.0 MIL
 Clear Low-Tack Removable Adhesive
 90# Tight Release Layflat Liner

- For General Signage, Decals, Point-of-Purchase, Exhibit, Architectural and Glass Applications (interior/exterior)
- Semi-Rigid Vinyl allows for Quick & Easy Handling and Application, even without a Laminate
- 3 Year Durability

54" x 100' | \$196.99 | Item #222-54



207

Clear Static Cling Vinyl

General Formulations 207 is a 7.0 mil premium clear highly plasticized flexible calendered vinyl film laminated to a 90# Lay flat liner. This film is designed to accept a variety of solvent-based inkjet and UV curable inks common to wide format digital printing systems.

General Formulations may be used for temporary applications to exterior glass, up to 3 months. Temperature, wind and rain may also limit the bond of static cling vinyl to exterior windows. Clear static cling can yellow with prolonged exposure to UV radiation.

The surface must be clean, smooth and as close to room temperature as possible. Cold surfaces reduce the cling of the vinyl. Small decals may be applied dry. Large decals should be applied by wetting the substrate and the decal with glass cleaner. Use a roller to smooth the decal onto the substrate.

Revised 5-2025

27" x 75' | **\$ 82.99** | Item #207-27

54" x 75' | **\$125.99** | Item #207-54



208

White Static Cling Vinyl

General Formulations 208 is a 7mil. premium white highly plasticized flexible calendered vinyl film laminated to a 90# lay flat liner.

This film is designed to accept a variety of solvent based inkjet and UV curable inks common to wide format digital printing systems.

General Formulations 208 is designed for window decals, temporary product markings, point of purchase displays and protective masking. Thoroughly test this product when applying to painted surfaces

Hazing may develop on the painted surface with extended exposure to static cling vinyl.

Revised 5-2025

27" x 75' | **\$ 85.99** | Item #208-27

54" x 75' | **\$128.99** | Item #208-54



224

Transmark Translucent Vinyl

General Formulations 224 is a 3mil. premium white translucent calendered PVC film coated with permanent acrylic pressure sensitive adhesive. This vinyl film is designed to accept a variety of solvent based inkjet and UV curable inks. General Formulations 224 is premium decal film designed for permanent interior or exterior signage applied to illuminated substrates such as polycarbonate, styrene and acrylic sheets.

Revised 5-2025

30" x 150' | **\$270.99** | Item #224-30

54" x 150' | **\$480.99** | Item #224-54



Orajel

Translucent
Calendered
Digital Media

3850

Latex | Solvent | eco-Solvent | UV curable

- Semi gloss white
- 3 mil calendered PVC film
- 7 year outdoor durability
- Long-term use on rigid substrates in backlit indoor and outdoor applications

For best results,utilize ORAFOL ICC profiles available at www.orafolamericas.com and allow solvent-based inks to dry for at least 24 hours (48-72 hours preferred) at 70°F before cutting the graphic to the ink or applying a laminate.

Recommended Laminates ORAGUARD® Series 215 | 290 | 290GF

Item# 3850SG (HGT) – 010
SG = Semi Gloss

30" x 150'	\$411.99
54" x 150'	\$738.99
60" x 150'	\$820.99

Revised 5-2025

Satin Backlit Polyester Film

Our coated PET film has a low-glare satin top coating that dries quickly and produces dense blacks and vivid colors that will pop with a light box. It is appropriate for outdoor display and is scratch resistant. Laminate for further protection with one of our Millennium laminates.

Eco-Solvent / Latex / UV

8 mil Matte white

Benefits:

- Durable
- Dries Quickly
- Scratch Resistant
- Coated for High Ink Reception

Revised 5-2025

36" x 100'	\$206.99	QMSBL36
54" x 100'	\$309.99	QMSBL54
60" x 100'	\$343.99	QMSBL60



Backlit Film sbl-7

- Matte white finish
- Idea for backlit signs
- Front print and front view
- 7mil polyester backlit film
- Indoor / outdoor application
- **Waterbased and solvent receptive**
- Vivid color and high image resolution

Revised 5-2025

36" x 100' | **\$293.99** | Item #66629

54" x 100' | **\$358.99** | Item #66870



Great for Window Advertising

Ask For Samples

- Easy Kiss-Cut or Contour Cut
- No Residue. No Static. No Cling
- Fade resistant for up to 1-3 years!
- Great for glass windows and displays
- Removable, Repositionable and Reusable
- Install using only water to eliminate bubbles
- Full Bleed Printing (no need to leave a white border)
- Peel & Place using Hybrid Micro-Suction Technology
- **Metal and plastic surfaces, Test application to the surface**
- Conforms to temperature change (does not shrink or expand)
- Water resistant & can be cleaned using standard window cleaners

Block-Out White

Size	Cost	Item #
30" x 100'	\$186.99	GAP30100
42" x 100'	\$260.99	GAP42100
50" x 100'	\$310.99	GAP50100
54" x 100'	\$335.99	GAP54100
60" x 100'	\$372.99	GAP60100

Solvent | UV | Latex Inks *Revised 5-2025*

Frost

Size	Cost	Item #
54" x 100'	\$349.99	GAPFROST54100

UV | Latex Inks

Block - Out White



Frosted

FOR ALUMINUM SIDED CARS AND TRUCKS



A GREAT OPTION FOR ALUMINUM SIDED VEHICLES

ALWAYS ROUND ALL 4 CORNERS OF VEHICLE SIGNAGE

ALWAYS TEST THE APPLICATION OF THE PRODUCT TO METAL AND PLASTIC SURFACES

GENERAL FORMULATIONS 202

Matte vinyl for temporary interior or exterior signage, decals, nameplates, die-cut letters and point - of - purchase.

- Available in matte white
- 3.4 mil calendered vinyl
- Removable clear Based Adhesive
- Short to medium term applications
- Latex, Solvent, Eco-Solvent, UV Curable
- Removable up to 1 year (under normal conditions)

Recommended laminate films
Concept 400 | 401 | 402

Not recommended for use on coated, sealed, treated stainless steel, brass or bronze surfaces

Size	Item #	Cost
30" x 150'	202-30	\$143.99
54" x 150'	202-54	\$214.99
60" x 150'	202-60	\$243.99

Revised 5-2025

GENERAL FORMULATIONS 204

Gloss vinyl for temporary interior or exterior signage, decals, nameplates, die-cut letters and point - of - purchase.

- Available in gloss
- 3mil calendered vinyl
- Accepts all popular printer types
- Removable clear Based Adhesive
- Latex, Solvent, Eco-Solvent, UV Curable
- Removable up to 2 years (under normal conditions)

Recommended laminate films
Concept 400 | 401 | 402

Not recommended for use on coated, sealed, treated stainless steel, brass or bronze surfaces

Size	Item #	Cost
30" x 150'	204-30	\$144.99
54" x 150'	204-54	\$215.99
60" x 150'	204-60	\$244.99

Revised 5-2025



3686★ Semi Gloss - 8mil. TriSolv™ PrimeArt Paper 200



Size	Cost	Item #
30" x 165'	\$139.50	368630
42" x 165'	\$194.99	368642
54" x 165'	\$245.99	368654

Revised 5-25

PRODUCT DESCRIPTION

3686 TriSolv™ PrimeArt Paper is a premium weight, bright white, wet strength paper that features outdoor durability and excellent scratch resistance. The entire TriSolv™ family of products are compatible with solvent, UVC, and Latex printers.

ADVANTAGES

- Outdoor Durable Wet Strength Paper
- Water & Scratch Resistant Coating
- Bright White
- Folds Any Direction Without Cracking

APPLICATIONS

- Indoor/Outdoor High Quality Advertising Signs, Information Boards
- Billboards, Construction Signs, Outdoor Décor, Exhibits, and Promotions

TECHNOLOGIES



3699★ Gloss - 9mil. TriSolv™ PhotoArt Paper



Size	Cost	Item #
36" x 150'	\$134.99	369936
54" x 150'	\$201.99	369954
63" x 150'	\$235.99	369963

Revised 5-25

PRODUCT DESCRIPTION

3699 TriSolv™ PhotoArt is a 9 mil gloss, wet strength photo paper that delivers maximum image performance, black density, and color vibrancy on both solvent and latex printers. The high quality color reproduction combined with the homogeneous gloss across printed and unprinted areas will certainly impress!

ADVANTAGES

- Outdoor Durable Wet Strength Paper
- Water Resistant Surface
- Vivid Color Reproduction
- Homogeneous Gloss in Printed & Unprinted Areas

APPLICATIONS

- Advertising for Concerts, Movies, Shop Promotions
- High Quality Photo Reproductions & Indoor / Outdoor Advertising

TECHNOLOGIES

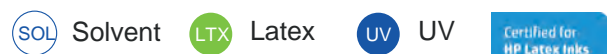

CanvasTac Repositionable Adhesive Backed Polyester Canvas

- 17 mil (8 oz.) Material
- 100 % Polyester canvas
- Commercial/retail/home use
- Removable & Repositionable
- Wall graphics/custom cut prints



Printable With:

Solvent/eco-solvent inks | Latex Inks | UV Inks

CanvasTac is a peel and stick canvas fabric that is removable and repositionable. CanvasTac is used for wall murals and interior applications. Our high-quality microsphere adhesive will not peel off paint, damage your walls or leave residue behind when removed. CanvasTac can be easily contour cut without any fraying. This product is easy to install and handle and will look great with any print or design. CanvasTac #343 is a Category VI Type III Wall covering. It is also UL tested for safety (ICC IBC (2012) 803.1.1 Class A finish material compliant.)

Length	Cost	Item #
54" x 75'	\$448.99	CT5475
60" x 75'	\$456.99	CT6075

Length	Cost	Item #
54" x 10'	\$87.99	CT5410
60" x 10'	\$97.99	CT6010

Revised 5-25

MAGIC GFCVM Stretch Canvas

17 mil Printable Stretch Canvas

- Matte finish • **Good with solvent inks**
- Acid free polyester cotton blend
- Longterm fade resistance fine art or photo reproduction applications

Size	Cost	Item #
36" x 75'	\$216.99	66027
54" x 75'	\$349.99	66029
60" x 75'	\$388.99	66030

Revised 5-25



17 mil Printable Stretch Canvas

- 9 oz.
- Satin finish
- Stretch without cracking
- High resolution stretch canvas
- Enhanced acrylic coating for superior color brilliance and image definition
- 55% cotton, 45% polyester blend resulting in a uniform finish

Excellent printability with Eco-Solvent | Solvent | UV | Latex

Size	Cost	Item #
54" x 150'	\$397.99	AUR54150
60" x 150'	\$418.99	AUR60150
122" x 150'	\$733.99	AUR122150

Revised 5-25

AmberCloth

Solvent Printable Fabric

- 3" core
- Matte fabric
- 5.5 oz. 100% coated polyester
- Indoor and limited outdoor durability

Eco-solvent Solvent UV Curable Aqueous Inks **Great for: Retail Trade Shows Display Banners**

Size	Cost	Item #
38" x 1yrd	\$ 7.99	AC361Y
38" x 5yrd	\$ 23.99	AC365Y
38" x 50yrd	\$192.99	AC3650
54" x 1yrd	\$ 10.99	AC541Y
54" x 5yrd	\$ 37.99	AC545Y
54" x 50yrd	\$275.99	AC5450
98" x 50yrd	\$523.99	AC9850

Revised 5-25



Removable Wall Graphics Matte White PVC **3268** *Orajel*

- 6mil
- Indoor durability up to 2 years
- If laminating Oracal recommends using Oraguard 200 / 210
- Clear, water-based, removable adhesive
- **Latex | Solvent | Eco-Solvent | UV Curable**
- For use on smooth walls or glass surfaces
- PVC film featuring a special low-tack adhesive
- Special low tac adhesive allows for the product to be reapplied multiple times

A 1/4" unprinted border around the graphic is recommended to help ensure the success of the application

Item # 3268M

Size	Cost
30" x 150'	\$176.99
54" x 150'	\$292.99
60" x 150'	\$328.99



Removable Wall Graphics Matte White PVC **3628** *Orajel*

- 3mil soft calendered PVC
- Indoor durability up to 3 years
- If laminating Oracal recommends using Oraguard 200 | 210
- Clear, water-based, removable adhesive
- **Latex | Solvent | Eco-solvent | UV Curable**
- For use on smooth walls or glass surfaces

A 1/4" unprinted border around the graphic is recommended to help ensure the success of the application

Item # 3628M

Size	Cost
30" x 150'	\$170.99
54" x 150'	\$305.99
60" x 150'	\$338.99



Fabric Wall Graphics **234**

General Formulations 234 is designed for temporary application of decals and graphics to most types of painted interior walls. This includes most flat, semi gloss and gloss paint finishes. Decals may also be applied to sealed wall coverings. The surface must be smooth and clean prior to application.

Not designed for coated, sealed, treated stainless steel, brass or bronze surfaces

7mil premium white matte coated polyester fabric with an acrylic removable pressure sensitive adhesive backed by a 90# Lay flat liner. The combination of fabric and adhesive allows removability of this product from normal wall surfaces. The 90# Lay flat release liner provides excellent stability for processing using standard solvent, eco-solvent, UV curable and latex.

54" x 25' | **\$118.99** | Item #234-54-25

54" x 100' | **\$389.99** | Item #234-54

SM Wall Vinyl *REPOSITIONABLE WALL GRAPHICS*

With an ultra removable and reusable adhesive. Highly effective wall advertisement and promotions. Recommended for smooth, dry, cleaned and flat surfaces.

Eco-Solvent | Solvent UV based | Latex Inkjet
2 years interior durability



6 mil 54" x 75' | **\$144.99** | Item #SPMWG6

8 mil 54" x 75' | **\$183.99** | Item #SPMWG8



SOLVENT * ECO-SOLVENT * LATEX * UV CURABLE * SCREEN * OFFSET (UV CURABLE)

WallMark™ HTR

WITH SPECIAL REMOVABLE HIGH-TACK WALL ADHESIVE

GF 226HTR is a 6.0 mil matte white semi-rigid vinyl.

GF 226HTR has a unique and innovative pressure sensitive adhesive that is specially formulated to be both high-tack and removable (HTR) cleanly for up to a year. It's also forgiving in the event you touch the adhesive to itself—it will stay anchored to the vinyl. The 90# tight release liner stays flat.

54" x 100' | **\$266.99** | Item # 226HTR54 **Durability : 5 years / Removability: 1 year**

Photo Tex *Self Adhesive 6 mil Fabric*

This Adhesive Fabric Media is compatible with pigment, water based, solvent, eco-solvent, latex and UV- inks. This fabric gives you vivid, sharp print results with brilliant colors! The Adhesive is Re-movable and Re-usable also Re-positional. Photo Tex patented characteristics separate itself from any other product on the market. Photo Tex will stick to virtually any surface and can be easily removed with 99% no residue. The material does not rip or wrinkle. Results will vary on stucco and eggshell painted surfaces. Not recommended for brick or non-painted cement surfaces or heavy painted spackled wall board. Make sure you allow 30-days on newly painted surfaces for out-gassing. Also, always check the heat setting on UV and UV curable printers as to not over heat the adhesive or alter its tack. Do not oversaturate UV inks and in certain cases you may need to leave up to a 1" boarder.

Size	Cost	Item #
27" x 20'	\$ 76.50	PT272
27" x 100'	\$278.50	PT271
54" x 20'	\$126.50	PT542
54" x 100'	\$532.50	PT541



Street Rap Floor Graphics

StreetRap is a 3.4-mil matte opaque white, PVC film designed for the production of outdoor sidewalk and parking lot ‘floor’ graphics. The product is coated on one side with a 3-mil thick, aggressive, permanent, blended acrylic / rubber pressure sensitive adhesive that bonds well to flat or slightly rough, pedestrian traffic surfaces like concrete and asphalt. The adhesive is protected with a 90# polycoated 2-side Super Flat™ liner. The film face is designed for excellent printability with **solvent, eco-solvent, latex and UV-cured inkjet printers.**



54" x 75' | \$ 664.99 | Item #STR328-25

54" x 150' | \$1155.99 | Item #STR328

Revised 5-2025



Temporary floor signs, decals and point of purchase advertising.

- 3.4mil
- 90# digital liner
- Non top coated
- Matte white flexible PVC vinyl
- Removable hard acrylic adhesive
- Must use GF109 Laminate or GF211 Laminate

FLOOR ADVERTISING GRAPHICS

Solvent based inkjet and UV curable inks

General Formulations 210 is a specially formulated flexible vinyl with a high performance acrylic pressure sensitive adhesive on a 90# Lay flat liner. The combination of vinyl and adhesive allows removability of the film from most common commercial tile floor substrates for up to 6 months under normal exposure conditions. This film is designed to accept a variety of solvent-based inkjet and UV curable inks common to wide format digital printing systems.

54" x 1yd. | \$ 9.99 | Item #210-54-01

(min 5 yards)

54" x 150ft. | \$247.99 | Item #210-54

(50 yards)

Revised 5-2025



This product is designed for temporary floor signs, decals, and point of purchase advertising on commercial carpets.

- 3.4mil
- 90# digital liner
- Non top coated
- Matte white flexible PVC vinyl
- Removable soft acrylic adhesive
- Must use GF109 Laminate or GF211 Laminate

CARPET ADVERTISING GRAPHICS

Solvent based inkjet and UV curable inks

This product is designed for temporary floor signs, decals, and point of purchase advertising on commercial carpets. These are carpets with a short nap and a tight weave containing minimal texture. Must use either Concept® 109 or Concept® 211 (over laminate) to provide protection to the graphics.

54" x 1yd. | \$ 9.99 | Item #212-54-01

(min 5 yards)

54" x 150ft. | \$257.99 | Item #212-54

(50 yards)

Revised 5-2025

FRONTLIT FLEX

Roll Up Banner Material

scrim vinyl for aqueous inks

**WORKS WITH
DYE AND PIGMENT INKS**

- 15 mil
- Matte finish
- Water and tear resistant
- Dries immediately after printing
- High gamut, brilliant color saturation

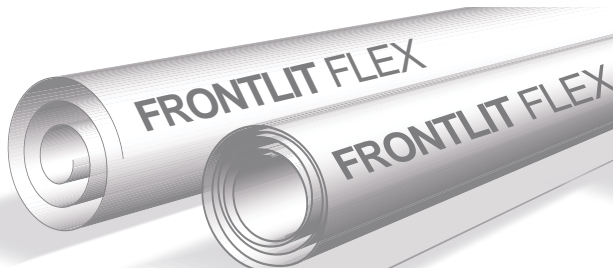

Size	Cost	Item #
36" x 60'	\$109.99	QM-ESV-36
42" x 60'	\$127.99	QM-ESV-42
50" x 60'	\$151.99	QM-ESV-50
60" x 60'	\$182.99	QM-ESV-60

Revised 5-2025

EMPIRE Lite

Roll Up Stay Flat Banner Material

- Block out grey back
- Stay flat, anti curl quality
- Ultra smooth 12.5oz. banner material

SOLVENT | UV

Not Recommended for **ECO-SOLVENT**



Size	Cost	Item #
38" x 10yds	\$ 58.99	EMPIREL3810
38" x 150'	\$187.99	EMPIREL38164
86" x 150'	\$435.99	EMPIREL86164

\$40 CUT CHARGE

Revised 5-2025

TUFF-BAN

**22oz. PVC COATED
BLOCK OUT**

- Ideal for street light poles
- Single or double faced banners
- Great for across the street banners
- Extra durable for long term outdoor use
- Works with Solvent | UV | Latex Printers
- Superb strength with 1000 x 1000 denier

Size	Cost	Item #
54" x 50yds	\$ 382.99	PBT5450
62" x 50yds	\$ 401.50	PBT6250
126" x 50yds	\$ 947.99	PBT12650
197" x 50yds	\$1481.50	PBT19750

Revised 5-2025

**SLITTING \$69 SET UP | \$6 PER CUT
DELIVERY NOT INCLUDED ON 197" ROLLS**

Great for
Double Faced
Street Light
Poles Banners!



Pro-Ban premium 13oz. Matte Single Sided

- Superior ink adhesion
- Tear and fade resistance
- Works with Solvent | UV | Latex Printers
- Trimmed edges [no fuzz] for digital printers



Size	Cost	Item #
38" x 50yds	\$126.99	PBM13384
54" x 50yds	\$170.50	PBM13544
64" x 50yds	\$196.50	PBM13644
73" x 50yds	\$234.99	PBM13734
98" x 50yds	\$272.50	PBM13984

\$46 CUT CHARGE *Revised 5-2025*
98" IS REVERSE WOUND

Pro-Ban premium 13oz. Gloss Single Sided

- Superior ink adhesion
- Tear and fade resistance
- Works with Solvent | UV | Latex Printers
- Trimmed edges [no fuzz] for digital printers

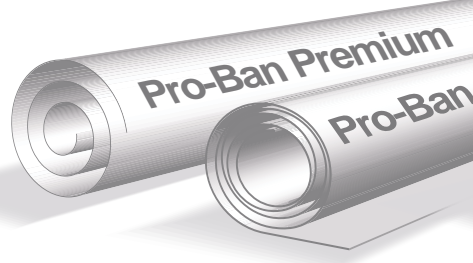

Size	Cost	Item #
38" x 50yds	\$126.99	PBG13384
54" x 50yds	\$170.50	PBG13544
64" x 50yds	\$196.50	PBG13644
73" x 50yds	\$234.99	PBG13734

\$46 CUT CHARGE *Revised 5-2025*

Pro-Ban premium 12oz. Matte Double Sided

- Superior ink adhesion
- Tear and fade resistance
- Works with Solvent | UV | Latex Printers
- Trimmed edges [no fuzz] for digital printers



Size	Cost	Item #
38" x 50yds	\$159.99	PBM14385
54" x 50yds	\$226.99	PBM14545

\$46 CUT CHARGE *Revised 5-2025*

Pro-Ban grand format

13oz. Matte Single Sided

- Print side in
- Roll is tubed for protection
- Excellent resolution and ink adhesion
- Superb strength with 1000 x 1000 denier
- Works with Solvent | UV | Latex Printers
- Trimmed edges [no fuzz] for digital printers

ALL ROLLS REVERSE WOUND
DELIVERY NOT INCLUDED ON
197" ROLLS



Size	Cost	Item #
126" x 50yds	\$422.50	PBGF1265
197" x 50yds	\$579.50	PBGF1975

Revised 6-2025

SLITTING \$69 SET UP | \$6 PER CUT

Pro-Ban mesh with liner

8-9oz. Matte Single Sided

- 197" no liner
- Superior ink adhesion
- Tear and fade resistance
- 38" | 54" | 126" have easy remove liner
- Superb strength with 1000 x 1000 denier
- Works with Solvent | UV | Latex Printers
- Trimmed edges [no fuzz] for digital printers

DELIVERY NOT INCLUDED ON 197" ROLLS



\$46 CUT CHARGE

Size	Cost	Item #
38" x 50yds	\$151.50 liner	PBME385
54" x 50yds	\$215.99 liner	PBME545
74" x 50yds	\$351.50 liner	PBME745
126" x 50yds	\$500.50 liner	PBME1265
197" x 50yds	\$782.50 no liner	PBME1975

Revised 9-2025

contrAvision® Performance provides high quality and minimal shrinkage. Campaign maintains many features of Performance, but for short term projects Universal Liner aka Additional Liner is suitable for printing with UV, Latex with optimizer primer, Solvent and Eco-solvent.

ACTUAL HOLE SIZE

THE ONLY ONE WAY VISION (OWV) MEDIA MANUFACTURER WITH **1MM DIAMETER HOLES!** IN THE ENTIRE WORLD



40% HD

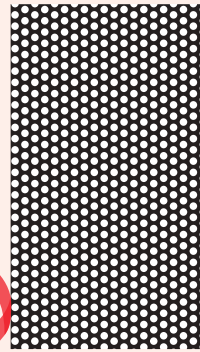

HD Performance

20%

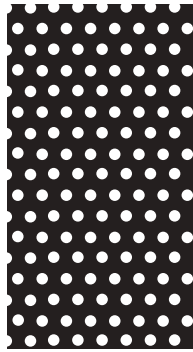

Maximum image strength

30%

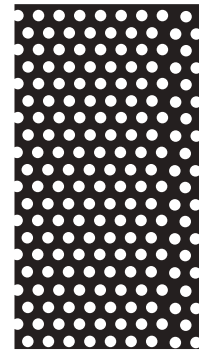

Standard for retail windows

50%

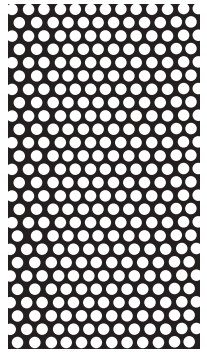

Maximum see-through

- Grey Liner provides a more accurate final print color assessment
- Reduces breakage during the removal process
- Wide range of transparency options
- Easy installation, very repositionable
- Leaves almost no adhesive residue

60 / 40	HD Performance
54" x 30'	\$314.99
54" x 150'	\$1258.99

50 / 50	Performance
54" x 30'	\$234.99
54" x 150'	\$945.99
60" x 150'	\$1051.99

50 / 50 70 / 30 80 / 20	Campaign
54" x 150'	\$521.99
60" x 150'	\$580.99

70 / 30 80 / 20	Performance
54" x 30'	\$ 262.99
54" x 150'	\$ 1007.99
60" x 150'	\$1119.99

Revised 5-2025

OUTSIDE VIEW



INSIDE VIEW



Channel Letter Film

Size: Day / Night	Cost	Item #
54" x Linear ft.	\$ 14.99	BWPRW1
54" x 30 ft.	\$ 345.99	BWPRW
54" x 50 yd.	\$1411.99	BWPRW5

minimum 3ft.



Privacy OWV Film

Size: Day / Night	Cost	Item #
60" x Linear ft.	\$14.99	BWPRW30
60" x 30'	\$345.99	BWPRW30

minimum 3ft.

Revised 5-2025

Black on white perforated window film (PERFORMANCE)

Quick installation and clean removal to the inside of windows. **Not for printing!**

Security ONE WAY FILM
For inside application facing out
They can't see in,
But you can see out

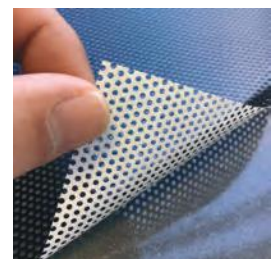

Nikkalite Premium Reflective Digital Film with Air Release For Reflective Fast Installations

- 7 year expected durability
- High resolution digital printing
- Bubble free air release system
- **Fast installation with AIR RELEASE**
- Easy application over compound curves and rivets
- Vehicle wraps, fleet marketing, signs and banner, decals and thermal die cutting

R 8512 GI
TEST PRINT FIRST

UV | Eco - Solvent | Solvent | Latex Printers

	Cost Per Yard	10 Yard Roll	50 Yard Roll	Item #
24"	\$15.99	\$147.99	\$ 641.99	R8524GI
48"	\$28.99	\$268.99	\$1,167.99	R8548GI

2 yards minimum order

Revised 5-2025



Nikkalite Reflective

Premium Reflective Digital Film

- 7 year expected durability
- High resolution digital printing
- Easy application over compound curves and rivets
- Vehicle wraps, fleet marketing, signs and banner, decals and thermal die cutting

R8512
TEST PRINT FIRST

UV | Eco - Solvent | Solvent | Latex Printers

	Cost Per Yard	10 Yard Roll	50 Yard Roll	Item #
24"	\$13.99	\$121.99	\$528.99	R8524
48"	\$27.99	\$243.99	\$961.99	R8548

2 yards minimum order

Revised 5-2025



ORAFOL® 5650 RA

- Not for wet application
- 7 year outdoor durability
- 89lb PE coated silicone paper
- Meets or exceeds Federal Specifications ASTM D 4956
- Clear repositionable, solvent based, permanent adhesive with air release. Clean removability for up to 4 years

Fleet Engineer Grade
5 mil Reflective

Print compatibility

Solvent | Eco Solvent | UV, Latex | Screen Print

Size	Cost	Item #
30" x 10yds	\$ 321.99	5650RA30-10
54" x 10yds	\$ 583.99	5650RA54-10
30" x 50yds	\$1938.99	5650RA30-50
54" x 50yds	\$2161.99	5650RA54-50

Revised 5-2025





30mil magnetic pre cuts 12" x 24.375"
Strong Magnetization - 90lb. PULL!

	1 - 24	25 - 100	100+
Straight	\$6.99	\$5.99	\$5.35
Curved	\$7.99	\$7.69	\$7.25

Magnetic VINYL ROLLS & SHEETS

30 mil GLOSS | Item #TM3050G
30 mil MATTE | Item #TM3050M
ROLL SIZE 24.375" x 50'



Straight Corners | Item #TM1224S Rounded Corners | Item #TM1224R

1 ROLL
\$169.99 ea.
2 ROLLS +
\$164.99 ea.

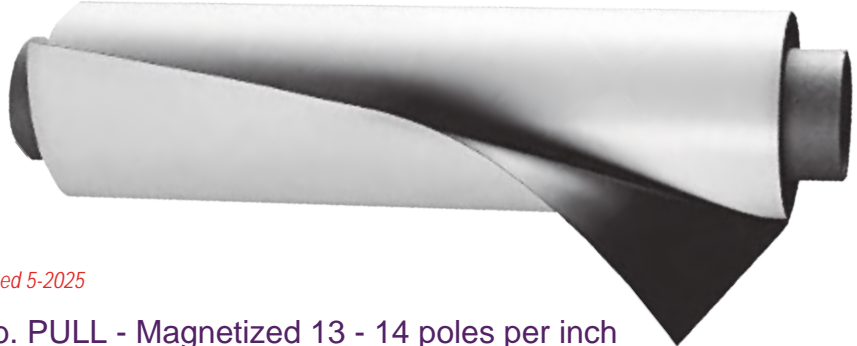

Revised 5-2025

90lb. PULL - Magnetized 13 - 14 poles per inch

- 30mil 24.375" x 10ft. | \$ 52.99 | Item #MS01 | Matte White
- 30mil 24.375" x 25ft. | \$ 98.99 | Item #TM3025M | Matte White Half Rolls
- 30mil 40" x 50ft. | \$295.00 | Item #TM4050M | Matte White

CAUTION: Magnetic vinyls can cause permanent damage to painted surfaces unless properly maintained as per the enclosed instructions, which includes daily removal. Sign-Mart is not responsible for any vehicle damage



Revised 5-2025

Size	Cost	Description	Item #
24.375" x 50'	\$174.99	Matte White	MS03
24.375" x 50'	\$203.99	High Gloss White	MS04
1/2" x 200'	\$ 61.99	30 mil Magnetic Strip with econ adhesive	MS05
3/4" x 200'	\$ 73.99	30 mil Magnetic Strip with econ adhesive	MS09



Magnum Magnetics® is the premier manufacturer of flexible magnetic sheeting products in the USA. Featuring a Matte White or High Gloss finish it offers superior holding power on most metallic surfaces. This flexible magnetic accepts vinyl graphics, screen printing, digital inkjet, offset, hot stamp, litho and more. The 30-mil. thickness is ideal for automotive applications and can easily be cut to size with a utility knife and straight edge.

CAUTION: Magnetic vinyls can cause permanent damage to painted surfaces unless properly maintained as per the enclosed instructions, which includes daily removal. Sign-Mart is not responsible for any vehicle damage



MAGNETIC RECEPTIVE SYSTEM FOR CHANGEABLE GRAPHICS

Our 10 mil magnetic graphic system is comprised of Magnetic Receptive Sheeting and Magnet material with an Adhesive backing. Use the Magnet with adhesive as the base layer and simply put the printed Receptive Sheeting on top; the receptive sheets can be layered up to 4 sheets on top of the Magnet. This provides a multitude of magnetic solutions for graphic displays of all sizes ranging from Menu Boards, Directional Signs, Museum Exhibits, Calendars, Trade Shows, P.O.P. Displays, full-wall mural graphics, signs where the basic information remains the same but dates, prices, specials need to be changed, all with easy installation and changeability. The Receptive Sheeting can be printed with **Solvent, Eco-Solvent, UV, and Latex Ink Systems.**

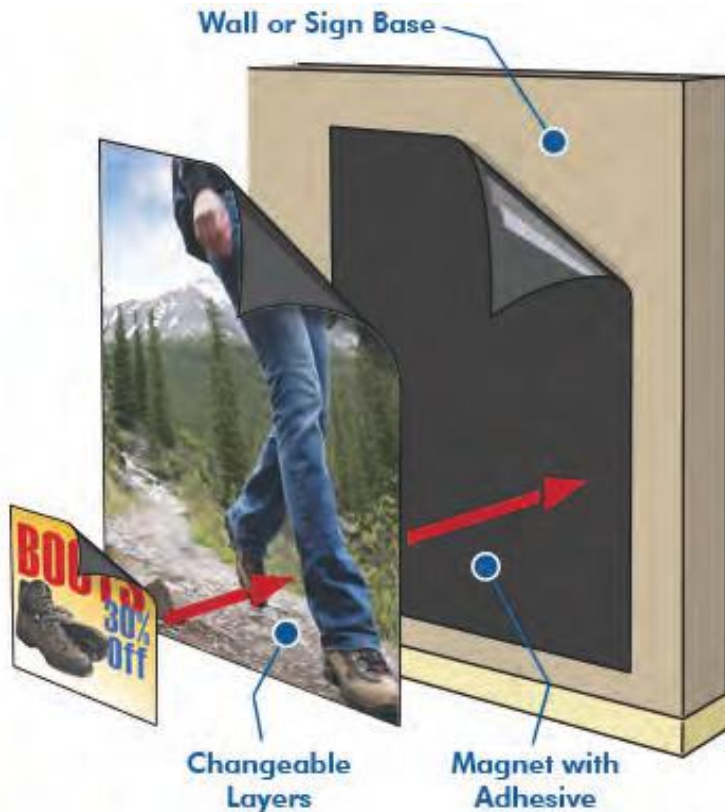

CREATE CHANGE GRAPHICS WITH OUR PRINTABLE MAGNETIC RECEPTIVE SHEETING IN CONJUNCTION WITH OUR MAGNETIC SHEETING WITH MOUNTING ADHESIVE

IDEAL FOR: MENU BOARDS, WALL GRAPHICS AND RETAIL ENVIRONMENTS.

Revised 5-2025

Size	Cost	Item #
50" x 100'	\$315.99	MRP501S
54" x 100'	\$346.99	MRP541S
60" x 100'	\$389.99	MRP601S

magnetic sheet with extreme adhesive

Size	Cost	Item #
24" x 50'	\$198.99	MRP24



Magnetic Vinyl

MagHold has an exclusive digital print [DDP] laminate which is compatible with most **solvent based digital inkjet systems** and is specially formulated to create photo quality images. MagHold's unique extrusion method makes MagHold the absolute smoothest and most flexible magnetic product available.

Print Full Color Magnets

The multi pole magnetization method provides maximum holding

24.375" x 50' | **\$118.99** | Item # MAGP • **20 mil thick**



Revised 5-2025



PVC LAMINATION FILM ECONOMY

2.5-mil, soft PVC film with a UV extension factor of one year. Economy PVC Laminating Film Offers an additional **1 year UV protection** when used indoors and with qualified inks. Clear, water-based, permanent adhesive. Protection of indoor and outdoor digital print applications.

FLAT APPLICATION ONLY

Available in: Gloss | Matte | Semi Gloss

For best results, Utilize ORAFOL ICC profiles available at www.orafolamericas.com and allow solvent-based inks to dry for at least 24 hours (48-72 hours preferred) at 70°F before cutting the graphic to the ink or applying a laminate.

2 YEAR LIFE EXPECTANCY

Item# 200 *Revised 5-2025*
G = Gloss or M = Matte or SG= Semi Gloss (HGT)

30" x 150'	\$143.99
36" x 150'	\$170.99
54" x 150'	\$255.99
60" x 150'	\$281.99

60" DOES NOT COME IN SEMI GLOSS



PVC LAMINATION FILM CALENDERED

2.5-mil, soft PVC film with a **UV extension factor of 2 years**. Minimum Life Expectancy (based on accepted application procedures on vertical surfaces) 4 years Clear, solvent based, permanent adhesive. A cold laminate for protection of medium-term indoor and outdoor digital print applications.

Available in: Gloss | Semi Gloss | Matte

FLAT APPLICATION ONLY

60" DOES NOT COME IN SEMI-GLOSS

4 YEAR MINIMUM LIFE EXPECTANCY

Item# 210 *Revised 5-2025*

G = Gloss or M = Matte or SG= Semi Gloss (HGT)

30" x 150'	\$160.99
36" x 150'	\$194.99
54" x 150'	\$290.99
60" x 150'	\$330.99

60" DOES NOT COME IN SEMI GLOSS



PVC LAMINATION FILM 2.75 MIL.

Soft PVC film with a UV extension factor of three years. Available in gloss, semi-gloss or matte finish. UL certified for UL 969 "Marking and Labeling Systems" (USA) Clear, solvent -based, permanent adhesive. A cold laminate for protection of medium- to long-term indoor and outdoor digital print applications. Minimum **Life Expectancy** (based on accepted application procedures on vertical surfaces) **5 years**. **UV Protection Extension Factor +3 years**. For best results, utilize ORAFOL ICC profiles available at www.orafolamericas.com and allow solvent -based inks to dry for at least 24 hours (48-72 hours preferred) at 70°F before cutting the graphic to the ink or applying a laminate.

FLAT APPLICATION ONLY

Available in: Gloss | Semi Gloss | Matte

Item #215 *Revised 5-2025*

G=Gloss M=Matte SG=Semi Gloss (HGT)

30" x 150'	\$257.99
36" x 150'	\$308.99
54" x 150'	\$466.99



PREMIUM CAST LAMINATING FILM

2 mil, premium cast PVC film with a **UV extension factor of 4 years**. Clear, solvent-based, permanent adhesive. A cold laminate for protection of long-term indoor and outdoor digital print applications. For the protection of digitally or electrostatically printed large - format displays. Minimum Life Expectancy (based on accepted application procedures on vertical surfaces) 8 years. For best results, utilize ORAFOL ICC profiles available at www.orafolamericas.com and allow solvent-based inks to dry for at least 24 hours (48 - 72 hours preferred) at 70°F before cutting the graphic to the ink or applying a laminate.

8 YEAR MINIMUM LIFE EXPECTANCY

Item# 290 *Revised 5-2025*
G = Gloss or M = Matte (HGT)

30" x 150'	\$354.99
36" x 150'	\$424.99
54" x 150'	\$577.99



OVER LAMINATING FILM GLOSS

- 3mil thickness
- Permanent adhesive
- Enhances image clarity
- High gloss clear PVC film
- Up to 4 year outdoor durability (vert. surface) and resistant to ultra violet degradation

General Formulations 400 gloss over lamination vinyl film is designed to protect digital image prints and screen printed images for exhibit and display graphics. Can be used in most instances where overlay with a high gloss finish is required on interior or exterior applications

Item #400 (HGT) *Revised 5-2025*

38" x 150'	\$166.99
54" x 150'	\$235.99



OVER LAMINATING FILM LUSTER

- 3mil thickness
- Semi gloss finish
- Permanent adhesive
- Clear luster flexible overlam
- Up to 4 year outdoor durability (vert. surface) and resistant to ultra violet degradation

General Formulations 401 luster over lamination vinyl film is designed to protect digital image prints and screen printed images for exhibit and display graphics. This product can be used in instances where an overlay with a lustre finish is required for interior and exterior applications.

Item #401 (HGT) *Revised 5-2025*

30" x 150'	\$130.99
38" x 150'	\$166.99
54" x 150'	\$235.99
60" x 150'	\$261.99



402

Overlaminating Matte Film

- 3mil
- Ultimate non glare
- Permanent adhesive
- Clear matte flexible overlam
- Up to 4 year outdoor durability (vertical surface) & resistance to ultra violet degradation

General Formulations 402 matte overlaminating vinyl film is designed to protect digital image prints and screen printed images for exhibit and display graphics. Can be used in most instances where an overlay with a matte finish is required on interior or exterior applications.

Revised 5-2025

Size	Item #	Cost
30" x 150'	402-30	\$130.99
38" x 150'	402-38	\$166.99
54" x 150'	402-54	\$235.99
60" x 150'	402-60	\$262.99

51" Roll can be special ordered



106

Transparency Mounting Film

Designed to mount backlit transparencies to plexiglass or other substrates in light box applications. This product also provides distortion free face mounting of prints. Transparency mounting film is constructed with optically clear polyester that is coated on both side with optically clear adhesive and protected by 2 clear polyester liners. 106 also provides images with valuable UV protection.

Size	Item #	Cost
31" x 150'	106-31	\$308.99
38" x 150'	106-38	\$429.99
54" x 150'	106-54	\$553.99

Revised 5-2025

51" and 61" Rolls can be special ordered

51" Roll can be special ordered



107

Opaque White Mounting Film

1.5mil white opaque polypropylene film coated on both sides with a specially formulated permanent acrylic adhesive that is protected with a 76# liner. Designed to mount photographic, digital, screen printed substrates such as gatorfoam, PVC, posterboard and more...

PRINTED IMAGES TO A SOLID SUBSTRATE

Size	Item #	Cost
31" x 150'	107-31	\$186.99
38" x 150'	107-38	\$247.99
54" x 150'	107-54	\$303.99

Revised 5-2025

51" and 61" Rolls can be special ordered

54" x 150' | Item #116-54 | **\$517.99**

Revised 5-2025



112

Clear Glass Mounting Film

.5mil Clear polyester film coated on both sides with a specially formulated high tack permanent adhesive that is protected with a 76# paper liner. This clear mounting film is designed for long term permanent mounting of digital prints to glass.

A PERMANENT ADHESIVE 2 SIDES

Size	Item #	Cost
38" x 150'	112-38	\$303.99
54" x 150'	112-54	\$335.99

Revised 5-2025

51" Roll can be special ordered



114

Clear Glass Mounting Film

.5mil Clear polyester film coated on one side with a specially formulated high tack permanent adhesive on one side and a removable on the otherside. That is protected with a 76# paper liner. This clear mounting film is designed for short term mounting of digital prints of any kind to glass from the inside out.

Size	Item #	Cost
38" x 150'	114-38	\$323.99
54" x 150'	114-54	\$356.99

Revised 5-2025

51" Roll can be special ordered



116

Clear Glass Mounting Film

116 is a double coated pressure sensitive 1mil clear polyester film with permanent adhesive on one side and removable adhesive on the other side. This product is designed for laminating thin flexible plastic films under 10mil in total thickness for temporary application to glass. The film is designed to produce two sided decals using digital prints, screen prints and other printed images to glass. These decals remove cleanly. 116 may be used on substrates other than glass, your specific application should be tested before production.

54" x 150' | Item #116-54 | **\$517.99**

Revised 5-2025



Stone Guard Film

Series 270 is a **6 mil. 5 year** PVC laminate film for medium term outdoor paint protection of automotive fenders, rear bumpers and deck or side skirts and other outdoor applications. Clear solvent based permanent adhesive.

Revised 6-2025

Size	Cost	Item#
24" x 10yds	\$ 75.99	270-241
24" x 25yds	\$156.99	270-245
30" x 10yds	\$ 95.99	270-301
30" x 25yds	\$193.99	270-305
50" x 10yds	\$155.99	270-501
50" x 25yds	\$321.99	270-505



Perforated Window Film Laminate

A 2 mil. Optically clear premium cast PVC gloss over laminate. Creating signage for windows or other transparent applications, your choice is clear Oraguard® 290GF. 8 year optically clear cast film and other applications where the highest level of clarity and transparency are needed. Available in gloss with a UV protection extension factor of 4 years. Cold lamination is recommended

Size	Cost	Item#
24" x 30'	\$ 78.99	10-290GK-24
30" x 30'	\$ 95.99	10-290GK-30
36" x 30'	\$116.99	10-290GK-36
54" x 30'	\$173.99	10-290GK-54
54" x 150'	\$694.99	290GF-54



Cold Laminate

- 2 year durability
- Economy laminate
- 4mil calendared vinyl
- Available in | matte | gloss | luster
- Protects against abrasion | moisture | limited exposure

Size	Cost	
38" x 147'	\$136.99	28¢ sq. ft.
* 51" x 150'	\$169.99	26¢ sq. ft.
54" x 150'	\$177.99	26¢ sq. ft.
61" x 150'	\$199.99	26¢ sq. ft.

Item #LAM (G = Gloss M = Matte L = Luster)

* 51" Only available in MATTE or GLOSS



4 mil **GRIP** & 12 mil **ARMOR LAMINATE**

Step 1 Print Media

- 5 year outdoor
- 90 lb. lay flat liner
- 4 Mil matte white "GRIP"
- Clear high bond permanent adhesive
- Ink eco - solvent | Latex | Thermal

54" x 150' | **\$646.99** | Item #235-54

Step 2 Protection Laminate

- 53 lb. liner
- 5 year outdoor
- 12 Mil gloss clear laminate
- Clear permanent adhesive

54" x 75' | **\$374.99** | Item #238-54

For best results use 4mil GRIP and the 12mil Armor laminate together.



Revised 6-2025



DOL 1060 Z

- 2.1mil High gloss finish
- Excellent dimensional stability
- Protects image from scratches
- Enhances color and depth of image
- Aids in application of printed graphics
- Superior conformability to irregular substrates
- Dimensionally stable liner for easy converting
- Outstanding durability & outdoor performance
- UV | temperature | humidity | salt spray resistance

Avery DOL 1060 gloss clear cast vinyl is a premium quality, flexible high gloss vinyl film designed as a protective overlamine film for screen and digital printed decals. DOL 1060 offers an exceptional value for applications requiring glossy colors and durability. This product can also be used as an overlamine for floor graphics.

54" x 150' | **\$642.99** | Item #6469



DOL 1360

- High gloss finish (DOL 1360)
- Excellent dimensional stability
- Protects image from scratches
- Enhances color and depth of image
- Aids in application of printed graphics
- Superior conformability to irregular substrates
- Dimensionally stable liner for easy converting
- Outstanding durability & outdoor performance
- UV | temperature | humidity | salt spray resistance

Avery DOL 1360 clear cast vinyl is premium quality, ultra thin and ultra conformable cast vinyl film designed for use as a protective overlamine film for solvent, UV, latex and screen print inks. DOL 1360 offers an exceptional value, while providing excellent conformability, with abrasion resistance and durability. The gloss film now features a synthetic liner that creates a super smooth finish which provides an overall paint like finish of printed graphics.

54" x 150' | **\$563.99** | Item #41027

GENERAL FORMULATIONS 103

Textured Over - Laminating Film

Textured over-laminating film is **designed to protect digital image prints and screen printed images** for exhibit and display graphics. Can be used in most instances where an overlay with non-glare properties is required. This film can be applied to flat, curved or rolled display graphics.

General Formulations 103 Textured Overlaminating Film is a pressure sensitive 5.0 mil velvet / very fine matte polycarbonate film with the optically clear RD-60A, permanent acrylic adhesive with a 1.5 mil polyester film liner. This polycarbonate film offers protection from abrasion, moisture and other environmental exposures. This laminate is applied cold, no heat required.

		Item #
38" x 1yd.*	\$ 15.99	103-3801
38" x 150'	\$383.99	103-38
54" x 1yd.*	\$ 17.99	103-5401
54" x 150'	\$552.99	103-54

* 5 yard minimum *Revised 6-2025*

GENERAL FORMULATIONS 109

Textured Laminate

This scratch resistant laminate is excellent choice for laminating mouse pads, counter mats, floor graphics and displays.

General Formulations 109 is designed for interior use applications. This laminate can be used on floor graphics for up to 6 months under normal use.



Revised 6-2025

38" x 150'	\$317.99	Item #109-38
54" x 150'	\$372.99	Item #109-54

GENERAL FORMULATIONS 211

Gloss Clear Permanent Adhesive

Summary: General Formulations 211 is a 6 mil clear flexible polished calendared vinyl film with a slight texture **designed for use as the protective overlay for Traffic Graffix™** decals. The permanent acrylic pressure sensitive adhesive formulated for exceptional clarity.

General Formulations 211 is intended for use as the over-laminating film to produce Traffic Graffix™ floor decals. The adhesive is formulated to adhere to most common printing inks. However, specific formulations must be tested before use. Some ink may contain excessive flow additives that could reduce adhesion of this product. Test before production.

General Formulations 211 will function as a Traffic Graphic™ over-laminate for six month under normal use. Completely evaporate inkjet solvents before application. Failure to do so may facilitate solvent penetration resulting in vinyl degradation.

54" x 1yd.*	\$ 16.99	Item #211-5401
54" x 150'	\$342.99	Item #211-54

* 5 yard minimum *Revised 6-2025*

GENERAL FORMULATIONS 110

EraseMark Pro

Commercial Grade Dry Erase Laminate with Permanent Adhesive

2-mil clear polyester laminate with a high performance hard coated engineered surface. The scratch and abrasion resistant polyester film is coated with a permanent solvent acrylic pressure sensitive adhesive on a smooth paper liner. This film works well with quality dry erase markers and its anti-graffiti properties allows for easy removal of permanent markers and crayons. EraseMark Pro™ 110 has a 5 year interior durability with proper care and cleaning.

For best results, we suggest the following dry erase brand marking pens:

Expo Scents® (chisel point), Expo Bold color® (chisel Point), Expo regular® (chisel point) brand marking pens. It is recommended to use a microfiber cloth to clean the films surface.

54" x 150'	\$439.99	Item #110-54
------------	-----------------	--------------

Revised 6-2025

DRYTAC®

Pro Tac Scribe

Dry Erase Film

- 2.5mil clear gloss
- Permanent adhesive
- Provides UV protection
- Use low odor dry erase pens
- No liquid for removal of markings
- Always test print sample piece first



54" x 164'	\$365.99	Item #PSC51164
------------	-----------------	----------------

Revised 6-2025

PermaFlex
Textured Laminate

PermaFlex is a 5 mil. Clear PVC film with a luster textured finish to eliminate glare, and is suitable for indoor and outdoor applications. PermaFlex provides protection from abrasion and moisture and helps slow color fade from UV exposure. The durability of the printed image is dependent on the type of ink and media used.

PermaFlex can also be used as a Floor Graphic laminate. Exceeds industry standards for slip resistance, when tested according to BS7976-2.

The outdoor durability in vertical applications is 3 years and indoor vertical applications is 5 years. Indoor floors durability is 1–3 years depending on traffic.



54" x 75'	\$455.99	Item #PF365475
54" x 150'	\$848.99	Item #PF3654150

Revised 6-2025

Nikkalite **ANTI-GRAFFITI** F-CAL Over Lamination

Technologically superior, wipe off permanent markers with just a soft cloth. Spray paint is easily removed with any liquid graffiti remover and a soft cloth. Extremely solvent resistant; paint stripper will not eat through the film.

F-Cal has a unique surface that allows most pressure sensitive materials such as stickers and decals to be easily peeled off.

F-Cal is approved by the Department of Transportation and holds the highest designation by Caltrans as a "Premium Protective" compared to a "standard protective".



BEFORE CLEANING



DURING CLEANING



AFTER CLEANING

IT'S TWO FILMS IN ONE!

A PREMIUM PROTECTIVE ANTI-GRAFFITI OVER-LAMINATE FILM WITH UV INHIBITORS.

Size	Cost	Item #
24" x by Linear Yard	\$ 22.99	FC24
24" x 10yds	\$165.99	FC2410
24" x 50yds	\$740.99	FC2450
30" x by Linear Yard	\$ 34.99	FC30
30" x 10yds	\$188.99	FC3010
30" x 50yds	\$843.99	FC3050
48" x by Linear Yard	\$ 40.99	FC48
48" x 10yds	\$305.99	FC4810
48" x 50yds	\$1360.99	FC4850

Revised 6-2025

GENERAL FORMULATIONS 108

- Long-term protection
- Outstanding graffiti resistance
- 1mil clear, flexible overlamine
- Weather / UV resistant up to 10 years



DuPont™ Tedlar film: New and improved film delivers superior UV protection, anti-graffiti with extreme durability and chemical resistance for a variety of indoor/outdoor applications.

54" x 150' | \$642.99 | Item #108-54

Revised 6-2025

VANDAL GUARD Anti Graffiti Laminate Dry Erase Laminate

- 1 mil
- High gloss finish
- Dry erasable surface
- Permanent acrylic adhesive
- Protects graphics from graffiti

NOT FOR USE ON CORRUGATED PLASTIC OR ACRYLIC

Vandal Guard™ Anti-Graffiti / Dry Erase Laminate is a specially formulated overlamine designed to protect screen printed and digitally printed images and signs from a wide variety of stains and chemicals including paint and permanent marker. Graffiti can be easily removed using common economical cleaners without damaging or dulling the surface of the laminate

Graffiti - Resistant Surface: Spray paint and permanent marker easily wipes away with economical cleaners.

High Gloss Finish: Signs and graphics have a classy professional look with enhanced color and depth

Ultra Clear Permanent Adhesive : Long lasting bond to vinyl and / or substrate eliminating premature delamination and also allows for use with window perforated graphics on flat surfaces

Clear Poly Liner: Ultra smooth adhesive overlay eliminating "orange peel" often found on laminates with a paper liner

54" x 100' | \$303.99 | Item #VG54

Revised 6-2025

AVERY Anti Graffiti Film

- 1mil high gloss film
- Clear solvent based adhesive
- UV extension factor of 3 years
- Designed for high quality protection of large format digital prints for outdoor applications

Avery Dennison Anti-Graffiti Series films delivers excellent abrasion and scratch resistance for short-term graphics. They are specifically designed to protect digital or screen printed graphics.

Revised 6-2025

54" x 1' | \$ 7.99 | Item #3623FT

54" x 150' | \$737.99 | Item #A001542

ARE YOU LOOKING FOR A LIQUID ANTI GRAFFITI SOLUTION? SEE PAGE 39 FOR MORE OPTIONS.

ANTI-GRAFFITI..

CLEARSHIELD® Classic



LIQUID LAMINATE COATINGS

ClearShield water-based liquid laminate coatings offer the same protection as film laminates while saving as much as 60% in production costs. UV-protection, chemical resistance, abrasion resistance and flexibility are just some of the benefits of protecting your digital prints with ClearShield liquid laminate. Our coatings are specifically formulated for a variety of inks and applications such as banners, wall coverings, canvas prints and vehicle graphics, also suitable for vertical applications.

ClearShield Classic is formulated for use with most non-water sensitive material.

	Gloss		Semi Gloss		Matte
Aerosol Can	\$21.99 Item #CSGA	Aerosol Can	\$21.99 Item #CSSA	Aerosol Can	\$21.99 Item #CSLA
Quarts	\$44.99 Item #CSGQ	Quarts	\$44.99 Item #CSCQ	Quarts	\$44.99 Item #CSMQ
Gallons	\$112.99 Item #CSGG	Gallons	\$115.99 Item #CSSG	Gallons	\$122.99 Item #CSMG
5 Gallon	\$521.99 Item #CS5GG SPECIAL ORDER	5 Gallon	\$537.99 Item #CSSG SPECIAL ORDER	5 Gallon	\$579.99 Item #CS5GM SPECIAL ORDER

Revised 6-2025

Please see Product Information on website for more information

KRYSTALKOTE™ CTF CAL TRANS FORMULA

Fade and Graffiti Resistant Clear Coating



- Anti graffiti
- Gloss clear coat
- Crack resistant surface
- CTF is flexible and tolerant to expansion
- Protect traffic & commercial signs even vehicles
- Great for harsh environments like salt water and high desert heat and frigid mountains
- Resistant to hydraulic, lubricating and cutting oils, alcohols and more



1 Quart \$ 67.99 | Item #KKQT
Gallon \$236.99 | Item #KKGAL



Revised 6-2025

WILL CALL or LOCAL DELIVERY ONLY
APPROVED BY LOS ANGELES AND CALTRANS



Speed Dry UV Acrylic Clear

1 Shot Speed Dry UV Acrylic Clear is a fast drying UV resistant clear topcoat that prevents colors from fading and provides mild abrasion resistance. Intended for use on interior or exterior digital prints in non - automotive applications. Dries to touch in 2 hours / UV resistant Compatible Surfaces - Printed PVC vinyl's and solvent, eco-sol, UV and thermal resin prints. Available in Quarts and 12oz Aerosol Spray Cans



Revised 6-2025

SHIPS GROUND SPECIAL
LABELED CONSUMER COMMODITY ORM D
Aerosol can | \$20.99 | Item #4005A
Quarts | \$61.50 | Item #4005Q



ClearShield Anti-Graffiti Gloss is a two-part, water-based liquid laminate with excellent chemical resistance, abrasion resistance and unmatched anti-graffiti properties.

This versatile coating has exceptional durability and is specifically formulated for severe exterior applications where hardness, flexibility and superior protection are required.

- * Able to be cleaned with a range of solvents
- * Effective for removable of aerosol paints and Mark-A-Lot Pens
- * 2 part Lam Coating is highly flexible and durable
- * Compatible with Eco-Solvent, Latex and UV inks
- * Gloss finish



LIQUID LAMINATE - PART A		
SIZE	COST	ITEM #
Quarts	\$ 44.99	360264324
Gallons	\$115.99	360259324

ACTIVATOR - PART B		
SIZE	COST	ITEM #
4 FL. OZ.	\$14.99	AGCTAA
16 FL. OZ.	\$35.99	AGCTQQ

Revised 6-2025

Please see Product Information on website for more information

Mixing Ratio Chart	
Part A	Part B
1 Quart (32 fl. oz.)	4 fl.oz.
2 Quart (64 fl. oz.)	8 fl.oz.
3 Quart (96 fl. oz.)	12 fl.oz.
1 Gallon (128 fl.oz.)	16 fl.oz.

(8:1 Ratio per U.S. Liquid Volume)

ThermoFlex PLUS Thermal Lettering

T-Shirts | Sports Wear | Flags

Thermo-Flex Plus is a heat transfer material suitable for most cotton, cotton - polyester, wool, lycra, and other basic fabrics including many athletic mesh fabrics. The self adhesive layer permits high speed cutting, ultra fine detail and easy weeding

	5 yard roll	10 yard roll	25 yard roll	30 yard roll
15" Regular Colors	\$40.99	\$79.99	\$196.99	\$222.99
15" Silver gold	\$44.99	\$85.99	\$206.99	\$235.99
15" Neon Colors	\$52.99	\$98.99	\$235.99	\$268.99
15" Metal Flakes	\$54.99	\$103.99	\$248.99	\$283.99
*30" Regular Color	\$82.99	\$159.99	\$391.99	\$443.99

Revised 6-2025

 PF151 P241 White	 PF1512 Royal Purple •
 PF163 Chocolate Brown	 PF154 Kelly Green •
 PF152 P242 Black	 PF162 Vanilla Cream •
 PF158 P248 Red	 PF155 Hot Pink •
 PF165 Dusty Rose	 PF170 Storm Grey •
 PF166 Medium Pink	 PF169 Teal
 PF150 Orange	 PF1530 Antique Silver •
 PF159 Maroon	 PF1521 Old Gold •
 PF1511 Athletic Gold	 PFN1543 Neon Pink •
 PF172 Lemon Yellow	 PFN1540 Neon Yellow •
 PF1510 Medium Yellow	 PFN1542 Neon Orange •
 PF160 Navy Blue	 PFN1541 Neon Green •
 PF156 P246 Royal Blue	
 PF164 Sky Blue	
 PF153 Columbia Blue •	 PF1193 Aqua Green •
 PF1513 Forest Green	 PF171 Apple Green •

*30" AVAILABLE in Black | White | Red | Royal Blue
• THESE COLORS CAN NOT BE LAYERED

All technical information and recommendations are based on tests we believe to be reliable. However, we can not guarantee performance for conditions not under manufacturer's control. Before using, **PLEASE determine the suitability of product for its intended use.** ALWAYS TEST PRIOR TO RUN. The user assumes all risk and liability whatsoever in connection with the use of this product. Sellers and manufacturers only obligation shall be to replace such quantity of the product proved to be defective by manufacturer.

Specialty Materials 
THE BEST GARMENT DECORATION PRODUCTS

SILVER SAFETY REFLECTIVE

Reflective Heat Transfer Film

Use SAFETY REFLECTIVE for nighttime visibility and brilliance in the spotlight!

SAFETY REFLECTIVE films consist of very small glass beads embedded in a layer of polyester film to reflect almost all the light that shines on them.

SAFETY REFLECTIVE is available in the Certified Safety Reflective Color, Safety Silver. Safety Silver is a retro - reflective film produces a maximum reflectivity of 675 candela / lux / meter. This product does not have a sticky carrier. Use Safety Silver for garments and other products used by police, firefighters, EMS, postal workers, traffic control, parking, utility, road, construction, security personnel, runners, bicyclists and motorbikers, among others.

FOR NYLON AND OTHER HEAT SENSITIVE FABRICS

 RF9501 Silver

	5 yard roll	10 yard roll	25 yard roll	50 yard roll
20"	\$130.99	\$246.99	\$586.99	\$1118.99

Specialty Materials 
THE BEST GARMENT DECORATION PRODUCTS

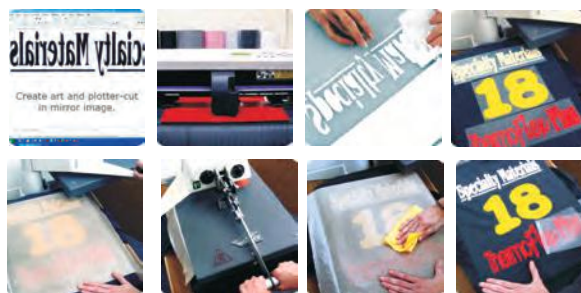



HTM

NEW PRODUCT

Vinyl Heat Transfer Film

Application Instructions Available

A patented high-gloss, medium weight vinyl film on a clear, heat-stabilized film. H.T.M. Heat Transfer Film has a superior bonding polyester adhesive. For use on computerized knife cutting machines. Great for pre-registered names on football jerseys, Poly Canvas Bags, Athletic Apparel, Hobbies & Crafts and Home Furnishing. Recommended Fabrics : Cotton, Polyester and Lycra/Spandex Blends.

	15" x 5yrd	15" x 10yrd	15" x 50yrd
 Black	HTB5	HTB10	HTB50
 White	HTW5	HTW10	HTW50
 Scarlet Red	HTSR5	HTSR10	HTSR50
	\$30.99	\$59.99	\$209.99

Revised 6-2025

Easy Weed



Thermo Weldable PVC Free Material

Easy Weed is thermo weldable PVC free material for CAD applications onto non siliconized textiles. Easy Weed offers excellent washability as well as durability, It has a pressure sensitive carrier which allows you to weed small letters and fine design easily.

Use on:

100% Polyester • 100% Cotton • All polycotton blends

EW5001 White	EW5009 Fuchsia
EW5002 Black	EW5010 Light Blue
EW5003 Royal Blue	EW5011 Brown
EW5004 Navy	EW5012 Gold
EW5005 Red	EW5013 Silver
EW5006 Yellow	EW5014 Burgundy
EW5007 Green	EW5015 Purple
EW5008 Orange	EW5021 Bright Red
	EW5022 Lemon Yellow

Revised 6-2025

	5 yard roll	10 yard roll	25 yard roll	50 yard roll
15"	\$41.99	\$77.99	\$178.99	\$333.99

Easy Weed FLUORESCENT



Easy Weed Fluorescent is designed specifically for sports garmets. Easy Weed Fluorescent has a high opacity and matte finish.

EW5016 FL Yellow
EW5017 FL Orange
EW5018 FL Green
EW5019 FL Fucshia
EW5020 FL Royal Blue

Acceptable Fabrics

100% Polyester | 100% Cotton and all Poly / Cotton blends

Revised 6-2025

	5 yard roll	10 yard roll	25 yard roll	50 yard roll
15"	\$44.99	\$83.99	\$202.99	\$395.99

DecoFILM[®] Metal Foil Appearance

- Add value to your fashion designs with the brilliant accent of reflective metals
- The Super styles offer a slightly softer hand and stretchability
- The Brilliant styles offer a smoother, chrome like surface that are dimensionally stable
- Super Silver and Super Gold are Oeko-Tex Class II Certified
- Manufactured without the pressure - sensitive carrier for easy stacking

SS5200 Silver
SG5250 Gold

Revised 6-2025

	5 yard roll	10 yard roll	25 yard roll
19"	\$86.99	\$156.99	\$353.99

Acceptable Fabrics
Cotton | Uncoated Polyester | Fabric Blends
Spandex* | Lycra* | Wool | Linen

DOES NOT STICK TO NYLON

ColorPrint[™]

Printable Heat Transfer

Color Print Solvent / Ecosol[™] The best quality, brightest digital prints on the market! Digital Media for Textile Transfers Designed for Solvent/Eco-Solvent & Latex Inks White 2.8 mils Semi-gloss to full gloss finish with excellent stretch and durability. Maintains rebound through numerous washes. Contains blockers to prevent dye-migration (bleeding) with Polyester and Poly-Blend fabrics.

Acceptable Fabrics Pre-Shrunk Cotton, Uncoated Polyester, Fabric Blends, Wool, Linen. Excluding Nylon For printing with Latex ink: ***You must use TM-853 or TM-854, use Gloss Vinyl Profile, print uni-directional, and never heat above 205°F/96°C on the printer settings.**

	5 yard roll	10 yard roll	25 yard roll
24"	\$94.99	\$178.99	\$373.99
	#CPS21605	#CPS21601	#CPS2160

Revised 6-2025

Specialty Materials
THE BEST GARMENT DECORATION PRODUCTS

Application Tape

TransferRite® ULTRA™ 592U HIGH TACK

Application Tape for
Exact Registration

- 100 yard rolls
- A more professional, profitable job
- Low & Medium tack available in 48"
- Easy to handle, more body to the paper
- Reduced wrinkling, tunneling and edge lift *Revised 6-2025*

TransferRite Ultra application tape is for those applications where exact registration is critical. Just pick up and position your vinyl over ready to apply graphics.



More than 6 slits, additional charge of \$1.00 per slit

Size	Cost	Item #
1"	\$ 7.99	59U1
2"	\$12.99	59U2
3"	\$16.99	59U3
4"	\$23.99	59U4
6"	\$33.99	59U6
8"	\$44.99	59U8
10"	\$56.99	59U10
12"	\$66.99	59U12
14"	\$68.99	59U14
16"	\$77.99	59U16
18"	\$87.99	59U18
24"	\$116.99	59U24
30"	\$145.99	59U30
48"	\$208.99	59U48

TransferRite® ULTRA CLEAR 1310

Ultra Clear
Non Yellowing

- Increased Quick Stick
- Superior adhesion to liner
- Improved clarity / non -yellowing



Revised 6-2025

30" x 100 yds | **\$179.99 ea.** | Item #UC1310-30

48" x 100 yds | **\$268.99 ea.** | Item #UC1310

More than 6 slits, additional charge of \$1.00 per slit

Poli-Tape 130

Application Tape at
Economy Prices

Logs Cut to Your SPECIFICATIONS



- 100 yd roll
- Lay Flat Properties
- Good Adhesion Silicone Paper
- Special High Tac Natural Rubber Adhesive
- Premium Paper with Excellent Tear Strength
- Suitable for all Vinyl Films with Gloss or Matte Surfaces

Revised 6-2025

48" x 100 yards | **\$118.99 ea.** | Item #PT130

More than 6 slits, additional charge of \$1.00 per slit

Poli-Tape 160 Ultra Clear

- 100 yard rolls
- Medium - high tac acrylic adhesive
- Suitable for dry and wet applications
- Lay flat properties...film does not curl!

ALSO
Available
Pre-Cut Sizes



Logs Cut to Your SPECIFICATIONS

Size	Cost	Item #
4"	\$15.99	PT04
6"	\$23.99	PT06
8"	\$29.99	PT08
10"	\$34.99	PT10
12"	\$39.99	PT12
14"	\$46.99	PT14
16"	\$53.99	PT16
18"	\$60.99	PT18
24"	\$79.99	PT24
30"	\$99.99	PT30
48"	\$145.99	PT48

Revised 6-2025

Ultra clean finish allows easy transfer of computer cut letters, logos and symbols with one to multiple colors

More than 6 slits, additional charge of \$1.00 per slit



REGULAR PAPER. NOT CLEAR
R TAPE 4075



All-purpose application tape for sign shops
Small and medium plotter cut lettering and printed graphics
User-friendly easy unwind and clean tearing features
Holds up very well in wet method applications
If the adhesive side folds on itself, the tapes pull apart easily with no delamination.

30" x 100 yds | **\$140.99** | Item #RT30

48" x 100 yds | **\$213.99** | Item #RT48

More than 6 slits, additional charge of \$1.00 per slit



MAIN TAPE
COMPANY, INC

Perfectear 575



- No curling
- Easy to handle
- Unwinds easily
- No gluey mess
- A smooth release
- No adhesive residue
- Tears cleanly with no stringy adhesive
- Can reduce errors in applying graphics

48" x 100 yds | **\$181.99** | Item #MT575

More than 6 slits, additional charge of \$1.00 per slit *Revised 6-2025*



A NEKOOSA BRAND

Conform



REGULAR PAPER. NOT CLEAR
With release liner
adhesion technology

- Comprehensive product line
- Trouble free storage and transport
- Adheres better to exposed release liners
- Superior lay flat - resist edge curl and tunneling
- Superior conformity presents a neat professional image

48" x 100 yds | **\$227.99** | Item #RC48

More than 6 slits, additional charge of \$1.00 per slit

ORATAPE
HT55

Decorative
film transfer
tape



A semi transparent transfer film featuring a specially featured high tack adhesive allowing the tape to stick to silicone release liners. Graphics stay flat with no tunneling after tape is applied for smoother graphics and faster application

Recommended use with Oracal's 631 Series

More than 6 slits, additional charge of \$1.00 per slit

48" x 100 yds | **\$200.99** | Item #HT55 - 48

Tuff Tape



- Indoor application
- General purpose double sided adhesive tape

Revised 6-2025

Size	Cost	Item #
1/2" x 60 yds	\$17.99	T012
3/4" x 60 yds	\$21.99	T034
1" x 60 yds	\$26.99	T001
2" x 60 yds	\$54.99	T002

Tesa Tape

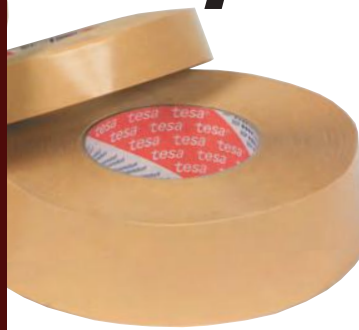

- Indoor application
- Double sided self adhesive tape

Revised 6-2025

Size	Cost	Item #
1/2" x 60 yds	\$36.99	TT12
3/4" x 60 yds	\$50.99	TT34
1" x 60 yds	\$57.99	TT01
2" x 60 yds	\$104.99	TT02

Banner Tape



Formulated to apply to vinyl banner material for fabrication hems. This adhesive is weather proof and **very strong**. Banner tape hems will not come apart.

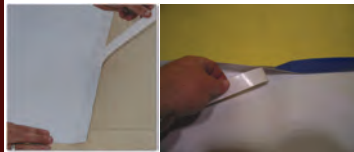

Revised 6-2025

Size	Cost	Item #
1" x 72 yds	\$21.99	BT01
1" x 72 yds	\$20.99	BT01 6+
1.5" x 72 yds	\$36.99	BT11
1.5" x 72 yds	\$33.99	BT11 6+

Pole Tape

1" x 200ft

Adhesive for pole pocket banners and splicing media

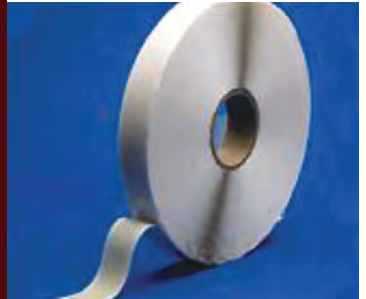

This super strong adhesive goes on like tape but sticks like a hot glue gun. Use pole tape instead of sewing to create dowel pockets for pole pockets, or joining banner media. It may also be used for permanent mounting on wood, rigid plastics and metal

Revised 6-2025

\$83.99 ea. | Item #POLETP

3M Micro Adhesive

5 mil adhesive transfer tape

- UV resistant
- Chemical resistant
- Easy apply / no mess
- Easy to die-cut process
- Great solvent resistance
- High temperature tolerance
- Excellent moisture resistance



Size	Cost	Item #
24" x 180yds	\$1625.99	3M468180
24" x 1 foot	\$25.99	3M46801

Revised 6-2025

XTRA High Bond

Our generic VHB Tape

This tape has exceptional conform abilities for applying to flat and curved substrates. It has excellent weather and exterior applications. Good for interior and exterior applications



Clear

Size	Cost	Item #
1/4" x 36 yds	\$15.99	XHB14
3/4" x 36 yds	\$39.99	XHB34
1" x 36 yds	\$52.99	XHB01

Revised 6-2025

XTRA High Bond

Our generic VHB Tape

3/4" x 36yds

This tape has exceptional conform abilities for applying to flat and curved substrates together for industry such as construction and signage. Provides excellent long term holding power and works well under extreme weather and high temperature conditions



White or Dark Grey

\$39.99 ea. | Item #XHB1

Revised 6-2025

ORAFOL

Oramount UHB 3601 SERIES

Consists of a white foamed acrylic pressure sensitive adhesive designed for high performance bonding and mounting applications. The Elastomeric nature of the foamed adhesive makes it ideal when conform ability and expansion is a concern.



Size	Cost	Item #
1/2" x 36 yds	\$51.99	3601-12
3/4" x 36 yds	\$64.99	3601-34
1" x 36 yds	\$77.99	3601-01

Revised 6-2025

Foam Tape



1/32" Thick Foam Tape

Cost	Size	Item #
\$24.99	1/2" x 72yd	FT13
\$29.99	3/4" x 72yd	FT33
\$36.99	1" x 72yd	FT31

Revised 2-14-23

1/8" Thick Foam Tape

Cost	Size	Item #
\$ 9.99	1/2" x 18 yds.	FT18
\$11.99	3/4" x 18 yds.	FT38
\$15.99	1" x 18 yds.	FT81

Masking Tape



Comparable to all others. Excellent adhesive at a lower price (**Compare and Save**)

Revised 6-2025

Size	Cost	Item #
3/4" x 60yd	\$3.99	MT34
1" x 60yd	\$3.99	MT01
1.5" x 60yd	\$6.99	MT112
2" x 60yd	\$6.99	MT02

Gorilla Tape

In a league all its own

2" x 36 yards



Made to stick to rough, uneven, unforgiving surfaces like wood, stone, stucco, plaster, brick and more

\$11.99 ea. | Item #6035120

Nylon Webbing

1" Standard



Item #1NWB

\$87.99 | Size 100 yards

Nylon Webbing

Heavy Duty



100 yards

Cost **Size** **Item #**
\$35.99 | Size 1" | 1HDW

\$60.99 | Size 2" | 2HDW

Velcro with adhesive

Mini Economy & white

3/4" Hook Loop
 Item #EM34H
 15ft. for **\$10.00 each**

Revised 6-2025



White Premium Velcro 25 yard rolls

Size	Cost	Hook #	Loop #
3/4" Hook or Loop	\$32.99 each \$25.99 4+	P34HW	P34LW
1" Hook or Loop	\$33.99 each \$28.99 4+	P1HW	P1LW

Revised 6-2025

Economy Velcro 25 yard rolls

Size	Cost	Color	Hook #	Loop #
3/4" Hook or loop	\$20.99 ea. \$18.99 4+	White	E34HW	E34LW
3/4" Hook or loop	\$20.99 ea. \$18.99 4+	Black	E34HB	E34LB
1" Hook or loop	\$22.99ea. \$20.99 4+	White	E1HW	E1LW
1" Hook or loop	\$22.99 ea. \$20.99 4+	Black	E1HB	E1LB
2" Hook or loop	\$31.99 ea. \$30.99 4+	White	E2HW	E2LW

Revised 6-2025



BANNER UPS CLEAR
PowerTape
HEM REINFORCING TAPE
Clear PowerTape - PTAPECLEAR

- New clear version of *PowerTape*
- Super strong single-sided tape
- Reinforces banner edges without folding a hem
- Great for double-sided printed banners
- Create a banner in only 3 minutes vs 15-20 minutes with old method of two sided tape & grommets

PTAPECLEAR Packaging: 36 yards/roll; 5 rolls/case Size: 1.5" wide x 36 yard length

Size 1.5" W x 36 yards | **\$28.99 each** | Item #PTAPECLEAR

Revised 6-2025



PowerTape - White PTAPE
HEM REINFORCING TAPE

- Single-sided superstrong tape
- No need to sew or fold a hem
- Create superstrong banners of any length in a few minutes
- Just apply over tabs along top and bottom edges, then punch hole
- *PowerTape* helps reduce edge curl

PTAPE Packaging: 36 yards/roll; 5 rolls/case Roll Size: 1.5" wide x 36 yard length

Size 1.5" W x 36 yards | **\$31.99 each** | Item #PTAPE

Revised 6-2025



MEGATAPE
HEM REINFORCING TAPE

- Double-sided version of *PowerTape*
- Use with tabs to create hurricane strength banners in minutes
- More than triple the strength of ordinary banner hem tapes
- Produces an attractive fold-finished banner edge
- See amazing 108mph wind test video at www.bannerups.com

MEGAT Packaging: 30 yards/roll; 5 rolls/case Roll Size: 1.5" wide x 30 yard length

Size 1.5" W x 30 yards | **\$34.99 each** | Item #MEGAT

Revised 6-2025



POWER PUNCH

- Heavy duty hole punch "right-sized" for Banner Ups center hole
- Cuts cleanly through tabs, tape and banner media
- Cuts 5/16" hole in tabs and heavy duty media with ease
- Wide jaw will easily punch clean hole in 4mm corrugated plastic
- Available discounted in convenient Starter Kit for "Banner Ups beginners"

\$57.99 each | Item #BUPP | Replacement Die **\$19.99 each** | Item #RDPP

Revised 6-2025



TEXTAPE - TEX0925, TEX1925
TEXTILE HEMMING TAPE



- New double-sided tape that sticks to fabric and textiles
- Hem banners & flags in minutes without sewing
- No sewing equipment cost
- No sewing labor required
- Make pole pockets easily in textile banners

Revised 6-2025

TEX1925 Packaging: 6 rolls/case Tape Size: 3/4" x 27 yd Packaging: 12 rolls/case Tape Size: 3/8" x 27 yd

Size 3/8" **\$27.99** [27 yards] | Item #**TEX0925** // Size 3/4" | **\$45.99** [27 yards] | Item #**TEX1925**



POLETAPE PRO - POLEPRO-120



- Make pole pocket banners without sewing or welding
- New adhesive formula & greater temperature range
- Create super durable pole banners
- Great substitute for expensive "high bond" adhesives
- Use for permanent sign and trophy mounting too!

recommended for 2 sided media

POLEPRO-120 Packaging: Individual rolls; 8 rolls per/case Roll Size: 1.0 inch wide x 108 feet (36yd) long

Size 1" wide **\$53.99** [36 yards] | Item #**POLEPRO-120**

Revised 6-2025

Forget Grommets! Try a
Banner Ups Starter Kit
Everything you need in one kit.

KIT CONTAINS:

- 1 Pack *BravoTabs* (100)
- 1 Roll *PowerTape* (36yd)
- 1 *PowerPunch*

INTRO SPECIAL REG. \$115.00
ONLY \$103.99

Start saving time and money today!

\$103.99 | Item #**STARTKT4AS**

Revised 6-2025



PowerTabs, Large White



- White tabs are lower in cost than clear but just as strong
- Super strong and durable for outdoor use
- Large PowerTabs are 3 times stronger than grommets!
- Use PowerTabs neck loop for "no-grommet" hanging of rigid board
- Great for use with lightweight films such as polypropylene

Packaging: 4 tabs per sheet; 25 sheets/bag (100); 5 bags/case (500) Tab Size: 2.125" x 5.5"

\$31.99 [100 per pack] | Item #PTW

Revised 6-2025



Crystal Clear PowerTabs

- Crystal clear tabs let your color image shine through
- Corner friendly shape looks great on banner
- Neck loop option for quick and fast light-duty hanging
- Use center hole for maximum outdoor strength

Packaging: 4 tabs per sheet; 25 sheets/bag (100); 5 bags/case (500) Tab Size: 2.125" x 5.5"

\$45.99 [100 per pack] | Item #PTC

Revised 6-2025



Banner Ups Large White

- Make banners in minutes without grommeting or hemming
- Three times stronger than grommets alone
- Fast and easy installation – Just peel and stick
- Neck loop option for fast light-duty hanging
- Use center hole for maximum outdoor strength
- Use to repair failed grommets

Packaging: 100 tabs/bag; 5 bags/case (500) Tab Size: 2.0" x 5.75"

\$34.99 [100 per pack] | Item #BUP

Revised 6-2025



Crystal Clear BravoTabs - BAN 017

- Large square "one size fits all" tab
- Tab looks great along edges or on corners
- No neck loop - Cleaner banner appearance
- Use with PowerTape or MegaTape for ultimate strength
- Available in convenient Starter Kit for "Banner Ups beginners" (see promotion below)

Packaging: 4 tabs/sheet; 25 sheets/pk (100); 5 pks/case (500) Tab Size: 1.875" x 1.875"

\$39.99 [100 per pack] | Item #BAN017

Revised 6-2025



POLYTABS - BAN 061AS - White BAN 062 - Clear



- Low cost for high volume users. 2000 tabs/roll, 4 tabs per sheet
- Available in White or Crystal Clear versions
- Maximizes strength of lightweight films like polypropylene
- Convenient dispenser box of 2000 tabs for fast application
- So easy customers can do it themselves. Include a sheet with banner!

Packaging: 2000/dispenser box Tab Size: 1.5" x 1.5"

\$300.99 [2000 per roll] | Item #BAN 061AS [white] | Item #BAN 062 [clear]



Apply PowerTabs®



Apply PowerTape® along top and bottom edges on back of banner



Punch hole

Revised 6-2025

Brown Kraft Lamination Paper

Coated Lamination Paper

- 30 lbs brown kraft paper
- Coated with a machine glaze
- A backer to protect bottom roller from adhesive

Size	Cost	Item #
55" x 812'	\$138.99	KP55
60" x 812'	\$146.99	KP60

Revised 6-2025



White Butcher Paper

- Paper banners
- Separating stacked signs
- Wrapping signs for customers
- Covering work areas or floors

Revised 6-2025

Size	Cost	Item #
24" x 1100' 50lbs	\$ 83.99	BP24
36" x 1100' 50lbs	\$115.99	BP36
48" x 1100' 50lbs	\$157.99	BP48
60" x 1100' 50lbs	\$199.99	BP60



Pounce Paper

For making patterns

Size	Cost	Item #
15" x 500' PUNCHED	\$78.99	PP15P
15" x 500' unPUNCHED	\$78.99	PP15
30" x 300' PUNCHED	\$141.99	PP30P
30" x 300' unPUNCHED	\$141.99	PP30

Revised 6-2025



Brown Kraft Paper

- Paper banners
- Separating stacked signs
- Wrap signs for customers
- About 3¢ per square foot

Size	Cost	Item #
24" x 1025'	\$ 70.99	BK24
36" x 1025'	\$ 96.99	BK36
48" x 1025'	\$126.99	BK48
60" x 1025'	\$137.99	BK60

Revised 6-2025



Pounce powder on page 141

Super Glue

Super Strong Adhesive

Super Glue, the first super glue that keeps holding strong, even when the bond takes a hit we call it our Impact-Tough™ Formula. Just hold in place for 30-60 seconds while the formula sets, no clamping necessary.



Revised 6-2025

15 gram | \$5.99 ea. | Item #780501



Adhesive

Bonding Adhesive

Gorilla Glue bonds materials other adhesives simply can't - metal, stone, wood, ceramics, foam, glass and much more! And it's still the best glue for anyone who wants the job done right. Plus, it's now available in a faster setting formula and a Precision Glue Pen for pin point applications.

4oz | \$10.99 ea. | Item #50004
8oz | \$15.99 ea. | Item #50008



Sealit Edge Sealer

Here's a fast, simple answer to your edge sealing problems with SIGNGOLD and other vinyl applications that require edge protection from washing, polishing & excessive physical contact.



Revised 6-2025



\$16.99 ea. | Item #SP22K

Sign-Mart Silicone Adhesive

- Water tight and flexible
- High performance silicone
- Great for interior & exterior letter installs

Curved Point Tip

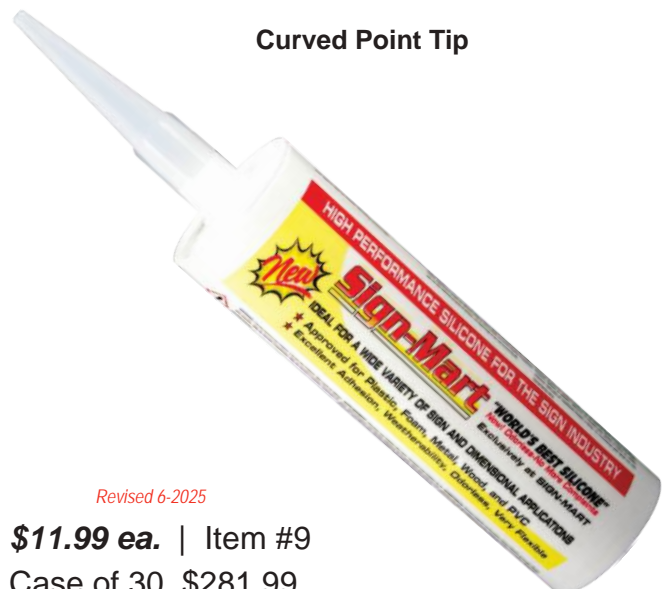

Revised 6-2025

\$11.99 ea. | Item #9
Case of 30 \$281.99

Stock ADA Signs



8" x 8" Men Wheel Chair
Item #88MH
\$12.99 each
Blue Black



8" x 8" Women Wheel Chair
Item #88WH
\$12.99 each
Blue Black



8" x 8" Unisex Wheel Chair
Item #88UH
\$14.99 each
Blue Black



8" x 8" Unisex
Item #88UX
\$12.99 each
Blue Black



8" x 8" Women
Item #88WN
\$12.99 each
Blue Black



8" x 8" Men
Item #88MN
\$12.99 each
Blue Black



12" Women
Item #12WN
\$13.99 each
Blue Black



12" Men
Item #12MN
\$13.99 each
Blue Black



12" Unisex
Item #12UX
\$19.99 each
Blue Black



12" Blank Unisex
Item #12AGBLK
\$15.99 each
Blue Black



12" All Gender
Item #12AG
\$17.99 each
Blue Black



8" x 8" All Gender Wheel Chair
Item #88AG
\$18.99 each
Blue Black



12" Girls
Item #12GS
\$14.99 each



12" BOYS
Item #12BS
\$14.99 each



4" x 4" Exit
Item #44EX
\$13.99 each



6" x 6" Exit
Item #66EXRT
\$26.99 each

STICKERS



5" x 5" Handicap sticker
Item #HS55
99¢ each



7" x 7" Handicap sticker
Item #HS77
\$1.99 each



5" Women
1/32 Tactile White
Item #5WN1
\$2.99 each



5" Man
1/32 Tactile White
Item #5MN1
\$2.99 each



2" Tall wheel chair symbol
1/32 Tactile White
Item #HPAS
\$2.99 each



12" x 24"
.063 Aluminum
with reflective face
Item #HP32R
\$42.99 each 1-5
\$39.99 each 6+



12" x 24"
.063 Aluminum
with reflective face
Item #HP32RVA
\$45.99 each 1-5
\$39.99 each 6+



24" x 24"
.063 Reflective
Aluminum
Item #R100B
\$51.99 each



12" x 9"
.063 Aluminum
Reflective face
Item #MFRO6
\$14.99 each



12" x 6"
.063 Aluminum
with reflective face
Item #VA30
\$14.99 each



24" x 24" Stop Sign
.080 Aluminum
Reflective face
Item #ST24
\$59.99 each

30" x 30" Stop Sign
.080 Aluminum
Reflective face
Item #ST30
\$83.99 each



18" x 24"
.080 Aluminum
REFLECTORIZED
Item #RS04
\$28.99 each

.032 Aluminum - Imprinted with the California Vehicle Code (C.V.C.) Requirements | EXTRA PACKAGING CHARGES IF SHIPPED

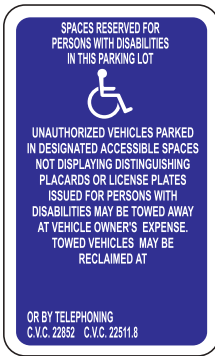

18" x 24"
.032 Aluminum
Item #HP210
\$33.99 each

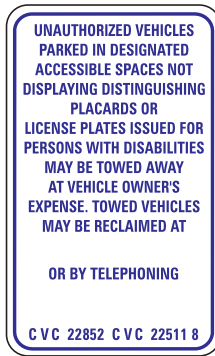

18" x 24"
.032 Aluminum
Item #HP28
\$33.99 each



18" x 24"
.032 Aluminum
\$18.99 ea. | Item #PS18

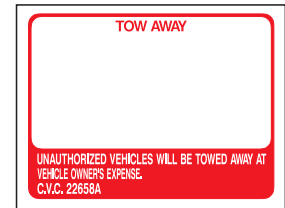

18" x 24"
.032 Aluminum
\$18.99 ea. | Item #PS19



18" x 24"
.032 Aluminum
\$18.99 ea. | Item #PS20



18" x 24"
.032 Aluminum
\$18.99 ea. | Item #PS21



18" x 24"
.032 Aluminum
\$18.99 ea. | Item #PS22



18" x 24"
.032 Aluminum
\$18.99 ea. | Item #PS23



18" x 24"
.032 Aluminum
\$18.99 ea. | Item #PS24



18" x 24"
.032 Aluminum
\$18.99 ea. | Item #PS25



18" x 24"
.032 Aluminum
\$18.99 ea. | Item #PS26



18" x 24"
.032 Aluminum
\$18.99 ea. | Item #PS27



18" x 24"
.032 Aluminum
\$18.99 ea. | Item #P33A

12" x 18"
.032 Aluminum
\$15.99 ea. | Item #P33B



18" x 24"
.032 Aluminum
\$18.99 ea. | Item #PS16



18" x 24"
.032 Aluminum
\$18.99 ea. | Item #PS17



- 2 Sided sign
- Size 18" x 24"
- Heavy gauge 60 mil
- Printed with long lasting inks

Item #018242
\$8.99 each
 Min. Qty 10

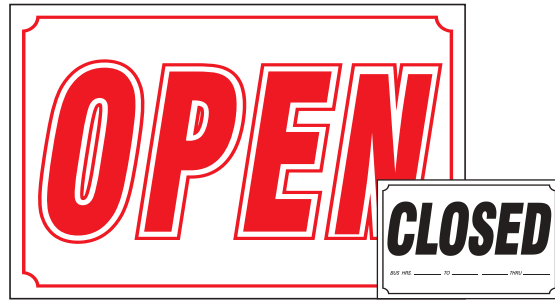

- 2 Sided sign
- Size 24" x 36"
- Oversized message
- Heavy gauge 60mil styrene
- Printed with long lasting inks

Item #OS23
\$12.99 each
 Min. Qty 5

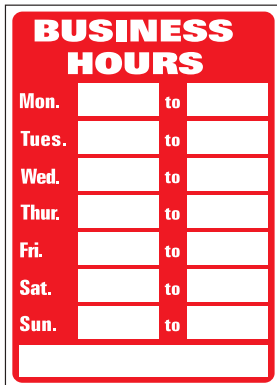

- Size 8" x 12"
- Oversized message
- 30mil styrene
- Printed with long lasting inks

Item #O128
\$4.99 ea min 20
\$3.00 ea 21+



- Size 10" x 14"
 - 60mil styrene
 - 2 Sided hanging sign
- Min. Qty 25
\$3.99 ea. | Item #OC14



- Size 10" x 14"
 - 60mil styrene
 - Highly visible
 - 2 Sided hanging sign
- Min. Qty 25
\$3.99 ea. | Item #BH14

THIS DOOR TO REMAIN UNLOCKED DURING BUSINESS HOURS

- Required for most business exit doors
 - White decal with black copy
- Size 1.5" x 23.5"

Item #BH01
\$2.00 each 1-5
\$1.75 each 6+



2" x 8" Decal
 Item #PUSH
\$2.99 each



2" x 8" Decal
 Item #PULL
\$2.99 each



24" Double faced
 Min. Qty 10
\$9.99 ea. | Item #OH18



24" Double faced
\$6.99 ea. | Item #OH08
 Min. Qty 15

Printed on 4mm Corrugated Plastic Shapes

All revised 6-2025

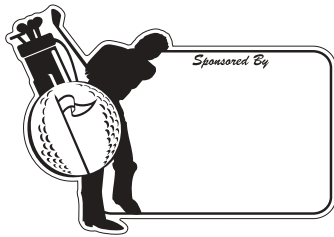

23" x 36"
Item #RSS2
\$8.99 ea. 1-24
\$7.99 ea. 25+
Min Qty 5



17" x 23.5" 22" x 32"
Item #GBB Item #GBBX
\$8.99 ea. 1-24 **\$8.99 ea. 1-24**
\$7.99 ea. 25+ **\$7.99 ea. 25+**
Min Qty 11 Min Qty 6



17" x 23.5" 22.5" x 32"
Item #GBC Item #GBCX
\$7.99 ea. 1-24 **\$8.99 ea.**
\$6.99 ea. 25+ **\$7.99 ea.**
Min Qty 6 Min Qty 6



23" x 17"
Item #RSS1
\$6.99 ea. 1-24
\$5.99 ea. 25+
Min Qty 10

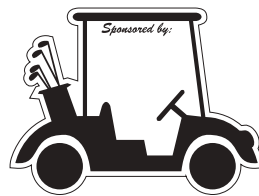

23" x 17"
Item #GC01
\$6.99 ea. 1-24
\$5.99 ea. 25+
Min Qty 10



23" x 36"
Item #GBT1
\$7.99 ea. 1-24
\$6.99 ea. 25+
Min Qty 4



22"
Item #GB01
\$7.99 ea. 1-24
\$6.99 ea. 25+
Min Qty 8

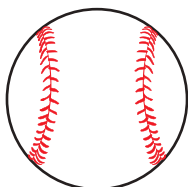

Baseball
17.5"
Item #B001
\$6.99 ea. 1-24
\$5.99 ea. 25+
Min Qty 11



Basketball
17.5"
Item #BB001
\$6.99 ea. 1-24
\$5.99 ea. 25+
Min Qty 11



Soccer Ball
17.5"
Item #S001
\$6.99 ea. 1-24
\$5.99 ea. 25+
Min Qty 11

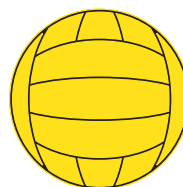

Water Polo
17.5"
Item #W001
\$6.99 ea. 1-24
\$5.99 ea. 25+
Min Qty 11

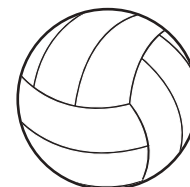

Volley Ball
17.5"
Item #V002
\$6.99 ea. 1-24
\$5.99 ea. 25+
Min Qty 11



Foot Ball
23" x 13.75"
Item #F001
\$6.99 ea. 1-24
\$5.99 ea. 25+
Min Qty 10

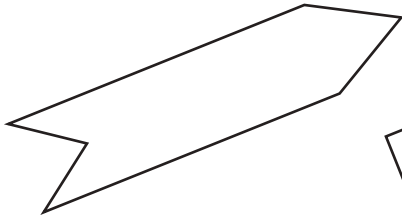

48" x 13.5" 10mm
Black | White | Yellow
Corrugated plastic

Item #ARWSM1
\$14.99 ea.

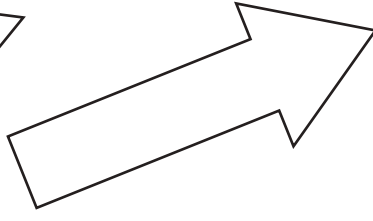
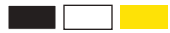

72" x 24" 10mm
Black | White | Yellow
Corrugated plastic

Item #ARWLG1
\$34.99 ea.

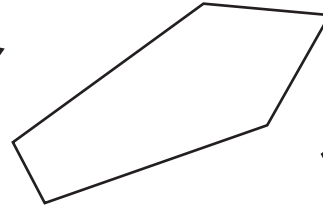
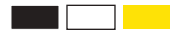

48" x 13.5" 10mm
Black | White | Yellow
Corrugated plastic

Item #ARWSM2
\$14.99 each

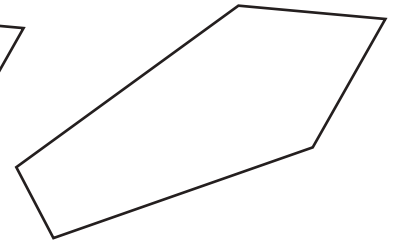

72" x 24" 10mm
Black | White | Yellow
Corrugated plastic

Item #ARWLG2
\$34.99 each



23" x 17" 4mm
White | Red | Yellow
Corrugated plastic

Item #AOO1
\$4.99 ea. 1-24
\$3.99 ea. 25+



23" x 17" 4mm
White | Red | Yellow
Corrugated plastic

Item #HOO1
\$4.99 ea. 1-24
\$3.99 ea. 25+

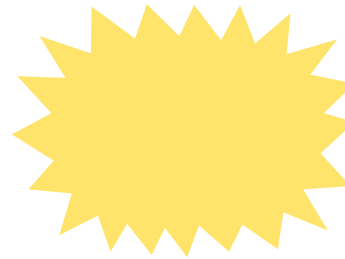

23" x 17" 4mm
White | Red | Yellow
Corrugated plastic

Item #SOO3
\$4.99 ea. 1-24
\$3.99 ea. 25+

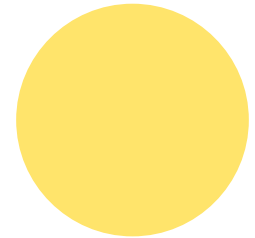

17" 4mm
White | Red | Yellow
Corrugated plastic

Item #COO1
\$4.99 ea. 1-24
\$3.99 ea. 25+



**Heavy duty metal handle
for corrugated plastic signs**

Corrugated plastic handles
\$9.99 each set | Item #HDH

EconoStakes GALVANIZED

The ultimate coroplast sign holder. Ideal for real estate, politics, garage sale and more.

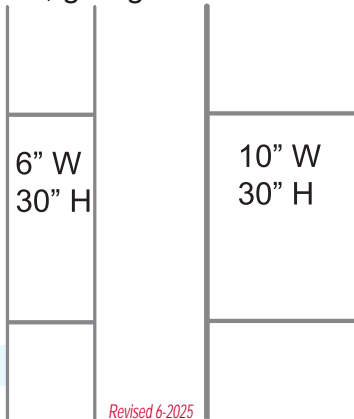

50 per case

Revised 6-2025

Revised 6-2025

Quantity	Cost	6" Item #	Cost	10" Item #
1 - 25	\$1.73	MCSTK	\$2.03	CSTK
26 - 49	\$1.60	MCSTK	\$1.90	CSTK
50 - 99	\$1.43	MCSTK	\$1.63	CSTK
100 - 199	\$1.06	MCSTK	\$1.28	CSTK
200 - 999	96¢	MCSTK	\$1.16	CSTK
1000 - 4999	94¢	MCSTK	\$1.00	CSTK
5000 +	85¢	MCSTK	96¢	CSTK

EconoStakes

Powder coated
Black or White

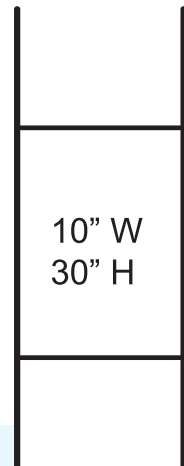

50 per case

The ultimate coroplast sign holder. Ideal for real estate, politics, garage sale and more.

Quantity	Cost	White Item #	Black Item #
1 - 49	\$2.04	CSTKW	CSTKB
50 + (1 case)	\$1.55	CSTKW	CSTKB

Revised 6-2025

EL Diablo stakes

2 Sizes
10.5" x 33"
10.5" x 48"

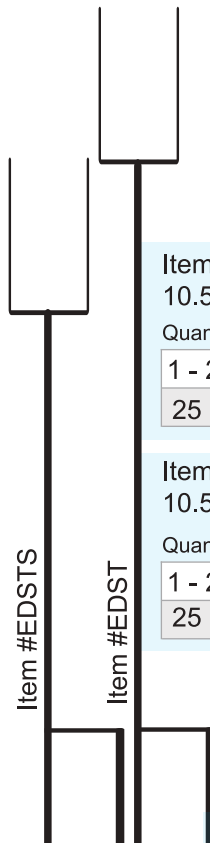

Item #EDSTS
10.5" wide x 33" high

Quantity	Cost	Item #
1 - 24	\$4.14	EDSTS
25 +	\$3.78	EDSTS

Item #EDST
10.5" wide x 48" high

Quantity	Cost	Item #
1 - 24	\$4.32	EDST
25 +	\$3.96	EDST

Revised 6-2025

25 per case

HD GOAL POST STAKE

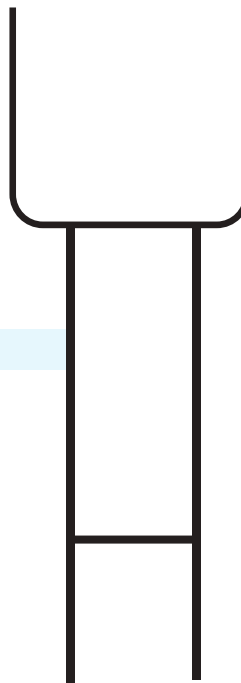

25 per case

- U-top 9 gauge galvanized
- Base 3/16" galvanized wire

Revised 6-2025

Quantity	Cost	Item #
1 - 24	\$3.95	HDSGP
25 +	\$3.71	HDSGP

Heavy H STAKE Duty

25 per case

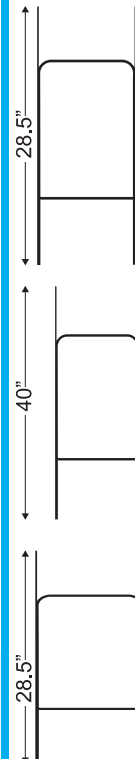

Item #HDHST
for 4mm flutes
10.5" wide x 28.5" high

Quantity	Cost	Item #
1 - 24	\$3.60	HDHST
25 +	\$3.36	HDHST

Item #HDSTL
for 4mm flutes
7.5" wide x 40" high

Quantity	Cost	Item #
1 - 24	\$4.19	HDSTL
25 +	\$3.95	HDSTL

Item #HD6MI
for 6mm flutes
10.5" wide x 28.5" high

Quantity	Cost	Item #
1 - 24	\$4.42	HD6MI
25 +	\$4.19	HD6MI

Revised 6-2025

FOLDABLE WIRE STAND

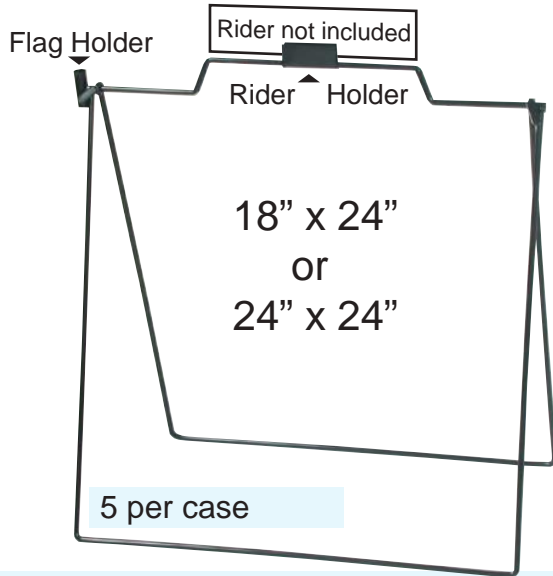

Item #FWSB [black]
18" x 24" | **\$19.99 ea.** | \$17.99 ea. 5+

Item #FWSW [white]
18" x 24" | **\$19.99 ea.** | \$17.99 ea. 5+

Item #FWSBL [large black]
24" x 24" | **\$20.99 ea.** | \$19.99 ea. 5+

Item #FWSWL [large white]
24" x 24" | **\$20.99 ea.** | \$19.99 ea. 5+

PVC TUBE A FRAME

- Round legs
- Double sided
- Quick assembly
- Stands 30" inches tall
- Frame and hardware only



Stand Holds
Size 18" x 24"
Size 24" x 36"

Item #PVCAF
18" x 24" | 24" x 24" | **\$16.99 ea.**

Item #PVCAF36
24" x 36" | **\$23.99 ea.**

Revised 6-2025

POST & RAIL FRAME KITS

UV PROTECTED | NO YELLOWING | NO CRACKING

Kit includes

- 2 vinyl caps
- 2 post 4" x 4"
- 2 horizontal rails
- 8 vinyl screw caps
- 8 total 3/4" stainless screws

Specify 1/2" frame 3/8 thick substrate
1/4" frame for 3/16" thick substrate

Holds 4' H x 8' W sign
Width can be smaller by cutting horizontal rails

HEIGHT IS OK TO CUT - HOWEVER DO NOT
CUT CROSSBEAMS ALONG THE LENGTH

\$386.99 each | Item #PRFK

SIGN PANEL NOT INCLUDED

Revised 6-2025



Frame Kit Size 4' x 8'

Coldwell Banker

5 per case

Available in
 White
 Black

- Installs in seconds
- All hardware included
- White 52" Item #CB01 **\$19.80 ea.**
- Black 52" Item #CB01BK **\$21.99 ea.**

Colonial Yard Sign Post

5 per case

Available in
 White
 Black

- Installs in seconds
- All hardware included
- White 52" Item #CLP01 **\$19.80 ea.**
- Black 52" Item #CLP01BK **\$21.99 ea.**

White 64" Item #CB01L **\$22.99 ea.**

Black 64" Item #CB01LBK **\$23.99 ea.**

White 64" Item #CLP01L **\$22.99 ea.**

Black 64" Item #CLP01LBK **\$23.99 ea.**



RIDER HOLDER

\$3.99 ea
 Item #CVPT
Revised 6-2025

Works with Colonial and Coldwell Frames

Can ship to these states by GLS / GSO - All other states must go by a truck company



Real Estate POST

SOLD

Vertical Post
 36" arm
 48" arm

- No cracking
- No yellowing
- **4" Square Post**
- Colonial style cap
- No digging required
- 5 years UV protection
- Includes metal anchor

Size	Cost	Item #
36" arm	\$87.99	REP44
<small>Actual Sign Hanging Area 26"</small>		
48" arm	\$93.99	REP48
<small>Actual Sign Hanging Area 38"</small>		

Additional anchor \$22.99 ea | Item #VPGA
 Additional 36" arm \$20.99 ea | Item #XA36
 Additional 48" arm \$23.99 ea | Item #XA38

Aluminum Real Estate SIGN POST

Item # ALP64B

Item # ALP64W

- Constructed of 2"x3" non-rust aluminum, include heavy duty ground stake and all hardware required for assembly
- Can accommodate 30" wide sign and rider
- Rider is attached with thumb screws and holes are not required
- Post is 64" tall with an arm length of 41"
- Electrostatic powder coated in black or white
- Packed two per box

Quantity	Cost
1	\$90.99 ea
2 +	\$86.99 ea

Real Estate Stakes T-Bar

Flag Pole Holder

12 per case

Stakes Black and White
flag not included

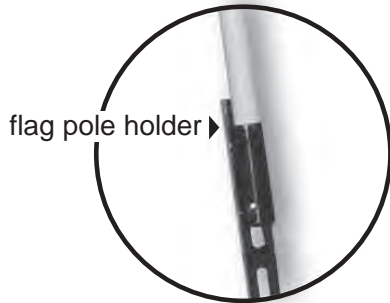

flag pole holder ▶

Stake is 48" Tall
Item #RESBTP [black]
Item #RESWTP [white]

Quantity	Cost
1 - 23	\$6.99 ea.
24 - 71	\$6.20 ea.
72 +	\$5.85 ea.

Revised 6-2025

42" T-Bar Metal Stake

• 3/4 angle iron

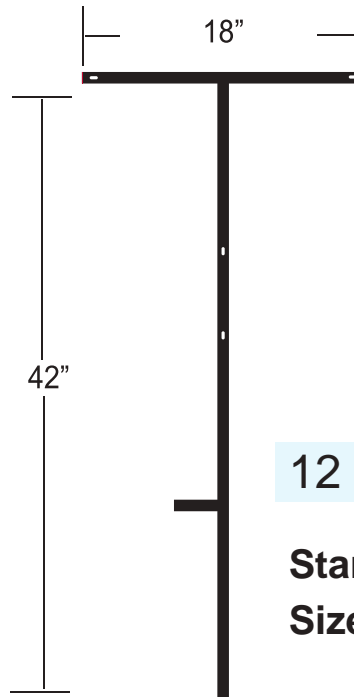

12 per case

Stand Size
Size 18" x 42"

Item #LGTBK *Revised 6-2025*
\$10.99 ea. 1-11 | 12+ \$9.99 ea.

Real Estate Stakes T-Bar

Stakes Black and White

12 per case



Stake is 48" Tall

Available in:
 White Black

Quantity	Cost
1 - 23	\$5.99 ea.
24 - 71	\$5.80 ea.
72 +	\$5.50 ea.

Item #RESBT [black]
Item #RESWT [white]

Revised 6-2025

Real Estate Stakes

Stake is 48" Tall

12 per case



Stakes Black and White

Revised 6-2025

Item #RESB [black]
Item #RESW [white]

Quantity	Cost
1 - 23	\$5.99 ea.
24 - 71	\$5.60 ea.
72 +	\$5.15 ea.

Deluxe Holds 150 8.5" x 11"

- Brochure Holder
- UV protection
 - High impact plastic
 - Hold 50 business cards
 - Available in black or white



Special packaging is recommended when shipping FedEx and UPS

Item #BH85-B [black]

Item #BH85-W [white]

\$14.99 ea. *Revised 6-2025*

Deluxe Brochure holder with stake

- Comes preassembled
- Available in black or white



Special packaging is recommended when shipping FedEx and UPS

Item #BH85STK-B [black]

Item #BH85STK-W [white]

\$24.99 ea. *Revised 6-2025*

Standard Holds 75 8.5" x 11"

- Available in black or white



Special packaging is recommended when shipping FedEx and UPS

Item #STBB-B [black]

Item #STBB-W [white]

\$13.99 ea. *Revised 6-2025*

Item #ESTBB-B [black with stake]

Item #ESTBB-W [white with stake]

\$22.99 ea. *Revised 6-2025*

Real Estate Flag poles

2 Part PVC poles with high impact stake

- Special foot stakes
- Flags sold separately
- 67" height assembled



High Impact
Unbreakable Plastic Stake



Item #FP06

\$22.50 ea. *Revised 9-24-25*

Steel Includes 2 Part Pole / 3 Clips Flag Pole



72" Tall

- Flags sold separately

\$6.99 ea. | Item #2PCFP

Revised 6-2025

Steel Top Top Section Only Includes 3 Clips

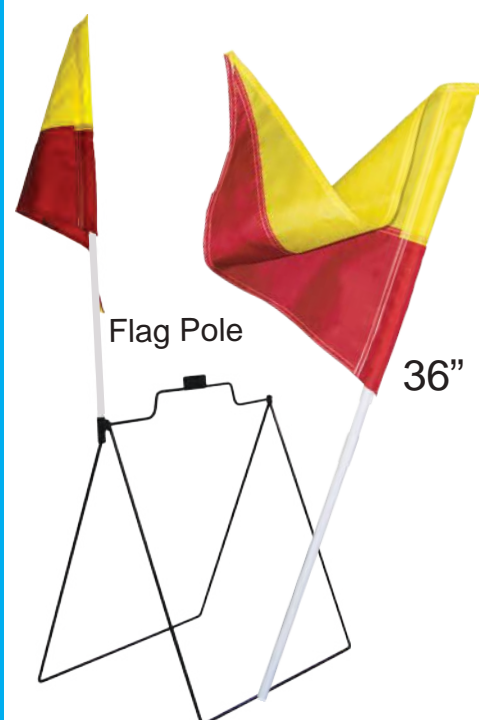

Flag Pole

36"

- Flag and frame sold separately

\$3.99 ea. | Item #2PCFPT

Revised 6-2025

REFB

4 per case

- Double sided
- Powder coated
- Quick assembly
- Available in black and white
- Approximately 46" inches tall
- Holds .040 aluminum to 1/4" wood sign face



Item #REFB [black]
\$24.99 ea.

Item #REFW [white]
\$24.99 ea.

DSF03 Stand Holds

Size 18" x 24"
Size 6" x 24"

- Double sided
- Powder coated
- Holds 24" x 18" and 24" x 6"
- Available in black and white
- Holds .040 aluminum to 1/4" wood sign face

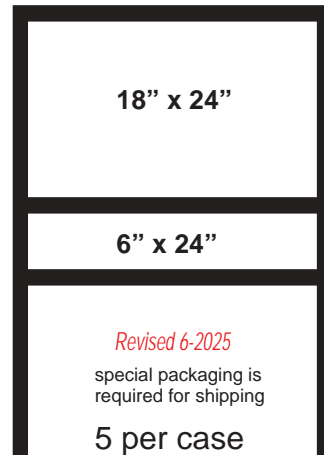

Item #DSF03B [black]
\$26.99 ea.

Item #DSF03W [white]
\$26.99 ea.

Notice
Due to increase in ocean freight,
there is temporarily
NO DISCOUNT PRICING
on quantity order
for any frames
on this page

DSF04 Stand Holds

Size 18" x 24"
Size 6" x 24"

- Double sided
- Powder coated
- Holds 24" x 18" and 24" x 6"
- Available in black and white
- Holds .040 aluminum to 1/4" wood sign face

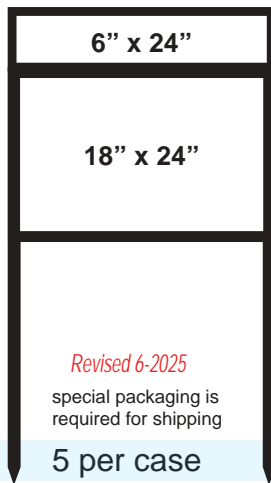

Item #DSF04B [black]
\$26.99 ea.

Item #DSF04W [white]
\$26.99 ea.

DSF05 Stand Holds

Size 18" x 24"
Size 6" x 24"

- Double sided
- Powder coated
- Holds 24" x 18" and 24" x 6"
- Available in black and white
- Holds .040 aluminum to 1/4" wood sign face

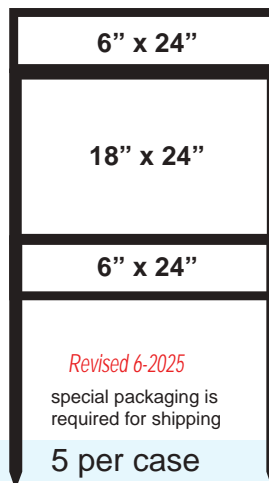

Item #DSF05B [black]
\$27.99 ea.

Item #DSF05W [white]
\$27.99 ea.

DSF06 Stand Holds

Size 24" x 36"
Size 6" x 36"

- Double sided
- Powder coated
- Available in black only
- Holds 36" x 24" and 36" x 6"
- Holds .040 aluminum to 1/4" wood sign face

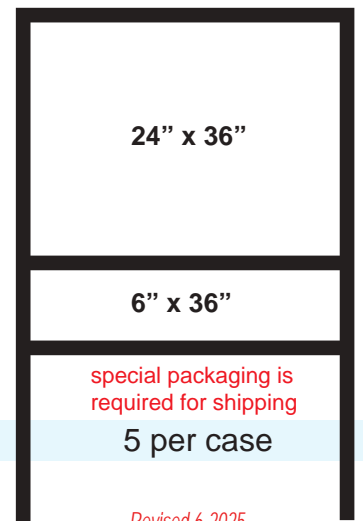

Item #DSF06
\$27.99 ea.

Plastic Easels

Single wing with adhesive

Size	Cost 1-24	Cost 25+	Item #
3"	47¢	42¢	PE30
5"	58¢	55¢	PE50
8"	84¢	80¢	PE80

Revised 6-2025



Chipboard Easels

Chipboard easel double wing

Size	Cost 1-24	Cost 25+	Item #
9"	86¢	70¢	ED06
16"	\$1.62	\$1.32	ED16
19"	\$1.92	\$1.58	ED19

Revised 6-2025



Chipboard Easels

6 Sizes Chipboard Single Wing

Size	Cost 1-24	Cost 25+	Item #
6"	74¢	61¢	ES06
8"	79¢	65¢	ES08
9.5"	83¢	68¢	ES91
12"	95¢	78¢	ES12
17"	\$1.13	92¢	ES17
22"	\$1.46	\$1.16	ES22

Revised 6-2025



Cool Corro easels

Size	Cost	Item #
24"	\$13.99	CCE24
32"	\$16.99	CCE32
36"	\$19.99	CCE36
42"	\$24.99	CCE42

Revised 6-2025

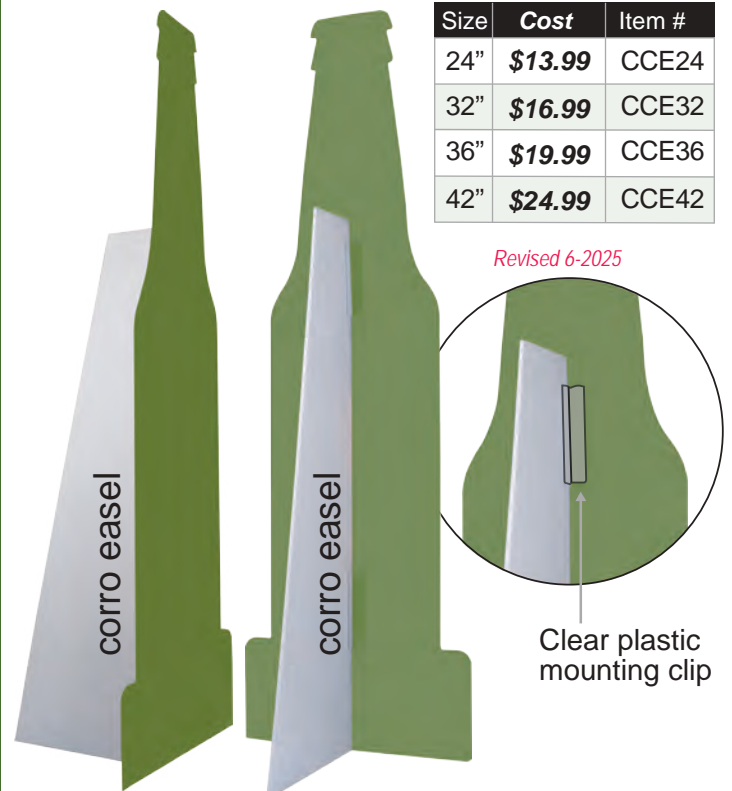

FLOOR MOUNTS

- Cost effective
- Bolt and wing nut
- Holds up to 1" thick material

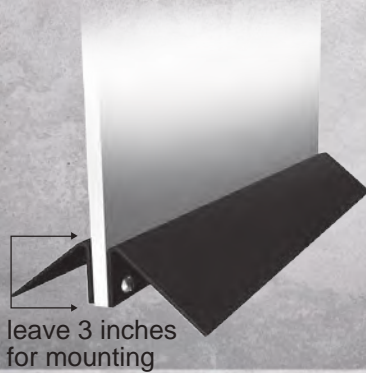

Cost		
8"	\$19.99 per pair	Item #SMM08
24"	\$39.99 per pair	Item #SMM24
36"	\$52.99 per pair	Item #SMM36
48"	\$78.99 per pair	Item #SMM48

Revised 6-2025

BLACK HAWK SIGN HOLDERS

- 4 sizes available
- Matte black finish
- Easy to use and reuse
- Single or double sided signs

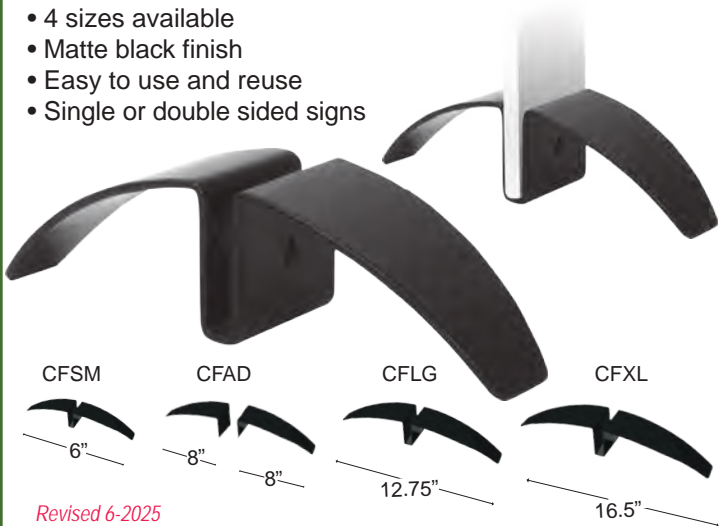

Revised 6-2025

Substrate thickness	Cost
1/4" Item # CFMS	\$5.99 ea 2+ \$4.50 ea.
1/2" Item # CFLG	\$9.99 ea 2+ \$8.25 ea.
1/2" Item # CFXL	\$11.99 ea 2+ \$10.25 ea.
Adjustable Item #CFAD	\$10.99 ea 2+ \$9.50 ea.

Adjustable 1/8" to 1" thick substrate

47" ECONO STEEL EASEL

- Cut outs easily attach to easel
- **Attaches with two sided tape (not included)**
- Perfect for theaters, promotions and retail locations
- Provides stability & the perfect angle for your cut out display

Great for gator or foamcore substrates

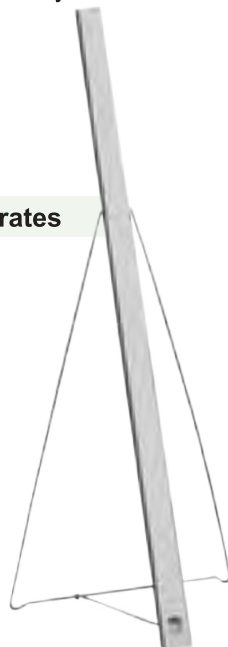

Item #EALE

1 - 6	\$16.99 ea.
7 - 24	\$15.99 ea.
25+	\$14.99 ea.

Revised 6-2025

5' Aluminum Easel

Comes with an adjustable knob to adjust display angle

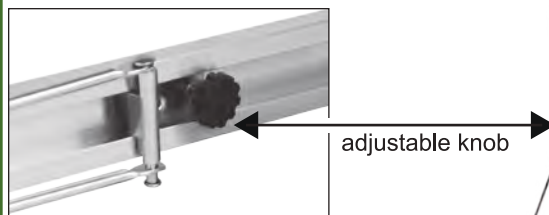

Great for gator or foamcore substrates

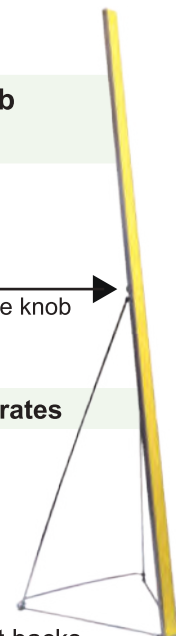

- Very sturdy
- **Includes two sided tape**
- Adjusting knob in back for different backs
- Great for displaying stand up figures or signs
- Triangle base collapses into 5' length for easy shipping
- Total length of aluminum edge covered with foam tape

\$25.99 each | Item #ALE4 Revised 6-2025

Curved Sign Face Displays

- Accepts semi-rigid or rigid self supporting medias
- Dramatic, stylish, elegant two sided curved design
- Change out graphics instantly without disassembling unit
- Graphic changes are effortless and assembly is ultra simple
- Perfect for exhibits, retail, restaurants, trade shows and malls

FACE MATERIAL NOT INCLUDED

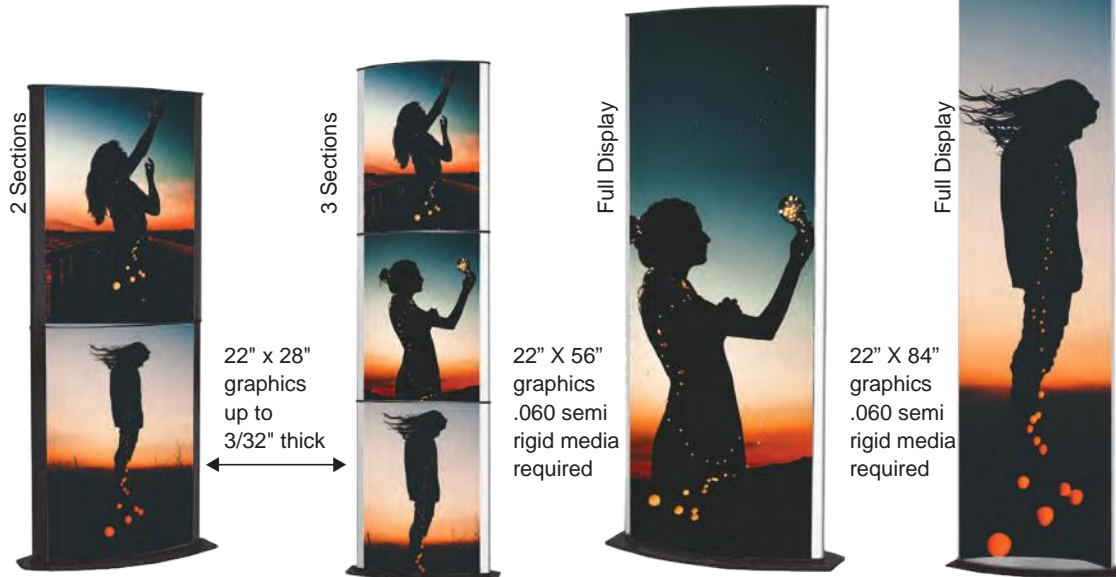

Item #VX2 - S [satin silver] \$251.99 each | Item #VX3 - S [satin silver] \$339.99 each | Item #VX4 - S [satin silver] \$230.99 each | Item #VX5 - S [satin silver] \$285.99 each

Curved sign face frame

- Styrene is ideal - .040"
- Material up to 3/32" thick
- Accepts semi-rigid or rigid
- Minimum .060" recommended



Curved Display Area 22" W x 28" H

Revised 6-2025

Item #VX1-S [silver] \$230.99 ea.
Item #VX1-B [black] \$230.99 ea.

displayRITE USE BANNER OR FABRIC MATERIAL

ORDER ON DEMAND

The Display Rite System **Telescopes** in both **Height** and **Width**. The **height** Telescopes quickly and easily from 36" to 96" high. Depending on the model, the width telescopes as easily from 36" to 96" wide. This versatile Display System adapts as your needs change. Choose one of the 2 Regular and 2 **Heavy Duty** sizes to meet your needs. Hem Banner with either a 2-1/2" or 3-1/2" sleeves top and bottom, depending on the model. Assemble in minutes with crossbars going through the sleeves. For other graphics without hems, use metal clamps Available colors: **Specify: S - Silver or B - Black**

\$53.99 | Item #EBG - 6 | travel bag



Travel bag sold separately

Size	Height	Banner Sleeve Cross Bar	Cost	Item #
30" - 48"	36" - 96"	2.5"	\$229.99	BN - 4
48" - 96"	36" - 96"	2.5"	\$262.99	BN - 5
30" - 48"	36" - 96"	3.5"	\$252.99	JN - 4
48" - 96"	36" - 96"	3.5"	\$296.99	JN - 5

Revised 6-2025



Printed graphic / Banner or Fabric Material Not Included

BN - 5 conversion kit	Item #	JN - 5 conversion kit	Item #
10'	\$160.99 each BN5C1	10'	\$176.99 each JN5C1
12'	\$234.99 each BN5C2	12'	\$250.99 each JN5C2

HEAVY DUTY MODELS USE A LARGER DIAMETER TUBE

For converting BN-5 & JN-5 Stands...use the Conversion Kit to make the stands up to 10 ft. & 12 ft. on either the width or height of the display

DELUX EXPANDER DISPLAY HEAVY DUTY STEP AND REPEAT

- Vinyl or fabric material
- Available in black finish
- Quick assembly and tear down
- Holds up to a full 8' x 10' banner
- Includes a heavy black nylon carrying bag
- Heavy duty all aluminum tubular construction
- 3" pole pockets are necessary on top and bottom

Dimensions

Boxed Weight: 19 lbs
 Box Size: 41" x 4" x 10"
 Banner Height: 34.5" up to 96"
 Banner Width: 77" up to 122"

\$150.99 each | Item #SRDE



cross foot for more stability



heavy black nylon carrying bag included

Revised 6-2025



Printed graphic / Banner or Fabric Material Not Included

Poles Telescope Vertically from 34-1/2" up to 96" and Horizontally from 77" up to 122"

Extension kits *Revised 6-2025*

Size	Expansion	Center pole	XL feet	Cross feet	TOTAL COST
8' x 10'	0	Optional	0	0	\$150.99.
8' x 12'	1	1	2	2	\$360.99.
8' x 14'	2	1	2	2	\$392.99.
8' x 16'	3	2	2	2	\$520.99.
8' x 18'	4	2	2	2	\$553.99.
8' x 20'	5	3	2	2	\$682.99.

Expansion parts 10' to 20' long		Item #
24" expansion tube set [2 needed every 2ft.]		EXP24
Center pole [recommended for top pole support]		EXCP
Extra large 26" long foot [extra support]		EXLF
Small foot to cross regular or extra large foot		EXSF

SUGGESTED EXTENSION DIAGRAM FOR DEX DISPLAY // MEASURE + VERIFY GRAPHICS BEFORE PRINTING

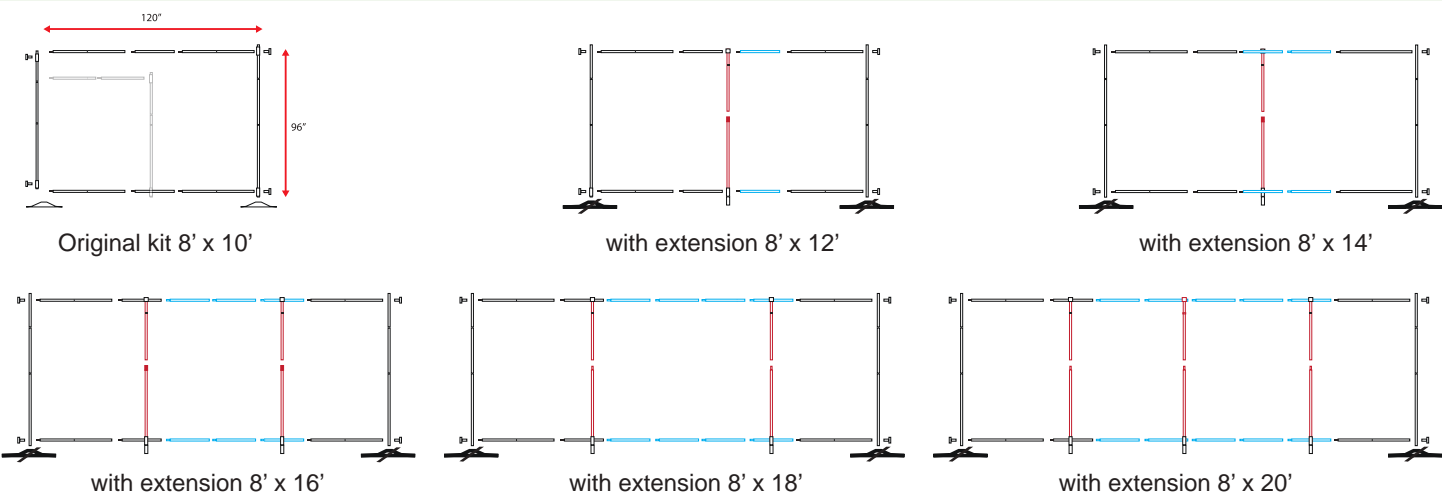

10ft Straight Tube Display

- Easy set up, step by step
- Steel base feet for stability
- Light weight aluminum frame
- Stretch fabric that pulls easily over frame
- Soft canvas carrying bag is included

Front view 115" x 88.5" Frame weight 23 lbs
 Top view 115" x 13.75" Frame and bag weight 30.8 lbs

DOUBLE SIDED PRINT AVAILABLE

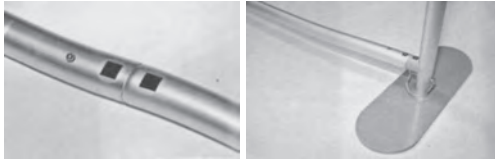

Revised 6-2025

\$301.99 ea. frame | \$418.00 ea. print* | Item #STD10

* Colored front with blank white back
 Extra charge to print double sided

Hardcover Travel Case with wheels sold separately:
\$76.99 each | Item #WTBAG10



10ft "S" Wave Tube Display

- Elegant "S" curve design
- Easy set up, step by step
- Light weight aluminum frame
- Stretch fabric that pulls easily over frame
- Hardcover travel case with wheels included

Front view 120 1/8" x 88 1/2" Frame weight 9.8 lbs
 Top view 120 1/8" x 14" Frame and bag weight 19 lbs

Top view



DOUBLE SIDED PRINT AVAILABLE



\$329.99 ea. frame | **\$361.00** ea. print | Item #WTSD10

Revised 6-2025



6ft Table Top Wave Tube Display

- Easy set up, step by step
- Light weight aluminum frame
- Stretch fabric pulls easily over frame
- Great for table top promotional graphics
- Canvas carrying bag is included

Front view 73.03" x 60.24"
 Top view 73.03" x 9.11"

Frame weight 6.4 lbs
 Frame and bag weight 10.9 lbs

DOUBLE SIDED PRINT AVAILABLE

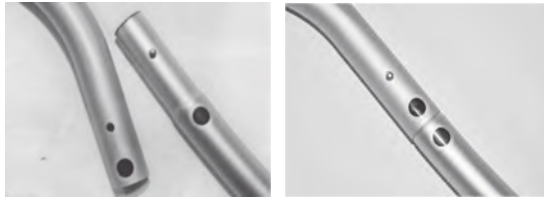

Revised 6-2025

Hardcover Travel Case With Wheels sold separately:
\$82.99 each | Item #WTBAG6 *Revised 6-2025*



\$141.99 for each frame | **\$206.00 each print** | Item #WTTD6

8ft Wave Tube Display

- Easy set up, step by step
- Light weight aluminum frame
- Closes with heavy duty zipper
- Stretch fabric pulls easily over frame
- Canvas carrying bag is included

DOUBLE SIDED PRINT AVAILABLE

Front view 90.35" x 88.98" Frame weight 8 lbs
 Top view 90.35" x 13.59" Frame and bag weight 15.7 lbs



\$184.99 each frame | **\$294.00 each print** | Item #WTD8

Hardcover Travel Case with wheels sold separately:
\$89.00 each
 Item #WTBAG8



Revised 6-2025

10ft Wave Tube Display

- Easy set up, step by step
- Light weight aluminum frame
- Closes with heavy duty zipper
- Stretch fabric pulls easily over frame
- Canvas carrying bag is included

DOUBLE SIDED PRINT AVAILABLE

Front view 118.50" x 88.98" Frame weight 8.7 lbs
 Top view 118.50" x 17.24" Frame and bag weight 16.4 lbs



\$203.99 each frame | **\$341.00 each print** | Item #WTD10

Hardcover Travel Case with wheels sold separately:
\$106.80 each
 Item #WTBAG10



Revised 6-2025

ALUMINUM DISPLAY FRAMES

Flip-up and Slide-in Frame

- Easy install
- Quick change
- Custom sizes available
- Includes .20" clear plastic cover

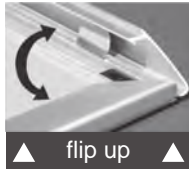

Flip-Up

Revised 6-2025

Insert Size	Cost	Item #
8.5" x 11"	\$57.99	FF8511
11" x 17"	\$59.99	FF1117
14" x 22"	\$60.99	FF1422
17" x 22"	\$66.99	FF1722
22" x 28"	\$78.99	FF2228
24" x 36"	\$93.99	FF2436
28" x 44"	\$111.99	FF2844

Available in black | silver | gold

Slide-In

Insert Size	Cost	Item #
8.5" x 11"	\$39.99	SLIN8511
11" x 17"	\$53.99	SLIN1117
14" x 22"	\$55.99	SLIN1422
17" x 22"	\$60.99	SLIN1722
22" x 28"	\$76.99	SLIN2228

Available in black | silver

DISPLAY POP UP FRAMES

Hook and Loop mounting



Non - Backlit

- Adjustable leveling feet
- **Easy Hook and Loop mounting**
- Lightweight satin aluminum construction
- Incredibly easy, two minute setup without tools
- Portable soft carrying case with wheels and handle included
- We highly recommend setting up your display and measuring the exact Height & Width of your unit

POP-UP Straight	Cost	Item #
88"W x 88"H x 12.5"D	\$287.99	SMK-33
118"W x 88"H x 12.5"D	\$314.99	SMK-43

Injected hard plastic case	Item #	Cost
HCASE [SMK-33 / CMK-33]		\$91.99 ea
HCASE43 [SMK-43 / CMK-43]		\$117.99 ea

Revised 6-2025

Optional halogen lights available
\$34.99 each | Item #HALO

A hard case is recommended when display units are being shipped



Ackland SNAPCAP

Custom Frames With Mitered Corners

- Frames are re-usable
- Requires no special tools
- Change graphics in minutes
- Indoor / outdoor applications
- Frame snaps open and close
- Powder - coating available in any color
- Uses vinyl with raw edges, substrates or coroplast
- Adhesive strip all along inside holds material in place



CALL FOR CUSTOM PRICING // SPECIAL ORDER ONLY

Ackland MEDIA FRAMES

2 Piece Aluminum Attachment System for Displaying Non - Adhesive Vinyl

- Works on walls & trucks
- Uses vinyl with raw edge
- Requires no special tools
- Indoor / outdoor applications
- Frames and vinyl are reusable
- Available with no mechanical anchors
- Powder- coating available in any color
- Self-Tensioning, with no moving parts!
- No Hems, beading or fabrication required

**Any size available
 WE MEAN ANY SIZE!**



TURN ANY WALL, TRUCK OR BUILDING INTO A BILLBOARD

CALL FOR CUSTOM PRICING // SPECIAL ORDER ONLY

LED Sign Clamps

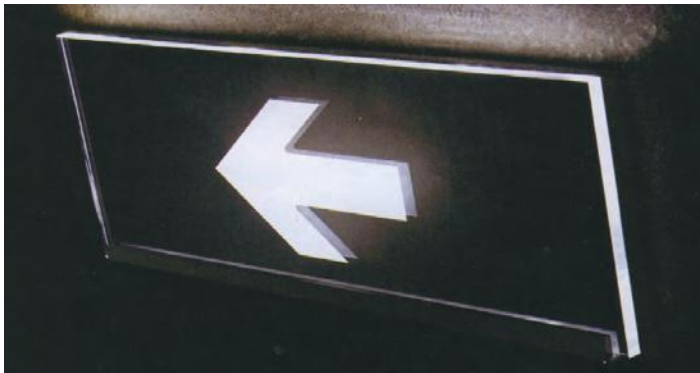

- Satin finish
- White LED only
- Easy installation

Revised 6-2025

Sign Clamps with LED Lights

\$33.00 ea.	Item #XC15-80-ST-WHITE	3 1/8"
\$32.99 ea.	Item #XC15-120-ST-WHITE	4 3/4"
\$38.99 ea.	Item #XC15-180-ST-WHITE	7 3/32"
\$45.99 ea.	Item #XC15-280-ST-WHITE	11"
\$58.99 ea.	Item #XC15-380-ST-WHITE	15"

SAMSUNG LEDS

50,000 HOURS LIFESPAN or 3 years manufacturer warranty



INTERONE

Model	Z4U-V05-A4
Operation voltage	DC12V
power Consumption	1.44W / 2.28W
Current	120mA / 190mA
Viewing Angle	140°
Weight	12g
Operation Temperature	-20°C ~ 60°C (- 4°F ~ 140°F)
Storage Temperature	-40°C ~ 75°C (- 40°F ~ 167°F)
Water Proof	IP68
Dimensions	43 X 43 X 6.9mm
Wire Length	100mm (3.94") UL 18 AWG Pair
LED Pitch	24mm



50 Modules per strand (24ft. long) | **60 Watts** power supply per strand | Item # SS3LED **\$28.99 ea.**

Please Note: POWER SUPPLY NOT INCLUDED - See page 82

Revised 6-2025

Power Supply

Low Cost High Reliability



LPV-60

- Low cost, high reliability
 - Constant voltage design
 - Fully isolated plastic case
 - 100% full load burn-in test
 - Cooling by free air convection
 - Universal AC input / Full range
 - Fully encapsulated with IP67 level (Note.8)
 - Suitable for LED related fixture or appliance
 - Withstand 300VAC surge input for 5 seconds
 - Protections: Short Circuit | Overload | Over Voltage (such as LED Decoration or Advertisement devices)(Note 7.)
- Class II power unit, no FG | Class 2 power unit | pass LPS



\$46.99 ea. | Item #LPV - 60 -12

Input: 100-240 VAC 1.2A
OUTPUT: +12V - 5.0A
OUTPUT POWER: 60W

Revised 6-2025

Power Supply



LPV-100

- Constant voltage design
- Universal AC input / Full range
- Fully encapsulated with IP67 level (Note.8)
- Withstand 300VAC surge input for 5 seconds
- Protections: Short circuit / Overload / Over voltage
- Fully isolated plastic case
- Cooling by free air convection
- 100% full load burn-in test
- Low cost, high reliability
- Suitable for LED related fixture or appliance (such as LED Decoration or Advertisement devices)(Note 7.)



\$57.99 ea. | Item #LPV - 100 -12

Input: 100-240 VAC 2.2A
OUTPUT: +12V - 8.5A
OUTPUT POWER: 102W

Revised 6-2025

Power Supply



LPV - 150

- Low cost, high reliability
- Constant voltage design
- Class power unit, no FG
- Fully isolated plastic case
- 100% full load burn-in test
- Fully encapsulated with IP67 level (Note.8)
- Fanless design, cooling by free air convection
- Listed in UL Sign Component Manual (SAM)
- Type "HL" for use in class I, Division 2 hazardous (Classified)
- Protections: Short circuit | Overload | Over voltage | Over temperature



\$93.99 ea. | Item #LPV - 150 -12

Input: 200-240 VAC 1.7A
OUTPUT: +12V - 10A
OUTPUT POWER: 150W

Revised 6-2025

SPRINGER SIDEWALK SIGN



Sign Area 24" W x 36" H

- Double sided
- 4 No slide feet
- 1 Black sign base
- 1 Set assembly hardware
- 2 Heavy duty galvanized springs
- 1 24" x 36" x .5 blank white sign face

Revised 6-2025

\$102.99 each | Item #SPRING

SPRINGER MESSAGE BOARD

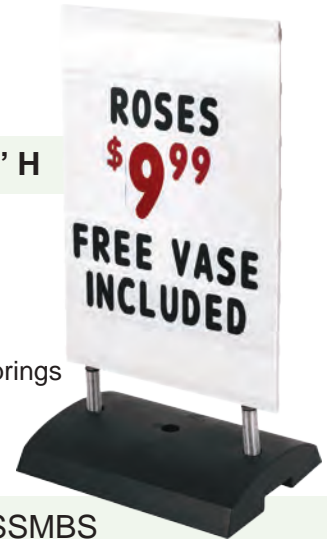

Sign Area 24" W x 36" H

- 4 No slide feet
- 1 Set assembly hardware
- Letter tracks on both sides
- 2 Heavy duty galvanized springs

Revised 6-2025

\$177.99 each | Item #SSMBS

Includes set of (314) 4" plastic sign numbers and symbols (black letters, red numbers)

WindSigns

- 2 sided
- Tool free assembly
- Quick change features
- Holds material 3/16" or less



Wind Sign II Sign Area 24" x 36"

Wind Sign Deluxe Sign Area 28" x 44"

#1833

#1822

\$161.99 ea | Item #1822
Frame Size 28.7" W x 53" H

\$204.99 ea | Item #1833
Frame Size 30" W x 61" H

Super wind sign

- Silver satin rounded corners
- Coil springs resist head-on winds
- Snap open/closed double faced frame
- PVC clear protective cover for outdoor use
- Use weatherproof sign material for outdoors



Sign Area 28" x 44"

\$246.99 each | Item #1877

FILL WITH 115lbs OF DRY SAND

Revised 6-2025

Gemstone Valet and parking sign

- Double sided
- Recycled rubber base
- Recessed sign surface area
- 44.5" H x 14.75"W without base
- Base available in two sizes 9lbs or 20lbs
- Designed to withstand impacts from vehicles



Sign Area 36" H x 8" W

No face included

Revised 6-2025

\$54.99 ea. | Item #4100BK9
[9 lbs. base] 12+ \$52.99 ea.

\$54.99 ea. | Item # 4100BK20
[20 lbs. base] 12+ \$52.99ea.

Valet parking signs

- removable tops
- Base included with frame

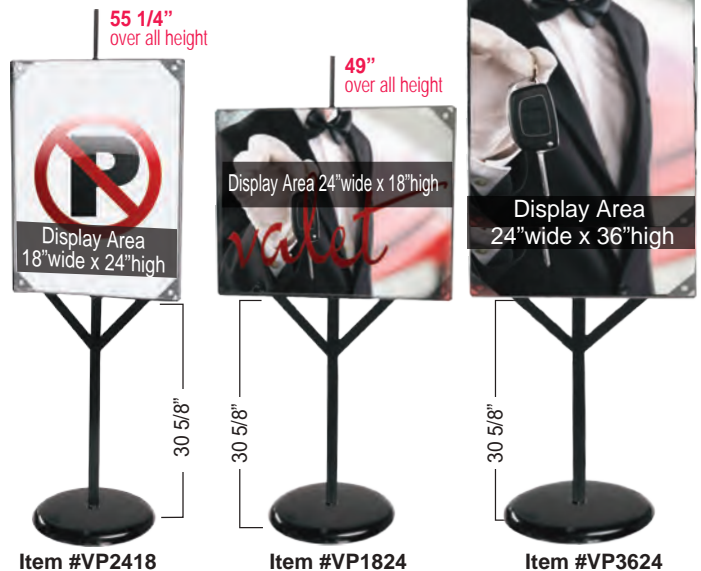

Revised 6-2025
Special packaging \$30 ea. if shipped

DISPLAY AREA			
18"W x 24"H	\$94.99	VP2418	
24"W x 18"H	\$94.99	VP1824	
24"W x 36"H	\$106.99	VP3624	
11 lbs -16" dia. Base only	\$45.99	VPBASE	

INDOOR display stand

- Height 59"
- Black or chrome
- Holds 22" x 28" sign
- Solid base 15" x 22"



Revised 9-2025
Chrome \$181.50 ea. / Item #BH30C
Black \$102.99 ea. / Item #BH30B

Economy Indoor Display

- Black or chrome
- Solid base 10" x 14"
- Stand holds 22" x 28" sign



Revised 6-2025
\$76.99 ea. | Item #BH-28

Pedestal base and post

- Black cast iron
- 48" height post
- 14.5" diameter base

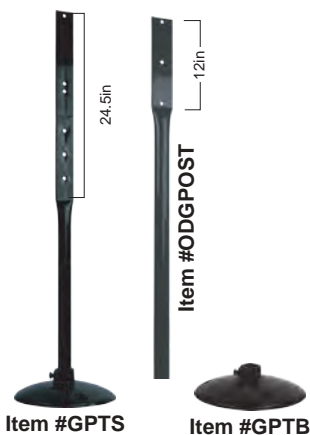

Revised 6-2025

PRICE	ITEM #
\$95.99 ea.	GPTS (base and 24.5" post)
\$70.99 ea.	GPTB (29 lbs. base only)
\$46.99 ea.	ODGPOST (12" post only)

INDOOR DISPLAY STAND

High Quality

- Base 16"
- Height 66"
- Radius corners
- Sturdy aluminum frame
- Available in black & silver
- Stand holds 22" x 28" sign

Revised 6-2025

\$224.99 ea. | Item #LF128B [black]
\$224.99 ea. | Item #LF128S [silver]

High Quality deluxe stand

- Height 60"
- Black or silver
- Textured aluminum
- Steel base 14" x 12"
- Holds 22" x 28" sign

Revised 6-2025

\$169.99 ea. | Item #LF228B [black]
\$169.99 ea. | Item #LF228S [silver]

CHROME POSTER FRAME

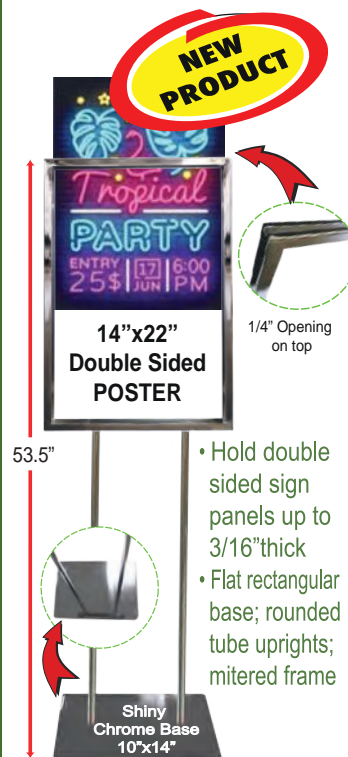

\$70.99 ea. | Item # 403-CH
Revised 6-2025

ULTIMATE A FRAME HINGE & FEET

All aluminum construction with black anodized finishing 14" long with built in self lock [no chains needed]. Holds up to 36" wide signs and gives your A frame sign a professional look. Help protect the bottom of your sign with feet that lift your A frame off the ground



#SF04

Ultimate Aluminum Feet

Ultimate Hinge will hold up to 36" wide



#SF36

Revised 6-2025

\$15.99 set of 4 feet | Item #SF04

14" Hinge \$21.99 | Item #SH36

PLASTIC "A" FRAME HINGE

Fits panels 1/4" to 1/2" thick



PLASTIC "A" FRAME HINGE

Revised 6-2025

\$ 9.99 each | Item #SP12 12" Hinge

\$11.99 each | Item #SP14 16" Hinge

The Billboard

- 360° messaging
- **Quick-Change** feature
- Twice as big as a signcade
- Can hold two sided top rider
- Holds up to 6 signs per display
- Has wheels for easy movement
- Stay tabs hold main signs securely in place

Top sign rider

\$9.99 each | Item #TBTR

- Cut to fit
- 4mm coroplast

Side sign

\$22.99 per set | Item #TBSP

- Cut to fit
- 4mm white coroplast
- 2 pieces per set

\$197.99 each | Item #195-W [white]

\$197.99 each | Item #195-B [black] *Revised 6-2025*

Available in White Black

**Sign Size
36" Wide x 48" High**



top sign rider available

FITNESS CLUB

Side sign available at additional cost

Top Dimension 5.25"
Bottom Dimension 32.0"
Overall Height 40.5"
6mm Horizontal flutes

Mini Signicade Deluxe

- Double sided
- Weight 0.9 lbs
- Holds two 8.5" x 11" signs
- All plastic countertop display
- Dimensions of sign area: 8.5" x 10.5"
- 2 clear acrylic cover sheets provided
- Easy slide in sign no adhesive needed
- Use as a marker board with wet erase markers
- Fits 50mil or .05" thick | 40mil with acrylic sheet



Holds two 8.5" Wide x 11" High signs
\$19.99 ea | Item #MINISD
 2 for \$18.99 ea *Revised 6-2025*

Minicade

- Double sided
- Molded-in handle for easy portability
- Regressed sign areas help protect sign
- Features **CLICK-LOCK** hinges for a positive interlock in the open position
- Can hold coroplast, acrylic and metal sheets with surface preparation



Holds two 12" Wide x 24" High signs
\$50.99 ea / Item #MC2412
Revised 6-2025

Narrowcade

- Double sided
- All plastic sign frame
- Holds two signs 12" x 24"
- Perfect for small and narrow areas
- Regressed sign area helps protect sign
- Features **CLICK-LOCK** hinges for a positive interlock in the open position
- Can hold coroplast, acrylic and metal sheets with surface preparation

Holds two
 12" Wide x 24" High signs



Available in White Yellow

\$53.99 each | Item #150-W
\$53.99 each | Item #150-Y
Revised 6-2025

Quik Sign

- Double sided
- All plastic design
- 25.6" Wide x 30.2" Tall
- Change signs in seconds
- Built in handle for portability
- Grabber hinges hold a sign rider
- Fits rigid material 3/16" or less



Available in White Black
 Holds two 24" Wide x 18" High signs

\$52.99 each | Item #QSF

Revised 6-2025

Simpo Square 24

- Non slip feet
- Double sided
- All plastic design
- Built in handle for portability
- No clips | no bolts | no latches
- Fits rigid material 3/16" or less
- Grabber hinges hold a sign rider
- Stay Tabs assures sign stays in place



Available in White Black
 Holds two 24" Wide x 24" High signs

\$48.99 each | Item #SSQ

Revised 6-2025

Signicade

- Solid faces
- Double sided
- Heavy duty white plastic
- Attached with double sided tape or wellnuts and screws

Holds two 24" Wide x 36" High signs

Double Sided



Can be filled with water or sand for extra stability.

\$79.99 each | Item #PS32

Revised 6-2025

EXTRA PACKAGING CHARGE IF SHIPPED

Signicade Deluxe

- Use coroplast signs or other material 3/16" or less
- With patented Quick change feature signs easily slide in and out

Holds two 24" Wide x 36" High signs

Double Sided



Can be filled with water or sand for extra stability.

Available in

White

Black

\$96.99 each | Item #PS32D

Revised 6-2025

EXTRA PACKAGING CHARGE IF SHIPPED

Simpo Sign II

- Double sided
- Change sign in seconds
- Holds material 3/16" or less
- Stay tabs holds signs in place
- Grabber hinges hold a sign rider
- Textured feet for smooth surfaces
- Stabilizing brace helps to prevent spreading or closing of the sign face



Available in White Black

Holds two 22" Wide x 28" High signs

\$62.99 each | Item #SSF2

EXTRA PACKAGING CHARGE IF SHIPPED

Revised 6-2025

SignicadeMDX

- Double sided
- No maintenance
- Change sign in seconds
- Stay tabs holds signs in place
- Great for indoor and outdoor use
- Medium size version of Signicade deluxe



Available in White Black

Holds two 18" Wide x 24" High signs

\$56.99 each | Item #MDX1

EXTRA PACKAGING CHARGE IF SHIPPED

Revised 6-2025

PORTABLE TUBE “A” FRAME

This portable A - frame is easy to assemble. Sign can be double or single sided. It breaks down conveniently for easy portability. The Portable Tube A - Frame is lightweight yet durable.

Frame holds
27” W x 38” H



Available in
 White
 Black

\$55.99 ea. | Item #FRL3827
4+ \$51.99 ea.

\$15.99 ea. | Item #PVC3827
1/8” White PVC insert with grommets

Revised 6-2025

BLACK REAL ESTATE “A” FRAME

Stand Holds
18” W x 24” H

- Double sided
- Folds nicely for convenient storage

4 per case



\$28.99 each | Item #AF1824B

Revised 6-2025

TOP LOADING “A” FRAME

- Easy loading
- Double sided
- All steel construction
- Holds any 3/8” substrate
- Frame and hardware only

Stand Holds
24” W x 36” H

4 per case



Revised 6-2025

\$55.99 each | Item #A3624
Extra packaging charge if shipped

SIDE LOADING “A” FRAME

Stand Holds
32” W x 48” H

- Easy loading
- Double sided
- All steel construction
- Holds any 3/8” substrate
- Frame and hardware only
- Includes extra side brackets for support

2 per case

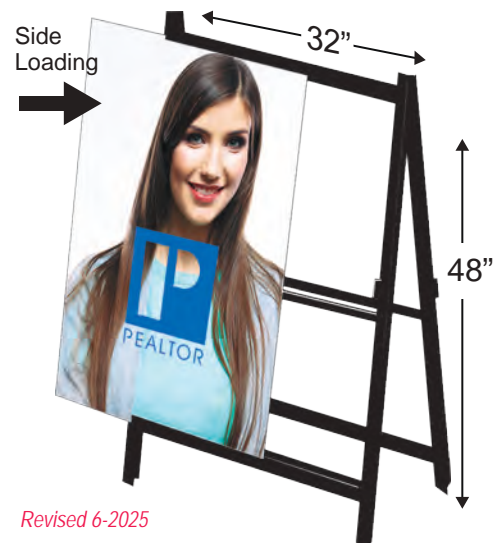

Revised 6-2025

\$69.99 each | Item #A4832
Extra packaging charge if shipped

SIERRA

OUTDOOR RETRACTOR

Great for Outdoor Events

- Includes a carrying case
- Curved silver aluminum base with black end caps
- 3 springs at center pole base allows extra wind resistance
- Banner attaches with snap rail on top and banner tape on bottom
- Removable feet attach securely to base to provide extra wide stability

An outdoor advertising solution that is durable and easy to set up. This heavy duty double sided display includes two detachable feet that when locked into the base provides a strong and stable footprint. 34" wide versatile design allows for a single or double sided message

Banner Graphics Area 33.25" Wide x 80" High *Revised 6-2025*

Retractor size 35" W x 82" H | **\$303.99 each** | 2+ \$263.99 each | Item #ORBS

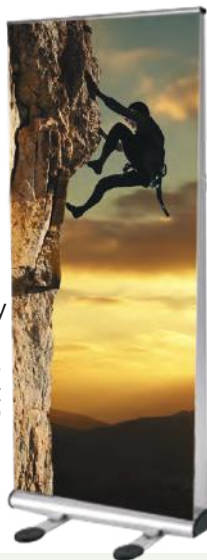

Extra Strong and Stable!



SIERRA Lite

OUTDOOR RETRACTOR

Great for Outdoor Events

- Includes a carrying case
- Almost 1/2 the weight of the Sierra
- Can be used single or double sided
- Curved silver aluminum base with black end caps
- Spring at center pole base allows extra wind resistance
- Banner attaches with snap rail on top and banner tape on bottom
- Removable feet attach securely to base to provide extra wide stability

Banner Graphics Area 32.25" Wide x 77.25" High *Revised 6-2025*

Size 35.625" W x 82.25" H | **\$183.99 each** | 2+ \$170.99 each | Item #ORBSLT

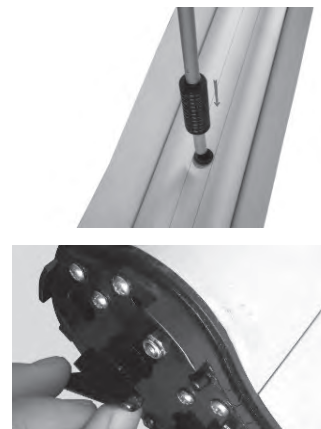

OUTDOOR A FRAME

- Made with 1/2" Omega sign board
- Exterior finished glossy vinyl over plywood core

Omega sign board features a hardwood core composed of a premium, exterior furniture grade plywood with smooth, tight, sanded veneers for optimum surface beauty

Made with the Ultimate A Frame Hinge see page 86

REDUCE IMAGE AREA BY 3 INCHES FROM BOTTOM

	Cost	Item#
16" x 24"	\$ 74.99	WAF1623
24" x 36"	\$111.99	WAF23
32" x 48"	\$163.99	WAF43

Revised 6-2025

FOR LONGER DURABILITY, EDGE SEAL EXTRA PACKAGING CHARGE IF SHIPPED



STEEL A-FRAME

- Double sided
- White gloss finish
- Ready to letter white face
- All steel welded construction

Sign Size 24" Wide x 35" High

Revised 6-2025

\$79.99 each | Item #A3424

EXTRA PACKAGING CHARGE IF SHIPPED



SILVERTONE RETRACTABLES



- Classic Design
- Extra deep base for extra stability
- Telescoping pole allows quick assembly
- 24”w units vary in height from 85”H to 92”H
- 36”w, 48”W and 60”W units vary in height from 69”H to 92”H
- Each unit comes with **HARD GREY DELUXE CARRYING CASE** (EXCEPT STBAS-W36)

Silver option 1:

pressure bar on top and on bottom roller

Graphic Area	Cost	Item #
24”w x 85” to 92”t	\$ 95.99	STBS24
36”w x 69” to 92”t	\$109.99	STBS36
48”w x 69” to 92”t	\$126.99	STBS48*
60”w x 69” to 92”t	\$157.99	STBS60*

Silver option 2: hook & loop (Velcro)

on bottom roller and pressure bar on top

Graphic Area	Cost	Item #
24”w x 85” to 92”t	\$ 90.99	STBV24
36”w x 69” to 92”t	\$105.99	STBV36
48”w x 69” to 92”t	\$121.99	STBV48*
60”w x 69” to 92”t	\$151.99	STBV60*

Silver option 3: adhesive strip

on bottom roller and pressure bar on top

Graphic Area	Cost	Item #
36”w x 69” to 92”t	\$97.99	STBAH-W36
36”w x 69” to 92”t	\$84.99	STBAS-W36
comes with soft carrying case		

Revised 6-2025

Black option 1:

pressure bar on top and on bottom roller
36”w x 69” to 92”h | **\$102.99** | STBS36B

Black option 1:

pressure bar on top and velcro on the bottom roller
36”w x 69” to 92”h | **\$102.99** | STBV36B

* has 2 support poles included

WHEN PLACING AN ORDER PLEASE SPECIFY “V” FOR VELCRO OR “S” FOR SNAP BARS AND THEN THE SIZE

ECONO RETRACTABLE BANNER STAND

Graphic Area
33.5" W x 78" H

Available in
 Black
 Silver



- Adhesive bottom bar
- Single faced display
- Shipping weight 8lbs.
- Light weight and portable
- All aluminum construction
- Includes soft carrying case
- Easy install with pressure snap top bar

\$82.99 ea. | Item #ZL13B [Black]

\$82.99 ea. | Item #ZL13S [Silver]

Revised 6-2025

Orion Deluxe Retractable Banner

Graphic Area
33.5" W x 80" H



- Chrome sides
- Single face display
- Modern looking base
- Adjustable pole to 80"
- All aluminum construction
- Includes soft carrying case
- Top bar uses a snap system
- Slide in bottom bar with removable strip
- Self winding base spring for easy rewind

Revised 6-2025

\$131.99 each | Item #RBSD

Orion Retractable Banner

Graphic Area
33.5" W x 90"H



- Chrome sides
- Single face display
- Modern looking base
- All aluminum construction
- Includes soft carrying case
- Adjustable pole up to 90"
- Tension knob to release or add pressure
- Banner attaches to plastic strip & side loads

Revised 6-2025

\$95.99 each | Item #RBSA

Orion Plus Retractable Banner

Graphic Area
33.5" W x 78" H
45.75" W x 78" H



Foldout base
for extra support



- Chrome sides
- Single face display
- All aluminum construction
- Includes soft carrying case
- Foldout base for extra support
- Pressure snap bar at top and bottom

Revised 6-2025

\$118.99 each | Item # RBSP

Orion Double faced stand

Graphic Area
33.5" W x 78" H



★ No End Cap



- Chrome sides
- Double faced display
- All aluminum construction
- Includes soft carrying case
- Pressure snap bar at top and bottom

Revised 6-2025

\$94.99 each | Item #RBSAD

RS2L-P

Graphic Area 33.5" Wide x 79" High



- Silver aluminum finish
- Great for short term use
- Includes soft carrying bag
- Same as RS2L only lighter aluminum

\$43.99 ea. | Item #RS2L-P

Revised 6-2025

13oz OR MORE BANNER MATERIAL NOT RECOMMENDED

RS2L-M

Size Options 23.5" W x 37.5" H
23.5" W x 79" H



- Adhesive bottom bar
- Ideal for trade shows
- Silver aluminum finish
- Great for short term use
- Includes soft carrying bag
- Easy install with snap top bar

Revised 6-2025

\$48.99ea. | Item #RS2L-M
Size 23.5" W x 37.5" T

\$48.99 ea. | Item #RS2L-M79
Size 23.5" W x 79"T

RS2L DELUXE

Graphic Area 33.5" W x 79" H

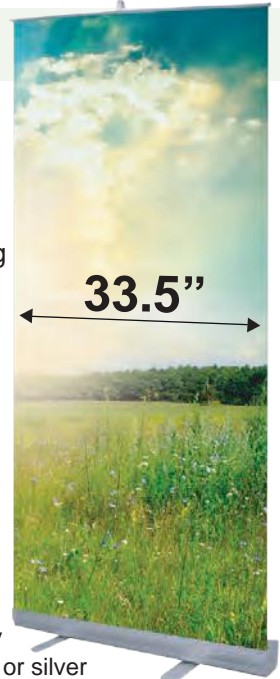

Includes soft carrying bag

- Strong and sturdy
- Available in black or silver
- Adhesive tab with spring roller
- Aluminum base with extra weight / support
- Reinforced pole support with extra bracket
- Top pressure bar with ridges to grip material

\$52.99 ea.

Item #RS2LD (S) or (B) *Revised 6-2025*

RS2L

Graphic Area 31.5" W x 79" H

Available in
 Silver
 Black



Includes soft carrying bag

- Adhesive bottom bar
- Ideal for trade shows
- Great for short time use
- Available in black or silver
- Easy install with snap top bar

\$47.99 ea. | Item #RS2L (S) or (B)

Revised 6-2025

RS2L-48 Silver

Graphic Area 47.5" Wide x 79" H

Available in
 Silver



Includes soft carrying bag

- Aluminum construction
- Adhesive on bottom bar
- Includes 2 support poles
- Easy install with snap top bar
- Great for trade show or promotional event

\$59.99 ea. | Item #RS2L48S

Revised 6-2025

in-GROUND Banner frame

GREAT FOR REAL ESTATE • GROUND LEVELS EXPOSURE • INCLUDES SIDE AND TOP POLES + CORNER CONNECTORS

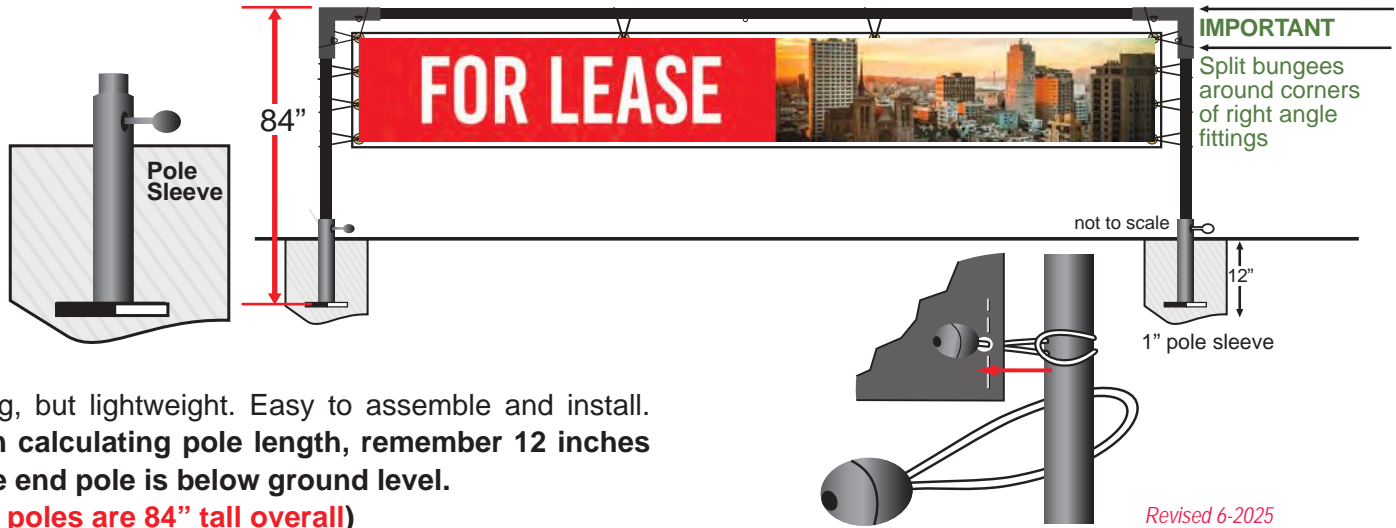

Strong, but lightweight. Easy to assemble and install.
When calculating pole length, remember 12 inches of the end pole is below ground level.
(Side poles are 84" tall overall)

- PRINT GRAPHIC NOT INCLUDED
- BALL BUNGEE SOLD SEPARATELY
- IN GROUND SLEEVES SOLD SEPARATELY
- ★KIT INCLUDES SIDE POLES, TOP POLES AND CORNER CONNECTORS

Size	4'	6'	8'	10'	12'	15'	20'
Item #	IGF4	IGF6	IGF8	IGF10	IGF12	IGF15	IGF20
Cost	\$95.99	\$109.99	\$113.99	\$129.99	\$145.99	\$167.99	\$182.99

Pole sleeve | \$17.99 ea. | Item #HBIGS1
 Ball bungee | \$ 3.99 ea. | 12+ \$2.99 ea. | Item # HBBB6

Revised 6-2025

Desktop 2 Graphic area sizes available 8 3/8" W x 12" H // 11 7/8" W x 16.5" H

- Chrome sides
- Single face display
- Modern looking base
- Graphic retracts into base
- Great for tables | desks | counters

Single Sided Roll Up Display

Revised 6-2025

\$18.99 ea. | 8 3/8" x 12" | Item #DRD8
\$22.99 ea. | 11 7/8" x 16.5" | Item #DRD11



Desktop 2 Graphic area sizes available 8 3/8" W x 12" H // 11 7/8" W x 16.5" H

- Chrome sides
- Double faced display
- Modern looking base
- Graphic retracts into base
- Great for tables | desks | counters

Double Sided Roll Up Display

Revised 6-2025

\$22.99 ea. | 8 3/8" x 12" | Item #DRD8-2
\$28.99 ea. | 11 7/8" x 16.5" | Item #DRD11-2



EZ-X Banner Stand

Sign Sizes

24" Wide x 62.5" High
31.5" Wide x 71" High



- Available in black
- Comes in two sizes
- Includes carrying bag
- Assembles in seconds
- Portable and lightweight
- Economical for large promotions
- #1 or #2 grommets in the corners

Revised 6-2025

Standard EZ - X

Size 24" W x 62.5" H

	Item #EZX
1	\$11.99 each
2 - 10	\$10.99 each
11 - 49	\$9.99 each
50 +	\$8.99 each

Extra Large EZ-XL

Size 31.5" W x 71" H

	Item #EZXL
1	\$14.99 each
2 - 10	\$13.99 each
11 - 49	\$12.99 each
50 +	\$11.99 each

econo Banner Stand

Size Options

24" Wide x 70" High
24" Wide x 61" High

- Single sided
- Includes carrying bag
- Economy version of the Ultimate banner stand



Revised 6-2025

\$26.99 each | 4+ \$14.50 each | Item #EBS

ULTIMATE BANNER STAND

- Use #3 grommets
- Assembles in seconds
- Fiberglass construction
- Portable and lightweight
- Includes free carrying bag

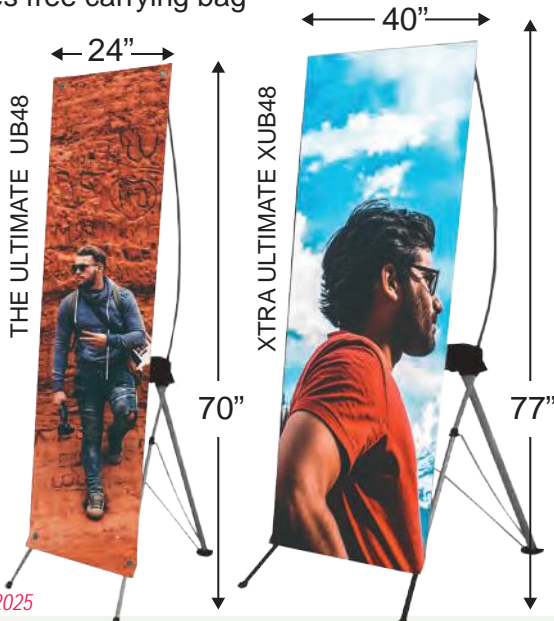

Revised 6-2025

24" W x 70" H | **\$65.99 ea.** | 4+ \$49.99 ea. | Item #UB48
40" W x 77" H | **\$95.99 ea.** | Item #XUB48

INDOOR X BANNER STAND

- Light weight and durable
- An economical display system
- Includes black nylon carrying bag
- Made out of fiber glass and aluminum
- Great for trade shows and conventions



Revised 6-2025

3 SIZES AND PRICES TO CHOOSE FROM

Graphic size	Item #	1 - 2	3 - 9	10 - 24	25+
24" x 63"	IBS24	\$19.99	\$18.99	\$17.99	\$16.99
31.5" x 70.5"	IBS36	\$28.99	\$27.99	\$26.99	\$25.99
47" x 82.5"	IBS48	\$44.99	\$43.99	\$42.99	\$41.99

Stylon

banner stand

- Stylish design
- **Carrying case not included**
- Telescoping pole from 48" to 90" high

This stylish banner stand assembles in minutes without tools. A telescoping pole goes from 48" to 90" high. The 14" square metal base includes a spring bottom lock for solid structural support. This stand holds 1 banner that can be single or double sided. Grommets are required at the top of the sign at the 1" and 19" mark.

\$35.99 each | Item #STYL-2 *Revised 6-2025*

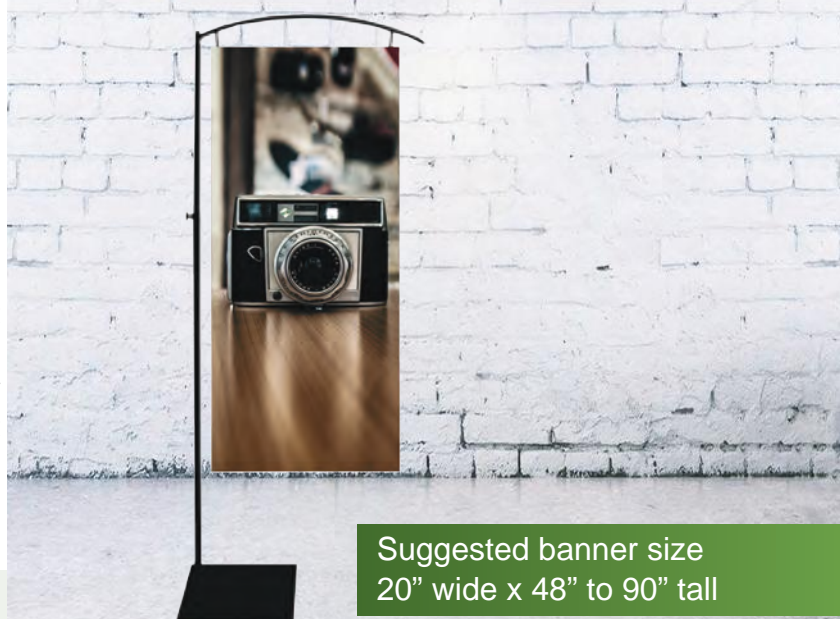

Presta

floor stand

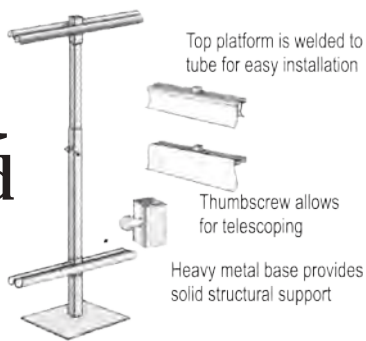

- Double sided
- Assembles in minutes
- 24" or 36" wide rod options
- Available in black and Chrome
- Adjustable height from 48" to 86"

\$85.99 each *Revised 6-2025*

Item #FS48 includes four 24" metal rods

Item #FS4836 includes four 36" metal rods



GAMMA

Outdoor Banner Display

The Gamma outdoor display banner stand is a heavy duty well constructed stand. Stability and strength are some of the great features. Each unit comes with a hollow base allowing water to be added for more stability. A single or double sided banner stand is available. An excellent option for outdoor use with banner materials, use #2 grommets in the corners.

Revised 6-2025

Banner Size
31" W x 70.5" H

Single Sided | **\$ 92.99 each** | Item #SMODB1

Double Sided | **\$105.99 each** | Item #SMODB2





Banner Bracket System

The rust-free cast aluminum brackets in combination with the 3/4" solid fiberglass arms, allows the Bracket System to withstand most outdoor elements. This Hi-Tech Bracket is built with a 1° angle to keep the banner tight. The fiberglass arms will give in the wind, reducing the wind pressure on the banner. **The arms are permanently EPOXY GLUED into the aluminum brackets. This prevents any wearing of the fiberglass rod.**



Single pole consists of:

- 4 40" stainless steel bands
- 2 Single aluminum brackets
- 2 Fiberglass poles end caps

Very Important!

Subtract 3" from your pole size for max banner width.
For example: a 40" pole can be used for a 36" wide banner.

Double Pole consists of:

- 4 40" stainless steel bands
- 4 Fiberglass poles end caps
- 2 Double aluminum brackets

A 5% Discount with orders of 25 units or more. Please call for quotes on 100 units or more

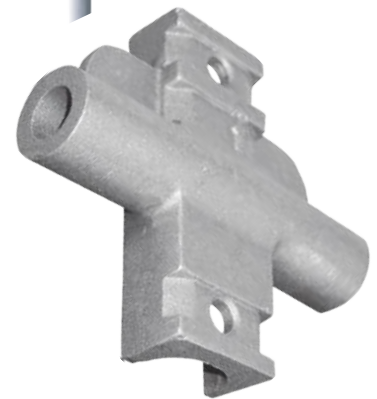

All Banner Brackets ARE MADE TO ORDER & NOT RETURNABLE

Revised 6-2025

Single pole set

Size	Specs	Cost	Item #
30"	27" or less	\$88.99	SB30
36"	33" or less	\$90.99	SB36
40"	37" or less	\$93.99	SB40

Double pole set

Size	Specs	Cost	Item #
30"	27" or less	\$110.99	DB30
36"	33" or less	\$113.99	DB36
40"	37" or less	\$115.99	DB40

Wall Mount Bracket Kit

Vertical Wall Mount System

- Indoor or outdoor
- Several pole sizes
- 3/4" fiberglass poles

\$39.99 each pair

3/4 poles - 2 1/2 Pole Pocket with #2 grommet recommended

Size	Specs	Item #
30"	27" or less wide banners	WM30
36"	34" or less wide banners	WM36
40"	38" or less wide banners	WM40

Revised 6-2025



THE PATRIOT

The Patriot Banner Bracket System consists of:

- 2 Large Pins
- 4 Strap Bands
- 2 Large Zip Ties
- 2 Black Fiberglass Poles
- 2 Cast Aluminum Brackets

The Patriot Banner Bracket is made from Cast Aluminum and the 3/4" Black poles are made from strong and light weight Fiberglass. The specially engineered springs allow the Patriot to adjust and withstand strong winds and the poles are designed to angle away from the banner keeping it nice and taut. This system is great for banners up to 25 square feet.

36" Pole
usable pole length 33 1/2"

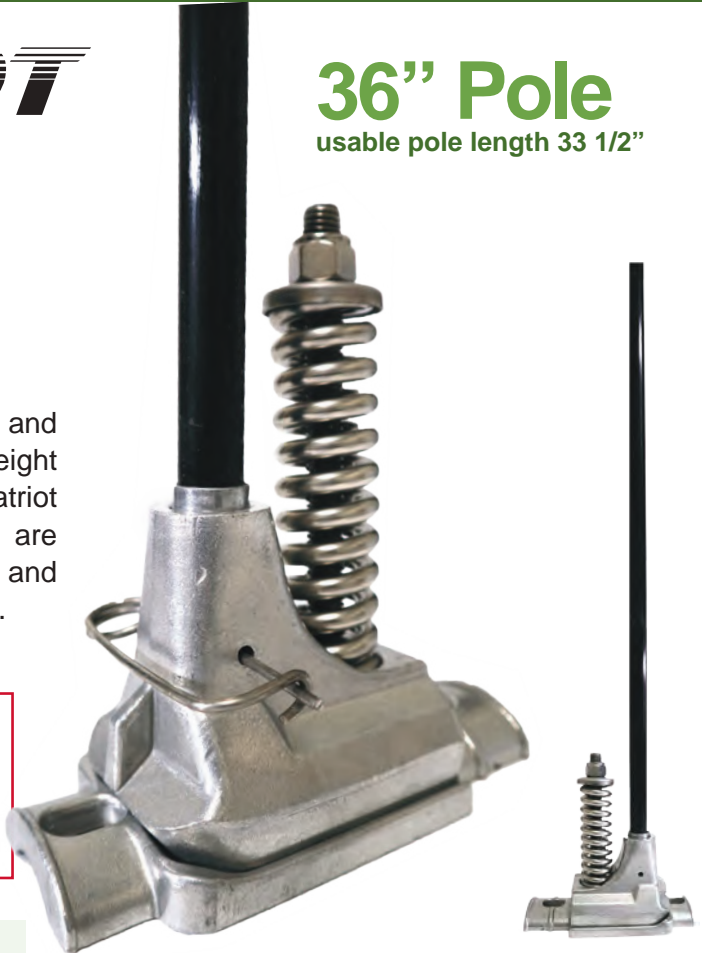

Important

To secure the banner to the pole, use zip ties through grommet holes then the gap between the pole and stainless steel band. Failure to secure banner may result in loss or damage. Do not allow banners to come into contact with high wires. It is important that brackets are mounted properly and are tight to insure the life of the banner. Check banners within 4 weeks of installation or first strong wind for needed adjustments.

\$150.99 per set | Item #PBBS *Revised 6-2025*

econo bracket system

LOOSE FIBERGLASS POLES WEAR DOWN AND CAN BREAK... BUT OUR 2 PART SYSTEM PREVENTS CHATTERING



2 Part Aluminum Bracket System

Stainless Steel Nuts and Bolt

Very Important!
Subtract 2" from your pole size for max banner width.

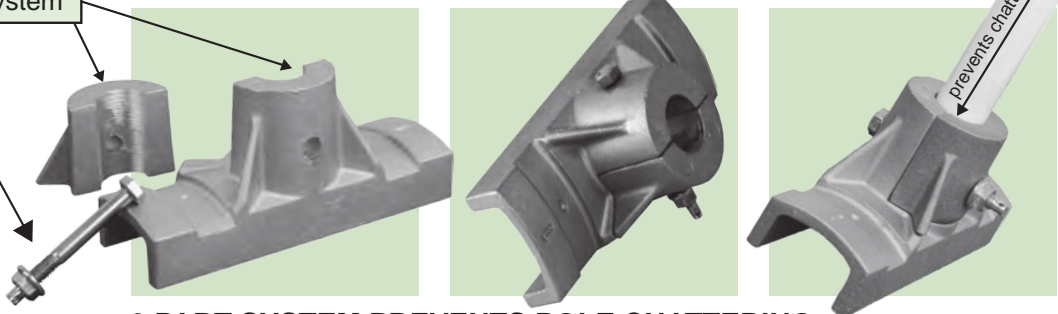

Aluminum Bracket Construction | Mounting Straps are Stainless Steel Hardware for 2 part Bracket System is Stainless Steel Fiberglass Poles Unique two part bracket assembly totally prevents " Pole Chattering "

Each set contains:

- 2 Zip Ties
- 2 Cast Aluminum Brackets
- 4 Stainless Steel Band Straps
- 2 Stainless Steel Nuts and Bolts
- 2 Fiberglass 3/4" Poles with Tip Caps

2 PART SYSTEM PREVENTS POLE CHATTERING

Important!

To secure the banner to the pole, use zip ties (not included) through grommet holes then the gap between the pole and stainless steel band. Failure to secure banner may result in loss or damage. Do not allow banners to come into contact with high wires. It is important that brackets are mounted properly and are tight to insure the life of the banner. Check banners within 4 weeks of installation or first strong wind for needed adjustments.

The **Economy Bracket System** is not only a great price, it's also made with the same high quality materials than that of the more expensive banner systems. The Cast Aluminum bracket is 100% Rust Free! The 3/4" poles are made from strong and light weight Fiberglass. No need to be concerned about a loose connection or wear-n-tear on the pole, our two part system prevents "Pole Chatter".

Single bracket pole set *Revised 6-2025*

Size	Specs	Cost	Item #
24"	22" or less wide banners	\$71.99	EBB24
30"	28" or less wide banners	\$77.99	EBB30
36"	34" or less wide banners	\$83.99	EBB36
40"	38" or less wide banners	\$86.99	EBB40

2" OF POLE LENGTH IS USED FOR BRACKET ASSEMBLY

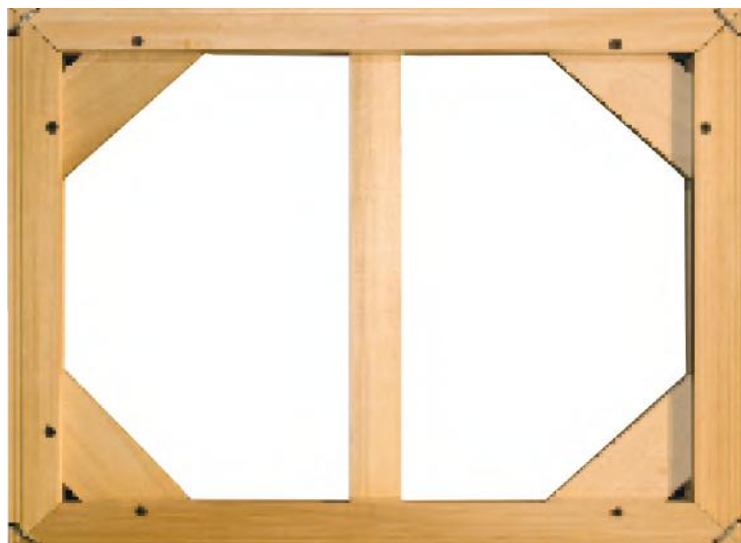

Each stretcher bar has an adhesive strip. This helps hold the material in place while canvas is being mounted.

With the purchase of four bars, 1 standard hardware kit and 4 corner braces are included. For larger frames we recommend using the heavy duty \$2.00 or super heavy duty hanging hardware \$2.50 each

Stretcher Bars

Revised 6-2025

Length	Cost	Item #
8"	\$4.99	WT08
9"	\$4.99	WT09
10"	\$5.50	WT10
11"	\$5.50	WT11
12"	\$5.50	WT12
14"	\$5.75	WT14
16"	\$5.99	WT16
17"	\$6.25	WT17
18"	\$6.50	WT18
20"	\$6.75	WT20
24"	\$7.50	WT24
30"	\$8.50	WT30
36"	\$10.00	WT36
40"	\$11.25	WT40
45"	\$12.75	WT45
48"	\$13.75	WT48

Center Brace

Length	Cost	Item #
8"	\$2.50	WTC08
9"	\$2.75	WTC09
10"	\$2.85	WTC10
11"	\$2.95	WTC11
12"	\$2.99	WTC12
14"	\$3.25	WTC14
16"	\$3.50	WTC16
17"	\$3.85	WTC17
18"	\$3.99	WTC18
20"	\$4.50	WTC20
24"	\$5.40	WTC24
30"	\$6.75	WTC30
36"	\$8.00	WTC36
40"	\$8.75	WTC40

45° Brace

Length	Cost	Item #
18" 45°	\$14.50 set of 4	4D1000
24" 45°	\$17.75 set of 4	4D1001

	Cost	Item #
Heavy duty hanger	\$2.25	WTHD
Super heavy duty hanger	\$2.75	WTSHD

Small square frames

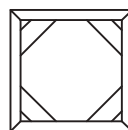

8" x 8" to 24" x 24"

Use supplied corner braces only

Small rectangular frames

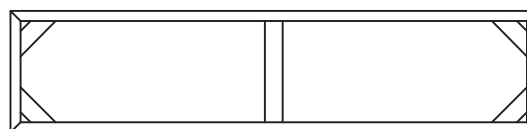

Panoramic Frames:

8" x 24" to 24" x 48" Requires 1 center brace.

Large Rectangular frames:

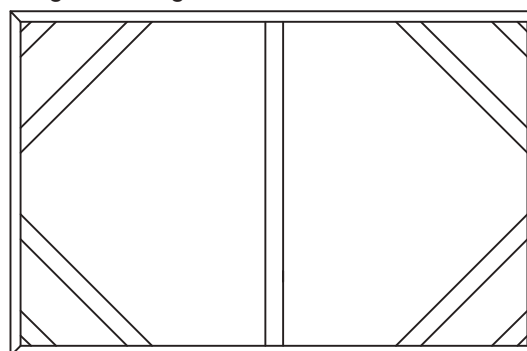

30" x 36" - (1) Center brace

30" x 40" - (1) Center brace

30" x 48" - (1) Center brace

36" x 40" - (1) Center brace + (4) 18" 45° braces

36" x 48" - (1) Center brace + (4) 18" 45° braces

40" x 48" - (1) Center brace + (4) 24" 45° braces

Large Square frames:

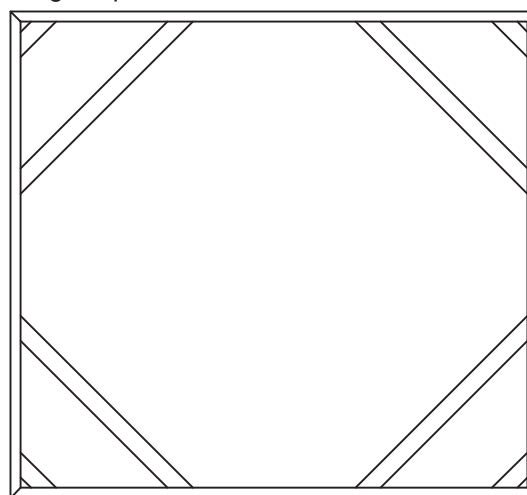

30" x 30" - (4) 18" 45° braces

40" x 40" - (4) 24" 45° braces

36" x 36" - (4) 18" 45° braces

48" x 48" - (4) 24" 45° braces

Center braces should be ordered in the same dimension as the frames size in the respected dimension, for example if your frame is 12" x 36" you will need 1 center brace that is 12".

KOMELON[®] SELF LOCK

Self Locking Tape Measure



Revised 6-2025

Size	Cost	Item #
12' x 5/8"	\$ 8.99	SL2812
16' x 3/4"	\$ 9.99	SL2816
16' x 1"	\$10.99	SL28116
25' x 1"	\$13.99	SL2825

KOMELON[®] SPEED MARK



Revised 6-2025

Size	Cost	Item #
12' x 5/8"	\$ 7.99	SM3812
16' x 3/4"	\$ 9.99	SM3816
25' x 1"	\$10.99	SM3825



This 25' tape has all the standard tape measure marking, including foot markings, stud layout and BCI layout. A special feature is the center finding scale.



Revised 6-2025

\$27.99 ea. | Item #CT25



Bench Tape

**Bench Tape
with Adhesive Backing**

- 1/2" wide steel
- Center finding scale
- Apply to a bench / work station



Revised 6-2025

\$15.99 | Item #BT12

PANTONE

solid color conversion
CMYK for Digital Printing

This indispensable solid to process guide provides a printing comparison for 1,089 solid PANTONE Colors side-by-side with their closest four-color process match on coated stock



\$261.99 ea. | Item #PBK2

PANTONE

original color formula

Color Formula Guide



\$222.99 ea. | Item #PBK1

CLEAR Custom JobFolders

- 2 options to choose from
- Heavy duty and reuseable
- Option 1 is a sleeve for 8.5" x 11"
- Option 2 has compartments to help organize [shown]



\$2.39 ea. | Item #CCJF
 100+ **\$1.80 ea.**

\$1.99 ea. | Item #CJF1 [no pockets]
 100+ **\$1.25 ea.**



STABILO

WATER SOLUBLE PENCIL
ON ANY SURFACE

A water-soluble pencil that marks clearly, densely and legibly on any surface including acetate, paper, glass, metal, photo and film. Wipes off with a damp cloth on smooth surfaces and erases on paper. Please note this is NOT an art pencil. Available individually or in boxes of 12.



\$18.99 box 12 / \$1.75 ea
 Item #SBB1 [Blue]
 Item#SPW1 [White]

LiteEdge Safety Ruler

The lite edge safety ruler is made of heavy duty, lightweight aluminium and is designed with safety in mind. Minimize accidents with the curved finger guard. Made of stainless steel ensures a long life while providing a strong steady edge for straight cuts. Further stability is provided by the super grip, slip resistant backing. A graduated edge allows for precision cuts.



Size	Cost	Item #
8.5"	\$15.99	DEDR-080
13.5"	\$21.99	DEDR-135
25.5"	\$34.99	DEDR-255
48.5"	\$62.99	DEDR-485

Revised 6-2025

BLACK BEAUTY safety ruler

- Lowest price
- Textured grip surface
- 7 lengths to choose from
- All aluminum construction
- Stainless steel cutting edge
- Measuring in inches and metric
- 2" rubber anti slip embedded on the bottom

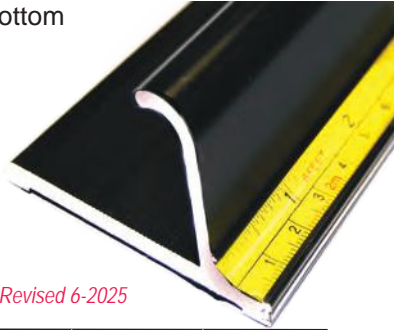

Revised 6-2025

Size	Cost	Item #
18"	\$ 41.99	BLBR18
28"	\$ 53.99	BLBR28
40"	\$ 69.99	BLBR40
52"	\$ 85.99	BLBR52
64"	\$ 92.99	BLBR64
76"	\$123.99	BLBR76
96"	\$177.99	BLBR96

BADA BING 5 Lengths to Choose From blue safety ruler

- All aluminum construction
- Stainless steel cutting edge
- Extra wide 3.5" grip surface
- Measuring in inches and metric
- Rubber anti slip embedded on both sides
- Patented hold flat design allows for pressure on the edges

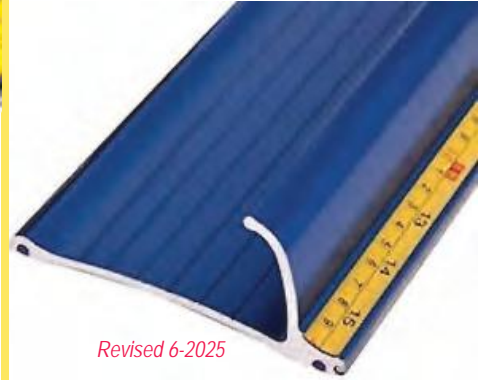

Revised 6-2025

Length	Cost	Item #
31.5"	\$ 59.99	BB31
43"	\$ 75.99	BB43
55"	\$106.99	BB55
67"	\$128.99	BB67
76"	\$137.99	BB76

Non-Slip ruler backer

High Friction Rubber Peel Adhesive

High friction rubber peel and stick adhesive. Apply to the back of any 2" wide ruler.

8' minimum order



Revised 6-2025

99¢ per foot | Item #RB02

JOHNSON aluminum ruler

- Easy to read
- 6 lengths to choose from
- Makes trimming super straight
- Heavy duty extruded aluminum
- Clear protective anodized finish

Size	Cost	Item #
18"	\$ 4.99	AR18
24"	\$ 5.99	AR24
48"	\$12.99	AR48
60"	\$18.99	AR60
72"	\$21.99	AR72
96"	\$33.99	AR96

Revised 6-2025

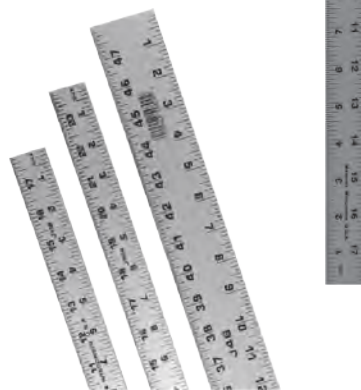

Center Point Ruler

2 Ruler Sizes: 12 inch and 24 inch

- Etched markings
- Center finding scale
- Tempered stainless steel

12" | **\$13.99 ea.** | Item #CP12
 24" | **\$15.99 ea.** | Item #CP24

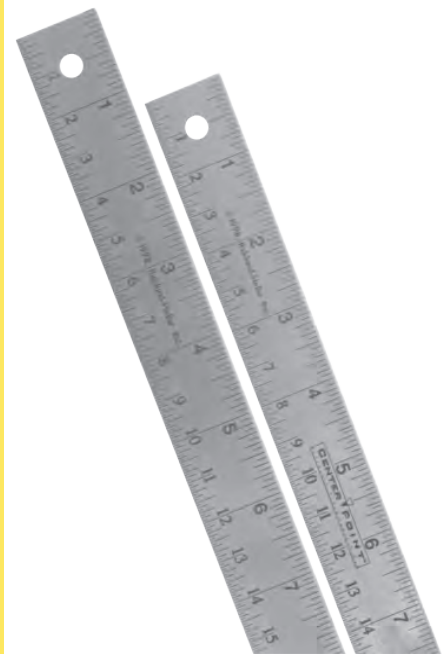

GENERAL
tweezers

Sharp Bevel Point



Finest quality tweezer design. Machined to close tolerances, these premium tweezers feature ultra-fine points and are made of hardened stainless steel.

\$8.99 ea. | Item #401A *Revised 7-28-22*

Tweezers Sharp Slanted Point



The bent nose, also occasionally known as angled tweezers are the tweezers of choice for working with small items. The angle of the tips allows easier manipulation of tiny items, especially where you are using the tweezers to aid assembly.

\$8.50 ea. | Item #CEG6 *Revised 7-28-22*

GRIP ON HOOK WEEDER



Revised 7-18-24

\$15.25 ea. | Item #30619
\$ 7.99 pk. | Item #30623 Replacement hooks (2 per pack)



Double Ended Knife Pin and Embossing Tool



#11 Blades

Revised 7-18-24



\$16.99 ea. | Item #30610
pin replacement (5 pack) | Item #30616

\$27.99 per box | Item #HB11
replacement blades #11

\$7.99 pk. | Item #30616
pin replacement (5 pack)



4 Different kinds of
Blades included

Precision art knife
\$18.50 ea.
Item #AK4 *Revised 6-2025*

Replacement Blade
\$5.50 ea. [5 pack]
Item #RAK4



Aluminum
Knife Holder

1 Blade included *Revised 6-2025*

\$3.99 ea.
Item #16001

Deluxe
Blade Holder

K26 Fit
Grip Knife



1 Blade included *Revised 6-2025*

\$6.99 ea.
Item #10627



**Art
Knife**

Carving
Scraping

5 Blades included



Revised 6-2025

\$11.99 ea.
Item #AK15

Replacement Blade
\$ 6.99 ea. [25 pack]
Item #RAK15

PROTEK CUTTING MAT

Cutting surface available with and without printed grid



EXTRA TOUGH
Extra THICK

- Solvent proof
- Translucent for light table
- Self sealing, knife cuts close up
- Made from seamless .182 gauge virgin polyethylene

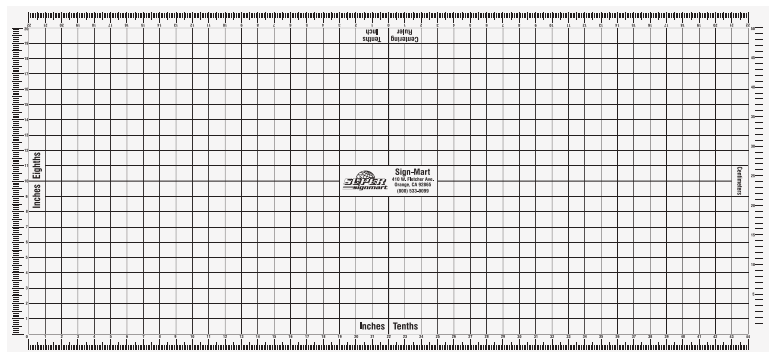

- * 2' x 4' | 4' x 8' \$10.00 per cut
- * 6' x 10' | 4' x 10' \$20.00 per cut
- * 4' x 12' | 5' x 12' | 6' x 12'
- Must be cut on router
- Minimum cut charge \$75.00
- Dimensions will be 1/4" shorter due to bit size *Revised 6-2025*

UNprinted	Cost	Item #
2' x 4'	\$ 25.99	CM24
4' x 8'	\$122.99	CM48
4' x 10'	\$129.99	CM410
4' x 12'	\$154.99	CM412
5' x 8'	\$131.99	CM58
5' x 10'	\$154.99	CM510
5' x 12'	\$201.99	CM512
6' x 10'	\$203.99	CM610
6' x 12'	\$228.99	CM612

The Very Best Prices!

SCRAPERITE Double Edge Plastic Razor Blades

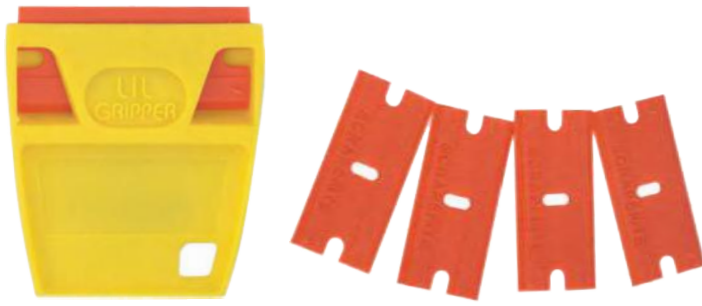

Options	Cost	Item #
1 Holder 5 blades	\$ 8.99	SCRITE
1 Holder 25 blades	\$11.99	SCRITE25
50 blade pack	\$15.99	SCRITE50

Revised 6-2025

Retractable **Window Scraper**



Revised 6-2025

\$10.99 ea. | Item #RWS

Scraper Blades

Replacement Blades for Item #RWS



Revised 6-2025

\$2.99 [10 pack] | Item #RWSRB

OLFA Scraper

Multi-purpose 25mm scraper



Revised 6-2025

\$12.99 ea. | Item #SCRS

OLFA Scraper

Multi-purpose 60mm scraper



Revised 6-2025

\$13.99 ea. | Item #SCRL

Yellow Scraper
Size 4.25" x 3.87"



Revised 6-2025

\$1.99 ea. | Item #AB5

XL Size Scraper 6.75" x 11"



Revised 6-2025

\$7.99 ea. | Item #XLBS

Black Felt
Black Felt Edge Blanks



Item #BF24
2" x 4" | **\$4.99** [set of 6]

Item #BF25
2" x 5" | **\$5.50** [set of 6]

Revised 6-2025

Squeegee Protector
Microfiber Material



\$5.99 [3pack] | Item #WGSP

Revised 6-2025

Lil'Chizler

Takes vinyl off from aluminum, plexiglass and painted wood
Safely Removes Vinyl



\$1.50 ea. | 12+ \$1.00 | Item #LLC1

Revised 6-2025

Squeegees

FELT EDGE Felt Edge Wrapped Squeegee

Saves time and money by eliminating the need to pre-mask or wrap squeegees. Protects vinyl from scratching, marring and air pockets.

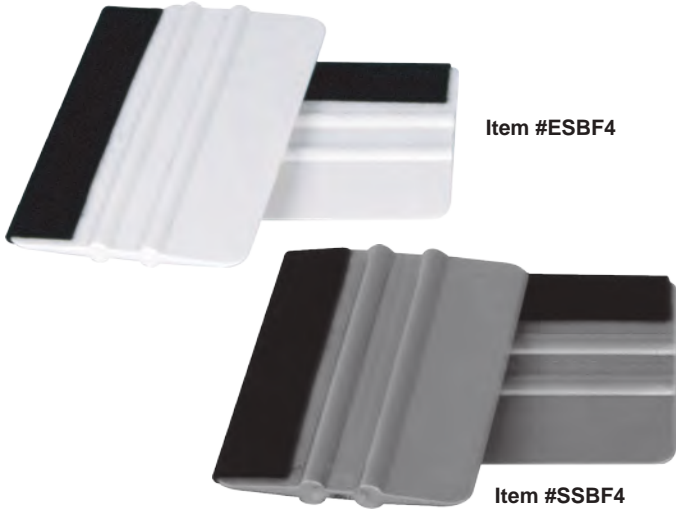

ECONOMY SQUEEGEE WITH BLACK FELT *Revised 6-2025*
 2 7/8" x 4" | **\$2.25 ea.** | 5+ \$1.99 each | Item #ESBF4
 2 7/8" x 5" | **\$2.50 ea.** | 5+ \$2.25 each | Item #ESBF5

SILVER SQUEEGEE NYLON REINFORCED WITH BLACK FELT
 2 7/8" x 4" | **\$2.99 ea.** | 5+ \$2.75 each | Item #SSBF4

WRAP SQUEEGEES



Item #SLSQ4 | Item #SLSG6
Best When Wet Edge + Double Layer Microfiber



Item #MSLS4 Magnetic
Best When Wet Edge + Double Layer Microfiber



Item #MSQ4 Magnetic



Item #SL3MG
Best When Wet Edge + Double Layer Microfiber

Revised 6-2025

4" **\$11.99 ea** | Item #SLSQ4 | 6" **\$13.99 ea** | Item #SLSG6
 4" **\$8.99 ea** | Item #MSQ4 | 4" **\$13.99 ea** | Item #MSLS4
 4" **\$17.50 ea** | Item #SL3MG

FELT SQUEEGEES

2 sizes and density available



Great squeegee for a "NO SCRATCH" application. A must have for a quality digital production

Medium Density:
 3" x 4" x 1/2" thick
\$8.99 ea. | Item #FS40

Hard Density:
 2.5" x 5" x 1/2" thick
\$11.99 ea. | Item #FS50

Revised 6-2025

Custom Printed Squeegees

- \$30.00 one-time set up charge
- Available in black ink
- A great customer giveaway
- 200 custom printed squeegees for \$240.00

Revised 10-2025

\$1.20 ea [200 total] **for \$240.00** | Item #ECS4P



Available in 2 sizes and in White or Yellow. *Revised 6-2025*



Item # ECS4	
2 7/8" x 4"	Cost
1 - 5	\$1.08
6 - 30	90¢
31 - 100	85¢
101 - 199	80¢
200 - 600	75¢
601 - 1000	70¢
1001+	60¢

Item # ECS5	
2 7/8" x 5"	Cost
1 - 5	\$1.25
6 - 30	99¢
31 - 100	90¢
101 - 199	85¢
200 - 600	80¢
601 - 1000	75¢
1001+	65¢

Squeegee 2 sizes

3" x 6" and 3" x 12"



Revised 6-2025

3" x 6" | **\$1.99 ea.** | Item #WSQ6
 3" x 12" | **\$4.50 ea.** | Item #WSQ12

Teflon Squeegee

Teflon Squeegee
2-7/8" x 4"

- Teflon characteristics
- Very stiff clean edge
- Squeegee glides over vinyl



Revised 6-2025

\$3.50 ea. | Item #TFLS4

ROLLER Squeegee

Size 2-7/8" x 4"

- A squeegee and brayer in one



Revised 6-2025

\$8.99 ea. | Item #SMRS

Silver Squeegee

- Size 2-3/4" x 4"
- Nylon reinforced
 - Designed to last longer



Revised 6-2025

\$3.50 ea. | 6+ \$2.99 each | Item #SS4

3M GOLD

3M Gold Squeegee
2-3/4" x 4"

- Long lasting
- Nylon Reinforced



Revised 6-2025

\$8.99 ea. | Item #3MGS

\$203.00 [25 per pack] Item #3MGS25

Econo Blue Brayer



Revised 6-2025

\$10.99 ea. | Item # EBB

Hunt SpeedBall

Size
4" Roller
4" Handle



Revised 6-2025

\$17.99 ea. | Item # B49P

PCR ROLLER

Roll this over a dusty surface and it magically picks up every particle for a clean surface.

Roller and Tacky Pad



Revised 6-2025

6" roller + pad | **\$107.99** | Item # 3556

12" roller + pad | **\$118.99** | Item # 3551

7"x 3" pad (50 pack) | **\$44.99** | Item # PCRP

G-Force Roll Vinyl Over Rivets

The G-force PSV application tool from RollePro is ergonomically designed and specially formulated heat resistant wheel brings speed and comfort to a once time consuming application.



69.99 ea. | Item # GF1001

Revised 6-2025

POWER PUNCH

PowerPunch cuts a 5/16" diameter hole cleanly through Banner Ups® PowerTabs®, PowerTape®, and heavy duty banner substrates. This innovative tool has a replaceable punch that ensures long term durability far greater than paper punches or single-hole dies, which become dull quickly. The tool will cut substrates up to 1/8" thick and is properly sized to make center-hole cuts in PowerTabs.

Punches Holes Through Banner Ups



\$57.99 ea. | Item # BUPP

\$19.99 Replacement die | Item # RDPP

Revised 6-2025



COMPASS CUTTER

Great for a variety of projects, from model making to photography, scrapbooks and signs. The cutter is ideal for paper, film, acetates, cardboard, even light wood cutting requirements.

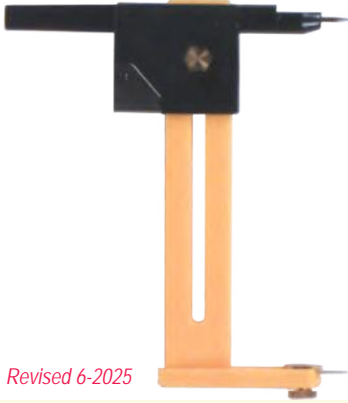

Revised 6-2025

\$16.99 ea. | Item #CMP1



\$10.99 ea. | Item #COB1
[15 blades]



Utility Knife



Ratchet Lock Knife

Revised 6-2025

\$11.99 ea. | Item #OUKA



\$7.99 ea. | Item #AB-10B [10 pack]

\$35.99 ea. | Item #AB-50B [50 pack]



Rotary Cutter



Revised 6-2025

\$39.50 ea. | Item #RTY2



\$12.99 ea. | Item #RTY2R



top sheet cutter



Revised 6-2025

\$18.50 ea. | Item #TSC1



\$5.99 ea. | Item #TSB1
[5 pack]

Breakaway knife

- Lockable
- Retractable
- 13 point breakaway



13 Point Breakaway Cutter

\$1.50 each | Item #BK59

Revised 6-2025

ECONO

utility knife



Item #EUCU
\$9.99 ea. | 2+ \$7.99 ea.



\$7.99 ea. | Item #EKRB
[10 pack] 2+ \$5.99 ea.

Revised 6-2025

OLFA Standard Duty

Ratchet Lock Knife



\$10.99 ea. | Item #300P



\$7.99 ea. | Item #AB10B
[10 pack]

\$35.99 ea. | Item #AB50B
[50 pack]

Revised 6-2025

OLFA deluxe

Stainless Steel Knife



\$14.99 ea.
Item #SVR2



\$14.99 | Item #A1160B
[10 pack] [ART BLADE]



\$10.99 ea. | Item #10SB
[10 pack]

\$35.99 ea. | Item #AB50S
[50 pack]

Revised 6-2025

OLFA Utility knife



Rubber Grip
Anti Slip
Snap Blades

\$19.99 ea. | Item #OKL2
Revised 6-2025

OLFA Utility knife



\$19.99 ea. | Item #OKFL
Revised 6-2025

OLFA Utility knife



Snap off
Blades

\$23.99 ea. | Item #OKCL
Revised 6-2025

OLFA XHD CUTTER



Extra Heavy
Duty
7.25" Long

Revised 6-2025

\$27.99ea. | Item #XHD1



\$13.99 ea. | Item #HB5B
[5 pack]

Replacement Blades for above 3 knives



\$13.99 ea. | Item #LB10B
[10 pack]

\$35.99 ea. | Item #LB50B
[50 pack]



\$42.99 ea. | Item #LBB-50B
**18mm ULTRA SHARP
SNAP BLADES** [50 pack]



Saw blade

\$17.99 ea. | Item #HSWB1
[1 blade]

Safety Razor

- locks blade securely in place for scraping
- Includes one Duro Edge Single Edge Blade
- Scrape paint, adhesives and labels



Revised 6-2025

\$1.99 ea. | Item #SR49

Swivel Blade



Revised 6-2025

\$14.99 ea. | Item #16004

\$ 6.99 | Item #20064
replacement blades [2 pack]

INDEX FINGER KNIFE

Ergonomically sculpted fingerloop for easy use. Features replaceable #11 blade and safety cap.

For use with blades
5 | 6 | 10 | 11 | 12 | 13 | 15 | 16 | 17 | 21



Revised 6-2025

\$12.99 ea. | Item #16071

DualStrip Cutter

Cuts circles, parallel lines. The aluminum handle has a swivel head and the twin adjustable parallel blades for cutting curves or scrolls. The head will also lock for straight line work. The knife allows for cutting strips 0.12in - .63in



Revised 6-2025

\$43.99 ea. | Item #70031

\$ 6.99 ea. | Item #20059
each replacement blade



Knife

- Soft handle
- 5 extra blades included

Revised 6-2025

\$7.99 ea. | Item #AL11



- Made in USA
- Aluminum Back
- Clamshell packaging
- 100 Blades per clamshell
- Wrapped in shelling paper
- Extra Keen Single Edge Blade



Revised 6-2025

Single Edge Razor

\$18.99 ea. | Item #SER1
[100 per box]



Revised 11-2025

#11 Replacement Blades

\$27.99 per box | Item #HB11
3+ \$25.99 per box

PLASTICUTTER

Hardened steel blade scores and cuts acrylic up to 1/4" thick. Swivel blade folds away safely for storage, yet stays in place when scoring. Simply score material and break along straight line.

CRAFTICS

Revised 6-2025

\$4.99 each | Item #1106087



Revised 6-2025

\$18.50 ea. | Item #P800



\$10.50 ea. | Item #P440
[3 blades]

Edge Scraper

- 4 function tool for edging
Acrylic | Plexiglas | Lucite | Acrylite
- Removes saw cuts
 - Creates rounded edge
 - Bevels thin and thick material



CRAFTICS

Revised 6-2025

\$18.50 each | Item #11060201

95

Plas Drill Bit

For drilling many types of plastics
Acrylic | Plexiglas | Lucite | Acrylite

CRAFTICS

Size	Cost	Item #
1 / 8"	\$ 6.99	1106006
5 / 32"	\$ 7.99	1106026
3 / 16"	\$ 8.99	1106005
1 / 4"	\$11.99	1106004
5 / 16"	\$15.99	1106027
3 / 8"	\$18.99	1106028
7 / 16"	\$28.99	1106029
1 / 2"	\$32.99	1106030

Revised 6-2025



Saber Saw Blades

Each package contains one blade (gold) for material up to 1/8" thick, and one blade (green) for thicker materials. Designed to cut acrylic, polycarbonate, and styrene so smoothly that edges can be polished. Blades are 3.75" long.

[Package contains both blades]



Revised 6-2025

\$10.99 per pack | Item #1106016

CRAFTICS

Elan SCISSORS

- Teflon coated
 - Non stick edges
- High quality carbon stainless steel for durability and accuracy. Florine non stick coating. Dishwasher safe



Stainless Steel Scissors

\$22.99 each | Item #ES01

Revised 6-2025



Precision applique scissors

The extra-large handle fits up to 3 fingers in one loop to help provide more strength and comfort in the cut. Symmetrical handles also fit both left- and right-handed users. Straight-edge blades easily slide through the fabric and are sharpened to the tip for smaller or appliqué cuts.



5 inch Precision Scissors

\$33.99 each | Item #SCS4

Revised 6-2025



Serrated edge scissors

Designed for consumer and industrial application. These scissors are made from high quality stainless steel. One of the edges is serrated which helps prevent material slippage. The 7" scissor is excellent for cutting multiple layers. Great for corrugate, paper, rubber, leather and foam.



7 inch Serrated Edge Scissors

\$39.99 each | Item #SCS2

Revised 6-2025

RAZZOR liner cutting tool

- Cuts the liner and not the label
- Makes "cut and peel" liners on any brand
- Cuts only the top sheet of layers of newspaper, Kraft paper and butcher paper

The "RAZZOR" slitting tool is a precision, hand-held device utilizing a standard single edged razor blade. The blade depth adjustment is as simple as using a screw driver which can control the depth of cut to less than a thousandth of an inch. The blade can be mounted on either side of the unit, for either left hand or right hand operation.



\$24.99 ea. | Item #TRLC

2+ \$22.99 ea. *Revised 6-2025*

Expandable Pole Slitter

- Cut by pushing or pulling
- Extends from 34" to 55" long

This extremely practical tool allows you to cut media across a table without having to lean or crawl.

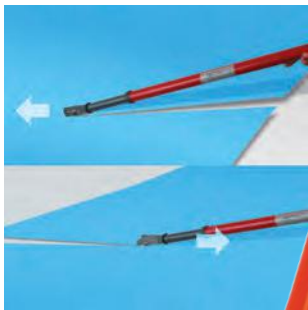

Revised 6-2025

\$49.99 ea. | Item # EXPS

Supreme-Pro Liner Slitter

Made specifically to cut through just the liner side of any pressure sensitive vinyl films. No more risk of cutting through the film side of your vinyl while on its backing paper. Special Teflon coating allows the knife to slide across the adhesive side of the vinyl, gives you a clean and easy cut through the backing.



Ultimate Vehicle Wrap Knife

\$19.99 ea. | Item # SLSK

2+ 17.99 ea. *Revised 6-2025*

Econo Pro Liner Slitter

- Easy to replace #11 blade
- Liner cutting tool for vehicle wraps
- Slit your material and avoid damaging the paint

Slightly separate the liner from the adhesive vinyl. Insert the spoon shape bottom part of the tool into the separation and push. Once the tool starts moving along and is separating and cutting, rock the tool back so the tip is slightly raised



Vehicle Wrap Tool

\$5.99 each | Item #EPLS

2+ \$3.99 ea. *Revised 6-2025*

Media Magnet



Item #WHMM

Revised 6-2025

\$12.99 ea. | 4+ \$11.99 ea.

Super Gripper

Not only does the suction cup help you lift and hold heavy items, it helps you maneuver them easily as well with its easy grasp and release handle.



4 1/2" Diameter

Revised 6-2025

\$5.99 ea. | Item #SGB1

VEHICLE WRAP MAGNET

Positioning wrap during install

Long handle makes it easy to remove after holding vinyl in place during installation. A better option than using masking tape.

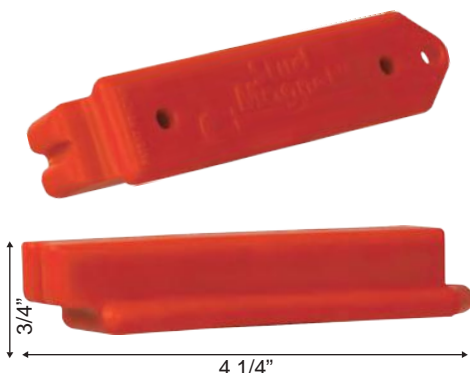

Revised 6-2025

\$14.99 ea. | Item #WRMG

3M Tape Primer 94



Use to improve vinyl adhesion where vinyl will be stretched and heated into concave areas. For best results, apply a thin layer of primer 94 over most of the concave area. For convex areas, apply a thin layer at the outer edge of the curve to prevent film edge lifting. Great for use on complex vehicle contours. Work with all brands of vinyl.

WILL CALL AND LOCAL DELIVERY ONLY

Revised 6-2025

1/2 pint **\$45.99 ea.** Item #3M9412 PT

DELUXE RETRACTABLE KNIFE

Simple and clean knife design for easy cutting and trimming. Includes A retractable and replaceable blades for use with blade 66



Revised 6-2025

\$18.50 ea. | Item #10648
\$ 6.50 pk. | Item #20066
 (2 per replacement pack)

RETRACTABLE PIN VISE / AIR RELEASE TOOL

Puncture film already applied to a substrate to remove entrapped air bubbles. Fits in your pocket.



Revised 6-2025

\$31.50 ea. | Item #16050
\$20.99 pk. (2 per pack)
 replacement pack | Item #30621

Pounce Wheel Kit

3 Different Sizes

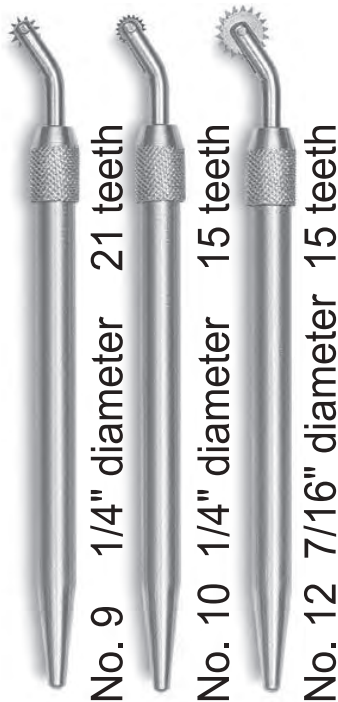

Revised 6-2025

\$39.99 ea. | Item #30612

Pounce Wheel

7/16" in diameter

- 15 teeth per inch
- Polished aluminum
- No 12 pounce wheel
- wheels made of steel



Revised 6-2025

\$16.99 ea. | Item #30607

Rivet Brush

2 Size: 3 inch and 1.5 inch



Item #RV15 Item #RV30
1 1/2" diameter 3" diameter

Revised 6-2025

\$19.99 ea. | Item #RV30 | 3"

\$ 9.50 ea. | Item #RV15 | 1 1/2"



Air Release Tool



With multiple pins, only a single press is needed to remove bubbles, saving time and energy. Excellent over rivets. Comes with box of 48 replacement pins inside the handle.

Revised 6-2025

\$88.99 ea. | Item #3MPP1



Magic Pad Applicator



Large handle grip for control and comfort. Foam pad makes it easy to conform heated vinyl over rivets or other irregular surfaces. Great for digital graphics too.

Revised 6-2025

\$37.99 ea. | Item #CMPP1

Media Band 18"

• Keeps rolls from unraveling



Revised 5-2025

\$2.99 each | Item #18MB

Speed Clip

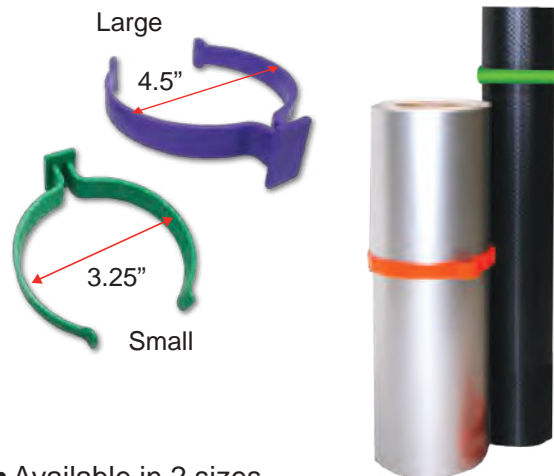

- Available in 2 sizes
- Keeps rolls from unraveling

Size	Cost	7 - 49	50+	item #
Small	\$1.59	\$1.45	\$1.35	SPCS
Large	\$1.89	\$1.75	\$1.45	SPCL

Revised 5-2025

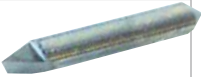
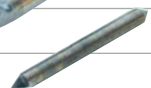
Item #	Description	2 - 4 mil vinyl	Engin. Grade Reflect	Amber Ruby Lithe	Sand Blast	Cost Each	Cost 5+	Compatibility
Gerber 4145	Gerber 45°	•		•		\$39.99	\$38.99	Mutoh XP Series 4 Gerber Fast Track 
1030	Gerber 30° flat	•				\$27.99	\$26.99	Gerber Signmaker III, Signmaker IV and IVB. HS15Plus, HS750 Plus, Sprint Super Sprint and Lettersmith 
1045	Gerber 45° flat	•	•	•		\$27.99	\$26.99	
1060	Gerber 60° flat		•		•	\$27.99	\$26.99	
Gerber GSX 2742	Gerber GSX 42°	•	•	•		\$42.99	\$41.99	GSX Series 
Gerber GSX 2760	Gerber GSX 60°		•		•	\$42.99	\$41.99	
Ioline 1430	Ioline 30°	•				\$27.99	\$26.99	Ioline Studio / 7, Studio / 8, Artpro, Super 88, Techno Art Switchblade Classic 
1445	Ioline 45°	•	•	•		\$29.99	\$28.99	
1460	Ioline 60°		•		•	\$35.99	\$34.99	
Ioline Signature 1530	Ioline 30°	•				\$23.99	\$22.99	Ioline 5000 Series and Techno Arts Bladerunner 
1545	Ioline 45°	•	•	•		\$23.99	\$22.99	
Roland 1330	Roland 30°	•				\$35.99	\$34.99	All Roland Camm-1's Allen Datagraph, Anagraph EMS, Vinyl Color Camm and CAMMJET 
1345	Roland 45°	•	•	•		\$35.99	\$34.99	
1360	Roland 60°		•	•	•	\$35.99	\$34.99	
Mimaki 2037	Mimaki 37°	•		•		\$38.99	\$37.99	Mimaki CG-45, CG-50 CG-60 and CG-90 
2040	Mimaki 40°	•	•	•		\$38.99	\$37.99	
2056	Mimaki 56°		•		•	\$38.99	\$37.99	
Graphtec 1945	Graphtec 45°	•	•	•	•	\$31.99	\$30.99	American Graphtec CB09U and FC100 SERIES American Graphictec CB-15U 
1960	Graphtec 60°		•	•	•	\$41.99	\$40.99	
3245	Graphtec 45°	•		•		\$38.99	\$37.99	
		•	•	•				
Summa Graphics T-Series 3036	Summa Graphics 36°	•	•	•		\$51.99	\$50.99	T Series 
3060	Summa Graphics 60°		•	•	•	\$51.99	\$50.99	
Summa Graphics D-Series 3335		•	•	•		\$35.99	\$34.99	AR 20 / 50, A6 Series, Signline Series, AG 501, 751, 130 
3360			•	•	•	\$35.99	\$34.99	
Aristo 2135	Aristo 35°	•				\$42.99	\$41.99	Excell II, Excel V and Excel-EM 
ANagraph 1230	ANagraph 30°	•				\$38.99	\$37.99	ANagraph and AE Series APD 
1260	ANagraph 60°				•	\$38.99	\$37.99	
ANagraph Express and APD 3645		•	•	•		\$31.99	\$30.99	
3660					•	\$38.99	\$37.99	
Zeta 2245	Zeta 45°		•	•		\$39.99	\$38.99	Zeta 

Revised 6-2025

Vinyl Rack

Floor System



- Ultra strong
- no weld design
- 44 roll capacity
- Easy to assemble
- 36" x 50 yard rolls
- Durable powder coat finish
- 14" long heavy duty brackets

free up floor space and protect your vinyl. The Sign Mart rack help keep your work space clean, organize and presentable.



Revised 6-2025

\$274.99 ea. | Item #VF44

VINYL MOVER

Heavy Duty Media Rack



- Heavy duty
- 20 roll capacity
- Powder coated finish
- All welded construction
- Holds 3" x 60" in length

Revised 6-2025

\$452.99 | 2+ \$418.00 ea. | Item #HD20

VINYL RACK WALL SYSTEM

Vinyl Material
Wall Rack
System

Keep your sign shop clean, organized and efficient. This vinyl wall mount is made of steel square frame construction. The rack holds upto 16 rolls of material. 15" and 20" rolls are recommended with a few 24".

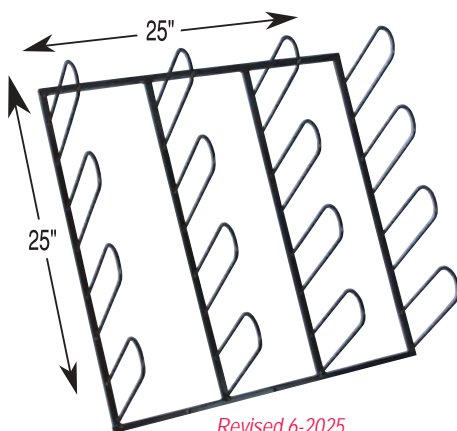

Revised 6-2025

\$59.99 ea.
Item #WB16 [black]
Item #WC16 [chrome]

HEAVY DUTY wall rack system

- Heavy duty • Black finish
- 20 roll capacity • Easy assembly

The heavy duty wall rack is the toughest wall storage system available. Able to hold 20 roll of material on it's 14" steel brackets.

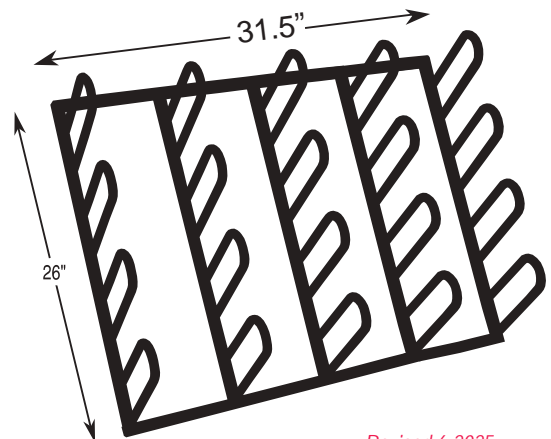

Revised 6-2025

Vinyl Material Heavy Duty Wall Rack

\$71.99 ea. | Item #HW20



Vinyl Remover

Removes vinyl graphics, decals, tape, film and adhesives

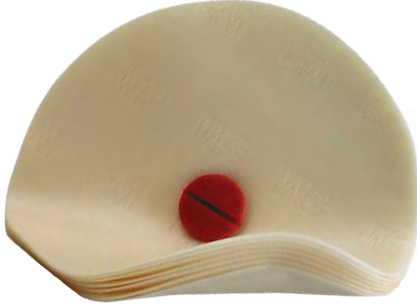

Use 1/4" drill 4,500 RPM recommended
Use all discs in each set at the same time

Size	Cost	Item #
4" x 3/8" Removal Disk	\$28.99	3MRDA
3M Disk Pad Holder	\$19.99	3MDPH
Removal Kit [2] 4" x 3/8" Removal Disk	\$64.99	3MVRK

Revised 6-2025

MAKE SURE TO PRE-TEST ALL PAINTED SURFACES SIGN-MART IS NOT RESPONSIBLE FOR DAMAGE.

MBX ELECTRIC VINYL REMOVER Vinyl Remover

Removes decals, pinstripes and adhesives with no vibration or jumping. This tool has a very unique and steady peeling motion.



Revised 6-2025

Size	Cost	Item #
Replacement Wheel	\$51.99	RWMBX
Replacement Wheel set of 3	\$104.99	RWMBX3
MBX Vinyl Remover	\$728.99	MBXTL
MBX Vinyl Remover Kit	\$786.99	MBXKIT

MAKE SURE TO PRE-TEST ALL PAINTED SURFACES SIGN-MART IS NOT RESPONSIBLE FOR DAMAGE.

Vinyl Off Effective and Safe

- Non toxic
- Water soluble
- Biodegradable
- Non flammable



ALWAYS TEST FIRST. **Vinyl Off** WILL REMOVE PAINT. **ONLY APPLY Vinyl Off TO VINYL**

Size	Cost	Item #
1 Quart	\$ 43.99	VOQT
1 Gallon	\$129.99	VOGAL

Revised 6-2025

The Stripe Eliminator

This tool removes stripes, lettering, decals and molding adhesives from most surfaces. No secondary cleaning is necessary. The result is clean and smooth with no burning or discoloration to the surface area.

Removes Vinyl



Use 1/4" drill
700 - 1200 RPM recommended

MAKE SURE TO PRE-TEST ALL PAINTED SURFACES SIGN-MART IS NOT RESPONSIBLE FOR DAMAGE.

4oz | **\$22.99 ea.** | Item #HT - S4
6oz | **\$30.99 ea.** | Item #HT - SG

NON RETURNABLE ITEM *Revised 6-2025*

Arbor Adapter

- Use with CRAFTICS
- 1/4" mandrel
 - Holds buffing wheel
 - For hand held drills



CRAFTICS *Revised 6-2025*

\$10.99 ea. | Item #1106053

BUFFER KIT

For buffing the edges of Acrylic | Acrylite | Plexiglas

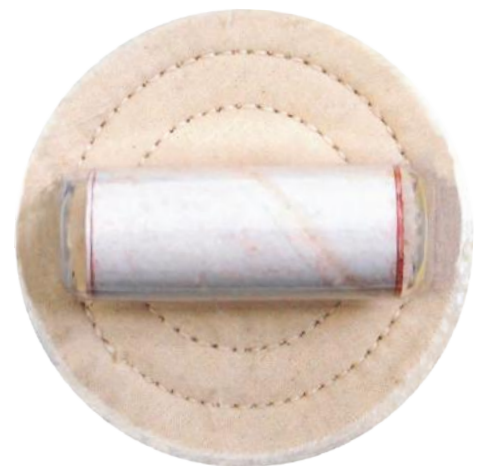

Kit Contains

- 4" diameter cloth wheel
- 2 oz stick red buffing compound

CRAFTICS *Revised 6-2025*

\$17.99 ea. | Item #1106019

ORANGE PEEL

Natural Citrus Based Solvent Adhesive Removal

Orange peel adhesive remover is a natural citrus based solvent, developed for the removal of oil and water based adhesives, wax, tar, oil, chewing gum and ink graffiti. May be used on automotive, boat, glass, acrylics, metal, masonry, cloth / vinyl fabrics and many other surfaces.

- A pleasant smelling formula
- Contains no toxic petroleum distillates

Revised 6-2025

SHIPS FEDEX GROUND AND LOCAL DELIVERY ONLY

Size	Cost	Item #
1 Qt	\$ 39.99	OPQT
1 Gal	\$112.99	OPGAL



RAPID REMOVER

Remove most adhesives in 30 - 60 seconds. Great for quick and clean removal without damage to surface.



Size	Cost	Item #
1 Qt	\$25.99	RRQT
1 Gal	\$65.99	RRGAL
5 Gal	\$287.00	RRGAL5

Revised 6-2025

SHIPS FEDEX GROUND AND LOCAL DELIVERY ONLY

GRAFFX GONE

Softens adhesive residue

Softens adhesive residue for removal within 90 seconds on most surfaces. Spot test on new paint before using.

USE ON

- Glass
- Lexan
- Styrene
- Styrofoam
- Plexiglass
- Vinyl banners
- Painted surfaces

Revised 6-2025

Size	Cost	Item #
4 oz	\$ 4.99	GG4OZ
1 Qt	\$14.99	GGQT

SHIPS FEDEX GROUND AND LOCAL DELIVERY ONLY



WINDOW JUICE

Vinyl Application Solution

Specifically formulated to make vinyl application on glass an easier and better result.



Revised 6-2025

SHIPS FEDEX GROUND AND LOCAL DELIVERY ONLY

4 oz | \$ 5.99 | Item #WJ4OZ

1 Qt | \$15.99 | Item #WJQT

Quick Stick

Application Fluid

Aids with adhering of pressure sensitive materials such as aircraft, fleetmarking, glass and acrylic



SHIPS FEDEX GROUND AND LOCAL DELIVERY ONLY

Size	Cost	Item #
1 Qt	\$16.99	QSQT
1 Gal	\$35.99	QSGAL

Revised 6-2025

SPLASH

Concentrate Transfer Solution



SHIPS FEDEX GROUND AND LOCAL DELIVERY ONLY

Revised 6-2025

\$17.99 ea. | Item #SPL8OZ

RAPID TAC

4 Sizes application fluid



Revised 6-2025

SHIPS FEDEX GROUND AND LOCAL DELIVERY ONLY

Size	Cost	Item #
4 oz	\$ 6.99	RT4OZ
1 Qt	\$19.99	RTQT
1 Gal	\$43.99	RTGAL
5 Gal	\$163.99	RTGAL5

RAPID PREP

Ideal for pre cleaning almost any surface



Revised 6-2025

SHIPS FEDEX GROUND AND LOCAL DELIVERY ONLY

Size	Cost	Item #
4 oz	\$ 6.99	RP4OZ
1 Qt	\$18.99	RPQT
1 Gal	\$37.99	RPGL

NOVUS

Clean and shine plastic



Revised 6-2025

2 oz | **\$5.99 ea.** | Item #NP1A
 8 oz | **\$9.99 ea.** | Item #NP1B

NOVUS

Fine scratch remover for plastic



Revised 6-2025

2 oz | **\$5.99 ea.** | Item #NP2A
 8 oz | **\$9.99 ea.** | Item #NP2B

NOVUS

Heavy scratch remover for acrylic



Revised 6-2025

2 oz | **\$ 6.99 ea.** | Item #NP3A
 8 oz | **\$14.99 ea.** | Item #NP3B

Brilliance

Clean and polish plastic



Revised 6-2025

Item #BRN80Z
 8 oz | **\$7.99 ea.** | 12+ \$6.99 ea.

Item #BRNQT
 32 oz | **\$28.99 ea.** | 12+ \$25.99 ea.

Item #BRNGAL
 Gallon | **\$36.99 ea.** | 12+ \$31.99 ea.
 105

Plexus

Clean, polish and protect plastic



Revised 6-2025

7 oz | **\$21.99 ea.** | Item #PLEX70Z
 13 oz | **\$29.99 ea.** | Item #PLEX130Z

Jetbest Replacement Ink for Roland | Mimaki SS21

- No need to flush the printer
- Perform two strong cleans after installing
- Replacement ink for Roland Eco Sol Max
- Print with OEM cartridge at the same time

440 mL Cartridge	Cost	Item #
Roland Max 1	\$86.99	JB1440R1
Roland Max 2	\$86.99	JB1440R2
Mimaki ES3	\$86.99	JB1440M

Jetbest Chip	Cost	Item #
Mimaki ES3 Chip	\$11.00	JBIMC
Roland Max 1 Chip	\$11.00	JBIRC
Roland Max 2 Chip	\$11.00	JBIR2C

Refillable Cartridge 440mL	Cost	Item #
	\$39.99	JBIRC3

Refillable Ink	Cost	Item #
500 mL BOTTLE	\$49.50	JB1500

- Available Colors:**
- **CYAN**
 - **MAGENTA**
 - **BLACK**
 - **YELLOW**
 - **LIGHT CYAN**
 - **LIGHT MAGENTA**



Revised 6-2025

ROLAND CLEANING KIT

Kit includes:
50 Swabs
14oz. solution























Revised 6-2025

\$75.00 ea. Item #CLEANKIT

50- Swabs only | **\$22.99** | CLSWABS
1- 4oz. solution only | **\$55.99** | CL4OZ



1/2 Pint Item# Price

	Dark Blue	158LP	\$35.99
	Dark Brown	115LP	\$35.99
	Dark Green	148LP	\$35.99
	Ivory	116LP	\$35.99
	Lettering Black	199LP	\$35.99
	Lettering White	101LP	\$35.99
	Medium Grey	195LP	\$35.99
	Medium Green	144LP	\$35.99
	Brilliant Blue	156LP	\$35.99
	Chrome Yellow	134LP	\$35.99
	Lemon Yellow	132LP	\$35.99
	Orange	124LP	\$35.99
	Bright red	104LP	\$35.99
	Process Blue	153LP	\$35.99
	Reflex Blue	155LP	\$35.99
	Purple	162LP	\$35.99
	Dark Magenta	164LP	\$35.99
	Polar White	103LP	\$35.99
	Metallic Silver	193LP	\$46.99
	Metallic Gold	109LP	\$46.99

Accessories	Cost	Item #	Quart Cost	Item #
• Sign restoring clear			\$26.99	4003Q
•••Vinyl Primer (Enamel-Receptive Coating)			\$46.99	5004Q
•• Speed dry UV clear acrylic spray	\$20.99	4005A	\$61.50	4005Q

NONE OF 1 SHOT ITEMS CAN BE SHIPPED BY AIR [NO EXCEPTIONS]
 • CANNOT BE SHIPPED. WILL CALL | SIGN MART DELIVERY SERVICE ONLY
 •• CAN SHIP UPS GROUND SPECIALLY LABELED: CONSUMER COMMODITY
 ••• CAN SHIP UPS GROUND ONLY

RONAN

SPECIALTY PAINTS

Water Based | Lead Free | **AQUACOTE** | Bulletin Enamel

For use on: Vinyl | Wood | Metal | Aluminum | Galvanized Metal | Masonry and Synthetics

	Description	Cost	PINT/ Item #
	Black	\$16.99	WB021P
★	White	\$17.99	WB101P
	Bright Red	\$22.99	WB104P
	Medium Brown	\$16.99	WB114P
	Ivory	\$16.99	WB116P
	Lemon Yellow	\$22.99	WB132P
	Dark Green	\$22.99	WB148P
	Process Blue	\$22.99	WB154P
	Reflex Blue	\$22.99	WB155P
	Brilliant Blue	\$22.99	WB156P
	Purple	\$29.99	WB162P
	Magenta	\$29.99	WB166P

Revised 9-25-25

ALL RONAN PAINT IS SHIPPED GROUND or LOCAL DELIVERY ONLY

Actual color may vary from examples due to variances in the printing process

★ White WB101P is recommended for EXTERIOR use only [has a PURPLE TINT]

Stainless Steel

#2 self piercing



Fits the  **STIMPSON**

Item #SPWG2SS
\$139.99 | 500 per bag

Revised 9-2025

Extra Longneck

Self piercing Brass grommets

- #2 extra longneck
- No crush installation
- Great for 1/2" thick substrates

STIMPSON AND FASNAP MACHINES ONLY

Great when your customer's substrate is 1/2" thick and demands a clean look. The **extra long neck** grommets are 1/8" longer than normal long neck grommets.

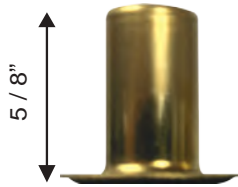

Extra Long Neck #2

\$43.99 | Item # XLNH
 Includes 100 qty.

\$107.00 | Item # XLN
 Includes 500 qty.

Revised 9-2025

Regular Long Neck #2 (on page 140)

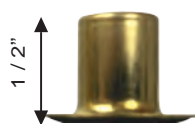

\$84.99 | Item # SPLN2 Brass
 Item # SPLN2 Nickel
 Includes 500 qty.

Grommet Kit

- Washers
- Insert Base
- Insert die
- Wood block
- Hole cutter
- 24 brass grommets



Grommet kit	Cost	Item #
#0	\$22.99	GK0
#1	\$21.99	GK1
#2	\$22.99	GK2
#3	\$23.99	GK3
#4	\$25.99	GK4

Revised 9-2025

Grommet Punch



Punch Die	Size	Cost	Item #
1/4"	#0	\$24.99	P14
5/16"	#1	\$24.99	P516
3/8"	#2	\$24.99	P38
7/16"	#3	\$24.99	P716
9/16"	#4	\$30.99	P916

Revised 9-2025

Setting Dies



Flat Washer	Cost	Item #
#0	\$40.99	DOFW
#1	\$43.99	D1FW
#2	\$44.99	D2FW
#3	\$51.99	D3FW
#4	\$56.99	D4FW

Revised 9-2025

RUBBER PAD

- 5" x 10"
- Helps while using punch die



\$19.99 | Item #RP510

Revised 9-2025

Grommets

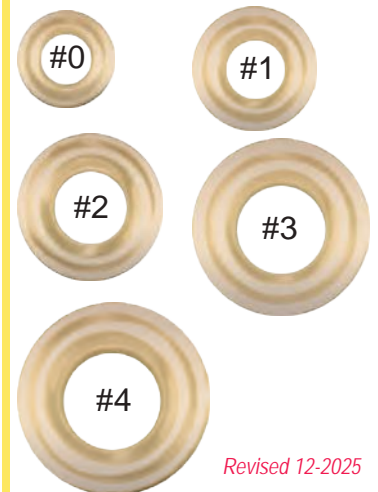

Revised 12-2025

NOT SELF PIERCING
CLOSE TO ACTUAL SIZE
144 GROMMETS PER BAG

flat washer	Cost	Item #
#0	\$ 8.50	GWFW0
#1	\$13.25	GWFW1
#2	\$17.50	GWFW2
#3	\$28.99	GWFW3
#4	\$39.50	GWFW4

"GOLD"

self piercing grommet machine

\$139.99 Includes #2 Die
Item #GGM

12" long handle
10 1/2" Long base

Grommets for
use in "GOLD" machine



# Die size	Color	Cost	Item #
#0	Brass	\$44.99	GGB0
#1	Brass	\$45.99	GGB1
#2	Brass	\$50.00	GGB2
#3	Brass	\$77.00	GGB3
#0	Silver	\$45.99	GGCO
#1	Silver	\$47.99	GGC1
#2	Silver	\$51.00	GGC2
#2	Black	\$51.00	GGBL2
#3	Silver	\$81.99	GGC3

Revised 9-25

**ALL DIES
\$74.99 each**

# Die size	Item #
#0	GGMDO
#1	GGMD1
#2	GGMD2
#3	GGMD3

Can also use Simpson grommets



Self Piercing
Grommet Machine



\$278.99

Includes #2 Die
Item #H-901B

Revised 9-25

# Die	Item #
#0	HSPD-0
#1	HSPD-1
#2	HSPD-2
#3	HSPD-3
#4	HSPD-4
#5	HSPD-5

ALL DIES \$151.50 EACH

Model H-901B

Grommets for use in Hiker machine

# Die	Brass	Cost	Nickel	Cost	Black	Cost
#0	HSPBO	\$ 54.50	HSPNO	\$55.50	HSPBKO	\$55.50
#1	HSPB1	\$ 60.50	HSPN1	\$60.00	HSPBK1	\$61.00
#2	HSPB2	\$ 68.75	HSPN2	\$69.99	HSPBK2	\$70.99
#3	HSPB3	\$ 87.99	HSPN3	\$88.99	HSPBK3	\$89.99
#4	HSPB4	\$101.75	HSPN4	\$105.00	HSPBK4	\$104.50
#5	HSPB5	\$114.99	HSPN5	\$115.99	HSPBK5	\$116.99
#2	HLNB2 Longneck	\$103.95	HLNN2 Longneck	\$102.95		

*



Model 405

Self Piercing Cast Aluminum
Grommet Machine

\$289.50 Includes #2 Die
Item #4055P



# Die size	Item #
#0	SPD-0
#1	SPD-1
#2	SPD-2
#3	SPD-3

ALL STIMPSON
DIES \$151.99 each

Revised 11-10-22

Stimpson Self Piercing Grommets*

#	Color	Cost	Item #
#0	Brass	\$ 39.99	SPBO
#1	Brass	\$ 47.99	SPB1
#2	Brass	\$ 57.99	SPB2
#3	Brass	\$ 104.50	SPB3
#4	Brass	\$145.00 <i>(100 pcs. per bag)</i>	SPB4
#2	Nickel	\$ 60.99	SPN2
#2	Black	\$ 74.99	SPBK2
#2	Brass Longneck	\$ 84.99	SPLN2
#2	Nickel Longneck	\$ 84.99	SPLNS2
#2	Stainless Steel	\$146.99	SPWG2SS

#2 Brass
XL Longneck
on page 110

Also works with Fastnap & Gold Grommet machines

* Box of 500 pieces (unless otherwise specified)

Countertop Sign Holder

Holds Corrugated Plastic Signs

AVAILABLE IN BLACK OR WHITE

Size	Cost each	Item #
2.38" Wide x 3" Deep displays 12" x 12"	40¢	WCT3
4" Wide x 5" Deep displays 18" x 24"	50¢	WCT5

Revised 9-25

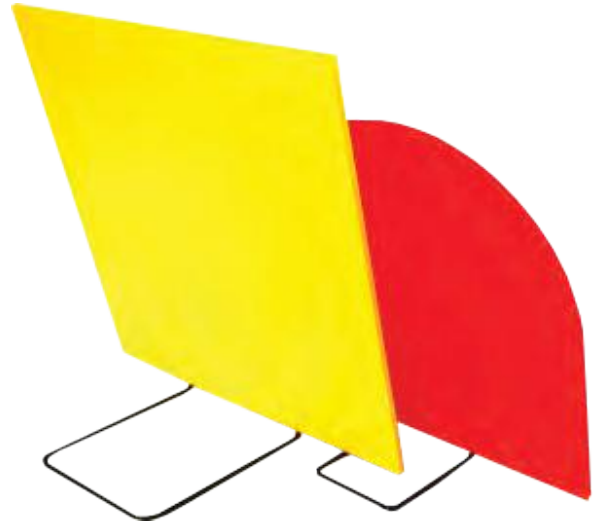

Decorative Scroll Bracket

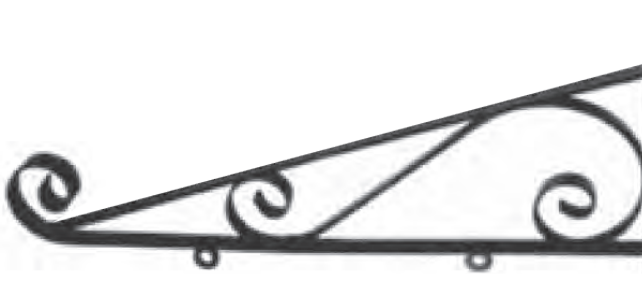

Sign Bracket

Size	Cost	Item #
18"	\$12.99	DSB18
24"	\$17.99	DSB24
30"	\$21.99	DSB30
36"	\$25.99	DSB36
42"	\$30.99	DSB42
48"	\$31.99	DSB48

Revised 9-25

BRAILLE BALLS

Same as Raster Brand Braille Balls

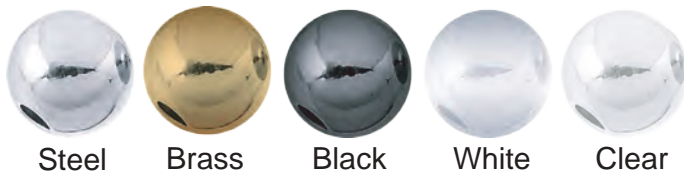

Steel

Brass

Black

White

Clear

Metal	Cost per Jar (1,000 pcs.)	Item #
Stainless Steel	\$57.99	SBST
Brass	\$57.99	SBBR

Acrylic	Cost per Jar (11,000 pcs.)	Item #
Clear	\$167.00	SBCL
Black	\$184.00	SBBK
White	\$184.00	SBWT

Revised 9-25

Bibapron 12 Pocket Canvas Bib Apron

- One size fits all
- Machine washable
- Heavy-duty cotton canvas
- 2 Polypropylene hammer loops
- Double rows, 10 waist pockets
- 2 Chest pockets for pencils, pens and small tools



Revised 9-25

\$17.99 ea. | Item #12PCBA

Plate Holder

Includes

- Nut
- 3" bolt
- .080" gauge
- Metal washer
- Plastic washer
- Aluminum plate 3" x 3"



Revised 9-25

\$4.99 ea. | Item #PHU3

"U" Channel Post

Size	Cost	Item #
6'	\$26.99	UCP6
8'	\$35.99	UCP8
10'	\$44.99	UCP10
12'	\$53.99	UCP12

Revised 9-25

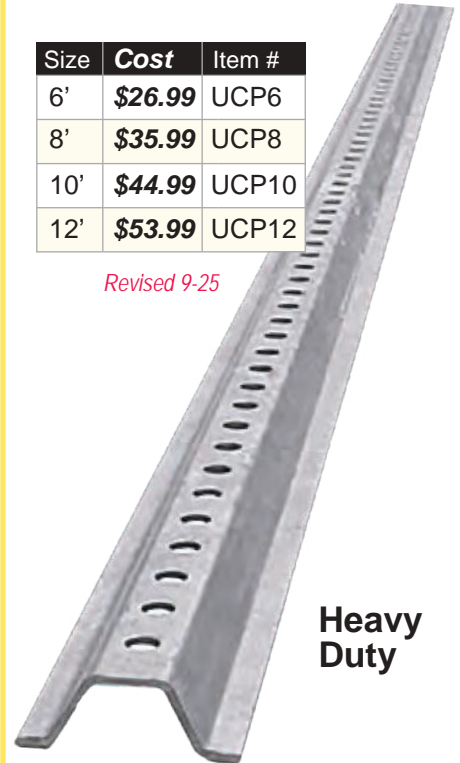

Heavy Duty

SURFACE MOUNT SIGN POST BRACKET

- 6" x 6" x 6.25" Tall
- Work with 2" square post



Revised 9-25

\$63.50 ea. | Item #SFMB

SQUARE STEEL SIGN POST

- 12 Gauge steel
- 2" x 2" x 10' long
- Coated for rust resistance
- 7/16" holes punched on all sides

12 Gauge Steel Post



Revised 9-25

\$76.99 ea. | Item #CSP22

TALL SQUARE SLEEVE

- 12 Gauge steel
- 2" x 2" x 30" long
- Coated for rust resistance
- Use with square steel post



Heavy Duty Sleeve

Revised 9-25

\$59.99 ea. | Item #CSP30

LinKlip Mounting System

- U channel post
- Chain link fence
- Square sign post

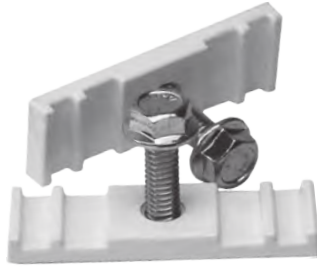

Revised 9-25

\$4.50 ea. | Item #LINK1
2 for \$6.88 | 4 for \$13.00

Twist-on Hanging System

Tabs will overlap T-Bar flange and lock securely in place. Slide-On Kits simply wedge between edge of T-Bar and ceiling panel to lock in place.



Revised 9-25

\$1.99 | Item #TW04 [4 pk]
\$9.99 | Item #TW25 [25 pk]

Twist N' Hook Hanging hardware for foam board

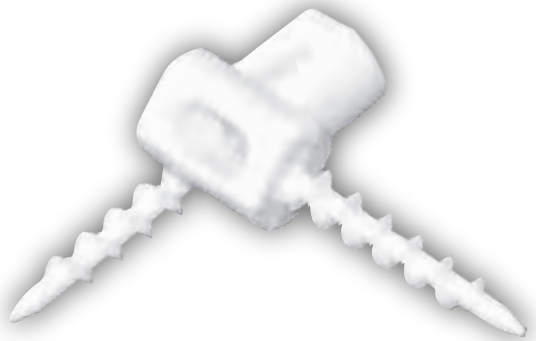

Revised 9-25

\$ 5.99 ea. | Item #TH12 [12 pack]
\$42.99 ea. | Item #TH100 [100 pack]

Pick N' Hook Hanging hardware for coroplast



Revised 9-25

\$ 5.99 ea. | Item #PH12 [12 pack]
\$42.99 ea. | Item #PH100 [100 pack]

SUCTION CUPS

Large hook 50 per bag
Small and medium 100 per bag

Size	Cost	Item #	Bag Cost	Item #
Small	79¢	SCSE	\$36.99	SCS1
Med.	91¢	SCME	\$43.50	SCM1
Large	\$1.14	SCLE	\$46.99	SCL5



Revised 9-25

Rope

Polypropylene Rope

Durable, rugged polypropylene rope that floats and is color safe, allows for minimal stretch.

1200 feet long



Revised 9-25

1/4" **\$64.99 ea.** | Item #RBLK

3/8" **\$98.99 ea.** | Item #RBLK3

Omega Notcher

For notching plastic edge cap at 45° angle

Portable Edge Cap Notcher



Revised 9-25

\$205.99 ea. | Item #NOTCHER

Rope Clamps

Create Loop Out of Rope

Use with 1/4" and 3/8" rope. This simple device creates a loop out of rope for your banner.



Revised 9-25

\$2.99 [2 per pack] | Item #RCL1

Work Gloves



Top Grain Leather

Revised 9-25

medium | **\$16.99 ea.** | Item #WLGGM

large | **\$16.99 ea.** | Item #WLGL

X-large | **\$16.99 ea.** | Item #WLGXL

Omega Edge Cap

Edge Cap for Substrates

- White
- Black
- Red
- Blue
- Green

- Adds a finished look
- Come in 96" lengths
- U channel 1/2" or 1/4"
- Several colors to choose from
- Protects edges from weathering

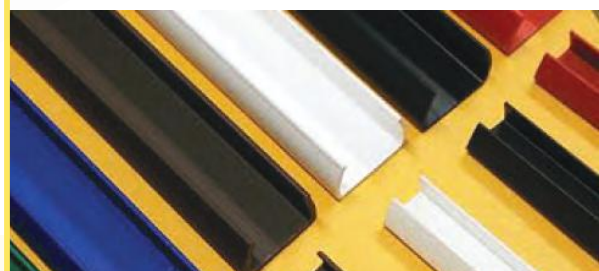

Revised 9-25

\$6.99 ea. 1/4" | **\$7.99 ea. 1/2"**

Steel Bracket

Hanging Signs



Revised 9-25

1/2" \$1.99 ea. | Item #SB12
12+ \$1.85 ea.

3/4" \$1.99 ea. | Item #SB34
12+ \$1.85 ea.

Coated HEX bolt with lock nut



Item #HEX
1/4" x 1 1/2" | 69¢ ea.
Fits both 1/2" and 3/4" sign hangers

SIGN CLAMPS

Modern Sign Clamps

- Easy Installation
- Satin or polished chrome finish



Revised 9-25

Size	Cost	Item #
3 1/8"	\$10.99	XC15 - 80 +
4 3/4"	\$12.99	XC15-120 +
7 3/32"	\$16.99	XC15-180 +
11"	\$20.99	XC15-280 +
15"	\$27.99	XC15-380 +

+ ST = Satin
+ CP = Polished Chrome

U BRACKET

1/4" | 1/2" | 3/4"



Revised 9-25

1/4" \$3.10 ea. | Item #UB14
12+ \$2.75 ea

1/2" \$3.10 ea. | Item #UB12
12+ \$2.75 ea

3/4" \$3.10 ea. | Item #UB34
12+ \$2.75 ea

Sign Mounting Sign Mounting Bracket

Used for banding to large poles. Extra Heavy 1/8" steel, hot dipped galvanized. With 5/16" tapped hole. Slotted for 3/4" strap.



• FLARED LEG

\$3.99 ea. | Item #SMBS
12+ \$3.67 each Revised 9-25

BRACKET L-MOUNT



\$2.55 ea. | Item #LMSS
12+ 2.40 each Revised 9-25

ALUMINUM L-MOUNT

Right Angle Pole Mount

For mounting a sign to a right angle pole. One side of the mounting plate is angled to provide extra strong support



\$2.53 ea. | Item #SLB1
12+ 2.29 each Revised 9-25

CENTER BRACKET



1/4" \$3.30 ea. | Item #CB14
12+ \$2.89 ea

1/2" \$3.30 ea. | Item #CB12
12+ \$2.89 ea

3/4" \$3.30 ea. | Item #CB34
12+ \$2.89 ea Revised 9-25

SIGN MOUNTING BRACKET

Galvanized Steel



• FLARED LEG

\$2.99 ea. | Item #SMBG
12+ \$2.58 each Revised 9-25

SnapRing



Revised 9-25

2 Sizes: 1 1/2" and 2"

1 1/2" | **\$1.15 ea.** | Item #SR12
 2" | **\$2.15 ea.** | Item #SR02

Desk Sign Holder

Accommodates 1/16" material



Revised 9-25

Size	Cost	Item #
2" x 8"	\$9.99	DH28
2" x 10"	\$10.50	DH20
2" x 12"	\$12.50	DH22

Available in

Yellow Gold Rose Gold
 Silvertone Matte Black

Snap Lock

- Versatile clamp
- 2" minimum diameter
- Open up to 12.5" diameter
- Screw and housing all steel
- Swivel action locking of screw



Revised 9-25

40" Stainless Steel Strap

\$5.99 ea. | Item #SS40
 12+ \$5.50 ea.

Ceiling Grid Clips

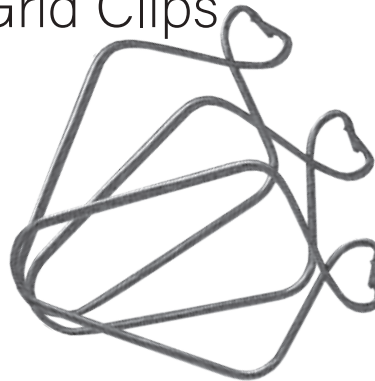

35¢ ea. | Item #CGCS *Revised 9-25*

\$28.99 | Item #CGCS1
 [100 total]

Wall Sign Holder

Accommodates 1/16" material



Size	Cost	Item #
2" x 8"	\$6.99	WH28
2" x 10"	\$7.99	WH20
2" x 12"	\$8.99	WH22

Available in

Yellow Gold Rose Gold
 Silvertone Matte Black

Revised 9-25

Tool Holder

- No puncture bottom
- Snap on clip and belt loop for easy attachment



\$17.99 ea. | Item #SSTH
Revised 9-25

Wall Clip

Mounting System



Press clip into foam core then hang the sign.

Revised 9-25

\$9.99 | Item #WC10
 [100 pk]

\$68.99 | Item #WC12
 [1000 pk]

Corridor Brackets



- Accommodates 1/8" material
- Available in 2", 3", 4" and 5"

Size	Cost	Item #
2"	\$10.99	CB2
3"	\$11.99	CB3
4"	\$12.99	CB4
5"	\$13.99	CB5

Available in

Yellow Gold Rose Gold
 Silvertone Matte Black

Revised 9-25

Clear Acrylic Holders

Injection Molded Business Card Holders and Brochure Holders
CUSTOM ACRYLIC FABRICATION AVAILABLE

Revised 9-25

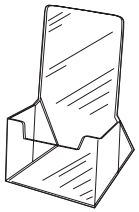

Small countertop
Item #CAC4

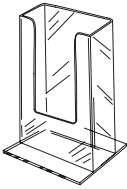

Brochure countertop
Item #CAB8



Wall mount
Item #WM04



Item# BCW3

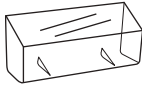

Item# BCC4

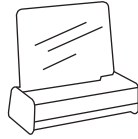

Item# BCC3

Description	Fits Brochure	Cost 1 - 49	Cost 50 - 99	Cost 100+	Item #
Small countertop	4" wide	\$4.50	\$3.99	\$3.50	CAC4
Medium countertop	5.5" wide	\$5.99	\$5.25	\$4.25	CAC5
Large countertop	8.5" wide	\$8.99	\$8.25	\$7.99	CAC8
Small wall mount	4" wide	\$4.50	\$4.25	\$3.75	WM04
Medium wall mount	6.5" wide	\$5.99	\$5.25	\$4.51	WM05
Large wall mount	8.5" wide	\$8.99	\$8.25	\$7.75	WM08
Business card countertop	3.5" wide	\$1.99	\$1.55	\$1.25	BCC3
Business card countertop	3.5" wide	\$2.25	\$1.85	\$1.75	BCC4
Business card wall mount	3.5" wide	\$2.25	\$1.85	\$1.75	BCW3
Brochure countertop	4" wide	\$8.99	\$8.15	\$7.75	CAB8

Sign-Mart Plastics Plus also develops and fabricates custom displays, fixtures more

Clear Acrylic Displays

Great for Advertising | POP | Photos | Signs
CUSTOM ACRYLIC FABRICATION AVAILABLE

Revised 9-25



Slant back
Item #S811

available
landscape or portrait

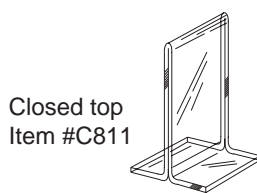

Closed top
Item #C811



Open top
Item #O811

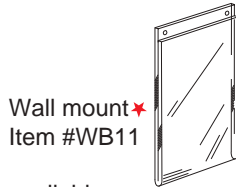

Wall mount*
Item #WB11

available
landscape or portrait

Size	Cost 1- 49	Cost 50 - 99	Cost 100+	Item #
Slant back 8.5" x 11"	\$7.50	\$6.50	\$5.99	S811
Closed top 8.5" x 11"	\$8.99	\$8.25	\$7.50	C811
Wall mount 8.5" x 11"	\$7.25	\$6.50	\$5.99	WB11
Open top 8.5" x 11"	\$10.50	\$9.50	\$8.50	O811

* Also available with flush top edge no lip

PVC Display Blanks

- 8.5" x 11"
- Product display
- Counter top signs
- Custom sizes available

Available in:

White | Black | Red | Yellow | Green | Blue |



\$4.50 ea. | Item #SB81 | 50 - 99 \$3.99 ea. | 100+ \$3.50 ea.



Sign Mart's *Great for* Wall and Counter Top Displays

Solid Brushed Aluminum Stand-Offs

Revised 9-25



All brushed aluminum stand-offs require a wall screw and anchor which are sold separately.

Long Studs Available for 5/8\" and 7/8\" stand offs
Cost 50¢ each
 1\" long Item #5161801
 3/4\" long Item #5161834



All *Stand-Offs* Include Stainless Steel Post & Cap Screws

Wall anchors / screw sets for stand-Offs for 3/8\" diameter



\$2.25 set | Item #WASS3
 for 5/8\" and 7/8\" diameter

Revised 9-25

\$1.25 set | Item #WASS1
 for wall anchors / screw sets for stand-offs 3/8\" diameter



Price includes post and cap

Size 3/8"	Cost	Item #
1"	\$3.85	SA138
2"	\$4.77	SA238
CAP ONLY	\$2.70	38CAP

Size 5/8"	Cost	Item #
3/4"	\$3.75	SA7558
1"	\$3.85	SA158
2"	\$5.45	SA258
3"	\$5.64	SA358
CAP ONLY	\$3.34	58CAP

Size 7/8"	Cost	Item #
1"	\$5.50	SA178
2"	\$5.99	SA278
CAP ONLY	\$3.85	78CAP

Approx Cap Height 1/4"

Panelclip

Extruded Aluminum Channel System

- Great for mounting logos
- Available in 4' lengths no holes
- Ideal for panel mounting to walls
- 2.5" lengths with holes sold in pairs

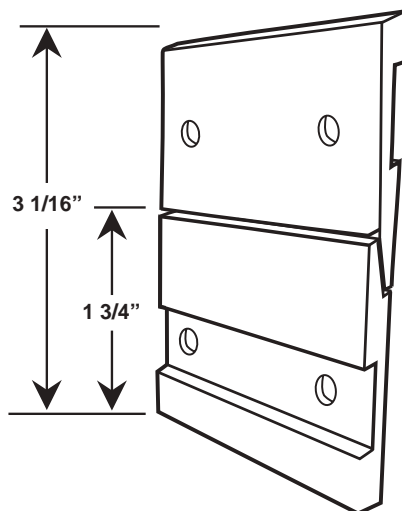

Revised 9-25

Item #PC02 [2.5\" lengths with holes]
 1 - 25 **\$3.50** per pair | 26 - 99 **\$3.10** per pair

Item #PC04 [4' lengths no holes]
\$28.99 per pair

Kingclip

Extruded Heavy Duty Channel System

- 4' lengths
- Heavy Duty
- Uncut has no holes
- Fits 3/8\" diameter bolt head

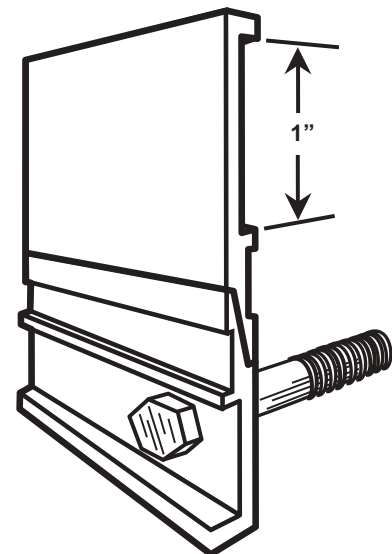

Revised 9-25

\$44.50 per pair | Item #KC04
 12 + **\$40.99** per pair

Stand - Offs



BLACK (BK)



BLUE (BL)



GLOSSY (GL)



POLISHED CHROME (CP)



RED (RD)



SATIN (ST)



POLISHED GOLD (BG)



SATIN GOLD (SG)

Conversion Chart	
13mm	= .51"
19mm	= .75"
25mm	= 1"

All Stand-Off Revised 9-25

CA 1313



Size	Cost	Color	Item #
13mm x 13mm	\$3.05	Satin	CA-1313-ST
13mm x 13mm	\$3.05	Black	CA-1313-BK
13mm x 13mm	\$3.05	Chrome Polished	CA-1313-CP
13mm x 13mm	\$3.05	Glossy	CA-1313-GL

CA 1319



Size	Cost	Color	Item #
13mm x 19mm	\$3.35	Satin	CA-1319-ST
13mm x 19mm	\$3.35	Red	CA-1319-RD
13mm x 19mm	\$3.35	Blue	CA-1319-BL
13mm x 19mm	\$3.35	Black	CA-1319-BK
13mm x 19mm	\$3.35	Chrome Polished	CA-1319-CP
13mm x 19mm	\$3.35	Glossy	CA-1319-GL

CA 1919



Size	Cost	Color	Item #
19mm x 19mm	\$4.50	Satin	CA-1919-ST
19mm x 19mm	\$4.50	Red	CA-1919-RD
19mm x 19mm	\$4.50	Blue	CA-1919-BL
19mm x 19mm	\$4.50	Black	CA-1919-BK
19mm x 19mm	\$4.50	Chrome Polished	CA-1919-CP
19mm x 19mm	\$4.50	Glossy	CA-1919-GL

CA / CN 1925



Size	Cost	Color	Item #
19mm x 25mm	\$5.35	Satin	CA-1925-ST
19mm x 25mm	\$5.35	Red	CA-1925-RD
19mm x 25mm	\$5.35	Blue	CA-1925-BL
19mm x 25mm	\$5.35	Black	CA-1925-BK
19mm x 25mm	\$5.35	Chrome Polished	CA-1925-CP
19mm x 25mm	\$5.35	Glossy	CA-1925-GL
19mm x 25mm	\$8.80	Polished Gold	CN-1925-BG
19mm x 25mm	\$8.80	Satin Gold	CN-1925-SG

CA 2519



Size	Cost	Color	Item #
25mm x 19mm	\$5.35	Satin	CA-2519-ST
25mm x 19mm	\$5.35	Red	CA-2519-RD
25mm x 19mm	\$5.35	Blue	CA-2519-BL
25mm x 19mm	\$5.35	Black	CA-2519-BK
25mm x 19mm	\$5.35	Chrome Polished	CA-2519-CP
25mm x 19mm	\$5.35	Glossy	CA-2519-GL

CA 2525



Size	Cost	Color	Item #
25mm x 25mm	\$5.92	Satin	CA-2525-ST
25mm x 25mm	\$5.92	Red	CA-2525-RD
25mm x 25mm	\$5.92	Blue	CA-2525-BL
25mm x 25mm	\$5.92	Black	CA-2525-BK
25mm x 25mm	\$5.92	Chrome Polished	CA-2525-CP
25mm x 25mm	\$5.92	Glossy	CA-2525-GL

Finishing Styles

Street Banners-Style 08

Street or Boulevard banners have pole pockets top and bottom. **An optional two grommets are available to secure the banner to the aluminum bracket with nylon straps or wire. (straps not included)** Due to weather exposure, 16oz. or stronger banner material is highly recommended. Hemming the vertical side is optional but recommended when artwork allows.

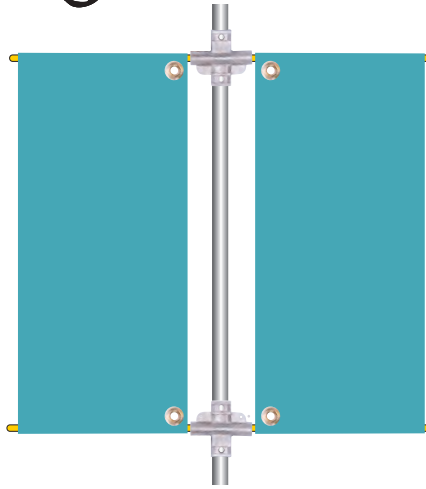

Sew extra 3/4" wide nylon webbing inside sleeve

Important

To secure the banner to the pole, use zip ties (not included) through grommet holes then the gap between the pole and stainless steel band. Failure to secure banner may result in loss or damage. Do not allow banners to come into contact with high wires. It is important that brackets are mounted properly and are tight to insure the life of the banner. Check banners within 4 weeks of installation or first strong wind for needed adjustments.

Reinforcing the sleeves with 3/4" nylon webbing is an option (\$0.60 approximate cost per corner) and adds extra strength.

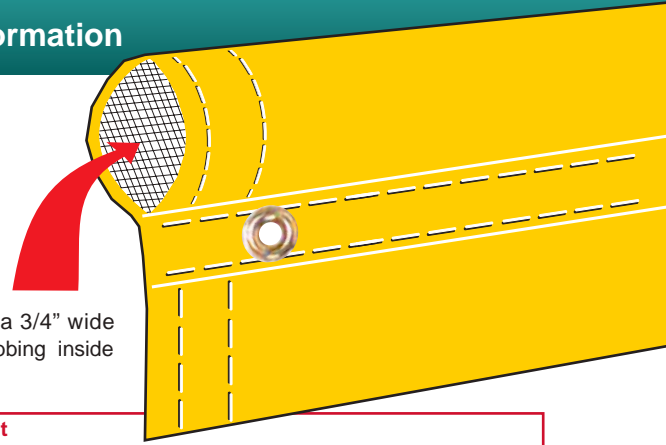

Snap Hooks-Style 09

The only professional method for hanging banners "Over the Street" or between any two unattached structures (poles, buildings, etc.). A steel wire cable must be installed between the structures and tightly secured.

Some city regulations require a cable for the top as well as the bottom of the banner. The metal Snap-Hooks "SNAP" over the cable and suspend the banner in the air. Usually 1/4" poly rope is tied to each of the top corners and extends to the side. This prevents the Banner from shifting left or right (see diagram below).

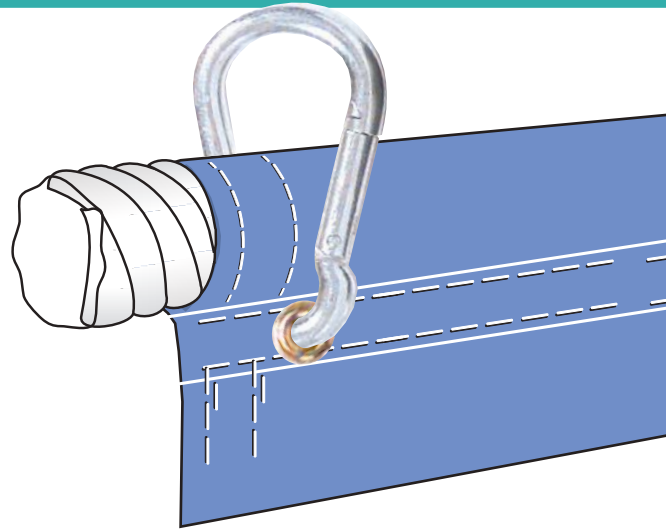

2 Methods for Attaching Snap-Hooks to Banners

1 Snap-Hooks attached through #2 or #3 grommets placed in the top hem of banner. 1/4" poly rope should be sewn into the top hem and the grommets are placed below the rope (see photo). This prevents the grommets from possibly ripping out.

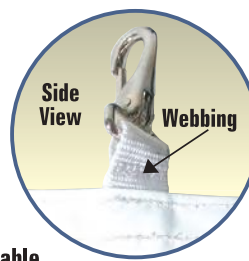

2 Snap-Hooks sewn directly to the banner with Heavy-Duty webbing straps (see photo). With the method, webbing should also be sewn into the hem for extra added reinforcement.possibly ripping out.

Both variations can be repeated for the bottom of the banner, if required. If the bottom is not secured with a wire guide, we recommend sewing 1/4" poly rope through the bottom hem with extra rope to reach the supporting side structure (see diagram). Reinforcing both bottom corners is recommended.

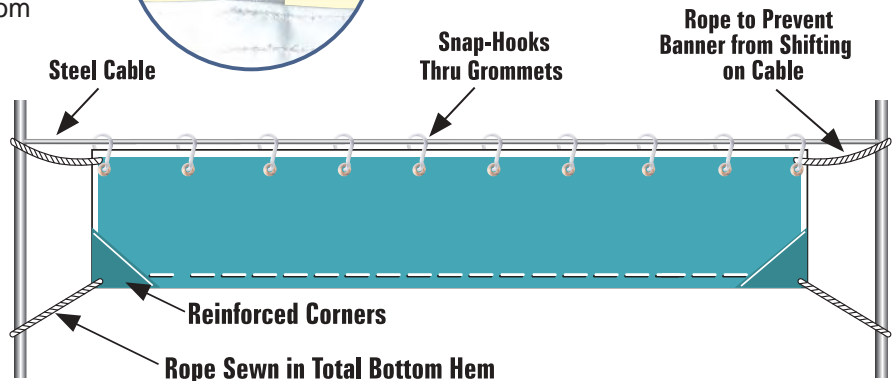

■ **Snap-Hook Banner should be made out of 16oz. Outdoor Material or Stronger**

■ **Snap-Hooks should be located every 18" to 24" MAXIMUM**

Quality **BANNERS**

ALL PRICES PER LINEAR FOOT

All Sign-Mart blank banners are sewn with **Double Lock Stitch** sewing machines.
 Superior Durability | No Unraveling | Stay Flat Hems | Improved Appearance | No Thread Bunching

All banners are fully hemmed (Standard hem 1")

Grommets every 2 1/2' approx. top and bottom (#1 & #2 grommets)

#3 & #4 grommets available at \$.40 each

Min. charge based on 5 running feet

Sewn in 1/4" rope or 1" webbing-add \$.30 per linear ft. 3/8" rope \$.35 per linear ft.

Sewn in "D" rings add \$2.50 for each ring

Sewn in clips add \$2.50 for each clip

Pole pockets add \$.20 for each running foot

Clear pockets add \$1.00 per sq./ft. plus labor
Please call for a quote

Reinforced corners \$2.50 ea. corner

Quantity Discounts Must be same size and material.

Extra material from a banner order-hemmed only at \$.75 per linear ft. & with hem and grommets \$.75 per linear ft.

Be sure to **PRETEST** all materials for adhesion of graphics (Paint, Ink, or Vinyl before proceeding

13oz. Vinyl WHITE ONLY

22oz. Matte Vinyl WHITE ONLY

Size	Cost
3'	\$3.29 linear ft.
4'	\$4.39 linear ft.
6'	\$7.69 linear ft.
10'	\$12.10 linear ft.

Revised 9-25

Size	Cost 1 - 5 Units	6+ units
3' Gloss or Matte	\$2.87 linear ft.	\$2.64
6' Gloss or Matte	\$4.18 linear ft.	\$3.94
10' Matte Only	\$7.70 linear ft.	Matte White
16' Matte Only	\$11.00 linear ft.	Matte White

Revised 9-25

Gloss and Matte [1000 x 1000 denier]
9 x 9 thread

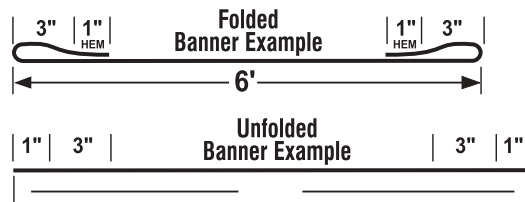

Heavy Duty Vinyl

Double Face | Block Out | PVC Coated
[1000 x 1000 denier]

Please Read

When determining banner prices: All linear measurements will be rounded up to the nearest foot. [A 3' x 6' 8" banner will be priced at 3' x 7'] When the banner includes **Sleeves**, the price is based upon the total length of the unfolded banner material. That measurement **Will be** rounded up to the nearest foot. All screen printed banner orders are sewn with chain stitch sewing machines.



3' High x 5' Wide 13oz. Red on white



NL35SPR



NR35SPR



UNM35R



GO35R



O35R



NL35R



S35R



NH35R



NO35R



UNO35R



NR35R



OS35R

Revised 9-25

Cost - Qty. 1 - 11

Qty. 12+

13 oz. White | \$20.25 ea. | \$18.75 ea.

3' High x 10' Wide 13oz. Red on white



NH310R



NR310SPR



O310R



OS310 R



NL310R



GO310R



UNO310R



NO310R



NL310SPR



NR310R



S310R



UNM310R

Revised 9-25

Cost - Qty. 1 - 11

Qty. 12+

13 oz. White | \$40.50 ea. | \$37.50 ea.

3' High x 10' Wide *Revised 9-25*
13oz. Multi color | \$40.50 each



OH310



GBSR310



NO310



GR310



CSL310



GO3310

3' High x 20' Wide
13oz. Red on white
1 COLOR \$81.00 each *Revised 9-25*



Item #NR320R



Item #NL320R



Item #GO320R

EACH PRE-PRINTED BANNER COMES HEMMED AND GROMMETED.
ALL BANNERS ARE INDIVIDUALLY BOXED AND LABELED FOR EASY STORAGE
ALL PRE-PRINTED BANNERS CAN BE COMBINED FOR QUALITY DISCOUNTS

Preprinted Flying Flags

OVER 200 PRE PRINTED BANNERS AND FLAGS AVAILABLE...PLEASE VISIT SIGN-MART.COM



NSFB-5326



NSFB-5159R



NSFB-5496



NSFB-5061F



NSFB-5022C



NSFB-5001A



NSFB-5061D



NSFB-5018A



NSFB-5002



NSFB-5013



NSFB-5129



NSFB-5207



NSFB-5483



NSFB-5511



NSFB-5011A



NSFB-5168

Size	Cost	Item #
30"W x 138" H Flag	\$23.99	NSFB (#)
15' Metal pole	\$36.00	Newpole
Roll on tire base	\$18.00	RTB
Outdoor ground spike	\$18.00	OGS
Outdoor fence spike	\$12.00	OFB

Revised 9-25



Item #Newpole



Item #RTB



Item #OGS



Item #OFB

MEDIUM 9" X 12" PENNANTS

Each pennant is 9" x 12" in your choice of two lengths and a rainbow of color combinations

Style	Color Pattern
A	Red, White, Blue, Green, Yellow, Orange
B	Red, White, Blue, Green, Yellow, Orange
C	Red, White, Blue, Green, Yellow, Orange
D	Red, White, Blue, Green, Yellow, Orange
E	Red, White, Blue, Green, Yellow, Orange
F	Red, White, Blue, Green, Yellow, Orange
G	Red, White, Blue, Green, Yellow, Orange

Red | White | Blue | Green | Yellow | Orange | Black

Size 50 feet	Cost	Item #	Size 100 feet	Cost	Item #
1 - 10	\$13.99	MC5	1 - 10	\$16.99	MC1
11 - 49	\$13.50	MC5	11 - 49	\$16.50	MC1
50 +	\$13.25	MC5	50 +	\$16.25	MC1



Please indicate style / color combinations codes
123

40 Flags per 50ft. string

Revised 9-25

80 Flags per 100ft. string

100% NYLON

- Office buildings
- Apartment flags
- Interior flags for malls
- Real Estate pennants
- Tract housing displays
- Grand opening displays

- Nylon flag prices include a sleeve on (1) one edge and Double-Stitched hems on all other edges.
- Flag headers are an additional cost of 50¢ per ft. and grommets are 15¢ each.
- Weather conditions and UV intensity directly affect the color and fiber of the Nylon longevity and are beyond our control
- Sleeves over 2" wide are surcharged 10% for every 1" increment if the approximate finish size is maintained
- If the finish size can be reduced to accommodate the sleeve size, then **NO Extra Charge** is necessary
- Nylon colors are subject to Mill color variation beyond our control

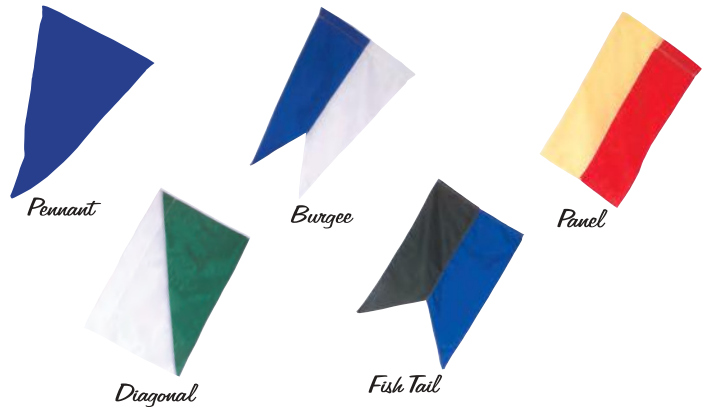

Nylon Pennants | Diagonals Burgees | Fish Tails

Approximate Finished Size	Qty	Solid Color	Two Panels
18" x 24" Pennant	1-11	\$17.99	\$20.99
	12-47	\$16.99	\$19.99
	48+	\$16.50	\$19.50
2' x 3' Pennant	1-11	\$19.99	\$20.99
	12-47	\$17.99	\$19.99
	48+	\$17.50	\$19.50
3' x 5' Pennant Even Qty Only	1-11	\$31.99	\$34.99
	12-47	\$30.50	\$33.50
	48+	\$29.99	\$32.99
2' x 6' Pennant Even Qty Only	1-11	\$37.50	\$40.50
	12-47	\$33.50	\$37.50
	48+	\$32.99	\$36.99
3' x 8' Pennant Even Qty Only	1-11	\$40.75	\$47.99
	12-47	\$36.99	\$41.99
	48+	\$34.99	\$39.99
4' x 6' Pennant Even Qty Only	1-11	\$41.99	\$43.99
	12-47	\$40.99	\$41.99
	48+	\$36.99	\$39.99
3' x 5' Diagonal Even Qty Only	1-11	2 PANEL \$41.99	3 PANEL \$55.99
	12-47	\$38.99	\$52.99
	48+	\$35.99	\$50.99
2' x 3' Burgee/Fish Tail Even Qty Only	1-11	\$28.99	\$35.99
	12-47	\$27.99	\$32.99
	48+	\$25.99	\$31.99
3' x 5' Burgee/Fish Tail Even Qty Only	1-11	\$41.99	\$44.99
	12-47	\$38.99	\$41.99
	48+	\$35.99	\$38.99

Nylon Flags

Approximate Finished Size	Qty	Solid Color	Two Panels	Three Panels	Four Panels	Five Panels
18" x 24"	1-11	\$20.99	\$23.99	QUOTE	QUOTE	QUOTE
	12-47	\$19.99	\$22.99	QUOTE	QUOTE	QUOTE
	48+	\$18.99	\$21.99	QUOTE	QUOTE	QUOTE
2' x 3'	1-11	\$20.99	\$23.99	QUOTE	QUOTE	QUOTE
	12-47	\$19.99	\$22.99	QUOTE	QUOTE	QUOTE
	48+	\$18.99	\$21.99	QUOTE	QUOTE	QUOTE
3' x 5'	1-11	\$31.99	\$34.99	\$37.99	\$39.99	QUOTE
	12-47	\$30.99	\$32.99	\$35.99	\$38.99	QUOTE
	48+	\$28.99	\$30.99	\$33.99	\$36.99	QUOTE
4' x 6'	1-11	\$42.99	\$44.99	\$46.99	\$53.99	QUOTE
	12-47	\$40.99	\$42.99	\$44.99	\$52.99	QUOTE
	48+	\$38.99	\$40.99	\$43.99	\$50.99	QUOTE
5' x 8'	1-11	\$59.99	\$62.99	\$65.99	\$68.99	QUOTE
	12-47	\$56.99	\$59.99	\$62.99	\$66.99	QUOTE
	48+	\$54.99	\$57.99	\$60.99	\$64.99	QUOTE
6' x 3'	1-11	\$35.99	\$37.99	\$46.99	\$42.99	QUOTE
	12-47	\$33.99	\$35.99	\$44.99	\$40.99	QUOTE
	48+	\$32.99	\$36.99	\$43.99	\$38.99	QUOTE
3' x 8'	1-11	\$44.99	\$47.99	\$49.99	\$52.99	QUOTE
	12-47	\$42.99	\$45.99	\$47.99	\$50.99	QUOTE
	48+	\$41.99	\$43.99	\$45.99	\$48.99	QUOTE
3' x 10'	1-11	\$52.99	\$50.99	\$57.99	\$60.99	QUOTE
	12-47	\$48.99	\$51.99	\$56.99	\$58.99	QUOTE
	48+	\$46.99	\$49.99	\$54.99	\$56.99	QUOTE
4' x 10'	1-11	\$55.99	\$57.99	\$60.99	\$64.99	QUOTE
	12-47	\$51.99	\$54.99	\$58.99	\$62.99	QUOTE
	48+	\$49.99	\$52.99	\$56.99	\$60.99	QUOTE

Above pricing is for square/rectangular panels only
anything else is a custom quote

Revised 09/22/25

Custom Sizes available upon request

ROLLED MATERIAL ONLY 54" FULL 130 YARD ROLL \$16.00 YARD | 54" CUT YARDAGE \$18.50 YARD

Table Throw

- 100% Polyester
- 6' and 8' lengths
- Machine washable
- Perfect for Trade Shows, Job Fairs, Conferences & more
- Special order colors are available just submit PMS color [2 order min]

Drapes Over Table:
2 Sizes Available
 6' = 30" D x 72" L x 29" H
 8' = 30" D x 96" L x 29" H

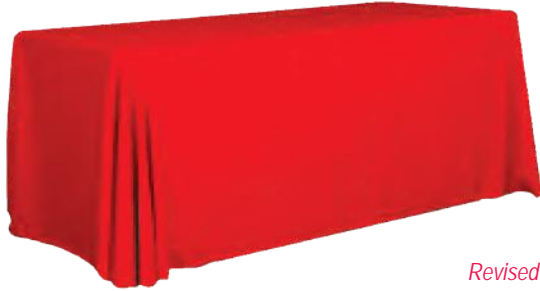

Revised 9-25

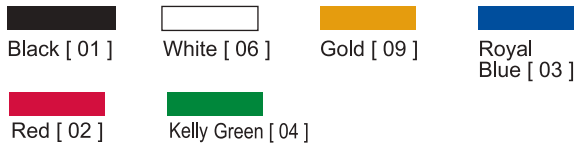

Size 6' | **\$52.99 each** | Item #TT1 + COLOR
 Size 8' | **\$63.50 each** | Item #TT2 + COLOR

Top Fitted Table Cover with pleats

- 100% Polyester
- 6' and 8' lengths
- Machine washable
- Perfect for Trade Shows, Job Fairs, Conferences and more
- Special order colors are available just submit PMS color [2 order min]

Fits Over Table:
2 Sizes Available
 6' = 30" D x 72" L x 29" H
 8' = 30" D x 96" L x 29" H



A fitted cover that is sewn to fit the edge of the table top, giving a boxy look.

Revised 9-25

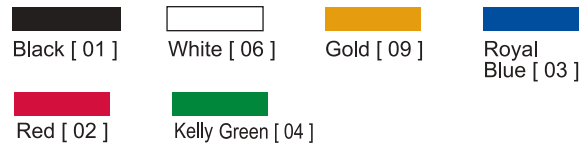

Size 6' | **\$72.50 each** | Item #TT3 + COLOR
 Size 8' | **\$80.50 each** | Item #TT4 + COLOR

Custom Carpets



Please call or email us for a quote

Website / Orders: sign-mart.com

Email orders: sales@sign-mart.com

Phone orders: 714-532-7100 800-533-9099

FeatherWind Banner

Designed to gain the immediate attention of those passing by. This durable banner can withstand the types of outdoor extremes that other forms of signage fall prey to.



TEARDROP wind banners

The Teardrop banner is ideal for events where wind is an issue. The teardrop is incredibly light and comes alive by rotating in the wind. No flapping noise and clearly displays your company's message or logo.

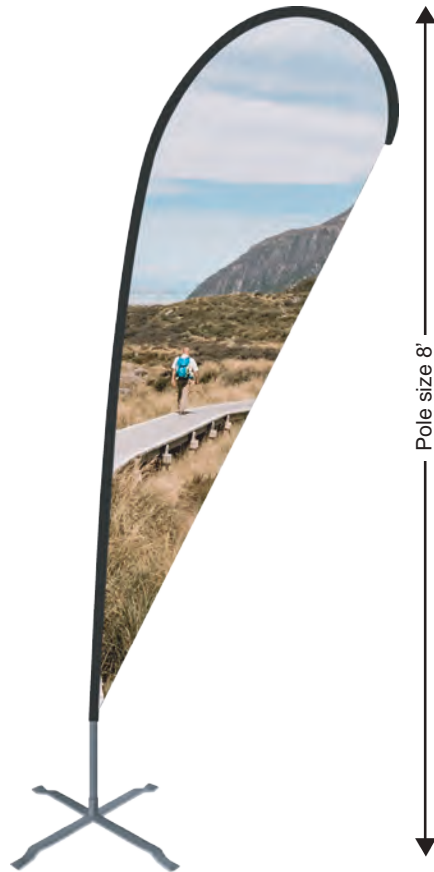

SAIL WIND BANNER

Designed to gain the immediate attention of those passing by. This durable banner can withstand the types of outdoor extremes that other forms of signage fall prey to.



ALL MEASUREMENTS ARE APPROXIMATE

Size	Print only
Pole Size 5'	<i>Please Call for Pricing</i>
Flag Size 56.5" x 19.5"	
Pole Size 8'	
Flag Size 88" x 33"	
Pole Size 11'	
Flag Size 108" x 31.5"	
Pole Size 14'	
Flag Size 142" x 33"	

Pole and Bag only Item #BHF + size	Outdoor Inground Stake Item #WSB1	Indoor Outdoor Base Water Tube Item #WSB2
5' \$46.00	\$39.00	\$42.50
8' \$50.99	\$39.00	\$42.50
11' \$57.50	\$39.00	\$42.50
14' \$63.25	\$39.00	\$42.50

Revised 9-25

ALL MEASUREMENTS ARE APPROXIMATE

Size	Print only
Pole Size 8'	<i>Please Call for Pricing</i>
Flag Size 71" x 35"	
Pole Size 11'	
Flag Size 96" x 40.5"	
Pole Size 14'	
Flag Size 144" x 41.5"	

Pole and Bag only Item #TDF + size	Outdoor Inground Stake Item #WSB1	Indoor Outdoor Base Water Tube Item #WSB2
8' \$46.00	\$39.00	\$42.50
11' \$57.99	\$39.00	\$42.50
14' \$63.25	\$39.00	\$42.50

Revised 9-25

ALL MEASUREMENTS ARE APPROXIMATE

Size	Print only
Pole Size 8'	<i>Please Call for Pricing</i>
Flag Size 72" x 24"	
Pole Size 11'	
Flag Size 108" x 30"	
Pole Size 14'	
Flag Size 156" x 34"	

Pole and Bag only Item #SLF + size	Outdoor Inground Stake Item #WSB1	Indoor Outdoor Base Water Tube Item #WSB2
8' \$46.00	\$39.00	\$42.50
11' \$57.99	\$39.00	\$42.50
14' \$63.25	\$39.00	\$42.50

Revised 9-25

Available Sizes

10' x 10'



10' x 15'



10' x 20'

- ★ SIDE WALLS, BACK WALLS
 - ★ TEAR DROP FLAG AND POLE
 - ★ TRAVEL BAG
- ALL SOLD SEPARATELY

**Please
Call Digital Dept.
for Pricing**

Tent Connector

Holds multiple tent / canopy frames together



Revised 9-25

\$25.99 each | Item #TBH

Cross Bars

Used to create a half wall



Revised 9-25

\$33.00 each | Item #TCBR

Sand Bags

Provides Extra Stability For Outdoor Use



\$37.99 set of 4 | Item #TSB

Ropes & Pegs

Provides extra stability for outdoor use

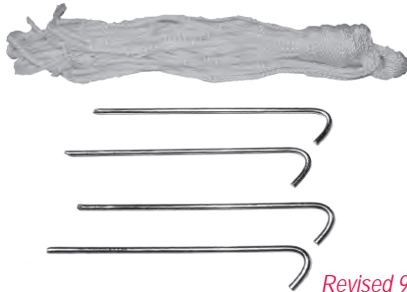

Revised 9-25

\$25.99 set of 4 | Item #TRP

Base Weight

Provides extra stability for outdoor Use



Call for Availability

Revised 9-25

\$40.99 ea. | 4+ \$37.99 ea | Item # TBWA

Water base weight

Provides extra stability for outdoor use



Revised 9-25

\$28.99 ea. | 4+ \$24.99 | Item #WBWT

Aluminum Frame

40mm aluminum hexagonal replacement frame

- Size 5' x 5'
- Size 10' x 10'
- Size 10' x 15'
- Size 10' x 20'

Please Call Digital Dept. for Pricing



Deluxe Travel bag with wheels



Revised 9-25

\$71.00 ea. | Item #TCB
Holds tents sizes 5' x 5' | 8' x 8' | 10' x 10' has 3 wheels

\$86.00 ea. | Item #TCB15
Holds tents sizes 10' x 15' has 3 wheels

\$86.00 ea. | Item #TCB20
Holds tents sizes 10' x 20' has 4 wheels

custom printed Canopy top

4CP Digital
Frame not included
Custom canopy top only

Please Call Digital Dept. for Pricing



Size 5' x 5'
Size 10' x 15'

Size 10' x 10'
Size 10' x 20'

Master Distributor For:

VALLEY FORGE

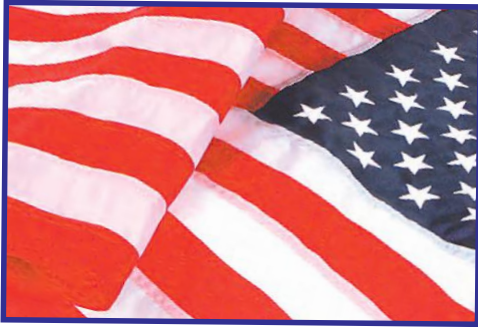

The Greatest Name In Flags
U.S. ● *California*

Perma-nyl

This Heavyweight DuPont Nylon is the most versatile and longest lasting nylon flag fabric available. Permany's combination of strength brilliant display, along with its quick drying ability, make it suitable for a wide range of applications. Great in rainy areas, its light weight and close weave enable it to fly in the slightest breeze, giving the fullest visual effect.

Koralex II

Koralex II represents new and improved flag fabric technology. Made of 100% spun polyester, its 2x2 ply construction combines durability, strength and flyability with a rich feel and look. These flags are ideal for extreme weather conditions without the excess weight for high wind areas.



flags exceed U.S. Government Inspections

BUYING FROM US IS THE SAME PRICE AS BUYING DIRECT!



California Flags Nylon

Size	Cost	Item #
3' x 5'	\$43.99	CF35
4' x 6'	\$56.99	CF46
5' x 8'	\$92.50	CF58

Perma-Nyl U.S. Flags

Size	Cost	Item #
2' x 3'	\$29.99	DN23
3' x 5'	\$43.99	DN35
4' x 6'	\$59.50	DN46
5' x 8'	\$89.00	DN58

Koralex II U.S. Flags

Size	Cost	Item #
3' x 5'	\$54.99	KX35
4' x 6'	\$71.99	KX46
5' x 8'	\$98.99	KX58

Revised 9-25

Larger sizes available... Please call for price

The Corbell Clamp



- Length is fully adjustable to 52"
- Adjustable to all table thickness
- EZ way to apply application tape

\$126.50 each | Item #CC52 *Revised 9-25*

The Best! Roller Tray

Our Roller Tray was designed to allow the rolling out of any size width material up to 50 lbs. The user can unroll or re-roll material without any effort and eliminates the possibility of any material damage. It can also be used as a roll feeder holder for sprocketed and unsprocketed drum cutter/plotters

Roll and Unroll Material Safely and Effortlessly



Revised 9-25

5" x 24" | **\$49.99** | 2+ \$43.99 each | Item #RT22

Reel PRO

ReelPRO is an affordable, easy to install, easy to use take-up system which will allow you to take control of your workflow. At the heart of ReelPRO is a proprietary patent pending drive train developed by Supply 55 which provides superior performance and reliability. ReelPRO will immediately start saving you money through improved efficiency when printing longer jobs: banners, vehicle wraps, wallpaper, signs, decals, etc.

- Unattended printing
- Avoid dust and dirt on printed images
- Eliminate waste through improved workflow
- Improve your profitability through improved efficiency
- Stop kinking and scratching prints as they are moved from the printer to your work tables, or as they hit the floor

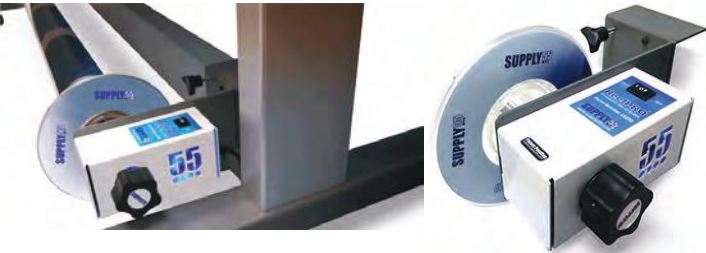

AVAILABLE THRU SPECIAL ORDER ONLY

Banner Pro

Are you tired of trying to fabricate your banners with cumbersome banner tape but are unwilling to spend \$4,000 and up for the current heat based hemming systems? We are proud to offer the BannerPro banner welding system. The BannerPRO offers numerous capabilities including hemming for grommets, pole pockets and pocket sign fabrication, at a fraction of the cost of other hemming systems. Take control of your jobs in-house with BannerPRO

Banner Welding System



Revised 9-25

\$1,550.00 | Item #BNPRO
\$89.95 | Item #55BPK | Maintenance Kit
\$199.95 | Item #55BPH | 10" Height Extension



The Deep Throat

heinrich Company

Punch Holes
in steel and aluminum
up to 1/8" thick

No. 6 Punch*
\$938.00

Item #BP06

Shipping Weight 42lbs

Revised 9-25

* Price includes 1/4" round punch and die set unless other size is specified

Punch is available in 4 sizes:
1/8" | 1/4" | 3/8" | 1/2"

EXTRA ROUND PUNCH & DIES SET

Size	Cost	Item #
1/8"	\$47.99	BPED18
3/8"	\$47.99	BPED38
1/4"	\$47.99	BPED14
1/2"	\$47.99	BPED12

LASSCO

Desk top corner rounder



Model M-20
Corner Rounders

Includes your choice of cutting unit.
sizes 1/8" | 1/4" | 3/8" | 1/2"

PVC, ABS, Magnetic Material and more.
Model M20 is **not designed for metal**
[i.e. Aluminum, Brass, Steel substrates]

\$437.99 | Item #LM20

Revised 9-25

LASSCO

Heavy duty corner rounder



Model M-50

- Heavy duty bench model
- Uses standard cutting units as well as large radius dies 3/4" | 1" | 1 1/2"
- Aluminum .032 or thinner can be a corner rounded with the 3/4" | 1" | 1 1/2" Dies

• **Full time metal use is not recommended.**
Half hard aluminum only

Revised 9-25

\$750.00 | Item #LM50

Does not include DIE see below

MODEL M-60

HEAVY DUTY HALF HARD ALUMINUM ONLY



MODEL M-60
RECOMMENDED
FOR METAL

Item #LM60
Cost \$1499.00

Revised 9-25

- Manual shear action
- Uses large radius cutting units 3/4" | 1" | 1 1/2"
- Corner round aluminum up to .080

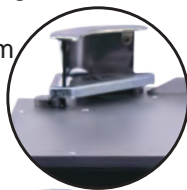

REPLACEMENT TABLES

Size	Cost	Item #
1/2"	\$651.99	TR12
3/4"	\$651.99	TR34
1"	\$651.99	TR01
1 1/2"	\$651.99	TR11

Revised 9-25

REPLACEMENT BLADES

Size	Cost	Item #
1/2"	\$119.99	BB6012
3/4"	\$119.99	BB6034
1"	\$119.99	BB6001
1 1/2"	\$119.99	BB6112



131 Revised 9-25

LASSCO



Cost \$348.99

Lassco dies large radius for (**M-50**)

Size	Item #
3/4"	LD34
1"	LD01
1 1/2"	LD125

Revised 9-25



REPLACEMENT BLADES

Size	Cost	Item #
3/4"	\$208.99	BB6034
1"	\$208.99	BB6001
1 1/2"	\$208.99	BB6112

Revised 9-25

LASSCO

Large radius dies



Size	Item #
1/8"	LD18
1/4"	LD14
3/8"	LD38
1/2"	LD12

Revised 9-25

Cost \$208.99

Lassco dies std.
for sizes (**M-20 / M-50**)
1/8" | 1/4" | 3/8" | 1/2"

GRAPHTEC
PRECISION CUTTING SOLUTIONS

CE8000

ROLL FED CUTTER SERIES
NEW

Basket Optional

Sheet Table Optional

BEST IN IT'S CLASS FOR PRECISION AND QUALITY

<p>CE8000-40 15"</p>	<p>CE8000-60 24"</p>	<p>CE8000-130 50"</p>
--------------------------	--------------------------	---------------------------

NEW GRAPHTEC **CE8000** SERIES

FEATURE HIGHLIGHTS

ENGINEERED FOR HIGHER PRODUCTIVITY
The Graphtec CE8000 Series cutting plotter is the perfect solution for those looking to increase production with greater efficiency for SIGNAGE Graphics • PRINT & CUT Graphics • Automotive Markets • Garment Decoration and many more....

A NEW TOUCH PANEL with **MECHANICAL KEYS** gives users more flexibility with it's **Blind Touch Operation** enabling the operator to continually keep eyes on media while feeding.

NEW Wireless LAN: (OPTIONAL) wireless connection module which improves flexibility of installation locations.

NEW Tool Holder: Improved design makes it easier to change tools and blade position by sliding the stopper forward and back.

Media Set Assist: Suction fans help to prevent media lift and shift when feeding.

Email Notification: Job Completion and Error Notifications can be sent to users by email.

Separate Tool Positions for contour and die cutting ensures the longevity of your blades and cutting strip when creating decals and graphics that are effortlessly popped out of sheet and roll media.

Data Link Barcode System allows cutting different jobs with different data sequentially. By reading the Graphtec barcode, the CE8000 automatically detects its linked data from a PC or USB Drive.

The CE8000 Series barcode data management system allows the **Continuous Cutting** of multiple jobs with different data sequentially by detecting the Start Mark of each new job.

Advanced Registration Mark Sensing system delivers precise Print & Cut results using sensors to detect registration marks and perform axis alignment. Efficiency boosting functions improve productivity for Print & Cut applications such as labels and decals.

Expanded Contour Cutting Area expands the Print & Cut area to include objects outside of the registration marks. Production efficiency is enhanced and media waste is reduced.

- NEW Touch Screen with Keypad
- NEW Wireless LAN Module
- Improved Tool Holder Design
- Magnetic Storage Compartment
- DATA LINK Barcode System

Call or email for Pricing sales@sign-mart.com

GRAPHTEC
PRECISION CUTTING SOLUTIONS

FC9000

ROLL FED CUTTER SERIES

FC9000

TAKE UP SYSTEM OPTIONAL

VIDEO TRAINING
PRESS PLAY ▶ GET TO WORK

HIGH PERFORMANCE • MAXIMUM PRODUCTIVITY

<p>FC9000-75 30"</p>	<p>FC9000-100 42"</p>	<p>FC9000-140 54"</p>	<p>FC9000-160 64"</p>
--------------------------	---------------------------	---------------------------	---------------------------

GRAPHTEC **FC9000** SERIES

FEATURE HIGHLIGHTS

PERFORMANCE & PRECISION MEETS VALUE
Graphtec FC9000 Series is the most advanced, versatile roll fed cutting plotter to date. Revered for its dependable, high-precision cutting capabilities with both printed and unprinted materials, the FC9000 Series is the ultimate finishing solution for the wide format signage, apparel, and automotive industries. A robust feeding system, tool head, and new ARMS sensor further contribute to the FC Series' class leading performance.

With the **USB Offline Operation** function, cutting data saved to USB flash memory can be output directly to the cutting plotter, enabling users to operate the FC9000 cutter without a computer.

Data Link Barcode System allows cutting different jobs with different data sequentially by detecting the Start Mark of each new job. By reading the Graphtec barcode, the FC9000 automatically detects its linked data from a PC or USB Drives. This function is available regardless of printer or RIP software used.

The FC9000 Series barcode data management system allows the **Continuous Cutting** of multiple jobs with different data sequentially by detecting the Start Mark of each new job.

With **Multiple Mark Compensation**, the FC9000 can significantly increase your productivity. Contour cutting is repeated for each copy, cutting production time for Print & Cut applications.

Auto Paneling automatically splits long-length jobs into smaller pages that are cut sequentially to prevent skewing.

- Barcode Scanning System
- USB Offline Operation
- Powerful Cutting Head: 600gf
- Intuitive 3.7" LCD Control Panel

ARMS 8.0 NEW & IMPROVED FUNCTIONS

Advanced Registration Mark Sensing system delivers precise Print & Cut results using sensors to detect registration marks and perform axis alignment. Efficiency boosting functions improve productivity for Print & Cut applications such as labels and decals.

Expanded Contour Cutting Area expands the Print & Cut area to include objects outside of the registration marks. Production efficiency is enhanced and media waste is reduced.

Reversed Color Registration Marks

ARMS
Middle Marks on X & Y-axis

Segment Area Compensation (X-Y)
Recognizes middle marks between the registration marks to correct X / Y-axis distortion for greater accuracy when cutting longer length media.

Reversed Color Registration Marks
With this reversed color output, sufficient contrast is created for contour cutting of preprinted ultra glossy & reflective media.

Call or email for Pricing sales@sign-mart.com



Digital Clam Heat Press

The Siser® Digital Clam heat press is constructed using heavy-duty materials of the highest quality, which means these machines can be ran day in and day out without any concern. The Siser® Digital Clam features a digital readout and controls, which make any heat press task simple and stress-free for both experienced users and complete beginners alike.

- Platinum RTD heat sensor
- Digital time and temperature readouts
- Tubular heating elements eliminate cold spots
- Teflon® coated upper heat platen for added protection

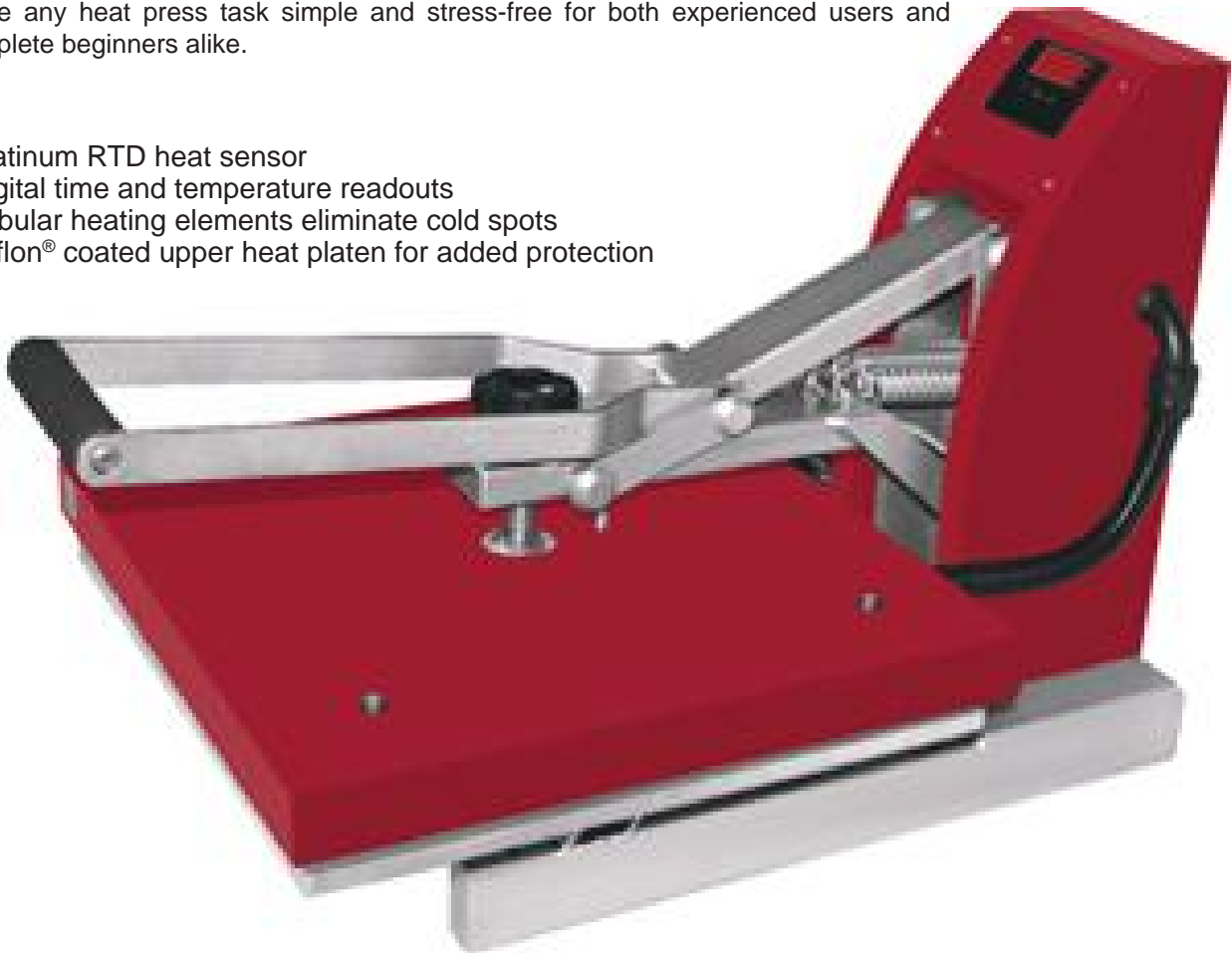

Press Size	Cost	Item #
11" x 15"	\$493.99	SHP1115
15" x 15"	\$657.99	SHP1515
16 x 20"	\$877.99	SHP1620

**CALL US
FOR MORE
DETAILS**

Revised 9-25

Acrylic Sheets

WE IMPORT OUR OWN SHEETS

CALL FOR PRICING
1-800-533-9099



Thickness	Clear	Black	White
1/4"	Yes	Yes	Yes
3/8"	Yes	Yes	Yes
1/2"	Yes	Yes	Yes
3/4"	Yes	Yes	Yes
1"	Yes	Yes	Yes

1/8" and 3/16" come in various colors and sizes

Styrene Sheets

HI - IMPACT

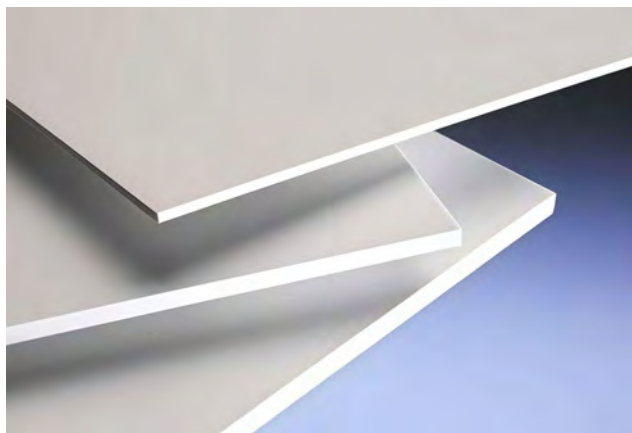

.015	48" x 96"	.060	48" x 96"
.020	48" x 96"	.080	48" x 96"
.030	48" x 96"	.090	48" x 96"
.040	48" x 96"	.125	48" x 96"

Note: No Pre-cuts.

**Cut per order from 4' x 8' sheet
(Customer must buy full sheet)**

CALL FOR PRICING
1-800-533-9099

ABS

Black or White

haircell one side / smooth

.060	48" x 96"
.090	48" x 96"
.125	48" x 96"
.187	48" x 96"
.250	48" x 96"

ALUMALITE

Composite Sign panels

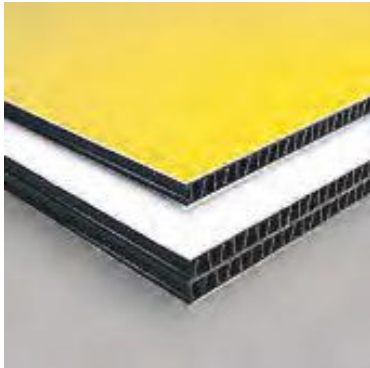

- .016 aluminum surface
- Corrugated plastic core
- Average outdoor life is 10 years

Alupalite has two high gloss or matte painted surfaces and is both water resistant and colorfast. It's ideal for pressure sensitive vinyl, paints and screen print inks.

Size	4' x 10' White	5' x 10' White
6 mm	Yes	Yes

Size
4' x 8' 6mm

- White
- Bright Yellow
- Sunset Red
- Grey
- Raven Black
- Ivy Green
- Royal Blue
- Ivory
- Matte Black



ECONOLITE

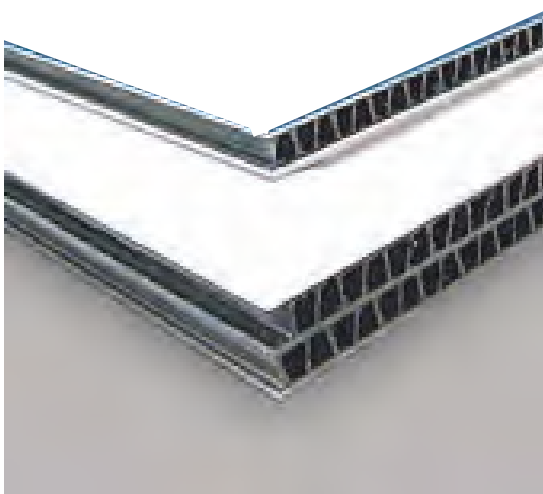

Econolite has one finished side and one side backed with a light gauge aluminum. Use with application such a wall mount signs, fascia or supported post and panel signs.

Size	4' x 8' White	4' x 10' White
6 mm	Yes	Yes

Size	4' x 8' White
10 mm	Special order

CALL FOR PRICING
1-800-533-9099

LUSTERBOARD

Composite Sign Panels

- Hardwood core
- Aluminum face
- Average outdoor life 5-7 years

Available in two-sided panels with smooth glossy aluminum finish. Lusterboard must be edge sealed for outdoor use



1/2" 4' x 8'
WHITE



CALL FOR PRICING
1-800-533-9099

OMEGABOARD

Hardwood Core // Limited Warranty

- Vinyl face
- Hardwood core
- Limited warranty 5-7 years

1/2" 4' x 8'
WHITE ON 1 SIDE

1/2" 4' x 8'
WHITE ON BOTH SIDES

1/2" 4' x 10'
WHITE ON BOTH SIDES



MDO

Hardwood Core Limited Warranty

48" x 96" x 1/2"	enamel 1 side primed 1 side	E / 1 / S - P / 1 / S
------------------	-----------------------------	-----------------------

Primed = Only needs paint
Enamel = Painted // Bare = Raw [wood only]
Good = Brown paper face, ready to be primed and painted



CALL FOR PRICING
1-800-533-9099

Sign Blanks *Western Red Cedar*

Our Sign Blanks are constructed from No. 1 Grade, kiln dried, vertical grain Western Red Cedar. The weatherability and stability of Western Red Cedar makes it an ideal choice for exterior commercial signs. Each sign blank is meticulously handcrafted to stringent quality control standards. Each blank is finished on all 6 sides, 1 3/4" thick. Our goal is to supply you with the finest substrates available.

Size	Cost	Item
18" x 23"	\$ 89.99	ALWD1823
18" x 35"	\$134.99	ALWD1835
24" x 23"	\$119.99	ALWD2423
24" x 35"	\$180.50	ALWD2435
24" x 47"	\$273.50	ALWD2447
24" x 95"	\$652.50	ALWD2495
36" x 47"	\$381.99	ALWD3647
36" x 71"	\$611.99	ALWD3671
48" x 71"	\$874.99	ALWD4871

**Great for Sandblasting,
Carving and routing**

LARGE SIZES MAY REQUIRE
SPECIAL HANDLING CHARGES

Revised 10-31-24



Size
18" x 23"

All Custom Orders Welcome!

FALCON BOARD

Recycleable and
Biodegradable Material



- Truly rigid
- Sharp print quality
- Lightweight and easy to carry
- Can be mitre cut and custom shape cut
- White craft paper, printable on both sides
- Strong and durable displays and other fabrications

OTHER FALCON BOARD PRODUCTS AVAILABLE THAT
CAN BE FOLDED, CURVED AND FASTENED HOT ADHESIVE

Thickness	Sheet Size	Cost	Item #
1/2"	48" x 96"	\$66.99	FB12



KÖMMERLING PVC BOARDS



High Density • Very Smooth • High White Point

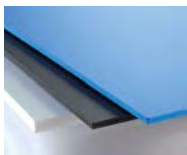

Superior PVC Boards for Exhibit Displays and
Digital Flat Bed printing

Thickness of sheets available:

2mm | 3mm | 4mm | 6mm | 10mm | 12mm | 19mm | 25mm

Sheet Sizes: 4' x 8' and 4' x 10'



Economy Version of KomaTex

Thickness of sheets available: 3mm | 6mm

Colors Available: Black and White

PLEASE CALL FOR SIZES, COLORS AND PRICING

SiBond

SiBond is available in a variety of sheet sizes and thicknesses

CALL FOR PRICING

Available in 4' x 8' sheets

Thickness of sheets available:

2mm | 3mm | 4mm | 6mm | 8mm

CALL FOR PRICING

Available in 4' x 10' sheets

Thickness of sheets available:

3mm | 4mm | 6mm

Aluminum composite panels Aluminum composite panels

CALL FOR PRICING

Available in 48" x 96" sheets

Thickness of sheets available:

2mm | 3mm | 4mm | 6mm | 8mm

OVERSIZED SHEETS ARE AVAILABLE



SiBond is a single faced and double faced aluminum composite material made of two aluminum panels with a solid polyethylene core. Single faced has a white face and natural mill finished back. Double faced has a white front and back

Aluminum sheets

Size
4' x 8' .040

- White
- Yellow
- Caution Yellow
- Red
- Orange
- Ivory
- Ivy Green
- Chevron Blue
- Black
- Pepsi Blue
- Dark Bronze
- Heron Blue
- Burgundy

Masking:

Painted aluminum is masked on one side. Mill finish is not masked

Color Variations:

In multiple sheet orders, slight color variations may occur due to different mill runs from the manufacturer.

Special Packaging:

Special packaging should always be applied

Call for Pricing

Also available WHITE Size 4' x 8'
.032 | .063 | .080



COLORS ARE ON ONE SIDE WITH WHITE ON THE OTHER SIDE

Showcard Poster Board

14 ply Double Faced White

Size Color	Cost 1-5 sheets	6 - 25 sheets	26 - 99 sheets	100+ sheets	Item #
28" x 44" Tuff White	\$4.07 ea.	\$3.92 ea.	\$3.75 ea.	\$3.41 ea.	TW28
28" x 44" Tuff Grey	\$3.63 ea.	\$3.58 ea.	\$3.42 ea.	\$3.10 ea.	TG28

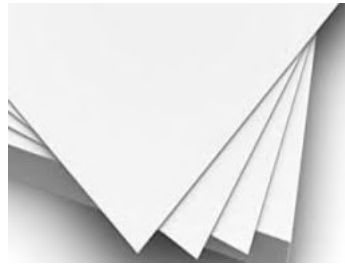

- Double faced white core premium board
- Double sided grey core economy board

Poster board **CANNOT** be shipped by UPS or FedEx

ONLY FULL [100] SHEET CASES WILL BE SHIPPED BY TRUCK OR LOCAL DELIVERY ONLY

Revised 9-25

CORRUGATED PLASTIC

Call for Pricing

Large selection of sizes and colors



Size	4' x 8' 4mm
	White
	Yellow
	Red *
	Orange *
	Ivory *
	Green *
	Navy Blue *
	Black *
	Light Blue *
	Brown *
	Natural *

Size	4' x 8' White	4' x 8' Yellow	4' x 8' Black	18" x 24" White Yellow	24" x 18" White Yellow
4 mm	Yes	Yes	No	Yes	Yes
6 mm	Yes	No	No	No	No
8 mm	Yes	No	No	No	No
10 mm	Yes	Yes	Yes	No	No

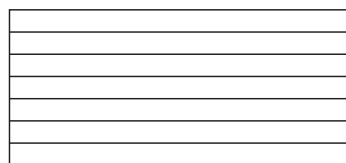

18" X 24" = 24" FLUTES

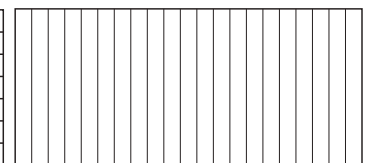

18" X 24" = 18" FLUTES

* COLORS AVAILABLE IN 4mm ONLY

SIGNMART

FABRICATION SECTION

LASER | ROUTING | FABRIC

ADA / BRAILLE | DIGITAL PRINTING | ENGRAVING

ACRYLIC FABRICATION | DIMENSIONAL LETTERS





LARGE AND GRAND FORMAT PRINTING

Our printing department has the latest technology in Flatbed printing. Our Vuteks print 50 - 4' x 8' sheets an hour, the color is beautiful and brilliant. With outstanding clarity, we are able to print as small as 4 point on any flat substrate up to 1.75 inches thick.

We have two EFI Vutek LX3 pro's with 8 colors plus white; our Flatbed printers also offer roll-to-roll printing up to 10 feet wide. With its powerful LED lights, your project is not only dried instantly, the LED's actually make it a "Green" process.

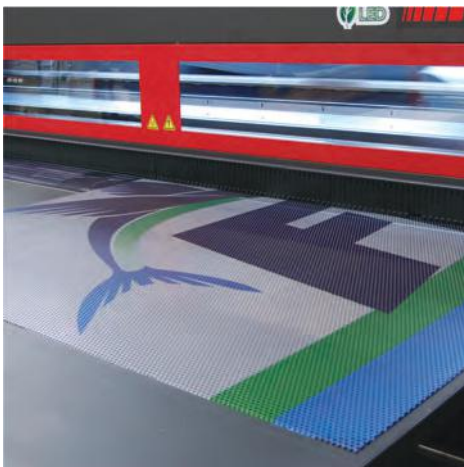

Direct to steel, customer provided 60" x 60" sheet.

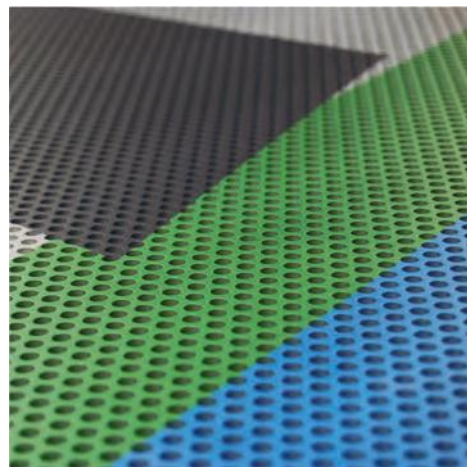

Direct to steel, customer provided 60" x 60" sheet.



48" x 96" sheets of Gator Foam with direct print.

FOR ESTIMATE PLEASE EMAIL : angie@sign-mart.com or karen@sign-mart.com



DIGITAL FABRIC AND VINYL PRINTING

With our wide array of Digital printers not only can we produce your job in either Solvent, Eco-Solvent, Latex or UV inks; we also offer various sizes. Poplin can be printed up to 10' wide, Flag material to 70" wide and Scrim Vinyl up to 16' wide.

Some of our most popular printed products include: Poplin Back Drops and Banners, Trade Show displays in Stretch Fabric, full color Canopy's, Scrim and Mesh Banners. Flags can come in various shapes and sizes such as Teardrop, Feather and Sail Wind.



10ft x 10ft stretch fabric Tube Cube trade show display printed on a Teleios Grande



13oz banner material printed on our 16ft Vutek gs5000r



Poplin fabric banners and table throws on our Teleios Grande direct to print

FOR ESTIMATE PLEASE EMAIL : angie@sign-mart.com or karen@sign-mart.com



DIMENSIONAL LETTERS AND LOGO'S

Dimensional Letters are great for interior and exterior use. We take great pride in having clean edges that can be painted in a variety of colors. Letters are easy to install with or without studs, and an installation pattern can be ordered showing you precisely where to drill your mounting holes. There are so many options available, Here a just a few:

Foam | Wood | PVC Aluminum | Acrylic.



10ft x 10ft stretch fabric Tube Cube trade show display printed on a Teleios Grande



13oz banner material printed on our 16ft Vutek gs5000r



Poplin fabric banners and table throws on our Teleios Grande direct to print

FOR ESTIMATE PLEASE EMAIL : sales@sign-mart.com

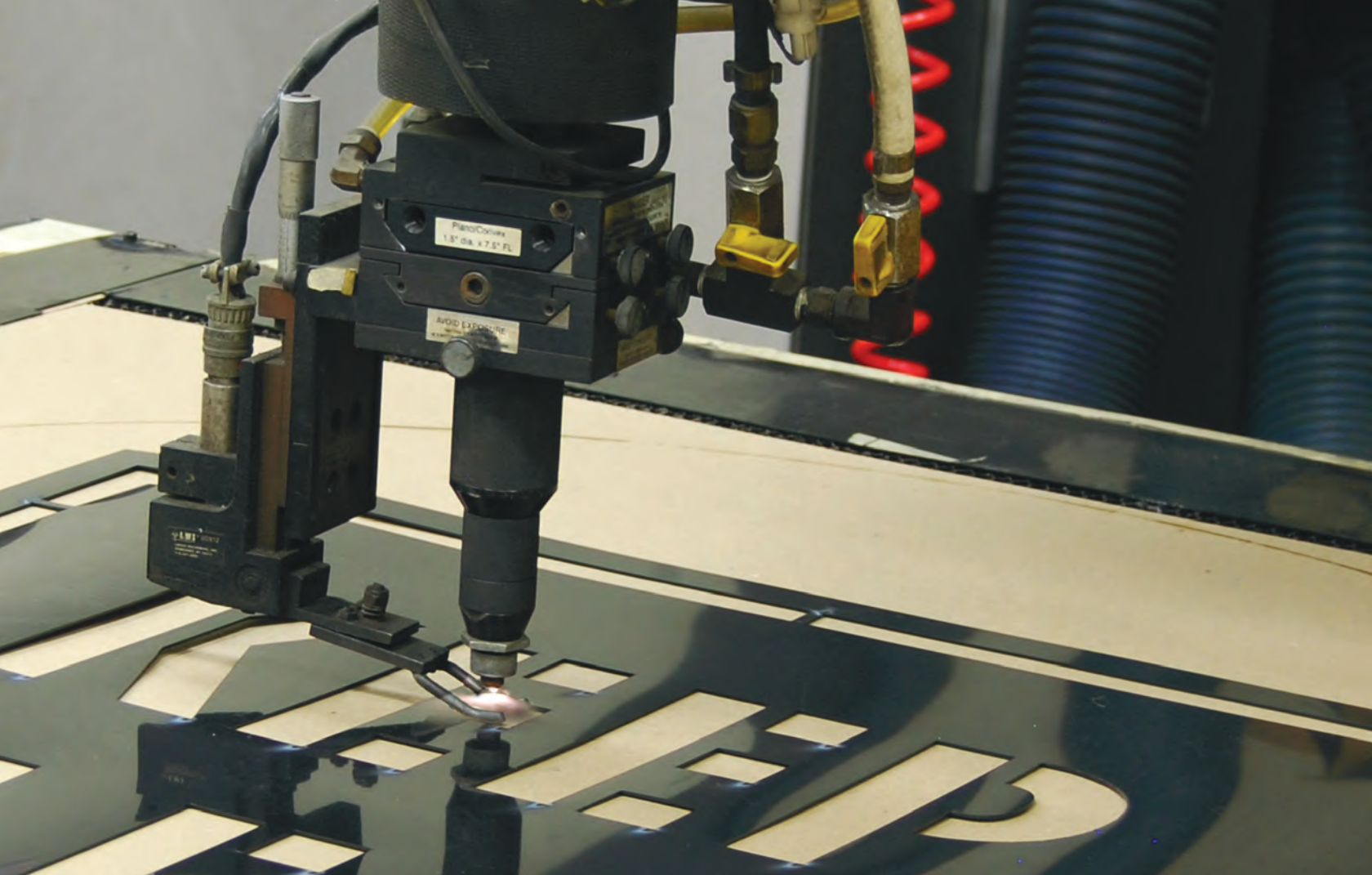

LASER CUTTING DEPT.

When certain projects require precise cutting with unparalleled accuracy, you need our 3500 watt CO2 Laser. We specialize in cutting acrylic and ABS plastic substrates.

The Laser is able to cut out projects ranging from simple shapes and cuts to intricate patterns with sharp details. It has a 4' x 8' bed and can cut substrates of various thicknesses.

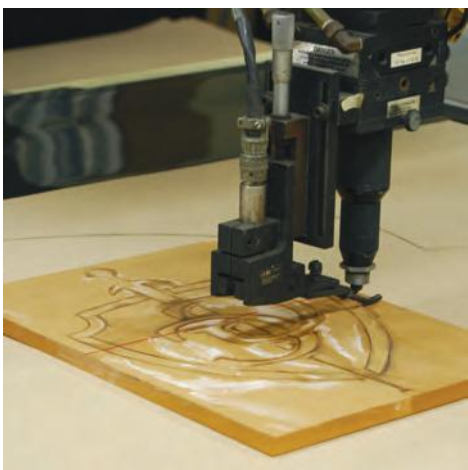

Custom Design on 1/4" thick Clear Acrylic



Custom cut 1/8" Brushed Gold Rowmark



Custom Cut 1/4" Black Acrylic with Digital Print

FOR ESTIMATE PLEASE EMAIL sales@sign-mart.com



**ENGRAVING
ROTARY & LASER
ADA / BRAILLE
3D PRINTING**

Our Engraving department has the experience to produce beautifully engraved signs and the expertise to handle any ADA project. Classic rotary engraving or the more advanced laser engraving is available. In addition to engraving we also do Tactile Raised Letters and Braille. We have a wide range of colors in our engraving material that we not only use on projects, but we also sell by the sheet. Textur3D is a 3-dimensional printing process for a unique look and feel in addition to standard flat printing. With a printable area of 10"x24" it produces ADA compliant Braille and Signage on Wood, Metals, Ceramic, Acrylic and Glass.



Braille Balls being applied to custom painted PVC ADA Signage



Black ADA raised Tactile Material and Braille on our TEXTUR3D DCS 1024

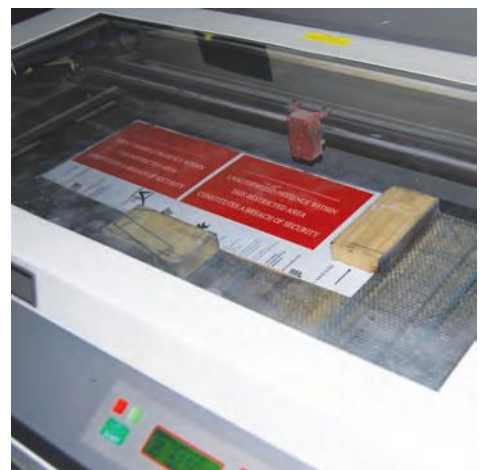

Precision engraved laser signage

FOR ESTIMATE PLEASE EMAIL sales@sign-mart.com

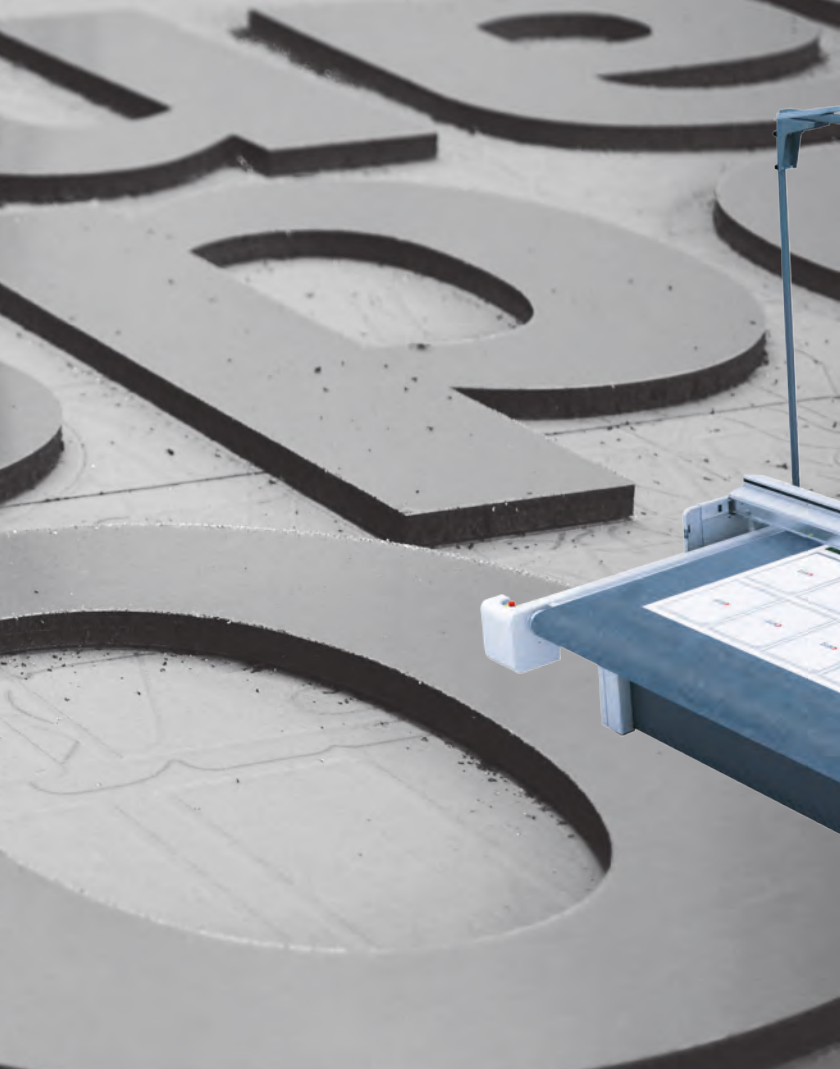

The
10' X 10'
ZUND 
 swiss cutting systems

**Come by
 and check
 out the Zund**

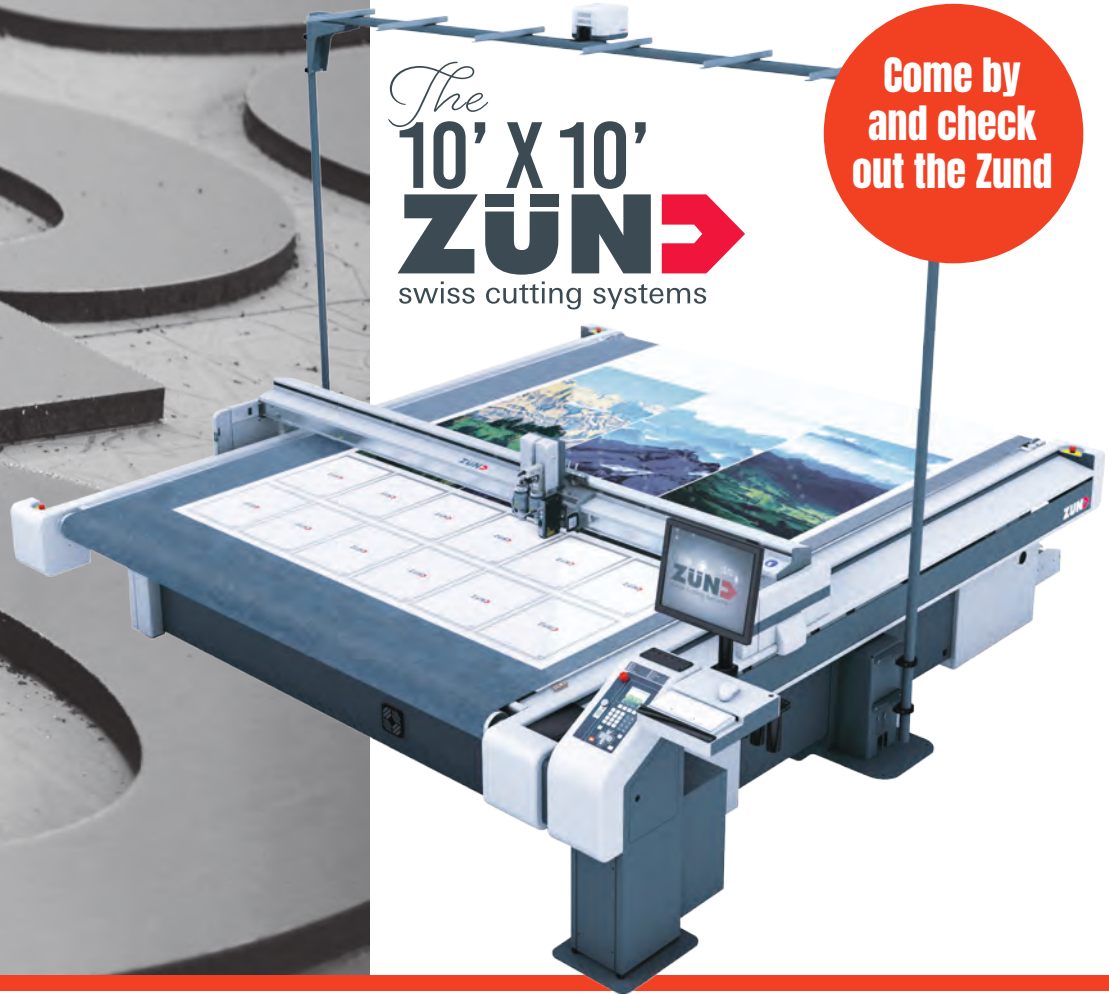

**ROUTING
 DEPARTMENT
 — AND —
 CUSTOM
 CUTTING**

Projects that need dimension are exactly what we have our two Multi Cam CNC Routers and our new addition the 10' x 10' ZUND. One of our Multi Cams has a 5'x10' bed with an Icut, that enables the system to read exactly where it should make the cuts. The other Router has a 7'x12' bed for larger projects. When it comes to diversity no tool can compete. From Carved signs, Cut Out Letters, Decorative Shapes, Form Raised Signs and Intricate Inlays our expert technician is able to turn a flat substrate into a dimensional work of art.



Cut Letters on Ultra Foam with Brushed Aluminum Face. Letters are nested



SiBond first printed on our Flatbed then cut with our Multi Cam with Icut



1/2" Black PVC Letters with Aluminum Face - the pink is a protective liner

FOR ESTIMATE PLEASE EMAIL sales@sign-mart.com



LAMINATING AND MOUNTING DEPT.

In our Laminating & Mounting department your project will receive the perfect finishing touches. With our vast variety of substrates and many types of laminate available, you will have the best material to suit your project needs. Laminating and mounting are done by one of our two 60" Pneumatic (air driven) Laminators or by hand from our experienced and knowledgeable staff.

You can rest assured your project will be produced to a smooth, flat professional finish.



Printed decals having lamination applied for extra UV protection

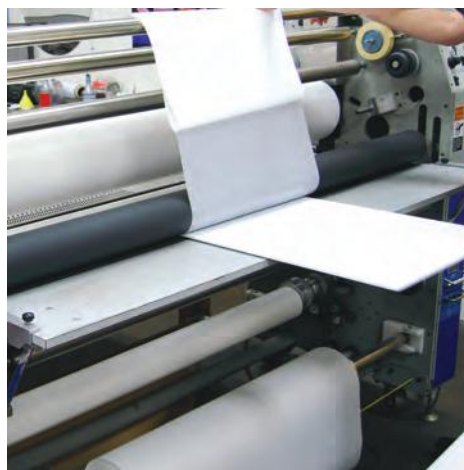

Printed vinyl graphics applied to foam core with laminator, then easel's attached



Sub-surface vinyl on clear acrylic applied by wet application

FOR ESTIMATE PLEASE EMAIL angie@sign-mart.com or karen@sign-mart.com



Paint *and Finishing* Dept

In our Custom Paint department our master painters are able to create beautiful paint colors in any hue and finish. We use only high quality One Shot Oil Based and Ronan Water Based Paints and are able to match PMS Colors or mix a custom color. From sanding to painting, to finishing and packaging this department follows strict quality assurance guidelines.



Laser cut Acrylic Letters & Logo painted with Oil Based Paint and assembled



Foam numbers Router Cut and then lightly sanded and painted

FOR ESTIMATE PLEASE EMAIL sales@sign-mart.com



FABRICATION DEPT. CUT TO SIZE SUBSTRATES

All Signage projects start with measurements. Fortunately for you this department has the knowledge and equipment to cut substrates to your exact specifications. We have the capacity to do Straight Cuts, Rounded Corners, Customs sizes and Drill Holes. Within the same area we have our Custom Acrylic Fabrication Dept. We can make Acrylic Display Boxes, Brochure Holders, Plaques and much more. And for the perfect finishing touch we can either Flame or Hand Polish the edges.

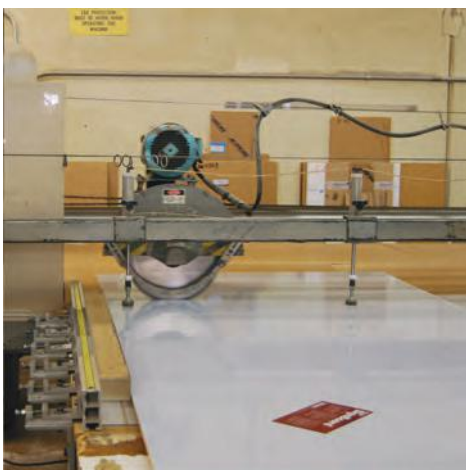

White Lexan cut with our Panel Saw and remeasured for accuracy



SiBond first printed on our Flatbed then cut to size with our 10' Metal Sheer



Custom acrylic displays

FOR ESTIMATE PLEASE EMAIL sales@sign-mart.com

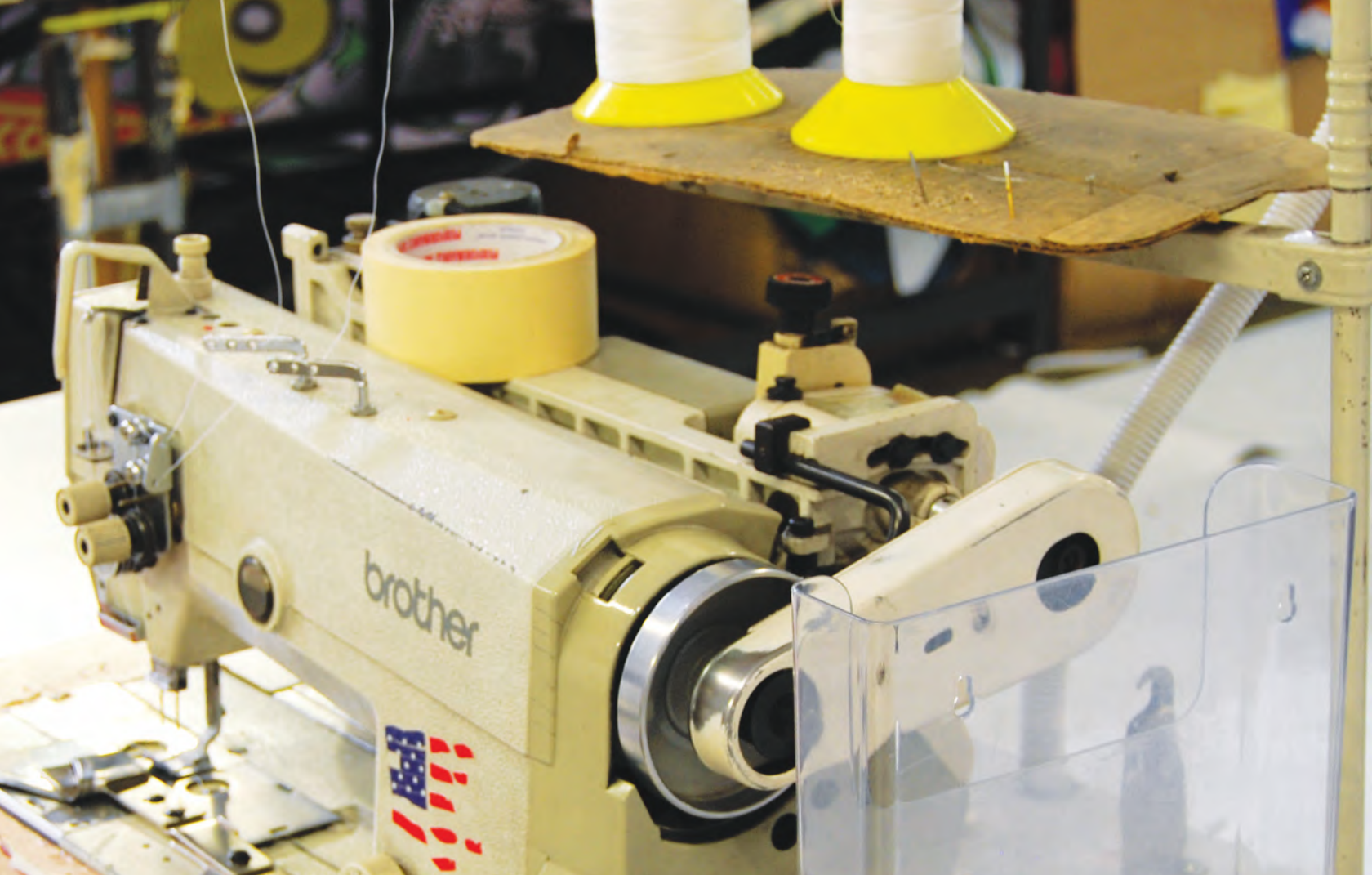

FINISHING DEPT.

The team in our Finishing Dept. is able to measure, cut and sew any size Banner, Flag or Fabric Display. Fabric Trade Show Displays come in many different shapes and sizes, and each display has a unique way of attaching to their frame. Tube frame display covers slip over the frame and are called Pillow Case Covers, they are closed with a Heavy Duty Zipper. Fabric Walls and Pop Up Displays can be attached with either Velcro or SEG. SEG stands for Silicone Edge fabric Graphics. We sew the SEG all around the edge, this makes the install and removal of the fabric very easy. It also gives a flat smooth face, perfect for Light Boxes.



13oz banner material edges sewn for strength with grommets added



Flag fabric sewn into a feather wind flag

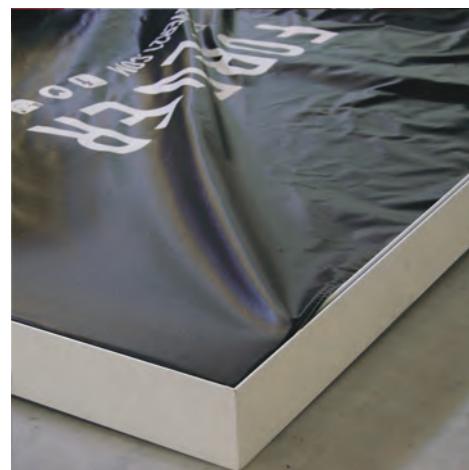

Martex printable fabric with SEG sewn in all around the edges

FOR ESTIMATE EMAIL sales@sign-mart.com



VINYL DEPT

We have a huge selection of stock vinyls. We carry Printable, Colored, Reflective, Translucent, Fluorescent, Metalized, Laminates, Sign Gold, Floor / Carpet, Wall, Metallic, Etched and Perforated.

Vinyl is cut with a plotter into Letters, Logos, Shapes and Graphics. After cutting the Vinyl, it is weeded and then Transfer Tape is applied to the Vinyl, that piece is then transferred onto a substrate with a squeegee.



Orafol 631 Vinyl



Roll Off machine // Vinyl Slitter

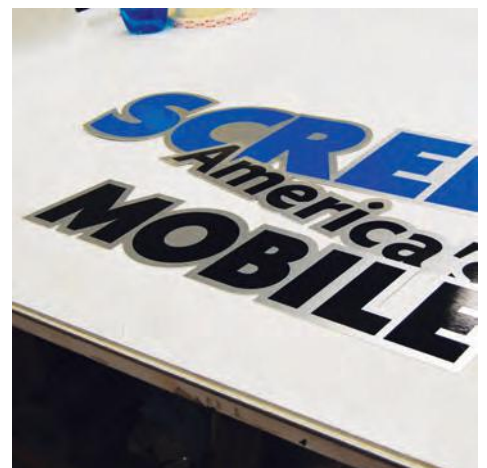

Orafol 751 black and blue vinyl on custom cut aluminum

FOR ESTIMATE PLEASE EMAIL sales@sign-mart.com

Index of products

FABRIC FLATBED ACRYLIC STENCILS
PVC SCREEN PRINTING ADA
DIMENSIONAL LETTERS
LASER ENGRAVING
DIGITAL PRINTING
ROUTING
LAMINATION DELIVERY
DIGITAL Acrylic STENCILS
PRINTING PVC FLATBED
Painting LASER ROUTING
SCREEN PRINTING Dimensional Letters
LASER

#11 Blades	122
1 Shot 4005	39
1 Shot Paint	135
3 Way Banner Stand	102
3M 468 Micro Adhesive	46
3M Air Release Tools	126, 127
3M Gold Squeegee	117
3M Tape Primer 94	125
3M Vinyl Remover	130
A Frame	60, 86 - 91
ABS Sheets	166
Ackland Media Frame	77
Acrylic Displays	147
Acrylic Glue	53
Acrylic Letters, Laser Cut	173
Acrylic Sheets	166
ADA Signs	54
Adhesive	52, 53
Adhesive Removal	130, 131
Adjustable Pedestal Display Stand	68

Avery Translucent Vinyl	4
Avery Vinyl, Plotter Film	3 - 9
Back Lit Film	18
Back Pack Display	105
Bada Bing Safety Ruler	113
Ball Bungee	98
Bamboo A Frame	88
Bamboo Deluxe Banner Stand	101
Bamboo Literature Display	68
Banaflex	28
Banner Blank, Sewn Custom Size	151
Banner Bracket System	107, 108
Banner Hem Tape	46, 48, 49
Banner Material, Printable	26 - 28
Banner Pro	161
Banner Saver	107
Banner Springs	141
Banner Stands	92 - 104
Banner Tape	46
Banner Trak	106



Applix Banner Stand	50
Application Fluid	132
Application Tape	44, 45
Apron	142
Arbor Adapter	130
Art Knife	115
Automark	13
Automotive Protective Film	35
Avery 900 Ultimate Cast Opaque	3
Avery Anti-Graffiti Laminate	38
Avery DOL 1060Z / 1360	36
Avery Fluorescent Vinyl	4
Avery Laminate	36
Avery Metallic Vinyl	5
Avery Metallized Vinyl	8
Avery MPI1105	13
Avery Paint Mask	9
Avery Printable Media	13
Avery Reflective Vinyl	6

Blaine Balls	171
Bravo Tabs	50
Brayer Roller	119
Break Away Knives	120 - 121
Brilliance Plastic Cleaner	133
Brochure Boxes, Real Estate	63
Brochure Holders, Clear Acrylic	147
Brown Kraft Paper	51
Brushed Aluminum Stand Offs	149
Brushes, Paint	137, 138
Brushes, Rivet	127
Buffer Kit	130
Bungee	98
Business Card Holder	111, 147
Business Signs	56
Butcher Paper	51
C Frame Display	104
California Flags	159
Canopy	157
Canopy Accessories	158

Canvas Stretcher Bars	109
Canvas Tac	22
Canvas, Printable	22
Car Window Stakes	62
Carbon Fiber Vinyl	11
Card Caddie	111
Carpet Custom Printed	155
Carpet Vinyl	25
Cedar Sign Blanks, Wood	168
Ceiling Grid Clips	146
Center Bracket	145
Center Point Measuring Tape	112
Center Point Rulers	113
Chalkboard Vinyl	7
Changeable Letters	141
Changeable Letters A Frame	91, 141
Chipboard Easels	65
Chrome Vinyl	7, 8
Clamps for Rope	144
Clear Acrylic Holders	147

Custom Printed Flags	156
Custom Printed Squeegees	118
Cutting Mats	115
Decofilm	42
Decoflock	42
Decorative Scroll Bracket	141
Decosparkle	42
Deep Throat Hole Punch	162
Delta Spray Master	132
Delux Expander Display	70
Deluxe Blade Holder	115
Deluxe Brochure Holder	63
Deluxe Retractable Knife	126
Desk Sign Holder	146
Desktop Roll Up Display	97
Die for Corner Rounders	162
Dinolite	167
Directory Display	77
Display Board Triangular Easel	66
Display Pop Up Frames	75



Convex Vinyl	17
Cool Corro Easels	65
Corbell Clamp	160
Corner Rounders	162
Coroplast Arrows	58
Coroplast Cutter	122
Coroplast Handles	58
Coroplast Counter Top Holder	141
Coroplast Shapes	58
Coroplast Sheets	171
Coroplast Sports Signs	57
Coroplast Stakes	59, 62
Corridor Brackets	146
Corru Board	169
Corrugated Floor Stand	67
Counter Top Sign Holder	141, 147
Creative Film Vinyl	7
Crescent Board	171
Crystal LED Acrylic Display	79
Curved Sign Face Displays	68

Easy Dot Chipboard Vinyl	7
Easy Weed	41
Econo Banner Stand	103
Econo Bracket System	108
Econo Classic	87
Econo Pro Liner Slitter	124
Econo Retractable Stand	94
Econo Squeegees	118
Econo Stakes	59
Econo Trim	113
Econo Utility Knife	120
Econolite	167
Edge Cap	144
EI Banner Stand	102
EI Diablo Stakes	59
Elan Scissors	124
Empire Banner Material	26
Engraving Braille Balls	141
Enroute Software	165
Epoxy	52
Etched Vinyl	8
EXG Wind Stand	99

Exit Signs	54
Expandable Pole Slitter	124
Expert 24 Plotters	164
EZ Snap Hanging System	105
EZ-X Banner Stand	103
Fabric Tape	49
Fabric Wall Media	22, 23
Falcon Board	169
Falcon Display Stand	66
Feather Wind Banner	156
Feet for Frames	86
Felt Squeegee	118
Field Master Paint	135
Flag Display	100
Flag Poles	63
Flags, Blank	154
Flags, Printed	153, 156
Flags, US / California	159
Flex Frames	85
Flexi Software	165

Gorilla Glue	52
Gorilla Tape	47
Grafix Gone	131
Graphitex	23
Graphtec Plotters	164
Grommet Machines	140
Grommets	139, 140
Ground Frame	61
Ground Vinyl	24, 25
Hand Held Hole Punch	119
Handicap Signs	54
Hanging Brackets	145
Hanging System Display	105
Hanseer Pounce Pad	141
HD Goal Post Stakes	59
HD H Stake	59
Heat Press Machine	163
Heat Transfer Film	40 - 43
Heavy Duty Handles	58
Hem Tape	46, 48, 49



FRONT LIT FLEX CORNER VINYL	20
Frosted Vinyl	8
Gamma Outdoor Banner Display	100
Gecko Cup	143
Gemstone	84
General Formulations Laminate	33, 34, 37
General Formulations Mounting Film	34
General Formulations Static Cling	18
General Formulations Vinyl	15 - 19, 25
G - Force Rivet Tool	119, 127
Gilder's Gold Vinyl	7
Glass Apeel	19
Glass Deco Vinyl	8
Glitter Flex II	42
Gloves	144
Gloves, Wrap	10
Glow-in-the-Dark Vinyl	6
Gold Grommets	140
Gold Solution	131
Gold Vinyl	7, 8
Golf Coroplast Signs	57

Job Folder	111
Johnson Rulers	113
Keder Tape	49
King Clip	148
Kling Mounts	148
Knap Sack Display	105
Knives	10, 115, 120-123
Komelon Measuring Tape	112
Koralex II Flags	159
Krystal Kote CTF Antigrffiti	39
L Table Top Banner Stand	97
Laguna Canvas	22
Laminate Films	33 - 38
Lamination Paper	36
Laminators	160
Laser Cut Service	172, 173
Lassco Corner Rounder	162
LED Displays	79
LED Lights	80,81
LED Snap Frame	78

Lidco Squeegee Holder	116
Light Displays	75 - 80
Lil Chizler	116
Liner Slitter	124
Linklip	143
Liquid Laminates	39
Lite Edge Safety Ruler	113
Lite Expander Display	71
Literature Display	68
Luminescent Cast Vinyl	6
Lusterboard	168
Mac Tac Permaflex	37
Mac Tac Street Rap	24
Magnetic Media Rolls	31, 32
Maghold	31, 32
Magic Canvas	22
Magic Printable Paper	21
Magic SBL-7 Back Lit Film	18
Magic Write	80
Magnetic Wrap Tools	125

No Smoking Signs	56
Novus	133
Nylad	155
Nylon Flags	154
Nylon Webbing	47
Olfa Knives	115, 120 - 123
Olfa Scissors	124
Omega Board	168
Omega Notcher	144
Open / Closed Signs	56
Open House Signs	56
Open Signs, Lighted	80
Orafol 200 / 210 / 215 / 290 Laminate	33
Orafol 270 / 280 Stone Guard	35
Orafol 290GF Optically Clear Laminate	35
Orafol 3105HT High Tack	17
Orafol 3164 / RA / XRA Vinyl	14, 15
Orafol 3165 / RA Vinyl	14
Orafol 3169RA Vinyl	16
Orafol 3268 / 3628 Wall Vinyl	23



Metal A Frames	30, 31
Metal Frames	64
Metal Stakes	62
Metallic Vinyl	5
Metallized Vinyl	7, 8
Metropolitan	89
Mini Banner Stand	96, 97
Mini Signicade Deluxe	87
Minicade	87
Modern SEG LED Frame	76
Mondo Banner Stand	102
Motomark Laminate	35
Motomark Vinyl	17
Mounting Films	34
Mounting Supplies	143 - 149
Narrowcade	87
Needle Glue Bottle	53
Neon Open Signs	80
Neschen Glass Deco Printable Film	8
Nikkalite Reflective Vinyl	6, 30

Orafol 331 Intermediate	2
Orafol 751 High Performance	3
Orafol 7510 Fluorescent	4
Orafol 811 Paint Mask	9
Orafol 831 Sandblast Mask	9
Orafol 8500 Translucent	4
Orafol 9300 Luminescent Cast	6
Orafol 951 Cast Metallic	5
Orafol 970RA Wrap Vinyl	11
Orafol 975 Carbon Fiber	11
Orafol HT-55 Tape	45
Orafol Laminates	33, 35
Orafol Printable Media	12 - 18, 23
Orafol Vinyl, Plotter Film	1 - 9
Orafol Wrap Vinyl	11 - 13
Orange Peel	131
Orion Banner Stands	94
Outdoor A Banner Frame	100
Outdoor A Frame	91
Outdoor Aluminum A Frame	98
Outdoor Directory	77

Outdoor Flag Pole Banner	100
Outdoor Heavy Duty Banner Stand	98
Outdoor Plastic Frames	84, 87 - 89
Overlaminates	33 - 39
Paint	135, 136
Paint Mask	9
Paint Supplies	137
Panel Clip	148
Pantone Color Guide	111
Paper	51
Paper, Printable	20, 21
Parking Signs	54, 55
Patriot Banner Bracket	108
PCR Roller and Pad	119
Pedestal Base and Post	83
Pedestal Display	68
Pencil, Stabilo	111
Pennants	153, 154
Pens, Fluorescent	80
Pens, Plotter	128

Pounce Powder	141
Pounce Wheel	126
Power Punch	48
Power Suction Cups	143
Power Supplies for LED	82
Power Tabs	50
Power Tape	48
Presta Floor Stand	104
Printable Heat Transfer Film	43
Printable Magnet	32
Printable Reflective Vinyl	30
Printed Banners	152
Printed Canopy	157
Printed Coroplast Shapes	57
Printed Flags	153
Printed Squeegees	118
Print - N - Walk	24
Pro Foto Paper	21
Pro Klip	143
Pro Print	43



Plexus LED	51
Plexus Plastic Cleaner	133
Plotter Blades	128
Plotter Machine	164
Plotter Pens	128
Pole Tape	46, 49
Poles for Flags	63
Poles for Street Banners	107, 108
Poli Tape	44
Polishing Block	133
Polytabs	50
Pop Up Displays	74, 75
Portable Banner Display	101
Portable Tube A Frame	90
Pos Pro 200+	26
Post	142
Post and Rail Frame Kit	60
Poster Board	171
Pounce Paper	51

PVC Displays	177
PVC Pro	169
PVC Tube A Frame	60
Que Media Vinyl	14
Quick Draw Measuring Tape	112
Quick Stick	132
Quik Sign	87
Rapid Remover	131
Rapid Tac	132
RAV Vinyl	14
Razor	122
Razor Liner Slitter	124
Real Estate Frames	60, 64
Real Estate Post	61
Real Estate Stakes	62
Reel Pro	161
REFB Frame	64
Reflective Vinyl, Plotter Film	6
Reflective, Printable Vinyl	30

Regulatory Signs	54 - 56
Removal Tools	130, 131
Restroom Signs	54
Retractable Blade	114
Retractable Stands	92 - 95, 97
Rider	61
Rivet Brush	127
Rivet Sealer 3000	127
Rivet Tool	127
Roland Cleaning Kit	134
Roller Squeegee	117
Roller Tray	161
Rollers for Paint	137
Ronan Paint	136
Rope	144
Rotary Cutter	121
RS2L Banner Stands	95
R-Tape	45
Rubber Pad for Grommets	139
Ruler Backer	113

Silicone	52
Silver Safety Reflective Heat Transfer	41
Silvertone Banner Stands	93
Simpo Sign II	88
Simpo Square 24	87
Single Edge Razor	122
Single Pin Vise	114
Siser Heat Transfer Material	41
Siser Heat Press Machine	163
Slide-In Frames	77
Slider Squeegee	118
Slitter	124
Slow Children Signs	55
SM Magnetic Table	69
SM Outdoor Banner Display	100
SM Repositionable Wall Graphics	23
SM Velcro Table	69
Snap Cap	77
Snap Frame	84, 91
Snap Lock Steel Straps	146



SEG Design	110
SEG Displays	74 - 76, 100
SEG Strip	74
SEG Tape	49
Setting Dies for Grommets	139
Showcard Poster Board	171
Sibond	170
Side Loading A Frame	90
Side Walk Sign	84
Sierra Outdoor Retractor	92
Sign Clamps	80, 145
Sign Feet	86
Sign Gold Vinyl	7
Sign Hinge	86
Sign Lab Software	165
Sign Mounting Brackets	145
Sign Post	142
Signicade	88
Signicade Deluxe	88
Sign-Mart #11 Knife Holder	115
Sihl Printable Media	20

Squeegee Sharpener	110
Squeegees	10, 117 - 118
Stabilo Pencil	111
Stahls' Cad-Cut	41
Stainless Steel X Frame Banner Stand	96
Stakes	59, 62
Stand Offs	149
Stand, Easel	65, 66
Standard Brochure Holder	63
Static Cling	18
Steel A Frame	91
Steel Post	142
Stencil Film	9
Stencils, Custom	172
Step and Repeat Display	70, 71
Sticky Yard	112
Stimpson Grommets	140
Stone Guard Film	35
Stop Signs	55
Straps	146

Street Banner Brackets	107, 108	Vandal Guard Anti-Graffiti Laminate	38
Street Vinyl	24, 25	Vehicle Protective Film	35
Stringed Pennants	153	Vehicle Wrap Magnets	125
Stripe Eliminator	130	Velcro	47
Styletech Etched Vinyl	8	Versatile A Frame	86
Stylon Banner Stand	104	Vinyl Application Fluid	132
Styrene Sheets	166	Vinyl for Nylon	155
Suction Cups	143	Vinyl Mover	129
Super Gripper	125	Vinyl Off	130
Super Light Weight Banner Stand	103	Vinyl Rack	129
Super Grip On Hook Weeder	114	Vinyl Remover	130, 131
Super Wind Sign	84	Vinyl Roller Tray	161
Supreme Pro Liner Slitter	124	Vinyl, Carbon Fiber	11
Surface Mount Sign Post Bracket	142	Vinyl, Plotter Film	1 - 9
Table Throws	155	Vinyl, Printable	12 - 19
Table Top Banner Stand	96, 97	Vinyl, Static Cling	18
Tag It Bracket	106	Volley Ball Coroplast	57
Tape	44 - 49	Wall Clips	146
T - Bar Stake	62	Wall Mount Acrylic Display	147
Tear Drop Wind Banner	156	Wall Mount Bracket Kit	106
Teflon Squeegee	117		



Translucent Printable Vinyl	10	Wind Spinner	85
Translucent Vinyl	4	Window Film	29
Triangular Easels	66	Window Juice	132
Trimmers	113	Window Scraper	116
Tuff Grey / White Poster Board	171	Winfex	28
Tuff Tape	46	Wire Roller	137
Tuff - Ban Banner	28	Women Signs	54
Tweezers	114	Wood Blanks	168
Twist N' Hook	143	Work Gloves	144
Twist - on Hanging System	143	Wrap Cut	126
U Bracket	145	Wrap Gloves	10
U Channel Post	142	Wrap Tools	10, 124 - 127
U Stake	61	Wrap Vinyl	11 - 13
Ultimate A Frame Hinge	86	Wraptex Stretcher Bars	109
Ultimate Banner Stand	101	Writing Board Fluorescent Pens	80
Ultra Thin Light Box	79	X Banner Stand	96, 100 - 103
Unisex Signs	54	X-Acto Knife	115
Universal Sign Stand	67	X-Spando Banner Stand	103
US Flags	159	Xtra High Bond Tape	46
USA Step Frame	64	Yellow Grommet Machine	140
USB Drive	111	Z Display	68
Valet Parking Signs	83		

SIGNMART

Supplies & Fabrications

2026

CATALOG



signmart_plasticplus



Sign-Mart@Signmartplasticsplus

Fax orders: 714-744-0077

Website / Orders: sign-mart.com

Email orders: sales@sign-mart.com

Phone orders: 714-532-7100 • 800-533-9099