



**WÜRTH**

**VEGLA  
DORE**



# WURTH PROGRAM | METRA



## PREMIUM Metër matëse

- Ndalim automatik - Self lock
- Shtëpizë gome dhe plastike
- Praktike dhe e qëndrueshme

Nr. art. 07146456...

Me magnet - art. nr 071464 569



## WURTH Metër matëse

- Shtëpizë plastike
- Rezistente ndaj korrozionit

Nr. art. 071464 00x

EC CLASS II

3m / 5m / 7m



## **PROFI** **Metër matëse**

- Shtëpizë metalike/plastike
- Qëndrueshmëri e lartë

Nr. art. 071469991...



## **RED LINE** **Metër matëse**

- Ndalim - Self lock
- Shtëpizë gome/plastike

Nr. art. 071469992...

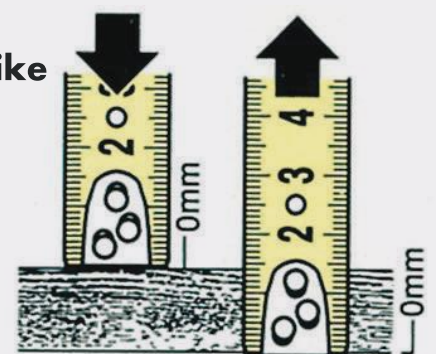

**Shirit metalik - ngjyrë të verdhë**

# WURTH PROGRAM | TJE

## THIKA

**THIKË RESCUE, L120mm**  
Nr. art. 071566 558



**THIKË BLACK ROCK, L110mm**  
Nr. art. 071566 557



**THIKË PËR PRERJEN E**  
Nr. art. 071566 565



## NIVEL MATËSE

### NIVEL MATËSE

- Saktësi e lartë dhe jetëgjatësi
- Saktësi prej  $0.029^\circ = 0.5 \text{ mm/m}$
- Lëngu brenda nuk e humb ngjyren
- UV rezistente



Art. nr. 0714644435 50cm



Art. nr. 0714644436 60cm



Art. nr. 0714644438 80cm

### NIVEL MATËSE STURDY

- Saktësi e lartë dhe jetëgjatësi
- Saktësi prej  $0.029^\circ = 0.5 \text{ mm/m}$
- Lëngu brenda nuk e humb ngjyren
- UV rezistente
- Shumë e qëndrueshme
- Mveshje e kuqe elektrostatische



Art. nr. 0714644205 50cm

### NIVEL MATËS

- Saktësi e lartë dhe jetëgjatësi
- Saktësi prej  $0.029^\circ = 0.5 \text{ mm/m}$
- Lëngu brenda nuk e humb ngjyren
- UV rezistente
- Shumë e qëndrueshme
- Mveshje e kuqe elektrostatische
- Me dy magnet



Art. nr. 0714644205 50cm

## SHARRË DORE

### SHARRË DORE PËR METAL-L40cm

- Sharrë dore metalike me dorezë të lehtë alumini



Art. nr. 071464 02

Tehe të sharrës:  
Art. nr. 0603300133

## SHARRË DORE UNI

### SHARRË DORE UNIVESALE-L147mm

- Sharrë dore metalike me dorezë të lehtë alumini

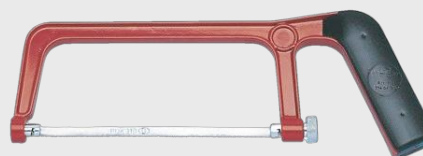

Art. nr. 071464 03

Tehe të sharrës:  
Dru; Art. nr. 06093  
Metal; Art. nr. 06092

## KABLLOVE L190mm



## THIKË PËR ZHVESHJEN E KABLLOVE (8-28mm)

**Nr. art. 071441 01**

Teh rez. 071441 010



## E MAGNETIKE

dhe jetëgjatësi  
0,29° = 0.5 mm/m  
nuk e humb

ueshme  
e elektrostatike  
të fuqishëm



07144304 40cm

## NIVEL MATËSE ELEKTRONIKE

- Elektronike, rezistente ndaj ujit
- E saktë dhe jetëgjatë
- Lëngu brenda nuk e humb ngjyrën



Art. nr. 0714644060\* 60cm



Art. nr. 0714644080\* 80cm



Art. nr. 5709300980\*  
Set tripod me laser RL1-18

## PERA



Prerës i tubave met.(3-35mm)  
Art. nr. 0714551331



Gërryese-2K+5thika  
Art. nr. 071466335



Matës i distancës-50m  
Art. nr. 5709300522



Dara për zhveshjen e telit-  
AUTOMATIKE-(0,2-6,0SMM)  
Art. nr. 0714109006

## Skalper me teh

### PROFI 3K Skalper me ndalues 170mm, Nr. art. 071566277

Dorezë ergonomike 3  
komponentëshe  
Teh prerës i zi  
Teh i rregullueshëm me  
opsion mbyellje



### PROFI 2K Skalper me ndalues, 170mm, Nr. art. 071566275

Dorezë ergonomike 3  
komponentëshe  
Teh i zi



\*vjen me +2 teha të zi në magazinë

### STANDARD PLUS skalper me ndalues, 155mm Nr. art. 071566210

Dorezë 1 komponentëshe  
Teh i zi  
Magazinë për 3 teha



\*vjen me +2 teha të zi në magazinë

## Skalper me teh trapezoid

### ZEBRA 3K THIKË SIGURUESE, 160mm, Nr. art. 071566017 \*

Dorezë 3 komponentëshe  
Thikë bi-metalike  
Thika largohet automatikisht pas  
prerjes së materialit  
Ndërrimi i lehtë i thikës



Teh art. nr. 07156602

### ZEBRA 2K THIKË 170mm Nr. art. 071566013

Dorezë ergonomike 2 komponentëshe  
Thikë bi-metalike  
Thika largohet automatikisht pas  
prerjes së materialit  
Magazinë për thika



### ZEBRA 2K THIKË SIGURUESE 170mm, Nr. art. 071566011

Dorezë ergonomike  
Thikë bi-metalike  
Mbyllje me 3 pozicione



## TEH STANDARD

Teh për skalper 18mm  
Nr. art. 07156605



Teh i zi për skalper 18mm  
Nr. art. 071566053



10 copë pako

## TEH SPECIAL

Teh prerës për stiropor,  
180mm  
Nr. art. 071566541



## TEH

Teh tra  
Nr. art.



Gjerësia

# ALPER

## Skalper BASIC me rrotë ndaluese, 155mm Nr. art. 071566045

- Trup nga plastika
- Teh i zi
- Bllokimi i rrethit me rrotë



## Skalper BASIC 170mm, Nr. art. 071566920

- Dorezë ergonomike 1K
- Magazinë për tehe



\*vjen me +2 teha në magazinë

E,  
5\*



## THIKË SPECIALE PËR PAKO/DEPO 160mm

Nr. art. 071566 018

- Siguri maksimale nga plastika mbrojtëse
- Hapje e shpejtë dhe e lehtë e pakove



## H TRAPEZOID

### Trapezoid për skalper 18mm Nr. art. 07156602



Paketimi për 100 copë

### Teh trapezoid për skalper 18mm Nr. art. 07156603



Paketimi për 100 copë

### Teh trapezoid bi-metal 18mm Nr. art. 071566021



# WURTH PROGRAM | DARAT

**DARA TË KOMBINUARA**

**PUNËTORI**



**ZEBRA QUALITY**

**RED LINE**

0714015...      5772015...

**PRERËSE**

**PUNËTORI**



**ZEBRA QUALITY**

**RED LINE**

0714015...      0714015...      577201553

**ZHVESHJE**

**PUNËTORI**



**ZEBRA QUALITY**

071401550

**DARA TË KOMBINUARA**

**ELEKTRIK**



**ZEBRA QUALITY**

**RED LINE**

07140157.../4/5/6      57720157...

**PRERËSE**

**ELEKTRIK**



**ZEBRA QUALITY**

**RED LINE**

**RED LINE**

07140157.../1/2/3      071401586      57720157...      577201585

**ZHVESHJE**

**ELEKTRIK**



**ZEBRA QUALITY**

071401570

**N E TELAVE**
**PUNËTORI**

**RED LINE**
**577201550**
**KAPËSE**
**PUNËTORI**

**0714015...**

**RED LINE**
**5772015...**
**DARA PËR HIDROINSTALUES**
**PUNËTORI**

**071401563**

**WÜRTH**
**07150233...**

**WÜRTH**
**071406...**

**07150906**
**N E TELAVE**
**ELEKTRIK**

**RED LINE**
**577201570**
**KAPËSE**
**ELEKTRIK**

**0714017...**

**RED LINE**
**57720157. 7/8/9**
**GËRSHËRË / SPECIALE**

**071303...**

**071403...**



















**WÜRTH**
**0715020...**

**WÜRTH**
**071402...**

# WURTH PROGRAM | KAÇAVIDA

## KAÇAVIDA PUNËTORIE ME BOSHT RRETHOR



| <p>MAJA PRANUESE</p>  <p>PH</p>  | <p>KAÇAVIDË STANDARDE</p>   <p>0613232...</p> | <p>KAÇAVIDË E GJATË</p> <p>2X EKSTRA GJATË</p>   <p>0613262...</p>  | <p>KAÇAVIDË STANDARDE</p>   <p>0613252...</p> | <p>KAÇAVIDË STANDARDE</p>   <p>5751242...</p> |
|--|--|--|--|--|
| <p>MAJA PRANUESE</p>  <p>PZ</p> |   <p>0613233...</p>                          |  <p>Dado montuese për shtrëngim me çelës</p>  <p>Koka goditëse mundëson goditjen edhe me çekan</p>  <p>0613253...</p> |   <p>0613253...</p>                          |   <p>5751241...</p>                          |

Kaçavida T-dorezë-ZEBRA- TX: 0613119...  
 Kaçavida T-dorezë-ZEBRA-6K: 0613116...  
 Kaçavida T-dorezë-ZEBRA- 6K sferike: 0613114...

Kaçavida T-dorezë-REDSTRIPE- TX: 5751140...  
 Kaçavida T-dorezë-REDSTRIPE- 6K sferike: 5751132...

Set kaçavida-ZEBRA-PH/  
 Set kaçavida-ZEBRA-PZ/  
 Set kaçavida-ZEBRA-PZ/

## KAÇAVIDA PUNËTORIE ME BOSHT 6 KËNDOR



### KAÇAVIDË STANDARDE



0613422...

### MAJË LASER



0613425...

### ME KOKË GODITËSE



0613322...

### ME KOKË GODITËSE D. 3K



0613201...

### VDE ELEKTRIKE



0613632...



0613423...



0613426...



Doreza 3 komponentëshe, mundëson kapje më të mirë dhe fuqi më të madhe

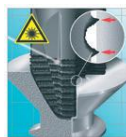

Prerjet laserike në majen pranuese i mundësojnë kapje më të mirë për vidhe, mbrojnë nga rrëshqitja dhe momentet më të lartë



0613202...



0613633...

# WURTH PROGRAM | KAÇAVIDA











## KAÇAVIDA PUNËTORIE ME BOSHT RRETHOR



| MAJA PRANUESE  | KAÇAVIDË STANDARDE  | KAÇAVIDË E GJATË  | KAÇAVIDË E SHKURTË   | KAÇAVIDË STANDARDE  |
|--|---|---|--|---|
|  | <br> | <br><br>2X EKSTRA E GJATË | <br> | <br> |
| MINUS  | 0613231...  | 0613261...  | 061325...  | 5751241...  |

## KAÇAVIDA PUNËTORIE ME BOSHT RRETHOR



| MAJA PRANUESE   | KAÇAVIDË STANDARDE   | KAÇAVIDË D. 3K  | KAÇAVIDË E GJATË   | MAJA PRANUESE   | KAÇAVIDË STANDARDE   |
|---|--|---|--|---|--|
|  | <br> | <br><br> | <br><br>2X EKSTRA GJATË |  | <br> |
| TX  | 0613434...<br>5751444... REDSTRIPE   | 0613203..   | 0613464...   | AW  | 0613437...   |

## KAÇAVIDA PUNËTORIE ME BOSHT 6 KËNDOR



### KAÇAVIDË STANDARDE



0613422...

### MAJË LASER



0613425...

### ME KOKË GODITËSE



0613322...

### ME KOKË GODITËSE D. 3K



0613201...

### VDE ELEKTRIKE



0613632...



0613423...



0613426...



Doreza 3 komponentëshe, mundëson kapje më të mirë dhe fuqi më të madhe

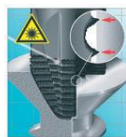

Prerjet laserike në majen pranuese i mundësojnë kapje më të mirë për vidhe, mbrojnë nga rrëshqitja dhe momentet më të lartë



0613202...



0613633...





MIN-6copa: 061392326  
MIN-5copa: 061392335  
MIN-DM-5copa: 061394235



Set kaçavida-ZEBRA-PH/MIN-6copa: 061392326  
Set kaçavida-ZEBRA-PZ/MIN-5copa: 061392335  
Set kaçavida-ZEBRA-PZ/MIN-DM-5copa: 061394235



Set kaçavida-ZEBRA-VDE-PH/MIN-5copa: 061396325  
Set kaçavida-RS-PH/MIN-5copa: 575194227  
Set kaçavida-ZEBRA-PZ/MIN-DM-5copa: 061394235





# WURTH PROGRAM | BITA

| Pranimi   | 1/4"  | 1/4"   | 1/4"  | 1/4"  |
|---|---|--|---|---|
| Gjatësia  | L=25mm  | L=25mm   | L=25mm  | L=25-32mm   |
| <br>PH<br>PZ |  | <br><b>TORZIONI</b> |  |  |
|   | 06141225...<br>06141125...  | 5614100300<br>561410040...   | 06141225...<br>06141125...  | 0614176...  |

| Pranimi   | 1/4"  | 1/4"  | 1/4"  | 10mm  |
|---|---|---|---|---|
| Gjatësia  | L=25mm  | L=29mm  | L=70mm  | L=75mm  |
| TX<br> |  | <br><b>TORZION</b> |  |  |
|   | 061431...   | 061431...   | 061433...   | 06147881...   |

| Pranimi         | 1/4"  | 1/4"  |
|-----------------|---|---|
| Gjatësia        | L=25mm  | L=29mm  |
| Mbajtës<br>1/4" |  |  |
|                 | 0614176688  | 0614176576  |

|                              |                              |   |   |  |
|------------------------------|------------------------------|---|---|--|
| <b>1/4"</b><br><b>L=50mm</b> | <b>1/4"</b><br><b>L=73mm</b> | <b>Pranimi</b><br><b>Gjatësia</b><br><b>MINUS</b>  | <b>1/4"</b><br><b>L=25mm</b>  | <b>1/4"</b><br><b>L=50mm</b>  |
| <b>061417669...</b>          | <b>061417677...</b>          |   | <b>061417565...</b>   | <b>061417566...</b>  |

|   |  |  |  |
|---|--|--|--|
| <b>Pranimi</b><br><b>Gjatësia</b><br><b>6-këndor</b>  | <b>1/4"</b><br><b>L=25mm</b>  | <b>Pranimi</b><br><b>Gjatësia</b><br><b>AW</b>  | <b>1/4"</b><br><b>L=75mm</b>  |
|   | <b>06141769...</b>   |  | <b>061451...</b>   |

**Art. nr. 0614400301**

|   |  |
|---|--|
| <b>1/4"</b><br><b>L=70mm</b>  | <b>10mm</b><br><b>L=75mm</b>  |
| <b>5614176638</b>   | <b>0614176702</b>  |

**Art. nr. 0614400402**

# WURTH PROGRAM | ÇELËSA















## HAPUR - UNAZOR

| ÇELËSA STANDARD |            |                    |            |              | Ç                          |
|-----------------|------------|--------------------|------------|--------------|----------------------------|
|                 |            |                    |            |              |                            |
|                 |            |                    |            |              |                            |
| 0713301...      | 5754101... | 0713308...         | 0713302... | 0713303...   | 0714251...                 |
| NIVELI METRIK   |            | METRIK TË<br>GJATË | 10° KËNDI  | NIVEL METRIK | NIVEL METRIK/<br>12-KËNDOR |



## UNZOR - UNAZOR

| ÇELËSA STANDARD    |            |           |                         |                    | ÇELËSA ME M            |
|--------------------|------------|-----------|-------------------------|--------------------|------------------------|
|                    |            |           |                         |                    |                        |
|                    |            |           |                         |                    |                        |
| 0713305...         | 5754105... | 071421... | 071422...               | 0715231...         | 071425701...           |
| METRIK<br>KËND 18° | METRIK     | METRIK    | METRIK<br>PËR ÇELËSA TX | METRIK<br>"BANANA" | METRIK<br>ME MEKANIZËM |

| HAPUR - HAPUR   |   |   |  |   |   |
|---|---|---|--|---|---|
| HELËSA ME MEKANIZËM   | STANDARD  | NYJE  |  |   |   |
| <br><br><b>0714259...</b><br><b>ME</b><br><b>MEKANIZËM</b><br><b>DY ANËSOR</b> | <br><br><b>0714263...</b><br><b>NIVEL METRIK/</b><br><b>MEKANIZËM/NYJE</b> | <br><br><b>0713304...</b><br><b>NIVEL METRIK</b> | <br><br><b>5754104...</b><br><b>NIVEL METRIK</b> | <br><br><b>0715222...</b><br><b>NIVEL METRIK</b><br><b>CARGO</b> | <br><br><b>0714230...</b><br><b>ME NYJE TË</b><br><b>HAPUR</b> |

| SPECIAL  |   |   |   |  |   |
|--|---|---|---|--|---|
| MEKANIZËM  | TUBULAR   |   |   | GJYSËM ÇELËS   |   |
| <br><br><b>0714254...</b><br><b>METRIK/ME</b><br><b>MEKANIZËM PËR TX</b> | <br><br><b>0714241...</b><br><b>METRIK/TUBULAR I</b><br><b>DYANSHËM</b> | <br><br><b>0714282...</b><br><b>METRIK/KËND</b><br><b>TUB. I DYANSHËM</b> | <br><br><b>0714244...</b><br><b>METRIK/</b><br><b>TUBULAR ME</b><br><b>NYJE</b> | <br><br><b>071527...</b><br><b>METRIK</b><br><b>ME GODITJE</b> | <br><br><b>0715261...</b><br><b>METRIK</b><br><b>ME GODITJE</b> |

# WURTH PROGRAM | ÇELËSA KOKË



## WURTH - ÇELËSA KOKË

|  |  |  |   |   |   |  |
|--|--|--|---|---|---|--|
| <p><b>12-këndor metrik SHKURTË</b></p>   <p><b>ZEBRA QUALITY</b></p> <p>07121331...</p> | <p><b>12-këndor metrik GJATË</b></p>   <p><b>ZEBRA QUALITY</b></p> <p>07121321...</p> | <p><b>6-këndor, metrik SHKURTË</b></p>   <p><b>ZEBRA QUALITY</b></p> <p>07121311...</p> | <p><b>6-këndor metrik GJATË</b></p>   <p><b>ZEBRA QUALITY</b></p> <p>07121323...</p> | <p><b>6-këndor metrik PËRTEJ</b></p>   <p><b>ZEBRA QUALITY</b></p> <p>0713130...</p> | <p><b>6-këndor metrik SHKURTË</b></p>   <p><b>ZEBRA QUALITY</b></p> <p>07121312...</p> | <p><b>Shumë-qëllimësh MULTI</b></p>  <p><b>JACK OF ALL TRADES</b><br/>Liron të gjitha llojet</p>  <p><b>ZEBRA QUALITY</b></p> <p>0712134...</p> |
|--|--|--|---|---|---|--|

## ÇELËSA KOKË TË ZI - IMPACT

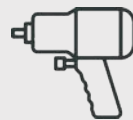







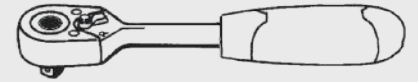













|   |   |   |  |
|---|---|---|--|
| <p><b>6-këndor, metrik SHKURTË</b></p>   <p><b>WÜRTH</b></p> <p>071413...</p> | <p><b>6-këndor metrik GJATË</b></p>   <p><b>WÜRTH</b></p> <p>0714131...</p> | <p><b>12-këndor metrik SHKURTË</b></p>   <p><b>WÜRTH</b></p> <p>07141319...</p> | <p><b>TX i brendshëm</b></p>   <p><b>WÜRTH</b></p> <p>0715136...</p> |
|---|---|---|--|

## AKSESORË PËR ÇELËSA TË ZI

|  |   |   |
|--|---|---|
| <p><b>Zgjatues</b></p>  <p><b>WÜRTH</b></p> <p>0714132...</p> | <p><b>Reduktues</b></p>  <p><b>WÜRTH</b></p> <p>07141328</p> | <p><b>Nyrtës kardano</b></p>  <p><b>WÜRTH</b></p> <p>071413...</p> |
|--|---|---|

**ÇELËS ARPIONI - KROM**

| IMBUS   | MINUS   | PH  | ETX<br>i jashtëm  | TX<br>i brendshëm   | XZN   | Ribe CV  |
|---|---|---|---|---|---|--|
|     |    |    |    |     |    |   |
|    |   |   |   |    |   |  |
|  |  |  |  |  |  |  |
| 07151370...   | 0715117...  | 0715118...  | 0715132...  | 0715133...  | 0715138...  | 0715139...   |

**AKSESORËT PËR ÇELËSA  
KOKË ARPIONI**

| ...   | Konektor  | Nyje<br>kardanike   | Reduktues   |
|---|---|---|---|
|     |  |  |  |
|  |  |  |   |
| 0715138351  | 07131184...   | 0712138301  | 0712138...  |

**SETE ÇELËSA KOKË IMPACT**

0715900200 - Çelës kokë impact-6k.long-8 copë



0715900100 - Çelës kokë impact-TX.long-8 copë



**Çantë e shpinës me bazë  
shell rezistente ndaj ujit  
460x400x200mm  
071593 750**



**Çantë shpine për vegla S  
330x110x440mm  
0715930244**



**Kuti-ulëse për vegla pune  
MULTI 470x300x300mm  
071593 600**



**Çantë e veglave e hapur  
fund waterproof 44x25x36  
0715930222**



**Çantë për vegla 28vende  
41x22x23cm  
0715930084**



**Çantë beli me 5 xhepa  
650x140x270mm  
0715930212**



**Çantë beli për vidha  
me zinxhiz  
0715930214**



**Kofer për për vegla pune  
41,5x26x20,5mm  
0962219200**



**Kofer veglash alumin  
poliester 44x23x34cm  
0715930232**



**Kuti e veglave me 3 ndarje  
660x260x248mm  
0962219004**



**Çantë e veglave me fund të  
papërshkueshëm nga uji  
0715930223**



**Çantë e veglave me fund  
waterproof 31x19x29  
0715930236**



**Çantë beli me 2 xhepa +  
2 mbajtës 200x110x290mm  
0715930210**



**Çantë beli për vegla  
2x2 200x140x290mm  
0715930211**

Nr. art. 575239 101



**8**  
copë

Nr. art. 575243 100



**9**  
copë

Nr. art. 575241 100



**9**  
copë







## VEGLA DORE

Würth Kosova Sh.p.k.  
Magjistrala Prishtinë-Ferizaj Km.15,  
Banullë, Lipjan 14000, Kosovë  
Tel: +383 (0) 38 600 308  
info@wurth-kosova.com

Würth Albania Sh.p.k.  
Autostrada Tiranë-Durrës Km.11,  
Nd.27, Kashar 1051, Tiranë, Shqipëri.  
Tel.: +355 (0) 42 247 773  
info@wurth.al

Imazhet jenë vetëm për qëllime ilustrimi dhe mund të ndryshojnë në pamje nga malli i dorëzuar.  
Çdo shpërndarje ose kopjim i këtij publikimi pa autorizim është rreptësisht i ndaluar.  
Informacioni në këtë publikim është pronë e Würth Kosova Sh.p.k. & Würth Albania Sh.p.k.©

# READY FOR WORK

