



Countrywide Healthcare

The UK's leading choice
for healthcare and janitorial supplies



Supplying the Healthcare sector for **over 25 years**



It's so easy to order
call us today on

01226 719090

or go online

countrywidehealthcare.co.uk



W E L C O M E

We are very proud to be the UK's leading supplier to the healthcare sector, delivering life-enhancing products and services nationwide for over 25 years. We use our expertise to help our customers in their purchasing journey and are committed to delivering products to enhance resident and patient care.

Our sourcing power alongside tried-and-tested own brands allows us to offer an unbeatable combination of high-quality products at affordable prices. With an industry-strong consultative approach, we deliver solutions tailored to your needs, helping to provide cost savings that benefit you.



SARAH ROBINSON
Managing Director

“ We endeavour to include innovation in our product ranges to provide more choice and flexibility for our customers. I'm delighted to offer industry-leading sustainable options which can help to reduce cost-in-use and benefit the environment. ”

- SARAH ROBINSON



HAND PROTECTION	4	MEDICAL EQUIPMENT	70	HOUSEKEEPING CONSUMABLES	164
HAND SANITISERS	5	THERMOMETERS	71	PAPER PRODUCTS	165
DISPENSERS	6	DIAGNOSTICS	73	TOILETRIES	173
NURSING CONSUMABLES	8	AIRWAY	76	HYGIENE SOAP	176
PREMIUM GLOVES	9	DEFIBRILLATOR	79	FRESH	179
PPE	10	DRUG STORAGE	80	PRIMACARE	193
DISPENSERS	11	BATHROOM AIDS	85	BIO-HYGIENE	202
CLEANSING WIPES	12	TOILET AIDS	90	DIVERSEY	208
SURFACE CLEANSING	18	MOBILITY AIDS	93	ASTONISH	220
CLOTHING PROTECTION	22	PATIENT TRANSFER	95	ZYBAX	222
UNIFORMS	24	MOVING & HANDLING	102	ODOUR CONTROL	224
CONTINENCE CARE	25	MEDICAL SCALES	106	CLOTHS & BRUSHES	227
LILLE	26	TREATMENT ROOM	108	MOPS & BUCKETS	230
ID	29	SENSOR PADS	110	BAGS & SACKS	235
TENA	34	DEMENTIA CARE	114	HOUSEKEEPING EQUIPMENT	238
ATTENDS	42	WAYFINDING	115	BINS	239
MOLICARE	46	REMINISCENCE & GAMES	118	STORAGE BOXES	245
INDAS	47	EXERCISE & MOVEMENT	123	TROLRIES	247
PROTECTIVE PADS	48	MUSIC & SENSORY	125	FLOOR CARE	249
MEDICAL CONSUMABLES	50	THERAPY	126	STEPS	256
WOUND DRESSINGS	51	CATERING	128	MAINTENANCE & SUNDRIES	257
PROCEDURE PACKS	53	BIODEGRADABLE & COMPOSTABLE	129	LAUNDRY	258
WOUND CARE	54	DAILY LIVING AIDS	131	BATHROOM SUNDRIES	259
BASICS	56	TABLEWARE	133	BEDDING & LINEN	260
UROLOGICAL	57	DEMENTIA TABLEWARE	136	WATERPROOF BEDDING	261
PLASTIC & DISPOSABLE	58	GLASSWARE	139	BED SET	262
RECORD KEEPING	59	CUTLERY	139	DUVETS & PILLOWS	263
FIRST AID	60	CROCKERY	141	POLYCOTTON BED LINEN	265
SYRINGES & NEEDLES	62	TABLEWARE SUNDRIES	144	FLAME RETARDANT BED LINEN	266
INFUSION	64	NAPKINS	148	SLEEPKNIT FR BEDDING	267
BLOOD COLLECTION	65	KITCHENWARE	149	TOWELS	268
OXYGEN & SUCTION	66	KNIVES & BOARD	154	BEDS & PRESSURE RELIEF	270
TRAYS & LINERS	68	THERMOMETERS	155	BED RAILS, MATS & TABLES	271
HOLDERS	69	FOOD STORAGE	156	BEDS & HEADBOARDS	273
		GLOVES & APRONS	157	PROFILING BEDS	275
		CONSUMABLES	158	PRESSURE RELIEF MATTRESSES	280
		DOMESTIC KITCHENWARE	163	PRESSURE RELIEF ACCESSORIES	289

simplifying your purchasing

online ordering

The perfect tool for quick and simple purchasing

When purchasing the same products frequently, our online portal is a quick and simple way to repeat order your items. A Countrywide online account allows you to instantly view your orders, fast order products by name and create order lists in advance which can be shared with colleagues directly from your account.



taking control of your budget

budgetminder

Designed to help you stay on track with your expenditure

Budgets can be allocated monthly or annually and can be filtered by product category. Access can be set directly at group level right down to individual homes for the ultimate control. Simple straight forward graphs and pie charts will identify your current budget vs spend and keep you in the know. Our simple traffic light system is an effective way to alert you as you reach your target spend.

Order online at www.countrywidehealthcare.co.uk

Call our sales team on **01226 719090** 5 days a week from 9am to 5pm Monday to Friday

Email your enquiry to sales@countrywidehealthcare.co.uk

PLEASE NOTE WE ARE
CLOSED BANK HOLIDAYS



 Countrywide
Interiors

FLIP THE BROCHURE TO VIEW OUR RANGE
OF FURNITURE AND FURNISHINGS

VISIT countrywidehealthcare.co.uk

CALL 01226 719090

EMAIL sales@countrywidehealthcare.co.uk

H A N D P R O T E C T I O N

INFECTION CONTROL

A range of hand protection products to help reduce the risk of infection. Helping to provide a safe environment for staff and residents everyday.

- Personal Hand Hygiene
- Soaps & Handwash
- Sanitising Dispensers





HAND SANITISERS

OFFERING AN ADDITIONAL LAYER OF PROTECTION
IDEAL FOR HAND HYGIENE ON THE MOVE

PURELL® ADVANCED HYGIENIC HAND RUB

A breakthrough formulation with exceptional antimicrobial efficacy.



60ML
CLIP
LC-0887

A hygienic hand rub that feels great to use and is clinically proven to help maintain skin health.

- Includes moisturisers to help keep skin healthy
- No-rinse hygienic hand rub
- Kills 99.99% of most common germs that may be harmful



60ML BOTTLE LC-0886

100ML BOTTLE LC-0885

500ML PUMP LC-0840

300ML PUMP LC-0884

BRACKET (300ML) LC-0888

PURELL® ADVANCED HYGIENIC HAND SANITISING FOAM

Enriched with skin conditioners that help maintain skin moisture and improve overall skin feel.

- Kills 99.99% of most common germs that may be harmful
- Unfragranced and colourless
- Helps maintain skin moisture



45ML FOAM LC-5892

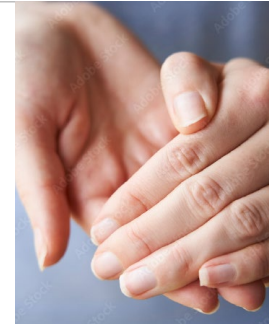

PURELL TOUCH FREE DISPENSER

Wall mounted dispensers ideal for high traffic areas.

- LTX-12® 1200ml white dispenser
- Smart, trouble-free electronics uses minimal energy per actuation
- Sanitary sealed refills protect users from the contamination risks of bulk soap



1200ML FOAM LC-5921

1200ML RUB LC-0875

DISPENSER LC-0871-WH

MANUAL SANITISING DISPENSERS

Engineered to perform and easy to maintain



**ADX-7™
COMPACT
700ML**



FREE
DISPENSER
ON LOAN



**ADX-12™
VOLUME
1200ML**



FREE
DISPENSER
ON LOAN

Compatible with PURELL® Advanced Hygiene 700ml refills

- Compact design ideal for tight spaces
- Large sight window for at-a-glance monitoring
- Converts to a locking dispenser – key included
- Sanitary sealed refills protect users from the contamination risks of bulk soap

Compatible with PURELL® Advanced Hygiene 1200ml refills

- High capacity dispenser ideal for high traffic areas
- Large sight window, skylight and crystal clear refill bottles make it easy to check fill status
- Converts to a locking dispenser – key included
- Removable pump for easy recycling

DISPENSER		LC-0877-WH	
DISPENSER	LC-0869	1200ML RUB	LC-0880
700ML RUB	LC-5987	1200ML FOAM	LC-0835

MANUAL SOAP DISPENSERS

ADX Dispensers offer exceptional reliability



**ADX-7™
COMPACT
700ML**



FREE
DISPENSER
ON LOAN



**ADX-12™
VOLUME
1250ML**



FREE
DISPENSER
ON LOAN

Compatible with GOJO® Mild Foam Hand Soap & GOJO Antimicrobial Plus Foam Handwash, 700ml Refills

- Compact design ideal for tight spaces
- GOJO Lifetime Performance
- Easy Maintenance – large sight window and skylight
- GOJO SANITARY SEALED™ Refills – snap quickly and easily into place

Compatible with GOJO® Mild Foam Hand Soap

- GOJO Lifetime Performance
- Easy Maintenance – large sight window and skylight
- GOJO SANITARY SEALED™ Refills – snap quickly and easily into place
- Controlled Collapse Refills hold their shape while emptying
- Refills made with SMART-FLEX™

DISPENSER		LC-0876-WH	
700ML MILD	LC-0878	DISPENSER	LC-0800
700ML PLUS	LC-0879	1250ML MILD	LC-0889



HAND PROTECTION

SOAPS AND HANDWASH THAT CAN HELP YOU PROVIDE AN ATMOSPHERE OF WELL-BEING FOR YOUR STAFF AND RESIDENTS

TOUCH-FREE SOAP DISPENSERS

Ideal for high traffic areas. Compatible with GOJO® Mild Foam Hand Soap, GOJO Antimicrobial Plus Foam Handwash and GOJO Freshberry Foam Hand Soap.

- LTX-7™ 700ml touch-free dispenser
- Smart, trouble-free electronics uses minimal energy per actuation
- Large sight monitoring window
- Single handed activation
- LTX-12™ 1200ml touch-free dispenser
- Smart, trouble-free electronics uses minimal energy per actuation
- Large sight monitoring window
- Single handed activation



**LTX-7™
COMPACT
700ML**



**LTX-12™
VOLUME
1200ML**

FREE
DISPENSER
ON LOAN

WALL
SHIELD
LC-0872-
WH

DISPENSER	LC-0801
700ML MILD	LC-5961
700ML FRESH	LC-0899

DISPENSER	LC-0870-WH
1200ML MILD	LC-0873
1200ML PLUS	LC-0874

LTX-7 also compatible with PURELL Advanced Hygienic Hand Rub



LTX-12 also compatible with PURELL Advanced Hygienic Hand Rub & PURELL Advanced Hygienic Hand Sanitising Foam (LC-5921)

LC-0896 LTX-7	LC-0890 RUB
---------------	-------------

LC-0871-WH LTX-12	LC-0875 RUB
-------------------	-------------

GOJO® SOAPS AND HAND WASH

Antimicrobial Plus Foam Handwash

- Suitable for use in food handling areas
- LC-0874**

Freshberry Foam Hand Soap

- Enriched with moisturisers & conditioners
- LC-0899**

Mild Foam Hand Soap

- Unfragranced, colourless and gentle
- LC-5961**



GOJO HAND MEDIC® PROFESSIONAL SKIN CONDITIONER

GOJO HAND MEDIC is designed to help maintain the skins natural moisture levels. Pair with the HAND MEDIC ADX-7 dispenser for ease.

- Skin conditioner
- Contains no silicone
- Fragrance free
- Quickly absorbed
- Non-greasy formula
- Water based
- Professional use



148ML TUBE	LC-0883
DISPENSER	LC-0893-WH
DISPENSER	LC-0893-BL/CH
685ML REFILL	LC-0894

WHITE
& BLACK
OPTIONS

NURSING CONSUMABLES

SAFETY & HYGIENE

Our everyday essentials range provides safe and hygienic products for staff and patient cleanliness.

- Protective Gloves
- Aprons & Masks
- Skin Cleansing
- Surface Disinfectants
- Personal Protection



PREMIUM GLOVES

COMFORTABLE TO WEAR AND GOOD SKIN COMPATIBILITY
PROVIDING OPTIMAL SAFETY

NITRILE NON-STERILE GLOVES - BLUE POWDER FREE

Ideal for use when in contact with bodily fluids.

- Blue or white nitrile
- Premium medical grade
- EN455
- AQL 1.5

100
PACK



SML	TK-0610	MDM	TK-0632
LRG	TK-0633	XL	TK-0634

VINYL NON-STERILE GLOVES - WHITE POWDER FREE

- Blue or white vinyl
- EN455
- AQL 1.5

100
PACK



SML	TK-0587	MDM	TK-0581
LRG	TK-0582	XL	TK-0592

VINYL NON-STERILE GLOVES LIGHTLY POWDERED

- Semi-transparent gloves
- EN455 & AQL 1.5

100
PACK



SML	TK-0589	MDM	TK-0590
LRG	TK-0591	XL	TK-0593

STRETCH VINYL NON-STERILE GLOVES POWDER FREE

- Synthetic vinyl gloves
- EN455 & AQL 1.5

100
PACK



SML	TK-0620	MDM	TK-0621
LRG	TK-0622	XL	TK-0623

VINYL NON-STERILE GLOVES - BLUE POWDER FREE

- Blue or white vinyl
- EN455
- AQL 1.5

100
PACK



SML	TK-0678	MDM	TK-0677
LRG	TK-0679	XL	TK-0680

POLYTHENE NON-STERILE GLOVES

- Non-sterile general purpose
- One size polythene
- Clear or blue gloves

500
PACK



CLEAR	TK-0588
BLUE	TK-0565

STERILE SOFT VINYL GLOVES POWDER FREE

- Sterile medical grade gloves
- Premium quality
- Latex free

50
PACK



SML	TK-0713
MDM	TK-0714
LRG	TK-0715



DISPOSABLE APRONS

Our disposable aprons are made from high quality polythene, available in a choice of five colours on a roll or flat packed. Choose from our value or premium ranges.



VALUE APRONS - 100 FLAT

QA-0195	QA-2001
QA-0196	QA-2002
QA-0197	

100
PACK

VALUE APRONS - 200 ROLLED

QA-0198	QA-0193
QA-0199	QA-0192
QA-0194	

200
PACK

PREMIUM APRONS - 100 FLAT

QA-0179	QA-0178
---------	---------

100
PACK

PREMIUM APRONS - 200 ROLLED

QA-0189	QA-0188
---------	---------

200
PACK



PROTECTIVE VISOR

Full face protective shield visor

- Fully transparent
- Flexible plastic
- Splash proof
- Comfortable fit

10
PACK



PACK OF 10 AA-3710

DISPOSABLE FACE MASK TYPE IIR

Featuring a three-layer construction, offering protection without compromising on comfort and breathability.

- **COMFORT**
The inner layer is soft and non-abrasive to the skin
- **BREATHABILITY**
The second layer deflects fluid whilst breathable
- **PROTECTION**
The third layer minimizes particle dispersal
- Type IIR Level 3 Mask with anti-fog foam
- 98% particulate effectiveness
- EN 14683: 2019



50
PACK

PACK OF 50 KE-3155

PREMIUM DISPENSERS

ANTIMICROBIAL PVC WITH LIFELONG ANTIMICROBIAL TECHNOLOGY HELPS STOP THE GROWTH OF BACTERIA AND MOULD

APRONS, GLOVES & WIPES DISPENSER

Antimicrobial dispensers reduce levels of bacteria such as MRSA, E Coli, Legionella, Salmonella and mould by up to 99.99%

Dispenser holds:

- 2 x glove box
- 1 x wipe pack
- 1 x apron roll



Registered
Design No: 40344C3

UNIT QA-0201



WALL MOUNTED APRON DISPENSER

Dispenser holds:

- 1 x standard roll of aprons
- H140 W364 D134 mm



UNIT QA-0200



APRON & GLOVE DISPENSER

Dispenser holds:

- 2 x glove box
- 1 x apron roll
- H360 W375 D134 mm



100 GLOVES QA-201

200 GLOVES QA-200

GLOVES DISPENSER

Single dispenser holds:

- 1 x glove box

Tripe dispenser holds:

- 2 x glove box



200 GLOVES DISPENSER

SINGLE TK-0594 TRIPLE TK-0595

100 GLOVES DISPENSER

SINGLE TK-0563 TRIPLE TK-0564



CLEANSING WIPES

OUR RANGE OF WET AND DRY WIPES PROVIDE THE IDEAL CLEANSING ROUTINE FOR CLEAN FRESH SKIN



BEST SELLER

PRIMACLEANSE WET WIPES TUB

Lightly fragranced cleansing wipes leave skin clean and fresh

- Dermatologically approved
- Alcohol and lanolin free
- Fresh fragrance
- Wipes 35 x 20cm
- 150 per tub

150 WIPES



150 WIPES

NE-3205

PRIMACLEANSE WET WIPES

A refreshing wipe for cleansing routines.

- Alcohol and lanolin free
- Soft and strong wipes
- Small: 16 x 22cm / 50 per pack
- Large: 20 x 22cm / 100 per pack

SMALL



50 WIPES

AVAILABLE SPRING 2023

NE-0545

LARGE



100 WIPES

AVAILABLE SPRING 2023

NE-0546

PRIMACLEANSE DRY WIPES - SPUNLACE

A high performance spunlace dry wipe with advanced absorbency

- Silky soft ultimate finish
- Ideal for delicate and sensitive skin
- Wipes 30 x 28cm
- 100 per pack

100 WIPES



100 WIPES

NE-3200

MACERATOR FRIENDLY

**PRIMACLEANSE DRY WIPES -
FLANETTE**

A strong and thick flanette dry wipe
with air-laid tissue

- Macerator friendly
- Strong, thick & absorbent
- Ideal for severe incontinence
- High bulk and water absorption
- Soft textile feel
- Wipes 30 x 28cm
- 75 per pack



75 WIPES

NE-0976

PRIMACLEANSE DRY WIPES

Strong and absorbent dry wipes

- Suitable for sensitive skin
- Soft and strong wipes
- Perfect for everyday use
- Regular: 30 x 18cm / 100 per pack
- Large: 30 x 28cm / 100 per pack



100 WIPES - REGULAR

NE-0973

100 WIPES - LARGE

NE-0974

ECONOMY



- Size: 20 x 26cm / 100 per pack

100 WIPES

NE-0969

* NOT UK MADE

EXTRA ABSORBENCY

**PRIMACLEANSE DRY WIPES -
SUPER ABSORBENT**

An extra absorbent strong dry wipe
offering greater moisture retention

- Strong and thick dry wipe
- Offers greater absorbency
- Soft touch feel
- 30 x 28cm
- 100 per pack



100 WIPES

NE-0971



CLEANSING RANGE

NEW AND IMPROVED RANGE OF CLEANSING WIPES, DESIGNED FOR THE INDIVIDUAL NEEDS OF THOSE RECEIVING CARE OR ASSISTANCE.



CONTI® WASHCLOTH MACERATABLE

Conti® Washcloth provides a more environmentally friendly alternative. Designed to disperse once disposed of in a hospital macerator, this wipe option supports a reduction in blockage and costly callouts.

- Large size 30 x 28cm
- Cellulose fibre blend
- Environmentally friendly
- High absorbency



75
WIPES

LRG	75 WIPES	NE-0990
-----	----------	---------

CONTI® CLEANSING DRY WIPES FLUSHABLE

Conti® Flushable wipes provides an alternative solution for post toileting, with the added convenience of quick, safe and hygienic disposal in either a toilet or macerator. Large and durable, this wipe is ideal for assisted toileting.

- Large size 22 x 24cm
- Plastic free cellulose blend
- Durable and flushable



50
WIPES

LRG	50 WIPES	NE-0998
-----	----------	---------



CONTI® CLEANSING DRY WIPES LITE

Conti® Lite combines strength and performance in a lightweight material.

This everyday wipe provides a cost-effective, reliable option, for a range of care tasks.

- 2 sizes available
- Small size 24 x18cm
- Large size 30 x 28cm
- Strong and durable
- 100% synthetic



100
WIPES

SML	100 WIPES	NE-0510
LRG	100 WIPES	NE-0991

CONTI® CLEANSING DRY WIPES SOFT

Conti® Soft provides strength and softness to support daily cleansing needs. Soft enough for use on fragile and sensitive skin.

- Large size 30 x 28cm
- Synthetic viscose blend
- Strong and durable
- Soft touch for sensitive skin

LRG	100 WIPES	NE-0995
-----	-----------	---------

100
WIPES



CONTI® CLEANSING DRY WIPES COTTON

Conti® Cotton Soft offers a cotton and viscose enriched material for a more textile feel. Designed specifically for the effective cleansing of heavily soiled skin.

- Large size 30 x 28cm
- Strong and durable
- Soft touch for sensitive skin

LRG	100 WIPES	NE-0996
-----	-----------	---------

100
WIPES



CONTI® CLEANSING DRY WIPES SUPER SOFT

Highly absorbent, ensuring skin is left dry without the need for vigorous rubbing and wiping. Its softness makes it ideal for cleansing all areas of the body.

- Very gentle for sensitive and fragile skin
- 2 sizes available
- Small size 30 x 22cm
- Large size 30 x 28cm

SML	100 WIPES	NE-0511
LRG	100 WIPES	NE-0997

100
WIPES



CLINISAN SKIN CLEANSING FOAM

BEST SELLER



Convenient
& time-saving



Cleansing, moisturising
& deodorising



Improved user
experience



Barrier
protection

One-step continence care

- Gently lifts soiling
- Cleanses and moisturises
- Emollients provide barrier protection
- Supports skin recovery

Quick drying no-rinse formula

- Eliminates issues associated with standard soap & water
- Dries quickly
- Reduces unwanted moisture
- Eliminates friction

Improves skin care

- Proven to maintain skin health in 66% of patients
- Reduces the risk of incontinence induced skin issues

200ML	ND-6965
-------	---------

400ML	ND-6966
-------	---------



DERMOIST SKIN CLEANSING WET WIPES

Dermoist skin cleansing wipes bring freshness from head to toe. A practical alternative to a soap and water bed bath.

- Moist cleansing wipe
- Soft and strong
- Quick and easy to use
- 27 x 26cm



100 WIPES NE-0227

HUGGIES PURE SENSITIVE WET WIPES

Huggies® Pure Wipes are made with skin loving natural fibres, gently cleansing and protecting delicate skin.

- 99% pure water
- No fragrance
- Hypoallergenic and clinically tested
- Gentle natural care



56 WIPES NE-0543

CARE WASH GLOVES

Easy to use wash mitt with a soft outer and plastic lining.

- Fits snugly onto your hand
- Safe for use over the whole body
- Use with separate cleanser
- 16 x 25cm

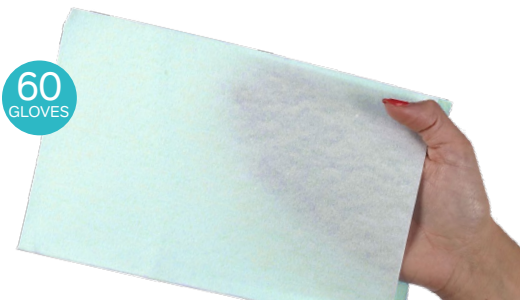

60 WIPES NE-0970

READIWIPES MOIST WIPES

Readiwipes® Wet - Body, large sized wipes are very special and contain a unique combination of premium ingredients for exceptional cleansing, conditioning and moisturising.

- Professional use in hospitals, nursing homes, care homes and for domiciliary care provision, by carers and patients alike
- Ideal for when bathing or showering is difficult
- Can be used on all skin types and ages
- Suitable for personal intimate hygiene
- Suitable for use before and after eating
- Suitable for makeup removal



60 WIPES NE-0563

CONTIPLAN ALL IN ONE CLEANSING CLOTH

A complete All in One Continence Care solution to cleanse, moisturise and protect.

- Barrier protection
- Long lasting
- Hypoallergenic
- Cleansing and moisturising
- Soothing natural plant extracts

8 WIPES

25 WIPES



8 WIPES	HC-0678
25 WIPES	HC-0699

MOLICARE SKIN MOIST CARE TISSUES

- Suitable for intimate cleansing of the genital and perineal area
- Dermatologically tested, suitable for sensitive skin
- pH skin balanced value of 5.5 preserving the natural acid protection mantle of the skin
- Re-sealable lid to prevent tissues from drying out

50 WIPES



50 WIPES	ND-1581
----------	---------

HYGENEX ECO FRIENDLY WET WIPES

Featuring natural ingredients, suitable for everyday use.

- Gentle and skin friendly
- Suitable for flushing and maceratable
- 100% biodegradable and compostable

30 WIPES



30 WIPES	NE-0941
----------	---------



SURFACE CLEANING

AZO™ PROVIDES SIMPLE EFFECTIVE SOLUTIONS FOR SURFACE CLEANING TO DELIVER HIGH EFFICACY AT QUICK CONTACT TIMES

HARD SURFACE & NON-INVASIVE MEDICAL DEVICES DISINFECTANT

AzoWipe® 70% IPA

70% Isopropanol provides convenient, effective and rapid disinfection of surfaces.

- Effective against a range of pathogens including Coronavirus and Norovirus
- Approved under the Biocidal Products Regulation (BPR)



EQUIPMENT WIPES	NE-6816
SURFACE WIPES	NE-6813
500ML SPRAY	HC-8119

MULTI-SURFACE DETERGENT & DISINFECTANT

Azo™ Universal

Delivers two-in-one surface cleaning and disinfection.

- Suitable for surfaces and non-invasive medical devices
- Effective against a range of pathogens including Coronavirus and Norovirus



SURFACE WIPES	NE-6811
500ML SPRAY	HC-0704



MULTI-SURFACE DETERGENT WIPES

Azo™ Detergent

Convenient multi-surface wipes suitable for routine cleaning and damp dusting.

- Suitable for a number of environments
- Also available in flushable and maceratable options
- 29.5 x 22cm



50 WIPES	NE-6825
----------	---------

PAL SURFACE AND PROBE DISINFECTION WIPES

Designed for cleaning and disinfecting within food manufacturing and service environments. The wipes disinfect and clean surfaces without using QUATS, PHMB or Alcohol. For professional use only. tested to a range of European testing standards (EN) and BS ISO 4120:2004.



200 WIPES

NE-6830



HARD SURFACE DISINFECTANT WIPES

Strong, blue, disinfection wipes, suitable for use on hard surfaces and equipment.

- Impregnated with 70% v/v isopropyl Alcohol BP
- Foil sealed to prevent leakage
- Effective against a range of bacteria
- Tested to EN1276



200 WIPES

NE-0219



UNIVERSAL WIPES & DISPENSER

The UK's most trusted single-step detergent and disinfectant; ideal for use on both surfaces and noninvasive medical devices.

- Clean and disinfect in a single step
- Effective from 10 seconds
- Kills at least 99.99% of pathogens
- Effective from 10 seconds
- Patented near-neutral pH formula
- EN14476



UNIVERSAL WIPES

50	HC-0672	100	HC-0676
200	HC-0690		



UNIVERSAL DISPENSER

DISPENSER BUCKET	HC-0680
BUCKET & 225 WIPES	HC-0679
REFILL 225 WIPES	HC-0681

CLINELL DETERGENT WIPES

Incredibly powerful, ideal for general multi-surface cleaning and damp dusting prior to disinfection. Designed for use in healthcare environments.

- Patented environmentally friendly formula
- Ultra-low smear multi-surface wipes
- Alcohol & disinfectant free



60

HC-0674

215

HC-0683

SANICLOTH DISINFECTION WIPE 70%

- Provides effective infection control
- Aids removal of soil
- Effective against tested organisms



200 WIPES

HC-0820

SOCHLOR CHLORINE DISINFECTION TABLETS

For isolation, terminal cleaning, daily cleaning and disinfection in high risk areas and during infection outbreaks.



SPRAY BOTTLE HC-3303

- 1.7g NaDCC/Chlorine p/tablet
- Effective against MRSA, c-difficile, norovirus and more
- Fully tested and certified EN14476 compliant
- Can be used for worktops and other hard surfaces

1.7G TUB OF 200

HC-3344

ANTIBAC MULTI SURFACE CLEANER SUPER CONCENTRATED

Extremely versatile product that cleans, degreases, deodorises and sanitises in one action, leaving a sweet lemon fragrance.



H1

- Complies with EN1276 (bacteria), EN1650 (fungal) EN13623 (legionella) EN14476 (viricidal)
- EPA Approved (NOROVIRUS, HIV, Influenza, Hepatitis B, Hepatitis C, Adeno Virus)

1LTR HC-7030

2LTR

HC-7030-2L

REUSABLE TRIGGER EMPTY

HC-7030-TR

UNPERFUMED ANTIBAC CLEANER SANITISER SUPER CONCENTRATED

Specially formulated to clean, degrease and sanitise in one operation.



K1

- Odourless and non-tainting
- BSEN1276 certified solution
- Contact time of 30 seconds
- EN1276 & EN14476 compliant

1LTR

HC-7033

2LTR

HC-7033-2L

REUSABLE TRIGGER EMPTY

HC-7033-TR

DI OXIVIR SPORICIDE CLEANER DISINFECTANT

Ready to use cleaner and disinfectant for non-invasive medical devices and nonporous surfaces.

- Use on surfaces, bed pans and commodes
- Effective against clostridium difficile spores
- EN1276 & EN14476 compliant



READY TO USE 750ML

HC-4195

FRESH ANTIBAC MULTISURFACE CLEANER RTU

An extremely versatile product that combines efficient cleaning and degreasing.

- Wide spectrum of activity
- Virucidal and bactericidal
- Fungicidal and deodoriser
- EN1276 & EN14476 compliant



READY TO USE 750ML

HC-3465

HARD SURFACE & NON-INVASIVE MEDICAL DEVICES DISINFECTANT

70% Isopropanol provides convenient, effective and rapid disinfection of surfaces.

- Effective against a range of pathogens including Coronavirus and Norovirus
- (BPR) Biocidal Products Regulation approved
- EN14476 compliant



READY TO USE 500ML

HC-8119

CLINELL ANTIMICROBIAL HAND WIPES

With a powerful, dermatologically - tested formula, Antimicrobial Hand Wipes are suitable for frequent use.

- Effective from 10 seconds
- Kills at least 99.99% of pathogens
- EN14476 compliant



200 WIPES

200 WIPES

HC-0671



100 WIPES

100 INDIVIDUAL

HC-0670

70% ALCOHOL HAND SANITISING GEL

FRESH hand sanitising gels are available in a handy 500ml pump bottle and a Neconomical 5Ltr refill.

- Leaves skin feeling soft and smooth
- Rapidly disinfects and protects
- Moisturising properties
- Kills 99.99% of germs
- Proven to kill MRSA
- Certified to BS EN 1276, BS EN14476:2013, +A2:2019, EN 1276 & EN 1500



500ML PUMP

LC-5939

5LTR REFILL

LC-5945

HAND INSPECTION CABINET & GLITTERBUG LOTION

Using UVA, long wave UV light this product enables infection control officers or training establishments to demonstrate correct hand washing/scrubbing techniques. It will instantly highlight any defects and raises the awareness of potential hygiene problems.

The Hand Inspection Cabinet demonstrates the importance of hands being washed often and well, requiring the right technique and friction to reduce the risks of user infections and cross contamination.

Glitterbug Lotion

Rub in to your hands, when hands are then placed under a UV lamp any areas not washed properly will show up.



USES UV LIGHT TO INSPECT

CABINET

LC-6000

LOTION 240ML

LC-6001

BLUE THUMB LOOP FLUID PROTECTION GOWNS

Thumb loop fluid protection gowns are manufactured from soft durable polyethylene material of one-piece construction which is impervious to fluids, providing an extremely effective barrier against cross infection.

They are suitable for staff use in multiple areas.

- One Size
- 116 x 201cm
- Blue
- Non Sterile



20 PACK

20 PACK

KE-3170

FLAME RETARDANT CLOTHING PROTECTORS

Offering outstanding absorbency, durability and quality.

- Absorbent surface and fluid proof backing
- Machine washable & tumble dry safe
- Guaranteed 300 washes
- Adjustable snap closures
- Flame retardant
- Available in two lengths:
Short 45 x 60cm
Long 45 x 90cm



FLAME RETARDANT

BLUE
GINGHAM



LONG

NA-2001-GI

BLUE/RED
CHECK



LONG

NA-2001

SHORT

NA-2005-BL

UP TO
300
WASHES

SMOKERS FIRE RETARDANT APRON

Proban treated for user safety.

- Provides a safe covering for clothing
- A soft and comfortable fit
- Long length



SINGLE

NA-2020

DO NOT DISTURB TABARD WITH POCKET

Available in sizes ranging from Small to XXL.

Please state size when placing your order.



SINGLE

QB-2121

DIGNIFIED CLOTHING PROTECTORS

Offering outstanding protection in both a napkin and apron style.

- Polyester surface
- Fluid proof backing
- Quick drying
- Machine washable
- Tumble dry safe
- Adjustable snap closures
- Flame retardant
- Choice of colours:
Green, Burgundy or Blue
- Napkin 45 x 45cm
- Apron 90 x 45cm



FLAME RETARDANT

NAPKIN	NA-2011
APRON	NA-2010

Please state colour when placing your order.



DISPOSABLE BIBS

ATTENDS BIB

The Attends disposable bib is designed with a waterproof back sheet to protect the wearer's clothing.

- Front pocket stops spillages
- Adhesive tape keeps bib in place
- Size 35 x 67cm
- 250 bibs per pack



NA-0545



TENA BIB

Double top layers absorb fluid while plastic film protects clothing.

- Integral front pockets collect spills
- Back ties secure bib in place, close to users neck
- Size 37 x 68cm
- 150 bibs per pack

NA-0546

Coming Soon...



New range of colourful and practical uniforms

Embroidery Available



Tunics, scrubs, trousers and more

Practical uniforms in a range of different colours, styles and sizes. Made from high quality, durable fabric and customisable with logo and job title or name.

Coloured uniforms can help residents identify staff easily.

Call our team to find out more!

LARGE RANGE OF SIZES AVAILABLE



CONTINENCE CARE

COMFORT & DISCRETION

A wide range of continence care products from leading brands, providing comfort and security day and night.

- Lille®
- iD®
- Tena®
- Attends®
- PrimaCare®
- Molicare®
- Indas®





INCONTINENCE PRODUCTS

OUR ABSORBENT PRODUCTS COMBINE COMFORT, SECURITY AND DISCRETION. CERTIFIED "HYPOALLERGENIC" LIMITING THE RISKS OF SKIN ALLERGIES.



LILLE SUPREM FORM

LARGE SHAPED PADS

An effective solution for managing moderate to severe incontinence. Provides a high level of absorbencies.

- 100% BREATHABLE waterproof back sheet enabling air flow to maximise skin integrity
- DISCRETE quiet cotton- feel back sheet limits noise helping to preserve the users dignity
- ABSORBENT double absorbent core in the centre of the pad to optimise absorbency level
- NO LEAKAGE hydrophobic leg cuffs prevent sideways leakage
- INDICATOR the wetness indicator will turn blue in contact with urine and indicates when the pad should be changed for maximum comfort
- ODOUR CONTROL new generation super absorbent polymer, maximises the absorbency level and neutralises odours.



REGULAR PLUS	1570MLS	25 PACK	ND-3492
EXTRA PLUS	2230MLS	25 PACK	ND-3480
SUPER PLUS	2740MLS	20 PACK	ND-3495
MAXI	2920MLS	20 PACK	ND-0254

LILLE SUPREM LIGHT

SMALL SHAPED PADS

A range of products for managing light to moderate incontinence. Designed for small urinary losses caused by bladder weakness

- 100% BREATHABLE waterproof back sheet enabling air flow to maximise skin integrity
- ODOUR CONTROL maximises the absorbency level and neutralises odours.
- Provides anti-leakage security, discretion and comfort
- Can be worn with regular underwear
- Anatomic shape for a better fit and more comfort, whilst remaining discrete
- Peel off strip helps to keep the pad in place, reducing the risk of leakage



NORMAL	370MLS	28 PACK	ND-3476
EXTRA	600MLS	28 PACK	ND-3477
EXTRA PLUS	750MLS	16 PACK	ND-3474
SUPER	850MLS	28 PACK	ND-3478
MAXI	1030MLS	28 PACK	ND-3479

BEST SELLER**LILLE SUPREM PANTS****EASY PULL-UPS**

Ideal for managing moderate to heavy urinary incontinence.

- Easy to use LILLEPANTS are worn like regular underwear
- INDEPENDENCE allows people to maintain their independence and live to the full
- ODOUR CONTROL maximises the absorbency level neutralises odours
- Ideal for managing moderate to heavy urinary incontinence



EXTRA	1300MLS	14 PACK
MEDIUM	80-110CM	ND-7005
LARGE	100-135CM	ND-7006
X-LARGE	120-160CM	ND-7007
SUPER	1750MLS	14 PACK
LARGE	100-135CM	ND-7009
X-LARGE	120-160CM	ND-7010
MAXI	1900MLS	14 PACK
SMALL	60-90CM	ND-7008
MEDIUM	80-110CM	ND-7002
LARGE	100-135CM	ND-7003
X-LARGE	120-160CM	ND-7004

**UNISEX****LILLE SUPREM FOR MEN****SMALL SHAPED PADS**

A range of products for managing light to moderate incontinence for men.

- 100% BREATHABLE waterproof back sheet enabling air flow to maximise skin integrity
- ODOUR CONTROL maximises the absorbency level and neutralises odours
- Designed for small urinary losses caused by bladder weakness
- Provides anti-leakage security, discretion and comfort
- Can be worn with regular underwear
- Anatomic shape for a better fit and more comfort, whilst remaining discrete
- Peel off strip helps to keep the pad in place, greatly reducing the risk of leakage

EXTRA	600MLS	14 PACK	ND-3526
-------	--------	---------	---------

LILLE SUPREM FIT

ALL IN ONES

Ideal solution for managing moderate to heavy urinary incontinence

- 100% BREATHABLE waterproof back sheet enabling air flow to maximise skin integrity
- DISCRETE quiet cotton- feel back sheet limits noise helping to preserve dignity
- ABSORBENT double absorbent core in the centre of the pad to optimise absorbency
- NO LEAKAGE hydrophobic leg cuffs prevent sideways leakage
- INDICATOR turns blue in contact with urine signalling to change the pad
- ODOUR CONTROL new generation super absorbent polymer, maximises the absorbency level and neutralises odours.
- Wetback - the acquisition layer improves the rate of absorption, greatly reducing the risk of leakage and any feeling of wetness

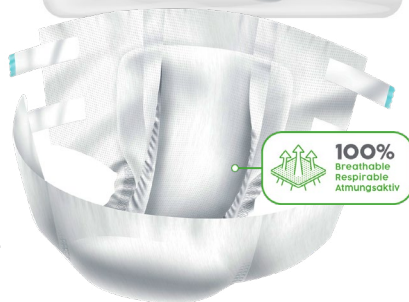

REGULAR PLUS: MDM	2440MLS	26 PACK	ND-2111
REGULAR PLUS: LRG	2550MLS		ND-2112
EXTRA PLUS: SML	1890MLS	20 PACK	ND-2110
EXTRA PLUS: MDM	2650MLS	24 PACK	ND-2353
EXTRA PLUS: LRG	2800MLS		ND-2354
EXTRA PLUS: XL	3200MLS	20 PACK	ND-2355
SUPER PLUS: MDM	2980MLS	22 PACK	ND-3497
SUPER PLUS: LRG	2950MLS		ND-3498
MAXI: SML	2190MLS	20 PACK	ND-3496
MAXI: MDM	3370MLS		ND-3499
MAXI: LRG	3550MLS		ND-3500
MAXI: XL	4060MLS		ND-3501



Waist Size

S	60-100cm
M	80-130cm
L	105-150cm
XL	110-160cm

EXTRA ABSORBENCY

LILLE CLASSIC BED

MATTRESS & CHAIR PROTECTOR



LATEX FREE



Designed to provide high levels of protection and softness, made from fluff pulp, a polyethylene back sheet and a soft non-woven sheet.

- Diamond structured pulp maximises diffusion
- Enhanced absorption and retention
- Polythene back sheet provides a waterproof barrier
- Sealed edges for optimal anti-leakage security

Pad Size

S	60x40cm
M	60x60cm
L	60-90cm

EXTRA: SML	700MLS	35 PACK	ND-3160
EXTRA: MDM	950MLS		ND-3159
EXTRA: L	1500MLS		ND-3352
SUPER: MDM	1100MLS	30 PACK	ND-3163
SUPER: L	1650MLS		ND-7012
MAXI: L	1780MLS	25 PACK	ND-3353



INCONTINENCE PRODUCTS

FROM OUR LIGHTWEIGHT INCONTINENCE PADS THROUGH TO BRIEFS AND BED PROTECTION, WE HAVE A WIDE RANGE OF DISPOSABLE PRODUCTS.

iD SLIP

COTTON FEEL ALL IN ONES

All in One products offer an effective solution for managing moderate to heavy incontinence. With a high level of absorption, the All-in-Ones provide the user with anti-leakage security and optimal comfort. They are particularly recommended for people with limited mobility or who are confined to bed.

- Soft Cotton Feel Back Sheet provides maximum comfort and discretion
- Fast Absorption layer designed to lock urine inside core of pad
- Odour Control system prevents formation of ammonia and unpleasant smells
- Double Wetness Indicators acts as a guide to when to change the product



Waist Size

XS	40-70cm
S	50-90cm
M	80-125cm
L	115-155cm
XL	120-170cm



PLUS: SML	1800MLS	14 PACK	ND-1264
PLUS: MDM	2000MLS	28 PACK	ND-1221
PLUS: LRG	2350MLS		ND-1220
PLUS: XL	3200MLS	14 PACK	ND-1276
EXTRA PLUS: SML	2050MLS	14 PACK	ND-1337
EXTRA PLUS: MDM	2750MLS	28 PACK	ND-1308
EXTRA PLUS: LRG	2950MLS		ND-1309
EXTRA PLUS: XL	3500MLS	14 PACK	ND-1335
SUPER: X SML	1550MLS	14 PACK	ND-1263
SUPER: SML	2100MLS		ND-1265
SUPER: MDM	3600MLS	28 PACK	ND-1313
SUPER: LRG	3700MLS		ND-1224
SUPER: XL	3800MLS	14 PACK	ND-1277
SUPER: XXL	3200MLS	15 PACK	ND-3507
MAXI: SML	2300MLS	20 PACK	ND-1208
MAXI: MDM	3700MLS		ND-0224
MAXI: LRG	4500MLS	15 PACK	ND-1300
MAXI: XL	4500MLS		ND-1325

iD EXPERT SLIP**PLASTIC BACKED ALL IN ONES**

All in One products offer an effective solution for managing moderate to heavy incontinence.

- Plastic Back Sheet provides maximum protection
- Fast Absorption layer designed to lock urine inside core of pad
- Odour Control system prevents formation of ammonia and unpleasant smells
- Double Wetness Indicators acts as a guide to when to change the product

**Waist Size**

XS	40-70cm
S	50-90cm
M	80-125cm
L	115-155cm
XL	120-170cm

NORMAL: MDM	1850MLS	28 PACK	ND-1266
NORMAL: LRG	2250MLS		ND-1271
PLUS: MDM	2000MLS	28 PACK	ND-1267
PLUS: LRG	2350MLS		ND-1272
EXTRA PLUS: MDM	2600MLS	28 PACK	ND-1269
EXTRA PLUS: LRG	2950MLS		ND-1274
SUPER: MDM	3600MLS	28 PACK	ND-1270
SUPER: LRG	4100MLS		ND-1330

iD BELT ACTIVE**EASY FIT COTTON FEEL**

Designed for managing moderate to heavy incontinence in active and independent people. Also recommended for limited mobility or those requiring assistance.

- Anti-leakage protection prevents side leakage for security
- Fast Absorption layer designed to lock urine inside core of pad
- Odour Control system prevents formation of ammonia and unpleasant smells
- Double Wetness Indicators acts as a guide to when to change the product
- Soft cotton back sheet for comfort

**Waist Size**

XS	50-70cm
S	60-90cm
M	80-115cm
L	100-145cm
XL	130-170cm

PLUS: SML	1500MLS	14 PACK	ND-2000
PLUS: MDM	1750MLS		ND-1286
PLUS: LRG	1850MLS		ND-1289
PLUS: XL	2100MLS		ND-2003
SUPER: SML	1900MLS	14 PACK	ND-2001
SUPER: MDM	2100MLS		ND-1287
SUPER: LRG	2400MLS		ND-1290
SUPER: XL	2600MLS		ND-2004
MAXI: SML	2600MLS	14 PACK	ND-2002
MAXI: MDM	2900MLS		ND-1288
MAXI: LRG	3400MLS		ND-1291
MAXI: XL	3400MLS		ND-2005
MAXI PLUS: MDM	3265MLS	14 PACK	ND-2007
MAXI PLUS: LRG	4012MLS		ND-2008



iD PANTS

MAXIMUM PERFORMANCE

A unisex absorbent pant designed to provide maximum performance for moderate to heavy urinary incontinence. Soft waist band and breathable material for extra comfort.

- 100% breathable & dermatologically tested
- Chamomile & vitamin E skin calming ingredients
- Protects delicate skin
- Odour control system within the absorbent core prevents the formation of ammonia and odours
- Maximum Fluid retention in short time for an extra dry feeling
- Elasticated zone ensure an anatomical adaptation to the body for maximum comfort
- Soft textile back sheet provides complete discretion
- Integrated anti-leak cuffs featuring waterproof material helps to prevent side leakage, maintaining security
- Proven to not cause skin irritations

Approved by dermatologists

iD pants

COMPLETE SKIN PROTECTION

Fast Absorption
Instant Dryness

Breathable

NORMAL

UP TO 10h Dry Feeling

ODOUR CONTROL

100% BREATHABLE

FAST ABSORPTION

IMPROVED TOPSHEET

Waist Size

XS	50-70cm
S	60-90cm
M	80-115cm
L	100-145cm
XL	130-170cm

iD CARE NET PANTS

USE WITH ID EXPERT FORM

Ensures maximum stability of pads by holding them close to the body for optimal anti-leakage.

- Soft fibres and double elastic lycra
- Allows freedom for movement whilst also minimising the risk of skin irritation



COMFORT SUPER NET PANTS

SML	40x80cm		ND-1243
MDM	60x100cm		ND-1244
LRG	80x120cm	5 PACK	ND-1245
XL	100x160cm		ND-1246
XXL	140x180cm		ND-1247
XXXL	180x195cm	3 PACK	ND-1303

NET PANTS WITH LEGS

LRG	85x110cm		ND-3520
XL	105x130cm	5 PACK	ND-3523

NORMAL: MDM	1550MLS	14 PACK	ND-1279
NORMAL: LRG	1250MLS		ND-1282
PLUS: SML	1320MLS	14 PACK	ND-1278
PLUS: MDM	1460MLS		ND-1280
PLUS: LRG	1590MLS		ND-1283
PLUS: XL	1700MLS		ND-1285
SUPER: MDM	1800MLS	12 PACK	ND-1281
SUPER: LRG	1950MLS		ND-1284
SUPER: XL	1950MLS		ND-3532
SUPER: XXL	1655MLS		ND-3537
MAXI: MDM		10 PACK	ND-3530
MAXI: LRG	2230MLS		ND-3531
MAXI: XL			ND-3538

BEST SELLER**iD FORM SHAPED PADS**

PLASTIC BACKED ALL IN ONES

Anatomically shaped pads ideal for moderate to heavy incontinence on mobile or semi-mobile patients. High absorption levels for dryness and comfort.

- Double Wetness Indicator acts as a guide to when to change the product
- Side elastics prevent leakage and maintain the pads anatomical shape
- Cotton feel top sheet and textile back sheet



NORMAL 1	53CM	1100MLS	28 PACK	ND-1253
PLUS 2	64CM	1500MLS	21 PACK	ND-1256
EXTRA 2	64CM	1900MLS	21 PACK	ND-1257
EXTRA PLUS 2	64CM	2350MLS	21 PACK	ND-1258
EXTRA PLUS 3	74CM	2450MLS		ND-1260
SUPER 2	64CM	2900MLS	21 PACK	ND-1259
SUPER 3	74CM	3150MLS		ND-1261
MAXI 3	74CM	3500MLS	21 PACK	ND-1262

iD EXPERT - LIGHT & ADVANCED

MODERATE INCONTINENCE

Ideal for women who suffer from moderate incontinence who need to use a highly absorbent product.

- Fast Absorption layer locks urine inside the core of the pad
- Odour Control system prevents the formation of ammonia and unpleasant smells
- The shape of the product ensures an anatomical adaption to the body for maximum comfort and discretion
- Soft Cotton Feel Back Sheet provides maximum comfort and discretion



LIGHT NORMAL	28CM	289MLS	28 PACK	ND-1250
LIGHT EXTRA	35CM	456MLS		ND-1251
LIGHT MAXI	40CM	800MLS		ND-1252
ADV MINI PLUS	25CM	250MLS	16 PACK	ND-1310
ADV EXTRA	34CM	500MLS	10 PACK	ND-1316
ADV SUPER	37CM	800MLS		ND-3566
ADV MAXI	37CM	668MLS		ND-1317

ID PROTECT PADS**MATTRESS & CHAIR PROTECTOR**

Designed to provide a high level of protection and softness, our bed and seat pads are made of diamond-structured pulp to maximise the diffusion of liquid.

- Soft non-woven top sheet for comfort
- Polythene backed sheet for waterproof protection



PLUS: 60x60CM	600MLS		ND-1294
PLUS: 60x90CM	950MLS	30 PACK	ND-1297
SUPER: 60x90CM	1550MLS	30 PACK	ND-7014

ID EXPERT PROTECT PADS**MATTRESS & CHAIR PROTECTOR**

Designed to provide a high level of protection and softness, our bed and seat pads are made of diamond-structured pulp to maximise the diffusion of liquid.

- Soft non-woven top sheet for comfort
- Polythene backed sheet for waterproof protection



PLUS: 40x60CM	525MLS	30 PACK	ND-1292
SUPER: 40x60CM	750MLS	30 PACK	ND-1293
SUPER: 90x180CM	1650MLS	20 PACK	ND-1331



A COMPLETE HYPOALLERGENIC
PARABEN-FREE SKINCARE RANGE

ID EMOLLIENT CLEANSER**2-IN-1 BODY & HAIR GEL**

This emollient cleansing gel gently cleanses the skin, leaving skin and hair soft and delicately fragranced.



500ML

ND-0601

ID BARRIER CREAM**PREVENTS & CALMS IRRITATION**

Enriched in glycerine and panthenol, to prevent and calm irritations.

Contains zinc oxide, to form a protective barrier.



100ML

ND-0604

ID CLEANSING WET WIPES**SOFT MOISTURISED CLOTH**

Indispensable for hygiene needs, cleanses and nourishes sensitive skin

- Safe to use multiple times a day
- Moisturised with a lightly scented milky lotion
- Keeps skin soft and refreshed



PACK OF 63

ND-0600

63
WIPES



TENA Plastic-Free Wet Wipes

Caring for skin while caring for our world

PACK OF 48 ND-0563



Introducing TENA Plastic-Free Wet Wipes – a sustainable choice for skin cleansing

Better Care For Everyone

tena.co.uk



INCONTINENCE PRODUCTS

TENA HELPS PEOPLE STAY SECURE, DRY AND ODOUR FREE WITH PRODUCTS THAT HELP MANAGE URINARY INCONTINENCE AND BLADDER WEAKNESS, DAY AND NIGHT.

BEST SELLER

TENA SLIP

ALL IN ONE BRIEFS

TENA Proskin Slip with FeelDry Advanced that quickly absorbs liquid away from the surfaces, keeping the skin dry.

Specifically designed to provide triple protection for dryness, softness and leakage security to maintain natural skin health.

- Cotton feel textile back sheet
- ISO 11948-1 (Whole product testing)



JUNIOR	1700MLS	32 PACK	ND-0263
PLUS: SML	2100MLS	30 PACK	ND-1041
PLUS: MDM	2500MLS		ND-1042
PLUS: LRG	2500MLS		ND-1043
PLUS: XL	2899MLS		ND-0264
SUPER: SML	2100MLS	30 PACK	ND-1044
SUPER: MDM	2900MLS		ND-1045
SUPER: LRG	2900MLS	28 PACK	ND-1046
SUPER: XL	3300MLS		ND-0265
MAXI: SML	2500MLS	24 PACK	ND-1047
MAXI: MDM	3300MLS		ND-1048
MAXI: LRG	4100MLS	22 PACK	ND-1049
MAXI: XL	4100MLS	24 PACK	ND-0266
ULTIMA: MDM	4100MLS	21 PACK	ND-1070
ULTIMA: LRG	4900MLS		ND-1071
ULTIMA: XL		18 PACK	ND-0267



Waist Size

XS	40-60cm
S	50-80cm
M	70-110cm
L	100-150cm
XL	120-160cm

TENA SLIP BARIATRIC

A NEW DEFINITION OF COMFORT

Complete leakage security for individuals with hips up to 244cm

- Features a soft textile back-sheet
- Easy to apply reclosable fixation wide hooks enabling multiple re-adjustments
- Breathable Stretch Side panels provide a comfortable fit
- FeelDry™ technology quickly draws liquid away into the core of the pad
- Super absorbent to provide complete leakage protection



Waist Size

XXL	163-178cm
XXXL	175-244cm



XXL	3300MLS	32 PACK	ND-1064
XXXL		8 PACK	ND-0290

TENA COMFORT

TWO-PIECE SYSTEM

TENA ProSkin Comfort with FeelDry Advanced for fast absorption to keep the skin dry.

- Features a unique bowl shape for a close body fit
- Specifically designed to provide triple protection for dryness, softness and leakage security
- Helps to maintain natural skin health
- Designed for use with TENA fixation pants
- ISO 11948-1 (Whole product testing)



NORMAL	53CM	1250MLS	42 PACK	ND-1004
PLUS	64CM	1800MLS	46 PACK	ND-1005
EXTRA	64CM	2100MLS	40 PACK	ND-1006
SUPER	64CM	2500MLS	36 PACK	ND-1007
MAXI	67CM	3300MLS	28 PACK	ND-1008

TENA FIX PANTS

To be used in conjunction with body-worn pads

- Developed to last longer and to hold both shape and elasticity even with frequent laundering
- No side seams, no pressure points, wearers are assured comfort which helps to avoid skin chafing and irritation

XS	50-60CM	5 PACK	ND-1020
SML	60-75CM	5 PACK	ND-1021
MDM	70-90CM	5 PACK	ND-1022
LRG	85-110CM	5 PACK	ND-1023
XLRG	95-125CM	5 PACK	ND-1024
XXL	110-140CM	5 PACK	ND-1025
XXXL	130-180CM	5 PACK	ND-0291



TENA COMFORT MINI

Featuring Odour Control™ Comfort Mini is a slim reliable pad in a range of absorbencies for light incontinence.

- Highly effective inner core for faster fluid acquisition
- Improved absorbency to keep skin dry
- Adhesive strip for enhanced security
- Ultra White Dry System™ leak protection

PLUS	27CM	450MLS	30 PACK	ND-1001
EXTRA	34CM	600MLS	30 PACK	ND-1002
SUPER	43CM	1000MLS	30 PACK	ND-1003



TENA FLEX

BELTED ALL-IN-ONE

Continually working to make caring easier and more effective, the improved TENA ProSkin Flex features two unique design innovations to make product changes faster, easier and more ergonomic.

- Redesigned elastic COMFIStretch™ belt provides a consistently secure, comfortable fit and leakage security
- Smart FingerLift™ helps to get the product ready for application more quickly
- 100% breathable material helps to maintain healthier skin and improves comfort and dignity for individuals
- Requires no additional fixation
- ISO 11948-1 (whole product testing)



NORMAL: MDM	1100MLS	34 PACK	ND-1108
NORMAL: LRG	1300MLS		ND-1109
PLUS: SML	1700MLS	30 PACK	ND-1052
PLUS: MDM	2100MLS		ND-1055
PLUS: LRG	2500MLS		ND-1056
PLUS: XL	2900MLS		ND-1051



Waist Size

MAXI: SML	3300MLS	22 PACK	ND-1054
MAXI: MDM	3300MLS		ND-1060
MAXI: LRG	4100MLS	21 PACK	ND-1061
MAXI: XL	4900MLS		ND-1062

S	61-87cm
M	71-102cm
L	83-120cm
XL	105-153cm

TENA MEN RANGE

ACTIVE FIT PROTECTORS

The anatomically shaped pad follows the contours of the body and is available in three absorbencies.

- 3X protection from leaks, odour and moisture
- Secure Absorption zone that locks leaks efficiently
- Adhesive strip to stay in place in men's underwear
- ISO 11948-1 (whole product testing)



LEVEL 1	23CM	300MLS	24 PACK	ND-1090
LEVEL 2	27CM	600MLS	20 PACK	ND-1091
LEVEL 3	27CM	800MLS	16 PACK	ND-5012

MEN ACTIVE FIT PANTS

Keep an active lifestyle despite urine leaks with TENA Men Active Fit incontinence pants.

- Secure and comfortable fit
- Breathable and flexible soft-stretch
- Stays securely fitted during everyday activities
- Dermatologically tested and kind to skin
- Secure Absorption Zone to lock in leaks efficiently
- Masculine and discreet



Waist Size

S/M	75-105cm
L/XL	95-125cm

ACTIVE PLUS: S/M	1010MLS	9 PACK	ND-0218
ACTIVE PLUS: L/XL		8 PACK	ND-0219
PREMIUM MAXI: S/M	1350MLS	10 PACK	ND-0274
PREMIUM MAXI: L/XL		8 PACK	ND-0275

BEST SELLER**TENA PANTS****PULL-UP UNDERWEAR**

Disposable and absorbent, TENA Pants can be handled just like regular underwear.

- Encourages self-care and independence
- Thin, soft and gently stretch to the shape of the body
- FeelDry™ technology rapidly absorbs even large quantities of urine
- Body-Close Fit™ less bulk and increased discretion
- Outstanding dryness, comfort and healthy skin
- Wetness indicators alert when the pad needs changing
- ISO 11948-1 (Whole product testing)

**Waist Size**

XS	50-70cm
S	65-85cm
M	80-110cm
L	100-135cm
XL	120-160cm

**TENA LIGHTS****FOR LIGHT LEAKS**

TENA Lights are perfectly shaped to fit the body.

- Specially designed for little leaks
- Crystal absorption for freshness
- Absorbent top sheet for instant dryness



LIGHT	15CM	28 PACK	ND-1010
WRAPPED	19CM	22 PACK	ND-1011
NORMAL	19CM	24 PACK	ND-1012
LONG	21CM	20 PACK	ND-1013

DISCREET: MDM	880MLS	12 PACK	ND-1100
NORMAL: SML	1300MLS	15 PACK	ND-1039
NORMAL: MDM		18 PACK	ND-1028
NORMAL: LRG		18 PACK	ND-1029
NORMAL: XL		15 PACK	ND-1068
PLUS: XSML	1700MLS		ND-1030
PLUS: SML		14 PACK	ND-1031
PLUS: MDM			ND-1032
PLUS: LRG		10 PACK	ND-1033
PLUS: XL		12 PACK	ND-1034
SUPER: SML	2100MLS		ND-1035
SUPER: MDM		12 PACK	ND-1036
SUPER: LRG			ND-1037
SUPER: XL			ND-1065
MAXI: MDM	2900MLS		ND-1066
MAXI: LRG		10 PACK	ND-1067
MAXI: XL			ND-1069

TENA SILHOUETTE**ACTIVE FIT UNDERWEAR**

Soft, discreet elastic waistband for a real underwear look. Soft fit fabric and breathable materials

- Comfortable with a real underwear look
- Unique black colour inside and out with 360° coverage for superior discretion and a real underwear look
- Dual leakage barriers - super absorbent core effectively prevents leakage and provides peace of mind.
- Front and back indication showing the right way to put them on.
- Unique leg cuff for a smooth discrete fit

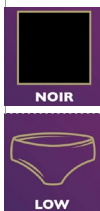

HIGH WAIST			
PLUS: MDM	1010MLS	9 PACK	ND-0216
PLUS: LRG	1300MLS	8 PACK	ND-0217
LOW WAIST			
PLUS: MDM	810MLS	10 PACK	ND-0278
PLUS: LRG	810MLS	9 PACK	ND-0279

**TENA DISCREET****SLIM PADS**

This wide range offers discreet and secure protection for medium to heavy bladder weakness.

- Designed for moderate to heavy bladder weakness
- Soft and anatomically shaped with elasticated sides
- Range of absorbencies from normal to maximum protection
- Dry, secure and provides odour control



MINI PLUS	25CM	240MLS	16 PACK	ND-5001
NORMAL	27.5CM	350MLS	12 PACK	ND-5002
EXTRA	31CM	500MLS	10 PACK	ND-5017
EXTRA PLUS	34CM	600MLS	8 PACK	ND-5018
MAXI	37CM	800MLS	6 PACK	ND-1128
MAXI NIGHT	39CM	914MLS	6 PACK	ND-5019



PROskin

EXPERT CARE FOR ELDERLY SKIN

TENA SHAMPOO & SHOWER

WASH & RINSE GEL

A mild shower gel with gentle conditioning shampoo for delicate skin and hair care.

- Suitable for daily use
- Fragrant gel cleanses the body and conditions the hair.
- Gently rub in and rinse off with water



500ML ND-0551

TENA WASH CREAM

3-IN-1 CLEANSER

TENA 3-in-1 Wash Cream cleanses, restores and protects even the most delicate and fragile skin.

- Ideal for frequent cleansing and incontinence care
- Mild, surfactant free emulsion replaces soap and water
- Gentle on sensitive skin
- Simple to apply and remove
- No need to rinse



150ML ND-0543

500ML ND-0545

1000ML ND-0277

TENA SOFT WIPE

DRY WASH CLOTH

Soft and strong cellulose wipe

- Designed to quickly and gently cleanse the skin
- Highly absorbent
- Dampen with water for ultra-softness and to maintain desired temperature
- Suitable for the whole body

30 X 32CM ND-0555



PACK OF
135

NEW

TENA PLASTIC-FREE WET WIPE

PRE-MOISTENED CLOTH



PACK OF
48

TENA Wet Wipe is pre moistened with a 3-in-1 formula of surfactant-free emulsions.

- Cleanses and restores
- Protects skin with a single wipe
- Suitable for frequent use especially in incontinence care
- Wipe material made from 100% natural fibres to reduce plastic waste

30 X 20CM ND-0563

TENA WASH GLOVE

SAFE HYGIENE



PACK OF
175

The TENA Wash Glove combines the gentleness of a cloth with the convenience of a glove

- Designed for safe personal hygiene
- Suitable for the whole body
- Effective care of fragile skin

25 X 16CM ND-0560

TENA CELLDUK

TISSUE CLOTH



A strong and highly absorbent washcloth designed to quickly and gently cleanse the skin or apply moisturising and protective products.

- Soft towel-like washcloth
- Compatible with soap and water and TENA Wash Cream
- Suitable for bed bath routines

27 X 25CM ND-0557

TENA BED PROTECTION

FLEXIBLE UNDERPAD

This soft, flexible underpad features a new Secure Zone top-sheet and back-sheet for added protection.

- Easier product identification and enhanced product quality
- Available in Plus and Super absorption levels
- Provides leakage security for individual needs



PLUS SML	40 X 60CM	30 PACK	ND-1073
PLUS MDM	60 X 60CM	30 PACK	ND-1074
PLUS LRG	60 X 75CM	25 PACK	ND-1076
PLUS XL	60 X 90CM	30 PACK	ND-1077
SUPER MDM	60 X 60CM	30 PACK	ND-1075
PLUS XL	60 X 90CM	26 PACK	ND-1078

**TENA SHAMPOO CAP**

NO RINSE CLEANSING

Pre-moistened non-rinse shampoo cap, comfortable alternative to washing hair with water.

- Ideal for bedridden, fragile and immobile users
- Warm in a microwave for added comfort

SINGLE ND-0562

**TENA BIB**

DISPOSABLE PROTECTION

Disposable serviette bib with integral front pocket and adjustable neck tie

- Dignified and hygienic protection at meal times
- Cellulose layers absorb fluid
- Plastic film lining protects clothing

37 X 48CM ND-1127





INCONTINENCE PRODUCTS

OUR PRODUCTS ARE LATEX FREE AND FEATURE A COMBINATION OF TECHNOLOGIES TO PROVIDE BOTH COMFORT AND DISCRETION

ATTENDS SOFT

BODY SHAPED PADS

An effective shaped pad for very light to heavy urinary incontinence.

- Absorbent core to help reduce the risk of leakage
- Provides odour protection and skin dryness
- Fixation tape allows the pad to be worn with close fitting underwear for extra discretion and comfort



ACTIVE ZONE



ODOUR PROTECTION



BREATHABLE COVER



QUICK-DRY CORE



0	ULTRA MINI	20.5CM	99MLS	28 PACK	ND-1350
1	MINI	21.5CM	199MLS	20 PACK	ND-1351
2	NORMAL	26.5CM	449MLS	12 PACK	ND-1353
3	EXTRA	32.5CM	599MLS	10 PACK	ND-1349
	EXTRA PLUS	36.5CM	799MLS		ND-1355
4	SUPER	38.5CM	999MLS	46 PACK	ND-1356
5		47.5CM		38 PACK	ND-1357
6	HEAVY	47.5CM	1249MLS	38 PACK	ND-1358
7	HEAVY	47.5CM	1499MLS	34 PACK	ND-1359

BEST SELLER

ATTENDS CONTOURS

DUAL BODY SHAPED PADS

A body shaped pad designed to manage heavy urinary and/or faecal incontinence.

- Absorbent core to help reduce the risk of leakage
- Provides odour protection and skin dryness
- Wetness indicator acts as a guide for pad changes
- Full barrier leg cuff reduces the risk of leaks
- Poly back sheet
- Contours absorbencies 6-10 should be used in combination with Attends fixation pants



TESTED AND APPROVED TO BE SKIN FRIENDLY BY PRODERM, THE INSTITUTE FOR APPLIED DERMATOLOGICAL RESEARCH.



4	REGULAR	39CM	799MLS	42 PACK	ND-1376
5	REGULAR	50CM	1249MLS		ND-1377
6	REGULAR	58CM	1499MLS	35 PACK	ND-1370
7	REGULAR	58CM	1799MLS		ND-1371
8	REGULAR	64.5CM	2499MLS	28 PACK	ND-1372
9	REGULAR	70CM	2899MLS		ND-1373
10	REGULAR	78.5CM	3299MLS	21 PACK	ND-1374

BEST SELLER**ATTENDS SLIP****ALL-IN-ONE PROTECTION**

Designed to manage heavy urinary and/or faecal incontinence.

- Anatomically shaped core for a close comfortable fit
- Four re-sealable fixation tapes for ease of fitting
- A close and comfortable fit to minimise leakages
- Breathable back sheet for improved skin health
- Absorbent core
- Elasticated waistband

ATTENDS SLIP CLASSIC

Suitable for people with restricted mobility

10	MDM	3699MLS	15 PACK	ND-1495
	LRG			ND-1496
	XL			ND-1497

Waist Size

M	80-115cm
L	115-150cm
XL	150-175cm

ATTENDS SLIP REGULAR

Suitable for people with moderate mobility

8	MDM	2099MLS	28 PACK	ND-1396
	LRG			ND-1395
9	XS	1699MLS	32 PACK	ND-1411
	SML	2099MLS	21 PACK	ND-1410
	MDM	2499MLS	28 PACK	ND-1402
LRG	2899MLS	ND-1403		
10	SML	2899MLS	21 PACK	ND-1412
	MDM	3299MLS	26 PACK	ND-1398
	LRG	3699MLS		ND-1397

Waist Size

XS	40-70cm
S	50-85cm
M	75-110cm
L	100-145cm



ACTIVE ZONE



ODOUR PROTECTION



BREATHABLE COVER



QUICK-DRY CORE

**ATTENDS SLIP ACTIVE**

All-in-one products designed to manage heavy urinary and/or faecal incontinence

8	MDM	2099MLS	28 PACK	ND-1381
	LRG			ND-1380
9	MDM	2499MLS	28 PACK	ND-1383
	LRG			2899MLS
10	MDM	3299MLS	28 PACK	ND-1385
	LRG			3699MLS

Waist Size

M	75-110cm
L	100-145cm

To choose the correct size, measure the hips and waist and select the larger of the two measurements.

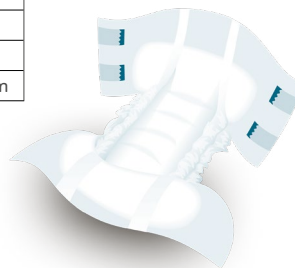

ATTENDS FLEX**ALL-IN-ONE PROTECTION**

Comfortable belted pad for heavy urinary and/or faecal incontinence.

- Flexible fixation system fits snugly around the waist
- Dual core reduces the risk of leakage keeping skin dry
- Provides odour protection and skin dryness
- Breathable textile back sheet for improved skin comfort
- Wetness indicator acts as a guide to when the pad requires changing

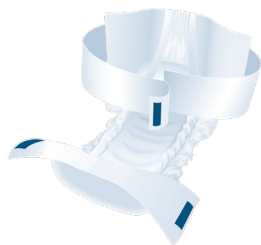
**ACTIVE ZONE****ODOUR PROTECTION****BREATHABLE COVER****QUICK-DRY CORE**

8	SML	1699MLS	28 PACK	ND-1423
	MDM			ND-1424
	LRG	2099MLS		ND-1437
	XL	2499MLS		ND-1425
9	SML	2099MLS	26 PACK	ND-1426
	MDM			ND-1490
	LRG	2499MLS		ND-1427
	XL	3850MLS		ND-1428
10	SML	3850MLS	22 PACK	ND-1429
	MDM			ND-1491
	LRG	3699MLS		ND-1422
	XL			20 PACK ND-1436

Waist Size

S	60-85cm
M	75-105cm
L	85-125cm
XL	100-155cm

To choose the correct size, measure the hips and waist and select the larger of the two measurements.

BEST SELLER**ATTENDS PULL-ONS****FULL BRIEF PANTS**

Absorbent pull-up pants for light to heavy urinary and/or faecal incontinence.

- Flexible shape designed to fit close to the body
- Absorbent core to help reduce the risk of leakage
- Provides odour protection and dryness
- Side panels can be opened for quick and easy removal



4	SML	1299MLS	22 PACK	ND-1323
	MDM			ND-1481
	LRG			ND-1482
	XL			18 PACK ND-1472
6	XXS	1699MLS	18 PACK	ND-1430
	XS			ND-1431
	SML			ND-1483
	MDM			ND-1484
	LRG			ND-1485
8	XL	2099MLS	16 PACK	ND-1435
	SML			ND-1486
	MDM			ND-1487
	LRG			ND-1488
	XL			14 PACK ND-1442
10	MDM	2499MLS	14 PACK	ND-1448-M
	LRG			ND-1448-L
	XL			ND-1448-XL

Waist Size

S	60-85cm
M	75-105cm
L	85-125cm
XL	100-155cm

To choose the correct size, measure the hips and waist and select the larger of the two measurements.

ATTENDS COVER-DRI

SURFACE PROTECTION

Surface protection underpad to protect beds, chairs and wheelchairs.

- Super absorbent core with non-slip waterproof backing
- Skin friendly soft top sheet
- All round leakage barrier

PLUS SML	40 X 60CM		ND-1450
PLUS MDM	60 X 60CM	50 PACK	ND-1451
PLUS LRG	90 X 60CM		ND-1452
PLUS WINGS	80 X 170CM	30 PACK	ND-1453
SUPER MDM	60 X 60CM	50 PACK	ND-1454
SUPER LRG	90 X 60CM		ND-1455



BREATHABLE COVER



QUICK-DRY CORE

**ATTENDS DEOPLUS**

BOOSTER INSERT PAD

For use with a pouch pant for added protection

- Rectangular insert pad
- Suitable for men and women
- Non-woven back sheet allows liquid to pass through to the primary pad when used as a booster

PACK OF
56

39 X 12CM ND-1379

BEST SELLER**ATTENDS STRETCH PANTS**

WASHABLE FIXATION PANTS

Pants for use with shaped pads

- Soft elasticated material for comfort
- Secures pads in place for extra protection
- Keeps pads close to the body to minimise leaks
- Wash up to 25 times



Waist Size

SML		ND-1465	S	40-80cm
MDM		ND-1466	M	70-100cm
LRG	15 PACK	ND-1467	L	90-120cm
XL		ND-1468	XL	110-135cm
XXL		ND-1469	XXL	130-145cm

BEST SELLER**ATTENDS FOR MEN**

DISCREET SHIELDS

Specifically designed for men offering discreet light to moderate protection

- Anatomically shaped for a close comfortable fit
- Noise-free soft breathable back sheet
- Fixation tape secures shield in place and reduces risk of leakage
- Odour protection minimizes the risk of unpleasant odours

LEVEL 1 & 2:
LIGHT

1	199MLS	25 PACK	ND-1362
2	299MLS	16 PACK	ND-1363
3	599MLS		ND-1364
4	799MLS	14 PACK	ND-1361

LEVEL 3 & 4:
MODERATE

MoliCare® PERSONAL HYGIENE

INTRODUCING THE MOLICARE® RANGE OF INCONTINENCE CARE PRODUCTS PROVIDING CONFIDENCE AND SECURITY IN EVERYDAY LIFE

NEW

MOLICARE PREMIUM FORM SHAPED PADS

SHAPED PADS

MoliCare's Premium Form Pads offer day-to-day comfort and security for users, who suffer with slight to severe incontinence.

- Advanced dry zone
- Shaped for a snug fit
- Flexible and fits to underwear
- Use fixation pants for extra security
- Skin friendly pH balanced



MORE SIZES AVAILABLE

3D	LIGHT		ND-1587
5D	MEDIUM	32 PACK	ND-1590
6D	HEAVY		ND-1589

MOLICARE PREMIUM MOBILE PULL-UP PANTS

These unisex pull up pants are ideal for urine and faecal incontinence. The pants feel just like regular underwear, featuring soft materials and elastics for a comfortable fit. The wetness indicator on the backsheet indicates when to change the pants.

- Active Skin Protection
- Absorbent Core • Skin Friendly
- Wetness Indicator • Elastic



MORE SIZES AVAILABLE

8D	SMALL	14 PACK	ND-1548
8D	MEDIUM		ND-1549
10D	MEDIUM	14 PACK	ND-1552
10D	LARGE		ND-1553

MOLICARE PREMIUM LONG LEG FIXPANT

MoliCare Premium Fixpants are unisex washable fixation pants that ensure safe and hygienic fixation of incontinence pads.

- Optimum Security
- Safe and hygienic
- Unisex • Premium Fixation
- Comfortable Fit



MORE SIZES AVAILABLE

MEDIUM		ND-1568
LARGE	5 PACK	ND-1569
X LARGE		ND-1570

MOLICARE PREMIUM ALL-IN-ONE INCO SLIP - ELASTICATED

Elasticated side panels ensure better adaptation to the body's shape and a reduction from 4 to 2 re-closable tapes provides easier application.

- Absorbent Core • Skin Friendly • Elasticated Panels
- Easy Application • Re-Closable Tapes

8D	SMALL	26 PACK	ND-1513
8D	MEDIUM		ND-1514
9D	SMALL	26 PACK	ND-1517
9D	MEDIUM		ND-1518

MORE SIZES AVAILABLE





PROTECTIVE PRODUCTS

EXPERTS IN ABSORBENT PRODUCTS FOR URINARY INCONTINENCE WITH A HIGH ABSORPTION CAPACITY



LATEX FREE

INDAS BED PAD

A single-use underpad for bedridden, incontinent or wheelchair-bound patients.

- Keeps moisture away from the skin, reducing the risk of dermatitis and ulceration.
- Prevents ulceration by reducing the pressure exerted by the body.
- Offers protection for bedridden or wheelchair-bound patients.
- Latex free

60 X 90CM		ND-1700
60 X 60CM	25 PACK	ND-1702
80 X 180CM		ND-1718



INDASEC SHAPED PADS

Indasec® shaped pads are ideal for mild to moderate incontinence, effectively neutralising odour and providing comfort.

- Super absorbent particles provide greater urine retention
- Breathable textile touch outer cover
- Adapts perfectly to underwear

MINI	80ML	20 PACK	ND-1712
NORMAL	150ML	24 PACK	ND-1714
EXTRA	350ML	20 PACK	ND-1710
MAXI	600ML	15 PACK	ND-1705
MENS	300ML	10 PACK	ND-1713



ALOE VERA

INDASFORM SHAPED PAD

IndasForm offers a shaped pad with extracts of aloe vera providing comfortable, odour-neutralising protection for heavier incontinence.

- Swiftzone system for fast diffusion and absorption
- Effectively keeps skin dry reducing ammonium
- Anatomical shape fits closely to the body

6 BLUE	1000ML		ND-1707
7 YELLOW	1500ML	20 PACK	ND-1701
8 GREEN	1800ML		ND-1704
9 PURPLE	2100ML		ND-1706



LATEX FREE

INDASLIP PREMIUM ALL IN ONE

Indaslip all-in-one premium protection fits securely to the body for severe incontinence. Anatomically shaped with a soft and flexible waist for comfort.

- Breathable soft textile fabric
- Super absorbent core and retention
- Odour-neutralising properties
- Latex free

L10+	2800ML		ND-1709
L9	2000ML	20 PACK	ND-1703
M10	2500ML		ND-1711
M9	2000ML		ND-1708

PROTECTIVE PADS

A RANGE OF PADS TO ALLEVIATE PRESSURE PAIN, ADD LEAK PROTECTION PREVENTING STAINS AND ODOURS

PRESSURE PADS

KIND TO SKIN

Help to eliminate potential pressure points. Offering a smooth surface for skin to rest.

- Less deterioration
- No pilling
- Minimal shrinkage
- Thin profile
- Size 88 x 88cm



SINGLE ND-6817

CHAIR PADS

EVERYDAY PROTECTION

Simple chair covering for added protection

- Resistant to stains
- Wash up to 95°C
- Tumble dry (medium heat)
- 45 x 57cm



SINGLE ND-0960

LUXURY CHAIR & FLOOR PADS

NON-SLIP & HARDWEARING

Quality pads offering comfort and safety to users

- Absorbent inner layer
- Non-slip backing
- Snag resistant smooth top surface
- Washable up to 95°C
- Tumble dry on medium heat
- Guaranteed up to 300 washes



CHAIR PAD

- Available in multiple colours
- Smooth polyester
- Size 53 x 56cm

GREEN	ND-3593-GR
BROWN	ND-3593-BR
BLUE	ND-3593-BL
MAROON	ND-3593-MAR

FLOOR PAD

- Size 90 x 132cm

MAROON ND-3599-MA

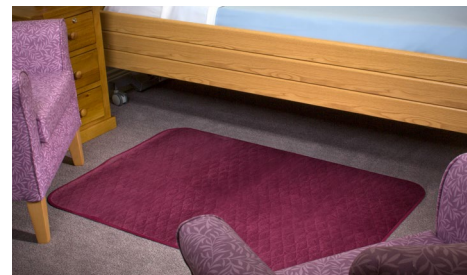

WASHABLE BED PAD

HIGHLY ABSORBENT

- Excellent wicking
- Resistant to stains
- Wash up to 95°C
- Guaranteed up to 300 washes
- Can be tumble dried

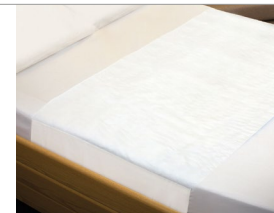

S	70 x 85cm
L	86 x 89cm
XL	86 - 114cm

SML + WINGS	ND-6813
LRG + WINGS	ND-6807
SML	ND-6812
LRG	ND-6806
XL	ND-6808

INCONTINENCE DISPOSAL UNIT

DISCREET SAFE DISPOSAL

A unique product designed to deal with the disposal of incontinence products discreetly and without fuss.

- Powered by Sengenec for guaranteed odour and germ protection
- Pads are individually wrapped in multi-layer anti-bacterial film to stop germs and smells escaping
- Anti-bacterial film kills 99% of dangerous germs like e-coli and Staphylococcus Aureus
- Holds up to 30 pads* meaning fewer trips to the outside bin
- Inbuilt plunger pushes waste deep into the bin, keeping your hands clean
- Flat lid opens against any wall. Slimline and compact, fits into any room

UNIT	ND-6891
UNIT + 6 CASSETTES	ND-6890
SINGLE CASSETTE REFILL	ND-6892



VINYL PULL ON PANTS

Fluid-proof briefs for discreet dependable protection

- Medical grade soft vinyl
- Comfortable and discreet
- Unique spill-block technology
- Available in sizes S to XXL
- 3 per pack

SML	ND-6840-SM
MDM	ND-6840-ME
LRG	ND-6840-LG
XL	ND-6840-XL
XXL	ND-6840-XXL



SERENITY NO RINSE CLEANSING FOAM

QUICK & EFFECTIVE CLEANSING WITHOUT THE NEED TO RINSE

- No silicone
- With Chamomile and Panthenol to prevent and calm irritations
- Dermatologically tested
- Paraben free
- No colorants

400ML **ND-0605**



Kylie® WASHABLE BED PADS

- Stay-dry surface wicks away moisture
- Washable up to 300 times at 95°
- Tuck-in flaps for a secure fit
- Waterproof backing
- 3Ltr capacity
- Available in blue or pink
- Size 91 x 91cm

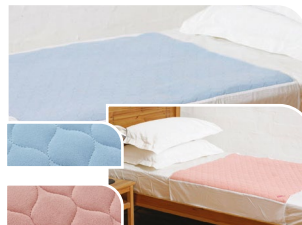

PINK	ND-6833-PI
BLUE	ND-6833-BL

DISPOSABLE BED PADS

Disposable pads suitable for the protection of beds and chairs.

- 5 ply Cellulose
- Sealed on all sides
- White polythene backing



57 X 75CM **ND-0950**

READI DOUBLE BED PAD

- Soft and gentle to the skin
- Superior high absorbency
- Keeps the user dryer for longer
- Waterproof backing to prevent leakage
- Cost effective and value for money



60 X 60 CM	ND-0997
60 X 90CM	ND-0999

M E D I C A L C O N S U M A B L E S

MEDICAL & FIRST AID

From wound care to specialist medical products, helping to support everyday nursing needs.

- Sterile Dressings
- Syringes & Needles
- Masks & Resuscitators
- Spill Kits & First Aid
- Trays & Bed Pans



TUBULAR BANDAGE STEROGAUZ

SIZE
20M



FINGERS & TOES	TA-0298
LARGE FINGERS	TA-0299
SMALL LIMBS	TA-3552
MEDIUM LIMBS	TA-0302

DRESSING RETENTION TAPE

- Fixes dressings to the skin with hypo-allergenic adhesive
- Non-woven polyester fabric tape, soft, pliable & porous
- Conforms readily to all areas of the body
- Permeable to air and water vapour
- Can be cut to required size

SIZE
10M



PACK OF 4: 2.5CM	TE-3330
PACK OF 2: 5CM	TE-3324
EACH : 10CM	TE-3325

CREPE BANDAGE

SIZE
4.5M



5CM	TA-0243
7.5CM	TA-0244
10CM	TA-0245
15CM	TA-0246

TRANSPORE TAPE **BEST SELLER**

Vinyl hypo-allergenic adhesive surgical tape.

SIZE
9.14M



1.25CM	TE-0300
2.5CM	TE-0301
5CM	TE-0302

CONFORMING / RETENTION BANDAGE

Contour bandage for all types of dressings



SIZE
4M



6CM	TA-0265
8CM	TA-0266
10CM	TA-0267
12CM	TA-0268

TRIANGULAR BANDAGE

- Non-woven
- Individually wrapped



90 X 90 X 127CM	TA-0269
-----------------	---------

DRESSING RETENTION SHEET

- For securing dressings
- Strong, low allergy adhesive
- Great for under taping



SIZE
10M

5CM	KE-2178
10CM	KE-2177

STERILE MEDIUM FINGER DRESSING



3.5 X 3.5CM	TF-0331
-------------	----------------

TOPPER 8 STERILE NON-WOVEN SWABS



5 X 5CM	PACK OF 100	TF-0394
7.5 X 7.5CM	25 PACKS OF 5	TF-0395
10 X 10CM	40 PACKS OF 5	TF-0396

NON-STERILE SWABS



100
PACK

10 X 10CM	TF-0388
-----------	----------------

MICROPOROUS TAPE

- High quality tape for a variety of uses



SIZE
10M

1.25CM	TE-0315
2.5CM	TE-0316
5CM	TE-0317

8 PLY NON-STERILE GAUZE SWABS



100
PACK

5 X 5CM	TF-0392
10 X 10CM	TF-0393

ADVAPORE STERILE WOUND DRESSING

Hypoallergenic adhesive dressing



50
PACK

6 X 7CM	TF-0341
10 X 10CM	TF-0339
10 X 15CM	TF-0340

STERILE LOW ADHERENT DRESSING

Absorbent dressing



100
PACK



5 X 5CM	TF-0362
7.5 X 7.5CM	TF-0355
10 X 10CM	TF-0356

STERILE SURGIPAD



25
PACK

20 X 20CM	TF-3062
-----------	----------------

STERILE NON-WOVEN EYE PAD



50
PACK

8 X 6CM	TF-0424
---------	----------------

DERMATOLOGICAL GLOVES

Light and comfortable, provides protective cover for minor wounds and abrasions.



MEDIUM PAIR	TK-0439
-------------	----------------

DRESSING PACKS

PACK WITH FORCEPS

- Tray with 2 integral gallipots
- 3 swabs 7.5cm
- 3 cotton wool balls large
- 55x55cm sterile field
- Yellow bag
- 2 forceps



TG-0306

PROCEDURE EYE CARE PACK

- 1 paper green tissue
- 2 60ML gallipot
- 5 non woven cotton balls
- 1 hand towel
- 1 tray

TG-0314

WOUND CARE PACKS

PACK CONTAINS:

- 5 non woven swabs - 7.5x7.5cm 4 ply
- 1 paper towel • 1 orange bag
- 1 Tray • Pair of nitrile gloves
- Sterile field



BEST SELLER

TG-0426

COMMUNITY WOUND CARE PACK - LARGE (NITRILE):

Pack contains:

- 100 White Bags
- 200 Blue Nitrile Gloves
- 100 Paper Tissues
- 500 Non woven Swabs
- 100 Triangular Gallipots
- 100 White Aprons
- 100 15cm Tape Measures
- 7 Web Base Nylon 612mm
- 7 Web Top Paper 595mm



TG-0424

BASIC DRESSING PACK WITHOUT FORCEPS

- 5 non-woven swabs 10 x 10cm
- 1 60ml gallipot
- 1 towel dressing 43 x 38cm
- 1 azowrap plain white paper 50 x 50cm sterile field



TG-0305

SUTURE REMOVAL PACK

PACK CONTAINS

- 3 non-woven swabs 5cm
- 1 suture forceps
- 1 stitch cutter
- 1 sterile field 30x30cm
- Yellow disposable bag



TG-0309

NURSING SCISSORS

1	KE-6273	BLUNT/BLUNT
2	KE-0669	BLUNT/SHARP
3	KE-0670	SHARP/SHARP
4	KE-3104	PLASTIC HANDLE BLUNT/BLUNT
5	KE-0699	PLASTIC HANDLE SHARP/SHARP



CATHETERISATION PACK

- PACK CONTAINS:
- Pulp kidney dish
 - 3 non-woven swabs 10cm
 - 60ml gallipot
 - 8 large cotton wool balls
 - 50x60cm paper sheet
 - 55x55cm sterile field



DRESSING FORCEPS



KE-0665

MIXED SIZE SAFETY PINS



KE-6277

80
PACK

EYE PAD UNMEDICATED DRESSING



TF-6273

EMERGENCY BLANKET



KM-6516

TG-0304

2.2CM SPOT PLASTERS WATERPROOF



TF-0326

100
PACK

7.2 X 2.5CM PLASTERS

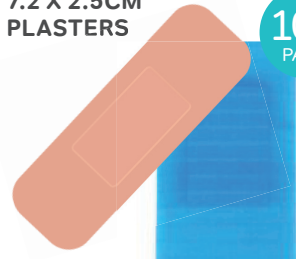

WATERPROOF TF-0503

BLUE DETECTABLE TF-0505

100
PACK

ASSORTED PLASTERS



WATERPROOF TF-0327

FABRIC TF-0318

BLUE DETECTABLE TF-0328

100
PACK

FINGER TIP PLASTERS

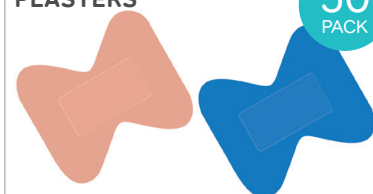

WATERPROOF TF-0325

FABRIC TF-0333

BLUE DETECTABLE TF-0319

50
PACK

ORAL HYGIENE PACK WITH SWABS

BEST SELLER

- Tray with 2 integral gallipots
- 2 non-woven swabs 7.5cm
- 10 oral foam swabs
- 1 tongue depressor
- Yellow resealable bag
- Red tie wrap for bag



TG-0425

1	TG-0575	MC6 Mouth Hydrator	20 PACK
2	TG-0572	MC3 Night Yellow Cleanser	25 PACK
3	TG-0570	MC3 Moutheze Mouth Cleanser	25 PACK

ORAL HYGIENE PACK

- Tray with 2 integral gallipots
- Orange resealable bag



TG-0470

LARGE STERILE COTTON WOOL BALLS

40 packs of 5 sterile balls



TF-0431

GLYCERINE ORAL SWABSTICKS

Sugar free glycerine swabsticks available in lemon or blackcurrant flavour for oral refreshment.

- Foil wrapped in packs of 3 swabsticks
- Soft tip



LEMON	TG-2135-BOX
BLACKCURRANT	TG-2136-BOX

PACK OF **25**
X3 SWABS

FOAM ORAL SWABS

Soft foam tips



5
PACK

TG-0579

TONGUE DEPRESSOR



25
PACK

TG-0574

STERILE GALLIPOT

- Individually wrapped
- Hygienic
- 60ML



TJ-0304

LARGE COTTON WOOL BALLS - BP

200
PACK



TF-0404

MEDICAL TISSUES



BOX OF **70**

SA-0780

DETTOL LIQUID



500ML **KJ-2095**

NORMASOL SACHETS

Normasol is used for topical irrigation of wounds, burns and eyes.
25ml Sachets



25
PACK

25 PACK **LC-3221**

SKIN CLOSURES



- Wound closure strips
- Sutures cutanes adhesives
- Wundverschlussklebe
- Sutures cutaneas
- Nastri adesivi per sutura cutanea
- Cusate heurísticas



3 X 75MM 50 PACK **TF-0346**
6 X 75MM 30 PACK **TF-0348**

STERILE DRESSINGS



12 X 12CM **TF-6271**
18 X 18CM **TF-6270**
28 X 18CM **TF-6274**

NON-WOVEN DRESSING WITH WINDOW CANNULA

7.5 x 6cm



50
PACK

TF-0332

INSTANT ICE PACK

BEST SELLER

- Simple and quick
- On the spot cold therapy
- No need for precooling
- Single use, disposable



KN-6429

ALCOHOL FREE WIPES

INDIVIDUAL STERILE SACHETS
Wound cleansing wipe



100
PACK

NE-6349

STERILE EYE WASH PODS

- Individual pods means minimum waste
- Can be directed to affected area of eye or wound



25
PACK

20ML **LC-3224**

EYE WASH STATIONS



Wall Mounted Eye Wash Station

- Integrated mirror
- 2x 500ml eye wash solution
- 2x eye pads

LC-3227



Eye Wash Station

- Integrated mirror
- 10x 20ml saline pods
- 2x eye pads

LC-3220



Sterile Eye Wash

- 500ml

LC-3225

DRY-UP DISPOSABLE SPILL PAD

The multi-layered pad absorbs liquids in seconds and bonds it into the pad by converting it into a gelled substance. The triple-layer construction replaces traditional absorbent procedures which require chemicals or powders, wait time, broom/brush, and dust pan or bagging.

This product is ideal for safely and quickly removing slip risk liquid spills from hard surfaces such as blood in hospitals, oils in kitchens, restaurants and garages, and urine in care homes. It replaces the traditional and time consuming methods.

KN-6470

10
PACK



CLINELL SPILL WIPE KIT

BEST SELLER

- Simple, quick and highly effective
- Proven to kill all known microorganisms associated with blood, urine and faecal spills.
- Incredibly stable formula, no toxic fumes makes it safe to use in patient areas
- Super absorbent pad generates peracetic acid and hydrogen peroxide
- Easy and safe disposal of soiled wipes - packaging is designed
- so that all items, including the protective clothing worn by the user, can be disposed of in the resealable bag and placed into clinical waste disposal

EACH KIT CONTAINS

- 1 x Spill wipe
- 2 x Disinfectant wipes

KN-6458



KILLS

Hepatitis B & C, HIV, Clostridium difficile, Norovirus and many more.

Infection control made clean, quick and easy

OXIVIR SPILL KIT

COMPLETE KIT FOR EFFECTIVELY DEALING WITH BODY SPILLAGES

- Safe for use on both hard and soft surfaces
- Helps clean spills quickly, safely and effectively

KIT CONTAINS: disposable nitrile gloves, disposable face mask, disposable plastic scraper, disposable bio-hazard bag, oxivir plus 750ml spray bottle, absorbent granules, disposable paper towels, disposable apron, disposable foot gloves.

REFILL CONTAINS: Disposable nitrile gloves, Disposable face mask, Disposable plastic scraper, Disposable bio-hazard bag, Absorbent granules, Disposable paper towels, Disposable apron and Disposable foot gloves.

PLEASE NOTE REPLACEMENT BOTTLE IS NOT INCLUDED IN REFILL KIT



FULL KIT HC-3715

REFILL HC-3712

BIOHAZARD BODILY FLUIDS SPILL KIT

Designed to cover all types of Biohazard and Body Fluid Spills. Small compact design allows portability and storage anywhere to ensure easy accessibility.

- Used for safe clean up and disinfection of blood, urine and vomit
- The single use pack is supplied with all the required PPE and instructions
- Granules absorb the spill, kill pathogens on contact and reduce cross contamination risk

EACH KIT CONTAINS

- 1x Hard sided, lightweight case
- 2x Blood / Biohazard Spill Packs nitrile gloves, apron, scoop & scraper, clinical waste bag, paper towels, absorbing granules and chlorine tablets
- 2x Urine & Vomit Spill Packs nitrile gloves, apron, scoop & scraper, clinical waste bag, absorbing granules and disinfectant surface wipes

HC-3729



SINGLE USE PACKS

These small packs makes it easy to keep ready for use in all areas and ensure accessibility where it may be needed.

The one use pack format prevents fragmentation of components and ensures all items are present when required and opened.

URINE & VOMIT SPILL PACK

HC-3729-UV



BLOOD SPILL PACK

HC-3729-BL



POLYTHENE OVERSHOES



LA-0205

100
PACK

POLYTHENE OVERSLEEVES



LA-0207

100
PACK

PLEATED FACE MASK

Disposable Fluid Resistant Face Masks (Type 11R)



KE-3155

50
PACK

ID WRITE ON BRACELET



KN-3165

100
PACK

BURN CARE KITS

Product may vary slightly from image shown



KN-6426 KN-6432

CONTENTS OF BURN CARE KIT	Qty	Qty
Burnshield burn dressings 20cm x 20cm	2	1
Burnshield burn dressings 10cm x 10cm	2	2
Burnshield blott sachets	16	12
Sterowash 20ml eyewash pods	5	5
Crepe bandage – 10cm x 5m	1	0
Conforming bandage – 7.5cm x 4m	2	0
Vinyl gloves (pair)	2	0
Nitrile gloves (pair)	0	2
Microporous tape – 2.5cm x 5m	1	1
Scissors (pair)	1	1
Steroply 7.5cm x 4m	0	2
Burnshield digit dressing 2.5cm x 50cm	0	1

FIRECHIEF 1 X 1M - FIRE BLANKET

- SOFT CASE
- Red screen-printed soft PVC pack
 - Kitemark certified to BS EN 1869
 - K40 Blanket - weaved twill cloth

FC-0100



RIGID CASE

- Red durable single-piece moulded design
- Kitemark certified to BS EN 1869
- K40 Blanket - weaved twill cloth
- Large label design

FC-0101



BURN GEL



10 X 10CM KN-6420
20 X 20CM KN-6421

ACCIDENT BOOK



RC-3560

STERILE STEROBURN BAG

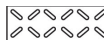

STEROBURN

A sterile bag to cover and protect a badly burnt hand or foot. Put sterile water or saline in the bag if required.

Steroplast®



BURN BAG

⊗ SINGLE USE ⚠ STORE IN A COOL DRY PLACE ⚠ DO NOT USE IF PACKAGING IS DAMAGED

Steroplast Healthcare Ltd,
Alpha Point, Bradnor Road, Manchester M22 4TE U.K.
Email: sales@steroplast.co.uk www.steroplast.co.uk

CE 0120



LOT

Ⓜ

STERILE

R

REF: 8224

KN-6431

BS-8599 WORKPLACE FIRST AID KIT

BEST SELLER



Each Pack Contains	SML	MDM	LRG
Burn Dressing 10x10	1	2	2
Cleansing wipes	20	30	40
Conforming bandage	1	2	2
Finger dressing	2	3	4
Foil blanket	1	2	3
Gloves nitrile (pair)	6	9	12
Guidance note	1	1	1
HSE eyepad dressing	2	3	4
HSE large dressing	1	2	2
HSE medium dressing	4	6	8
Microporous tape	1	1	1
Plasters assorted	40	60	100
Resuscitation Aid	1	1	2
Scissors tuffcut	1	1	1
Triangular bandage	2	3	4

SMALL	KN-6000	MEDIUM	KN-6001	LARGE	KN-6002
-------	----------------	--------	----------------	-------	----------------

BS-8599 CATERING FIRST AID KIT

Ideal for any catering business or general food preparation areas:

- Burn Dressing 10x10 • Cleansing wipes
- Conforming bandage • Finger dressing
- Foil blanket • Gloves, nitrile (pair)
- Guidance note • HSE eyepad dressing
- HSE large dressing • HSE medium dressing
- Microporous tape • Plasters assorted
- Resuscitation Aid • Scissors tuffcut
- Triangular bandage



SMALL KIT	KN-6008	MEDIUM KIT	KN-6009
SMALL REFILL	KN-6010	MEDIUM REFILL	KN-6011

BS-8599 WORKPLACE FIRST AID REFILL PACKS



SMALL REFILL	KN-6004
MEDIUM REFILL	KN-6005
LARGE REFILL	KN-6006

WALL HANGING BRACKET

Fits all our First Aid and Burn Care Kits



KN-3747

ASTROPLAST FIRST AID KIT

Includes dividers



KN-6013-M

BS-8599 TRAVEL FIRST AID



KN-6003

STERILE SYRINGES



MEDICINA SYRINGE

1ML LUER SLIP - 100 PACK	KF-0421
3ML CONC LUER SLIP - 100 PACK	KF-3552
5ML CONC LUER SLIP - 100 PACK	KF-3553
10ML CONC LUER SLIP -100 PACK	KF-3554
5ML LUER LOCK IV - 100 PACK	KF-0563
20ML LUER LOCK - 50 PACK	KF-3555

BD PLASTIPAK®

2ML CONC LUER SLIP - 100 PACK	KF-3539
5ML CONC LUER SLIP - 100 PACK	KF-3538
10ML ECC. LUER SLIP - 100 PACK	KF-3536
BD SYRINGE 10ML LUER LOCK - 100 PACK	KF-3535
BD SYRINGE 20ML LUER LOCK - 120 PACK	KF-3533
30ML LUER LOCK - 60 PACK	KF-3531
50ML CATHETER - 1 PACK	KF-3537

TERUMO SYRINGES

1ML CONC LUER SLIP - 100 PACK	KF-0482
5ML CONC LUER SLIP - 100 PACK	KF-0489
10ML LUER SLIP - 100 PACK	KF-0510
20ML ECC. LUER SLIP - 50 PACK	KF-0491
30ML LUER LOCK - 25 PACK	KF-0475
50ML LUER LOCK - 1 PACK	KF-0485
50ML CATHETER - 1 PACK	KF-0486



Ecc. Luer Slip



Catheter Tip



Conc Luer Slip



Luer Lock

ORAL TIP SYRINGE

- Individually packaged
- Reusable/Washable
- Smooth oral tip connector
- Clear measurement markings
- Purple

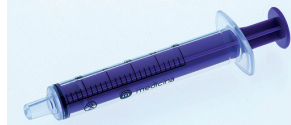

1ML PURPLE PLUNGER - 100 PACK	KF-3452
5ML PURPLE PLUNGER - 100 PACK	KF-3451
10ML PURPLE PLUNGER - 100 PACK	KF-3453
20ML PURPLE PLUNGER - 80 PACK	KF-3454

SOL-CARE™ - SAFETY NEEDLE

A needle based safety device that helps you easily convert from non-safety to safety, protecting healthcare workers from exposed needlestick injuries.



18G X 1½"	KF-3405
21G X 1½"	KF-3406
23G X 1½"	KF-3407
25G X 1½"	KF-3408

SOL-CARE™ - BLUNT FILL NEEDLE



No Filter

18G X 1½"	KF-3425
18G X 2"	KF-3426



5 Micron Filter

18G X 1½"	KF-3427
-----------	----------------

BD BLUNT FILL NEEDLES

- Rapid filling to cope with viscous medications
- 1.2mm x 40mm



18G	KF-3562
-----	----------------

HYPODERMIC NEEDLES STERILE

BEST SELLER

**100
PACK**

19G X 1.5"	KF-0466
21G X 1.5"	KF-0468
23G X 1.25"	KF-0470
25G X 5/8"	KF-0469



HYPODERMIC SAFETY NEEDLE - BD ECLIPSE STERILE WITH SMARTSLIP TECHNOLOGY



**100
PACK**

18G X 1.5"	KF-3551
21G X 1.5"	KF-3550
23G X 1.25"	KF-3548
25G X 5/8"	KF-3549

PRE-INJECTION SWAB

- 70% Isopropyl Alcohol (IPA)
- Cleanses and disinfects skin
- Saves time and costs – no waste
- 100 individually wrapped swabs per pack

**100
PACK**



KF-0977

TOURNIQUET - SINGLE USE

- Latex Free
- Single use



KE-3102

TOURNIQUET - REUSABLE



- Quick release
- Reusable

KE-3100

**BE SAFE - COMPLY WITH THE EUROPEAN
DIRECTIVE 2010 / EU 'PREVENTION OF
NEEDLE STICK INJURIES'**

TERUMO® SURFLO® WINGED INFUSION SET - STERILE

30CM TUBING



19G	KB-0618
21G	KB-0622
23G	KB-0620

TERUMO® SURSHIELD® SAFETY WINGED INFUSION SET - STERILE

30CM TUBING

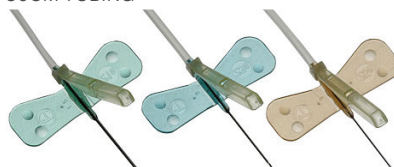

21G	KF-3557
23G	KF-3558
25G	KF-3559

TERUMO® SURSHIELD® SAFETY WINGED INFUSION SET - STERILE

BEST SELLER

The 30cm Infusion set can be used with Venisystem Extension set (70cm KB-0702) to offer an alternative syringe driver infusion set.



25G 30CM TUBING	KB-0700
-----------------	---------

VENISYSTEM - NARROWBORE IV EXTENSION SET

Venisystem can be used with the 30cm short butterfly (KB-0700) to offer an alternative syringe driver infusion set. 100cm.



KB-0702

SAF-T-INTIMA™ IV CLOSED CATHETER BD



With Y adaptor (KB-0711)

24G	KB-0710
24G WITH Y ADAPTOR	KB-0711

FLO-GARD™ - ADMINISTRATION SOLUTION SET



KA-0645

ADMINISTRATION SOLUTION SET FOR GRAVITY (WITH MOBILE LUER LOCK)



KA-0644

BE SAFE - COMPLY WITH THE EUROPEAN DIRECTIVE 2010 / EU 'PREVENTION OF NEEDLE STICK INJURIES'

BD BLOOD VACUTAINER® - SAFETYLOK™ BLOOD COLLECTION SETS

LUER ADAPTER - 178MM TUBING

50
PACK



21G	KF-3540
23G	KF-3541

Safetylok™ can significantly reduce the risk of needlestick injury

BD MICROTAINER®

CONTACT-ACTIVATED LANCET

Safety lancet needle activates only when pressed against the skin. 1.8mm depth.



200
PACK

21G	KF-0501
-----	---------

ENTERAL SYRINGE



1	KF-0442	60ML FEMALE LUER
2	KF-0443	60ML CATHETER TIP

BD BLOOD VACUTAINER® - ECLIPSE™ BLOOD COLLECTION NEEDLE

TRUE SINGLE-HANDED SAFETY ACTIVATION

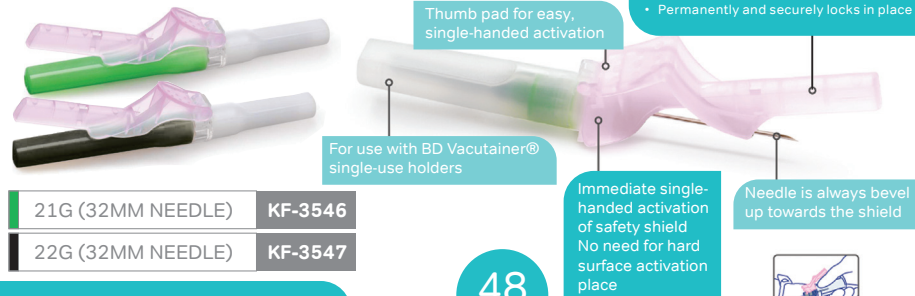

Thumb pad for easy, single-handed activation

For use with BD Vacutainer® single-use holders

Safety shield

- An integral part of the device
- Completely covers the needle
- Permanently and securely locks in place

Immediate single-handed activation of safety shield. No need for hard surface activation place

Needle is always bevel up towards the shield



21G (32MM NEEDLE)	KF-3546
22G (32MM NEEDLE)	KF-3547

Eclipse™ can significantly reduce the risk of needlestick injury

48
PACK

BD VACUTAINER® SINGLE USE HOLDER

200
PACK



For use with multi sample needles
* featured with the Eclipse Blood Collection Needle left. White, one size.

KF-3542

BE SAFE - COMPLY WITH THE EUROPEAN DIRECTIVE 2010 / EU 'PREVENTION OF NEEDLE STICK INJURIES'

SUCTION CONNECTING TUBE

STERILE

Disposable female/male complete with spare male adaptor.



26CH X 2M

KM-0696

STERILE SUCTION CATHETERS



LATERAL & TERMINAL EYE - 48cm

10FG KM-2142

12FG KM-2143

14FG KM-2144

16FG KM-2145



MULLY-TIP WITH VACUUM CONTROL

10FG KM-0687

12FG KM-0688

14FG KM-0689

CATHETER CONNECTOR

STERILE



KE-2119

NASAL CANNULA - SOFT

Clear, lightweight adult cannula made with the Salter-Style® manufacturing process. Soft, seamless and comfortable to wear



KN-0645

SUCTION BUBBLE TUBE

NON-STERILE

Conductive Strip in 30 metre roll ready to cut to length required.



5MM KM-3555

7MM KM-3553

CONNECTING OXYGEN TUBE

NON-STERILE
1.8m



KM-0678

YANKAUER SUCTION TUBE

18FG STERILE



WITHOUT CONTROL KM-0698

WITH CONTROL KM-0699

SILICONE TUBING

For use with 3A Aspeed & OB2012 Aspirator. 2 metre



KE-2144

SUCTION TUBING SET

STERILE

Replacement set of tubing for your suction machine comprising of a Connecting Tube and a Yankauer Handle with control.



KE-7507

NEBULISER SET

EACH SET INCLUDES:

- 1 x Drive Line Tubing
- 1 x Adult Face Mask
- 1 x Medication Chamber

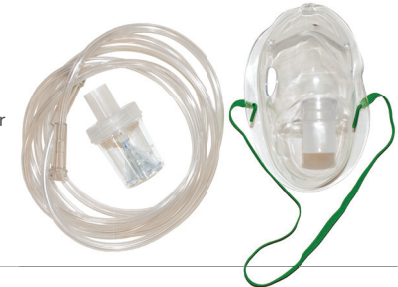

KM-0656

TRACHEOSTOMY MASK

For tracheostomy and laryngectomy aerosol therapy. Tubing connector swivels 360 degrees and accepts 22mm I.D. corrugated tubing.



22MM

KM-0655

BEST SELLER

NEBULISER SET

FOR TRACHEOSTOMY MASK

- Nebuliser
- Mouth piece
- Tee
- Tubing



KM-0670

HUDSON FACEMASK

CLEAR, SOFT VINYL FOR PATIENT COMFORT AND VISUAL PATIENT ASSESSMENT.

- Adjustable nose clip assures comfortable fit
- Medium concentration-elongated
- Complete with 2.1m oxygen supply tubing

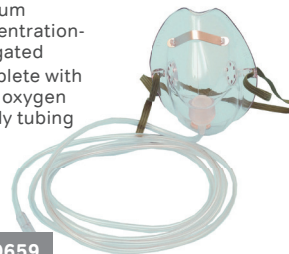

KM-0659

SINGLE USE RESUSCITATOR

- Single patient use
- BVM (Adult - without PRV)
- No risk of patient cross contamination
- Made from textured vinyl for superior grip
- 100% latex free



KM-3014

CPR FACEMASK

The E-Mask has a one way valve and directional diaphragm, which allows no backflow of air or contaminants from patient to user.

- Clear plastic, designed to fit adult or child
- Flexible dome folds into pocket sized case
- Allows inspection through clear mask
- Standard 22mm fittings, can be used with bag and mask resuscitator
- Soft inflated cuff
- Compact carrying case
- Comes with O2 port and headstrap as standard



KM-3222

GUEDAL AIRWAYS



STERILE

1	KM-2181
2	KM-2182
3	KM-2183
4	KM-2185

RESCUE AID MOUTH SHIELD

With one way valve.

Mouth Shield in Key Ring Pouch



KM-3479

REVIVE AID SHIELD

WITH KEYRING POUCH

Comes complete with a one way valve and assists in minimising the risk of cross infection when administering mouth to mouth.



TF-0357

1LTR AUTOCLAVABLE JUG

- Heavy duty
- Stackable
- Graduated



TJ-6198

MEDICINE SPOONS

5ml



100
PACK

KN-3195

MEDICINE POT

28ml



250
PACK

KN-0719

KIDNEY DISH

25 x 13 x
5.5cm



TJ-0725

MEDICINE MEASURES

75
PACK



30ML - 75 PACK

KN-0715

100
PACK



60ML - 100 PACK

KN-0714

**REUSABLE
INSTRUMENT TRAYS**

1	TJ-3028	18 X 13 X 5CM
2	TJ-3037	27 X 15 X 3CM
3	TJ-3617	30 X 25 X 5CM



VOMIT BOWL W/HANDLE

30 x 14 x 6.5cm



TJ-6197

**1 LTR MALE
URINAL WITH
HANDLE &
LID**



KH-0709

**FEMALE
CYGNET
URINAL**



EB-3257

**TOPPER
MALE
URINAL**



KH-6154

**SLIPPER
BED PAN**



KH-3517

**VECTOR
BEDPAN
& LID**



KH-2195

PULP URINAL

800ml



100
PACK

KN-0732

**PULP BED
PAN LINER**

2 Ltr



100
PACK

KN-0729

**PULP COMMODE
PAN LINER**

1.7 Ltr



200
PACK

KN-0730

**PULP KIDNEY
DISH**

700 ml



300
PACK

KN-0737

PULP BOWL

1 Ltr



200
PACK

KN-0736

BED PAN & URINAL BOTTLE HOLDER

Designed to conveniently store up to 6 bed pans & 6 bottles

- Wall mountable
- Steel frame
- Hard wearing nylon coating
- Suitable for Care homes/Hospitals

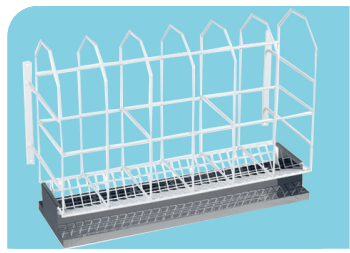

HOLDER	EC-6526
DRIP TRAY	EC-6526-TRAY

URINE BAG HOLDERS



HOLDER FOR BED **KH-3015**

FLOOR STANDING HOLDER

- Suits all 2 litre drainage bags
- Dual purpose - Self standing or as a bedside hanger



KH-3046

VERNAGEL GELLING POWDER

An absorbent powder for the prevention of spillages. For safe transportation of liquid clinical waste. Absorbs body fluids and converts them to a firm non-spill gel. Ideal for use with bedpans, urine bottles and vomit bowls.



100 6G SACHETS	KN-6452
475G TUB	KN-6451

URINE LEG BAGS

Long Tube - 500ml



KM-3480

URINE DRAINAGE BAG

2 Ltr



KH-2169

NEWCASTLE URINE COLLECTION PACK

Simple and easy-to-use, the urine sample is collected on the pads which are put into the child's nappy. The urine is then extracted with a syringe and transferred to the specimen pot. This set can also be used to collect samples from incontinent adults with limited mobility who wear incontinence pads. This urine collector would be placed on top of their usual pad.

CONTENTS

- 2 Urine collection pads
- 1 Syringe
- 1 Specimen container



TG-0303

MULTISTIX 8SG

Glucose, ketone, specific gravity, blood, pH and protein, nitrite & leukocytes.



100 PACK

KN-6054

INSIGHT URINALYSIS STRIPS

Glucose, ketone, blood, pH, protein, specific gravity, urobilinogen, bilirubin, nitrate & leukocytes.



*does not test for urobilinogen & bilirubin



8 PARAMETER - PACK OF 25	KN-3052
10 PARAMETER - PACK OF 100	KN-3051

M E D I C A L E Q U I P M E N T

MONITOR & PROTECT

Our large range of medical products delivers all the essential equipment for resident care to ensure a safe environment.

- Thermometers & Diagnostics
- Air Ways & Suction
- Defibrillators
- Medication Storage
- Bathroom & Living Aids
- Hoist Equipment
- Emergency Evacuation
- Fall Sensors & Alerts



NON-CONTACT INFRARED THERMOMETER

A NON-INVASIVE DEVICE WHICH REQUIRES NO SPARE PROBE COVERS... EVER!

- Measures body temperature, also features surface/ambience mode which allows the reading of air and fluid temperature (bath water, babies bottles, etc)
- Non-contact, simply point and press holding within 3-5cm of patients forehead
- Multi-colour screen to identify a fever alarm
- Less than 2 second response time
- Accurate within +/- 0.3°C & measuring range 22 - 42.5°C (body temperature)
- Accurate within +/- 2.0°C & measuring range 10 - 80°C (object temperature)
- Body temperature data automatically stored within a 32 capacity recall memory
- AAA 1.5V battery included
- Protective case included

A normal reading displays a green light, and a low or high reading is identified by an orange light

ZY-0112



DIGITAL THERMOMETER

- Easy to read, LCD display
- Alarm when measurement is complete
- Suitable for oral use
- Accurate to +/-0.1°C
- Range of measurement 35.5 - 42°C
- Clear plastic case
- Battery included: LR41



DIGITAL THERMOMETER	KE-3255
PROBE COVERS - 25 PACK	KE-3256

DIGITAL TYMPANIC EAR THERMOMETER

- Compact & ergonomic
- Measurement response time of 1 second
- Memory capacity of 10 memory readings
- °C readings
- Auto shut-off (60 seconds)
- Battery life is approximately 4,000 uses
- Supplied with 2 x AAA batteries
- 1 year guarantee

See KE-3262 overleaf for probe covers

KE-3260



PROBE COVERS

For ear thermometer
KE-3260

20
PACK



BEST SELLER

KE-3262

FOREHEAD STRIP

Quick and safe to use forehead strip uses heat sensitive liquid encased in plastic film.

• Range: +35 - +40 °C & °F

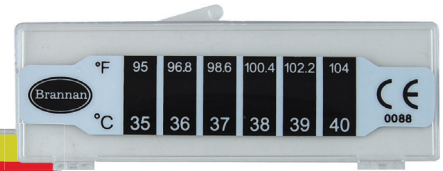

KE-3248

WATERPROOF DIGITAL SHOWER THERMOMETER

With temperature alert



KE-3240

MERCURY FREE

BATH THERMOMETER



FLOATING

KE-3101

SCOOP

KE-3083

WALL THERMOMETER HYPOTHERMIA

Plastic with coloured zones to help determine the most comfortable and economical settings for your home.

• Range: -5° to +50°C
• Accuracy: +/- 1.0°C



KE-3247

WALL THERMOMETER

- Temperature range -10 to +50°C
- Equivalent °F scale
- Plastic



EB-2124

AUTOMATIC BLOOD PRESSURE MONITOR

OMRON M3

- Supplied with an Easy Cuff (22-42 cm)
- Easy to interpret readings
- High Blood Pressure LED indicator
- Cuff wrapping guide & indicator confirms cuff is wrapped correctly
- Shows how reading compares to reference values
- Irregular Heartbeat Detection
- Average of 3 consecutive readings in 10 minutes
- Detects any movement which can invalidate a result

Includes:

- Blood pressure monitor
- Battery set (4x AA - LR06)
- Instruction manual
- Storage case
- Blood pressure pass

MONITOR	KE-6469
MAINS ADAPTOR	KE-6488



BEST SELLER

CUFFS FOR OMRON M3 FULLY AUTOMATIC BP MONITOR

SMALL CUFF - 22-32CM CIRCUMFERENCE **KE-6489**

WRIST BLOOD PRESSURE MONITOR

DIGITAL - FULLY AUTOMATIC
OMRON RS2

- Intellisense Technology
- Cuff wrapping guide
- Optimal speed & pressure for gentle inflation/deflation
- Pre-formed, easy-to-fit cuff
- Irregular heartbeat detection
- Hypertension indicator
- Includes 2x AAA batteries
- 30 memories
- Carry case

KE-6468



AUTOMATIC BLOOD PRESSURE MONITOR

UPPER ARM BP MONITOR IDEAL FOR THE CARE SECTOR AND HOME USE

- Large LCD Display
- Fuzzy Logic Technology
- Fully Automatic
- Auto Shut Off
- European Society of Hypertension Certified
- 2 Year Guarantee
- Latex Free
- Memory Capacity 90 Readings



MONITOR	KE-6472
STANDARD CUFF	KE-6472-CUFF-STD
LARGE CUFF	KE-6472-CUFF-LGE

SPHYGMOMANOMETER

SQUARE DESK MODEL

- 152mm Dial Display
- Desk or Wall Mounted
- 2 Tube Standard Adult Cuff
- Additional sized Cuffs available (Infant to Thigh)
- Cuff/Tubing storage behind dial
- Latex Free

KE-0490



SPHYGMOMANOMETER

ROUND FREE STANDING MODEL

- 147mm Dial
- Metal Castors
- 5 Wheels with Brake
- 360 Degree swivel for easy read
- 2 Tube Standard Adult Cuffs
- Additional sized Cuffs available (Infant to Thigh)
- Adjustable Height

KE-0491



CLIP-ON SPHYGMOMANOMETER

- Reliable, economically priced
- The 48mm dial ensures easy pressure value reading
- Complete with an adult velcro cuff
- Leatherette storage case



KE-0504

DISPOSABLE PEN TORCH

BEST SELLER



KE-0506

CUFFS



25.4 X 40.6CM	KE-6731
25.4 X 40.6CM ONE TUBE	KE-6732
40.6 X 66CM	KE-6733

28" DUAL HEAD STETHOSCOPE

- Lightweight chest piece
- Non-chill bell ring for patient comfort
- Adjustable chrome plated brass binaural
- Excellent sound transmission

LATEX FREE



KE-0505

TIMESCO OPTIMA OTOSCOPE

- Fibre optic light source
- Durable & lightweight
- Requires AA batteries (not included)
- Supplied with carry case
- 3 year warranty

KE-2104



DISPOSABLE SPECULA

For Timesco Optima Otoscope (KE-2104)



2.5MM
KE-2102

4MM
KE-2110

GLUCORX NEXUS METER

The GlucoRx Nexus meter is a high quality, affordable product which facilitates simple management of diabetes. Its has key features such as no coding, 0.5µL blood volume and a results time of 5 seconds.

- Large LCD screen with backlight
- No coding is required to use the meter
- 0.5µL blood volume with results in 5 seconds
- 4 alarms for Ketone warning and a discreet mode without the alarms
- Strip ejection avoids blood contact
- Accommodates alternative site testing
- 1000 reading memory with day averages
- 1.1 - 33.3mmol/L measurement range for the highest possible accuracy
- 30% to 60% haemocrit range
- PC link facility so you can download and analyse your results

KE-5930



GLUCORX NEXUS TEST STRIPS

BEST SELLER

The Glucorx Nexus Test Strips can also be used for the Glucorx Nexus meters. They are used to quantitatively measure glucose from the finger.

- Utilise advanced GDH-FAD enzyme technology
- Strip expiry printed on packaging
- Close pot lid immediately after taking out a strip

KE-5931



AVIVA TEST STRIPS

Featuring 8 electrodes which help to detect & prevent unreliable results when used with a compatible meter

Compatible with:
 ACCU-CHEK Aviva,
 Aviva Nano,
 Aviva Combo
 & Aviva expert meters

KE-5888



ACCU-CHEK SAFE-T-PRO PLUS LANCET

The Safe-T-Pro Plus is a sterile, single-use lancing device for obtaining capillary blood from the fingertip, or if the patient is a child under 1 year, from the heel.



KE-5890

BD MICROTRAINER®

Contact-Activated Lancet
 Safety lancet needle activates only when pressed against the skin 21g (1.8mm depth).



KF-0501

FINGERTIP PULSE OXIMETER

- Suitable for adult & paediatric use (2 years+)
- 30 hours continuous use
- One colour LED display
- Displays SpO2, pulse rate & pulse bar
- Auto power down & low battery indicator
- Low power consumption
- Supplied with batteries (2 x AAA), protective rubber boot & lanyard
- Pulse rate measurement range: 30 – 99bpm: ±2bpm accuracy / 100 – 250bpm: ±2% accuracy
- SpO2 measurement range: 70% – 100%: ±2% accuracy
- 1 year guarantee



KE-1675

ARIANNE NEBULISER

- Ensures fast nebulisation time and increasing treatment efficiency whilst allowing for a reduction in medicine waste
 - Compact, robust and modern in design
 - Plastic case in an attractive colour
 - With a two speed Neboplus Ampoule this unit offers the facility to select the nebulisation speed
 - Dimensions: L21 x W15 x H14cm
- SUPPLIED WITH:
- 1x Neboplus Ampoule
 - 1x Adult mask
 - 1x Child mask
 - 1x Adult nose piece
 - 1x Child nose piece
 - 1x Mouthpiece
 - 1x Tube
 - 1x Filter



KE-0707

HI-FLO NEBULISER

COMPLETE SYSTEM

Very popular Nebuliser is supplied complete with all accessories for immediate use. High performance machine producing a therapeutic mist with particles below 5 microns for effective treatment.

- Suitable for bronchodilators, steroids, antibiotics
- Recommended to replace filters etc minimum every 12 months

ADULT YEAR PACK

The year pack contains all essential parts to keep your nebuliser operating at peak performance at a sensible price.

Includes: 4 each of Nebuliser chambers, drive lines, adult face masks and inlet filters, 1 each of Mouthpiece & outlet filter.



COMPLETE SYSTEM

KE-2081

ADULT YEAR PACK

KE-3571

3A ASPEED SUCTION MACHINE

BEST SELLER

- Double Pump with 1000cc Jar, Liner & 10 Catheters
- Robust piston type electric aspirator, needs no maintenance or lubrication
- Motor protector cap prevents liquids/secretions reaching & damaging pump
- Ideal for use in general practice, nursing homes & occupational health etc
- Compact design for efficient & effective functional aspiration
- Protective thermal cutout relay
- Effective vacuum level: 0 - -0.85 bar
- 12 month guarantee (excluding accessories)
- Air flow: 22Lpm (double pump)

INCLUDED ACCESSORIES

- Autoclavable polycarbonate jar 1000 cc with safety valve (overflow protection)
- Disposable suction liner
- 99% Antibacterial hydrophobic filter
- Sterile cannula
- Sterile manual regulator
- Set of atoxic sterilisable silicone tubes
- Power cable
- KE-2119 fits the KE-2113



SUCTION MACHINE	KE-2113
1LTR COLLECTION BOTTLE	KE-2118
DISPOSABLE LINER	KE-2111
FILTER - 3A ASPEED SUCTION MACHINE	KE-2112

OB-2012 PORTABLE SUCTION UNIT

- Silent, powerful operation
- Choice of collection jars: Autoclavable or Disposable
- Air Flow > 30lt (High Vacuum - High Flow)
- Adjustable suction with analogue gauge 0 to >800 mbar(80kPa)
- Operable and rechargeable through any 12 VDC vehicle source or any 220 VAC with suitable battery charger
- Optional wall bracket available with integrated cable for an external 12V source
- Dimensions: 35 x 10 x 24.5cm
- Weight: 4.9kg

Autoclavable

- Autoclavable 1000 ml jar with safety valve and protection filter
- Weight 3.6 kg

Disposable

- 1000 ml jar with disposable liner
- Weight: about 4.3 kg



OB-2012 SUCTION UNIT - AUTOCLAVABLE	KE-7526
OB-2012 SUCTION UNIT - DISPOSABLE	KE-7525

DEVILBISS SUCTION MACHINE

This portable suction machine has been especially designed to meet the active life styles of clients in their own homes & health care establishments.

COMPLETE UNIT FEATURES:

- Suction range 80-550mm Hg
- 800ml collection bottle
- Built-in re-chargeable battery
- Multi-voltage power supply and 12v DC in car charger
- Suction tubing
- Carrying case

Replacement Pack Contents:

- for both KE-2114 & KE-2103
- 800ml disposable bottle & lid
 - Connection tubing
 - Elbow & integrated filter
 - Float ball
 - Collection bottle
 - 6 inch patient tubing



SUCTION MACHINE	KE-2114
REPLACEMENT PACK	KE-2116
1LTR DISPOSABLE LINER	KE-2121

DEVILBISS VACUAIDE QUIET SUCTION UNIT

The VacuAide QSU has been designed to perform effective airways suctioning in a comfortable, safe and hygienic way, suitable for both a clinical and homecare setting.

It has a large suction pressure range and 27 l/min flow rate for optimum performance yet an operating sound level of just 55dBA, making it one of the quietest suction unit available for its type.

- Low noise level at 55dBA
- Simple to operate with easy grip pressure adjustment gauge
- Suction range of 50-500mmHg and 27 l/min flow
- Comes with a 800ml collection bottle
- Built in rechargeable battery with a 60 min run time
- Multi Voltage power supply with 12v DC Car Charger
- Comes complete with suction tubing and unique carry case for discreet use



SUCTION MACHINE	KE-2103
REPLACEMENT PACK	KE-2116
1LTR DISPOSABLE LINER	KE-2121



Replacement Pack



Disposable Liner

*The liner fits into a canister. The canister is supplied within the replacement packs.

HEARTSTART FRX DEFIBRILLATOR (AED)

The rugged and reliable Heartstart FRx Automated External Defibrillator (AED) has been designed to be very easy to use for first responders.

The unit has been ruggedised to ensure it is available for use in harsh environments, including industrial areas or where it may be subject to water. In tests the FRx has been shown to withstand drops of up to 1m onto a concrete surface and weights of up to 250kg.

The FRx conducts daily, weekly and monthly self-testing routines to ensure that it is ready for use when required. The long-life battery has a standby span of 4 years, and the pads have a lifespan of 2 years. A highly visible indicator indicates the status of the device.

- Detailed voice instructions
- Coaches the user in CPR and defibrillation
- Comprehensive self-tests to ensure optimum operation
- Supplied complete with battery pack and adult pads
- Battery life: 4 years
- Pad life: 2 years
- Energy output: 150 joules into a 50 ohm load (adult), 50 joules into a 50 ohm load (infant/child)
- Shock-to-shock cycle time:
- Dimensions: 60 (H) x 180 (D) x 220 (W) mm
- Weight: 1.5kg
- Warranty: 8 years

KE-3106

HEARTSTART FRX ADULT DEFIBRILLATOR PADS

Adult defibrillator pads designed for use with the Heartstart FRx Defibrillator.

KE-2165

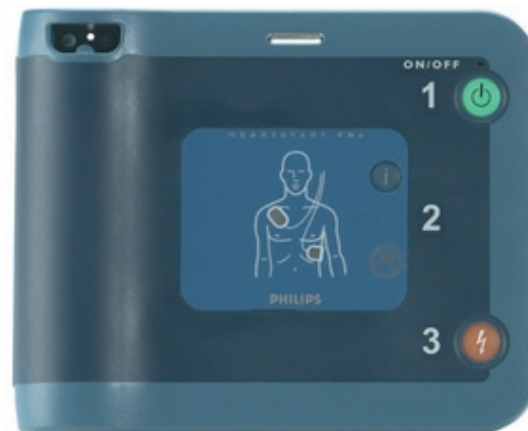

DRUG REFRIGERATION

THE LEADING SOLUTION FOR ALL HEALTHCARE ENVIRONMENTS



This pharmacy fridge keeps heat sensitive medicines between 2°C and 8°C. It features trays with flexible dividers, digital thermometer and lockable door. Right hand hung which is easily reversible. Can be wall mounted if required.

- **Internal fan** - Circulation from internal fan leading to increased cooling performance and reduces frost build up on cooling fans.
- **Door alarm** - Sounds after 20 seconds to alert user that the door is still open, reducing chances of increased internal temperature. More intense alarm sounds after 1 minute should the door remain open.
- **Interior drawer fronts** - Greater protection from ambient external temperature resulting in increased performance.
- **New thermostatic control** - Improved electronics in thermostatic controller meaning improved temperature control.
- **Silent operation**
- **Digital thermometer**
- **Lockable**

Technical Data DS301H Refrigerator

Gross volume	23-27Ltr
Weight of freestanding version	16Kg
Outer dimensions of freestanding version	H: 580mm W: 422mm D: 393mm
Power input	65w

DS301H REFRIGERATOR **EC-1216**

DS301H WALL BRACKET **EB-6139**

REPLACEMENT DIGITAL THERMOMETER

- Sensing probe for fridge temperature measurement
- Range: -50°C to +70°C&F

BEST SELLER

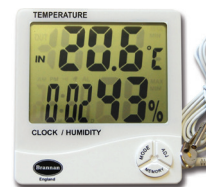

EC-1218

LEC 47L PHARMACY ESSENTIAL REFRIGERATOR

- 2°C to 8°C temperature range
- External digital controller and temperature display
- Fitted lock and supplied with 2 keys
- Audible & visual temperature alarms
- 2 Years parts & labour warranty



EC-1205

CD CONTROLLED DRUG CABINETS

INNER OPTIONS FOR PHARMACY CABINETS

- Independently tested to conform to or exceed all the required standards & legislation
- Tested to the British Standard (BS 2881:1989 Security Level 1)
- High security 8 lever lock designed to EN1300 & VdS 2396
- 3 keys supplied
- Adjustable shelves and door trays



	DIMENSIONS - MM	SHELF	
CDC21/NL	210W X 270D X 300H	1	EB-3212
CDC22/NL	340W X 270D X 300H	1	EB-3213
CDC23/NL	340W X 270D X 550H	2	EB-3214

PHARMACY CABINETS

- Independently tested to conform to or exceed all the required standards & legislation
- Tested to the British Standard (BS 2881:1989 Security Level 1)
- High security 8 lever lock designed to EN1300 and VdS 2396 (3 keys supplied)
- Adjustable shelves and door trays



	CD/INNER OPTION	DIMENSIONS - MM	SHELF	WEIGHT	
1. MC3/WL	CDC21 & 22	600W X 300D X 600H	3	22KG	EB-3216
2. MC5/WL	CDC21 & 22	1000W X 300D X 600H	6	36KG	EB-3217
3. MC9/WL	CDC21, 22 & 23	1000W X 300D X 850H	8	46KG	EB-3218

MONITORED DOSAGE SYSTEM (MDS)

Designed for the storage and dispensing of the popular blister packed Monitored Dosage System (MDS).

- Contemporary in design
- Strong, secure & durable in construction
- For storing, distributing & dispensing medicines
- Hygienically designed
- Finished in attractive beech effect laminate
- Pull out shelves & adjustable height door shelves
- Shelf for patients record file
- Storage tray for patients record file (EB-3226 only)



	DIMENSIONS - MM	FRAMES	SHELF	DOOR SHELF	BLISTER PACKS PER SHELF	
DT1MDS6	620W X 600D X 1120H	6	3	3	FITS 2	EB-3225
DT2MDS9	820W X 600D X 1120H	9	3	3	FITS 3	EB-3226

SELF ADMINISTRATION CABINETS

- Designed for storage of self administration medicines
- Cabinets provide low level security for the Monitored Dosage System (MDS)
- Suitable for storing the Manrex (Boots) and Venalink systems
- High quality 18mm beech effect construction
- Locking door supplied with 2 keys



'Key to differ' Always key to differ unless stated when ordering.

	DIMENSIONS - MM	MDS RACKS	
MDESCAB1 SMALL CABINET	300W X 240D X 420H	1	EB-3219
MDESCAB2 LARGE CABINET	400W X 240D X 720H	2	EB-3221

DRUG TROLLEY SECURITY LEASH WITH WALL FIXING BRACKET

Leash can only be fitted when ordered with the trolley

- Secures trolley to the fabric of the building when not in use
- No additional keys required



EB-3244

IF YOU DO NOT SEE WHAT YOU REQUIRE PLEASE CONTACT OUR SALES OFFICE

VISTA TROLLEY

The Sunflower range of Vista medical trolleys and storage modules is extensive, with options to suit all applications and environments, from GP or hospital consultation and treatment rooms, to hospital wards and intensive care units. The product range is designed to be easy to clean, with smooth lines and minimal dirt traps.



1. 2 SINGLE / 2 DOUBLE	VISTA 30	EB-3193
2. 3 SINGLE / 1 DOUBLE	VISTA 40	EB-3192
3. 4 SINGLE / 1 DOUBLE	VISTA 50	EB-3190

GC RANGE STORAGE CABINETS & LABELS SUPPLIED

- A range of mild steel storage cabinets fitted with a flush fitting locking handle
- Each cabinet has integral shelf locators (2 per 300mm high and 400mm high cabinets) and is supplied with removable shelves
- Measurements:
GC005: w300x d200 x h 400mm
GC010: w400x d200 x h 400mm
GC015: w400x d200 x h 600mm



GC005 - 2 SHELF	EB-3231
GC010 - 2 SHELF	EB-3232
GC015 - 4 SHELF	EB-3233

A complimentary set of self-adhesive labels (First Aid & Clinical Reagents) enables users to specify cabinet contents if required.

METAL FIRST AID CABINET

BEST SELLER

- Wall mountable
 - Metal
 - Lockable
 - Removable shelves
- 46 h x 30 w x 14 d cm



KN-6103

MEDI DISPENSER

- A weeks medication with up to 4 daily doses
 - 7 plastic containers printed with day of the week
- 170 x 115 x 20mm



KE-6538

3-IN-1 PILL CUTTER, CRUSHER AND STORAGE

BEST SELLER

*Product may differ in appearance to the one pictured.



ED-3028

STAINLESS STEEL TABLET COUNTER

Triangular stainless steel tablet counter with clear counting scale. Cost effective and robust metal tablet counting triangle:

- Manufactured from 304 grade high quality stainless steel
- Triangular
- 205 x 190mm

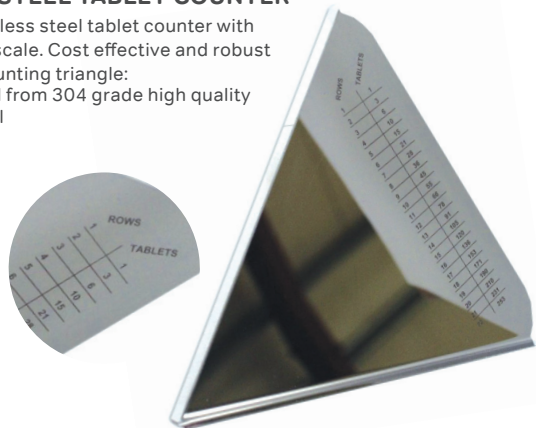

KE-6539

DRUG BOOK

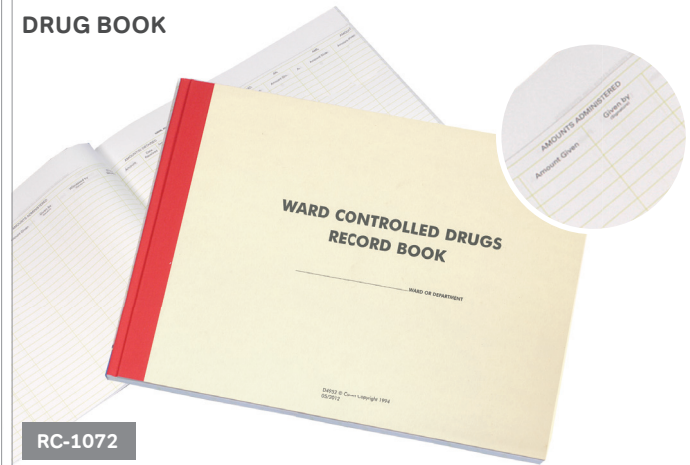

RC-1072

**BEST SELLER**

INFLATABLE HAIR WASH BASIN

Simple and sturdy shampoo basin that easily inflates. Ideal for bed use, it is easily and conveniently drained.

- Sturdy design
- Offering portable hair washing
- Allows assisted hair washing in bed
- No mess drainage hole with plug
- Drainage pipe
- Neck recessed for comfort
- Latex-free, vinyl construction

ED-3023

DELUXE MOBILE SHOWER COMMODE CHAIR & LAP STRAP

MAX WEIGHT 127KG

- Swing away footrests as standard
- Padded hinged arm supports for easy transfer
- All alloy lightweight frame with tough polymer coating
- Detachable padded back assembly
- Easy clean padded PU seat, back and arms infill as standard
- Four high quality 125mm rust proof brake castors
- 7 litre bucket as standard
- Fits comfortably over standard WC
- 127kg weight limit

EB-2182

LAP STRAP

Adjustable safety lap strap which can be secured around the backrest or arm rest.

EB-2184

MOBILE SHOWER CHAIR

- Moulded polypropylene seat conforms to MHRA safety guidelines
- Fixed height
- Max user weight 190kg
- Seat width: 520mm



BEST SELLER

MAX WEIGHT 190KG

1	EB-2180	Fixed arms & 2 front brake castors
2	EB-2178	Removable arms & 4 brake castors

STACKABLE PORTABLE SHOWER CHAIR

Moulded polypropylene seat offering maximum drainage, conforms to MHRA guidelines.

- Lightweight and stackable for ease of storage
- Tubular steel construction with tough polymer coating in white
- Rubber ferrule leg tips for safety
- Tested to BS EN 12182:1999 clause 16
- Overall: 82 - 95h x 44w x 44d cm
- Height adjustable by 13cm

MAX WEIGHT 127KG



ED-6809

PRISM MEDICAL UK

Helping to transform lives every day

TILT-IN-SPACE SHOWER COMMUNE CHAIR

A lightweight, tilt-in-space aluminium shower commode chair which provides a versatile bathing and toileting solution for a wide variety of patients.

The seat can be tilted from 6° to 25° in a variety of positions via the ergonomically designed hand lever. It allows for a more comfortable and relaxed seating position for those with poor muscle tone, whilst facilitating patient transfers, particularly useful when using a mobile hoist. A soft padded seat is provided which ensures added comfort and security for the patient. It is both easy to manoeuvre and easy to clean.

- Adjustable seat angle of 6° to 25° ensures suitability of a wide range of conditions & aids patient transfers
- Length adjustable, swing-away footrest for ease of access and varying leg lengths
- Height adjustable headrest suitable for a range of patient heights
- Flip-up armrests allow for easy side patient transfer
- Manufactured in strong yet lightweight aluminium, durable & easy to transport; will not rust or corrode
- Padded seat provides a comfortable and secure seating position for the patient
- 4 individually locking castors provides a stable seating position whilst aiding manoeuvrability
- Removable backrest can be laundered and replaced as necessary
- Weight limit 150KG / 23 stone

EB-2185



MAX WEIGHT 150KG

SEAT HEIGHT	55CM
SEAT DEPTH	42CM
SEAT WIDTH	45CM
WARRANTY	1 YEAR



SHOWER CRADLE

- Safe, comfortable bathing for those with degenerative or severe physical conditions
- Removable, washable cover to maintain hygiene levels
- Adjustable to three positions to suit individual
- Adjustable fabric to create a hammock effect for added safety

Available in Small, Medium and Large.
Replacement cover available at an additional cost.

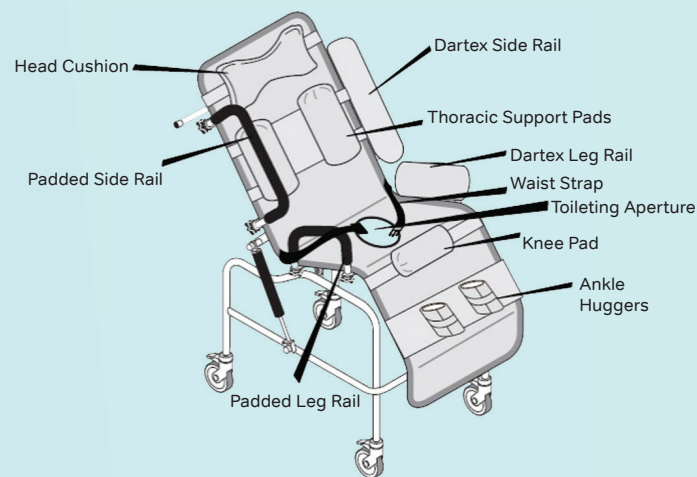
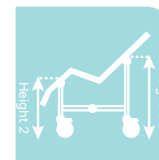
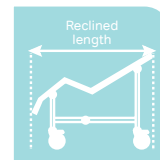
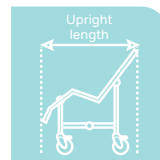

Width	Upright Length	Reclined Length	Height 1	Height 2
Varies*	Varies*	Varies*	815mm	670mm

*Varies depending on small, medium or large size

ADDITIONAL ACCESSORIES
PLEASE CALL OUR SALES DEPARTMENT FOR
A PERSONALISED QUOTE REF NO: JB-3078

JB-3078

CONTRACT HINGED ARM SUPPORT

STANDARD WHITE

- Simple fold up/down mechanism
- Epoxy coated in white
- Max user weight 115Kg
- 750mm long

STANDARD RED OR BLUE

- Epoxy coated
- Max user weight 170Kg
- 760mm long

White Red or Blue
Please state colour when placing your order



EB-3258

HEIGHT ADJUSTABLE WHITE

- Leg offers extra stability
- Max user weight 127Kg
- 750mm long

STANDARD RED OR BLUE

- Powder coated steel
- Max user weight 170Kg
- 760mm long

White Red or Blue
Please state colour when placing your order



EB-3259

FIXED HANDRAIL

- Cadmium & lead free UPVC with ABS flanges
- Covered caps as standard
- Ribbed grip for improved safety
- Reinforced fixing points
- Highly durable
- Tube diameter: 32mm
- Depth to wall: 60mm

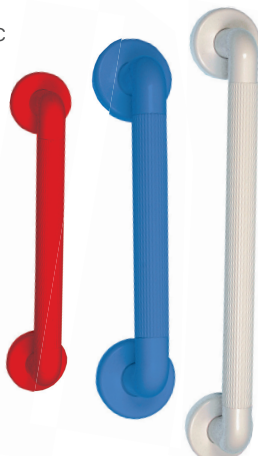

EB-3347 30 cm

EB-3348 45cm

EB-3349 60cm

White Red or Blue
Please state colour when placing your order

STATIC SHOWER CHAIR

BEST SELLER

- Fixed height and arms
- Portable and stackable
- Moulded polypropylene seat for maximum drainage
- Conforms to MHRA guidelines
- Rubber ferrule leg tips
- Max user weight: 127kg



EB-2177

ROBUST SHOWER STOOL

- Tough polymer coated frame
- Adjustable seat height: 495-645mm
- Seat width: 370mm
- Clip on/off plastic seat
- Max user weight: 159Kg



EB-3345

HEIGHT ADJUSTABLE TOILET AID



RED OR BLUE

- Thick non-slip feet
- Seat removes easily
- Integral splash-guard
- Max user weight 190kg

WHITE

- Easily cleaned
- One piece clip on seat
- Max user weight 154kg

BEST SELLER



RED	EB-3090-RE
BLUE	EB-3090-BL
WHITE	EB-3090-WH

FLOOR FIXING TOILET AID FRAME

- Height adjustable
- Max user weight 190kg



EB-3285

NON-SLIP TOILET AID FRAME

- Height adjustable
- Rubber tip
- Max user weight 190kg



EB-3089-WH

PERFECT TO SUPPORT A CO-ORDINATING TOILETING STRATEGY IN A DEMENTIA CARE ENVIRONMENT
 Both seat styles available in red or blue, Standard Seat also available in white, please state colour when ordering

COLOUR CODED TOILET SEAT

STANDARD

- Durable economical plastic seat
- Fits most standard toilets
- Standard fixing

RED	EB-3342-RE
BLUE	EB-3342-BL
WHITE	EB-3342-WH

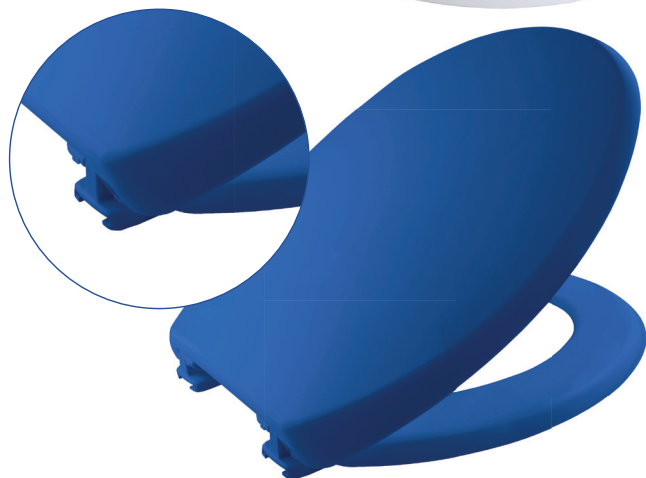

IDEAL FOR DEMENTIA CARE

RAISED TOILET SEAT

A hygienic one-piece moulded seat, lends itself to easy cleaning and reissue.

Available in 3 heights: 5cm, 10cm and 15cm.

- Designed for comfort
- Ergonomic thigh supports
- Fits all British standard pans
- Wide frontal access
- Large aperture



5CM RAISED SEAT

RED	EC-3157-RE
BLUE	EC-3157-BL
WHITE	EC-3157-WH

10CM RAISED SEAT

RED	EC-3158-RE
BLUE	EC-3158-BL
WHITE	EC-3158-WH

15CM RAISED SEAT

RED	EC-3159-RE
BLUE	EC-3159-BL
WHITE	EC-3159-WH



STATIC COMMODE

- Stackable design for ease of storage (max 10 per stack)
- Completely removable upholstery for ease of cleaning and space saving when stacked
- Splayed legs for added stability
- Supplied complete with removable commode pan and lid and fire retardant upholstery
- Replacement Pan available
- Maximum user weight 160kg (25st)



MAX WEIGHT 160KG

COMMUNE	EB-1137
REPLACEMENT PAN	EC-3459

MOBILE COMMUNE

- Fixed height
- Detachable footrest
- Detachable arms
- 4 brake castors
- Push handle
- Replacement Pan available
- Maximum user weight 190kg



MAX WEIGHT 190KG

COMMUNE	EB-3575
REPLACEMENT PAN	EB-3576

BEST SELLER



BARIATRIC COMMUNES

- Robust dip-coated (non-peel) all welded frame
- Detachable arms for lateral transfer
- Cellular moulded (anti-bacterial) backrest and seat
- 14 litre pan with lid

MOBILE COMMUNE

- Fitted with 4x 12.5cm diameter brake castors
- Clip on/off moulded seat
- Fixed height
- 50h x 63w x 63d cm
- 61sw x 43sd cm
- Max user weight: 203kg



MAX WEIGHT 203KG

EB-1156

STATIC COMMUNE

- Clip on clip off rota moulded seat
- Adjustable height
- 43 - 58h x 66w x 54d cm
- 61sw x 43sd cm
- Max user weight: 280kg



MAX WEIGHT 280KG

EB-1157

Bariatric Range Available
Call for more information

G-LOGIC ATTENDANT PUSHED WHEELCHAIR

The wheelchair has puncture proof tyres to make the wheelchair more durable, as well as having a half-folding back to make travel and storage easier. There are also height adjustable armrests and swing-away/quick release leg rests, to provide you with comfort

- Matt Black Frame
- 45cm seat width
- Half-folding back
- Puncture proof tyres
- Max user weight 113kg (17st)



COLOUR OPTIONS



Please specify colour when placing your order

EB-3849-AP

MAX WEIGHT 113KG

KARMA ERGO LITE 2 TRANSIT WHEELCHAIR

The Ergo Lite 2 from Karma is an ultralight aluminium transit wheelchair with a detachable swing-away footrest for easy transfer. Weighing just 9.3 kg, it's extremely light, easy to fold and lift.

- Large 18" seat width
- Swing in/out detachable footrest
- Foldable backrest and frame for easy transportation.
- Desk-length padded armrests for extra comfort
- Comfortable & durable upholstery with antimicrobial protection
- Max user weight 100kg (15st)



EB-3848-TR

MAX WEIGHT 100KG

TRANSIT WHEELCHAIR

Compact and lightweight steel frame. Ideal for first time users, occasional use and travel.

- Weight 12kg including footrests
- Folds compact for easy storage and transportation
- Padded armrests for comfort
- Detachable, adjustable swing away footrests
- Lap belt included
- Full dimensions: 101h x 59w x 90d cm
- Seat dimensions: 50 x 48 x 40cm
- Closed width: 24.5cm
- Max weight limit 115kg (18st)



EB-3524-BL

MAX WEIGHT 115KG

ALERTA TRANSIT WHEELCHAIR

The rear wheels measure at 30cm and the front wheels measure at 20cm, as well as all being puncture proof.

- The seat is 40cm deep and 43cm wide.
- Crash Tested
- Puncture Proof Tyres
- Padded armrests
- Drop Down Arms



EB-3511

MAX WEIGHT 115KG

BEST SELLER

DAYS ESCAPE LITE TRANSIT ALUMINIUM WHEELCHAIR

- Puncture-proof tyres
- Full-length armrest
- Padded, flam-retardant upholstery
- Detachable, swing-away footrest
- Lightweight & foldable
- 100kg (16st) weight limit

COLOUR OPTIONS



Please specify colour when placing your order



EB-3842

MAX WEIGHT 100KG

DRIVE TRI-WALKER WITH SEAT

- Unique seat design enables user to rest when necessary
- Looped cable brakes are easily activated and lockable for safety
- Front wheel swivels for increased manoeuvrability
- Handle height easily adjusts to suit various users
- Easy fold system for storage and transportation
- 19cm (7.5") puncture-proof wheels
- Suitable for indoor and outdoor use
- Includes bag, which folds with Tri-Walker if stored away

MAX WEIGHT 114KG

EB-3925



X FOLD ROLLATOR

- Bi-folds for a very compact size
- Sturdy lightweight aluminium cross brace & frame
- Integral seat handle serves as a useful handgrip
- Loop brakes with internally routed brake cables
- 20cm diameter wheels for indoor and outdoor use
- Reflectors for enhanced visibility
- Height adjustable 81-94 cm W64cm
- Seat height 56cm (W46cm D23cm)
- Max user weight 135kg (21st)

MAX WEIGHT 135KG

EB-3853



VINYL WHEELCHAIR FOAM CUSHION

- 5cm (2") thick foam inner cushion
- Wipe-clean waterproof vinyl cover
- Provides comfort when sitting for long periods
- 40 x 40 x 5cm



EB-3981

WHEELCHAIR CUSHION SET

Slim fit allowing it to fit on most wheelchairs. Filled with soft flame retardant hollow fibre.

- 128cm (W) x 130cm (L)



ED-4016

VINYL WHEELCHAIR CUSHION WITH MEMORY FOAM

- Foam inner with memory foam topper
- Wipe-clean black vinyl cover
- 2 sizes available



40.6 x 40.6 x 5cm

ED-4089

45.7 x 40.6 x 5cm

ED-4017

WHEELCHAIR SAFETY STRAP

Fits to the backrest of wheelchair. Fastens around the waist with a double adjustable snaplock fastener.

Also suitable for use with Shower Chairs

EB-2174



REACHER - 66CM



EC-2167

LEADING BRANDS, MORE CHOICE AND VALUE

We work with the UK's leading brands in healthcare equipment to be able to offer our customers high quality products at affordable prices.



ORBITAL TRANSFER PLATFORM

MAX WEIGHT 222KG

Assists a person who is weight bearing and has good upper body strength to transfer from one seated position to another.

- Pivots between sitting surfaces
- Reduces physical strains placed on carers
- Handle bar surrounds for increased support
- Non slip footplate offers secure foothold
- W 66 x D 69cm
- Width between arms 43cm
- Height of front handles from base 76cm
- Height of top bar from platform base 93cm
- Disc diameter - 45cm
- 222kg maximum weight capacity
- Weight 17Kg



EB-3488

MAX WEIGHT 160KG



INVACARE ISA STAND ASSIST

Offering a natural pattern of movement, it creates a safer, more comfortable, active and efficient seated to seated transfer for elderly and disabled people. The ISA assists carers with its intuitive operation, ease of use and manoeuvrability.

- Flexible adjustment through the TelescoLift arm
- Single-handed hook design
- Ergonomic push bar
- Soft padded lower leg support
- Significant range of adjustments to suit the user

EB-8152

PATIENT TURNER

MAX WEIGHT 190KG

A practical tool helping carers with lifting and turning of patients from one seated position to another.



- Lightweight unit (15kg) for ease of transport
- Compressible mast and removable knee pads
- Height adjustable
- Foot pedal break for security
- Padded loop handle allows for preferred grips of patients
- Suitable for patients with a moderate degree of strength in their arms and legs
- Turntable easily rotates 360° for transfers in even the most confined spaces
- Reduces the risk of stress injuries for the carers
- Weight limit of 23 stone/190kg

EB-3494

HERMES 250 HOIST

This folding hoist is electrically operated, with an additional electric actuator to operate the chassis, enabling the legs to be opened with ease and wheeled around a chair.

- High weight capacity of 250Kg
- Can be vertically stored away when not in use
- Low clearance, easy access underneath beds
- Chassis legs can be opened with ease
- Quality Dewert control system
- On / Off board charging system

MAX WEIGHT 250KG



EB-8195

NOVALTIS STAND AID

The Novaltis Stand Aid Hoist enables users to be quickly and efficiently transferred from bed to chair, chair to commode/bathroom, etc. in a fraction of the time required for a conventional sling lifter.

- High weight capacity of 175kg
- Low castors for better access under beds
- Large knee pads for safe and secure transfers
- Dewert Control System with emergency stop
- Ergonomic push handle

MAX WEIGHT 175KG



EB-8180

MACKWORTH STAND ASSIST HOIST

A highly economical stand aid solution. The stand assist hoist is a robust unit with no compromise on quality.

- Robust unit that provides safety when in use
- Manual leg opening
- Removable foot plate
- Soft, adjustable lower leg support with integral strap attachment points
- Lifting range of 790-1670mm
- Overall size L1220 x W670 x H1150mm
- Castor size 100mm
- Total user weight 180kg

MAX WEIGHT 180KG



EB-8189



ABLE ASSIST PATIENT TRANSFER AID

- Provides a safe and easy solution for a Carer wishing to transfer a client
- Enables users to participate in transfers, improving muscle tone
- Ideal for transferring users from room to room, increasing user's independence
- Maximum user weight 185kg (29st)
- 2x 7.5cm plain castors
- 2x 7.5cm brake castors

MAX WEIGHT 185KG



Specifications

With Adjustable Legs
EB-8106

Dimensions (L X H X W)	82 x 106 x 53cm
Knee Pad Measurements (W X H)	39 x 26cm
Knee Pad Height From Base Plate	5-49cm
Seat Height From Floor	62cm

ADJUSTABLE PATIENT SLING

FOR USE WITH ABLE ASSIST PATIENT TRANSFER AID

For additional safety and peace of mind, an adjustable transfer sling can be used with the Able Assist Patient Transfer Aids.

EB-8108



MAX WEIGHT 180KG



EB-8165

MACKWORTH STAND AID TA180

The versatility allows for ease of use in a variety of care and health environments.

- Softer padded knee support for extra comfort
- Easy to use manual leg open/ close pedal
- Detachable & reinforced strengthened foot plate
- Offers a suitable alternative to a wheelchair
- Provides easy transportation to the bathroom
- Stand aid foot print L 150 x W 65 cm
- Turning radius - 112.5cm
- Maximum weight capacity - 180kg
- One year warranty

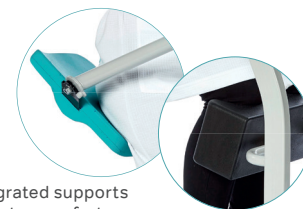

Integrated supports for extra comfort

BIRDIE EVO FOLDING HOISTS

5 YEAR WARRANTY

	EB-8142-EV Birdie Evo	EB-8141-EV Birdie Evo Compact
Base Length	1220mm	1080mm
Base Width	640mm	520mm
Inside Width Legs Open	1020mm	815mm
Lifting Range	415-1660mm	530-1590mm
Product Weight	40kg	31kg
Safe Working Load	180Kg	150Kg

Ask about our
delivery installation
demonstration support

- New curved design of boom and spreader bar
- Simple to fold & dismantle without the need for tools, uses loop style slings
- Client can be rotated 360 degrees whilst suspended by the spreader bar
- Detachable battery pack
- 100mm castors front and rear – rear castors braked as standard
- Audio battery alarm and battery indicator
- Battery status LED
- 5 year warranty - 5 years on actuator, frame and control box / 2 years on handset / 1 year on batteries

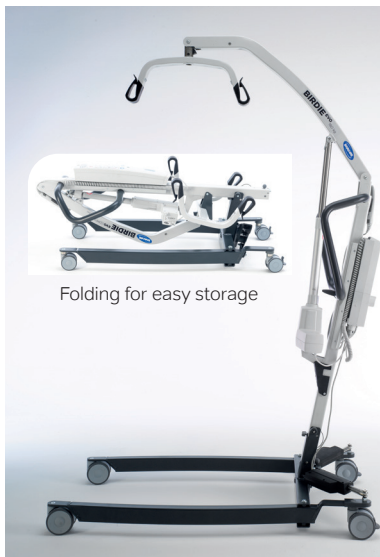

Folding for easy storage

MACKWORTH ESSENTIALS 180KG MOBILE HOIST

3 YEAR WARRANTY

A cost effective quality solution constructed from high quality powder coated steel.

- Tool free assembly, single person installation
- Easy to position with 4 large swivel castors and ergonomic handle
- Electric leg opening as standard
- Robust steel powder coated frame
- 180kg safe working load
- Linark control system



MAX WEIGHT 180KG

EB-8159

DIGITAL HOIST WEIGHERS - 941 MODEL

Attaches to most hoists to provide a weighing and handling facility. CE Approval CLASS III.

- Rechargeable function for stand alone operation
- Automatic reduction of sling weight
- Body Mass Index function
- Capacity up to 200kg by 200g (dependent on hoist maximum load)



EB-2121

HERIDA MOBILE HOIST H-180™

With it's attractive outlook and ergonomic design coupled with impressive lifting capabilities, allowing ease of maneuverability, even under maximum load.

The high boom, coupled with ultra-low lifting positions, ensures that the H-180 will fit perfectly in any care home, residential or hospital setting.



EB-8186-FIX (fixed battery)

EB-8186-DET (detachable battery)

Frame Material	Heavy Duty Steel
Actuator Strength Linak® Technology	10000 N
Product Weight	52kg
Floor Lifting Position	43cm
Maximum Boom Height	195cm
EN10535 Compliant. Manufactured to the most stringent standards.	

FULLY WOVEN HIGH DEFINITION LABEL THAT WILL NOT WASH OUT

- Last the lifetime of the sling thus ensuring LOLER compliance throughout
- High temperature compatible laundered label up to 90 degrees
- Identifies sling style, size, fabric, attachment type and maximum patient weight
- Individual serial number for traceability and easy reference for manufacturing date
- Space to note patients name and 6 year LOLER compliance check section
- Tested in accordance with BSEN 10535
- We can provide a wide variety of slings so if your requirement is not here please contact our sales office quoting make, model and size required



HAMMOCK WITH SUPERSOFT MATERIAL

BEST SELLER

- Multi-utilisation sling and is also available to support amputee patients
- Tested to a safe working load 220Kg

MAX WEIGHT 220KG

Padded Head Support

Please request at time of ordering

Toilet Aperture Available

Please request at time of ordering

Loop Fitting

Small	EB-8030
Medium	EB-8031
Large	EB-8033
X Large	EB-8034

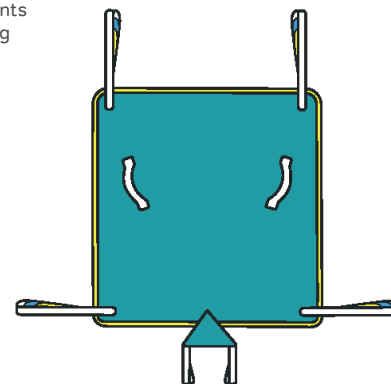



FAST FIT DELUXE MESH

- Popular sling for general purpose transfers
- Generally used where greater support is required in the hip or thigh area
- Suitable for bathing when purchased in mesh
- Dignity hoop to maintain modesty and patient well being
- Dual sided positioning handles for manoeuvrability
- Safety tested to 220Kg

MAX WEIGHT 220KG

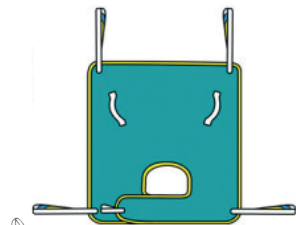

Loop Fitting	Small	EB-6962-SM
	Medium	EB-6963-ME
	Large	EB-6964-LA
	X Large	EB-6965-EL

STANDARD UNIVERSAL SLING

BEST SELLER

- Divided leg sling can be used between the legs
- Available with or without head section
- Safety Tested to 220Kg

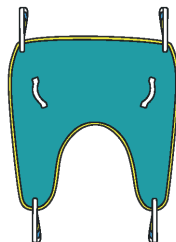

MAX WEIGHT 220KG

Loop Fitting	Small	EB-6954-SM
	Medium	EB-6955-ME
	Large	EB-6956-LA
	X Large	EB-6957-EL

STANDARD UNIVERSAL SLING WITH HEAD SUPPORT

- Features additional tailoring and support in leg and shoulder areas for additional comfort
- Dignity hoop for modesty and patient well being
- Safety tested to 220Kg

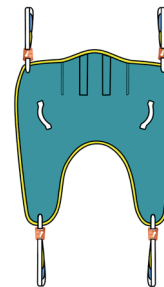

MAX WEIGHT 220KG

Loop Fitting	Small	EB-7075
	Medium	EB-7076
	Large	EB-7077
	X Large	EB-7078

Clip Fitting	Small	EB-7022
	Medium	EB-7023
	Large	EB-7024
	X Large	EB-7025

DRESS/TOILETING SLING

BEST SELLER

- Waist support belt with Velcro or buckle fixing
- Support belt provides additional patient security
- Under arm padding for increased patient comfort
- Safety tested to 220Kg

MAX WEIGHT 220KG

Loop Fitting	Small	EB-6966-SM
	Medium	EB-6967-ME
	Large	EB-6968-LA
	X Large	EB-6969-EL

Clip Fitting	Small	EB-7053
	Medium	EB-7054
	Large	EB-7055
	X Large	EB-7056

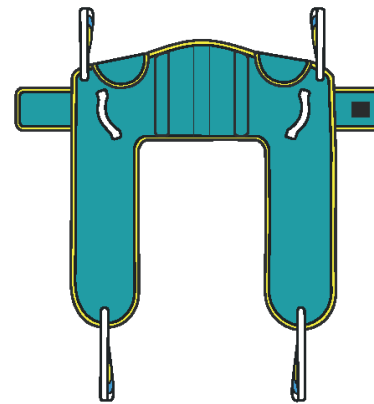

STAND AID BACK SUPPORT SLING

BEST SELLER

- For use with stand aid hoists only
- Quilted material enhances patient comfort
- Padded back support with polycarbonate stays provide stability and rigidity
- Under arm padding for increased comfort
- Waist support with velcro or buckle fixing
- Safety tested to 220Kg

MAX WEIGHT 220KG

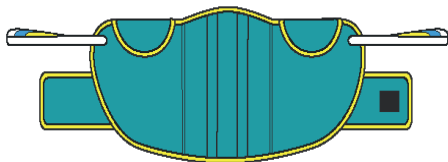

Loop Fitting

Clip Fitting

Small	EB-6987
Medium	EB-6988
Large	EB-6989
X Large	EB-6990

Small	EB-6820
Medium	EB-6821
Large	EB-6822
X Large	EB-6823

EASY MOVER

NEW

The easy mover stand aid is easy to use, with opening legs to navigate chairs and other obstacles. Braked rear casters keep the unit stable while the patient raises themselves from a seated position. Once in the raised position, the rear seat pads are moved into place to prevent falls and the patient can then be transferred between beds, chairs and toilets etc without the need for a wheelchair.

- **Transport Function**
Provides easy transportation to the bathroom/toilet
- **Hand Grips**
Secure metal hand grips for patient and operator
- **Rubber Castors**
Non-slip rubber castors allow easy manoeuvring
- **Folding Seat Pads**
Folding seat pads allow the patient to step into the mover and remain securely seated during transport
- **Padded Knee Supports**
Height and tilt adjustable padded knee supports for added comfort and stability
- **Eye Contact**
Allows for better eye contact between the user and carer



EM-8178



IN AN EMERGENCY SITUATION... ARE YOU PREPARED?



EVACUATION SHEET

PERMANENTLY FIXED TO BEDS FOR FAST EVACUATION OF BED BOUND PATIENTS!

- Fixes permanently to flexible foam mattresses
- Safety belts hold the patient on the mattress
- Pulling straps at each end
- Slippery sheet and mattress flexes
- Will pass through narrow doorways & down stairs
- Two people required for evacuation
- Safe working load: 160kg

MAX WEIGHT 160KG

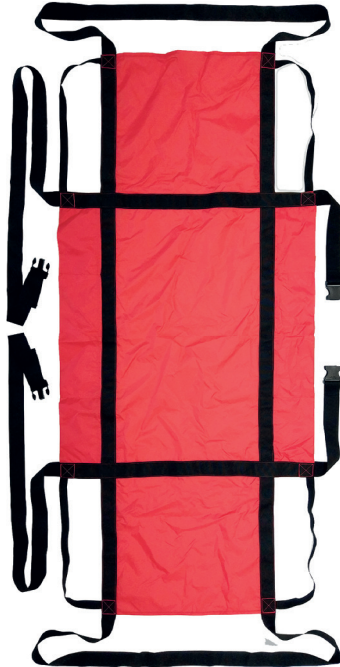

EB-3505

EVACUATION SLEDGE

FAST EVACUATION OF PATIENTS, DOWN STAIRS AND OVER ANY SURFACE

- Dual layer inner foam
- Firm lower layer to ride over any surfaces
- Soft upper layer for patient comfort
- Safety belts and foot pocket hold patient in place
- Pulling straps at each end
- Tough slippery coated bottom side
- Loop at head is to hold when descending stairs
- Stored in a pouch and can hang on the wall
- One or two people required for evacuation

EB-3504



AIR MATTRESS EVACUATION SHEET

Our air mattress evacuation sheet is a very similar design to our standard evacuation sheet.

The unit has large pulling straps at either end to aid negotiation of stair ways. With securing straps to hold the patient when in transit.



EB-3510

HI-VIS VEST LARGE

BEST SELLER

100% Polyester



QB-3506

EMERGENCY TRANSFER CHAIR

SUITABLE FOR MANOEUVRING PATIENTS
IN A CONFINED SPACE

- Folds flat for storage and transportation
- Plastic coated steel construction
- Wipe clean upholstery – flame retardant
- Anti-tipping adjustment assemblies
- 10cm solid tyre wheels
- Safety lap strap
- Seat width is 34cm
- Length when folded flat is 117cm
- Depth when folded flat is 39cm
- 82 h X 45 w x 47 d cm
- 34 sh x 28 sd cm
- Weight 9Kg

MAX WEIGHT 120KG



EB-3044

“GRAB & GO” EMERGENCY BAG

Bright red rucksack contains:

- 1x Travel first aid kit (BS-8599)
- 20x Emergency foil blankets
- 2x High visibility vests
- 1x Emergency whistle
- 100x ID wrist bands
- 1x Torch
- 1x Head torch
- 3x AAA batteries

**PRE-PACKED FIRST AID
BAG ALWAYS ON HAND
FOR FAST EVACUATION**

EB-3506



SEAT BELT / LIGATURE KNIFE

- Fixed blade seat belt cutter
- Can be used as a ligature knife
- Protected blade for safety
- Wide body for easy grip
- High visibility orange colour



KE-2141

EMERGENCY WHISTLE



KM-6515

SLIDE SHEETS

Ultra slide sheets are designed to allow three basic patient handling tasks without the need to lift and without the risk of shearing to the patients skin.

Ideal for:

- Turning a resident
- Pressure care, change of dressing or cleaning
- Sitting a resident up in bed and moving a resident on or off the bed without painful shearing.



EB-7129	Compact	85 X 85cm
EB-7127	Standard	115 x 85cm
EB-7128	Wide	130 x 100cm
EB-7125	Long	145 x 85cm
EB-7066	Extra Long	200 x 85cm

LIMB SUPPORT

MULTI-USE PADDED SLING FOR COMFORT

- Helps to retain good posture
- For standing transfers
- Repositioning in bed
- Leg transfers
- 60 x 25cm



EB-3118

LATERAL TRANSFER SLIDE

Smooth surface and non-slip base allowing a client to be moved from one surface to another without the need to be lifted.

Used in conjunction with the Emergency Transfer Sheet (EB-7015) correct posture during the transfer is maintained. The Lateral Transfer Slide has tapered edges to allow for easy insertion and removal.

- Size 185 x 65cm



EB-3116

DUO TRANSFER SLIDE DELUXE

- Allows straight and angled transfers
- Hand grips allow extra security for the user
- Low friction surface that will not crack or splinter
- Totally hygienic construction
- Lightweight and easy to carry
- Weight limit: 150kg

MAX WEIGHT 150KG



EB-3128

GLIDE AND LOCK SHEET

DESIGNED TO ENABLE SAFE & EASY MOVEMENT

- Anti-slippage material on base
- Polyester coated inner allows the movement to occur
- 41 x 41cm



EB-3105

TRANSFER TURNING DISCS

RIGID DISC - 40.5CM DIAMETER

- Strong & lightweight transfer turntable
- Smooth & easy rotation in any direction
- Assists the carer to transfer a patient safely from a chair to bed, into and out of a car
- Can also comfortably assist those with limited mobility to transfer themselves
- Helps avoid back strain
- Max user weight: 125kg



MAX WEIGHT 125KG

EB-7067

UNIVERSAL LOOPED HANDLING BELT

The universal handling belt is a standard belt used for those users lacking physical strength and cognitive aspects of moving and handling tasks.

1. Belt strap:

Allows tidy housing of surplus belt material

2. Quilted grey material as standard:

Enhances user comfort

3. Security belt:

Provides user comfort

- Aids the basic sitting to standing procedure and visa versa
- One size fits all
- Accommodates 20" - 57" waist sizes with the use of an extension piece
- Impregnated with acti-fresh, an anti-microbial agent which helps to reduce cross infection
- Can be surface cleaned with a 75% alcohol based solution

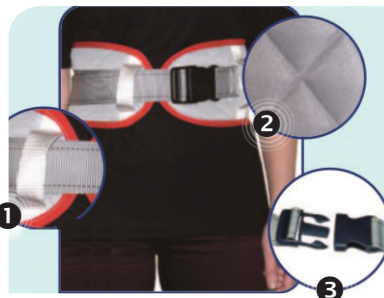

EB-7110	Small	4 Vertical 1 Horizontal	51 - 81cm
EB-7111	Medium	5 Vertical 1 Horizontal	71 - 96.5cm
EB-7112	Large	6 Vertical 1 Horizontal	96.5 - 117cm

DRESSING SLEEVE

BEST SELLER

PROVIDES ASSISTANCE TO A PERSON WHO HAS DIFFICULTY DRESSING.

Made with slide sheet fabric to ensure that clothes easily slide on. Once clothes are on it can easily be removed.

EB-7010



Don't forget

You can order online too!
countrywidehealthcare.co.uk

It's fast & easy and has a handy budgeting tool!

Give it a try today



CIRCUMFERENCE MEASURE

BEST SELLER

THE SECA 201 TAPE MEASURE

- Measurement Range: 205cm
- Division: 1mm
- Diameter: 70mm
- Height: 22mm
- Weight 55g



EB-2132

HEIGHT MEASURE 206 MODEL

Rolls up to order: automatic metal tape measure for wall mounting

- Measuring range: 0 - 220cm



EB-2118

DIGITAL HOIST WEIGHERS - 941 MODEL

- Attaches to most hoists to provide a weighing and handling facility
- Rechargeable function for stand alone operation
- Automatic reduction of sling weight
- Body Mass Index function
- CE Approval CLASS III
- 4 Years warranty

MAX WEIGHT 200KG



EB-2121

PORTABLE HEIGHT MEASURE - 213 MODEL

- Simple and easy to set up - no wall fastening necessary
- Large floor plate ensures stability
- Result clearly visible while measuring
- Convenient and easy to transport

EB-2100



EB-2100-CASE

ELECTRONIC PERSONAL SCALES - 875 MODEL

- Very light and robust flat scales
- Integrated display, Class III
- Tap-on switch to use
- Automatic switch off
- Maximum user weight 200Kg
- 4 Years warranty

MAX WEIGHT 200KG

EB-2103



FLOOR SCALES - 761 MODEL

- Stove enameled steel finish
- Large dial scales
- Nonslip cover
- 150kg capacity
- CE Class III

MAX WEIGHT 150KG

EB-2114



ELECTRONIC CHAIR SCALE - 955

MAX WEIGHT 250KG

- Functions: TARE, HOLD, BMI, automatic switch-off
- Swivel Arm Rests
- Large Foot Rests can be folded completely out of the way so the patient can safely & comfortably take a seat
- Features rechargeable battery
- The onboard pouch houses the battery recharging mains adaptor
- Locking rear wheels
- CE Approval class III
- Capacity: 250kg
- Graduation: 50g



4 YEARS WARRANTY

EB-2117

ELECTRONIC CHAIR SCALE - 956

MAX WEIGHT 200KG

The new 956 mobile chair fulfills all basic medical standards.

- Electronic function uses 6x AA batteries (included)
- Functions: TARE, HOLD, automatic switch-off
- Swivel arm rests
- Foot rests folds away
- Locking rear wheels
- CE Approval class III
- Capacity: 200kg



4 YEARS WARRANTY

EB-2099

MAINS LEAD CHAIR SCALE CHARGER - 683

Power adapter with a quick release plug to prevent cable damage. Compatible with Seca 955 & 959 chair scales.

4 YEARS WARRANTY



EB-2137

DIGITAL WHEELCHAIR WEIGHER 665

MAX WEIGHT 300KG

- Accommodates wheelchairs with a wheel base up to 850 x 700mm
- Body Mass Index function
- Folds up for storage when not in use
- Auto hold of correct weight
- Capacity-300kg (with Pre-TARE)
- Includes rechargeable unit
- Size: 1102 x 912 x 1150mm
- CE Approval class III
- Built in wireless connectivity
- Free demo in certain areas



4 YEARS WARRANTY

EB-2119

DIGITAL WHEELCHAIR SCALE - 677

MAX WEIGHT 300KG

With railing & transport castors

- Functions: pre-TARE, TARE, HOLD, BMI, weight range switch over
- Intelligent functions for comfortable weighing
- Dimensions: W 920 x H 1120 x D 1150mm
- Platform: W 760 x H 55 x D 930mm
- CE Approval class III
- Wireless connectivity
- Free demo in certain areas
- Mains powered
- Capacity 300kg (with Pre-TARE)



EB-2134

4 YEARS WARRANTY

ECG MACHINE CT8000I-2

The 2nd generation of Seca's best-selling 12 lead ECG compact, portable & enhanced technology

- Compatible with all leading EMR systems - emis, SystemOne, Vision and others...
- Designed with ease of use in mind - enter patient data at the touch of a button - On-screen preview of ECG prior to printing and a simplified keyboard
- 5" colour high resolution LCD display
- High sampling frequency and a large frequency band, the sec CT8000I-2 provides optimal signal quality for adult and paediatric ECG's
- Advanced clinical interpretation ETM algorithm
- Compact lightweight design: 1.9kg
- QTc interval - ideal for Mental Health
- QTc formulas: Bazett, Fredericia, Framingham or Hodges
- High volume internal memory: storage of up to 100 ECGs



EB-2202

1 OXYGEN CYLINDER TROLLEY

- Designed to carry flat bottomed cylinders available from pharmacy
- Cylinder AF 66 x 18cm

EB-3491

2 SCREEN FRAME

AN OPTION OF CURTAINS OR SOLID PANELS

- Four panel screen frame
- White epoxy coated
- Can be folded completely flat
- Swivel castors
- H 168 x W 244cm (open)
- H 168 x W 61cm (closed)

PANELS - SET OF 4

- FR solid panel
- H 141cm x W 57cm each panel
- White

CURTAINS - SET OF 4

- White PVC

EC-1139	Screen Frame	
EB-1159-WH	White PVC Curtains	Set of 4
EC-1099	White Panels	Set of 4

3 DRESSING TROLLEY

Mild steel frame with removable aluminium shelves
CHOICE OF 2 SIZES

EC-1143	46 x 46cm
EC-1142	61 x 46cm



4 LEG REST

- Economical leg rest
- Flat vinyl surface with heat sealed seams
- Frame finished in a tough epoxy polymer finish
- Fire retardant easy to clean fabric
- Tough epoxy coated finish
- Variable height (385 mm - 535 mm)
- Maximum User Weight 101kg

MAX WEIGHT 101KG

EB-3014 Without Castors

EB-3013 With Castors

5 DRIP STAND

FREESTANDING

- Adjustable height
- Dual nylon hooks to hold separate bags
- Five star base with anti-static swivel castors

EB-3084

6 2 SECTION EXAMINATION COUCH

- Maximum user weight 225kg (35st.)
- Gas strut assisted multi-position head and foot sections
- Back rest and leg rest angle adjustment +85°/-30°
- Variable height range of 45-98cm
- Easy to use handset (Electric models only)
- 60mm (FR) contoured upholstery with rounded corners
- Anti bacterial/anti-microbial additive helping reduce MRSA and other bacteria
- 4 retractable 50mm positioning castors and adjustable leveling foot
- Hoist clearance 13cm
- Paper roll holder included
- 3 year warranty on moving components
- 7 year warranty on frame
- Choice of hydraulic or electric model

MAX WEIGHT 225KG

EB-3222

Please state colour & hydraulic or electric when ordering

COLOUR OPTIONS FOR 2 SECTION EXAMINATION COUCH & MEDICAL GAS LIFT STOOL





FALL SAVERS WIRELESS MONITOR

Cut the cord with next generation Fall Management Solutions.

The Fall Savers Wireless Monitor can be used with wired or wireless bed, chair or floor sensor pads and a range of optional wireless peripherals to meet the needs of the person in your care.



Safer for patients;
less work for staff



Bed and chair pads available



One monitor works with
2 sensor pads



Options include call button,
pager, floor sensor mat and
door/window exit alerts



Call Button

Floor Sensor Pad

Pager

Bed Sensor Pad

Chair Sensor Pad

Integrates with most
Nurse Call Systems



FALL SAVERS WIRELESS MONITOR

- Ability to use one monitor with two sensor pads or other wireless devices simultaneously
- Recordable personalised voice alert feature
- Battery or mains powered with low battery indicator
- Silent Alarm option eliminates noise in room
- Can be interfaced with most nurse call systems (optional cable required)
- Multiple monitoring options include: Bed, Chair and Floor Sensors, Wireless call button, Door/window alarm & Portable LCD pager

WORKS WITH A RANGE OF SENSOR PADS



ED-5900	Wireless Monitor
ED-5965	Mains Power Adaptor
ED-5960	Nurse Call Kit

ANTIBACTERIAL CHAIR SENSOR PAD

Chair Sensor pad used to activate an alert on the Fall Savers Monitor when a person's weight moves off the sensor pad.

*REQUIRES: **ED-5908** for wireless or **ED-5927** for wired connectivity to **ED-5900** Fall Savers Wireless Monitor.



ED-5905

ANTIBACTERIAL BED SENSOR PAD

Foldable Bed Sensor pad used to activate an alert on the Fall Savers Monitor when a person's weight moves off the sensor pad. Can be folded for easy storage.

*REQUIRES: **ED-5908** for wireless or **ED-5928** for wired connectivity to **ED-5900** Fall Savers Wireless Monitor.



ED-5904

TREADNOUGHT FLOOR SENSOR PAD

Floor sensor pad used to activate an alert on the Fall Savers Monitor when a person steps onto the sensor pad.

*REQUIRES: **ED-5907** for wireless or **ED-5928** for wired connectivity to **ED-5900** Fall Savers Wireless Monitor.

ED-5906	Floor Sensor Pad
ED-5986	Anti-Slip Mesh



BEST SELLER

SENSOR PAD TRANSMITTERS FOR WIRELESS CONNECTION:

WIRELESS TRANSMITTER FOR FLOOR SENSOR PAD



Wireless transmitter for use with floor sensor pads to allow for wireless connectivity with ED-5900 Fall Savers Wireless Monitor.

ED-5907

WIRELESS TRANSMITTER FOR CHAIR/BED SENSOR PAD

BEST SELLER



Wireless transmitter for use with chair/bed sensor pad to allow for wireless connectivity with ED-5900 Fall Savers Wireless Monitor.

ED-5908

WIRELESS CALL PENDANT

Wireless call pendant for use with Fall Savers Monitor, activates alert on monitor when call button is pressed.

- Compact sealed transmitter with lanyard featuring a break-away clasp
- Wireless supervision with Fall Savers Monitor
- For Use up to 15 metres away from monitor (depending on environment)
- Up to 2-year battery life



ED-5903

SENSOR PAD PIGTAIL LEADS FOR WIRED CONNECTION:

1 METRE PIGTAIL LEAD FOR CHAIR SENSOR PAD



Pigtail lead for use with chair sensor pad for direct wired connection to ED-5900 Fall Savers Wireless Monitor.

ED-5927

2 METRE PIGTAIL LEAD FOR BED/FLOOR SENSOR PAD



Pigtail lead for use with bed / floor sensor pads for direct wired connection to ED-5900 Fall Savers Wireless Monitor.

ED-5928

WIRELESS DOOR/WINDOW ALARM

For use with Fall Savers Monitor to activate alert on monitor if a monitored door or window is opened.

- Small compact door/window transmitter with magnetic contact
- On/off switch allowing flexibility of use during day and night
- Wireless supervision with Fall Savers Monitor
- For use up to 15 metres away from monitor (depending on environment)
- Up to 2-year battery life



ED-5901

WIRELESS LCD PAGER

Portable LCD Pager for use with Fall Savers Monitor to alert care giver remotely when alert is activated on monitor.

- Can be paired with multiple Fall Savers Monitors to display alerts
- Audible or vibrate notification
- for use up to 15 metres away from monitor (depending on operating environment)
- Battery operated with low battery alert (requires 2-AA Batteries – not included)



ED-5902



TREADNOUGHT FLOOR SENSOR PAD - FOR NURSE CALL SYSTEMS

BEST SELLER

The TreadNought floor sensor pad is compatible with most nurse call systems (correct pigtail lead required). The floor sensor can be placed at the bedside, doorway or other location to activate the nurse call system when a resident at risk of falling stepson onto the sensor pad.

CONNECTS TO MOST NURSE CALL SYSTEMS



Range of nurse call connection leads available P.O.A



ED-5906	Floor Sensor Pad
ED-5925	Mono Jack Pigtail Lead 3 Metre
ED-5924	Stereo Jack Pigtail Lead 3 Metre
ED-5986	Anti-Slip Mesh

INFRARED BEDSIDE MONITOR

- Connects to most nurse call systems (cable not included)
- Typically used by a bedside or mounted to a door
- An alternative for when sensor pads are undesirable
- Battery or mains powered with low battery indicator
- Alarm options allow for the alarm to sound locally on the monitor or remotely through an existing nurse call system or portable pager (nurse call cable and pager optional)
- Supplied with a swivel bracket for easy mounting and adjustable positioning
- Optional C clamp extension bracket is available for mounting to a bed frame

EMITS AN INFRARED BEAM AND TRIGGERS AN ALARM TO ALERT A CAREGIVER WHEN MOVEMENT IS DETECTED

1	ED-5992	Monitor
2	ED-5960	Nurse Call Kit
3	ED-5993	C Clamp Extension Bracket
	ED-5919	Mains Power Supply
	ED-5984	Paging Set



ALERT BUTTON NURSE CALL LEAD

- For residents to call for assistance via an existing nurse call system
- Interfaces with most mono nurse call systems, stereo adaptor available
- Sealed call lead has an easy touch button
- Easy clip fastener attaches lead to bed linen or clothes

ED-5991	Nurse Call Lead - 3M
ED-5970	Mono-Stereo Adaptor



D E M E N T I A C A R E

THE THERAPY & ACTIVITIES

A supportive selection of products to help with dementia care, from communication tools to therapy and reminiscence activities.

- Sign Posting & Orientation
- Reminiscence Tools
- Daily Activities
- Outdoor Games
- Music & Instruments
- Sensory Resources
- Therapy Dolls & Pets



2 YEARS WARRANTY

A RANGE OF SIGNAGE WHICH PROVIDES CLEAR COMMUNICATION FOR YOUR RESIDENTS

DOOR SIGNAGE

Features:

- Contributes significantly to supporting independence and security
- Can be translated into other languages; please request a quote
- Self-adhesive - 1mm thick
- Anti-bacterial and anti-fungal growth properties

We recommend signs are fixed between 1.2 - 1.4m from floor level, so they remain in the field of vision.

BEDROOM

- Create a sense of ownership and dignity
- Aid recognition and improve orientation
- Support a person-centred approach



COMMUNAL

These signs create highly visible and readily understandable landmarks that promote confidence and help people to function more easily in their home environment.



COLOUR OPTIONS



Please specify colour when placing your order.

Code	Room	Width	Max Height
UC-0021	Bedroom	300mm	136mm
UC-0020	Bathroom	300mm	150mm
UC-0025	Toilet	300mm	166mm
UC-0024	Lounge	300mm	122mm
UC-0023	Kitchen	300mm	115mm
UC-0022	Dining Room	260mm	160mm

TOILET & BATHROOM

We take 'finding the toilet' for granted, yet we've all experienced the stress and anxiety of needing a toilet and not being able to locate one, or worse, perhaps not getting there in time.

When dementia is brought into the equation, the difficulty and frustrations are multiplied, resulting in anxiety, challenging situations and potentially the loss of dignity and independence.

Through good design and the compelling dynamics of colour, we have incorporated action-prompts which help get residents to the toilet independently.



ORIENTATION BOARDS

Designed for use in an individual's room or their own home

- Simple, dry-wipe aid for recording important pieces of information
- Includes set of card inserts for: - day/date/ month - weather and dry wipe pen
- Dry-wipe, non-reflective surface
- Secure, simple, hidden fixings
- Clock & battery

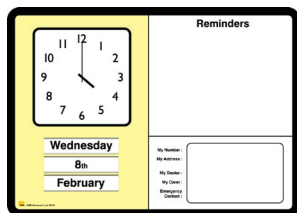

UC-0507

PERSONAL

- Reminders section
- Contact details section
- Size 594h x 420w mm

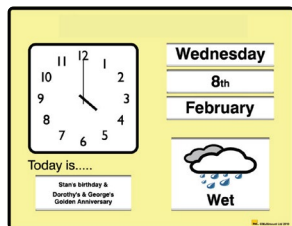

UC-0508

GENERAL

- Daily event section
- "Today is..."
- Size 700h x 900w mm

MENU BOOK

Easy to understand book helps reduce frustration & misunderstanding

- Colourful images of commonly eaten dishes provide an effective way of expressing menu choices at a time when communication can often be difficult
- Includes 3 wipe-clean boards to write own choices
- 21 ring bound pages

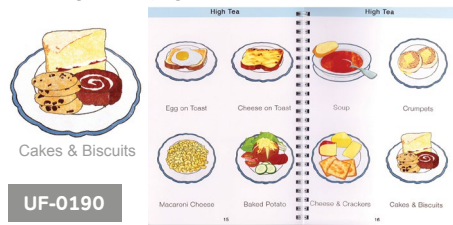

UF-0190

ACTIVITY BOARD

- Antibacterial & anti-fungal growth properties
- Full 7 Day week on view
- Eye-catching & informative
- Includes dry wipe pen
- Chemical & water resistant
- Sturdy construction
- Dry-wipe
- Non-reflective surface
- Easy to clean
- 700 x 1000mm



UC-0503

MENU BOARD

BEST SELLER

- An effective way to communicate menus
- 7 holders to display pictures
- 870 x 720mm

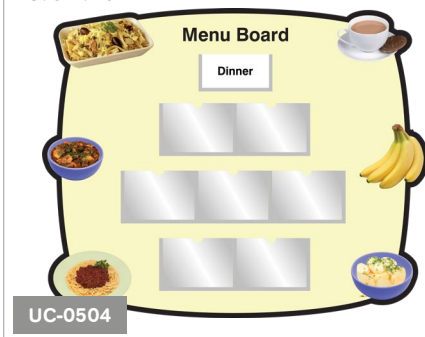

UC-0504

MENU CARDS

- Menu cards to stimulate communication and individual choice
- Wipe clean lamination
- Pack of 240
- 140 x 95mm



UC-0520

SNAP FRAME FRONT OPENING

- Ideal for photo displays/ menu's, office notices and more...
- Posters or notices are kept clean behind a UV anti-glare PVC cover
- Snap shut front opening mechanism
- Frames hinge outwards making posters or notice changes fast and easy
- Finished in silver anodised aluminium
- Pre-drilled fixing holes
- Wall mounting, for interior use only

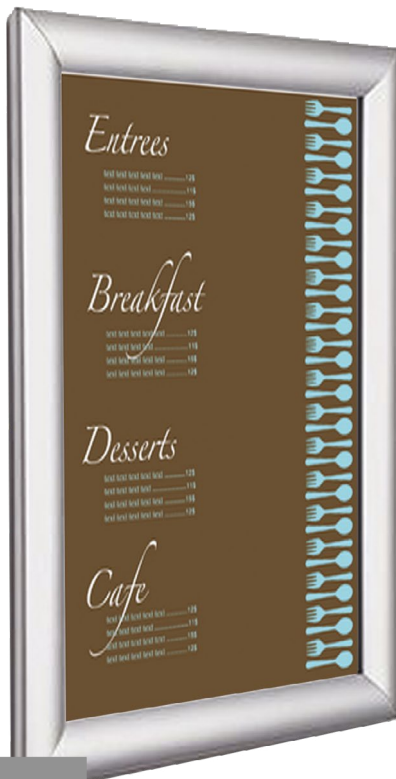

BEST SELLER

Code	Size
UC-0031	A4 (210 x 297mm)
UC-0032	A3 (297 x 420mm)
UC-0033	A2 (420 x 594mm)

MEMORY BOX PROVIDING A 'POTTED' HISTORY OF THE INDIVIDUAL

Memory Boxes enable powerful life-story work to be brought into the wider environment. They provide points of great interest around the home and, more importantly, provide a highly recognisable landmark which is a powerful tool for room recognition and orientation. Promoting a person-centred approach and providing carers and visitors with valuable opportunities for interaction.

- Slide out front acrylic panel
- Removable acrylic shelf
- Keyhole slot wall fixing
- No pins required: Supplied with six velcro style tabs to fix the photos to the back of the box
- Size 400h x 300w x 68d mm

We recommend that the Memory Box is fixed at a height of between 1.2-1.4m from floor level, to ensure it remains in the field of vision of the user



UC-0501

Pictured contents not included
Available in Beech and Oak
 Please specify colour when placing your order

view our range of
**reminiscence
 content packs**
 featured on
 pages xxxx



1950'S HOUSEHOLD

- Ration Book
- Radio Rentals Brochure
- Hygena Kitchen Pamphlet
- Food Booklet
- Ponting's Fashion Catalogue
- Miscellaneous Ephemera
- Name Cards



UF-0192

1960'S CHILDHOOD

- Elisdens Novelty Catalogue
- Beatles Ticket
- Fleetway Annuals Brochure
- Toy Leaflets
- School Report & Essay
- Tricycle Flyer
- Trade Cards



UF-0193

THE GARDEN

- Woolworth Booklet
- Lawnmower Leaflets
- Variety of Paperwork
- "Garden Work" Newspaper
- Miscellaneous Images
- Trade Cards



UF-0220

SEASIDE HOLIDAYS

- Holiday Camp Pamphlets
- I-Spy Booklet
- Hotel Leaflets
- Entertainment Programme
- Boxing Flyer
- Postcards
- Trade Cards



UF-0194

BATTLE OF BRITAIN

Complete replica of the Daily Sketch newspaper from June 19th 1940, outlining the RAF's offensive, London evacuation, What to do if Britain is invaded, radio listening and local adverts.

UF-0223



VICTORY IN EUROPE

Complete replica of the Daily Sketch from 8th May 1945 when the King declared a Public Holiday to celebrate Victory in Europe.

UF-0222



TITANIC

Daily Mirror from April 1912, covering the sinking of the world's largest liner during her maiden voyage.

UF-0224



REMINISCENCE REPLICA BOOK & CARD PACKS

'Pastimes' is a new, fully illustrated reminiscence book and card set, featuring pastimes and activities from previous decades of life in Britain. It will evoke happy childhood memories of playtime games and hobbies, television shows, teenage pursuits, entertainment and sporting personalities from the 1940's to the 1970's.

Decades cards are double-sided laminated cards with a carers' information sheet. Themes include Hollywood and film across 40's, 50's & 60's.

Decades book features beautiful colour illustrations from the 1940s to the 1960s in Britain, as well as black and white pages for colouring.



PASTIMES BOOK
UF-0202



DECADES BOOK
UF-0195

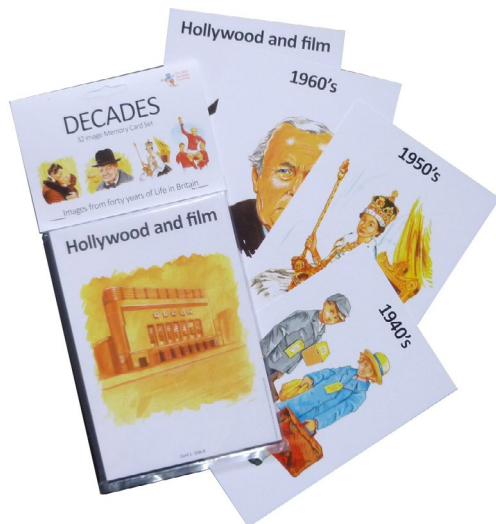

DECADES CARDS
UF-0196



PASTIMES CARDS
UF-0203

ACTIVITY APRON

BEST SELLER

The Activity Apron assists with improved coordination and helps users to re-learn everyday skills such as zips, pockets and buttons. Featuring multiple areas to develop the skills needed to dress oneself, the activity apron is an affordable and fun tool.

Ideally suitable for:

- People with dementia and Alzheimer's
- Ongoing conditions that affect coordination
- Aids in the re-learning of everyday skills such as zips, pockets and buttons
- Can be worn around the neck or placed on the lap
- 210 x 210 x 20mm
- Net Weight 0.125gms



UF-0152

DART BALL

BEST SELLER

- Throw the balls at the brightly coloured target and count your score
- Encourages motor skills and hand/eye coordination.
- Made from wipeable fabric and strong velcro
- Can be easily hung up and carried



UF-0197

LUDO BOARD GAME

Hours of fun with this traditional game of Ludo in bright primary colours!



UF-0213

DRY WIPE MARKERS

- Wipe off with a dry cloth
- Assorted colours
- Chisel tipped

4
PACK



UF-0008

DOMINOES

A traditional box of deluxe domino tiles for the serious player or could be used as a counting game for the younger members of the family.



UF-0211

LOW VISION PLAYING CARDS

- LARGE indices
- Approx. 6 x 9cm

BEST SELLER



UF-0005

PLAYING CARDS

High quality premium regular sized playing cards.
Perfect for card games and group events.



UF-0212

THROW AND TELL ACTIVITY BALL

BEST SELLER

- The beauty of this game is its' simplicity – catch the ball and answer one of the questions by one of your thumbs.
- Encourages people to discuss familiar, comfortable information that is unique to them
 - Enables people to express meaningful, personal preferences in a no-pressure situation
 - Prompts unchallenging interaction
 - Promotes physical movement and hand-eye coordination
 - Generates information carers can utilise to make people happier and more comfortable
 - Weight: 132g
 - 6" (150mm dia)

UF-0085



TARGET GAME

The Target Mat is a fun interactive game for all ages.

- Mat made from heavy duty PVC coated nylon
- Easily rolled, easy storage
- Comes complete with 8 bean bags
- A fun game for all ages
- Size 1m²

UF-0020



JUMBO DOMINOES

A giant version of the classic game, 28 piece massive black & white dominoes.

- Easy to see for anyone with poor eyesight
- Waterproof
- Ideal for all ages
- Easy to handle
- 18 x 10 x 2.5cm

UF-0015



GIANT NOUGHTS & CROSSES

A huge version of the traditional Noughts and Crosses.

- Quick and easy setup
- Suitable to play outdoors or indoors
- Interlocking game pieces for easy storage
- Ideal for all ages
- 90cm²

UF-0014



QUOITS SET GAME

This game is great for for all the family. Just throw the rope quoits over the pegs to score points.

- Incredibly easy to set up and play
- Suitable to play outdoors or indoors
- Comes in a canvas holdall for storage
- Ideal for all ages

BEST SELLER



UF-0025

JUMBO 4 IN A ROW

The perfect giant challenge. The first to get "4 in a Row" is the winner!

- Quick and easy setup
- Suitable outdoors and indoors
- Ideal for all ages
- 46cm x 52cm

UF-0001



BALL PACK

Ideal to use with parachute canopy (UF-0010)

- Lightweight - promotes physical movement and hand-eye coordination
- 1 each of: Red, Yellow, Blue & Green
- 21cm Dia

Supplied deflated.

Can be inflated with a standard pump and needle.

UF-0012



PEDAL EXERCISER

The Pedal Exerciser is an easy to use item for home exercise. Enables upper and lower body exercise from a seated position.

- Pedals can be moved forwards or backwards
- Resistance can be adjusted
- Use feet in the pedals to exercise legs, hips and buttocks
- Rest on a table and turn the pedals with arms for an upper body workout
- Product Dimensions (mm): 285x500x405
- Net weight (kg): 2.2



ED-3022

PARACHUTE CANOPY

Parachute canopies bring excitement and something new to group activities.

- Helps to develop & create trust
- A wide variety of different games can be played
- Light nylon material as used for real parachutes
- 8 hand holds along the edge
- 1.75m dia

UF-0010



PARACHUTE PLAY BOOK

Features over 24 activities

UF-0011



10 PIECE PERCUSSION MUSIC SET

Set includes 10 different percussion instruments in a PVC zip storage bag.

Contains - a pair of maracas, a pair of castanets, tambourine, triangle and beater, pair of claves, rhythm-clapper, single tone guiro and beater, a pair of finger cymbals, wooden shaker pot and 13 bell jingle stick.



UF-0231

SING ALONG MUSIC CD

Specially recorded for those with no access to a piano. Features 20 of the songs from the Song Book. Each song has introductory melodies to reacquaint the group with the tune.

Songs include:

- 'My Bonnie is Over the Ocean'
- 'Lets all go down the Strand'
- 'I'm Henry The Eighth'
- 'I Love A Lassie'
- 'Roll out the Barrel'
- 'We'll Meet Again'
- 'Cockles & Mussels'
- 'Auld Lang Syne' and many more...



UF-0049

MUSICAL BINGO

A musical version of the ever popular game! More than 10 seconds of the song is played and the participant marks off the song on their game sheet.

Set contains:

- 2 CDs
- 20 game sheets
- Printable song list & guidance booklet

Songs include:

- 'Auld Lang Syne'
- 'Greensleeves'
- 'I'm Forever Blowing Bubbles'
- 'Wedding March' and many more...



UF-0067

MUSICAL QUIZ

- Simply listen to a few bars and name that tune!
- 80 melodies designed to bring back memories
- Can be used as a sing along

Songs include:

- 'Catch A Falling Star'
- 'Zip-A-Dee Doo-Dah'
- 'Gregory Girl'
- 'Moon River'
- 'Born free'
- 'Delilah' and many more...



UF-0053

GLITTER TUBE

A wonderful and robust multi-sensory resource. The rhythmic flow and motion of the shiny contents as they swirl and sparkle along the tube is pretty and mesmerising, great for tracking and focus skills, and will fascinate all ages.

Available in 4 colours
Colours may vary



UF-0232

SMALL LIQUID TIMERS

Turn them upside down and watch the bubbles fall and bounce to the bottom.

- Captivating liquid timer
- Popular sensory aid
- Entrancing colours & flow
- Use to teach colours & the concept of time

4
PACK



UF-0123

VISUAL EFFECTS SENSORY BAG

Contains a range of visual effects. A mixture of slow and quick moving colours and alternating shapes which can encourage calmness or stimulates and excites the user to concentrate.

Ooze Tubes and Glitter Tubes provide slow movement whilst the jumping Bean Motion is quick and exciting. The Magnifying Glass, Kaleidoscope and Magic Eyes are all visually stimulating and rewarding.

- Over 25 sensory items
- Items provide a range of visual effects
- Dramatic shapes and colours to stimulate senses
- Items come in a drawstring bag
- Contents may vary

25+
ITEMS



UF-0150

S Q U A W K E R B L U E B I R D

The perfect walker accessory

Introducing your newest companion: These cheery, animatronic birds are the perfect walker accessories. Designed to deliver joy, fun, and companionship to older adults and their families. Perched playfully atop of walking devices, Walker Squawker birds aim to bring joy to every step!

As a Companion: CHIRPBACK technology mimics the sounds of real birds. Built-in sensors allow Walker Squawkers to detect light, sound, touch, and movement - making this a truly interactive companion!

As a Walker Accessory: When perched atop a walking device, Walker Squawkers will sense motion and sing along happily as they "unlock" six songs. When the Walker Squawker detects that walking has stopped, it will playfully sing a "don't forget me" song to remind its owner of its presence.

Perch included. Batteries Included: 3x AAA Alkaline Batteries

UF-0126



B A B Y T H E R A P Y D O L L

For individuals who enjoy comforting others

BEST SELLER

Therapy dolls are the perfect companion to encourage affection and a natural care instinct. Holding the doll soothes and comforts plus creates a sense of purpose.

- Soft huggable body
- Supplied with 2 outfits; 1 pink, 1 blue
- Eyes remain open so not to cause anxiety
- No noise to alleviate distress
- Baby weight approx. 1kg
- Baby height 21.5"
- Clothing can be washed at 40 degrees
- Body can be cleaned with a damp cloth



UF-0074

THERAPY PETS

BEST SELLER

Experience the delight that pets can provide

Therapy Pets have been developed with extensive feedback from ageing loved ones, their families, and caregivers to provide comfort, companionship, and fun - **but don't take our word for it!**

- Built-in sensors respond to motion and touch
- Batteries Included: 4 x 1.5V C Alkaline Batteries

THE THERAPY GOLDEN PUP THE PERFECT PUPPY

In between naps and being adorable, real puppies require lots of special attention. The Therapy Golden Pup has all the love in the world to give and will never eat the mail or have an accident.

FEATURES

- Feel the heartbeat with your calming touch
- Lifelike coat and authentic sounds
- Responds to your voice with "BARKBACK" technology

UF-0301



Feel Golden Pup's heart beat
With your calming touch



Lifelike coat & authentic sounds
For pleasing tactile interactions



Responds to your voice
With barkback technology



THE THERAPY CAT THE PURRFECT COMPANION

Thanks to built-in sensor technology, therapy cats respond to petting, hugging and motion much like the real ones you know and love but don't require any special care or feeding.

FEATURES

- Realistic, soft fur looks and feels like a real cat
- Cat-like movements and sounds
- VibraPurr™ sounds and feels like real purring



Cat-like movements & sounds inspired by real felines



VibraPurr™ Sounds and feels like real purring



Soft Premium Fur
For pleasing tactile interactions

SILVER & WHITE CAT	UF-0300	BLACK & WHITE CAT	UF-0302
GINGER & WHITE CAT	UF-0099		

CATERING

KITCHEN & DINING ESSENTIALS

A huge selection of catering products from full table settings to food prepping equipment.

- Sustainable Single Use
- Cups & Jugs
- Crockery & Glassware
- Serving & Tableware
- Kitchenware & Electricals
- Hygiene & Paper





SUSTAINABLE, HIGH QUALITY & COST EFFECTIVE

The ALSO Green range has been carefully sourced to minimise its impact on the environment and to ensure we meet internationally recognised standards and accreditations. A high percentage of the ALSO Green range is manufactured in the British Isles to support our commitment to the reduction of our carbon footprint.

The Socius Network is a prominent member of the Foodservice Packaging Association (FPA)



Compostable

Breaks down in 8-12 weeks into natural organic compost, within commercial composting facilities



Biodegradable

Breaks down by the action of micro-organisms in to the natural environment

22CM COMPOSTABLE PLATE



500
PACK

These super strong plates are sturdy and microwavable, water and grease resistant making them perfect for serving hot or cold food. Made from waste paper cuttings from Huhtamaki's paper cup manufacturing process and is fully compostable and biodegradable.

AE-1502

COMPOSTABLE CUTLERY



CPLA Cutlery is made from 100% renewable resources, including corn starch and is fully compostable. It complies with European Standard EN13432.

AE-1503	Eco Knife
AE-1504	Eco Fork
AE-1505	Eco Spoon
AE-1506	Eco Teaspoon

PACK OF
1000
PER CODE

12OZ COMPOSTABLE SMOOTH WALL TUMBLER



Strong and crystal clear, PLA cold drink cups are made from a natural corn based bio polymer and can be composted after use.
• Holds 354ml

AE-1500

1000
PACK

CHICOPEE® J-CLOTH® PLUS BIODEGRADABLE AND THE BIODEGRADABLE AND COMPOSTABLE GENERAL CLEANING WIPE

BEST SELLER



- Lightweight
- Biodegradable and compostable
- Has a unique, open, wavy texture that enables efficient pick-up of any dirt to deliver the most effective green cleaning solution
- Reduce the risk of cross-contamination
- Ideal for the healthcare environments
- Cloth remains fresher for longer
- Excellent dirt pick up due to holes
- Environmentally friendly
- FCC approved
- 43 x 32cm

MEETS ENVIRONMENTAL STANDARD EN 13432

COLOUR OPTIONS



Please specify colour when placing your order



DB-9021

50 PACK

BIODEGRADABLE PAPER TOWELS - 2PLY



White
Each sleeve contains 162 sheets

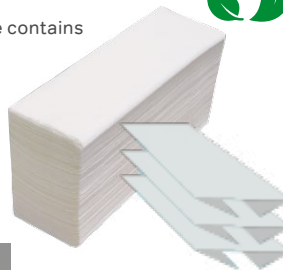

CASE OF 15 SLEEVES

DB-8127

COMPOSTABLE CADDY LINERS

BEST SELLER

- Made with cornstarch
- EN13432 certified for collections and for home composting
- Guaranteed free of any genetically modified DNA
- EU manufactured under ISO9001 & 14001 using 100% renewable energy (coastal wind) and 0% water (recirculated)



DA-0874	5Ltr	Pack of 52
DA-0873	7Ltr	Pack of 52
DA-0879	10Ltr	Pack of 25

LAUNDRY LEAVES NON-BIO DETERGENT SHEETS

NEW

Laundry Leaves is a revolutionary, eco-friendly and sustainable alternative to conventional laundry detergent, gels or pods!

- Vegan
- Eco-friendly
- Plastic-free
- Heavily reduces plastic waste



25 PACK

HC-3204

25LTR & 50LTR RECYCLING BINS WITH LIDS

- Available in two sizes
- Graphite main colour
- Choice of 4 lid colours for various recycling uses
- Easy to clean
- Handy slim-line fit for 25 litre unit

COLOUR OPTIONS



Please specify colour when placing your order



HB-0708	25Ltr
HB-0709	50Ltr

POLYCARBONATE BEAKERS

Suitable to take straws

**BEST SELLER****HIGH IMPACT
HEAT
RESISTANT**

CD-3316	Feeder/drinking cup with 2 handles, 250ml
CD-3317	Beaker No Handles 250ml
CD-3320	Narrow Spout Lid for Beaker CD-3317
CD-3321	Wide Spout Lid for Beaker CD-3317

TRANSLUCENT BEAKERS

- Polycarbonate clear beaker
- Coloured option in Copolyester
- available in: Blue, Purple, Green, Red and Clear



CD-0934	Clear 2 Handled Beaker
CD-0935	Coloured Handled Beaker
CD-0932	Narrow Spout Lid
CD-0933	Wide Spout Lid

TWO HANDLE CUP

- Lightweight, strong and durable
- Non-drip, non-scratch
- Narrow spout and feeder lids
- Vent hole in lids helps to cool hot drinks & controls liquid flow

**CD-0930****TWO HANDLE NOSE CUT-OUT**

- Available in White or Clear
- 225ml

Please state colour when ordering

**CD-3021****NOSE CUT-OUT CUP**

- Ergonomically designed
- Allows the user to drink easily without having to tip head back
- Textured Surface for better grip
- Dishwasher safe up to 70°
- Translucent to monitor fluid intake
- Colour may vary from image shown

**CD-3025****SINGLE HANDED MUG WITH LID**

- Large handle to grip round and under
- 1 x Anti-spill feeder rim lid
- 1 x Drinking spout
- Mug dishwasher safe lids handwash only

**CD-0931****ONE-WAY DRINKING STRAW**

- Stays filled with liquid which reduces air ingestion
- Less effort required by user
- Leads to less coughing & choking while drinking
- Adjustable clip

**CD-3024****COMPOSTABLE BLACK PLA DRINKING STRAWS**

(5mm x 195mm)

**CC-0943****250
PACK**

SCOOP PLATE & BOWL

The specially designed scoop plate and bowl that helps those with limited dexterity making it easy to scoop food onto fork or spoon

- Features non-slip suction base
- Dishwasher safe

Please state colour when ordering, options White & Red



CD-3027	Scoop Plate
---------	-------------

CD-3026	Scoop Bowl
---------	------------

PLATE SURROUND**BEST SELLER**

- Clips to circular plates (8-10 in)
 - Dishwasher & microwave safe up to 70°C
- Please state colour when ordering, options White & Red



CD-2175

TENURA NON-SLIP ROLL & MAT

Will adhere to a surface, but can also be removed easily with no residue left behind.

- Made from non toxic silicone
- Excellent grip qualities
- Dishwasher safe
- Prevents items from sliding on surfaces
- Holds chopping board and appliances in position
- Anti-Slip Grips wrap around objects for better grip



CD-1090	Roll 1 metre x 20cm
---------	---------------------

CD-1091	Mat 25.5cm x 18.5cm
---------	---------------------

CD-1089	Mat 35.5 x 25.5cm
---------	-------------------

EASY GRIP CUTLERY & UTENSIL STRAP

- Ideal for limited hand/ arm movements
- Knife - easy cutting using a rocker motion
- Fork & Spoon - bend to any angle to suit user
- Easy grip handles
- Dishwasher safe
- Also available in Red



1	CD-1095	Rocker Knife
	CD-1096	Bendable Fork
	CD-1098	Bendable Spoon
	CD-1099	Bendable Teaspoon
2	CD-1097	Utensil Strap
3	CD-1113	Anti-Slip cutlery grips (pack of 2)

SUPERSAFE CUTLERY

When your duty of care calls for a safer and sensible alternative to the potential dangers of metal, hard plastic or disposable cutlery, SuperSafe™ is the proven first choice for safety, reliability and economy.

The SuperSafe™ Spork

is a 2-in-1 combination spoon and fork.

The SuperSafe™ Knife has a unique rippled blade design that cuts through food but can't be used as a weapon. It can't be snapped or sharpened: it's the practical and safe alternative to a conventional metal, hard plastic or disposable knife.



10
PACK

DB-0865	Spork Pack of 10
---------	------------------

DB-0866	Knife Pack of 10
---------	------------------

750ML JUG & MATCHING LID

- Copolyester
- Microwave & Dishwasher safe
- Jugs available in: Green, Purple, Red and Clear
- Lids available in: Green, Red and Purple
- Please state colour when placing your order



CB-8064	750ml Jug
CB-8069	Jug Lid

1.1 LITRE JUG & MATCHING LID

- Microwave & Dishwasher safe
- Jugs available in: Emerald Green, Red, Blue, Yellow and Clear
- Lids available in: Emerald Green, Red, Blue, Yellow and White
- Please state colour when placing your order



CB-8106	1.1Ltr Jug
CB-8107	Jug Lid

LOCKER SET

- Set contains:
- 250ml beaker
 - 1Ltr jug
 - Tray



CB-2185	Locker Set
AA-0895	1Ltr Jug only

Colours may vary

JUGS

BEST SELLER



1	AA-0850	750ml Plastic jug with lid	1Ltr
2	CB-8092	Acrylic jug with ice lip	1.8Ltr
3	CB-8091	Polycarbonate jug with lid	1.5Ltr

HARFIELD LOCKER SET

- Set contains:
- 12oz American style tumbler
 - 750ml clear graduated jug with coloured lid
 - Coloured tray
 - 6 colours available: Emerald Green, Red, Blue, Yellow, Purple and White
- Please state colour when placing your order

Available Colours



CB-2190

BEDSIDE JUG, TUMBLER & TRAY

BEST SELLER



CB-8065	Jug & Lid	1.1Ltr
CB-8059	Stackable Tumbler	250ml
AC-0940	Birch Tray	26 x 20cm

TUMBLERS



Available in Red, Lemon, Blue, Green and Clear



Available in Red, Blue, Green and Clear

CB-2181 200ml / 7oz Fluted Tumbler

CB-8060 280ml / 10oz Tall Tumbler

CUP HOLDER

- 2 Large handles
- Better control
- Reduces chance of spilling
- Tumbler not included

CD-3030

For use with CB-8060 Tumbler



TRANSLUCENT TUMBLERS

BEST SELLER

- Virtually Unbreakable
- 100% BPA Free
- Stackable American Style Tumbler



CB-8003 250ml / 9oz



CB-8004 340ml / 12oz

POLYCARB CLEAR DISHES



CB-8055 350ml Dessert Dish
12 x 5cm

CB-8050 2.5L Serving Bowl
24 x 9cm

HARFIELD GRADUATED TUMBLER

340ml



CB-8130

POLYCARBONATE DISHES

5.5cm Deep



CB-8095 Dessert 14cm dia

CB-8094 Sundae 9.5cm dia

CLEAR POLYCARBONATE STEMMED TUMBLER

- Made by Roltex
- Polycarbonate
- Easily stackable stemmed tumbler
- 220ml



CB-4111

WHY CHOOSE POLYCARBONATE FOR YOUR TABLEWARE?

IT HAS **HIGH STRENGTH, TOUGHNESS, HEAT RESISTANCE,** AND HAS EXCELLENT DIMENSIONAL AND COLOUR STABILITY. MICROWAVE USE IS LIMITED TO HEATING RATHER THAN COOKING.

- Virtually Unbreakable ✓
- Stain Resistant ✓
- Lightweight and Durable ✓
- Non-porous. Food Bacteria cannot soak into the tableware ✓
- Will Not Chip ✓
- Dishwasher Safe ✓
- Safe for use by Children ✓
- Will Not Shatter ✓
- Self Extinguishing ✓

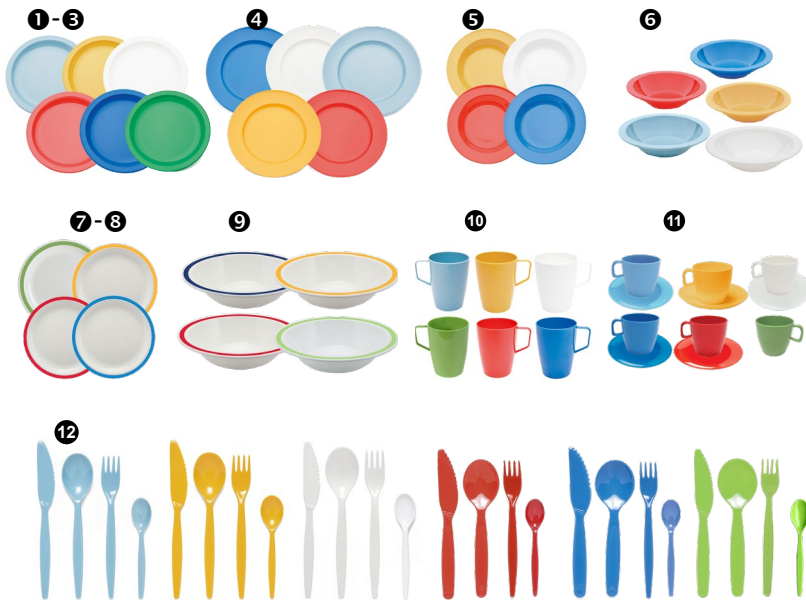
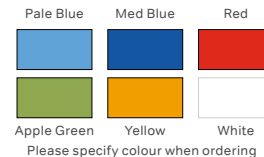

Item 1 only available in White & Med Blue Item 2 & 3 also available in Emerald Green
 Item 11 Apple Green Tea cup only

1	CB-8014	Dinner plate	25.5cm
2	CB-8078	Dinner plate	23cm
3	CB-8080	Teaplate	17cm
4	CB-8001	Dinner plate	24cm
5	CB-8082	Soup/pasta plate	21.5cm
6	CB-8077	Bowl	17cm
7	CB-8011	Dinner Plate - Colour Rim	23cm
8	CB-8012	Teaplate - Colour Rim	17cm
9	CB-8013	Bowl - Colour Rim	17cm
10	CB-8079	Beaker with handle	280ml
11	CB-8076	Tea Cup	220ml
	CB-8075	Tea Saucer	To match CB-8076
12	CB-8087	Teaspoon	14.5cm
	CB-8086	Dessert Spoon	20cm
	CB-8085	Fork	20cm
	CB-8084	Knife	22cm



IDEAL FOR DEMENTIA CARE
 THE COLOUR RANGE AND EASE OF USE OF THIS TABLEWARE
ENCOURAGES EATING AND DRINKING
 AND SO HELPS WITH NUTRITION AND HYDRATION.

- Individuals are helped to maintain their independence for longer by being able to feed themselves
- Made from vitrified Earthenware (ceramic) with added alumina for extra strength
- Can be used in dishwashers, microwaves and freezers



Colour Options

1	CB-1763	Saucer	-	Green	Yellow	White
2	CB-1781	One mug handle	250ml	Green	Yellow	White
3	CB-1772	Shape two mug handle	250ml	Green	Yellow	-
4	CB-1762	Two handle mug	250ml	Green	Yellow	White
5	CB-1760	Feeder cup two handle mug	250ml	Green	Yellow	White
6	CB-1782	Feeder cup two handle mug	250ml	Green	Yellow	White
7	CB-1770	Cereal Bowl	-	Green	Yellow	-
8	CB-1765	Soup / Cereal bowl	-	Green	Yellow	White
9	CB-1775	Side plate	-	Green	Yellow	-
10	CB-1766	Plate	-	Green	Yellow	White

ORNAMIN FAMILY TABLEWARE

Ornamin specialises in developing and producing universally designed tableware. The helpful tricks of our functional tableware compensate different types of disabilities and facilitate independent eating and drinking. The best trick yet - the unique characteristic is concealed within the design so they are hardly noticeable at first glance.

- Eating and drinking aids with helpful features hidden in the colourful design
- The features facilitate independent eating and drinking
- Universal design, the family tableware can be used by everyone equally, without adaptations or specialised addition

BEST SELLER

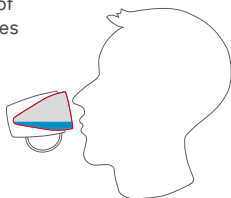

Mugs are available in Red and Blue



1	CB-9090	One Handled Mug
2	CB-9091	Break Resistant Mug
	CB-9092	Discreet Lid (for CB-9090)
	CB-9093	Discreet Spout Lid (for CB-9090)
	CB-9094-WH	26cm Melamime Plate with sloped base & non-slip base

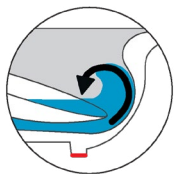

MENU BOARD

Many providers believe the use of pictures is a more effective way to communicate meal options. They often take photographs of their own dishes to create a library of pictures to put in the holders on the menu board each day and show clients what choices are available. 870 x 720mm

The menu board includes:

- 7 holders to display pictures size 150 x 100mm
- Set of header cards: Breakfast, Lunch, Dinner, Tea and Snacks

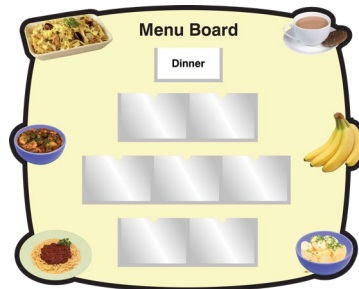

UC-0504

MENU CARDS

A fantastic range of menu cards specially made to fit in the menu board. 240 individual cards to choose from encompassing a variety of meal times: Breakfast, lunch, dinner, tea, snacks.

- Laminate
- 140 x 95mm
- Waterproof
- Wipe clean

240
PACK



UC-0520

MELAMINE DINNERWARE

Eating a healthy, balanced diet is important, especially for people with dementia. It can help maintain physical and mental wellbeing, helping people to live a longer happier life. As dementia progresses, colour definition decreases. If the crockery is a similar colour to the food, the person with dementia may not be able to see the food. For example, if a white plate is used for potatoes, rice, pasta, white fish or cauliflower, it can be difficult for some people to see this food on a white plate. Some white foods such as carbohydrates can be the most calorific part of a main meal and are vitally important.

- **Virtually unbreakable** and chip resistant
- **Bright coloured** to stimulate appetite and aid nutrition
- **Commercial dishwasher safe**
- **Steep inner sides** help to guide food on to a spoon or fork
- **Large rim** makes the plates easy to hold and lift
- **Broad base** improves stability
- **Good insulation** keeps food hot and hands cool

Studies have shown growing evidence that blue, yellow & red are the most effective colours for Dementia care. This heavy duty melamine dinnerware is lightweight, with the look and feel of ceramic.

Plates & Bowls available in blue, red, yellow or white. Mugs are available in blue, red, yellow or ivory.

Please state colour when placing your order

CB-8026	Dinner Plate	25cm
CB-4109	Dinner Plate with Steep Inner Sides	25cm
CB-8027	Side Plate	16.5cm
CB-8028	Bowl	18.5cm
CB-8025	Single Handle Mug	296ml
CB-8020	Two Handle Mug	296ml

1	CB-8022	Single Hole Lid
2	CB-8023	Perforated Lid
3	CB-8036	Slow Pour Lid
4	CB-8037	Quick Pour Lid



IDEAL FOR DEMENTIA CARE

Brightly coloured dinnerware can significantly improve food intake, plates stand out from the table, and the food stands out from the plate, which stimulates the person to see the food & eat more.



Dinner Plate with Steep Inner Sides



TOUGHENED GLASS
TUMBLERS

BEST SELLER



1	CB-0921	Hi ball stacking	320ml
2	CB-0920	Plain conical	280ml
3	CB-3081	Tumbler stacking	200ml
4	CB-0925	Fruit juice	170ml

GLASSES



5	CB-0927	Sherry Glass	60ml
6	CB-0926	Wine Glass	190ml
7	CB-0929	Wine Glass	255ml

GLASS FRUIT DISH



CB-0919 Fruit Dish 12.5cm

BEAD CUTLERY

18/0 mirror polished
stainless steel

CB-1926	Teaspoon
CB-1927	Serving spoon
CB-1924	Dessert spoon
CB-1925	Soup spoon
CB-1921	Table fork
CB-1923	Dessert fork
CB-1920	Table knife
CB-1922	Dessert knife

GLASS JUGS



AA-0894	Plain Lip 1Ltr
AA-0899	Pitcher 500ml

ECONOMY CUTLERY

BEST SELLER



CA-0902	Teaspoon
CA-0901	Dessert spoon
CA-0903	Soup spoon
CA-0905	Table fork
CA-0912	Dessert fork
CA-0900	Table knife
CA-0913	Dessert knife

RATTAIL CUTLERY - PACK OF 12

CB-1963	Pack of 12	Teaspoon
CB-1967	Pack of 12	Serving spoon
CB-1962	Pack of 12	Dessert spoon
CB-1966	Pack of 12	Soup spoon
CB-1961	Pack of 12	Table fork
CB-1965	Pack of 12	Dessert fork
CB-1960	Pack of 12	Table knife
CB-1964	Pack of 12	Dessert knife

DUBARRY CUTLERY

18/0 mirror polished
stainless steel
Sold Separately



CB-1944	Teaspoon
CB-1943	Dessert spoon
CB-1942	Soup spoon
CB-1938	Table fork
CB-1939	Dessert fork
CB-1940	Table knife
CB-1941	Dessert knife

KINGS CUTLERY

18/0 mirror polished
stainless steel
Sold Separately

BEST SELLER

CB-1936	Teaspoon
CB-1929	Serving spoon
CB-1934	Dessert spoon
CB-1935	Soup spoon
CB-1931	Table fork
CB-1933	Dessert fork
CB-1930	Table knife
CB-1932	Dessert knife

NOVA

A blank canvas lets your food stand out.

Nova is a range of plates and bowls in key sizes combining contemporary understated design with functionality and durability.

BEST SELLER**EARTHENWARE
CLASSIC MUG**

White mug 284mm

**CB-0960**

1	CB-2041	Side plate	15.2cm
	CB-3771	Dinner plate	20.3cm
	CB-2040	Dinner plate	23cm
	CB-3042	Dinner plate	25.5cm
	CB-2043	Soup plate	-
2	CB-2048	Soup bowl	-
	CB-2042	Soup bowl with handles	-
3	CB-3146	Oatmeal bowl	15.2cm
4	CB-2051	Pepper pot	-
	CB-2050	Salt pot	-
5	CB-2054	Egg cup	-
6	CB-2046	Tea/Coffee pot	420ml
7	CB-2047	Tea/Coffee pot	850ml
	CB-2049	Milk/Cream jug	140ml
8	CB-2061	Milk/Cream jug	285ml
	CB-3398	Sugar bowl	150ml
9	CB-2044	Teacup (stacking)	213ml
10	CB-2045	Tea saucer	-

SIMPLY TABLEWARE

Simply is a cost effective, fully vitrified tableware range that fully conforms to the British Standard 4034 for Hotelware.

The range offers an outstanding combination of quality and value.

Simply
VITRIFIED HOTELWARE BS4034



1	CB-7102	Wide rim plate	26cm
	CB-7103	Wide rim plate	21cm
	CB-7104	Wide rim plate	16cm
2	CB-7106	Soup/Pasta plate	23cm
3	CB-7107	Oatmeal bowl	16cm
4	CB-7108	Lugged soup bowl	285ml
5	CB-7109	Stacking teacup	200ml
6	CB-7110	Latte mug	285ml
7	CB-7117	Bowl shaped cup	227ml
6	CB-7118	Saucer for all cups	16cm
8	CB-7111	2 cup teapot	400ml
	CB-7112	4 cup teapot	710ml
9	CB-7114	Sugar bowl	200ml
10	CB-7113	Cream jug	140ml
11	CB-7115	Salt pot	7.5cm
	CB-7116	Pepper pot	7.5cm

ALCHEMY WHITE

A contemporary twist on a classic look, Alchemy White has been designed with both innovation and functionality in mind.

- This pure white fine china has a neat rolled edge which gives excellent chip-resistance
- A unique glazed foot helps protect surfaces against scratching and metal marking
- The high percentage of alumina content gives Alchemy White maximum strength



1	CB-3602	Dinner plate	26.8cm
	CB-9021	Dinner plate	20.3cm
	CB-3603	Side plate	16.5cm
2	CB-3601	Rimmed soup bowl	24cm
3	CB-3600	Bowl	16.5cm
4	CB-3607	Lugged soup bowl	284ml
5	CB-3604	Stacking tea cup	213ml
6	CB-9016	Mug	284ml
7	CB-3605	Tea saucer	15.3cm
8	CB-9017	Tea/coffee pot	426ml
	CB-3606	Tea/coffee pot	710ml
9	CB-3608	Open sugar bowl	227ml
10	CB-9015	Milk/cream jug	142ml
11	CB-3609	Salt pot	6cm
	CB-3610	Pepper pot	6cm

STAINLESS STEEL TABLEWARE

TEA/COFFEE
POT

1340ml



AA-3208

MILK/CREAM
JUG

300ml



AA-3203

GRAVY/SAUCE
BOAT

AA-6599

NAPKIN RING



AB-2085

SUNDAE DISH

BEST SELLER



AA-3534

SUGAR BOWL

340ml



AA-3207

BUTTER DISH



AA-3545

EGG CUP



AA-3497

SALT & PEPPER POTS

BEST SELLER

AA-3579	11cm Salt
AA-3580	11cm Pepper

SALT & PEPPER POTS



AA-3581	Salt
AA-3582	Pepper

SALT & PEPPER POT SET

6cm Set

AA-3575

VINEGAR & OIL BOTTLES



CB-0520	Vinegar
CB-0909	Oil

BIRCH BEDSIDE TRAY

- Scratch and stain resistant
- Temperature resistant from -10°C to +100°C
- Laminated melamine
- Dishwasher safe
- 26 x 20cm

AC-0940

POLYPROPYLENE SERVING TRAY

BEST SELLER

- Available in Red and Royal Blue
- Light and durable
- 41 x 30cm
- Not for use in a Dishwasher



CB-8099-R	CB-8099-B
-----------	-----------

AIRPOT DISPENSER

- Safety lock on lid
- Removable spout for cleaning
- Stainless Steel
- One hand operation
- 1.9Ltr

AA-2078

BEVERAGE JUGS

- A porcelain look alike insulated jug with a tough unbreakable liner
- Available in White and Black



AA-2075	560ml
AA-2076	1120ml
AA-2077	1810ml

Please state colour when ordering

6 SLICE TOAST RACK

AA-6595

SERVING TRAY

- Laminated veneer
- Stain resistant
- 46 x 34cm
- Not for use in a Dishwasher



AC-0934-MAHOGANY
AC-0934-BIRCH

WALNUT ANTI-SLIP SERVING TRAY

- 46 x 36cm

AC-0932

POLYCARBONATE TABLEWARE SUPERIOR QUALITY PLASTIC

- Dishwasher safe
- Microwave safe for reheating food

Available in Black, Green, Blue, Red, and Yellow

POLYCARBONATE SNACK DISH

- 19.3 w x 4.4cm h
- 450ml



CB-8072



POLYCARBONATE SQUARE SNACK DISH

- Also available in white
- 10 w x 3.5cm h
- 175ml



CB-8070



FLAT EDGE POLYCARBONATE SPOON

BEST SELLER

- The flat edge spoon is an ideal feeding aid
- Safe to use, lightweight & very durable
 - Choice of either narrow or wide
 - Will not shatter or splinter
 - Heat resistance and colour stability



Available in Black,
Pale Blue and White

CB-8074 Narrow 25mm

CB-8073 Wide 35mm

POLYCARBONATE SNACK DISH

- Also available in white
- 9.5 w x 5cm h
- 200ml



CB-8071



POLYCARBONATE SERVING PLATTER

- Perfect for sandwiches or soup and a roll. Also ideal for bedside cabinets to stand jug & tumbler on
- Also available in white
- 26.7 L x 13.4cm W



CB-8101



TABLE MATS & COASTERS

- Melamine
- Scratch proof
- Heat resistant up to 150°C
- Cork backed

Available in Red, Green, Blue and Cream.
State colour when ordering.

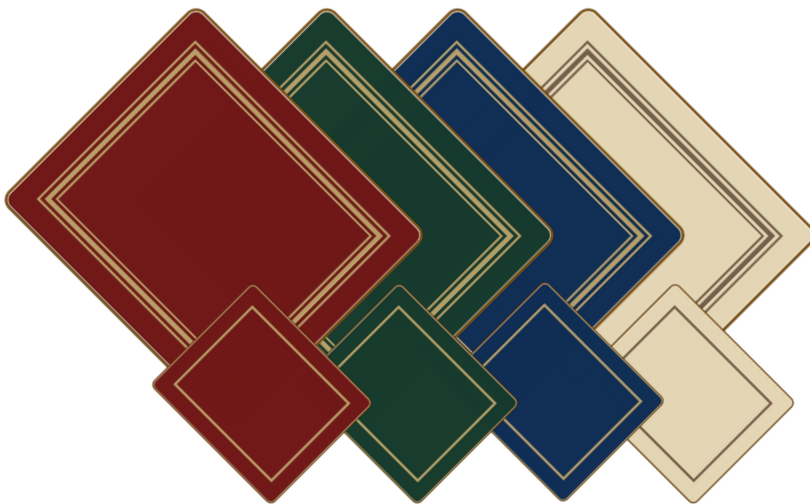

CD-3314	TABLE MATS	23 x 19cm
CD-3311	COASTERS	11 x 9cm

BEST SELLER**MENU HOLDER**

- Perspex
 - A4 size
 - 30 x 21cm
- (Contents not included)

**AB-2113****POLYCARBONATE BUD VASE**

- Lightweight
- Dishwasher safe
- White or clear



EC-6253-C	CLEAR
EC-6253-WH	WHITE



ROSE DESIGN TABLECLOTHS & NAPKINS

- Easy care and stain release
- Strong, durable and robust
- 100% polyester
- Colourfast

JB-2019	Napkin	40 x 40cm
JB-2015	Napkin	55 x 55cm
JB-2061	Tablecloth	114 x 114cm
JB-2020	Tablecloth	137 x 137cm
JB-2050	Tablecloth	Round 137cm dia
JB-2052	Tablecloth	Round 178cm dia

AVAILABLE COLOURS

Please state colour when ordering



BEST SELLER

STAINLESS STEEL PANS

- 18/10 Stainless steel high quality cookware •
- Heat resistant, stainless steel tubular handles
- Suitable for all conventional heating methods including induction cooking • Dishwasher safe

FRYING PANS

Lid sold separately



AA-1039 32cm

AA-1040 36cm

LONG HANDLE SAUCEPANS

Lid sold separately



AA-1048 2.5Ltr 18cm

AA-1050 5Ltr 24cm

AA-1049 3Ltr 20cm

AA-1086 8Ltr 28cm

PAN LIDS

AA-1074 18cm

AA-1075 20cm

AA-1076 24cm

AA-1077 28cm

SIDE HANDLE STEWPANS WITH LID ALUMINIUM

Not Dishwasher Safe



AA-1056 8Ltr 24cm

AA-1057 11.5Ltr 28cm

AA-1058 14Ltr 30cm

AA-1059 24.5Ltr 36cm

AA-1060 30Ltr

OMELETTE / FRYING PANS HEAVY DUTY ALUMINIUM BODY**BEST SELLER**

- Non stick
- 2 sizes available

AA-1087 20cm

AA-1092 24cm

STAINLESS STEEL COLANDERS

AA-3636 34cm

AA-5833 40cm

POACHER ALUMINIUM

AA-3790

TEAPOT ALUMINIUM

- Plastic handles
- Front lifting handle
- 4.5Ltr capacity



AA-0932

BAKEWELL PANS ALUMINIUM



AA-3295	31 x 21 x 4cm
AA-3299	37 x 26 x 4cm
AA-3294	42 x 30 x 4cm
AA-3300	47 x 35 x 4cm

SWISS ROLL TRAY

- Non-Stick
- 37 x 26 x 1cm



AB-2089

LOAF TINS



AA-3266	454g
AA-3267	908g Non-Stick

BUN TIN

- 12 Cup Yorkshire Pudding Tray
- Non-Stick



AA-3297

PLATE RINGS & COVERS

BEST SELLER

Plastic ring and cover suitable for use in a microwave



AD-3566	20cm Plastic Ring
AB-2075	21cm Plastic Cover
AD-3565	20cm Aluminium Ring
AB-2074	20cm Aluminium Cover

DEEP ROASTING DISHES



AA-3307	42 x 30 x 7cm
AA-3308	47 x 35 x 7cm

CAKE TIN



AA-3259 Fixed Base 22.8 x 8.9cm

FOOD DISPLAY TRAY

- Material ABS Plastic
- Weight 380g
- Colour White
- Gloss finish
- Raised edge to prevent spill
- Food-safe material
- Hand-wash only
- Exceptionally durable, high-impact ABS construction



ALT-AB-2092

COOLING TRAY

- 56 x 38cm

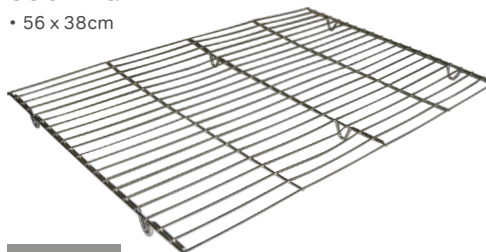

AA-3023

KITCHEN SCALES

- Stainless steel
- Pan Included
- 10Kg capacity
- 50g graduation



AA-3298

LADLE

Stainless Steel



AB-2057	89ml 7cm
AB-2048	118ml 8cm
AB-2058	180ml 9.5cm

MASHER 23CM

Stainless Steel



AB-5887

**TONGS
21.5CM**

Stainless Steel

BEST SELLER

AB-2070

**HEAVY DUTY
MASHER**

Stainless Steel



AB-2060

STRAINER BOWLTinned
20cm

AA-7000

**PLAIN SERVING
SPOON - 30CM**

Stainless Steel



AB-2071

EGG/FISH/SLICE

Stainless Steel



AB-2073

SERVING TONGSDishwasher safe, virtually
unbreakable
22.5cm

AB-2077-BLK

WHISKStainless Steel
30cm

AB-2059

SKIMMER SPIDERStainless Steel
Handle

AA-3051

**30CM PERFORATED
SERVING SPOON**

Stainless Steel

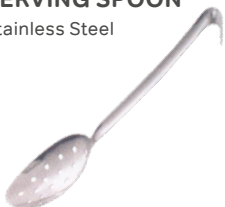

AB-2072

6CM SCOOP

Stainless Steel



AB-3022

PEA LADLEStainless Steel
6cm Dia

AB-2044

GRATER

Tinned



AB-2064

40CM ROLLING PIN

Polypropylene

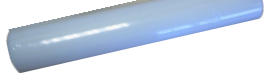

AB-3579

20CM SEMI-FLEXIBLE SPATULA

Ideal for non stick surfaces



AA-6155

CAKE SERVER WITH SOFT GRIP

26.5 x 6 x 3cm



AB-2099

PLAIN 35CM SPATULAFor Non-Stick Pans
Withstands up to 200°C

AA-6159

PIPPING BAGS **BEST SELLER**

AA-3627

Nylon set of 2

DA-0801

Disposable
Pack of 100**ICING TUBES - SET OF 6**Plain Tip - Stainless Steel
2.4 - 14cm

AA-3628

PLAIN PASTRY CUTTERTinplate
2 - 10cm

AA-7006

SET OF
11**PEELER**

Stainless Steel Blade



AB-2065

STAR TIP - PLASTICSet of 6
3 - 13cm

AA-3629

13CM FUNNEL

Polythene



AA-7005

PASTRY BRUSHPlastic
2.5cm

AB-3578

9CM SHAKER

Aluminium



AA-7002

EGG SLICER

Stainless Steel



AA-6468

CAN OPENERS

Mild steel with stainless steel stem. Can be either clamped or screwed to work surface.



Bench style

AA-6045



Wheel style

AB-2063



Non-slip

AB-2062

POLYPROPYLENE PUDDING BASIN WITH LID



1.7Ltr
110cm(h)x178cm(dia)

AA-7015

DUAL CALIBRATION MEASURING JUGS

Stainless Steel

1 Litre

AA-6430



POLYPROPYLENE

*May differ slightly from image shown



AA-0896 0.5 Litre

AA-3219 1 Litre

AA-3220 2 Litre

BEST SELLER

POLYPROPYLENE BOWL



AA-3263 2Ltr 22.5cm

AA-3262 4Ltr 28cm

AA-3269 7Ltr 33cm

ROLLED EDGE STAINLESS STEEL BOWL



AA-7008 1.4Ltr 20cm

AA-7009 2Ltr 24cm

AA-7010 4Ltr 30cm

SCISSORS



AA-3265

CHOPPING BOARDS & KNIVES

- To prevent cross contamination use correct colour coded chopping boards & knives
- Chopping board: 46 x 30 x 12cm

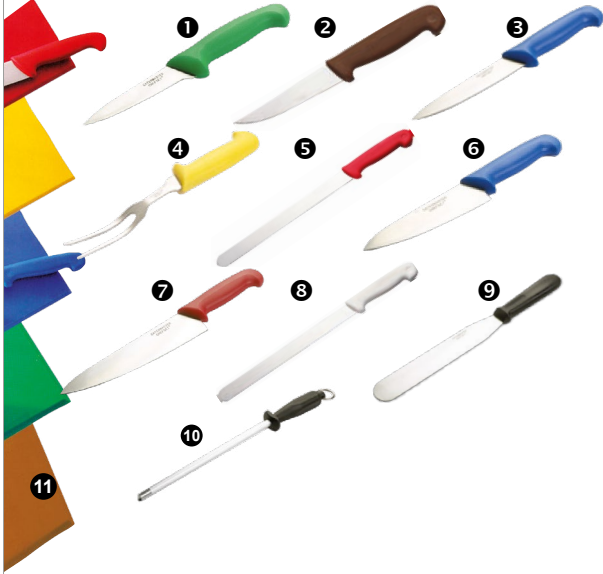

CATERING COLOUR GUIDE

Red - Raw Meat	Green - Salad & Fruit
Yellow - Cooked Meat	Brown - Vegetables
Blue - Raw Fish	White - Bakery & Dairy

Please state colour when ordering

1	AB-3577	Paring Knife	9cm	Red			Green	Brown		
2	AB-2068	Vegetable Knife	10cm		Yellow		Green	Brown		
3	AB-3163	Filleting Knife	15cm			Blue				
4	AB-6410	Carving Fork	15cm	Red	Yellow					
5	AB-2083	Carving Knife	25cm	Red						
6	AB-2067	Carving Knife	30cm		Yellow					
7	AB-2066	Cooks Knife	16cm	Red	Yellow		Green	Brown		
7	AB-3130	Cooks Knife	21cm	Red	Yellow	Blue	Green	Brown	Purple	
8	AB-2069	Bread Knife	20cm							
9	AB-3576	Palette Knife	20cm							Black
10	AB-5832	Sharpening Steel	30cm							Black
11	AB-3025	Chopping Board		Red	Yellow	Blue	Green	Brown		
	AB-3031	Chopping Board	45x30cm						Purple	
	AB-3021	High Density Poly Chopping Board		Red	Yellow	Blue	Green	Brown		

KNIFE HOLDER

- Magnetic
- 55cm



AB-3546

RACKS FOR BOARDS



AB-3027

FRIDGE/FREEZER THERMOMETER

Range -30C to +40C



AC-0893

WALL THERMOMETER

- Plastic
- Range -10°C to +50°C
- Equivalent °F scale

BEST SELLER

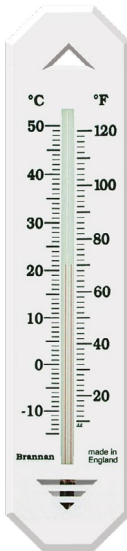

EB-2124

COOKING/FRYING THERMOMETER

- Stainless steel with 50mm dial
- Range 0C to 120C
- With 1°C divisions



AA-6463

DIGITAL THERMOMETER

- 120mm stainless steel probe
- Hold display facility
- Range -50°C to +150°C
- Complete with probe cover
- Equivalent °F scale



AC-3238

FOOD CHECK THERMOMETER WITH TIMER

- For liquids and semi solids
- Range: -50°C to +300°C
- Complete with fixed food penetration probe



AB-6510

FRIDGE / FREEZER DIGITAL THERMOMETER

Digital Thermometer to show room temperature and the temperature of fridge or freezer. Alarm sounds when appliance fails.

- Temperature range: -50° to +70°C



EC-1219

PHARMACY DIGITAL THERMOMETER

- Sensing probe for fridge temperature measurement
- Range: -50°C to +70°C&F

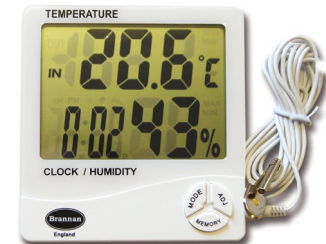

EC-1218

PLASTIC FOOD CONTAINERS

Food storage made easy with this range of easy clean, robust containers and food preparation products. Conveniently freezer, dishwasher and microwave safe, as well as BPA free.



1.2 Litre
6.5 x 30 x 10 cm
AA-3886



BEST SELLER
2 Litre
9.5 x 15.5 x 22.5 cm
AA-3885



2.4 Litre
16.5 x 19 x 14 cm
AA-3884



3.9 Litre
16.5 x 20 x 20 cm
AA-3883



5 Litre
30.5 x 28 x 12.5 cm
AA-3388



6 Litre
14 x 32 x 22.5 cm
AA-3882



10 Litre
13 x 32.5 x 32.5 cm
AA-3880



15 Litre
18.5 x 32.5 x 32.5 cm
AA-3881

SQUARE SPACE SAVING CONTAINERS

Square containers store up to 33% more than round containers

- Break resistant clear polycarbonate for visibility and long life
- Dishwasher safe
- Measurement graduations
- Nest for compact storage
- Durable Polythene Lids - Dishwasher Safe
- Colour of graduation & lid matches for easy identification of correct cover size
- Snap-tight fit reduces leakage, helps prevent spillage
- Pull tab with grips



Green	
AA-6302	1.5Ltr
AA-6304	3.5Ltr
AA-6250	Green Lid

Red	
AA-6305	5.5Ltr
AA-6308	7Ltr
AA-6523	Red Lid

Blue	
AA-6312	10Ltr
AA-6322	20Ltr
AA-6509	Blue Lid



VINYL NON-STERILE GLOVES POWDER FREE

- Blue
- EN455 & AQL 1.5



100
PACK

TK-0678	Small
TK-0677	Medium
TK-0679	Large
TK-0680	X Large

BLUE HAIRNETS

Elasticated twin banded hair nets. Widely used in the food industry.

- One size fits all
- Spool of 48 nets

48
PACK

DB-0858



DISPOSABLE APRONS



BEST SELLER

Quality products at unbeatable prices! Our disposable aprons are made from high quality polythene, available in a choice of five colours on a roll or flat packed.

For Apron Dispensers see page 15

FLAT PACK

Code	Colour	Multibuy
QA-0195	White	Contact our sales team for latest prices.
QA-0196	Blue	
QA-0197	Red	
QA-2001	Green	
QA-2002	Yellow	

100
PACK

STANDARD APRONS ON A ROLL

Code	Colour	Multibuy
QA-0198	White	Contact our sales team for latest prices.
QA-0199	Blue	
QA-0194	Red	
QA-0193	Green	
QA-0192	Yellow	

200
PACK

PREMIUM APRONS FLAT PACK

Code	Colour
QA-0179	White
QA-0178	Blue

100
PACK

PREMIUM APRONS ON A ROLL

Code	Colour	Multibuy
QA-0189	White	Contact our sales team.
QA-0188	Blue	

200
PACK

SPEEDWRAP CLING FILM, FOIL, PARCHMENT & DISPENSERS



Speedwrap
30cm Dispenser

AD-0906

Speedwrap
45cm Dispenser

AD-0903

*If you already use the Wrapmaster dispenser then you can still purchase your refills which are highlighted in the table



AD-0909-CASE	Cling Film	30 x 300m	3 Pack
AD-0907-CASE	Cling Film	45 x 300m	3 Pack
AD-0911-CASE	Foil	30 x 90m	3 Pack
AD-0908-CASE	Foil	45 x 90m	3 Pack
AD-0910-CASE	Baking Parchment	45 x 50m	3 Pack

FOOD ROTATION LABELS & DISPENSER

No more worries about controlling stock with this easy to use food rotation labelling system. The colour coded 'day printed' labels have space to add a date below, simplifying rotation and reducing food wastage.

- Labels supplied on a roll of 500
- Please specify day required when ordering



500
A ROLL

CB-1821 Label dispenser

CB-1820 500 labels (individual day - specify)



BOXED CLING FILM, FOIL BAKING PARCHMENT BEST SELLER



AD-0940	Cling Film	30cm x 300m
AD-0939	Cling Film	45cm x 300m
AD-0942	Foil	30cm x 75m
AD-0943	Foil	45cm x 75m
AA-9939	Baking Parchment	45cm x 50m
AA-9930	Baking Parchment	30cm x 50m (Disposable Cutter Box)

SHELF LIFE LABELS, ROLL OF 500

2 x 3" Labels

500
A ROLL

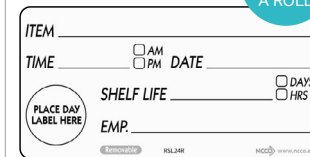

AE-1101

*Please note labels are not freezer-proof

7OZ FOAM CUPS & LIDS
198ml Foam Cup

AE-1173

1000
PACK



9OZ HOT CUPS & LIDS

Lids sold separately

250ml Cup

AE-1180

Domed Lid

AE-1192

1000
PACK



SANDWICH WEDGES



500
PACK

AE-1199 Plastic Wedge

AE-1316 Card Triple Wedge

WOODEN DRINK STIRRERS

12.7cm



10,000
PACK

AE-1204

PLASTIC CUTLERY



DB-0853	Teaspoons	1000 PACK
AE-1600	Dessert Spoons	2000 PACK
DB-0852	Knives	1000 PACK
AE-1601	Forks	2000 PACK

7OZ PLASTIC CUPS

198ml

2000
PACK



CC-0954



BAGASSE CLAMSHELL FOOD BOX

NEW

- 180 x 125 x 65mm
- Suitable for hot, wet and oily foods. Disposable, Compostable & Biodegradable.

600
PACK

ED-1570

BAGASSE FOOD BOX

NEW

- 160 x 230 x 75mm
- Suitable for hot, wet and oily foods. Disposable, Compostable & Biodegradable

250
PACK

ED-1571

MEDIUM 26OZ TAKEAWAY FOOD BOX

NEW

- No Window
- Brown Kraft food cartons are leak and grease resistant, microwaveable, stackable

450
PACK

AE-1454

LARGE 51OZ TAKEAWAY FOOD BOX

NEW

- No Window
- Brown Kraft food cartons are leak and grease resistant, microwaveable, stackable

200
PACK

AE-1456

FOIL CONTAINERS & LIDS

Lids sold separately



AE-1196 Small Container

1000
PACK

AE-1193 Small Lid

AE-1197 Large Container

500
PACK

AE-1194 Large Lid

DELI POT WITH HINGE LID

375ml

500
PACK

AE-1190

PORTION POT & LID

113ml

1000
PACK

AE-1175

COMPOSTABLE PLATE

NEW

These plates are sturdy and less likely to bend with heavy foods like paper plates do.

- Sturdy
- Leakproof
- 22cm
- Rimmed edge
- Pack of 500

500
PACK

AE-1502

9" DISPOSABLE PAPER PLATE

- 22cm
- Packs of 10x 100

1000
PACK

AE-1179

FOOD PAPER CARRIER BAGS

- 18 x 25 x 23cm
- Pack of 250

250
PACK

AE-1188

COLOURED PAPER SERVIETTES

- Available in 5 colours
- 2 ply 33 x 33cm
- Available in packs of 100

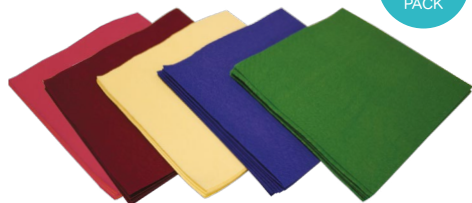

100
PACK

CC-0950-BU	Burgundy	100 pack
CC-0950-FG	Forest Green	100 pack
CC-0950-NA	Navy	100 pack
CC-0950-RE	Red	100 pack
CC-0950-CR	Cream	100 pack

WHITE PAPER SERVIETTES

CC-0947	1 Ply	30 x 30cm	Pack of 500
CC-0949	2 Ply	40 x 40cm	Pack of 125
CC-0952	2 Ply	33 x 33cm	Pack of 100

PAPER DOYLIES

26cm dia



250
PACK

CC-0955

FOIL PLATTER

Oval 43cm



10
PACK

AE-1169

PAPER TRAY COVERS

32 x 24cm



250
PACK

CC-0957



CENTRE FEED ROLLS

MAXI CENTRE FEED DISPENSER

DB-3124



MAXI CENTRE FEED TOWELS

* EMBOSSED

CASE OF
6
ROLLS

Code	Colour	Ply	Metres per Roll
DB-1111	Blue	1	300
DB-1110	Blue	2	150
DB-1112	White	2	150
DB-9017	Blue *	2	120
DB-9018	White *	2	120



MINI CENTRE FEED DISPENSER

DB-3166

MINI CENTRE FEED TOWELS

Also compatible with DB-3124

Code	Colour	Ply	Metres per Roll
DB-9019	White	2	60
DB-8182	Blue	2	80

CASE OF
6
ROLLS



DOUBLE MITT OVEN GLOVES

- Mixed Fibre
- 90 x 16cm



JB-3021

OVEN CLOTH

- Herringbone Weave
- 48 x 76cm



JB-2004

KITCHEN ROLL

- 2 Ply



DB-1115

CASE OF
24
ROLLS

GLASS OVAL CASSEROLE DISH 3.5L

AA-3504

MICROWAVE OVEN 20LTR

- 700W cooking power
- Turntable diameter: 25.5cm
- 20.8h x 30.6w x 30.7d cm cavity
- 5 power levels & defrost function
- Power consumption 1100 - 1150W



EB-6691

Whilst every attempt is made to maintain availability of domestic equipment, please note that models and/or specifications may vary to those illustrated.

2 SLOT 4 SLICE TOASTER

- Variable browning control
- Reheat, defrost & cancel buttons
- Self centering deep slots
- Variable width
- Slide out fixed crumb tray
- Stainless steel insert
- Cool wall
- 1300W



EB-6735

12 DEEP CUP MUFFIN TIN

- 39.5 x 30 x 3cm



AA-2020

CORDLESS KETTLE 1.7LTR**BEST SELLER**

- 2.2kW
- Safety locking lid
- Boil dry protection
- Water level window
- Washable filter



AA-6449

NON-STICK COOKWARE

- Roasting Dish
- 35.5 x 28 x 6cm



AA-3511

HOUSEKEEPING CONSUMABLES

PAPER, CLEANING & TOILETRIES

All your housekeeping needs are covered with our extensive range of consumables, with both value and brand options to meet any budget.

- Paper Products
- Toiletries & Sanitisers
- Cleaning & Laundry
- Cloths & Mops
- Refuse Sacks



**MINI JUMBO
TOILET ROLL
DISPENSER**

SA-3126



**MINI JUMBO
TOILET ROLLS**

2 Ply *Embossed

Code	Core size	M per Roll
SA-0803	76mm*	150
SA-0807	62mm	150

CASE OF
12
ROLLS

**JUMBO TOILET
ROLL DISPENSER**

SA-3127



**JUMBO 2PLY
TOILET ROLLS**

Code	Core size	M per Roll
SA-6759 Embossed	76mm	250
SA-0813 Recycled	60mm	300

CASE OF
6
ROLLS

**CORELESS TOILET ROLL
TWO-ROLL DISPENSER**

SA-6765



CASE OF
36
ROLLS

CORELESS TOILET ROLL

Code	Ply	Metres per Roll	Width
SA-0815	2	100	90mm

ECONOMY 2PLY

NEW

- Conventional toilet roll
- Soft embossed tissue
- Quick breakdown in water to reduce blockages
- Made with recycled fibres
- Sealed in packs of 4



CASE OF
36
ROLLS

DB-8150

TOILET TISSUE BULK DISPENSER

SA-3125

**BULK PACK SOFT
TOILET TISSUE 2PLY**

• 250 metres per roll

SA-0808



CASE OF
36
ROLLS

EMBOSSED TOILET ROLLS



CASE OF
40
ROLLS

Code	Ply	Sheets p/ Roll
SA-6773	Soft	200
SA-6772	Silver	208
SA-6764	Gold	178

BEST SELLER

**CONVENTIONAL
SOFT TOILET ROLL**

CASE OF
36
ROLLS

Code	Ply	Metres per Roll
SA-0806	2	200
SA-0809	2	320

PREMIUM DISPENSERS

BRUSHED STAINLESS STEEL DISPENSERS

BULK PACK TOILET TISSUE DISPENSER

SA-3137



CASE OF
36
ROLLS



SOFT TOILET TISSUE

Code	Ply	Sheets per Sleeve
SA-0808	2	250

HAND TOWEL DISPENSER

SA-3129



CASE OF
15
ROLLS



Z FOLD PAPER TOWEL

Code	Colour	Sheets per Sleeve
DB-9006	Blue	200
DB-9005	White	200



400ML LIQUID SOAP DISPENSER

Bulk Fill

SA-3100



STAINLESS STEEL MINI JUMBO TOILET TISSUE DISPENSER

SA-3128

CASE OF
12
ROLLS



MINI JUMBO TOILET ROLL

Code	Ply	Metres per Sleeve
SA-0807	2	150



900ML LIQUID SOAP DISPENSER

Bulk Fill

SA-3101

LIQUID SOAPS

Cream Hand Soap & BodyWash

A creamy, perfumed hand, hair & bodywash. For use in washrooms, showers and bathrooms. 5 Litre

HC-0767



Bacterial Hand Soap

Ideal for cleaning and sanitising where infection control is required. 5 Litre

HD-1078



MAXI CENTRE FEED TOWELS

* EMBOSSED

Code	Colour	Ply	Metres per Roll
DB-1111	Blue	1	300
DB-1110	Blue	2	150
DB-1112	White	2	150
DB-9017	Blue *	2	120
DB-9018	White *	2	120

MINI CENTRE FEED DISPENSER

DB-3166



CASE OF
6
ROLLS

CENTRE FEED ROLLS

MAXI CENTRE FEED DISPENSER

DB-3124



CASE OF
6
ROLLS

MINI CENTRE FEED TOWELS

Also compatible with DB-3124

Code	Colour	Ply	Metres per Roll
DB-2178-WH	White	1	120
DB-9019	White	2	60
DB-8182	Blue	2	80

25CM TOWEL ROLL DISPENSER

DB-3613



CASE OF
24
ROLLS

25CM TOWEL ROLLS

Code	Colour	Ply	Metres per roll
DB-1106	Blue	2	40
DB-1108	White	2	40

50CM TOWEL ROLL DISPENSER

DB-3614



CASE OF
12
ROLLS

50CM TOWEL ROLLS

Code	Colour	Ply	Metres per roll
DB-1107	Blue	2	40
DB-1109	White	2	40

**PAPER TOWEL
DISPENSER**

DB-8120



Interfold/V fold

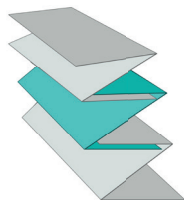
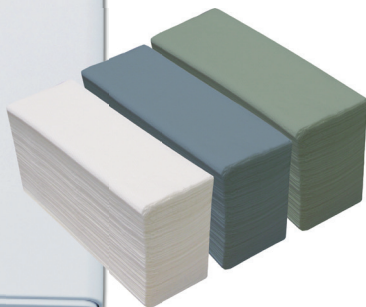

Z fold

Z FOLD PAPER TOWELS

3000 towels per case

BEST SELLER

Code	Colour	Ply
DB-8122	Blue	1
DB-8126	White	2

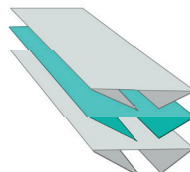
CASE OF
15
ROLLS

C fold

PAPER TOWELS**INTERFOLD (V FOLD) PAPER TOWELS**

3600 towels per case

Code	Colour	Ply
DB-8124	Blue	1

CASE OF
15
SLEEVES

3600 towels per case

Code	Colour	Ply
DB-8125	Green	1

CASE OF
15
SLEEVES

4000 towels per case

Code	Colour	Ply
DB-9010	White	2

CASE OF
15
SLEEVES

5000 Economy paper towel

Code	Colour	Ply
DB-8121	White	1

CASE OF
18
SLEEVES**C FOLD PAPER TOWELS**

2355 towels per case

Code	Colour	Ply
DB-8123	White	2

CASE OF
15
SLEEVES

2430 towels per case

Code	Colour	Ply
DB-8127	White	2

CASE OF
15
SLEEVES

*Biodegradable



TWO-ROLL SIDE BY SIDE TOILET TISSUE SYSTEM

North Shore's Side-by-Side toilet roll dispenser offers a choice of three premium colourways combined with a compact two roll holding dispenser, making it ideal to utilise where space is at a premium. The Side-by-Side's large window makes checking for replenishment quick and easy, helping for janitorial efficiency.



DISPENSER

Available in 3 colours

*please state colour when ordering



DB-9060-WH	White
DB-9060-BL	Blue
DB-9060-BLK	Black

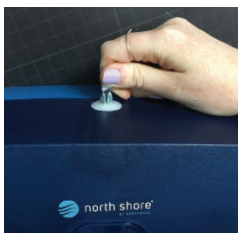

Supplied with a dispenser key

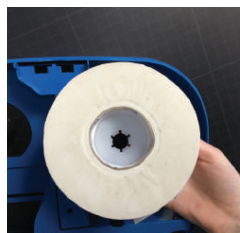

The roll will click on the spindle



Slide across bar to use next roll

FEATURES

- Dispenser holds 2 rolls
- Saves on refill time
- Easy to use
- Reduces waste
- h137mm w345mm d137mm

TOILET ROLLS

BEST SELLER

For use with the North Shore's Side-by-Side toilet roll dispenser.



Code	Ply	Sheets per Roll
SA-6715	2	525 Sheet Pure
SA-6716	2	625 Sheet Recycled
SA-6717	1	1250 Sheet Recycled



Z FOLD PAPER TOWEL DISPENSER SYSTEM

Designed to meet the most demanding of environments. North Shore's Folded Hand Towel Dispenser has been engineered to offer anti-blocking technology to deliver high efficiency through single sheet presentation. Easy to use with robust one sheet dispensing, the Folded Hand Towel Dispenser limits consumption and is ideal where space is at a premium.

- High capacity reduces the need for janitorial maintenance
- The most effective method of preventing washroom germ spread vs hand dryers
- Single sheet presentation means you only touch what you use, delivering excellent hygiene performance

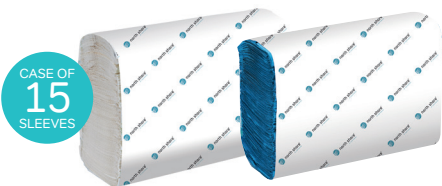

Z FOLD PAPER TOWELS

- 3000 towels per case
- 1 ply

Code	Colour	Sheets per Sleeve
DB-9006	Blue	200
DB-9005	White	200



Z fold

Paper Towel Dispenser

BEST SELLER



ROBUST ONE SHEET DISPENSING

REDUCING WASTE



Dispenses one flat sheet at a time

Can be topped up

MINIMISE MAINTENANCE



At a glance service visit

Can be installed in any location

IMPROVE HYGIENE



Towels kept locked, clean, protected

Touch free dispensing

Only touch paper that is used

EASY TO USE



Fast hand drying

Suitable for all ages and abilities

Constant availability

DISPENSER

DB-9000-WH	White
DB-9000-BL	Blue
DB-9000-BLK	Black



Available in 3 colours

*please state colour when ordering



**TORK MATIC®
HAND TOWEL
ROLL DISPENSER**

- Easy load
- Available in black or white

DB-0922



**TORK MATIC®
HAND TOWEL
ROLL DISPENSER**

- Automatically dispenses with hand activation
- Available in black or white

DB-0923



WITH
INTUITION™ SENSOR

**TORK MATIC® HAND
TOWEL ROLL**



Code	Colour	Ply	Metres per roll
DB-0934	White	2 (Soft)	150
DB-0935	Green	2	150

CASE OF
6
ROLLS

**WIPING PAPER
CENTREFEED ROLL**



Code	Colour	Ply	Metres per roll
DB-0940	White	1	165
DB-0941	Blue	1	165

**CENTREFEED
DISPENSER**

DB-0924



**COUCH
ROLL**

BEST SELLER



CASE OF
9
ROLLS

Code	Colour	Ply	M per roll
DB-0942	White	2	56
DB-0943	Blue	2	56

TORK FACIAL TISSUES

- Soft tissue that is gentle to the skin
- High brightness to give a hygienic impression
- Strong and absorbent for extra comfort



DB-2086	CLINICAL	2 Ply	100 PACK
DB-2082	PREMIUM	2 Ply	100 PACK

TORK XPRESS® MULTIFOLD HAND TOWEL DISPENSER

• Available in black or white

DB-0925



TORK XPRESS® MULTIFOLD HAND TOWELS

Code	Colour	Ply	Towels per Sleeve	Towels per Case
DB-0939	White	1	250	3000
DB-0938	Blue	1	250	3000

CASE OF
12
SLEEVES

Code	Colour	Ply	Towels per Sleeve	Towels per Case	CASE OF SLEEVES
DB-0949	White *	2	180	3780	21
DB-0937	White	2	237	4740	20

* Soft towel with attractive leaf pattern

SMARTONE TOILET ROLL & DISPENSER REDUCE CONSUMPTION BY 40%

Refill - Toilet Rolls
Case of 6 rolls

DB-0948

CASE OF
6
ROLLS

Dispenser

DB-0948-DISP



MINI JUMBO TOILET ROLL DISPENSER

• High capacity holds the equivalent of 8 conventional toilet rolls

DB-0920



MINI JUMBO TOILET ROLL

Code	Ply	Metres per Roll	CASE OF ROLLS
DB-0930	2	170	12

5.5cm core, soft attractive leaf pattern

CONVENTIONAL SOFT TOILET ROLL

BEST SELLER



CASE OF
36
ROLLS

Code	Ply	Sheets per Roll
DB-0932	2	200
DB-0933	2	320

FOLDED TOILET PAPER DISPENSER

DB-0921



CASE OF
36
SLEEVES



SOFT FOLDED TOILET PAPER

Code	Ply	Towels per Sleeve	Towels per Case
DB-0931	2	242	8712

FLUSHABLE HAND TOWEL

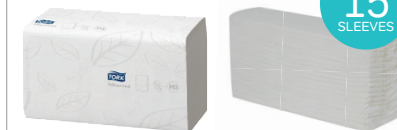

CASE OF
15
SLEEVES

Code	Towels per Sleeve	Towels per Case
DB-0929	250	3750
DB-9041	200	3000

TOOTHPASTE - 75ML

Aquafresh Triple Protection toothpaste provides 3-in-1 protection. Promotes strong healthy teeth and healthy gums.

- Clinically tested
- Triple protection
- 24-hour protection
- Triple action



SA-3143

Brand subject to change

TOOTHBRUSHES

- Multi action
- Medium size
- Pack of 3



SA-0810-PK

FLUORODINE MOUTHWASH

- Cool mint
- Alcohol free
- 500ml

Brand subject to change



SA-1208

DENTURE TABLETS - TUBE

- Effervescent cleaning tablets
- Tube of 30



SA-0785

DENTURE POTS RE-USABLE



KN-3465

ECONOMY DISPOSABLE RAZORS

For a close, smooth, clean shave.



SA-0792

BEST SELLER



Twin blade

SA-0793

5 PACK

SENSITIVE SHAVING FOAM

A rich creamy foam designed for an easier shave with a masculine fragrance.

- 200ml



SA-0782

MENS AEROSOL

150ml



SA-2097

DOVE ORIGINAL ROLL-ON ANTI-PERSPIRANT DEODORANT

- Alcohol Free
- Moisturising cream
- 50ml



SA-3337

LADIES AEROSOL

• 150ml



SA-2098

HAIR SPRAY

• 400ml



SA-3359

COMBS

• Pack of 12



12 PACK

SA-0784

HAIR BRUSH



SA-0783

TENA SHAMPOO & SHOWER

A mild shower gel with gentle conditioning shampoo for delicate skin and hair care.

Especially suitable for daily use, this fragrant gel cleanses the body and conditions the hair.

Just give the skin and hair a quick, gentle rub, and rinse off with water.

- 500ml

ND-0551

**SHOWER GEL *****BEST SELLER**

A luxurious everyday shower gel that will leave all skin types as soft as silk

- 500ml

Peach
Fragrance

SA-2168

**SHAMPOO & CONDITIONER**

A luxurious everyday shampoo and conditioner that will leave all hair types as soft as silk.

Shampoo 500ml

SA-0850

Conditioner 500ml

SA-0851

Green Apple
Fragrance

**FOAM BATH ***

A bath foam beautifully fragranced with the notes of sea minerals.

- The foam will cleanse and moisturise leaving skin feeling silky smooth
- 1 Litre

Sea
Minerals
Fragrance



SA-1205

**TENA SHAMPOO CAP**

NO RINSE CLEANSING

Pre-moistened non-rinse shampoo cap, comfortable alternative to washing hair with water.

- Ideal for bedridden, fragile and immobile users
- Warm in a microwave for added comfort



ND-0562

**BATH SPONGE**

SA-3148

NAIL BRUSH

SA-0790

TALCUM POWDER *

350g



SA-0805

TISSUES - 2 PLY WHITE CUBE

Box of 70



SA-0781

TISSUES 2 PLY WHITE

Box of 100



SA-0789

BEST SELLER

LAPÈ COLLECTION ORIENTAL LEMON TEA HAND WASH & LOTION

Luxury Hand Wash

- Specially formulated moisturising complex
- Skin neutral pH

Luxury Hand Lotion

- Contains skin reconditioning ingredients

REFILLABLE
& RECYCLABLE



* Products may vary slightly from images shown

HC-4208	Oriental Lemon Tea Hand Wash	300ml
HC-4210	Oriental Lemon Tea Hand Wash	5Ltr
HC-4209	Oriental Lemon Tea Hand Lotion	300ml
HC-4211	Oriental Lemon Tea Hand Lotion	5Ltr

SMALL INDIVIDUAL GUEST TOILETRIES

A scintillating bathtime experience awaits...

A creamy best-selling collection blends the goodness of real milk with a touch of french chic, to nourish and soften your skin.

SCOTTISH FINE SOAPS

Au Lait

WELCOME PACK

- 30ml Shampoo
- 30ml Body wash
- 30ml Moisturiser
- 25g Soap

Contents subject to change

SA-1115



GUEST * SIZE

SA-1112	Shampoo	38 ml
SA-1114	Bath & Shower Gel	38 ml
SA-1113	Body Milk Moisturiser	38 ml
SA-1111	Soap (*wrapped)	25g
SA-1117	Cream Handwash	300ml

SOAP BARS

SIMPLE SENSITIVE

2 Pack / 125g Bar

SA-0837



DOVE

100g Soap Bar

SA-3753



PALMOLIVE

3 Pack / 90g Bar

SA-0838



ANTI-BAC LIQUID HAND WASH

BEST SELLER

Dermatologically tested and kind to skin. Effectively kills 99.9% of bacteria.

Leave hands clean, soft and nourished.

Moisture Protect 600ml

HC-5010



Original 600ml

SA-5817



**Countrywide
Healthcare**
PrimaCare™ RAPID

**HAND SOAP
& BODY WASH**

**CREAM HAND SOAP
& BODY WASH**

A pleasant, creamy, perfumed hand, hair and bodywash. Formulated not to dry skin.

- 5 Litre

HC-0767



BEST SELLER

**BACTERICIDAL
HAND SOAP**

This luxury skin care product is ideal for cleaning and sanitising where infection control is required.

- 5 Litre

HD-1078



**PREVEN'S PARIS®
SHOWER DISPENSER**

SA-3810-SI	Dispenser (holds 300ml) Silver
SA-3810-WH	Dispenser (holds 300ml) White
SA-3813	PREVEN'S PARIS Luxurious 3-in-1 Shower Lotion 300ml
SA-3812	PREVEN'S PARIS Refresh 3-in-1 Wash 300ml



PUMP DISPENSER

- 1000 pumps
- 5 Litre Container



HC-1080

**WALL MOUNTED
SOAP DISPENSER**

- Refillable
- 1 Litre Capacity
- 23h x 13w x 10d cm



SA-3124



MANUAL SOAP DISPENSER

With anti-drip technology and easy load system with no risk of spill, North Shore's Manual Soap Dispenser is the ideal premium soap dispenser for high end washroom environments.

- High capacity, reducing the need for janitorial maintenance
- New nozzle with every cartridge minimises cross contamination and germ harbouring
- Small user contact area makes for simple and efficient cleaning
- Generous shot size and easy lather encourages effective use and reduces waste
- Simple, manual pump action dispensing with large push bar makes it child and elderly friendly
- h298mm w118mm d105mm

***FREE ON LOAN**
***SUBJECT TO AGREEMENT**



Available in 3 colours

*please state colour when ordering

SA-6710

SOAP 1000ML

For use with the North Shore's manual soap dispensers.

SA-6712	Lotion Foam Soap
SA-6713	Anti-bacterial Foam Soap
SA-6714	Instant Sanitiser - Alcohol Free

REDUCING WASTE



- Reduces overuse
- Foam reduces water consumption
- Spill free refilling

MINIMISE MAINTENANCE



- High capacity - fewer service visits
- Fast to replenish
- Drip free

IMPROVE HYGIENE



- New nozzle with each cartridge
- Wipe clean
- Alcohol and Alcohol Free sanitiser and antibac options

EASY TO USE



- Suitable for all ages and abilities
- Easy to lather foam soap
- Quick absorbing sanitisers

Manual Soap Dispenser



EASY LOAD SYSTEM

BEST SELLER

SOFT CARE LINE DISPENSER FOR SOFT CARE LINE 700ML & 800ML CARTRIDGES

BEST SELLER

- A wall mounted dispenser for all Soft Care Line products
- Sleek and hygienic design
- Easy to clean



HC-3870	Soft Care Dispenser for Liquid Soap - 800 doses	Each	-
HC-3874	Soft Care Dispenser for Foam Soap - 1400 doses	Each	-
HC-3876	Soft Care Foam Soap	700ml	Soft Care Foam H2
HC-3875	Anti Bac Foam Soap	700ml	Soft Care Plus Foam H42
HC-3770	Bacterial Hand Wash Cream	800ml	Soft Care Plus H41
HC-3871	Soft Care Reconditioning, Moisturising Hand Cream	800ml	Soft Care Derasoft H9
HC-3872	Soft Care Lightly Perfumed Hand Wash Cream	800ml	Soft Care Fresh H1
HC-3769	Soft Care Alcohol Gel Perfume Free Contains Moisturiser	800ml	Soft Care Med H5
HC-3873	Soft Care Mild Synthetic Hand Wash Cream	800ml	Soft Care Mild H2
HC-3877	Soft Care Mild Skin Disinfectant & Conditioner	800ml	Soft Care Sensisept H34
HC-3878	Mild Natural Soap for Frequent Use	800ml	Soft Care H21

KATRIN®
"CLEAN & GREEN"

Katrin ensure that their washroom solutions are hygienic, easy to use and sustainable. Making everyday life healthier, simpler and kinder to the environment.

NOW IN STOCK!
contact us to find out more



Introducing...

Superior results time after time

Our own-brand premium chemical range



Reduce your costs and environmental waste
with our super concentrated formula lines
You could save 15-25% on your annual spend

Did you know?

On average, 27% of a care home consumable budget is spent on cleaning and laundry chemicals

Switching to FRESH can help you meet your budget AND clean effectively



Our super concentrated formulas help to reduce single use plastics

FRESH MEETS GUIDELINES

COLOUR CODED RANGE

Our FRESH range meets the national colour coding guidelines to make it easy to use





Our all new...

BEST PRACTICE TROLLEY

- Lockable lid and side door
- 1x 22L drawer
- 1x bucket raising device
- 1x shelf included

Waste area includes foldable bag holder with lid and removable bag support.

FR-1000



ERGONOMIC

Made with lightweight materials



SAFE

Lockable units for safe storage



EASY TO CLEAN

Premium polypropylene



MODULAR

Customisable with wide range of accessories



SUSTAINABLE

Components fully recyclable



LOCKABLE UNITS

Keeping chemicals safe has never been easier.

YOUR CARE HOME NAME HERE

120 L PLASTIFIED BAG WITH STRING

Ideal to be used to hold the traditional nylon bags for a higher discretion, easy to clean with a damp mop



FR-1000-BAG-R	RED
FR-1000-BAG-B	BLUE
FR-1000-BAG-GR	GREEN
FR-1000-BAG-Y	YELLOW
FR-1000-BAG-BR	BROWN
FR-1000-BAG-GRY	GREY

INSERTS FOR 120L BAG HOLDER

To allow for waste / laundry stream separation



FR-1018-2/70	2X 70L
FR-1018-90/30	90 + 30L
FR-1018-3/40	3X 40L
FR-1018-20/70	1X 20L 2X 70L

BUCKET RAISING DEVICE FOR 22L DRAWER

FR-1001



TROLLEY SHELF WITH REINFORCEMENT

FR-1020



4L STORAGE BUCKET WITH UPPER HANDLE

Ideal for traditional use



TROLLEY DRAWER

3 sizes available



FR-1019-R	RED
FR-1019-B	BLUE
FR-1019-G	GREEN
FR-1019-Y	YELLOW

FR-1021-10L	10L
FR-1021-22L	22L
FR-1021-40L	40L

GLOVE BOX HOLDER

Stainless steel glove box holder attachment.

FR-1002



NICKITA TEC TROLLEY WITH HANDLE

Double cleaning trolley with professional jaw wringer. Ideal for cleaning medium-large areas where it is necessary to rinse the mop.

Lightweight and compact to facilitate manual handling during cleaning operations.

- 15L red handle bucket
- 15L Blue handle bucket
- Integrated wringer



FR-1003

15L BUCKET

Bucket suitable for use with the Nickita trolley system or stand alone.

- Colour coded handle for differentiation



FR-1022-B Blue

FR-1022-R Red

TELESCOPIC HANDLE

Extends 102cm to 184cm, 23mm diameter.

Aluminium telescopic handle with non-slip ergonomic grip and cap. Ideal for a professional clean featuring an ergonomic design.



FR-1004

SCOUT HANDLE HOLDER

- Simply clips mop handle to trolley
- 10 Pack



FR-1005

COLOUR CODE CAPS

For telescopic aluminium handle 10 pack



FR-1004-CAP-GRY Grey

FR-1004-CAP-BLU Blue

FR-1004-CAP-RED Red

FR-1004-CAP-GRN Green

FR-1004-CAP-YEL Yellow

UNI-JUNIOR FLAT MOPPING KIT

Ideal for high performance cleaning of horizontal and vertical surfaces.

- 35cm mop frame with touch free design
- 35cm soft band flat mop with colour coded tabs
- 140cm 4-piece handle
- 14L bucket with wringer and colour coded handle

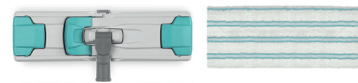

FR-1010-BLUE Blue

FR-1010-RED Red

FR-1010-GREEN Green

FR-1010-YELLOW Yellow



FRESH

FRESH Concentrate Dispensers



We work with your team every step of the way and provide ongoing training and support with regular visits.

Fresh autodosing dispensers ensure that the correct chemical dose is used for all applications, delivering optimal results and accurate cost control. One pump adds the correct level of chemical to a trigger spray bottle filled with water.

The bucket fill pump adds the correct amount of chemical to a mop bucket. Dispensers are supplied and installed free on loan and come with a comprehensive support package including product guidance and wall charts, please speak with your account manager for full details.



Changing to Fresh chemicals is a smooth and easy process and our experienced team will help you all the way, we will;

- Conduct a site survey of your home(s) and agree with your team where to install dosing equipment and wall charts
- Guide you on running down your old stock to ensure nothing is wasted
- Help to put together your first chemical order, making sure that you only have to buy what's needed to get you started
- Agree a date for the change over
- Our qualified engineering team will visit on the agreed day to install the equipment, talk you through everything and give your team guidance on everything they need to know
- Installations are completed to minimise disruption and ensure that everything is to your satisfaction

UNI SYSTEM MOP HOLDER 40CM

Hands free connection and release of uni flat mop heads. For high-performance cleaning.



FR-1006

MICRORICCIO UNI SYSTEM 40CM

Microfibre flat mop looped end with polyester support. Ideal for any surface and for particle dirt thanks to the high dirt collection power of yarn and microfibre.

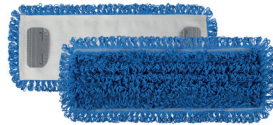

FR-1007-WHT	White + tabs
FR-1007-BLU	Blue
FR-1007-RED	Red
FR-1007-GREEN	Green
FR-1007-YELL	Yellow



MICROBLUE UNI SYSTEM 40CM

Microfibre and polypropylene flat mop with polyester.

Ideal for washing of non-slip or porous surfaces, suitable to remove ingrained dirt.

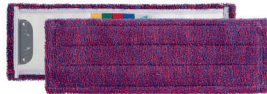

FR-1008-CYAN	Cyan + tabs
FR-1008-BLUE	Blue + tabs
FR-1008-RED	Red + tabs





NON BIOLOGICAL LAUNDRY LIQUID CONCENTRATED

A concentrated detergent for whites and colours. Specially formulated for sensitive skin. Delivers superb cleaning performance across a wide variety of stains.

IDEAL FOR:

Machine laundry washing. For use through FRESH dosing equipment or main wash dispenser.

Directions for use:

Normal soiling

8ml per kg dry weight.

Heavy soiling

12ml per kg dry weight.

10LTR

FR-3220



BIOLOGICAL LAUNDRY LIQUID CONCENTRATED

A concentrated detergent for whites and colours. Delivers superb cleaning performance across a wide variety of stains.

IDEAL FOR:

Machine laundry washing. For use through FRESH dosing equipment or main wash dispenser.

Directions for use:

Normal soiling

8ml per kg dry weight.

Heavy soiling

12ml per kg dry weight.

10LTR

FR-3221



LOW TEMPERATURE LAUNDRY DESTAINER

A unique colour-safe destainer. Starts working from only 20°C, saving energy and time. Tough on stains, gentle on fabrics.

IDEAL FOR:

Machine laundry washing of whites and colours. For use through FRESH dosing equipment.

Directions for use:

Normal soiling

4ml per kg dry weight.

Heavy soiling

6ml per kg dry weight.

10LTR

FR-3223



FABRIC CONDITIONER

Premium fragrance clings to fibres leaving clothes smelling fresh for several days. Softens, reduces static, with the added benefit of quick dry and easy iron features.

IDEAL FOR:

Machine laundry washing. For use through FRESH dosing equipment or fabric conditioner dispenser.

Directions for use:

Use 5-8ml per kg dry weight.

10LTR

FR-3222



SUPER SOFT ENCAPSULATED FABRIC SOFTENER

Fresh super soft features an effective long-lasting fragrance and restores softness and bounce to laundry. It's innovative anti-static properties reducing the need for ironing wash after wash.

IDEAL FOR:

Machine laundry washing. For use only through FRESH dosing equipment or main wash dispenser.

Directions for use:

Use 5-8ml per kg dry weight.

10LTR

FR-3224



COUNTRY SOFT ENCAPSULATED FABRIC SOFTENER

Country soft incorporates encapsulation technology, helping the fragrance to penetrate laundry fibres and stay fresher for longer. Replenishes softness in linen and features antistatic properties.

IDEAL FOR:

Machine laundry washing. For use only through FRESH dosing equipment or main wash dispenser.

Directions for use:

Use 5-8ml per kg dry weight.

10LTR

FR-3229



LAUNDRY SPOT & STAIN REMOVER

An effective specially formulated liquid that removes tough stains like tea, coffee, oil and grease.

DOES NOT contain peroxide or bleach.

IDEAL FOR:

Machine laundry washing of whites and colours. For use through FRESH dosing equipment or main wash dispenser. **DO NOT use on wool, silk, leather, flame resistant fabrics, dry-clean only garments or on metal parts.**

Directions for use:

Follow washing instructions on garment's label. If in doubt, check for colour fastness.

5LTR

HC-3190

Empty trigger bottle

750ML

HC-3190-TR



H1 ANTIBAC MULTI SURFACE CLEANER SUPER CONCENTRATED

Extremely versatile product that cleans, degreases, deodorises and sanitises in one action, leaving a sweet lemon fragrance.

Complies with - EN1276 (bacteria)
EN1650 (fungal) EN13623 (legionella)
EN14476 (viricidal) EPA Approved
(NOROVIRUS, HIV, Influenza, Hepatitis B,
Hepatitis C, Adeno Virus).

IDEAL FOR: A wide variety of hard surfaces including floors.
For Compliance with EN1276 3 shots are required per 2.5L with a 5 minute kill rate.

1 litre of concentrate makes 100 triggers

Directions for use:

Follow dosing instructions on product label.

1LTR

2LTR

HC-7030

HC-7030-2L

Empty trigger bottle

750ML

HC-7030-TR

VISIT countrywidehealthcare.co.uk



H2 AIR FRESHENER & ODOUR NEUTRALISER SUPER CONCENTRATED

Freshens and deodorises rooms leaving a pleasant long-lasting fresh fragrance.

Easy and economical to use.
Can be used on curtains and fabrics *subject to fabric manufacturer's instructions.

IDEAL FOR:

Spray lightly into the corners of the room as required, avoiding furniture. **DO NOT** spray directly onto fabrics or furnishings.

1 litre of concentrate makes 100 triggers

Directions for use:

Follow dosing instructions on product label.

1LTR

2LTR

HC-7031

HC-7031-2L

Empty trigger bottle

750ML

HC-7031-TR

CALL 01226 719090



H3 GLASS & MIRROR CLEANER SUPER CONCENTRATED

An innovative formula offering sparkling results and a streak-free finish, of grease, dirt, and finger marks without the use of harsh chemicals.

IDEAL FOR:

Use on glass, mirrors, stainless steel, brass and all water washable surfaces. Will not damage delicate surfaces.

1 litre of concentrate makes 100 triggers

Directions for use:

Follow instructions on product label.

1LTR

2LTR

HC-7032

HC-7032-2L

Empty trigger bottle

750ML

HC-7032-TR

EMAIL sales@countrywidehealthcare.co.uk



ANTIBAC MULTISURFACE CLEANER RTU

An extremely versatile product that combines efficient cleaning and degreasing with a wide spectrum of activity as a virucide, bactericide, fungicide and deodorant.

Passes
EN 1276 &
EN 14476

Directions for use:

Spray on surface, wipe with a clean dry cloth. Allow to air dry.

5LTR

750ML

HC-3464

HC-3465



CLOSTRIDIUM DIFFICILE SPORICIDAL CLEANER READY TO USE

The Clostridium difficile sporicidal cleaner is an essential everyday product in the fight against cross infection, it cleans and sanitises frequently touched surfaces.

Bleach free, non-hazardous, non-toxic and safe to use on all common water washable surfaces. Pleasantly perfumed and leaves a freshly cleaned fragrance to rooms. Passes EN 1276, 13704 & 14476.

Directions for use:

Spray onto surface and wipe with a clean dry cloth. Allow to air dry.

Ready to use
750ML

HC-4158



CHLORINE SPRAY & WIPE READY TO USE

Designed for hard surfaces or the removal of stains, grease and mould. Chlorine based for rapid action.

Not suitable for use with carpets and fabrics. Bleach can cause damage to fabrics, carpets, plastic and many other common materials. Rinse porous and non-porous surfaces after treatment.

Directions for use:

Spray on surface as required, allow product to soften the soiled area then wipe off with a damp sponge or cloth.

Ready to use
750ML

HC-4159



HARD FLOOR CLEANER FRESH LINEN FRAGRANCE SUPER CONCENTRATED

PREMIUM scented floor cleaner for removing soil, grease and heel marks from a wide range of non-porous flooring surfaces.

IDEAL FOR:
Use on linoleum, PVC, sealed wood and thermoplastic floors. **Not recommended for use on unsealed wood and cork flooring.** No need for rinsing when used diluted. Suitable for mopping and auto scrubbers.

Directions for use:

Daily cleaning dilute 1:100
Periodic cleaning dilute 1:50

Fresh Linen
5LTR Empty trigger bottle
750ML

HC-1019

HC-1019-TR



CARPET CLEANER WATER EXTRACTION

A scientifically balanced blend of a surface active agent and selected cleaning ingredients for use on all types of carpeting.

Suitable for carpets of synthetic and natural fibres when used in conjunction with a hot water extraction machine. Also safe and effective for the cleaning of upholstery fabrics.

Directions for use:

Normal soil: dilute 1:100
Medium soil: dilute 1:75
Heavy soil: dilute 1:50

5LTR

HC-0754



ODOUR ELIMINATOR & MULTI-PURPOSE CLEANER CONCENTRATED

Environment- friendly, biological cleaner. Tough on grease, dirt and stubborn soiling. A low-foam product that can be applied by trigger spray, pressure spray or by cloths, etc. Fresh Linen Fragrance.

IDEAL FOR:

Highly effective against a huge variety of odours ranging from urine, cigarette smoke, refuse to faeces, vomit and sour milk. Can be used on carpets, upholstery, curtains, floors, walls, and to clean washrooms.

1 litre of concentrate makes 100 triggers

Directions for use: Always dilute product with water before use: Add 2 plunge from dispenser per trigger spray bottle. For pressure spray usage, follow dosing instructions on product label.

1LTR	2LTR	Empty trigger bottle 750ML
HC-7039	HC-7039-2L	HC-7039-TR



ODOUR DIGESTANT CONCENTRATED

PREMIUM enzyme based floral cream liquid that eliminates odours and other organic soils.

IDEAL FOR:

Carpet, upholstery and hard surfaces especially in kitchens & bathrooms. Can be used in a carpet extract machine.

Directions for use:

Carpets & Upholstery: Dilute 1:1
Hard Surfaces: Dilute 1:1
Drain Maintenance: Apply 100ml at the end of the day. For multi-level facilities, treat lowest floor first.

5LTR	Empty trigger bottle 750ML
HC-1016	HC-1016-TR



ODOUR & STAIN LIFTER READY TO USE

A Fresh linen scented biological odour and stain remover is tough on dirt and stubborn soiling. Highly effective against a wide variety of stains ranging from urine, vomit, blood, coffee, and tea to sour milk and faeces. Safe to use on carpets, upholstery, soft furnishings that are difficult to clean.

IDEAL FOR:

Safe to use on carpets, upholstery, soft furnishings that are difficult to clean.

Not suitable for use on Laundry

Directions for use:

Always test for colour-fastness in an inconspicuous area. Dry spots should be agitated and dampened before application. Spray direct on to stain, allow to penetrate. Absorb the stain by blotting with paper or cloth. Allow to dry or extract with machine.

Ready to use 750ML	HC-4157
-----------------------	---------



ANTIBAC MULTIPURPOSE WASHROOM CLEANER SUPER CONCENTRATED

Pleasantly perfumed concentrated all round washroom cleaner. Meets EN1276 requirements.

IDEAL FOR:

Cleans, descales, sanitises and deodorises in one operation leaving behind a fresh, hygienic washroom environment. Ideal for washrooms including floors and mirrors.

1 litre of concentrate makes 100 triggers

Directions for use:

Follow dosing instructions on product label.

1LTR

HC-7035

2LTR

HC-7035-2L

Empty trigger bottle

750ML

HC-7035-TR



HIGH PERFORMANCE WC CLEANER READY TO USE

PREMIUM fast action! Loosens limescale and dissolves stains with ease, leaving surfaces clean with a fresh fragrance.

IDEAL FOR:

Hard water areas. Toilet rims and urinals.

Do not mix with any other cleaning product or bleach. Do not use on any type of bath, vitreous enamel or fibre glass. Do not allow product to freeze.

Directions for use:

1. Direct nozzle under rim of toilet / across urinal.
2. Apply evenly over surface, leave for 2 mins.
3. Agitate with brush if necessary.
4. Flush and rinse brush.

1LTR

HC-0752

5LTR

HC-0774



FRESH LEMON ORIGINAL CREAM CLEANER

A high quality, non-scratch scouring cream suitable for rapid cleaning with a fresh lemon smell

IDEAL FOR:

Polishing stainless steel, chrome, aluminium laminates and enamel

Directions for use:

Apply lightly onto surface to be cleaned and buff to a shine with a clean cloth.

500ML

HC-5891



LEMON WASHING UP LIQUID READY TO USE

PREMIUM fresh citrus lemon fragrance for long lasting suds and lifting of heavy grease and soiling.

IDEAL FOR:

Cleaning cutlery, crockery, glassware, worktops, walls, and all light duty hand washing.

Directions for use:

Always use hot water.

Dishwashing 800:1

General Cleaning 250:1

Upholstery 40:1

1LTR

HC-1018

5LTR

HC-1017



K1

UNPERFUMED ANTIBAC CLEANER & SANITISER SUPER CONCENTRATED

Specially formulated to clean, degrease and sanitise in one operation. Odourless and non-tainting. **BSEN1276** & **EN14476** certified solution with a required contact time of only 30 seconds.

IDEAL FOR: For use on all hard surfaces.

1 litre of concentrate makes 100 triggers.

Directions for use: Follow dosing instructions on product label.

For Compliance with EN1276 3 shots are required per 2.5L with a 5 minute kill rate

1LTR

HC-7033

2LTR

HC-7033-2L

Empty trigger bottle

750ML

HC-7033-TR



K2

KITCHEN CLEANER & DEGREASER SUPER CONCENTRATED

A powerful alkaline detergent that will remove the heaviest of oils, grease and protein based soiling.

IDEAL FOR:

Greasy floors, walls and worktop surfaces found in kitchens and food processing equipment.

1 litre of concentrate makes 100 triggers

Directions for use: Follow dosing instructions on product label.

1LTR

HC-7034

2LTR

HC-7034-2L

Empty trigger bottle

750ML

HC-7034-TR



KITCHEN DEGREASER CONCENTRATED

A PREMIUM high active multi purpose, heavy duty detergent for those really difficult cleaning tasks.

IDEAL FOR:

Cooker hoods, deep fat fryers, ovens, floors & walls.

Directions for use:

General Cleaning: Dilute 1:250

Heavy Soiling & Grease: Dilute 1:50

Cleaning Deep Fat Fryers: Dilute 1:25

Trigger Sprays: 1:10

Empty trigger bottle
5LTR **750ML**

HC-1001

HC-1001-TR



SCALE-AWAY DESCALER CONCENTRATED

PREMIUM phosphoric acid descaler designed to safely remove the heaviest build-up of limescale.

IDEAL FOR:

Kettles, dishwashers, glass washers, tea urns and hard surfaces.

Directions for use:

Dishwashers & Glass Washers: Dilute 1:20

Tea urns: Dilute 1:20

Add 10 doses via 30ml pelican pump (code HC-9091) fitted to 5 litre container.

Hard Surfaces Dilute 1:20

5LTR

HC-1000



CLEAR MINT DRAIN CLEANER CONCENTRATED

Biologically breaks down fat and grease deposits quickly and safely. Contains no corrosive or harsh chemicals and will not harm metal, plastic, or ceramic drain materials. The ingredients in this product are entirely biodegradable.

IDEAL FOR:

Ideal for use in food production areas such as restaurants, care home kitchens, and staff canteens.

Directions for use:

Plughole: 500ml of product with 5 Ltr warm water. Pour down a plughole. Repeat over 4 nights.

Drain Maintenance - Heavy Duty: Dilute 1Ltr: 2Ltr warm water and dose directly to the drain. Repeat until the drain clears.

5LTR

HC-4147



DISHWASHER DETERGENT

PREMIUM highly concentrated, powerful liquid detergent for use in hard and soft water areas. Offers excellent stain removal ability and prevents deposition of hard water scale. Advanced soil suspending formula prevents staining and corrosion inhibitors which reduce metal marking. Designed to produce top class results without damaging the 'on glaze' decoration.

IDEAL FOR:

Machine dishwashing and glasswashing. For use only through FRESH dosing equipment.

Directions for use:

Soft water: 2mls per litre of wash water volume.

Hard water: 4mls per litre of wash water volume.

For optimum results use in conjunction with Rinse Aid. **Not suitable for use with aluminium.**

10LTR

FR-3227



RINSE AID

PREMIUM liquid for sparkling results and table-ready dishes and glasses after each cycle.

IDEAL FOR:

Machine dishwashing and glasswashing. For use only through FRESH dosing equipment.

Directions for use:

2-3mls per litre.

10LTR

FR-3228

BIO LAUNDRY POWDER - 10KG

A specially formulated free flowing biological laundry powder. Powerful and effective in the removal of dirt and stains.

HC-3207



NON-BIO LAUNDRY POWDER - 10KG

A gentle non-biological powder suitable for all clothing types. This powder is the ideal choice for those with sensitive skin.

BEST SELLER

HC-3193

BIO LAUNDRY LIQUID

A powerful & effective biological detergent containing whitener. Ideal for use in all types of washing machines. PrimaCare laundry liquid is most effective when used alongside PrimaCare fabric softener. Also suitable for hand washing.

DILUTION RATES:

Soft water: 120/150ml
Hard water: 150/180ml



5LTR

HC-1084

10LTR

HC-6724

FABRIC CONDITIONER

Restores softness and bounce to woollens. Also stops static-clinging in man-made fibres and makes ironing easier, leaving your clothes with a lovely fresh smell.

DIRECTIONS FOR USE:

For use through machine dosing equipment connect feed pipe directly to container.

DILUTION RATES:

By hand: Add 1-2 capfuls to final rinse.

BEST SELLER



5LTR

HC-0770

10LTR

HC-6723

LAUNDRY DESTAINER

Designed to penetrate and break down stains, this pre-wash destainer allows laundry detergent to remove stains more effectively.

DIRECTIONS FOR USE:

Use dispensing equipment. Best results are obtained in a high temperature wash.

DILUTION RATES:

Use 5ml to 30ml/Kg dry load depending on staining to be removed.



10LTR LIQUID

HC-3192

10KG POWDER

HC-3194



DISHWASHER DETERGENT

A specially formulated tough working machine dishwasher detergent.

DIRECTIONS FOR USE:

As specified by the machine manufacturers.

DILUTION RATES:

If machine is not metered 1-200.

BEST SELLER

5LTR

HC-6705

10LTR

HC-6726



RINSE AID

A hard and soft water dishwashing machine rinse aid. Ensures sparkling crockery and cutlery, and smear free glassware.

DIRECTIONS FOR USE:

Suitable for hard or soft water. Inject in final rinse.

5LTR

HC-6706

10LTR

HC-6725



GRANULAR SALT

BEST SELLER

25KG

HC-6708



SALT TABLETS

25KG

HC-6713



DISHWASHER DETERGENT SUPER STRENGTH

Formulated to meet the most exacting conditions where liquid detergent is required, whether for glass or dishwashing applications. Directions for use specified by the machine manufacturers.

DILUTION RATES:

If machine is not metered 1-300

5LTR

HC-0764



DISHWASHER POWDER

A specially formulated tough working dishwasher powder. Effectively removed stubborn stains from crockery, cutlery and utensils.

DILUTION RATES:

30-40g of powder (approx 2 heaped tablespoons) For heavily soiled/hard water use slightly more powder.

10KG

HC-3208



DISHWASHING DESTAINING POWDER

Specially formulated for those stubborn tea, coffee & food stains. DIRECTIONS FOR USE: Urns, tea & coffee pots: 20g per 1ltr water Inject in final rinse.

10KG

HC-3209



LEMON WASHING UP LIQUID

A zesty lemon washing-up liquid that gives a fresh natural fragrance ensuring a sparkling clean finish.

DILUTION RATES:

1 Tbsp /4.5Ltrs hand hot water
(48°C/118°F)



1LTR

5LTR

HC-3393

HC-3392

WASHING UP LIQUID SANITISING

A specially formulated detergent that has the power to clean and disinfect crockery, cutlery and utensils.

DILUTION RATES:

General washing-up:
1/160 parts hand hot water.

Washing-up and sanitising crockery, glassware: 1/80 parts hand hot water.



5LTR

HC-6364

WASHING UP LIQUID SUPER STRENGTH

A super high active detergent that attacks grease and stubborn stains. Leaves your crockery, cutlery and utensils impressively clean.

DILUTION RATES:

1/2 -1 Tbsp/4.5Ltrs hand hot water
(48°C/118°F)

BEST SELLER



1LTR

5LTR

HC-3394

HC-3391

WASHING UP LIQUID

A general purpose washing up liquid with a pleasant fragrance that easily cuts through grease.

DILUTION RATES:

1 Tbsp/4.5Ltrs hand hot water
(48°C/118°F)



5LTR

HC-1085



KITCHEN SANITISERS

Available in both 750ml, 5Ltr ready to use and 5Ltr concentrated.

Our range are:

- Odourless
- Non-tainting
- Biodegradable
- Phosphate free
- Safe to use on aluminium

All are Specially formulated for use on all hard surfaces including:

- Work tops
- Table tops
- Kitchen cabinets
- Tiles
- Sinks
- Cooker tops
- Floors
- Walls

BEST SELLER

750ML TRIGGER SPRAY

HC-0720

5LTR

HC-0721



RAPID OVEN CLEANER

A versatile and effective cleaner that removes even the most stubborn baked on fat and grease.

DIRECTIONS FOR USE:

1. Pre-heat oven to 90c/200F/ Regulo 1/4 and turn off.
2. Spray onto interior of oven, avoid making spray mist, spray evenly.
3. Clean with cloth or scouring pad and rinse with water.
4. Check pilot light has not gone out and heat oven for up to 10 minutes.

5LTR

HC-0775

6 X 750ML

HC-0776-CASE



GENERAL PURPOSE KITCHEN DEGREASER

A heavy duty multi-purpose cleaner & degreaser. Effectively removes kitchen grease & grime from all washable surfaces.

DIRECTIONS FOR USE:

1. Spray or wipe on-wipe off with damp cloth.
2. Use undiluted for heavy grease or grime

DILUTION RATES:

General cleaning: 1/10

5LTR

HC-0757



NON-PERFUMED DISINFECTING FLUID

An effective disinfecting fluid that kills bacteria, fungi and spores. Simple and reliable.

DIRECTIONS FOR USE:

For sanitising crockery, glassware, work surfaces, fridges, freezers (inside & out), cloths, mops, fruit & vegetables, vending machines, kitchen equipment and laundries.

1LTR

LC-3150

5LTR

LC-3149



WASHROOM CLEANER & SANITISER

Effective against a wide range of bacteria including: E-Coli, Enterococcus faecium Salmonella. Suitable for all washroom areas.

DIRECTIONS FOR USE:

For use on toilet bowl and seat, wash basins, baths, wall tiles, showers. Spray onto the surface. Leave and wipe with a clean cloth.

**RTU contact time 5 minutes for
EN1276:2019 & EN14476:2013+A2:2019**



**750ML TRIGGER
SPRAY**

HC-3467

5LTR

HC-3468

SLUICE WASH

Powerful detergent for the cleaning of bed pans, commode pots, urine bottles and related utensils using the auto dosing bed pan and sluice washing machines.



5LTR X4

HC-0746-CASE

WC CLEANER

Kills malodours & 99.9% of bacteria. Ideal for toilets, glass, vinyl, plastics & stainless steel. Pine fragrance.

BEST SELLER



1LTR

HC-0731

THICK BLEACH

Used for sanitising and stain removal.

- Fresh smelling
- Effective cleaner and disinfectant
- Leaves areas germ free and sparkling clean

1LTR

HC-1089



5LTR

HC-1091



ECONOMY BLEACH

Our everyday bleach formula is ideal for general cleaning and disinfecting.



5LTR

HC-0750

**ODOUR ELIMINATOR
CONCENTRATED**
BEST SELLER

A powerful & perfumed disinfectant that kills the bacteria causing the odour. It can be used on all floor types; carpets, furniture, beds & toilet areas.

DIRECTIONS FOR USE:

This is a concentrated odour killer, not a masking agent.

For small spillages:

Dilute 1/10 parts water. For large or persistent problems:

- 1 Dilute 1 to 5 or use neat.
- 2 Apply to area, leave minimum of 5 minutes,
- 3 Clean up with warm water.
- 4 Apply with mop, cloth or trigger spray.

Do not mix with other cleaners or chemicals. May cause allergic reaction.

**750ML TRIGGER
SPRAY** Ready to use
(not refillable)

HC-0740
1LTR
HC-0728
5LTR
HC-0747
AIR FRESHENER

Energise your senses with this range of fresh, pleasant fragranced air fresheners.

DIRECTIONS FOR USE:

Use undiluted in a trigger spray where a pleasant aroma is required.

Potpourri
**750ML TRIGGER
SPRAY** Ready to use
(not refillable)

HA-5855
5LTR
HA-5856

Honeysuckle
**750ML TRIGGER
SPRAY** Ready to use
(not refillable)

HA-5857
5LTR
HA-5858

Lemon & Ginger
**750ML TRIGGER
SPRAY** Ready to use
(not refillable)

HA-5842
5LTR
HA-5841

Citrus Fresh
**750ML TRIGGER
SPRAY** Ready to use
(not refillable)

HA-5840
5LTR
HA-5841

HARD SURFACE CLEANER

An effective cleaner for most surfaces with a vibrant, fresh floral pine fragrance. Suitable for floors, walls, paintwork and heavy duty cleaning.

DIRECTIONS FOR USE:

General cleaning, floor mopping, paintwork etc:

Dilute 1 part to 30 parts water.

Heavy duty cleaning, degreasing of: Floors, ovens, ducts, fans, garage walls, work benches, plastic seats, etc: Dilute 1 part to 5 parts water.

For very stubborn marks or stains:

Can be used neat, first test for any colour removal.



5LTR

HC-0751

DISINFECTANT

A powerful & effective pine fresh/floral disinfectant.

DIRECTIONS FOR USE:

Ideal for floors, ledges and tables when used with a mop/ wipe at normal dilution of 1 part to 30 parts water. For sinks, drains, toilets and sick room use neat on a daily basis.

BEST SELLER



Pine Fragrance

5LTR

HC-1081



Floral Fragrance

5LTR

HC-1082

FURNITURE POLISH

A quick and easy ready to use polish, providing a long lasting shine.



750ML TRIGGER
SPRAY

HC-0765

GLASS & STAINLESS STEEL CLEANER

A ready to use Glass & Stainless Steel Cleaner which effectively cuts through grease & grime to leave a smear free finish.



750ML TRIGGER
SPRAY

HC-1086



MULTI PURPOSE CLEANER & SANITISER

BEST SELLER

Powerful & effective against a wide range of bacteria including E.Coli, Listeria, Salmonella & MRSA.

BSEN1276 - BSEN13697

- ❶ Spray onto surface
- ❷ Leave and wipe with a clean cloth.
- ❸ Contact time 1 minute.

1 MINUTE CONTACT TIME



**750ML TRIGGER
SPRAY**

5LTR

HC-0762

HC-0763

4 IN 1 FOAMING WASHROOM CLEANER

Cleans, descales, sanitises and deodorises in one operation, killing bacteria while leaving a fresh, hygienic environment.

DIRECTIONS FOR USE:

- ❶ Spray product directly onto surface,
- ❷ Wipe away dirt and grime with a clean wet cloth.
- ❸ Stubborn soilage may require agitation.



**750ML TRIGGER
SPRAY**

5LTR

HC-3461

HC-3460

LOW FOAM / NO RINSE FLOOR CLEANER

Low foaming neutral pine or lemon cleaner, ideal for daily mopping of finished floors. Also ideal for use with a scrubber drier due to the low foaming properties of the product. Will not dull floors between buffing.

DILUTION RATES:

Daily Cleaning: 1:100

Periodic Cleaning: 1:50



5LTR

HC-3451



5LTR

HC-3450

FLOOR GEL

BEST SELLER

A neutral pine or zesty lemon Janitorial cleaner with germicidal and deodorant properties.

DILUTION RATES: Floors, painted surfaces, toilets, baths, showers & rest rooms: 1/40



Pine Fragrance

5LTR

HC-3196



Lemon Fragrance

5LTR

HC-5859

BioHygiene

Introducing BioHygiene, the UK's **leading** biotech cleaning brand

Our Vision

At BioHygiene we want to replace harmful, non-renewable chemical products with environmental biotech alternatives to improve human and environmental health



Reduce the Effects of Climate Change



No Ingredients Toxic to Humans



No Ingredients Toxic to Aquatic Life



Stop Plastic Pollution



COST SAVINGS



SKU REDUCTION



TRANSPORT SAVINGS



STORAGE REDUCTION



PLASTIC WASTE REDUCTION



CARBON REDUCTION

How We Help You Save



- Catering
- Dishwashing
- Housekeeping
- Laundry
- Hand Care
- Floor Care
- Specialist

BioHygiene

Safer Way to Sanitise

- ✓ BioHygiene's eco friendly sanitiser range provides a **complete virucidal and bactericidal solution**. Approved to EN14476 for enveloped viruses, including **coronaviruses, e.g. SARS-CoV-2**.



Effective cleaning:

- ✓ Clean, Descale, Deodourise and Disinfect.
- ✓ Eco friendly, naturally derived ingredients.
- ✓ Approved to EN14476, EN1276, EN13697, EN13623, EN1650.
- ✓ UK Manufacturer.



ODOUR STOPPER & STAIN SPOTTER - 750ML

A highly effective stain and odour remover. Our dual-action enzymatic formula gets deep into porous surfaces and fabrics, quickly breaking down hidden organic deposits to remove odours and lift stains directly at the source.

- Effective on all organic odours and stains including food spills and human/pet accidents
- Suitable on most colour fast surfaces
- Long-lasting residual performance
- 100% naturally derived ingredients
- Reduced CO2e by up to 85%

HC-7091



ALL SURFACES & FLOOR CLEANER 5L

A highly concentrated, microbial and enzymatic-based all purpose cleaner. Quickly target dirt, grease and grime and remove odours directly at the source for long-lasting results.

- Effective on all porous surfaces
- Non-rinse
- Naturally derived ingredients
- VOC free and 100% biodegradable
- 1 x 5L = 1250 trigger bottles

HC-7089



ALL PURPOSE SANITISER

Quad-action virucidal, bacterial and fungicidal cleaner disinfectant.

- Effective against EN14476, EN13697, EN1276, EN13623 and EN1650
- Supported under EU Biocides Regulation (528/2012)
- Long-lasting residual action
- Fragranced for use in general areas
- Effective through fogging machines
- 1 x 5L = 665 trigger bottles

HC-7099



COMPLETE WASHROOM CLEANER 5L

A heavy-duty microbial and enzymatic cleaner to tackle tough environments

- Removes fat, scale and odours
- Super-concentrate (1:50)
- Naturally derived ingredients
- VOC free and 100% biodegradable

HC-7080



URINAL AND TOILET CLEANER SACHETS

Water soluble sachets combining biological treatments to clean and deodorise urinals and toilets.

- Removes organic matter, scale and general soiling
- Provides residual protection against odour and scale
- Low hazard rating
- Naturally derived ingredients

HC-7086



ORGANIC ACID DESCALER 1L

Utilises organic acids and naturally derived surfactants for cleaning and descaling of toilet/urinal bowls and associated pipework.

- Excellent scale removal and long lasting cling
- Removes bodyfats and soiling
- Safe on all washroom surfaces
- Carbon neutral

HC-7083



FOAM HAND SANITISER 500ML

A naturally-derived, alcohol and Quat free foaming hand sanitiser that helps maintain hand hygiene whilst being kind to the planet.

- Kills 99.999% of common germs
- Virucidal and bactericidal
- Approved to EN14476 and EN1276
- Uses beauty industry technology to minimise irritation and prevent drying
- Offers residual protection
- Reduced CO2e

HC-7146



LUXURY FOAM HAND SOAP 500ML

Antibacterial soap utilising naturally derived ingredients and eco-friendly surfactants, suitable for all environments.

Soothing emollients protect skin from drying, Available in a range of luxurious, delightful fragrances.

- Antibacterial action which preserves the skin's natural balance
- Hydrating and moisturising
- Paraben, Triclosan, Phosphate and Phosphonate free

HC-7142



FRAGRANCED FOAM SOAP 500ML

An eco-friendly liquid hand soap that helps maintain hand hygiene whilst being gentle on all skin types.

- Naturally-derived ingredients
- Hydrating and moisturising
- Paraben, Triclosan, Phosphate and Phosphonate free

HC-7141



UNFRAGRANCED FOAM SOAP 500ML

An eco-friendly liquid hand soap that helps maintain hand hygiene whilst being gentle on all skin types.

- Naturally-derived ingredients
- Hydrating and moisturising
- Paraben, Triclosan, Phosphate and Phosphonate free

HC-7140





ECO WASHING UP LIQUID 5L

A naturally derived washing up liquid that quickly and easily removes grease, oils and food residue from dishes and eating utensils, leaving them clean and streak free.

- Prevents redistribution of grease onto crockery, utensils and glassware
- Gentle on skin
- No residue
- Effective in hard and soft water
- Safe in septic tanks
- Phosphate and phosphonate free

HC-7117



AUTOMATIC DISHWASH 5L

An effective blend of eco-friendly chelating and alkalinity agents and specialist additives that removes all types of soiling from dishes, cutlery and crockery when used through an automatic dosing unit.

- Concentrated formula
- Controls hard water scale, preventing staining and improving rinsing
- Effective on grease, dried-on-food, oil, proteins and starch-based deposits
- Prevents scaling of dish wash machine even in hard water conditions
- Reduces CO₂e by up to 85%

HC-7121



ECOLOGICAL RINSE AID 5L

An effective cleaning agent that eliminates water marks and provides optimum drying performance of crockery, utensils and glassware after the dishwasher or glass wash cycle is complete.

- Prevents calcium deposits
- No chemical residue
- Works at all temperatures
- Suitable in hard and soft water
- Suitable for washing delicates
- Suitable for septic tanks • 100% biodegradable

HC-7123



KITCHEN CLEANER & DEGREASER 5L

An enzyme based no rinse, no slip cleaner formulated to permanently remove grease, and fat from slippery floors using renewable and sustainable ingredients.

- Effective on fat, oil and grease
- Removes odours at source
- Safe on all surfaces • PH neutral
- Unfragranced for safe use on food stations
- 100% biodegradable • 1 x 5L = 665 trigger bottles

HC-7111



KITCHEN SANITISER 5L

Quad-action virucidal, bacterial and fungicidal cleaner disinfectant for use in Kitchen and food service areas.

- Effective against EN14476, EN13697, EN1276, EN13623 and EN1650
- Supported under EU Biocides Regulation (528/2012)
- Long-lasting residual action
- Unfragranced formula for safe use around food
- Effective through fogging machines
- 1 x 5L = 665 trigger bottles

HC-7116



SOFT FABRIC CLEANER 5L

Soft Fabric Cleaner utilises specialist enzymes and microbes to break down organic-based deposits, removing stains and eliminating associated unpleasant malodours.

- Triple action: clean, remove stains and deodorise
- Safe, gentle removal of stains and odours
- Ensures longevity of fabrics
- Specifically designed to tackle organic based stains and odours from humans, pets and food based spills
- Suitable for use on most colour fast surfaces



HC-7128

ECO LAUNDRY DETERGENT (BIO) 10L

A super concentrated phosphate-free laundry detergent formulated with environmentally favourable ingredients, enzymes and naturally derived water softeners and surfactants from plant based sustainable resources.

- Formulate with a medley of enzymes to cover all stain types
- Enhances colours
- Strong fragrance for a long-lasting fresh, clean smell
- Suitable for most fabrics
- Exceptional cleaning under low temperatures
- 100% biodegradable



HC-7133

ECO LAUNDRY DESTAINER 10L

Environmentally friendly, water-based destainer offering superior bleaching and deodorising performance along with anti-microbial activity against a wide spectrum of bacteria and fungi.

- Phosphate-free
- Excellent destainer for most types of fabrics
- Exceptional whiteness on white linen, kitchenware and white towels
- Effective at lower wash temperature
- Extends fabric life
- 100% biodegradable
- Reduced carbon footprint



HC-7132

ECO LAUNDRY SOFTENER 10L

Environmentally friendly, naturally derived fabric softener delivering a luxury feel to fabrics with odour neutralising technology and long lasting fragrance. Reduces creases, static and improves fabric softness.

- Concentrated formula leaves laundry feeling soft, clean and luxurious
- Eliminates residual odours for long-lasting freshness
- Enhanced fragrance
- Suitable for septic tanks
- Anti-static technology reduces creases and extends fabric life
- Reduced carbon footprint



HC-7134



COUNTRYWIDE HEALTHCARE'S PARTNERSHIP WITH DIVERSEY MEANS THAT WE CAN PROVIDE EXPERT ADVICE ON PRODUCT SELECTION AND PROBLEM SOLVING AND HAVE A TRACK RECORD IN HELPING OUR CUSTOMERS DELIVER EXCEPTIONAL LEVELS OF CLEANLINESS AND HYGIENE IN A COST EFFECTIVE WAY.

HORIZON SOFT FRESH FABRIC CONDITIONER MANUAL DOSING

- Good softening of many types of fabric
- Prevents build up of static electricity on synthetic fibres
- Gives fabrics a pleasant odour
- Ready to use by machine

5LTR X2

HC-3661



HORIZON BIOPOWDER BIOLOGICAL DETERGENT MANUAL DOSING

- Excellent results
- Suitable for all types of fabric
- Free-flowing, non-clogging powder
- Ready to use

6.3KG

HC-3660



CONDITIONER, POWDER AND BOOSTER

This guide aims to simplify the choice of Laundry products for your business

Detergent	Destainer	Conditioner	Features	Healthcare
Horizon Light (Biological)	Horizon Bright	Horizon Deosoft	Low temperature washing, kills MRSA at 40°C and C.Diff at 60°C. Energy and cost savings.	✓
Horizon Light (Biological)	Horizon Percid	Horizon Deosoft	High temperature washing. Great on whites.	✓
Horizon Active (Non Biological)	Horizon Peroxy	Horizon Deosoft	High temperature washing. Non biological alkaline based system. Good for whites.	✓

HORIZON DEOSOFT IRIS AUTO DOSING FABRIC CONDITIONER CONCENTRATED AUTO DOSING

Odour neutralising technology. Leaves fabrics feeling soft, fragrant and static-free.

10LTR

HC-3658



HORIZON BRIGHT AUTO DOSING LOW TEMPERATURE DESTAINER AUTO DOSING

Kills C.diff & MRSA in the wash.

10LTR

HC-3654



HORIZON LIGHT AUTO DOSING FULLY BUILT ENZYMATIC DETERGENT AUTO DOSING

Suitable for personal clothing. Biological Low Ph.

BEST SELLER

10LTR

HC-3650





PERSIL PROFESSIONAL NON BIO FABRIC WASH POWDER CONCENTRATED

- Dermatologically tested, does not contain enzymes
- Highly effective stain removal at low to medium temperatures
- Ready to use

160 TABLETS

HC-9046

6.3KG

HC-6763



BEST SELLER



COMFORT PROFESSIONAL ORIGINAL FABRIC CONDITIONER

BEST SELLER

- Effective softening (lubrication) of cloths
- Reduces tangling and static charge
- Delivers a pleasant & long lasting fragrance
- Ready to use per machine

5LTR

HC-6760



UP TO 45 WASHES

COMFORT PROFESSIONAL LAUNDRY SOFTENER AUTO DOSING

- Unique formulation
- Your laundry will smell fresh and remain fresh for longer and will not cling

10LTR

HC-3880



COMFORT PROFESSIONAL ORIGINAL FABRIC CONDITIONER CONCENTRATED

- Effective softening (lubrication) of cloths
- Reduces tangling & static charge
- Delivers a pleasant & long lasting fragrance
- Ready to use per machine

5LTR

HC-3890

10LTR

HC-3100



UP TO 178 WASHES

COMFORT PROFESSIONAL PURE FABRIC CONDITIONER

- Hypo-allergenic softener, effectively softens clothes to take care of delicate skin
- Reduces tangling & static charge
- Pleasant & long lasting fragrance
- Ready to use per machine

5LTR

HC-3891



UP TO 45 WASHES



SUMA NOVA L6 DISHWASHING DETERGENT CONCENTRATED AUTO DOSING

Economical heavy duty alkaline liquid detergent

- Suitable for hard water conditions
- Specially formulated for the fast removal of dried on foods & grease
- Effectively controls lime scale build up, boosting cleaning performance and maintaining the machine

BEST SELLER



5LTR X2

HC-3791-CASE

CASE OF
2

BRYTA DISHWASHING POWDER

- For both domestic & commercial manually dosed machines
- Formulated to remove tannin stains
- Minimises rewashing
- Ready to use



5KG

HC-3928

5 IN 1 BRYTA DISHWASHER TABLETS

Powerful Detergent with water softener and built in rinse aid. Ready to use.



120 PACK

HC-3635

SUMA COMBI+ LA6 5 LITRE & SAFEPAK 2 IN 1 DETERGENT AND RINSE AID AUTO DOSING

Part of the SafePack system

- Combines detergent and rinse-aid for simpler dish and glass washing, with reduced costs



5LTR X2

HC-3925-CASE

10LTR
SAFE PACK

HC-3926

CASE OF
2

SUMA COMBI+ ALU LA10 2 IN 1 DETERGENT AND RINSE AID AUTO DOSING

Aluminium safe. Combines detergent and rinse-aid for simpler dish & glass washing, with reduced costs. Dishwashing completed more quickly, greater consistency, improved productivity and better results

5LTR X2 HC-9119



CASE OF
2

BRYTA RINSE A5 RINSE AID AUTO DOSING

For all water conditions

- Low foam rinse additive for a more efficient operation
- Blend of non-ionic surfactants to give streak and spot free results

5LTR HC-3788



BRYTA RINSE AID AUTO DOSING

- For integral dosed machine
- Aids quick drying
 - Leaves a streak free finish
 - Easy to use

5LTR

HC-3637



DISHWASHER GRANULAR SALT - 10KG

HC-6704



SUN PROFESSIONAL DISHWASHER TABLETS

100 PACK

HC-3806



SUMA LIGHT D1.2 WASHING UP LIQUID

Cuts through grease and dried-on food Economy, yellow-green liquid detergent for cleaning pots, pans, china, glass and all washable utensils. Cuts through grease and dried-on food and makes rinsing easy and streak-free. Citrus scent.
DILUTION RATES:
 1:1000 parts water

BEST SELLER



1LTR
 HC-9000

5LTR
 HC-9024

BRYTA WASHING UP LIQUID

BEST SELLER

- Cuts through grease & dried on food leaving a superior finish
- Streak-free & easy rinsing for sparkling results
- Strong degreasing properties at low dosage to save costs and minimise the impact on the environment



DILUTION RATES:
 1:1600 parts water

1LTR **5LTR**
 HC-6008 HC-6009

GOOD SENSE BREAKDOWN ODOUR ELIMINATOR

- Neutralises bad odour molecules
- Effective on carpet & washroom areas
- Long lasting fresh fragrance

DILUTION RATES:
 Trigger:1:10 water
 Bucket:1:50 water



5LTR
 HC-3713

R7 CREAM CLEANER

- Non-scratching
- Removes stubborn soils and stains
- Suitable for stainless steel, enamel, glazed ceramic tiles, plastic baths
- Ready to use

BEST SELLER



500ML
 HC-3696

SUMA D2.3 SMARTDOSE GENERAL PURPOSE CLEANER

- For hand dishwash, floors and glass cleaning.
- Makes 350 triggers, 60 sinks, or 40 buckets

DILUTION RATES:
 Trigger:
 1:200
 Water
 Bucket:
 1:250 water



1.4LTR
 HC-3740

SUMA D5.2 LIMESCALE REMOVER

- Effective removal of limescale
- Brightens dull metal surfaces by removing oxide film
- Safe in use due to non corrosive formulation

DILUTION RATES:
 Trigger:1:10 water
 Bucket:1:3 water



CASE OF
2

5LTR X2
 HC-3774-CASE

SUMA DRAIN GTS PLUS DRAIN CLEANER CONCENTRATED

- Biological formulation
- Preventive maintenance of drains and grease traps
- Keeps drains free from grease through superior biodegradation of organic waste, eliminating bad odours
- Read to use



10LTR
 HC-3818

SUMA BAC D10 LIQUID DETERGENT SANITISER SUPER CONCENTRATED

For use with Divermite dispensing system.

- Quat based for all surfaces.
- Cleans & disinfects in one step
- Suitable for food prep areas
- Easy and economical to use

DILUTION RATES:

Trigger: 1:25 water

Bucket: 1:100 water



1.5LTR

HC-3810

5LTR X2

HC-3816-CASE

6 EMPTY TRIGGER BOTTLES 750ML

HC-3901

CASE OF
2

OXIVIR EXCEL WIPE

- Heavy duty disinfectant wipes
- Effective against bacteria, viruses and yeast in as little as 30 seconds
- Can be used for descaling and lime limitation
- Comply with EN13727, EN13624, EN14476, EN16615, EN1276 and EN1650
- 100 wipe



HC-9138

ENDBAC SANITISING TABLETS & READY TO USE LIQUID

Chlorine tablets are suitable for food surfaces, salad washing and for use in washrooms.

The liquid detergent sanitiser is ideal for kitchen surfaces.

- Available ready to use or in concentrate
- Cleans and sanitises in one operation
- Effective against bacteria including Listeria, Salmonella, E.coli and Campylobacter
- Economical in use

TUB OF
230

DILUTION RATES:

1 tab / 5L

Tablets

Tub of 230

HC-3819



BEST SELLER

Ready to use
750ml Liquid

HC-3470

SUMA MULTI-CONCENTRATE D2 KITCHEN DETERGENT SUPER CONCENTRATED

For use with Divermite dispensing system.

- For cleaning all washable surfaces
- Fast cleaning, cuts through grease
- Not for use on polished aluminium
- Easy and economical to use

DILUTION RATES:

Trigger:1:150 water

Bucket:1:500 water

1.5LTR

HC-3786



SINGLE USE DISPOSABLE SANITISING WIPES

Non-tainting, odourless formula suitable for sanitising probes and utensils. Effective against a wide range of common food poisoning bacteria. High quality, non-woven material that offers excellent strength and absorbency

TUB OF
200

HC-3961



SUMA GRILL D9 OVEN & GRILL CLEANER

- Powerful cleaning
- Removes heavy carbonised soils
- Not suitable for aluminium
- Foam trigger allows the formulation that clings to vertical surfaces & reduces mist

750ML X6

HC-9034-CASE



CASE OF
6

BRYTA OVEN & GRILL FOAM AEROSOL

For deep cleaning and degreasing inside ovens

- Powerful, exceptional degreasing foam oven cleaner
- Dissolves grease and removes burnt on carbon deposits easily

500ML X6

HC-6012-CASE



CASE OF
6

R1 DAILY TOILET CLEANER

- Removes stains and deposits from toilets
- Regular use hinders limescale build up
- Pleasant, fresh RoomCare fragrance



750ML

HC-3690

R6 PERIODIC TOILET CLEANER

- Powerful heavy duty acidic formulation for periodic use
- Removes scale and stubborn toilet stains
- Fast acting with fresh fragrance

NOTE:
Not suitable for stainless steel toilets



CASE OF
6

750ML X6

HC-3695-CASE

DOMESTOS DISINFECTANT TOILET GEL

Domestos is a cleaning must have, to protect against viruses, bacteria, and fungi.

The zero limescale gel formula is tough on dirt whilst providing a powerful gel shield making toilets visibly and hygienically cleaner for longer.

- Kills 99.9% of bacteria & germs
- Shields between cleans
- Removes 100% of limescale
- Certified and proven formula

750ML

HC-6028

BEST SELLER



DOMESTOS TOILET LIMESCALE REMOVER

- For daily & periodic use
- Heavy duty cleaner
- Longer lasting thick formula
- Quickly dissolves calcium/ limescale deposits

750ML X6

HC-3670-CASE

CASE OF
6



SHIELD LIMESCALE REMOVER

- Restores shine to all washroom surfaces
- With neutrafresh technology to remove unpleasant odours both at source and the surrounding area
- Acid based cleaner for daily cleaning of non enamel surfaces such as toilets, showers, changing rooms and swimming baths

DILUTION RATES:
Daily:1:100 water
Heavy soil:neat

1LTR

HC-6002

READY TO USE
HEAVY DUTY
5LTR X2

HC-6001-CASE

BEST SELLER



SHIELD 3 WAY DAILY TOILET CLEANER AND DESCALER

- Powerful phosphoric acid based cleaner suitable for periodic deep cleaning of toilet bowls and urinals
- Thickened formulation uniformly coats and clings to the surface for easier cleaning
- Safe on chrome and stainless steel with Odour Neutralising Technology

1LTR

HC-6003

BEST SELLER





TITAN CHLOR TABS & CHLOR PLUS CHLORINE BASED SANITISING TABLETS

Chlorine based tablets contain detergent to clean, sanitise and disinfect surfaces and utensils in one step.

- Soluble in warm and cold water
- Certified to EN13704, EN1650, EN1276

TITAN CHLOR TABS

DILUTION RATES:

1 tab / 1L = 500ppm
200 Tablets x 6

CASE OF
6



HC-3859-CASE

TITAN CHLOR PLUS TABS

DILUTION RATES:

1 tab / 1L = 1000ppm
200 Tablets

DOUBLE
STRENGTH



HC-9086

OXIVIR BODY SPILLAGE KIT

A complete kit for effectively dealing with body spillages

- Safe for use on both hard and soft surfaces
- Helps clean spills quickly, safely and effectively

Spill Kit (HC-3715) contains:

- Disposable nitrile gloves
- Disposable face mask
- Disposable plastic scraper
- Disposable bio-hazard bag
- Oxivir Plus 750ml spray bottle
- Absorbent granules
- Disposable paper towels
- Disposable apron
- Disposable foot gloves



READY TO USE

Spill Kit

HC-3715

SPILL KIT REFILL

(All contents excluding trigger bottle)

HC-3712

DI OXIVIR SPORICIDE CLEANER DISINFECTANT

Ready to use cleaner and disinfectant for non-invasive medical devices and nonporous surfaces.

- For disinfecting surfaces, bed pans and commodes
- Effective against *Clostridium difficile* spores

Conforms to:

EN1276, EN1650, EN13727, EN13624, EN13697, EN14476, EN13704, EN14348, EN14347, EN16615.



READY TO USE
750ml

HC-4195

DI OXIVIR EXCEL ONE STEP CLEANER DISINFECTANT

Broad spectrum efficacy and short contact times.

- Effective against bacteria, viruses and yeast in as little as 30 seconds
- Powerful surfactant package delivers excellent cleaning performance including descaling and lime limitation
- Excellent user safety profile reduces worker risk and absence

Efficacy proven by compliance with: EN13727, EN13624, EN14476, EN1276 and EN1650

- Kills MRSA

READY TO USE
750ml Foam

HC-4196

DILUTION RATES:
1:50 WATER
5LTR

HC-4197

**EMPTY REFILLABLE
TRIGGER SPRAY
BOTTLES
500ML X5**

HC-4198



TITAN CHLORINE BASED SANITIZER POWDER

Bactericidal powdered detergent

- Cleans & disinfects in one step
- Suitable for food prep areas
- Easy and economical to use

DILUTION RATES:
1:10 WATER
500G

HC-6748



DI OXIVIR PLUS SMARTDOSE

A concentrated powerful broad spectrum cleaner disinfectant. Automatically diluted through the SmartDose system to give 70 ready to use trigger sprays.

1.4LTR

HC-3716

750ML X6

HC-3710-CASE

**EMPTY REFILLABLE
TRIGGER BOTTLES**

Case of 5 x 500ml

HC-3717





Smartdose bottles offer controlled and consistent dosing

TASKI SANI 4 IN 1 PLUS SMARTDOSE CONCENTRATED

Acidic washroom cleaner, cleans, descales, disinfects and deodorises all acid resistant washroom surfaces

- Highly effective disinfectant passes EN1276, EN13697 and EN1650
- Pleasant ONT fragrance

EMPTY REFILLABLE TRIGGER BOTTLES

Case of 5 x 500ml **1.4LTR**

HC-9031

HC-5200



SPRINT 200 PUR-ECO SMARTDOSE GLASS AND MULTI PURPOSE CLEANER CONCENTRATED

- Dries quickly without streaking
- Versatile application on a large variety of water-resistant hard surfaces

- Makes 280 trigger sprays or 100 buckets

DILUTION RATES:

Trigger:1:100 water
Bucket:1:300 water

1.4LTR

HC-3743



SUMA BAC D10 SMARTDOSE DETERGENT DISINFECTANT

- Makes 140 trigger sprays or 20 buckets

DILUTION RATES:

Trigger:1:25 water
Bucket:1:100 water

1.4LTR X2

HC-3741-CASE



CASE OF
2

TASKI SPRINT 200 NC ALCOHOL-BASED DAILY MULTI PURPOSE CLEANER CONCENTRATED

- PH Neutral
- Dries quickly without streaking

DILUTION RATES:

Trigger:1:50 water
Bucket:1:250 water

1LTR

HC-3721



CIF PRO FORMULA WOOD FURNITURE POLISH - 400ML

- Wood care and protection with a blend of waxes & conditioners
- Removes dust and dirt
- For use on all sealed wooden surfaces

HC-6023



R4 FURNITURE POLISH

- Rapidly dries
- Cleans, shines and protects in one step
- Buffable for a high gloss

750ML X6

HC-3693



CASE OF
6

SUMA D2.3 SMARTDOSE GENERAL PURPOSE CLEANER

- For hand dishwash, floors and glass cleaning
- Makes 350 triggers, 60 sinks, or 40 buckets

DILUTION RATES:

Trigger:1:200 water
Bucket:1:250 water

1.4LTR

HC-3740



BRYTA GLASS & STAINLESS STEEL CLEANER

Ideal for glass food cabinets, stainless steel work tops and hard surfaces

- Perfume free
- Tough cleaning
- Brilliant shine

750ML

HC-6010



SPRINT GLASS CLEANER

- Glass and multi purpose cleaner
- Cleans fast without smearing

750ML

HC-3852



GOOD SENSE 30 DAY AIR FRESHENER

- Good Sense 30 Dispenser
- Dispenses fragrances through air movement
- Requires no batteries or power

REFILL PADS

- Fresh Apple fragrance pad for continuous odour control
- Lasts for 30 days



2 Piece Refill x6 Dispenser

HC-3659

HC-3652

GOOD SENSE DISPENSER & VARIETY PACK

- Automatic Dispenser
- Adjustable dispensing settings
 - Easy wall fixing
 - LED battery change

- 6 CARTRIDGES** for Good Sense Automatic Dispenser
- Contains Odour Neutralising Technology
 - Ultra fine particles for long lasting freshness



Dispenser

HC-3898

TASKI SPRINT FLOWER SD CLEANER AND DEODORISER CONCENTRATED

- Highly perfumed cleaner for all water resistant hard surfaces
- Leaves a pleasant, strong and fresh perfume after cleaning
- Dries quickly without streaking

DILUTION RATES:

Trigger:1:100 water
Bucket:1:33 water

1.4LTR HC-3185



BEST SELLER

GOOD SENSE VERT CONC HIGH FRAGRANCE CLEANER CONCENTRATED

- Fresh apple fragrance
- For daily damp wiping of surfaces

DILUTION RATES:

Trigger:1:50 water
Bucket:1:250 water

1LTR

HC-9017



CIF PRO FORMULA MULTI SURFACE CLEANER

- With anti-static agents
- For dust removal and every day marks
- For computer screens, televisions, hi-fi and modern hard furniture
- 400ml



HC-6022

GOOD SENSE FRESH ODOUR ELIMINATING SPRAY

- Room and fabric freshener with Odour Neutralising Technology
- Safe to use on carpets & upholstery
- Lasting fragrance
- 750ml Trigger Spray

BEST SELLER



HC-3671

GOOD SENSE FRESH

- Does not mask malodors but chemically destroys them to enhance the perception of the chosen fragrance
- Ideal to select the right atmosphere at the right place and at the right moment
- Very economical due to compressed fragrance concentrates



HC-9210



TASKI SPRINT SPITFIRE HEAVY DUTY ALKALINE CLEANER

- Alkaline and solvent based heavy duty cleaner
- Good trouble shooter for persistent stains and graffiti
- Suitable on most types of water resistant surfaces
- 750ml Trigger Spray

BEST SELLER

HC-3857



ENHANCE SPOT & STAIN REMOVER FOR CARPETS

- Unique formula
- One solution for all common water and oil based spots & stains
- Odour Neutralising Technology destroys unpleasant smells leaving a fresh apple fragrance
- 750ml Trigger Spray

BEST SELLER

HC-3685



ENHANCE FOAM SHAMPOO

- 2 in 1 cleans and freshens carpets
- Fresh apple fragrance
- Suitable for both wet and dry foam shampooing
- Woollsafe approved with Odour Neutralising Technology

DILUTION RATES:

1:10 water

5LTR

HC-3845



TASKI JONTEC 300 PUR ECO SD SMARTDOSE NEUTRAL FLOOR CLEANER LOW FOAM CONCENTRATED

- Suitable for all types of water resistant hard floors
- Dries quickly without streaking
- Dosing pump for accurate dosage and cost control
- Makes 70 buckets (10Ltr) or 35 tanks (20Ltr)

DILUTION RATES:

1:500 water

BEST SELLER

1.4LTR

HC-3744



CAREFREE ETERNUM HIGH GLOSS LOW MAINTENANCE FLOOR POLISH

- Blend of 3 polymers to give the best performance and high gloss. Excellent adhesion and hard wearing easy to maintain protective film
- Superior resistance to black heel marking

5LTR

HC-3838



ENHANCE EXTRACTION CLEANER

- For carpets and upholstery
- Fresh apple fragrance
- Low foaming & suitable for use in all carpet machines
- Woollsafe approved with Odour Neutralising Technology

DILUTION RATES:

Bucket: 1:50 water

Machine: 1:100 water

5LTR

HC-3766



TASKI WIPE OUT SPONGE

- Excellent spot cleaning
- Easy to use
- No chemicals needed



Pack of 10

HC-3939

**CIF 2 IN 1 CLEANER
DISINFECTANT**

Kitchen cleaner disinfectant
 • Kills germs
 • Powerful cleaner
 • Fragrance free
 EN 1276 approved

READY TO USE
 750ml Trigger
 Spray

HC-3677



DILUTION RATES:
 1:10000 water

5LTR

HC-3678



**CIF PROFESSIONAL
CREAM CLEANER**

• Tough on stain
 • Contains non scratching
 micro-granules
 • Ready to use

2LTR

HC-3856



**CIF PROFESSIONAL ALL PURPOSE
CLEANER - CONCENTRATED**

• Powerful on grease & grime
 • For all unpolished floors, walls,
 paintwork, ceramics, laminates,
 plastics and all other washable

DILUTION RATES:

Trigger: 1:5000 water
 Bucket: 1:10000 water

- surfaces
- Rinse free
- Lemon fragrance

5LTR HC-3855



**CIF PROFESSIONAL OXYGEL
OCEAN ALL PURPOSE CLEANER
CONCENTRATED**

• Powerful on grease and grime
 • For all unpolished floors, walls,
 paintwork, ceramics, and all
 other washable surfaces

DILUTION RATES:

Trigger: 1:5000 water
 Bucket: 1:10000 water

5LTR

HC-3647



CIF FURNITURE POLISH

- Professional Wood Polish
- Shines and protects
- Removes greasy
 fingerprints, smudges &
 stains from sealed wood
 surfaces, vinyl
 & ceramics
- 750ml Trigger
 Spray

HC-3683



**CIF PROFESSIONAL
BATHROOM 2 IN 1
CLEANER**

- Washroom cleaner and
 descaler
- Sparkling results
- Long lasting fragrance
- Safe on chrome &
 stainless steel
- 750ml Trigger
 Spray

HC-3669



**CIF WINDOW/GLASS
& MULTI SURFACE
CLEANER**

- Streak-free shine
- Removes grime and grease
- For all glass, tables, and
 other sealed surfaces
- 750ml Trigger
 Spray

HC-3681





A FAMILY OWNED BRITISH COMPANY

Astonish have been producing a range of market leading cleaning products for over 40 years. The range is approved by Cruelty Free International and the Vegan Society.



MOULD & MILDEW BLASTER

- UK's No.1 mould remover
- Blasts away tough stains
- Quick and easy to use
- Works in minutes without the need for scrubbing
- Regular use helps prevent return
- 750ml Trigger Spray



750ML

HC-5003

Apple Burst Scent

MULTI PURPOSE CLEANER WITH BLEACH

- Tough on grease, dirt and stains
- Leaves surfaces hygienically clean
- With peony bloom scent



750ML

HC-5004

Peony Bloom Scent

BATHROOM CLEANER

- All over bathroom solution
- Removes soap scum, watermarks and limescale
- Leaves a streak free shine
- With a fresh pine fragrance
- Ideal for use on baths, wash basins, taps, glazed ceramic tiles and shower heads



750ML

HC-5018

Jasmine & Basil

WINDOW & GLASS CLEANER

- Natural cleaning power of vinegar
- Cuts through grease and grime
- Crystal clear streak free shine



750ML

HC-5006

Eucalyptus & Lemon

KITCHEN CLEANER

Our Kitchen Cleaner is that every day helping hand, the hero under the sink. Cutting through grease and kitchen grime with ease, leaving you time to take in the zesty lemon scent.

750ML

HC-5035



Lemon Scent



ANTIBACTERIAL SURFACE CLEANER

Antibacterial Surface Cleanser ensures your surfaces are always hygienically clean.

Kills 99.9% of common germs.

- Effective against e-coli, salmonella & listeria
- No bleach, pH neutral, no dye
- Use on food preparation surfaces, fridges, bins & toilets
- Allow 5 minutes contact time
- 750ml Trigger Spray

HC-5008

5 MINUTE CONTACT TIME



ULTIMATE LIMESCALE REMOVER

Ideal for problem areas in the bathroom or kitchen, including: taps, shower heads and sinks. Suitable for hard water areas and regular use will help prevent the return of any deposits.

750ML

HC-5019



Eucalyptus Scent



OXY ACTIVE PLUS LAUNDRY & STAIN REMOVER - 1.25KG

- Super concentrated
- Powerful stain removing powder
- Removes unpleasant odours
- Brightens whites and colours
- Pre-soak for use directly in the washing machine



HC-5014

ALL IN 1 DISHWASHER TABLETS - LEMON FRESH

- Powerful cleaning action removes tough dried on stains
- Built in salt & rinse aid
- Leaves glassware & cutlery sparkling and streak free
- Fresh lemon scent
- Phosphate free

42 PACK



Lemon Scent

HC-5040

OXY-ACTIVE STAIN REMOVER SPRAY

On hand to swiftly remove stains from fabrics instantly or for treating prior to washing. With added pink blossom fragrance to leave your fabrics smelling fresh.



Blossom Scent

750ML

HC-3482

FABRIC FRESHENER & DEODORISER

Our Fabric Refresher is on hand to bring that just washed freshness back to those hard to wash items like curtains and carpets.



Hibiscus Scent

750ML

HC-5001

PINK ROSE CONCENTRATE DISINFECTANT

Concentrated Disinfectant kills 99.9% of bacteria and enveloped viruses including coronavirus.



Rose Scent

300ML

HC-9127-PNK

LEMON CONCENTRATE DISINFECTANT

Concentrated Disinfectant kills 99.9% of bacteria and enveloped viruses including coronavirus.



Lemon Scent

300ML

HC-9127-LEM

FRESH LINEN CONCENTRATE DISINFECTANT

Concentrated Disinfectant kills 99.9% of bacteria and enveloped viruses including coronavirus.



Linen Fresh Scent

300ML

HC-9127-FLN

Zybox

Exclusively by **BioBax**

Zybox environment-friendly cleaning products, using the most appropriate formulations for the problem.

Containing no harmful chemicals, the Zybox microbiological range use 'friendly' bacteria to break down organic waste efficiently, safely and naturally. Together with a non-biological range, we offer a range of cleaning products, that are completely safe to use, posing no risk to professionals or the general public. Manufactured and developed by BioBax in Skelmanthorpe.



Zybox ultra

CORE FEATURES

4 Active odour eliminators
Perfect for use on all surfaces
Ideal for stubborn odours

PERFECT FOR

Washrooms	Carpets
Walls	Upholstery
Toilets	Soft Furnishings
Urinals	

Zybox advance

CORE FEATURES

Contains AQ Fresh™ Technology
The world's most advanced air freshener
with instant odour elimination

PERFECT FOR

Smelly bins	Rancid food
Urine smells	Pet smells
Tobacco smoke	

ZYBAX ULTRA 750ML DILUTION CONTROL TRIGGER SPRAYER

HC-4112



ZYBAX ADVANCE AIR FRESHENER

Fresh Linen

HC-4215

Mint

HC-4216

Zybox Quick Starter Kits

EACH KIT CONTAINS

4x 1Litre Zybox ULTRA Concentrate
 1x 750ML Zybox AIR Ready To Use
 2x Zybox Trigger Sprayer
 1x Zybox Pump Sprayer
 Plus user guide

FRESH LINEN	KIT	SIZE
HC-4117	Zybox Quick Starter Kits	8 Items
FRESH LINEN	INDIVIDUAL PRODUCTS	SIZE
HC-4098-LINEN	Zybox Ultra Eliminator Ready-to-use	750ml
HC-4111-LINEN	Zybox Ultra Eliminator Concentrate	1Ltr
HC-4099	Zybox Ultra Eliminator Concentrate	5Ltr

FRESH MINT	KIT	SIZE
HC-4113	Zybox Quick Starter Kits	8 Items
FRESH MINT	INDIVIDUAL PRODUCTS	SIZE
HC-4098-MINT	Zybox Ultra Eliminator Ready-to-use	750ml
HC-4111-MINT	Zybox Ultra Eliminator Concentrate	1Ltr
HC-4122	Zybox Ultra Eliminator Concentrate	5Ltr

Zybox Quick Starter Kit - Fresh Linen Fragrance



Zybox Quick Starter Kit - Fresh Mint Fragrance



EASY FRESH AIR FRESHENER

- The unique non-aerosol air freshener!
- Highly fragranced
- The fragrance is in the cover! So no aerosol.
- Continuously releases over the 30 days so you don't have peaks and valleys
- The fan helps blow the fragrance around the room
- Covers up to 16sq metres
- Low VOC (Europe compliant)
- LED reminder when the cover needs changing.
- Light enough to be mounted with tape/screws and fixings supplied
- Comes complete with battery

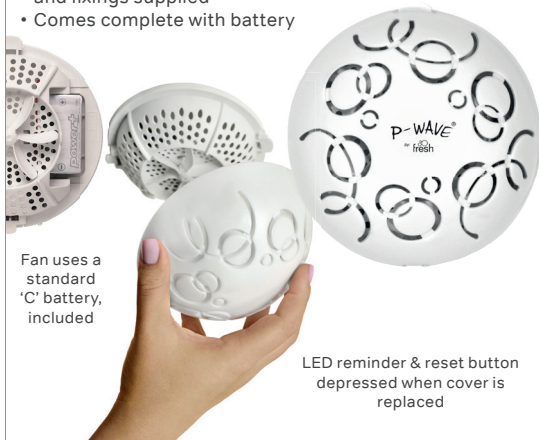

Fan uses a standard 'C' battery, included

LED reminder & reset button depressed when cover is replaced

HA-4206	P-Wave Dispenser
HA-4202	Spiced Apple Refill
HA-4207	Ocean Mist Refill
HA-4209	Honeysuckle Refill
HA-4208	Mango Refill
GA-0865	Duracell Procell Battery - C 1.5v



Airoma® Air freshener

An automatic air freshener dispenser designed to provide facilities with regular small bursts of fragrance.

The air freshener dispenser provides flexible and easy to use programming options.

Airoma® Air Freshener Refills are available in 5 distinct fragrances.

FEATURES

- Fully programmable dispenser. 'Quick' button allows for 30/45/60 days use, 24/7.
- Patented features - automatic reset button & I.P.E.™ - enables a period per day of enhanced fragrance.
- Effective in room sizes up to 200m³.



HA-4211	Aerosol Dispenser	-
HA-4226	Linen	270ml refill
HA-4227	Citrus Mango	270ml refill
HA-4213	Latin Passion	270ml refill
HA-4215	Exotic Garden	270ml refill
HA-4216	Citrus Tingle	270ml refill
GA-0865	Duracell Procell Battery	C 1.5v



ODOUR ELIMINATING GEL

Removes odours caused by, urine, bodily fluids, faeces, vomit, food, mould/mildew, household waste, tobacco, animals & paint, without using caustic chemicals or scented masking agents. The initial smell dissipates after a day or two leaving a smell free environment for approximately 30 days. Gel will evaporate as it works. Replenish as needed.

250g Gel

TE-1000



Wall Bracket for TE-1000

TE-1025



10KG Refill

TE-1017



AIR FRESHENER GEL

150g Gel, Pack of 4

4
PACK

HA-0746



AIR FRESHENER

BEST SELLER

Spring Flowers
300ml Aerosol

HA-0743

Fresh Linen
300ml Aerosol

HA-0741



FURNITURE POLISH NATURAL

With wax, cares and protects.

300ml Aerosol

HC-0766

550ml Aerosol

HC-0778



YELLOW DUSTERS

50 x 45cm

10
PACK

DB-0871



SOCHLOR CHLORINE DISINFECTION TABLETS

- 1.7g NaDCC/Chlorine per tablet
- For isolation, terminal cleaning, daily cleaning and disinfection in high risk areas and during infection outbreaks
- Effective against MRSA, c-difficile, norovirus and many other pathogens
- Fully tested and certified
- Can be used for worktops and other hard surfaces



1.7g Tub of 200

HC-3344

• Not food safe

SOCHLOR CHLORINE FOOD/SURFACE DISINFECTION TABLETS

Used to deliver the correct and exact strength chlorine solutions for disinfection of blood spills and surfaces in high risk areas.



1.7g Tub of 200

HC-3343

GLADE SHAKE & VAC

500g Magnolia & Vanilla



HC-6742

SPRAY BOTTLE FOR SOCHLOR TABLETS

- Diffuser bottle suitable for use with HC-3344 & HC-3301

• 1Ltr



HC-3303

BEST SELLER

500ml Bouquet

HC-9036-B

500ml Bluebell Woods

HC-9036-BW

500ml Linen Fresh

HC-9036-FL



Zoflora

Concentrated Disinfectant
Linen Fresh

99.9% Bacteria & Viruses Killed

odours Eliminated

all day Freshness

500ml
MAKES 20 Litres
of full strength
disinfectant

DISINFECTING LIQUID 5L

- Disinfects according to the EN1276* & EN13697**
- Sterilises in just 15 minutes
- Unperfumed
- Food Safe

LC-3151



FLY KILLER STRONG

- Fast killing action for flies, wasps, mosquitos, midges and other flying insects
- 300ml



HA-0887

DETTOL ANTIBAC SPRAY

- Antibacterial multi purpose cleaner, non bleach, non taint, no odour
- Kills 99.9% of Bacteria & Viruses; E.coli, Salmonella, MRSA Rotavirus, Flu Virus (H1N1)
- 500ml Trigger Spray



HC-0758

COLOUR CODED RANGE - RAISING HYGIENE STANDARDS

Colour-Coding reduces the risk of cross contamination by identifying use in different departments and surface areas. (*Please state colour when ordering)

BLUE	RED	GREEN	YELLOW
GENERAL LOW RISK AREAS	BATHROOMS, SHOWERS & TOILETS	FOOD PREPARATION AREAS	ISOLATION AREAS

CHICOPEE® J-CLOTH® BIODEGRADABLE & COMPOSTABLE GENERAL CLEANING WIPE

50
PACK

- NEW compostable polybag packaging
- The only certified colour-coded compostable cloth
- Lightweight
- Has a unique, open, wavy texture that enables efficient pick-up of any dirt to deliver the most effective green cleaning solution
- Reduce the risk of cross-contamination
- Excellent dirt pick up due to holes
- Ideal for healthcare environments
- Meets environmental standard EN13432
- Environmentally friendly
- FCC approved



43 x 32cm

Please specify colour when placing your order

DB-9021

COLOUR OPTIONS



ALL PURPOSE LIGHTWEIGHT CLOTHS - CENTREFEED ROLL DISPENSER BOX

BEST SELLER

Every day, general purpose cleaning cloth, ideal for light duty tasks

- 500 perforated sheets of All Purpose Lightweight Cloths on a roll for quick and easy access
- Apertured to provide effective food and dirt pick-up
- Good absorbency
- Cleaning Agent Compatible



500
PACK

COLOUR OPTIONS



Please specify colour when placing your order

25 x 25cm

DB-9028



HYGIENE HEAVY DUTY REUSABLE CLOTHS

For tasks that require a superior performing cloth

- Excellent absorption and capacity
- Exceptional food and dirt pick-up
- Machine washable and reusable
- Cleaning agent compatible
- Antibacterial properties inhibit bacterial growth on the cloth

COLOUR OPTIONS



Please specify colour when placing your order

49 x 38cm

DB-9100



25
PACK

SUPER HEAVYWEIGHT CLOTHS

Offers excellent overall performance

- Heavy duty, strong and bulky
- Exceptional food and dirt pick-up
- Great absorption and strength
- Machine washable and reusable
- Cleaning agent compatible

10
PACK



43 x 36cm

DB-9027

DISPOSABLE NON-WOVEN CLOTHS
BEST SELLER
All Purpose Lightweight

- All purpose cleaning solution
- Cleaning agent compatible
- Extremely versatile and provides a good overall performance
- Disposable
- Great food and dirt pick-up
- Good absorbency and bulk
- FCC Approved

**50
PACK**

 Standard
30 x 38cm

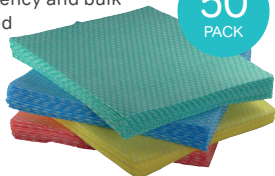
DB-0821

COLOUR OPTIONS

 Please specify colour
when placing your order

 Large
42 x 38cm

DB-9023
STRIPED DISHCLOTH

- A good all-round cleaning cloth

COLOUR OPTIONS

 Please specify colour
when placing your order

40 x 30cm

DB-9022

**10
PACK**
RE-USABLE NON-WOVEN CLOTHS
Heavyweight

- Great food and dirt pick-up
- Machine washable
- Cleaning agent compatible
- Excellent absorption
- Strong, bulky and durable
- Excellent performance
- FCC Approved

COLOUR OPTIONS

 Please specify colour
when placing your order

 Large
49 x 38cm

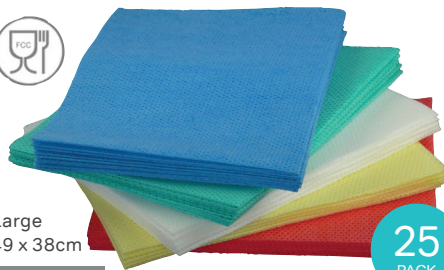
DB-9024

**25
PACK**
**MICROGLASS®
MICROFIBRE
CLOTHS**

- A Glass specific microfibre.
- Smear free glass cleaning
- Alternative to chamois & scrim
- Pale blue only

40 x 40cm

DB-0831

TEA TOWELS

- Cotton rich

 45 x 74cm
Designs
may vary

JB-2005

MICROFIBRE CLEANING CLOTHS
Microfibre

- Durable and strong
- Highly absorbent
- Can be washed and re-used repeatedly
- Use with or without chemicals or water

**5
PACK**

 Standard
40 x 40cm

DB-0830
COLOUR OPTIONS

 Please specify colour
when placing your order

DISH CLOTHS
**10
PACK**

40 x 30cm

DB-0819

DUSTPAN & BRUSH

Choice of Soft or
Stiff Bristles

COLOUR OPTIONS

Please specify colour
when placing your order

Soft

Stiff

HB-3543

HB-3544

**YARD BRUSH**

• Includes handle



HB-0670

SCRUBBING BRUSH

• Plastic



HB-3145

DUSTPAN & BRUSH

• Long Handled
Pan tips upright when lifted
by the handle.

COLOUR OPTIONS

Please specify colour
when placing your order

HB-3545

**DELUXE BROOMHEAD**

Select from Soft or
Stiff Bristles
• Suitable for indoor
and outdoor use

For use with
HB-3078 white handle

Soft

HB-1089

Stiff

HB-6600

**COLOUR OPTIONS**

Please specify colour
when placing your order

DECK SCRUB

• Tough manmade fibres
For use with HB-3078 white handle



HB-3526

DUSTER

• Lambswool
• 61cm handle
colour may vary



HB-6625

BEST SELLER

1



2



3



4

BEST SELLER**TOILET BRUSHES**

HB-0070 ① Closed style

HB-0071 ② Open style

HB-0702 ③ Semi Closed

UA-0796 ④ Enclosed & Holder

HB-0075 Toilet Brush only

WASHING UP BRUSH

HB-3086

WHITE HANDLE

- Heavy gauge

BEST SELLER

Heavy gauge handle screws easily into the following heads



48" Length
(122cm) Each

HB-3078**HYGIENE HANDLES**

- Lightweight alloy

**COLOUR OPTIONS**

Please specify colour when placing your order

49" Length
(125cm) Each

HB-3527

Hygienic handle screws easily into the following heads

MOP / BRUSH HOLDER

- Holds three mops/brushes



48" Length
(122cm) Each

HB-3535**COLOUR OPTIONS**

Please specify colour when placing your order

FRESH

BEST PRACTICE TROLLEY

See page 180 for full details



MICRO SPEEDY KIT

- Rapid response mopping
- Split bucket to segregate clean and dirty water
- Traditional mopping with the power of microfibre
- More hygienic
- Leaves floors dry in minutes
- Minimal training required
- COMPLETE KIT INCLUDED:**
- 20ltr bucket and wringer
- Frame and handle
- Microfibre mop

COLOUR OPTIONS



Please specify colour when placing your order



KIT

HB-2118

REPLACEMENTS FOR HB-2118

MICROFIBRE PAD



Each

HB-3061

PAD ATTACHMENT

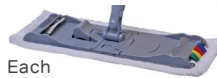

Each

HB-2101-GRY

20LTR MOP BUCKET & WRINGER

COLOUR OPTIONS



Please specify colour when placing your order

Each

HB-2117

MOP BUCKET & WHITE WRINGER

- Strong wringer with reinforced clips
- 10 Litre lightweight bucket



Each

HB-3457

COLOUR OPTIONS



Please specify colour when placing your order

BUFFALO BUCKET & WRINGER

- Strong wringer
- 25 Litre capacity bucket
- 75mm castors



Each

HB-2119

COLOUR OPTIONS



Please specify colour when placing your order

PROFESSIONAL MOP BUCKET

- Large wringer
- 15 litre capacity

BEST SELLER



Each

HB-3456

COLOUR OPTIONS



Please specify colour when placing your order

10LTR PLASTIC BUCKET



Each

HB-0772

COLOUR OPTIONS



Please specify colour when placing your order

CAUTION SIGN

BEST SELLER



Each

HB-1087

WASHABLE SOCKET MOPS

BEST SELLER

- Fully looped with a stay flat band
- 50/50 mix of cotton & synthetic
- 200gm
- Washable up to 60°c

For use with HB-3527 hygiene handle



Each

HB-3528

COLOUR OPTIONS



Please specify colour when placing your order

KENTUCKY MOP HEAD HYGIEMIX

- 450g



DB-0846	Red
DB-0844	Blue
DB-0845	Green
DB-0847	Yellow

DISPOSABLE MOPS

Ideal for areas where infection control is a must

- Practically lint free
- Spun lace material
- Leaves no yarn behind on rough surfaces
- Very cost effective

For use with HB-3527 hygiene handle

COLOUR OPTIONS



Please specify colour when placing your order

10
PACK



HB-3529

KENTUCKY MOP

- Stay flat
- Looped ends

For use with HB-3527 hygiene handle



Each

HB-2120

MAXI MOP

- Extremely absorbent non-woven synthetic fabric
- White

For use with HB-3078 white handle



Each

HB-3060

KENTUCKY MOP FITTING

For use with HB-3527 hygiene handle

COLOUR OPTIONS



Please specify colour when placing your order

Each

HB-2121



FLOOR SQUEEGEE

- 45cm

Each

HB-0810



COLOUR OPTIONS



Please specify colour when placing your order

SOCKET MOP

• Thick absorbent yarn
For use with HB-3527 hygiene handle

COLOUR OPTIONS



Please specify colour when placing your order

Each

HB-0774



SUPERMOP AG REFILLS

BEST SELLER

Fast & effective cleaning - Ideal for spot mopping, spill pick up or intensive cleaning of small to medium floor areas, washrooms etc. Improved Hygiene - contains silver (Ag ions) anti-bacterial technology. Independent tests* show it inhibits 99.99% of bacteria growth within the mop.

*Leitat Technological Center, Spain.

- Zig Zag edges provide excellent absorbency and 30% better dirt pick up
- Excellent dirt release unlike cotton mops which trap dirt
- Colour-coded to prevent cross contamination
- Very high resistance to detergents and bleaches, durable and ergonomic
- Low friction, lightweight non-woven material
- Long lasting, will not shed fibres or unravel
- Easy to wring, releasing water efficiently
- Leaves floors drier and back in use faster
- Machine washable at 60°C up to 95°C

COLOUR OPTIONS



Please specify colour when placing your order



Each

HB-0960

SUPERMOP HANDLE

Aluminium handle with easy click connector

- Long Top grip (18,5 cm): ergonomic shape with rounded end, good grip
- Light weight
- To be used with Supermop
- The 4 colour system offers simple identification of different application areas

Handle with coloured connector included.

COLOUR OPTIONS



Please specify colour when placing your order



Each

HB-0962

SUPERMOP BUCKET & WRINGER

Oval design in a pale blue finish

- Colour coded funnels to help prevent cross contamination
- Easy pour spout to dispose of waste water
- Hand grip in the base for easy lifting and pouring
- 10 litre capacity with fill level
- Robust metal handle with ergonomic grip
- Easy to wring, less force required than conventional socket mops
- Strong, lightweight bucket is highly portable and easy to store



COLOUR OPTIONS



Each

HB-0961

Please specify colour when placing your order

PVA MICRO (MICROFIBRE CLOTH)

Easy glide, streak free wiping, high absorbency microfibre cloth

- No window cleaning chemicals required
- Can be washed 400 times

COLOUR OPTIONS



Please specify colour when placing your order

Each

HB-0963



5
PACK

GAUNTLETS

Black only



DC-0217 Medium

DC-0216 Large

FINGERGRIP SCOURER

Large shaped pad with a handgrip to allow optimum comfort.



HC-8123

10
PACK**STAINLESS STEEL SCOURER**

- Large heavy duty
- Will not rust, perfect for removing baked on food.

HC-1078

BEST SELLER**SOAP FILLED PADS**

Offer great efficiency for tough cleaning tasks.



HC-1079

10
PACK**PUMP DISPENSER**

- For 5Ltr containers



HC-1080

DOMESTIC GLOVES

Medium weight gloves with a cotton liner.

COLOUR OPTIONS

Please specify colour when placing your order



DC-0212 Small

DC-0213 Medium

DC-1103 Large

DC-1104 X Large (Blue)

SPONGE / SCOURER

Large pad. Good quality and highly absorbent sponge.



HC-8120

10
PACK**ZINCOTE SCOURER**

- Large scourer for tough jobs



HC-8122

8
PACK**CATERING SCOURER**

Good quality sponge scourer ideal for washing dishes and pans.



DB-0828

10
PACK**GALVANISED SCOURER**

- Removes stubborn burnt on food stuffs

DO NOT use on non stick or delicate surfaces.



HC-8121

10
PACK**SPONGE ERASER**

- Removes stubborn stains from nearly all surfaces
- No need for chemicals
- Use with water for cleaning
- Use dry for dusting



HC-8124

10
PACK**CATERING SCOURER**

Heavy duty



HC-8129

10
PACK**WASHING UP BOWL**

- 8 Litre capacity
- 32w x 15h x 32d cm
- COLOUR MAY VARY



AC-0943

DISPOSABLE SAFETY GLASSES

AA-3711

GOGGLES

AA-3700

POLYESTER LAUNDRY BAGS

BEST SELLER

Traditional style with lockable drawstring and toggle for use on 1,2,3 and 4 bag laundry carts (skips) as featured on page 246.



EC-3150	Red
EC-1147	Blue
EC-3152	Green
EC-3006	Yellow
EC-1149	White

SAFETEX MOP BAG

- Designed for the collection of dirty mop heads
- Fully washable at 95 degrees C
- Re-useable (up to 1000 uses)



White Each

DA-0846

FLUID PROOF BAGS



DA-0880-RE	Red
DA-0880-BL	Blue
DA-0880-GR	Green

RE-USABLE LAUNDRY BAGS

Safetex re-usable, self opening laundry bag designed for the collection of heavily soiled & infected linen. Safetex opens in the wash process once it is safely inside the washing machine. Safetex bags are environmentally friendly and a cost effective alternative to single use disposable red bags.



300
USES
GUARANTEED

DA-0845-RE	Red	For infected linen
DA-0845-BL	Blue	For delicate items
DA-0845-GR	Green	For delicate items that cannot withstand a boil wash

WHITE NET BAGS

Small

- 30 x 40cm
- Zipped
- Write on label

Large

- 60 x 84cm
- Drawstring
- Write on label

Polyester bags can be tumble dried on a low heat.

EC-3149	Small
EC-3151	Large



FULLY SOLUBLE LAUNDRY BAGS**BEST SELLER**

- Hot water soluble
- Easier to open
- Interleaved - no perforation
- Pink tie now at bag neck
- The most cost effective way to handle contaminated linen and help meet duty of care guidelines
- Minimum 65°C for at least 5 minutes



Code	Colour	Size	Pack Size
DA-0841	Clear	660 x 840mm	25
DA-0840	Red	660 x 840mm	25
DA-0839	Clear	711 x 990mm	25 on roll
DA-0838	Red	711 x 990mm	25 on roll

SOLUBLE SEAM LAUNDRY BAGS**GREAT VALUE**

This bag is ideal for nursing and residential homes, and is suitable for hot and cold temperature washes up to 40°C and above.

- Soluble membrane dissolves in initial wash
- Overlapped slit to prevent damp linen puncturing the bag
- Pink tie tape for secure closing of the bag
- Suitable for low temperature washes, ideal for care facilities
- Helps meet duty of care guidelines for nursing and residential homes

200
PACK



Code	Colour	Size	Pack Size
DA-0842	Red	450 x 700 x 750mm	200



**Countrywide
Healthcare**
PrimaCare™

BEST SELLER**SOLU-SEAM LITE LAUNDRY BAGS WITH DISSOLVABLE SEAM**

Quality product at an unbeatable price!

- Ideal for nursing and residential homes
- Suitable for hot and cold temperature washes up to 40°C and above
 - Water soluble tie tape & seam
 - Helps meet the duty of care guidelines for nursing & residential homes



soluble tape

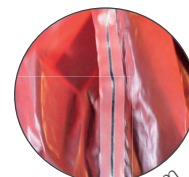

soluble seam

GREAT VALUE

Code	Colour	Size	Pack Size
DA-0815	Red	450 x 620 x 670mm	200
DA-0818	Green	450 x 700 x 750mm	200

B I N L I N E R S

We stock a large range of bin liners for all kinds of waste disposal, from recycling to clinical waste.

PEDAL BIN LINERS - WHITE

Code	Type	Size mm d x w x h	Pack Size
DA-0847	Standard	270 x 430 x 450	100
DA-0882	Heavy Duty	279 x 430 x 457	1000
DA-0855	Super Heavy Duty	280 x 425 x 425	500
DA-0899	Scented Drawstring	15L	30

SWING BIN LINERS - WHITE

Code	Type	Size mm d x w x h	Pack Size
DA-0831	Standard	300 x 500 x 700	100
DA-0844	Heavy Duty	325 x 575 x 750	50
DA-0834	Super Heavy Duty	300 x 550 x 700	100
DA-0881	Heavy Duty	330 x 584 x 762	1000
DA-0896	Drawstring	30L	12

INCO TIE HANDLE LINERS - POLYTHENE

Code	Type	Size mm d x w x h	Pack Size
DA-3056	Standard	180 x 300 x 320	300
DA-3058	Large	275 x 415 x 515	300

GENERAL WASTE LINER

Code	Type	Size mm d x w x h	Pack Size
DA-0833-BOX	Standard - Black	375 x 600 x 600	500
DA-0826	Heavy Duty	380 x 600 x 600	1000

DUSTBIN SACKS

Code	Type	Size mm d x w x h	Pack Size
DA-0832	Standard - Black	450 x 720 x 950	50
DA-0829	Heavy Duty - Black	457 x 737 x 965	200
DA-0830	Super Heavy Duty - Black	457 x 723 x 965	200
DA-3263	Standard - Red	457 x 724 x 965	200
DA-3264	Standard - Green	457 x 724 x 965	200
DA-0835	Standard - Clear	457 x 724 x 965	200
DA-0823	Premium - Clear	457 x 724 x 965	200
DA-0843	Heavy Duty - Clear	457 x 813 x 965	100

CLINICAL WASTE SACKS

Code	Type	Size mm d x w x h	Pack Size
DA-3588	Standard - Yellow	457 x 711 x 990	50
DA-0852	Yellow with Black Stripe	457 x 724 x 864	200

COMPACTOR SACK - BLACK

Code	Type	Size mm d x w x h	Pack Size
DA-0836	Heavy Duty	559 x 850 x 1168	100

HOUSEKEEPING EQUIPMENT

STORAGE & CLEANING

Helping to keep spaces clean and tidy, our range of refuse bins and storage options are ideal. Mopping systems and floor machines are also available.

- Bins & Refuse
- Storage Trolleys
- Mopping Systems
- Floor Cleaning Machines
- Laundry & Bathroom



STEP ON CONTAINERS - FREESTANDING - FIRE RESISTANT

BEST SELLER

WON'T RUST, DENT, CHIP OR PEEL

Ideal for hands free, food service refuse disposal

- Tight fitting, overlapping lid helps contain odours
- Rounded corners and smooth contours for easy cleaning and disinfecting
- Tough, puncture resistant, all plastic construction won't rust, dent, chip or peel
- Quiet, heavy-duty pedal for hands free use



Please specify colour when placing your order

CODE	SIZE		COLOUR OPTIONS
EB-6934	30Ltr	41 x 40 x 43.5cm	
EB-6935	45Ltr	41 x 40 x 60cm	
EB-6939	70Ltr	50 x 41 x 67.5cm	
EB-6940	87Ltr	50 x 41 x 82.5cm	

25LTR & 50LTR RECYCLING BINS WITH LIDS

- Choice of 4 lid colours for various recycling uses
- Available in two sizes
- Graphite main colour

COLOUR OPTIONS



Please specify colour when placing your order



50Ltr

HB-0709

25Ltr

HB-0708

PLASTIC 15L PEDAL BIN

- Manufactured from polypropylene
- Light but durable construction
- Pedal operated
- Dimensions:
370 x 290 x 260

COLOUR OPTIONS



Please specify colour when placing your order

NEW BEST SELLER



HB-0768

AN IDEAL CHOICE FOR USE WITHIN THE CARE HOME ENVIRONMENT.

MADE FROM 100% PLASTIC AND FIRE RETARDANT

20L Key Features:

- Fully plastic fire retardant, rust free construction
- Soft closing, pedal operated lid with sack retention system
- Choice of coloured lids for different waste streams
- Non marking base and lid and no sharp edges

42L & 70L Key Features:

All the features of the 20L plus...

- Removable body to ease emptying and cleaning
- Interchangeable lids to highlight different waste streams
- Bottom castors for easy manoeuvrability



Description	20Ltr	42Ltr	70Ltr
Removeable body and quick release lid	✘	✓	✓
Fixed Body	✓	✘	✘
Lid mechanism separate from lid to prevent accidental damage	✘	✓	✓
Rust Free fully plastic construction	✓	✓	✓
Enclosed mechanism with smooth edges to ease cleaning including smooth foot pedal	✘	✓	✓
Fire Retardant	✓	✓	✓
7 Interchangeable silent close coloured lids	✓	✓	✓
Small footprint	✓	✓	✓
Small footprint with rubber feet to prevent movement	✘	✓	✓
Wheels for transportation	✘	✓	✓
Sack retention system which holds lid open to ease emptying	✓	✓	✓
Non Marking lid and base	✓	✓	✓

**FIRE RETARDANT PLASTIC PEDAL BINS
AVAILABLE IN 20L, 42L & 70L**

**BAGS & SACKS
SEE PAGE 235**



SIZE
20Ltr

SIZE
42Ltr

SIZE
70Ltr

Lids are available in 7 colour options:



Yellow, Orange, Black, White, Green, Tiger and Red.
Please state lid colour at time of placing your order.

DIMENSIONS:

20L: 60CM H 22CM W 35CM D
42L: 58CM H 46CM W 42CM D
70L: 79CM H 46CM W 42CM D

EB-3295	20L Fully Plastic FR Pedal Bin
EB-3296	42L Fully Plastic FR Pedal Bin
EB-3297	70L Fully Plastic FR Pedal Bin
EB-3298	Replacement Lid (42L & 70L)

PEDAL BIN - METAL - FIRE RETARDANT

- Rear mounted handle and wheels for ease of mobility
- Removable body to assist cleaning
- Hands free pedal operated
- Drip tray to collect spills
- Main body in grey only
- Colour coded lid options available below

Bristol Maid™
Hospital Metalcraft™ Limited 

LID COLOUR OPTIONS

Please state colour when ordering

	User defined		Domestic
	User defined		Infected
	User defined		Waste for incineration
	User defined		

SIZE
20LtrSIZE
50LtrFRONT
OPENING
DOOR
75Ltr

EB-3263	20Ltr	265w x 320d x 555h mm
EB-3264	50Ltr	435w x 430d x 555h mm
EB-3265	75Ltr	435w x 430d x 785h mm

SELF ASSEMBLY SACK HOLDER

Pedal operated for ease of use

- Self-Assembled open type refuse sack holder
- Flat packed easy self-assembly
- Dimensions:
H810 x W430 x D440mm
- White

**EB-3268-WH****BEST SELLER****PRE ASSEMBLED SACK HOLDER**

Pedal operated for ease of use

- Pre-assembled open type refuse sack holder
- Coloured lid option
- Dimensions: H810 x W430 x D440mm

COLOUR OPTIONS

Please specify colour when placing your order

**EB-3268****FREESTANDING REFUSE SACK HOLDER**

- Pedal operated
- Elasticated cord to secure bag
- Rear mounted wheels

Please state lid colour options above when ordering

COLOUR OPTIONS

Please specify colour when placing your order



50Ltr

EB-326075Ltr
(No White Lid Option)**EB-3261**

50LTR SWING BINS

- Ideal if you require colour coded bins
- Wipe clean plastic
- Large 50Ltr capacity
- 41d x 33w x 60h cm

**COLOUR OPTIONS****HB-0686**

Please specify colour when placing your order

**10LTR ROLL TOP BIN**

Handy 10Ltr roll top bin. Ideal in guest rooms, small kitchen & bedroom areas.

- 21d x 20w x 42h cm
- Silver

**HB-0699****50LTR PEDAL BINS**

- Large 50Ltr capacity
- 33d x 41w x 62.5h cm
- Choice of 3 colours. Linen, Black and Metallic

*Please state colour when ordering

**HB-0600****50LTR LIFT-UP LID BIN**

- Tall plastic bin with lift-up lid for easy waste disposal
- Slot in lid to clamp in bin liner
- 38d x 34w x 59h cm
- Foot plate for easy liner removal

**HB-0698-LIN****BEST SELLER****WASTE BIN**

- Small White Plastic
- 30cm dia

**EB-0892****BEST SELLER****MESH WASTE BIN**

- Silver Mesh
- 25dia x 28h cm

**EB-0893****FIRE RETARDANT WASTE BIN**

- Large Grey
- 30dia x 28h cm

**EB-0890****ROBUST DUSTBIN WITH LID**

- Generous 80L Polythene dustbin with secure lid
- 54 x 50 x 70cm

**HB-0778**

12LTR & 20LTR PLASTIC WASTE PEDAL BIN



Yellow pedal bin includes a clinical waste sticker.

HB-0796-WH	12Ltr White
HB-0796-YE	12Ltr Yellow
HB-0797-WH	20Ltr White
HB-0797-YE	20Ltr Yellow

4LTR PEDAL / VANITY BIN

- White
- Complete with separate liner
- Hard wearing and wipe clean
- Will not dent or rust
- 26h x 19w x 23.5d cm



HB-0602

30L STAINLESS STEEL PEDAL BIN

- Fitted with internal plastic liner



HB-0739

5LTR & 12LTR STAINLESS STEEL PEDAL BIN



5Ltr

HB-0779

12Ltr

HB-0770

30LTR STAINLESS STEEL SOFT CLOSE BIN

- Stainless Steel
- 36.4dia x 60.2h cm
- Soft, quiet close mechanism
- Inner ring conceals bin liner out of sight



HB-0705



CART + 12 TRAYS

Just as quick and efficient as the Karri Cart but a more compact size. Trays included. 97h x 124w x 46d cm

Trolley without handle

Trolley with handle

EB-6770**EB-6770-WITHHANDLE****EB-6770**
12 TRAY**REPLACEMENT TRAYS**

For use with Karri Cart and Combi Cart

EB-6507	Red
EB-6505	Blue
EB-6506	Green
EB-6508	Yellow

**BEST SELLER****KARRI CART WITH TRAYS**

- Ideal for distribution of personal clothing
- Lightweight compact and slimline - space saving
- Colour coded trays makes identification easy
- Improves manual handling techniques
- Mobile stacking units replace untidy shelves & baskets
- Rust proof, robust, powder coated steel construction, improves laundry hygiene & appearance
- Sturdy hanging rail
- MRSA resistant
- Trays included
- Additional trays available

**EB-6772**
16 TRAY**EB-6773**
24 TRAY**EB-6774**
28 TRAY

Code	Trays	Columns	Rows	Height	Width	Depth
EB-6772	16	2	8	167cm	89cm	46cm
EB-6773	24	3	8	167cm	124cm	46cm
EB-6774	28	4	7	148cm	155cm	46cm

CHANGING TROLLEY

- MRSA resistant coated steel
- Designed for efficient bed changing
- Three removable trays with a dividing panel that separates clean and soiled linen.
- Holds a single laundry bag and comes with a lid to help prevent any cross contamination between the clean and soiled linen
- *Laundry bags sold separately See page 238

102 x 108 x 47cm

EC-1120**FOLDING LINEN TROLLEY**

- With strong yellow PVC sack
- Base frame of the trolley helps support the bottom of the sack
- Swivel rubber castors 7.5cm
- Strong plastic frame
- Load capacity 70Kg
- 71d x 66w x 95h cm

**EC-1134**

Trolley

EC-1133-YE

Spare Bag

SOILED LINEN TROLLEY

- Practical & inexpensive
- Robust frame
- Free running castors
- Bags sold separately see page 238

SINGLE FRAME
48.5cm
(Bag ring Dia)
x 91.5cm**EC-1125**

STAINLESS STEEL MEDI-CARTS

Colour coded for categorising and segregating linen

- Built to last of no-rust stainless steel
- Snug fitting lids to help with the containment of odours
- Top quality, non-marking wheels
- Two wheels with stability brakes
- Will hold a variety of bag sizes
- Supplied flat pack

*Bags sold separately

LAUNDRY BAGS

VIEW OUR FULL RANGE ON PAGE 235



Code	Frames	CM	Lid Colours*
EC-6775	1	38 x 93 x 49	
EC-6776	2	66 x 93 x 49	
EC-6777	3	100 x 93 x 49	
EC-6778	4	135 x 93 x 49	

FIXXON LABELLING SYSTEM

DESIGNED TO SIMPLIFY THE IDENTIFICATION OF RESIDENTS CLOTHING.

Starter kit contents:

- 1 x gun
- 1 x attacher tool
- 1 x remover tool
- 1 x spare needle
- 1000 x fasteners



EB-0100	1	Fixxon Starter Kit	
EB-0101	2	Fixxon Buttons with Room Numbers	Pack of 24
EB-0102	3	Fixxon Spare Needles	Pack of 5
EB-0103	4	Fixxon Fasteners	Pack of 1,000
EB-0104	5	Fixxon Storage Cabinet (40 rooms)	

STORAGE BOXES & LIDS

STACKABLE BOXES

HIGH QUALITY, WITH SECURE CLIP ON LIDS



EB-6510	10Ltr	17h x 24.5w x 36.5d cm
EB-6511	32Ltr	18h x 40w x 60d cm
EB-6512	45Ltr	25h x 40w x 60d cm
EB-6513	80Ltr	42h x 40w x 60d cm

42LTR FLEXI TUB

Black

* Colour may vary



EB-6514

UTILITY TROLLEY

This aesthetically pleasing shelf trolley is manufactured from hard wearing plastic, each with a rim to help prevent items sliding off.

Large Black Polypropylene Trolley
Size: 960(H) x 520(W) x 1070(D)mm
Capacity: 200kg
Weight 16kg
Colour Black

Easy-Clean Polypropylene Shelves
Maximum Weight Capacity: 200kg
Tray Size: 60.5(H)x 900(W)x 498(D)mm
Highly durable design
Supplied with 2 braked and 2 plain castors
Flat packed for easy assembly

EB-2164

Large Black Max Load 90kg
103 x 49.5 x 95cm

**EB-2160**

Small Grey Max Load 60kg
90 x 41 x 80cm

STAINLESS STEEL TROLLEY

- 71h x 82.5w x 40.5d cm
- 3 Tier

**EB-2251****4.5LTR WASTE FOOD COLLECTION CADDY**

Generous 4.5 litre capacity that will contain any leftovers before you transfer them to your outdoor bin.

- Hinged lid
- 19h x 25w x 18d cm

**AA-0945****CUTLERY TROLLEY**

- Includes 3 grey cutlery containers
- 72.5 x 52.5 x 100cm
- Freestanding or mobile

Colour may change

**EC-3240** Trolley**AA-3377** Spare Tray - Black**CLEANERS CADDY**

- Lightweight durable plastic
- 3 compartments for segregation
- Keeps cleaning tools tidy and easy to carry



Colour may vary
from image shown

HB-6601

BEST PRACTICE TROLLEY



Find out more on page 180

RAPID RESPONSE CLEANING TROLLEY

A compact, lightweight multipurpose trolley, comes complete with 25ltr mop bucket & wringer.

- Ideal for emergency spillages
- Twin trays to hold cleaning materials
- Rear plastic sack holder
- 75mm castors
- 104h x 41.5w x 60d cm



EB-3256

34LTR DOUBLE BUCKET MOPPING SYSTEM

Designed for cleaning medium to large areas.

- Two colour coded 17 litre buckets
- Complete with basket for carrying additional cleaning products
- Supplied with a clip to fix mop in transit
- Good quality gear press

Each Mop System Contains:

- Sturdy frame with handle & mop clip
- Castor wheels for easy movement
- Open ended mop wringer with handle
- Removable carry basket
- 2x 17Ltr blue & red buckets

Ideal for use with

- Kentucky Mop Head Hygiemix
- Kentucky Mop
- Kentucky Mop Fitting



EB-3302

JANITOR TROLLEY

Ideal for maintenance and waste handling

- Smooth construction, cleans easily
- Storage for a variety of handled tools & equipment
- Front platform holds mop, bucket and wringer combination for floor cleaning tasks or disinfection
- Includes durable vinyl bag for easy refuse removal
- Requires assembly
- Additional lockable box (sold separately)
- 98h x 49w x 113d cm
- Available in blue only



EB-3254-LID Trolley with Lid

EB-3254-LOCK * Lockable Box

EB-3255-BAG * Blue Sack

BEST SELLER

CLEANING TROLLEY

Smooth, easy to clean surface and swivel wheels for easier movement. Storage compartment tray built into top shelf of trolley for easy access to cleaning equipment or tools.

- Includes removable yellow vinyl bag
- 97.5h x 55.2w x 116.8d cm

Trolley

CA-2261

Locking Cabinet

CA-2262



ROTARIES | ORBIS

The Orbis machine offers exceptional handling and productivity for cleaning and polishing hard floors.

ORBIS 400 17" OB45400

- Single disc rotary machine
- Comes with drive disc
- 400rpm ideal for polishing and spray cleaning
- Other sizes and speeds available upon request

HB-7201

POLYPROPYLENE SCRUBBING BRUSH FOR HB-7201

HB-7214

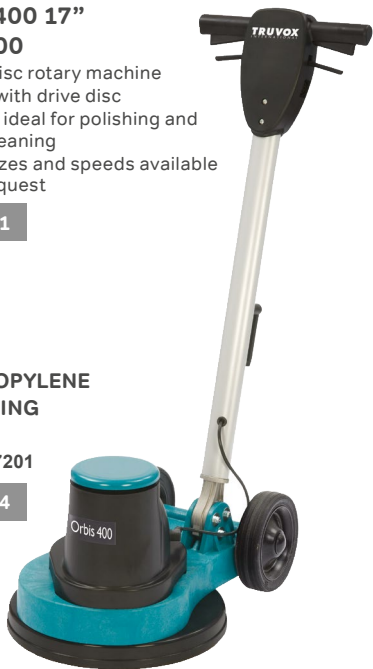

INJECTION EXTRACTION HYDROMIST RANGE

Cleaning deep into the carpet these machines are ideal for care homes.

HYDROMIST COMPACT HC250

Compact Spray Extraction Machine

- Comes with upholstery tool kit
- 250mm cleaning width
- 14L solution tank
- Powerful vacuum, pump and brush motors

BEST SELLER

HB-7205



HYDROMIST LITE HML

Light and Compact Spray Extraction Machine

- Carpet Extractor
- Ideal for upholstery
- 1100W vacuum motor
- Comes with tools

HB-7203

TRUVOX[™]
INTERNATIONAL
A TACONY COMPANY

VACUUMS | TUB

VTVe A Energy Rating Tub Vacuum with Hepa 13 Filter.

GREAT VALUE

VTVE TUB VACUUM

- 3-stage filtration, including HEPA 13 filter, that provides a high filtration of all particles of 0.3 microns and larger
- Weighing only 6kg the VTVe is light and manoeuvrable ideal for transporting between cleaning jobs
- Cable storage wrap to prevent tangling
- 11.5 litre capacity for high productivity and inclusive of HEPA 13 fleece bag
- Quick and easy to replace cord replacement system
- Storage of the crevice tool and brush tool at the rear of the machine for easy accessibility during use

HB-7227

*No further discounts apply

DUST BAGS

- Pack of 12
- For HB-7227

HB-7135



VALET AQUA 20

VA20HD

Heavy duty Vacuum

- 20L Wet & Dry Vacuum
- Compact size
- Supplied with a full set of tools

HB-7202



accessory storage

VACUUMS

VALET BATTERY UPRIGHT

This battery powered upright vacuum is light weight and powerful.

**BATTERY OPERATED 50+
MINUTES OF RUNTIME**

VBUII

The Valet Battery Upright is the first commercial battery upright vacuum on the UK market.

Ideal for daytime cleaning in nursing homes, offices and education facilities where power is not easily accessible or the use of corded machines poses a risk.

- Lithium ion battery that provides 50 + minutes of runtime
- Weighing only 5kg makes it ideal for transporting between cleaning jobs
- Ideal for day-time cleaning and where electricity points are not easily accessible
- Battery level indicator lets you know when the machine needs re-charging
- Quick change battery system enabling longer run times with a second battery

HB-7231

DUST BAGS

- Pack of 10
- For HB-7231

HB-7236

SPARE BATTERY

- For HB-7231

HB-7276



Battery status indicator



Quick change removable battery



BEST SELLER

TRUVOXTM
INTERNATIONAL
A FACONY COMPANY



SCRUBBER DRYERS MULTIWASH PRO

Simple to operate, adaptable and produces consistently good cleaning results, regardless of operator, floor type or application environment.

The new re-designed Multiwash PRO scrubber dryers will wash, scrub and dry in just one single pass. Giving improved cleaning results, your floors will be left clean and dry ready for your residents and staff to walk on.

MULTIWASH SCRUBBER DRYER Multiwash PRO 340

- Increased brush diameter and improved motor gives 12% more scrubbing power
- Versatile, quiet and easy to use
- Wash, mop, scrub and dry in a single pass
- Highly effective on "difficult" flooring
- 4L solution tank with spray pump
- Dimensions 39 x 45 x 111cm
- Cable length 12 metres

HB-7206

SIDE BRUSH ACCESSORY

- For HB-7206

HB-7216



Trolley for ease
of transportation

Accessible and
removable tank

Rotating brushes
scrub & lift dirt

Larger brush for
enhanced scrub





VACUUMS | TASKI ENSIGN EVO

Professional and ultra efficient mains powered upright vacuum cleaners.

TASKI ENSIGN EVO 300, 350 AND 450

Wet and Dry Upright Vacuum Cleaners

- Highly efficient
- Compliant to EU Directives
- Designed to be ultra reliable with versatility and convenience

TASKI ENSIGN EVO 300

- 30cm operating width

HC-4140

TASKI ENSIGN EVO 350

- 36cm operating width

BEST SELLER

HC-4141

TASKI ENSIGN EVO 400

- 46cm operating width

HC-4142



VACUUM BAGS

- For Taski Ensign Evo & SM1 and SM2 Range
- Pack of 10

HC-3895

CARPET EXTRACTION | TASKI

Deep cleaning through spray extraction is the ultimate way of thoroughly cleaning your carpets. It increases the lifetime of your carpets by removing ingrained dirt whilst maintaining the high appearance levels of your carpet.

TASKI AQUAMAT 10

Compact 10 litre Carpet Extraction Cleaning Machine

- Manoeuvrable and convenient
- Easy to transport
- Increases the lifetime of your carpets by removing ingrained soilage

Machine only

HC-3896

EXTRACTION HOSE TOOL KIT

Toolkit for HC-3896

HC-3896-A



TASKI PROCARPET 30

Medium 30 litre carpet extraction and encapsulation cleaning machine

- High Performance - dual extraction & encapsulation application
- Flexible application - can be set-up for deep cleaning or revitalising

HC-3752



HC-3753 Extraction Brush

HC-3754 Encapsulation Brush

HC-3755 Draining Hose





TASKI SWINGO 150

Ultra Compact Cylindrical Scrubber Drier

- High mechanical scrubbing action and a pressure ten times higher compared to manual cleaning
- Simple and ergonomic operation
- Easy cleaning of confined areas

HC-3978



TASKI SWINGO 350E

Compact Electric 15" 10 Litre Cylindrical Scrubber Drier

- Cleans and dries more effectively compared to manual cleaning
- Simple and ergonomic operation
- Accessible to confined areas
- Perfect drying results, slip-falls caused by wet floors is reduced to the minimum

HC-3986



SCRUBBER DRIER | TASKI SWINGO

Simple and ergonomic operation.

TASKI SWINGO 455E

Small electric 17" (430mm) scrubber drier

- Truly versatile for use in all types of small or congested hard floor areas
- Intuitive controls and yellow maintenance points, operator training and maintenance time is reduced to a minimum
- Very robust and durable
- Great working width and increased tank volume
- The use of high-tech material and long life components enhance the machine's uptime, while reducing service and repair costs to a minimum

TASKI SWINGO 455

HC-4230

ACCESSORIES FOR HC-4230

Scrubbing Brush
430mm

HC-4232

Pad Drive Harpoon
Grip 430mm

HC-4231

ACCESSORIES FOR ALL SWINGO MODELS CYLINDRICAL BRUSH

Standard
380mm

HC-3983





TASKI AERO 8

TASKI The TASKI AERO 8 high-efficiency vacuum cleaner uses state-of-the-art technology and has a super-efficient motor. With the patented TASKI whisper technology, the vacuum cleaner works ultra-silently. What's more, replacement of parts such as cables and filters is simplified by clever design and can be carried out by the user in seconds without the need for any tools.

- 8ltr capacity
- Compact and robust TASKI design
- Sustainable high-efficiency concept
- Ultra-silent TASKI whisper technology
- Designed and tested according to operational best practice



TASKI AERO 8

HC-4241

VACUUM BAGS

Pack of 10

HC-4241-BAGS

TASKI ERGODISC DUO

Single Disc Machine

- Two speed options
- Perfect for all applications
- Extremely versatile
- A pad drive is required for this machine - available in 2 speeds. Sold separately.
- Floor Maintenance Pads available in Blue, Black, Brown, Green, Red, Tan and White.

Please state colour when ordering.



HC-3897	TASKI Ergodisc Duo Machine only
HC-3915	Pad Drive 17" High Speed
HC-3916	Pad Drive 17" Standard Speed
HB-7010	Floor Maintenance Pad 11" - Pack of 5
HB-7011	Floor Maintenance Pad 14" - Pack of 5
HB-7012	Floor Maintenance Pad 15" - Pack of 5
HB-7013	Floor Maintenance Pad 16" - Pack of 5
HB-7014	Floor Maintenance Pad 17" - Pack of 5

NUMATIC HENRY HOOVER - RED

- Professional toolkit and protective bumper for wall and door protection
- 620W Motor
- Four wheels for stability
- Super long-reach 12.5m cable
- TriTex® Filtration system
- Easily switch between carpets & hard-floors
- HepaFlo Bags with self-seal tab



HC-6861

TASKI TAPI DEO AIR FRESH

Perfume granules for vacuum bag. Leaves a long lasting fragrance.



40
PACK

HC-9085

BEST SELLER

NVM-1CH DUSTBAGS

Vacuum Bags to fit Numatic Henry



10
PACK

HB-6890

FOLDING STEP STOOL

- Handy and practical
- Folds away neatly when not in use, saving space
- 22d x 29w x 22h cm
- Weight 1.1Kg

SUPER STRONG
MAXIMUM 150KG LOAD



EB-6551

STEP-UP METALLIC GREY

- Strong moulded construction.
- Stackable.
- Anti-slip feet.
- 24 x 32.5 x 40cm



EB-6594

KICK STEP

- Quality durable steel for max safety
- Quick assembly, retractable castors
- Kick-Step will not slide, roll or tip over
- GS Approved
- Loaded height: 430mm
- Uploaded height: 435mm
- Top: 290mm dia
- Base: 435mm dia
- Grey only
- Weight 5Kg



EB-6593

GREY FOLDING TROLLEY

- Folding handle for storage
- 2 fixed, 2 swivel 10cm rubber tyred castors
- Constructed from injection moulded, lightweight & hygienic plastic
- Platform size: 60d x 38.5w x 15h cm
- Handle height 82cm
- Load capacity 120kg
- Weight 6Kg



EB-6596

FOLDING STEPS

- Non slip feet
- Soft grip handle which is comfortable when using as a seat
- Tread size 380 x 260mm
- Certified to EN-14183 standard

2 STEPS

- Weight: 4kg
- Height of top step: 48cm
- Dimensions when erected: 45w x 82h x 52d cm
- Dimensions when folded: 45w x 106.5h x 9d cm

EB-6597

3 STEPS

- Weight: 6kg
- Height of top step: 72.5cm
- Dimensions when erected: 46w x 118h x 67d cm
- Dimensions when folded: 46w x 131h x 9d cm

EB-6598



BEST SELLER

5 SHELF STORAGE RACK

- Multi-use; cupboards, utility rooms etc
- Easily assembled in minutes
- Can be used 'free standing' or fittings included to enable fastening to walls
- Large shelves 71.4cm x 38cm
- Each shelf holds up to 30Kg
- Total unit holds up to 150Kg
- 5 shelf storage
- 170h x 71.4w x 38d cm

2 YEAR GUARANTEE

EB-6530



TORCH

- Active rubber torch
- 3 LED bulbs
- 10 metre beam
- Requires 2 x AA Batteries



GB-0873

HEAD TORCH

- 8 white LEDs
- Push switch
- Adjustable brightness
- Adjustable headstrap
- Requires 3x AAA batteries



UC-0226

UV LIGHT & TORCH

- A portable ultra violet lamp
- Built-in torch
- Handy carry strap
- Requires 4 x AA batteries (not supplied)



LC-6250

ASH COLLECTING BIN

Designed to make collecting cigarette ash easier and safer.

- Ideal for open spaces
- 12.5d x 23w x 30h cm



EC-3528

MELAMINE ASHTRAY

- Stackable
- Black
- 10cm



HB-6602

EAZYZAP COMMERCIAL FLY KILLER INSECT CONTROL UNIT (100M²)

- 320(H) x 498(W) x 86(D) mm
- Power Type 230V. 38W. 0.17A.
- Single phase
- Voltage 230V
- Weight 2.36kg
- Warranty RBD 1 Year
- 2 x 15W UV tubes
- Free-standing or ceiling mounting
- Ideal for use at front or back of house
- 100m² coverage



Removable catchment tray



HB-6532

HIGH PERFORMANCE PROCELL BATTERIES

BEST SELLER

Manufactured to rigid specifications to meet some of the highest standards of durability and longevity.

*Brand may vary.



GA-0868	AAA	1.5v	MN2400
GA-0866	AA	1.5v	MN1500
GA-0865	C	1.5v	MN1400
GA-0864	D	1.5v	MN1300
GA-0867	9v	9v	MN1604

DE-ICING SALT

25kg bag

- Fast acting salt
- Gritty residue provides extra grip
- Ideal for areas of high footfall, leaving no dirty residue after dissolving
- Colour may vary



JA-1102

1 MOBILE GARMENT RAIL

Robust black clothes rail,
complete with castors.
160h x 48d x 122w cm

EC-3526

2 PLASTIC COAT HANGER

Black
Each

EC-3358

3 IRONING BOARD

Design may vary

EC-3562

4 STEAM IRON

EB-8043

5 ROUND LINEN HAMPER

Generous 58Ltr capacity with lid.
58h x 48d x 48w cm

EC-3561

6 LAUNDRY BASKET

With recess on one side,
making it easier to carry.
30.5h x 59d x 39w cm

EC-3556

7 IRONING BOARD COVER

Metalised
Size approx 102 x 43cm

EC-3565

8 WATERPROOF LAUNDRY PEN

EC-3148



SHOWER CURTAIN

180 x 180cm
With 12 hooks

Colours may vary,
cream or white



HB-0795

SUCTION SAFETY MATS

Suction backed to stay firmly in place. Available in 2 sizes suitable for baths and showers.



JB-2091	Bath Mat	57 x 37cm
JB-3076	Shower Mat	52 x 52cm

**BIOMASTER ANTIBACTERIAL PULL CORDS**

The Biomaster Clean PullCord alleviates germ build-up with its non PVC polymer coating and superior Biomaster Antimicrobial Technology.

Biomaster slowly releases silver ions on demand and has been formulated to last the active lifetime of the product.

It can be wiped over, will never discolour through use and will be the last PullCord you will ever need to buy.

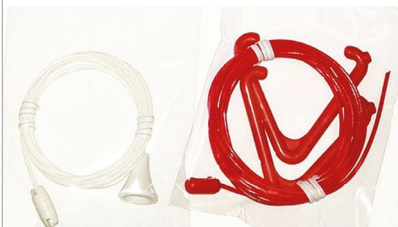

EB-2020	Clean White PullCord	1.5m
EB-2021	Clean White PullCord with Acorn Connector	3m
EB-2022	Clean White PullCord with 2 Handles	3m

CHROME FINISH BATHROOM ACCESSORIES**SOAP DISH**

57 x 120 x 105mm



HB-0786

TOILET ROLL HOLDER

100 x 165 x 60mm



HB-0788

TOWEL RING

180 x 160 x 60mm



HB-0789

TOWEL RAIL

57 x 520 x 80mm



HB-0787

NOTE: Products are designed for domestic use only and may vary to those illustrated, subject to availability.

B E D D I N G & L I N E N

PROTECTION & COMFORT

Beautiful range of quality bedding and towels available in an array of colours to complement your decor.

- Waterproof Bedding
- Bedding Covers
- Duvets & Pillows
- Flame Retardant Options
- Sleepknits
- Towels



DRITECH

100
TM

**BEDDING
PROTECTION
PRODUCTS**

DRITECH '100' BEDDING PROTECTION

- 100% waterproof
- Soft & comfortable to lay on
- Flame Retardant
- A firm fit to avoid rucking
- Easy to clean
- Non-slip
- Non-hardening
- Latex and Vinyl free

Specially Developed for:
**Nursing Homes
& Hospitals**

PROTECTS FROM:



Dust Mites



Stains



Fluids



Allergens



Bacteria



JA-0957	Pillow protectors	Pack of 2	66 x 48cm
JA-2095	Duvet cover	Single	137 x 198cm
JA-2167	Duvet cover	Double	200 x 200cm
JA-0996	Mattress cover	Single	190 x 91 x 15cm
JA-0963	Mattress cover	Double	190 x 137 x 15cm



SATIN STRIPED SINGLE DUVET SET

Experience a restful nights sleep.

The design, quality and value of our polycotton bed linen makes it an ideal offer for nursing homes.

Using only the finest ring spun carded and combed quality yarns, you can experience a restful nights sleep.

BEST SELLER

GREAT VALUE SATIN STRIPE SET

JA-3771	Duvet Cover
JA-3772-PAIR	Pillowcase - Pair

MRSA RESISTANT BEDDING COVERS

These mattress protectors are quiet, soft and breathable. The combination of four way stretch fabric and Smart Sheet design ensures that these protectors will fit a wide range of healthcare mattresses.

- Flame Retardant to European Standard EN ISO 12952

MRSA
RESISTANT

FIRE
RETARDANT

Simply
WIPE
CLEAN

WASH AT
95°

TUMBLE
DRY

JA-4042-SGL	Single Mattress Protector
JA-4044	Pillow Protector



WATERPROOF TERRY MATTRESS PROTECTOR & PILLOW PROTECTOR



JA-3300-SGL	Single
JA-3300-4FT	4ft (3/4)
JA-3300-DBL	Double
JA-3300-KNG	King
JA-0967	Pillow Protector

QUILTED WATERPROOF MATTRESS PROTECTOR

Unparalleled mattress protection...Comfortable, yet waterproof as well! A PVC backed, quilted top gives complete protection to the mattress in combination with exceptional comfort

- Machine washable 40°C
- Fitted sheet style

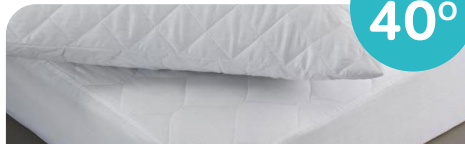

WASH AT
40°

JA-3362	Single
JA-3364	4ft (3/4)
JA-3363	Double

ESSENTIAL PILLOW

BEST SELLER



JA-3302

REGULAR PILLOW

BEST SELLER

Poly/cotton cover



JA-0998

WASHABLE QUILTED PILLOW



JA-3622

FR CUSHION

FR Proban Cover
40 x 40cm



JA-3277

WIPE CLEAN BATWING SUPPORT PILLOW



JA-4040

POLYCOTTON V-SHAPED PILLOW



JA-4050 Polycotton V-Shaped Pillow

JA-3279 FR Proban Cover



SINGLE DUVET

- 10.5 Tog
- Fibre filled with poly/cotton cover

JA-1170

ESSENTIAL DUVET

- 10.5 Tog
- Polypropylene Cover
- Hollow fibre filling

JA-3301

ANTI-BACTERIAL PILLOW & DUVET

Filled with anti-bacterial, anti-allergy fibres that actively protect against bacteria and dust-mites

- 10.5 Tog



JA-3335 Anti-Bacterial Pillow

JA-3336 Anti-Bacterial Duvet

FR PILLOWS & DUVETS

- 10.5 Tog
- 100% Cotton
- Hollow fibre filling
- Non-allergenic
- FR Proban cover to BS EN 12952



JA-3278 FR Pillow

JA-2120 FR Single Duvet

JA-2121 FR Double Duvet

NON ALLERGENIC

FR WIPE CLEAN PILLOWS & DUVETS - FLUID PROOF

- 10.5 Tog
- Wipe down with warm soapy water
- Polypropylene outer and a flame retardant polyester filling
- Outer cover conforms to Source 5



JA-2126 FR Pillow

JA-2125 FR Single Duvet

JA-2124 FR Double Duvet

FLUID PROOF

FR WIPE CLEAN PILLOWS & DUVETS - MRSA RESISTANT

- 10.5 tog
- Simple, wipe down cleaning
- Flame retardant to BS 7175 Source 5
- Comfortable, hygienic & economical
- Fluid proof, breathable pillows & duvets
- Impermeable cover & resilient polyester inner fill



JA-0951 Pillow

JA-3086 Single Duvet

MRSA RESISTANT

FR TRUBLISS QUILTED PILLOWS & DUVETS - WASHABLE TO 95°C

- 10.5 tog • 100% Cotton • Wash up to 95°C
- Quilted outer section enhances comfort and durability
- Special 'cluster' fibre-fill ensures that the pillow does not go hard and lumpy when washed
- Exceeds thermal disinfection guidelines
- Flame retardant to BS EN 12952



JA-3380 FR Pillow

JA-3381 FR Single Duvet

JA-3382 FR Double Duvet

WASH AT 95°C

COLOUR OPTIONS

PLEASE SPECIFY COLOUR WHEN
PLACING YOUR ORDER

PASTEL

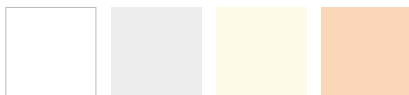

White Pale Grey Cream Peach



Pale Blue Pink Green Lemon

DEEP



Wine Jade Navy

POLYESTER & COTTON BED LINEN

COMFORT, DESIGN, QUALITY AND VALUE...

Ideal for contract use in sectors including Nursing Homes, Hospitality, Healthcare, and many more. Designed and specified to stand the test of time in demanding contract environments. Manufactured using only the finest yarns and tested to the highest standards.

- Easycare 50% polyester 50% cotton
- Wash to 60°C
- Duvet covers have an envelope end for ease of laundering



SINGLE Bedding	
JA-3761	Pillowcase - Pack of 2
JA-3762	Fitted Sheet
JA-3763	Flat Sheet
JA-3768	Duvet cover

Cream only	DOUBLE Bedding
JA-4058	Fitted sheet
JA-4060	Flat sheet
JA-4063	Base valance 37cm
JA-4062	Duvet cover

Double Bedding only available in Cream

FLAME RETARDANT BED LINEN

SOFT FLAME RETARDANT FABRIC...

- 100% Polyester • 100% inherently flame retardant to BS 7175 Source 7
- Wash to 71°C thermal disinfection
- Fitted sheets have covered elastic at each corner
- Duvets have an envelope end for ease of laundering
- All FR bedding comes individually labelled
- Flat sheets hemmed on all four sides

COLOUR OPTIONS

PLEASE SPECIFY COLOUR WHEN PLACING YOUR ORDER

PASTEL

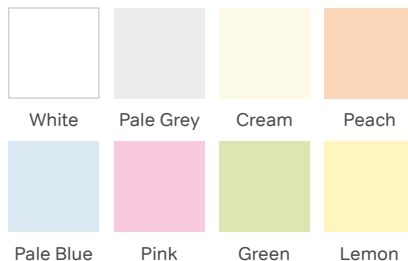

White Pale Grey Cream Peach
Pale Blue Pink Green Lemon

DEEP



Wine Jade Navy



	SINGLE Bedding
JA-3611	Pillowcase - Pack of 2
JA-3616	V Shape Pillowcase*
JA-3610	Fitted Sheet
JA-3609	Flat Sheet
JA-3612	Duvet Cover

* V Shape Pillowcase only available in White and Cream

SINGLE FR CELLULAR BLANKET 180 X 230CM

Its cell like construction combines insulation with breathability, making it an ideal choice for residential care homes and emergency services.

- High performance cellular blanket
- Can be washed at 71 degrees for thermal disinfection
- Fully fire retardant blankets
- 100% Polyester flame resistant fibres
- Conforms to British Standards BS 5866: Part 4 1991 (2008)
- Compliant to BS7175 Source 5 and Source 7



JA-3359-WH



SLEEPKNIT FR POLYESTER KNITTED BEDDING

Speciality knitted fabric for performance, comfort and reliability, innovative construction allows four way stretch, which conforms to the patient's movements and minimises skin shear and friction.

- Can be used on pressure reducing mattresses with no reduction in performance
- Does not crease or ruck therefore minimises the chance of pressure sores
- Wash to 71°C thermal disinfection
- Requires only one person to make the bed
- Patented design of bottom sheet features special underwrap ensuring exceptional mattress coverage
- Unique top sheet incorporates unique toe pleat to ensure excellent patient comfort
- Double bedding available on request

BLANKET

- Knitted cellular construction ensures clients are always warm
- Snag resistant and unique construction minimises pilling

JA-3800	PILLOWCASE - EACH White, Cream, Blue, Green, Peach, Yellow
JA-3801	FITTED SHEET White, Cream, Blue, Green, Peach, Yellow, Pink
JA-3802	SEMI-FITTED TOP SHEET Cream, Blue
JA-3805	DUVET COVER White, Cream
JA-3614	BLANKET White, Cream, Blue, Green, Yellow

POLYCOTTON SMART SHEETS (NOT FR)

- Knitted sheet with multi-directional stretch
- Polyester/cotton mix fits most healthcare mattresses

JA-3803	SINGLE SMART SHEET White, Cream
---------	------------------------------------



COLOUR OPTIONS

PLEASE SPECIFY

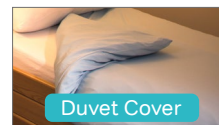
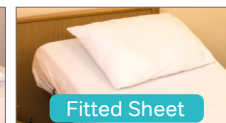
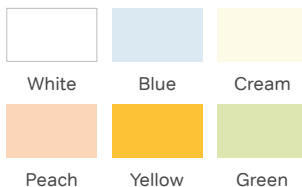

LUXURY 500G TOWELS

STEADFAST COLOURS,
100% COTTON,
NATURALLY ABSORBENT

- Manufactured for heavy contract use
- Plain header bar to denote size
- 100% cotton
- Hems reinforced at corners
- Extremely durable 71°C wash
- Low loop to resist snagging

* All towel sizes below
Face: 30cm x 30cm
Hand: 50cm x 90cm
Bath: 71cm x 137cm
Sheet: 100cm x 150cm

AFFORDABLE LUXURY TRUSTED TO LAST

DEEP COLOURS - LUXURY 500G TOWELS

JB-3509	Face Cloth
JB-3510	Hand Towel
JB-3511	Bath Towel
JB-3512	Bath Sheet

PASTEL COLOURS - LUXURY 500G TOWELS

JB-3509	Face Cloth
JB-3510	Hand Towel
JB-3511	Bath Towel
JB-3512	Bath Sheet



Wine



Terracotta



Chocolate

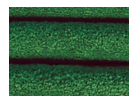

Forest Green

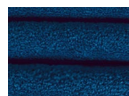

Navy



Plum



Peach



Light Grey

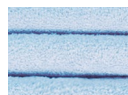

Pale Blue



White

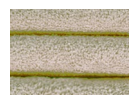

Mushroom

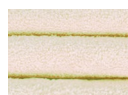

Cream

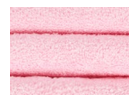

Pink

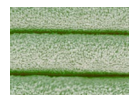

Green



Lemon

WHITE TOWELS

PRIME QUALITY COMMERCIAL TOWELS OF THE VERY BEST RING SPUN YARNS

These 100% carded cotton towels are highly absorbent, durable and soft. With double stitched hems to protect the longevity of the towel to ensure best quality. The more these towels are washed the softer and more luxuriant they become.

Identified by:

- 1 Bar for face cloth and hand towel
- 2 Bars for bath towels
- 3 Bars for bath sheets



JB-2008	Face Cloth	30 x 30cm
JB-2009	Hand Towel	50 x 90cm
JB-2010	Bath Towel	71 x 137cm

Essential Choice Towel Set

GREAT VALUE TOWEL SET HAND & BATH BUNDLE

Code	Description	Colour
JA-3307-BL	Hand & Bath Towel Bundle	Blue
JA-3307-CR	Hand & Bath Towel Bundle	Cream

IDEAL FOR EVERY DAY USE

Our towels are 100% cotton, naturally absorbent and can be washed up to 40°C. Available in three pastel colour options blue, cream and mint which will easily match any bathroom colour scheme.

Key features...

- 100% cotton
- Naturally absorbent
- Plain header bar to denote size
- Hems re-enforced at corners
- Low loop to resist snagging
- Wash up to 40°C
- Simply select your colour choice...

HAND TOWEL

A key bathroom essential, and due to its size is perfect for drying hands and hair. Dimensions: 88 x 50cm

BATH TOWEL

There's nothing nicer than wrapping yourself in a 100% cotton fresh bath towel after bathing. Ideal for both body and hair. Dimensions: 135 x 70cm

Code	Description	Colour
JA-3304-BL	Hand Towel	Blue
JA-3305-BL	Bath Towel	Blue
JA-3304-CR	Hand Towel	Cream
JA-3305-CR	Bath Towel	Cream
JA-3304-MI	Hand Towel	Mint



B E D S & P R E S S U R E R E L I E F

PROVIDING COMFORT

We offer a wide selection of supportive mattresses, cushions and dynamic profiling beds to help provide everyday comfort.

- Structured Bed Supports
- Overbed Tables
- Profiling Beds
- Static & Dynamic Mattresses
- Pressure Cushions & Supports



SIDE RAIL PADS : PAIR**FOR WOODEN SIDE RAILS**

- High sided side rail pads to be used with a height extender*
- Wipe clean F.R. cover
- MRSA resistant

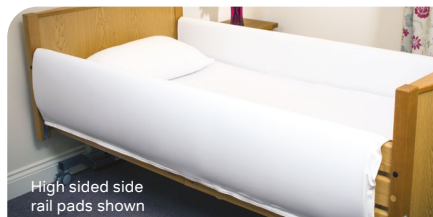

EB-3026	Standard Height	195 x 78cm
EB-3027	High Sided*	195 x 86cm

SIDE RAIL PADS WITH MESH PANEL : PAIR**FOR WOODEN SIDE RAILS**

- Top and bottom pads are connected by a strong see through net which concertinas to save space when side rails are down
- Wipe clean F.R. cover
- MRSA resistant
- Zip fastening
- 87 x 200cm

**EB-3025****ANTI-ROLL SIDE WEDGES****WITH BREATHABLE CONNECTING SHEET**

- Patients can be positioned and prevented from accidentally rolling off the bed
- Wedges are attached to the draw sheet using hook & loop fastenings
- Sheet is held in position by straps with adjustable buckles
- MRSA resistant wipe clean F.R. cover
- 20 x 90cm

**EB-3037****FOLDABLE FALL OUT MAT**

- FR wipe clean breathable cover
- MRSA resistant
- High density foam
- 60 x 190 x 7cm

**EB-3019****PADS FOR TELESCOPIC SIDE RAILS : PAIR**

- 137 x 72cm

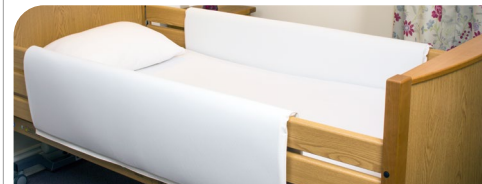
**EB-3033****BED FOAM SPACER**

Fits neatly on profiling beds to prevent damage to walls and electrical sockets. 45mm deep.

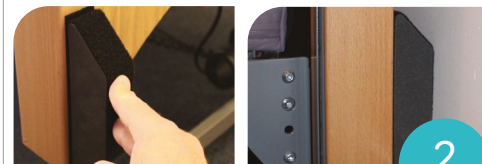
**BA-6485****BED CRADLE**

- 41w 46h x 76d cm

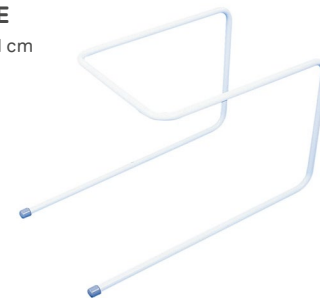
**EB-1140**

COLOUR COORDINATED OVERBED TABLE

AVAILABLE IN 4 WOOD FINISHES

- Metal frame base
- Tilting top size:
60w x 40d cm
- Height adjustable:
62 - 94cm
- Raised upstands

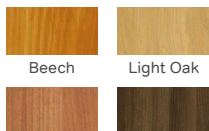

French Walnut Dark Walnut
Please specify finish when ordering



BA-1146

SPLIT LEVEL OVERBED TABLE

- Features a small side table
- A raised edge on each side prevents items falling
- Adjustable height and tilting top
- Easy wipe clean surfaces



BA-1151

EASI-RISER OVERBED TABLE

WHEELCHAIR BASE

- Height adjustable handle
- Anti-trapping safety feature
- FR light oak laminated top
- Height adjustable:
72 - 110cm
- 4 swivel castors
- Raised upstand
- Top size:
93w x 40d cm



BA-1134

OVER BED TABLE

OUR LOWEST PRICE
OVER BED TABLE

- Suitable for profiling and deep base divan beds
- Economical overbed table
- Use in bedroom or lounge
- Height adjustable
53-82cm
- Tilting top with lipped edge
- Warm red oak colour top

BEST SELLER



BA-1150

OVERBED LIGHT OAK TABLES

- Light oak laminated top
- Metal frame base with tilting top
- Height adjustable 62-94cm
- Raised upstands
- Top size: 60w x 40d cm



BA-3382 Split Leg

BA-1132 Split Leg with Castors

OVERBED TABLE, SPLIT LEG 4 CASTORS - WARM RED OAK

- Height and angle of both tables can be easily adjusted
- Tabletop angle can be adjusted up to 45 degrees
- Easy to dismantle for ease of storage and transportation
- Easy wipe clean surfaces



BA-1153

NAUTILUS CONTRACT DIVAN BED

NAUTILUS FABRIC WATER RESISTANT COVER

Revolutionary Soft & Comfortable

- Antibacterial and antifungal
- Breathable and vapour permeable
- Forms an effective barrier against bed mites
- High quality re-enforced springs
- Framed edge
- Flame retardant crib 5 BS7177
- 6 fixed legs

**SINGLE &
4FT OPTION**

Single divan bed



**FLAME
RETARDANT**



4ft divan bed

BA-1118	Single Base	3ft x 6ft 2in x 1ft 2in
BA-1117	Single Mattress	3ft x 6ft 2in x 7in
BA-1114	4Ft Base	4ft x 6ft x 1ft 3in
BA-1115	4Ft Mattress	4ft x 6ft x 7in

ASHMOUNT SINGLE CONTRACT DIVAN BED

PVC WATER RESISTANT COVER

Manufactured with natural fibres for durability & comfort.

- High quality open coiled springs
- Framed edge
- Flame retardant crib 5 BS7177
- Single Base
3ft x 6ft 2in x 1ft 2in
- Single Mattress
3ft x 6ft 2in x 7in



BEST SELLER

**FLAME
RETARDANT**

BA-1124	Single Base
BA-1122	Single Mattress

CADIZ HEADBOARD

- For single beds
- Easy wipe clean
- Available in Light Oak or Beech
- 51.5 x 91.5cm

Please state wood finish when placing your order



Light Oak



Beech

UA-5275-BCH	Beech
UA-5275-LO	Light Oak

GRANBY HEADBOARD

- Padded and covered in a FR anti bacterial water resistant fabric
- Colour: Libra Gold
- Single



BA-1140

XTREME MATTRESS

- Full foam divan depth mattress designed for use with our Xtreme bed
- Enclosed in a vapour permeable cover fire retardant to Crib 5 BS7177
- Welded to 3 sides and stitched to the 4th side
- 190 x 91 x 19cm

ED-4012



FLAME
RETARDANT

AMYTHEST BARIATRIC BED

- 120cm wide platform
- 310kg max. user weight
- 195 x 96 x 50cm

BA-8214-WAL



SECLUSION BLANKET & CUSHION

A specialist contract quality blanket & cushion for use in custodial locations such as Prisons, Hospitals and Police Stations. Specifically designed in consultation with prison, police & psychiatric bodies to prevent the incidence of self-harm/suicide. Specifically address the sleeping arrangements for segregated & vulnerable high-risk individuals. The blanket provides warmth and comfort and is designed to minimise the risk of self-harm.

Washing Instructions

- Machine cool max wash
- No tumble drying
- Cool iron - one spot
- Temperature 40°C
- No bleach

FLAME RETARDANT
Conforms with British
Standard BS5815,
Part 3, 1991



FLAME
RETARDANT

JA-2130	Blanket	122 x 196cm
JA-2131	Cushion	50 x 42cm



ULTRA
LOW
POSITION

LUNA

ULTRA-LOW FLOOR BED

The Luna is a unique ultra-low bed for pioneering user safety and care. It has all the features of the and comes with the added benefit of its range going down to just 9cm from the ground, and auto regression backrest. This facilitates the most specific and complex care requirements, while also reducing impact if the user rolls out of the bed.

It has a 3 year warranty on the bed frame and 2 years on the motors and electrics. The bed can be dismantled for storage or transporting and is available in Oak and Walnut wood finish.

- Available in oak and walnut
- 3 year warranty on bed frame
- 2 year warranty on motors and electrics
- 10 function lockable handset
- Trendelenburg and reverse Trendelenburg tilting feature
- Auto regression backrest
- Knee brake adjustment
- Click stop lower leg raising elevation
- Electrically adjustable backrest
- Four robust braking 3" castors
- Four-section mattress support with mattress grips
- Extra high side rails available
- 20cm bed length extension kit available
- Tool-free assembling and dismantling
- Transport system for storage and transporting

Technical Specification:

- Maximum Safe Working Load: 200kg
- Height Adjustment: 9 - 70cm
- Outer Dimensions: 102 x 213cm

WALNUT

BA-6711-WALNUT

OAK

BA-6711-OAK

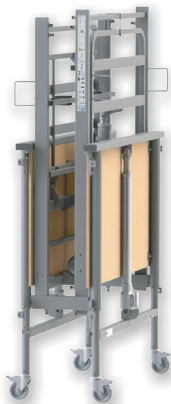

- Intuitive multi-function handset with lock-out facility for patient safety
- Dual motor headrest and knee brake adjustment
- Electric backrest, leg rest, knee brake & lower leg elevation
- Emergency lowering by quick action bolt mechanism
- Four section mattress support
- Quick release pins on all actuator points
- Tool free assembly and dismantling
- Compliant to: EN 60601-1-11*, EN 60601-1 and EN 60601-2-52
- Mattress Platform 200 x 90cm
- Full Frame 214 x 102.5cm



OPTIONAL
WOODEN
RAILS

PISCES PROFILING BED

With an attractive and non-clinical finish, this bed is beautifully finished with enclosed motors. Available in standard height which enables carers to care for users without bending and causing back injuries, or low bed ensuring a safe resting and sleeping environment for those at risk of falling out of bed. Available in three wood finishes to compliment room décor.

MAX WEIGHT 165KG

BED WITH INTEGRAL SIDE RAILS



38.6mm
Minimum height from floor
to mattress platform

BA-6652-BCH

BA-6652-OAK

BA-6652-W

LOW BED WITH INTEGRAL SIDE RAILS



19.2mm
Minimum height from floor
to mattress platform

BA-6653-BCH

BA-6653-OAK

BA-6653-W

SELECT PROFILING BED



Add bed end facias to transform the PrimaCare™ Select Bed into a stylish bed for a homely feel!



SELECT II PROFILING BED

shown with side rails (included) and without bed end facias (sold separately)

BA-6478

SELECT LOW PROFILING BED

shown without side rails or bed end facias (each sold separately)

BA-6673

CODE	Additional Options
BA-6479	Bed End Facias (pair) for Select II & Low Beds
BA-6672	Side Rails (set) for Select Low Bed only
BA-6481	15cm Bed Extension without Side Rails
BA-6482	Full Length Extended Wooden Side Rails
BA-6480	15cm Bed Extension & Side Rails

A unique feature of this bed enables the flexibility of the mattress platform to be mounted at a low height or a higher position creating a range of working heights for the carer and transfer heights for the client.

- Tilt operation to foot and head end (under medical supervision)
- Supplied with rastofix kit which allows the lower leg section to be raised
- Double height mattress platform positions
- Beech wood finish

Ask about our...
DELIVERY, INSTALLATION
DEMONSTRATION & SUPPORT

Specification	Select II Bed	Select Low Bed
Side rails	Yes	Optional
Max user weight	145kg	145kg
Safe working load	180kg	180kg
Height adjustment from floor	33 - 73 or 40 - 80cm	21 - 61 or 28 - 68cm
Outside dimensions	102 x 224cm	102 x 224cm
Inside dimensions	94 x 208cm	94 x 208cm
Mattress platform	90 x 200cm	90 x 200cm



BARIATRIC PROFILING BED

Our Bariatric 120cm wide bed provides the ultimate balance between user care, functionality and quality. It has all the features of the standard model and comes with the added ability of its range extending from 20cm to 80cm high, and a 120cm wide platform. It has a 3 year warranty on the bed frame and 2 years on the motors and electrics. It can be dismantled for storage or transporting and is available in Oak and Walnut wood finish.

- 3 year warranty on bed frame
- 2 year warranty on motors and electrics
- 10 function lockable handset
- Trendelenburg and reverse Trendelenburg tilting feature
- Knee brake adjustment
- Click stop lower leg raising elevation
- Electrically adjustable backrest
- Four robust braking 3" castors
- Four-section mattress support with mattress grips
- Extra high side rails available
- 20cm bed length extension kit available
- Tool-free assembling and dismantling
- Transport system for storage and transporting



BA-6681 Bariatric Mattress

Mattress Dimensions	1980 x 1200 x 150mm
Risk factor	High
Recommended max user weight	317kg (50st)
Vapour Permeable	Yes
Waterproof	Yes
Seams	Welded

ED-4141 Bariatric Profiling Bed

Side rails	Yes
Max user weight	250kg (39st)
Safe working load	250kg (39st)
Height adjustment from floor	20 - 80cm
Outside dimensions	132 x 213cm
Mattress platform	120 x 213cm

Laundry instructions for mattress:
Wipe clean with soft cloth and warm water / neutral detergent mix or apply to a maximum 90 degree wash for 30 mins, only if heavily contaminated

**FIRE
RETARDANT**

FIRE RETARDANT

Conforms to BS7177:2008 for medium hazard

All our profiling beds conform to the Standard EN 60601-2-52



AMETHYST

WIDE PROFILING BED WITH SIDE RAILS

This high-class wooden frame in walnut is complemented through an electrically adjustable BED IN BED system insert frame. The vertical adjustability of the lying surface is between 35cm and 79cm for the standard beds, and between 29cm and 69cm for the low beds.



AVAILABLE IN A CHOICE OF 5 OPTIONS

CODE	Type	Mattress Platform Width cm	Bed Width cm	Bed Length cm
BA-8211	Standard	90	111	206
BA-8210	Standard Extra Wide	105	126	206
BA-8213	Standard Low	90	111	206
BA-8212	Low Extra Wide	105	126	206
BA-8214	Bariatric	120	141	206

What to look for when choosing a mattress...

STATIC MATTRESS & CUSHIONS

Pressure reducing static foam products are suitable for every care environment

- Combustion Modified Ether (CME), castellated inlay sat in a "U" shaped, high density foam core gives high degree of pressure reduction
- Reinforced foam edges prevents slipping off the bed
- Profiles on a hospital bed frame
- Highly durable polyurethane foam
- Fire retardant to BS7177:2008
- Clinically Proven



SPECIALIST MATTRESS

Pressure reducing static foam products suitable for specialist care environments

- Multi-stretch, vapour permeable, antimicrobial, cover material
- Fully high frequency welded product
- Fire retardant CME foam
- Castellated foam surface
- UK manufactured product
- Dry floatation® technology
- Cells conform to body shape
- Clinically proven



DYNAMIC MATTRESS & CUSHION

Highly specialised dynamic alternating pressure systems

- Risk Factor - High Risk to Very High
- Maximum Patient Weight - 28 Stone/180Kgs
- Mattress Dimensions 200 x 88 x 20cm
- Alternation Cycle - 1 in 2
- Alternation Time - 10-12 mins
- Mattress Cover Coating 200g
- Extended Warranty Available



PICARA™ LOW RISK MATTRESS

- Support surface is castellated foam with a zonal area to provide support to heels
- Includes a 270° zip with protective flap
- Top cover has a white inner substrate to assist in identifying signs of cover damage and strike-through
- 2-way turn and X-ray translucent cover

Laundry instructions for mattress:
Wipe clean with soft cloth and warm water / neutral detergent mix or apply to a maximum 90 degree wash for 30 mins, only if heavily contaminated

MAX WEIGHT 187KG

ED-4014



Mattress dimensions	198 x 88 x 12.5cm
Risk factor	Low
Fatigue Class	Severe
Type of foam	CME
Rotate	Yes

Max user weight	187kg (29.5st)
Castellated	No
Multiple core	No
Seams	Stitched
Zips	Sewn Concealed Zip

PICARA™ MEDIUM/HIGH RISK MATTRESS

BEST SELLER

- Multi-stretch, vapour permeable cover
- High quality castellated CME foam supports and distributes pressure uniformly
- Can be rotated, one side castellation eliminates the need to turn
- Profiles on a hospital or nursing bed frame
- Fire retardant to BS7177(Crib 5) :2008
- 1 year warranty

Laundry instructions for mattress:
Wipe clean with soft cloth and warm water / neutral detergent mix or apply to a maximum 90 degree wash for 30 mins, only if heavily contaminated

MAX WEIGHT 165KG

ED-4019



* CME - Combustion Modified Ether (33kg/m3 – 160N)

Mattress dimensions	198 x 88 x 12.5cm
Risk factor	Medium-High
Fatigue Class	Severe
Type of foam	CME
Rotate	Yes

Max user weight	165kg (26st)
Castellated	Yes
Multiple core	No
Seams	Stitched
Zips	Sided Flap

THE GRAMPIAN II™**MAX WEIGHT 150KG**

An economical mattress overlay system, designed for the prevention and treatment of skin breakdown/pressure ulcer development. It is targeted for patients deemed at high risk of pressure ulcer development.

- Mattress suitable for most hospital/homecare beds
- Clinically Proven

Dimensions	200 x 88 x 20cm
Risk factor	High
Cell Construction	4.5inch
Alternation Cycle	1 in 2
Alternation Time	10-12 mins
Max user weight	150kg (24st)
Mattress Cover Coating	<200 - 250g
Extended Warranty	Available



Manual Pump

ED-6090

Digital Pump

ED-4075**PICARA™ THIN UNDERLAY MATTRESS****BEST SELLER**

Specially developed to support dynamic overlay mattress systems.

- Vapour permeable cover
- 1980 x 880 x 50mm

Laundry instructions for mattress:
Wipe clean with soft cloth and warm water / neutral detergent mix or apply to a maximum 90 degree wash for 30 mins, only if heavily contaminated

**JA-3372**
PICARA™ HIGH RISK
DYNAMIC DEEP CELL MATTRESS

The Picara High Risk Mattress is a deep cell, specialised dynamic mattress replacement system with manual pump as standard. However, this product can be upgraded to a digital pump for a small premium. This product is targeted towards the assistive treatment for patients who have existing and potentially severe pressure damage.

MAX WEIGHT 180KG

Manual Pump

ED-6097

Digital Pump

ED-6098

Mattress dimensions	200 x 88 x 20cm
Risk factor	High - Very High
Alternation Cycle	1 in 2
Alternation Time	10-12 mins
Max user weight	180kg (28st)
Mattress Cover Coating	200g
Warranty - Standard	1 Year (Extended warranty available)

BERKSHIRE PREMIUM GEL PRESSURE CUSHION - VERY HIGH RISK

The Berkshire™ is the premium pressure reducing cushion within the entire seating range.

- Multi-stretch, vapour permeable cover material aids infection control.
- Specialist gel & visco elastic foam design combination ensure the highest level of comfort and pressure re-distribution is achieved
- Provides excellent cooling properties whilst aiding skins micro climate
- Welded seam
- Foam type: Visco Elastic
- 43 x 43 x 7.5cm
- Maximum user weight: 165Kg (26st)
- Fire Retardant BS7176



ED-4043

MAX WEIGHT 165KG

HIGH RISK FOAM CUSHION

- Incorporates two high performance foams including visco foam surface and CME base
- Maximum user weight: 152kg (24st)
- Welded seam
- 43 x 43 x 7.5cm
- Fire retardant: BS7176

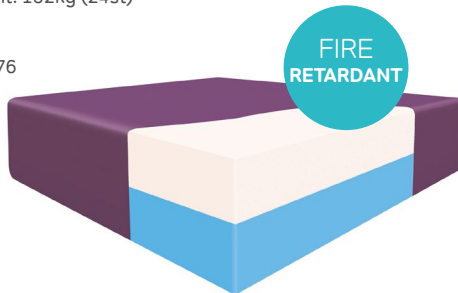

ED-4041

MAX WEIGHT 152KG

The Picara™ range of pressure reducing cushions can be used with almost any type of seating.

- Clinical judgement required to determine correct equipment, dependent on patient morphology
- Multi-stretch, vapour permeable waterproof covers incorporating antibacterial agent
- Double sided zip flap to protect from fluid ingress
- Flame retardant to crib 5 BS7176

THE WILTSHIRE II™ DYNAMIC CUSHION

This product is used for the prevention and treatment of pressure ulcers for patients in all categories of risk. This can be used in conjunction with a dynamic mattress system, under the required supervision.

- Risk Factor - Very High Risk • Aids infection control
- Multi-stretch, vapour permeable, antimicrobial, cover material
- Cell design aids patient comfort whilst providing excellent pressure relief (5 individual cells)
- Transport Mode enables ward/patient procedures
- Cushion Dimensions 46 x 46 x 10cm (suitable for standard arm chair / hospital chair)
- Maximum Patient Weight 150 kgs or 24st • Pump Style - Analogue
- Alternation Cycle: 1 in 2 • Alternation Time: 10-12 minutes
- Extended warranty available

MAX WEIGHT 150KG



ED-6092

LOW-MEDIUM RISK FOAM CUSHION

- Foam type: CME
- Maximum user weight: 108kg (17st)
- Sewn cover
- 43 x 43 x 7.5cm
- Fire retardant: BS7176

MAX WEIGHT 108KG



ED-4015

SENSAFLEX 300 MEMORY FOAM CUSHION VERY HIGH RISK

The Sensaflex 300 is a very high risk memory foam cushion with a high density foam base, foam centre and a castellated gel memory foam top. The cushion provides effective comfort, care and pressure redistribution for users in hospital, nursing and care home environments.

- Multi-stretch and vapour permeable PU cover
- Water resistant, vapour permeable cover
- Antimicrobial, machine washable cover
- BS7177: Crib 5

ED-4126



WASHABLE COVER

To launder the cover in a washing machine, set the main wash to 65oC for no less than 10 minutes or 95oC for no less than 3 minutes.

The cover can be tumble dried on low heat and the temperature must not exceed 60oC. The foam can be autoclaved at 134oC.

SENSAFLEX 200 FOAM CUSHION MEDIUM RISK

The Sensaflex 200 is a medium risk foam cushion built with castellated foam. The foam cushion provides effective comfort, care and pressure redistribution for users in hospital, nursing and care home environments.

- Multi-stretch and vapour permeable PU cover
- Water resistant and machine washable cover
- Antimicrobial cover with white underside
- BS7177: Crib 5

ED-4122



Available in all sizes including Divan and double. Ideal for very high risk patients who cannot tolerate an alternating system.

HERIDA AVON MATTRESS

Sat in u shaped high density foam to give maximum support and allow a generous patient weight of 247kg. The side-formers give support and aid patient transfer.

Key Features

- Combustion Modified Ether (CME), castellated inlay sat in a "U" shaped, high density foam core gives high degree of pressure reduction
- Reinforced foam edges prevent slipping off the bed
- Profiles on a hospital bed frame
- High durable polyurethane foam
- Multi-stretch, vapour permeable cover
- Fire retardant to BS7177:2008
- Clinically Proven

ED-4025

MAX WEIGHT 247KG

5 YEAR WARRANTY

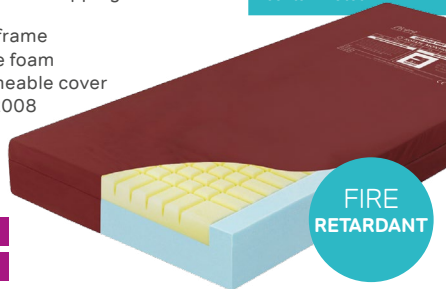

BEST SELLER

Laundry instructions for mattress: Wipe clean with soft cloth and warm water / neutral detergent mix or apply to a maximum 90 degree wash for 30 mins, only if heavily contaminated

Dimensions	198 x 88 x 15cm
Mattress Weight	13.98kg
Risk factor	High/Very High
Fatigue	Very Severe
Type of foam	CME
Rotate	Yes

Max user weight	247.7kg (39st)
Castellated	Yes
Multiple core	Yes
Seams	Welded
Zips	Double Sided Zip Flap
Laundry instructions	90°C wash for 30 mins

HERIDA HIGH RISK AVON-HEEL MATTRESS

The clinically proven Avon-Heel™ pressure reducing mattress, has been developed using the very latest Combustion Modified Ether (CME) and visco elastic foam technology. This pressure reducing castellated central zone maximises re-distribution in the most vulnerable areas, so that the mainstream patient weight can be managed effectively. The castellation's not only provide superior pressure management and postural support but it's channels are cut to ensure constant air dispersion occurs around the patient. This process aids in controlling temperature when compared to standard mattresses and therefore endeavours to improve comfort and as such aids the patient's ability to sleep well.

- Heel section features a 12% slope to help redistribute pressure from the heel to the larger parts of the leg
- Visco elastic foam within the slope is cut horizontally to help prevent shear and friction from agitated heels
- Standard 198 x 88 x 15/9cm

5 YEAR WARRANTY
FOAM & COVER



MAX WEIGHT 247KG

ED-4070

STRATHCLYDE™ HEEL BOOT

Clinically proven to reduce pressure on the vulnerable heel area. A handy cooling gel pack can be placed in the fridge before use, which in turn provides ongoing properties that can reduce the skins surface temperature.

- Comfortable padding offloads pressure points from the heel region to the back of the calve area.
- Made of a durable design, this product allows multi use for infection control purposes.

1 YEAR WARRANTY

Heel Boot (Pair)

ED-3011



THE LOTHIAN™ II**BEST SELLER**

Designed to ensure ease of use, whilst high clinical delivery is achieved in a single mattress. Specifically designed for use in long term care environments or equally at home in a residential setting. This product provides a very high risk solution, when used as part of a complete care package. The cyclical cells operate and deflate in a ten minute alternating pattern with a 1.5 minute equalling of cells in between the complete cycle, therefore providing direct pressure relief and patient stability throughout the whole dynamic process. The multi-stretch vapor permeable cover, comprises of a high level coating in plyurethane which makes it easy to clean whilst complying with strict infection control procedures. The rapid cell deflation system is unique in the sense that pressure relief happens much quicker than on a standard dynamic mattress system. This prompt deflation physically ventilates, thus allowing immediate relief between cycles, rather than awaiting deflation under patient weight as is often the case. The high density underlay is in its own zipped compartment for infection control purposes. The base foam is there for support and if a power failure occurs which make the cells deflate, the patient will not bottom out on to the bed.

- Comes as standard with 5 inch cell sits on foam base (7 inch combined)
- Should not be used by patients with severe spinal injuries/fractures
- Pressure range setting between 10 and 50mmhg
- Air leakage/low pressure alarm
- Clinically Proven

**MAX WEIGHT 180KG****2 YEAR WARRANTY****ASSEMBLED IN THE UK****ED-6093**

Dimensions	200 x 88 x 16cm	Max user weight	180kg (28st)
Risk factor	High-Very High	Pump Style	Digital
Alternation Cycle	1 in 2	Warranty	2 Year
Alternation Time	11.5 mins		

Available in all sizes including Divan and double. Ideal for very high risk patients who cannot tolerate an alternating system.

THE ARGYL II™

A second generation design, consisting of a high end, specialised dynamic mattress replacement system with digital pump. This system is targeted towards the assistive treatment for patients who have existing and potentially severe pressure damage. The system is designed for those patients considered to be at very high risk of pressure ulcer development.

- 20 deep cells which give maximum comfort and support
- Digital pump suitable for most hospital/homecare beds
- Mattress Weight - Less than 7Kgs
- Clinically Proven

ED-4052**ASSEMBLED IN THE UK****MAX WEIGHT 180KG****2 YEAR WARRANTY**

Dimensions	200 x 88 x 20cm
Risk factor	Very High
Alternation Cycle	1 in 2
Alternation Time	10-12 mins
Max user weight	180kg (28st)
Mattress Cover Coating	200g
Warranty	2 Year

Available in all sizes including Divan and double. Ideal for very high risk patients who cannot tolerate an alternating system.

BARIATRIC MATTRESS

Perfect fit for the Bariatric profiling bed on page 278

This Mattress has been specifically developed to support the heavier patient whilst optimizing pressure re-distribution. The multi-stretch, vapour permeable, high frequency welded cover ensures compliance with strict infection control policies. This mattress safeguards the skin integrity of the patient through a reduction in shear & friction forces.

Wipe clean with a soft cloth and warm water or a neutral detergent mix. If heavily contaminated, wash at 90 degrees for 30 mins.



BA-6681

MAX WEIGHT 294KG

Dimensions	1980 x 1200 x 150mm
Risk factor	High
Max user weight	317kg (50st)
Vapour Permeable	Yes
Waterproof	Yes
Seams	Welded

THE CLEVELAND BARI™ II

Our highly specialised, uniquely designed, bariatric pressure relieving mattress replacement system has been developed for use with the complex, heavy duty user in mind. The system is well versed with not only prevention but treatment of complex pressure ulcers, specifically for use with larger patient groups. The transverse cell construction of 10inch/215mm dimensions, provides support when it's more required. The one in three cell alternating cycle is more recognisable for relief with the heavier client.

- Multi-stretch, vapour permeable antimicrobial, cover material
- Fully high frequency welded product
- Transport mode
- CPR function
- Static mode
- Alarm function
- Clinically proven

ED-4059

MAX WEIGHT 300KG

2 YEAR WARRANTY



Dimensions	200 x 120 x 25cm
Risk factor	Very High
Alternation Cycle	1 in 2
Alternation Time	6, 9, 12, 25 mins
Max user weight	300kg (47.2st)
Mattress Cover Coating	<210-230g
Pump Style	Digital
Mattress weight	Less than 10kg
Warranty	2 Year Extended warranty available



**ASSEMBLED
IN THE UK**

HERIDA MORAY-COMBO

The Moray combo hybrid mattress is a 2 in 1 mattress. Firstly a high risk foam pressure reducing mattress, then if the patient has to set up (or just a patient that needs very high risk) to an alternating mattress the pump can be attached and the integrated cells will begin to alternate. Pump style is digital.

- Fully welded, Multi stretch - vapour permeable fabric
- Leading Design / Safer Heel Solution
- CME Foam surround & base
- High Quality Foam Filled Cell Technology
- Active Therapy Mode (WITH PUMP)
- Comfort Mode Selection
- Clever Hose Management Chamber
- Unique CPR Function / Actions
- Easy Transportation
- Risk Factor-Very High Risk (up to and including Grade IV pressure ulcer)
- Noise Output - Ultra-low-45db

ED-7051

Dimensions	198 x 88 x 16cm
Risk factor	Very High
Cycle Time	1 in 2
Cell Alteration Cycle	11.5 mins
Max user weight	248kg (39st)
Pump Style available	Digital & Analogue
Mattress weight	<9kg
Warranty - Foam & cover	5 Year (Pump 2 Year)

Available in all sizes including Divan and double. Ideal for very high risk patients who cannot tolerate an alternating system.



MAX WEIGHT 248KG

5 YEAR WARRANTY - FOAM & COVER

2 YEAR WARRANTY - PUMP ONLY



HIPSAVER

HipSaver features soft permanently sewn-in hip pads that protect trochanteric areas located at the top of the thigh bones from the dangerous effects of the impact forces generated by accidental falls. HipSaver airPads are soft, light and large. Each soft and pliable airPad weighs mere 80g. The airPad moulds themselves into the user's body contours during wearing. And because the HipSaver airPads are large by comparison to pads used in other brands of hip protectors, the chances of pad misplacement during wearing of HipSavers are very minimal, thus offering reassurance and safety to HipSaver users.

***MOST PRODUCTS AVAILABLE WITH TAILBONE PROTECTION**

Please request when you place your order.

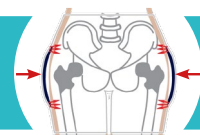

Measure hip circumference at level marked by arrows
Unavailable on all XS sizes

HIPSAVER SLIM FIT WOMEN

- Sewn in shields for excellent protection
- Can be worn over user's underwear
- Discreet and comfortable to wear

TAILBONE PROTECTION
OPTIONS AVAILABLE

ED-8013	X Small	70 - 81cm
ED-8012	Small	82 - 92cm
ED-8011	Medium	93 - 102cm
ED-8010	Large	103 - 114cm
ED-8009	X Large	115 - 127cm
ED-8008	XX Large	128 - 146cm



HIPSAVER NURSING HOME MODEL

- Model that fits both sexes
- Can be worn over user's underwear
- Discreet and comfortable to wear

TAILBONE PROTECTION
OPTIONS AVAILABLE

MALE	FEMALE		
ED-8034	ED-8027	X Small	70 - 81cm
ED-8033	ED-8026	Small	82 - 92cm
ED-8032	ED-8025	Medium	93 - 102cm
ED-8031	ED-8024	Large	103 - 114cm
ED-8030	ED-8023	X Large	115 - 127cm
ED-8029	ED-8022	XX Large	128 - 146cm

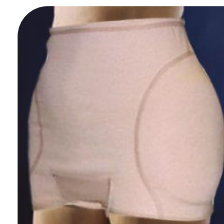

HIPSAVER SLIM FIT MEN

- Sewn in shields for excellent protection
- Can be worn over user's underwear
- Discreet and comfortable to wear

TAILBONE PROTECTION
OPTIONS AVAILABLE

ED-8020	X Small	70 - 81cm
ED-8019	Small	82 - 92cm
ED-8018	Medium	93 - 102cm
ED-8017	Large	103 - 114cm
ED-8016	X Large	115 - 127cm
ED-8015	XX Large	128 - 146cm



HIPSAVER 'OPEN BOTTOM' UNISEX

IDEAL FOR HEAVY TO DOUBLE INCONTINENCE

Facilitates change of incontinence products.

ED-8005	X Small	70 - 81cm
ED-8003	Small	82 - 92cm
ED-8002	Medium	93 - 102cm
ED-8001	Large	103 - 114cm
ED-8004	X Large	115 - 127cm
ED-8006	XX Large	128 - 146cm



repose



Let Repose take the pressure off



Providing effective pressure redistribution solutions

-  Durable
-  Multi-patient Use
-  Comfortable
-  Cost Effective

Code	Product Description
1 ED-6050	Mattress Overlay & Pump*
2 ED-6055	Cushion & Pump
1&2 ED-6052	Mattress* & Cushion Set & Pump
3 ED-6056	Foot Protector & Pump
4 ED-6057	Wedge & Pump

Code	Product Description
5 ED-6070	Contur Recliner Overlay
6 ED-6071	Care-Sit Cover & Pump (400mm)
6 ED-6072	Care-Sit Cover & Pump (450mm)
7 ED-6073	Sole Protector
8 ED-6074	Foot Protector Plus Pair

*Max patient weight 222kg when used in conjunction with a high specification foam mattress. Otherwise weight limit for Repose products: 139kg

HEEL PRESSURE RELIEF BOOTEE

Offload is an inflatable offloading device to help safely remove pressure from the foot area, thus aiding the prevention of pressure injuries to the heel, or managing patients with an existing pressure ulcer.

Each pack contains a pair of Offload bootees, a pump and an instructions for use leaflet.

- H 20 x W 30 x L 46cm
- Weight: 3.35kg
- Pair



ED-6079

PREVASSE PRESSURE REDISTRIBUTING CUSHION - READY TO USE

Prevasse is a pressure redistributing cushion which is pre-inflated and ready to use straight out of its box.

- Ideal for the prevention of pressure ulcers for all patients including those at high risk.
- Can be used for existing stage 1 & 2 pressure ulcers
- Can be cleaned and reused for multiple patient use
- Clinical supervision is advised if damage is severe

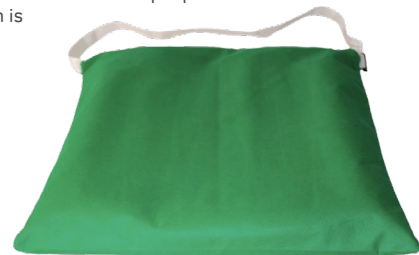

ED-6078

FOAM POSITIONING AIDS

A range of versatile positioning aids manufactured from high quality memory foam that are covered in a 2 way stretch, fire retardant, vapour permeable fabric making them easy to use and clean. Ideal for:

- Part of safe exercise routines
- Part of an ulcer treatment plan to either treat or avoid pressure sores
- An aid to help patients find their most restful position

SMALL CYLINDER

50 x 10cm



ED-4005

HALF MOON



ED-4007

T-ROLL

Soft, comfortable and easy to use, the T-Roll aids the positioning of lower limbs. Made from durable foam and covered with a wipe-clean, vapour permeable material.

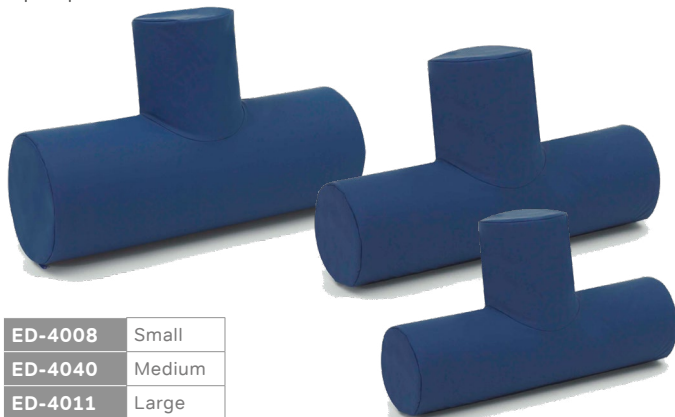

ED-4008	Small
ED-4040	Medium
ED-4011	Large

LEG TROUGH

BEST SELLER

This leg support not only offers comfort in raising the leg but will keep the heel above the bed surface and completely relieves pressure on the heel.



Each

ED-4010

BED WEDGES

Many uses for these bed wedges include a sitting up back rest or pillow raiser. Made of polyurethane foam and covered in a vapour permeable wipe clean fabric.

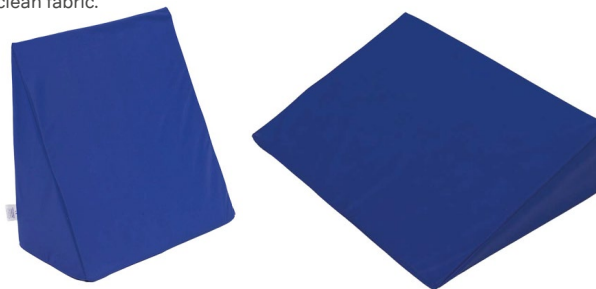

ED-4003	Small	56 x 38 x 13cm
ED-4002	Large	56 x 56 x 30cm

HEEL PADS

Designed to offer a high degree of patient comfort with a generous amount of foam filling.

Comes as a pair



ED-3018

MAXXCARE® PRO HEEL BOOT

Provides excellent comfort and pressure reduction for patients with a 'high risk' of developing pressure ulcers to the vulnerable heel area. For patients with pressure damage, the Maxxcare® Pro Heel Boot can be an effective solution for wound healing as it's unique design allows for heel off loading.



Each

ED-3010

STRATHCLYDE™ HEEL BOOT

Clinically proven to reduce pressure on the vulnerable heel area. For full details see page 285.



Pair

ED-3011

HAND CUSHIONS

Often patients suffering from the effects of c.v.a. develop contractures of the hand. As a result, skin integrity of the inner hand can be compromised due to the build up of moisture. The use of the hand cushion coupled with attention to hygiene will prevent this occurring.

Pair



ED-6739

PALM PROTECTOR WITH FLEECE LINING**BEST SELLER**

To help patients from digging their finger nails into their palms. Made of high density closed cell foam with fleece to the inner layer. Hook & loop on the back to hold in position.

Each

ED-6701-RIGHT

ED-6701-LEFT

**ELBOW PROTECTORS**

100% Hospital quality deep pile polyester elbow protector for comfort and ease of washing and drying - suitable for hospital laundries. Velcro fastening

Pair

ED-6703

**ROUND CUSHION**

- Ideal for knees, ankles, heels, elbows & wrists
- Washable at 40°C



ED-6736	Small	15.2cm dia
ED-6737	Medium	17.8cm dia
ED-6738	Large	20cm dia

SLIPPY HEEL PROTECTORS

Pure wool pile with outer shell of easy slide material. For use in bed to prevent shear force and aid movement between the sheets.



Pair

ED-6702

Index

A

ACCIDENT BOOK 59, 60
ADMINISTRATION SOLUTION SET 64
AIR FRESHENER 186, 198, 217, 224, 225
AIRPOT DISPENSER 145
ALCOHOL FREE WIPES 56
ANTI-ROLL SIDE WEDGES 271
APRONS & DISPENSER 10-11, 22, 157
ANTIBACTERIAL CLEANER 20
ARIANNE NEBULISER 76
ARM SUPPORT HINGED 89
ASHTRAY 257
ASSISTED CUTLERY 132
ATTENDS INCONTINENCE RANGE 42

B

BACTERICIDAL 176
BAGS & SACKS 69, 152, 235, 236, 241, 246
BAKEWARE 150
BAKING UTENSILS 151
BANDAGES 51
BARIATRIC BED 274
BATH SPONGE 174
BATTERY DURACELL 224
BATWING SUPPORT PILLOW 263
BEDS 273-279
BED CRADLE 271
BEDDING 260, 261, 262, 267
BED PADS 271
BED PAN 68, 69
BED PROTECTION 29, 41, 48
BEVERAGE JUGS 145
BIBS 23
BINGO 124
BIN LINERS 237
BINS 130, 239, 243
BIOHYGIENE 202
BLANKET 54, 60, 266, 267, 274

BLEACH 197
BLOOD PRESSURE MONITOR 73
BLUE PLASTERS 54
BODILY FLUIDS SPILL KIT 57-58
BRILLO PADS 234
BRUSHES 229
BRYTA 210, 211, 212, 216
BUBBLE TUBE 66
BUCKET MOP 231
BUD VASE 147
BURNSHIELD DRESSINGS 60
BUTTER DISH 144
BUTTERFLY WINGED INFUSION SET 64

C

CAKE TIN 150
CAN OPENER 153
CARD GAMES 119, 121
CAREFREE 218
CARPET CLEANER 187
CATERING FIRST AID 61
CATHETERISATION PACK 54
CAUTION WET FLOOR SIGN 231
CENTRE FEED ROLL 167
C FOLD PAPER TOWELS 168
CHAIR SCALE 107
CHEMICALS 184
CHLORINE TABLETS 214
CHOPPING BOARD 154
CIF PRO 216, 217
CIGARETTE BOX 257
CIRCUMFERENCE MEASURE 106
CLEANING CLOTHS COLOUR CODED 228
CLEANSING WIPES 12-17
CLING FILM / FOIL 158
CLINICAL REAGENTS CABINET 83
CLINICAL WASTE SACKS 237
CLOTHING PROTECTORS 22
COAT HANGER 258
COMFORT 209
COMMUNE 85, 87, 92, 96, 197
COMMODE PAN 68
COOLING TRAY 150
COTTON WOOL 55

CPR FACEMASK 67
CREAM / MILK JUG 141
CROCKERY 141
CUFF FOR SPHYGMOMANOMETER 74
CUTLERY 132, 159, 190, 194, 195, 206, 221, 247

D

DECK BRUSH 229
DEFIBRILLATOR 79
DEGREASER 190, 191, 196
DEMENCIA AIDS 115
DENTURE TABLETS 173
DEODORANT 173
DEODORISER 217
DERMATOLOGICAL GLOVES 52
DESCALER 191, 213
DETERGENT SANITISER 212
DETTOL 56
DISHWASHER DETERGENT SUPER STRENGTH 194
DISHWASHER POWDER 194
DISHWASHER TABLETS 210
DISINFECTANT 18, 19, 20, 199, 213, 215, 216, 219
DISPENSER CENTRE FEED 162, 167
DISPENSER PAPER TOWEL 168, 170
DISPENSER SOAP 176, 177
DISPENSER TOILET ROLL 165, 172
DISPOSABLE APRONS 157
DIVAN BED 273
DIVERSEY 208
DOMESTIC GLOVES 234
DOMESTOS 213
DOOR SIGNAGE DEMENTIA 115
DOVE SOAP 175
DOYLEYS 161
DRAIN CLEANER 191, 211
DRESSINGS 52
DRESSING TROLLEY 108
DRIP STAND 109
DRITECH BEDDING PROTECTION 261
DRUG BOOK 84
DRUG DISPENSER 84
DRUG REFRIGERATOR 80
DRUG TROLLEY 83
DRY WIPES 12, 13

DUSTER 229
 DUSTPAN & BRUSH 229
 DUVET 264
 DUVET COVER 261, 265

E

EGG CUP 141
 EGG SLICER 152
 EMERGENCY BLANKET 54
 ENDBAC 212
 ENHANCE 218
 ENTERAL SYRINGE 65
 EVACUATION 102-103
 EXAMINATION COUCH 109
 EXERCISE PEDAL 123
 EXTENSION SET VENISYSTEM 64
 EYE CARE PACK 53
 EYE PAD 54
 EYE WASH SOLUTION 56

F

FABRIC CONDITIONER 193, 208, 209
 FABRIC SOFTENER 185
 FACE CLOTH 268
 FACEMASK 67
 FALL OUT MAT 271
 FIRE BLANKET 60
 FIRST AID KIT 61
 FISH SLICE 151
 FLOOR CLEANER 187, 204, 249, 252-255
 FLY SPRAY 226
 FOAM ORAL SWAB 55
 FOIL / CLING FILM 158
 FOOD BOWL 136
 FOOD ROTATION LABEL 158
 FORCEPS DRESSING 54
 FRESH CHEMICALS 184
 FURNITURE POLISH 199, 216, 219

G

GALLIPOT STERILE 55
 GAMES 119, 121, 123

GARMENT RAIL 258
 GAUNTLETS 234
 GLADE 226
 GLASS COOKWARE 163
 GLASS & MIRROR CLEANER 186
 GLASS FRUIT BOWL 139
 GLOVE BOX HOLDER 181
 GLOVES STERILE MEDICAL 9
 GLUCOSE MONITORING SYSTEM 75
 GOGGLES 234
 GOJO HAND HYGIENE 6
 GOOD SENSE 211, 217
 GRAB RAIL 89
 GRATER 151
 GRAVY BOAT 144
 GRILL CLEANER 212
 GUEDAL AIRWAY 67
 GUEST TOILETRIES 175

H

HAIR BRUSH 173
 HAIR NET 157
 HAIR SPRAY 173
 HANDLE FOR MOP / BRUSH 230
 HANDLING BELT 105
 HAND SOAP 176
 HARD FLOOR CLEANER 187
 HAND SANITISING 5
 HEADBOARD 273
 HEEL PROTECTOR 292
 HEIGHT MEASURE 106
 HOISTS & AIDS 95
 HOLDER FOR MOP / BRUSH 230
 HORIZON 208
 HOUSEKEEPING 164
 HOUSEKEEPING TROLLEY 180, 248
 HUDSON FACEMASK 67
 HYPODERMIC NEEDLE 63

I

ICING TUBES 152
 ID BRACELET 58
 ID INCONTINENCE 29

INCONTINENCE RANGE 25
 INDAS INCONTINENCE 47
 INFECTION CONTROL 176
 INFUSION SET 64
 INSTRUMENT TRAYS 68
 IRON & IRONING BOARD 258

J

JUG MEASURING 153
 JUG POLYCARBONATE 133
 JUGS GLASS 139

K

KARRI CART 245
 KENTUCKY MOP 232
 KETTLE 163
 KICK STEP 256
 KITCHEN CLEANER 190
 KITCHEN KNIFE 154
 KITCHEN ROLL 162
 KITCHENWARE 149
 KNIFE HOLDER 154

L

LADLE 151
 LANCET 75
 LAUNDRY BAGS 235
 LAUNDRY BASKET 258
 LAUNDRY DESTAINER 207
 LAUNDRY LIQUID 184, 193
 LAUNDRY POWDER 193
 LEG REST 109
 LILLE INCONTINENCE 26
 LIMESCALE REMOVER 211, 213
 LINEN HAMPER 258
 LINEN TROLLEY 245
 LOAF TIN 150
 LOCKER SET 133
 LOTION 175

M

MASHER 151
 MATTRESS 102, 263, 274, 280, 281, 282, 285, 287
 MATTRESS PROTECTOR 262
 MATTRESS UNDERLAY 282
 MEDICINE POT 68
 MEMORY BOX 117
 MENU BOARD & CARDS 116
 MENU HOLDER 117
 MICROFIBRE CLOTH 233
 MICROWAVE 163
 MOLICARE INCONTINENCE 46
 MOP BUCKET 182, 231
 MOP HEAD 232
 MOULD & MILDEW REMOVER 220
 MOUTHWASH 173
 MUFFIN TIN 163
 MUG 131, 137, 138, 143
 MULTISTIX 69
 MULTI SURFACE CLEANER 20, 186, 217, 219
 MUSICAL BINGO 124
 MUSICAL INSTRUMENTS 124

N

NAIL BRUSH 174
 NAPKIN RING 144
 NAPKINS 148
 NASAL CANNULA 66
 NEBULISER 76
 NEBULISER SET 66
 NEEDLES 62
 NON-STICK COOKWARE 149
 NORTH SHORE PAPER AND SOAP 169
 NURSE CALL 111
 NURSING SCISSORS 54

O

ODOUR ELIMINATOR 188, 198, 211
 OMELETTE PAN 149
 ORAL HYGIENE PACK 55
 ORAL SWABS 55
 ORIENTATION & WAYFINDING 115

OTOSCOPE 74
 OVEN CLEANER 196
 OVEN GLOVE 162
 OVERBED TABLE 272
 OVERLAY MATTRESS SYSTEM 282
 OVERSHOES 58
 OVERSLEEVES 58
 OXIMETER 76
 OXYGEN CONSUMABLES 66

P

PANS 149
 PARACHUTE CANOPY 123
 PAPER & DISPENSERS 165
 PASTRY BRUSH 152
 PASTRY CUTTER 152
 PEELER 152
 PEDAL BIN LINERS 237
 PEN TORCH 74
 PERSIL 209
 PILL CRUSHER 84
 PILL DISPENSER 84
 PILLOW 263
 PILLOWCASE 262, 265, 266, 267
 PILLOW PROTECTOR 263
 PIPING BAGS 152
 PLASTERS 54
 PLASTIC BUCKET 10LTR 231
 PLATE SURROUND 132
 POACHER 149
 POLYCARBONATE TABLEWARE 146
 POSITIONING AIDS 291
 PPE 9-10
 PRE-INJECTION SWAB 63
 PRIMACARE CHEMICALS 193
 PRESSURE RELIEF 280-290
 PROCEDURE PACK 53
 PROTECTIVE PADS 48
 PULP PRODUCTS 68
 PURELL HAND HYGIENE 6

Q

QUIZ 124

QUOITS 122

R

RAISED TOILET SEAT 91
 RAZOR 173
 REACHER 94
 REMINISCENCE 119
 RESCUE AID MOUTH SHIELD 67
 RESUSCITATOR 67
 REUSABLE CHAIR, BED & FLOOR PAD 48
 RE-USABLE LAUNDRY BAGS 235
 RINSE AID 192, 194, 210
 ROLLING PIN 152

S

SAFETY NEEDLE 62
 SAFETY PIN 54
 SALT DE-ICING 257
 SALT & PEPPER POT 145
 SANGENIC DISPOSAL UNIT 49
 SAUCER 135, 136, 142
 SCALES 106
 SCALES KITCHEN 150
 SCISSORS KITCHEN 153
 SCOOP 151
 SCREEN FRAME 108
 SECLUSION BLANKET 274
 SENSOR PAD 111
 SENSORY 125
 SERVIETTE 161
 SERVING SPOON 139, 140
 SHAKER 152
 SHAMPOO 174, 218
 SHAMPOO CAP 174
 SHAVING FOAM 173
 SHERRY GLASS 139
 SHIELD 213
 SHOWER BED 88
 SHOWER CHAIR 86, 88-89
 SHOWER GEL 174
 SHOWER STOOL 89
 SIDE RAIL 271
 SING ALONG 124

SKIMMER 151
 SKIN CLOSURE 56
 SLEEPKNIT BEDDING 267
 SLIDE SHEETS 104
 SLING 97, 100, 104
 SNAP FRAME 117
 SOAP 6-7, 175-178
 SOAP DISH 259
 SPATULA 152
 SPECULA FOR OTOSCOPE 74
 SPHYGMOMANOMETER 73
 SPONGE SCOURER 234
 SPOT & STAIN REMOVER FOR CARPETS 218
 SQUEEGEE FLOOR 232
 STAINLESS STEEL CLEANER 199
 STAINLESS STEEL SCOURER 234
 STAIN REMOVER 185, 221
 STAND AID 97
 STEPS 256
 STERILE DRESSING 52
 STETHOSCOPE 74
 STEW PAN 149
 STITCH CUTTER 53
 STRAINER 151
 STRAWS 131
 SUCTION CATHETER 66
 SUCTION MACHINE 77, 78
 SUCTION TUBING 66
 SUGAR BOWL 141, 142
 SUMA 210, 211, 212, 216
 SUNDAE DISH 144
 SURFACE WIPES 18
 SUTURE REMOVAL 53
 SWABS 55
 SYRINGE 62, 69

T

TABLECLOTH 148
 TABLE MAT 147
 TABLET COUNTER 84
 TABLEWARE 135, 136, 137, 142, 144, 146
 TABLEWARE CROCKERY 141
 TABLEWARE DEMENTIA 136
 TABLEWARE POLYCARBONATE 135

TALCUM POWDER 174
 TASKI 216, 217, 218, 253, 254, 255
 TEAPOT 142
 TENA INCONTINENCE 35
 TENA SHAMPOO & SHOWER 40
 TENA WASH CREAM 40
 TERUMO 62
 THERAPY AIDS 126
 THERMOMETER BATH 72
 THERMOMETER CATERING 155
 THERMOMETER DIGITAL 71
 THERMOMETER NON-CONTACT INFRARED 71
 THERMOMETER WALL 72
 TIE HANDLE BAG 237
 TITAN 214, 215
 TOASTER 163
 TOAST RACK 145
 TOILET AIDS 90
 TOILET CLEANER 213
 TOILET ROLL 165, 172, 259
 TOILET SEATS & AIDS 90-91
 TONGS 151
 TONGUE DEPRESSOR 55
 TOOTHBRUSH / TOOTHPASTE 173
 TORCH 74, 257
 TORK PAPER SYSTEMS 171
 TOURNIQUET 63
 TOWEL BATH 268, 269
 TOWEL BATH SHEET 268
 TOWEL RAIL 259
 TOWEL RING 259
 TRACHEOSTOMY 67
 TRANSFER SLIDE 104
 TRAVEL FIRST AID 61
 TRAYS 68
 TRI-WALKER 94
 TROLLEY CHANGING 245
 TROLLEY CLEANING 180, 230, 248
 TROLLEY DRESSING 108
 TROLLEY DRUG 83
 TROLLEY OXYGEN CYLINDER 108
 TUBULAR BANDAGE 51
 TURNING DISCS 105

U

UNIFORMS 24
 URINAL & TOPPER 68
 UROLOGICAL 69
 UTILITY TROLLEY 247

V

VACUTAINER 65
 VACUUM BAG 253
 VACUUM CLEANER 250-253
 VALANCE 265
 VECTOR BEDPAN 68
 VERNAGEL 69
 VINEGAR BOTTLE 145
 VISITOR BOOK 59
 VOMIT BOWL 68
 V-SHAPED PILLOW 263

W

WASHING UP LIQUID 195
 WASHROOM CLEANER 189, 197, 200
 WASTE FOOD CADDY 247
 WATER EXTRACTION CARPET CLEANER 187
 WC CLEANER 189
 WET WIPES 12
 WHEELCHAIR 93
 WHEELCHAIR WEIGHER 107
 WHEEL WALKER 94
 WHISK 151
 WIPES 12-17
 WINGED INFUSION SET 64
 WOUND CARE PACK 53
 WRAPMASTER DISPENSER 158

Y

YORKSHIRE PUDDING TIN 150

Z

Z FOLD PAPER TOWELS 168, 170

Below are listed our terms and conditions of sale and it is important that you read and understand them. If you have any queries we would be happy to answer them on 01226 719090

1. ACCEPTANCE OF ORDERS

1.1 These Terms and Conditions shall apply to all orders for goods received by Countrywide Healthcare Supplies Ltd. (the Company) for supply in the United Kingdom. No other conditions whether or not inconsistent with these Terms and Conditions shall apply.

1.2 Each order for goods will be deemed to be an offer by the customer to purchase the goods upon these Terms and Conditions (the 'Order'). A contract shall not be formed until the customer's order is accepted.

1.3 All Contracts are subject to these Terms and Conditions. No variation of these Terms and Conditions will be accepted by the Company unless previously agreed in writing. The Company reserves the right to refuse any Order without providing a reason.

1.4 Goods are subject to availability, in the event that we are unable to supply the goods, we will inform you of this as soon as possible. An alternative will be offered or a full refund will be given where payment has already been received by the Company for those Goods.

2. CUSTOMER'S AUTHORITY

Customers entering into transactions with the Company expressly warrant that they are authorised to accept and are accepting these Terms and Conditions not only for themselves but also as agents for and on behalf of all other persons who are, or may become, interested in the Company's goods, whether in whole or part.

3. DETAILS AND SPECIFICATIONS

Details and specifications of goods will be as set out in the Company's current brochure. The Company reserves the right to alter specifications of any given product and to withdraw any item without explanation or notification. Current specifications can be confirmed with the Company by telephone.

4. PRICES

The price for the goods will be the price set out in the Company's current brochure or websites, the Company reserves the right to change any price without notice. Costs of packaging and carriage and any applicable sales tax or duty will be added to the price where relevant. All prices quoted are subject to VAT at the prevailing standard rate. Any organisations that are exempt from VAT must provide a validated certificate at the time of ordering.

5. PAYMENT

5.1 The Company may, at its sole discretion, accept payments by

credit, debit card or BACS. Unless otherwise agreed, credit account customers are required to tender full payment within 30 days from the date of each and every invoice.

5.2 If any sum payable is not paid when due, the Company will be entitled to suspend delivery of subsequent Orders and any agreed discounts until the outstanding amount has been received.

5.3 If any sum payable is not paid when due for example, by failure of the direct debit payment, that sum will bear interest from the due date until payment is made in full at 4% above HSBC Bank PLC base rate from time to time and the Company will be entitled to suspend delivery of subsequent Orders and any agreed discounts until the outstanding amount has been received.

6. CANCELLATION OF ORDERS

The Company will use all reasonable endeavours to meet Customers' individual requirements but the Company shall be under no obligation to accept cancellation or other amendment to any order or any part of an Order once accepted by the Company. Where such cancellation or amendment to an Order is agreed by the Company, it is on the understanding that a cancellation or amendment charge may be levied at the Company's sole discretion which may include unavoidable costs incurred by the company.

7. DELIVERIES, CARRIAGE AND TAILGATE DELIVERY

7.1 All Orders will be despatched by the most appropriate route. Where a customer suggests an alternative route or places an Order outside the normal schedule, the Company shall have the right to charge carriage irrespective of the value of the Order.

7.2 Deliveries will be made to the reception desk and/or ground floor at the Customer's stated delivery address. Any special delivery requirements or difficulties in delivering (e.g. narrow doorways, stairs and restricted access) should be made known to the Company at the time of placing the Order and may be subject to additional costs. The Company cannot accept responsibility for any difficulties in delivery as a consequence of information or lack of information supplied by the customer. All furniture is sold subject to 'Tailgate Delivery' i.e. customer assistance will be required to unload vehicles.

7.3 The company will use reasonable endeavours to deliver each of the customers orders within the time agreed when the Company accepts an order. If no time is agreed then within a reasonable time, but inability to deliver for any reason will not be deemed as breach of contract nor (for the avoidance of doubt) will the Company have any liability to the customer for direct, indirect or consequential loss how-so-ever caused (including as a result of negligence) by any delay or failure in delivery. Any delay in delivery will not entitle the customer to cancel the Order or to receive a refund of any monies owed or paid. The Customer shall have no other remedy in respect

of late delivery.

8. RETENTION OF TITLE

8.1 All goods supplied by the Company to the customer shall remain the property of the Company until such time as the Company has received payment in full for the goods and of all other moneys due to the Company from the Customer. After delivery of the goods to the Customer or his nominated sub purchaser, the goods shall be at the customer's risk and the customer shall insure those goods against loss or damage. Until such full payment is received the separate identity of those goods shall be maintained by the Customer.

8.2 Until such time as title of the goods shall pass to the customer in accordance with the foregoing provision, the Company shall be entitled at any time to repossess the goods whether with or without notice and the Company and its employees or agents shall have the right at any time to enter upon the premises of the Customer for the purpose of effecting such repossession.

9. FORCE MAJEURE

The Company will not be liable to the Customer for any failure or delay in delivery of the goods if it is due to any event beyond the reasonable control of the Company. The Company will be entitled to a reasonable extension of time for performing such obligations and shall not be liable for any loss or damage occasioned to the Customer thereby.

10. WARRANTY AND WARRANTY PERIOD

10.1 Goods are supplied according to the descriptions and specifications given in the relevant and current brochures of the Company. The Company gives no warranty, save for manufacturer's warranty (normally 12 months from date of purchase, unless an alternative period is specified). Neither does the company make presentation as to the suitability or fitness of any goods for any particular purpose unless expressly given or made in such brochures or websites.

10.2 In the event that an item is defective within the meaning of the Sale of Goods Act 1979 (as amended from time to time) the Company reserves the right to replace or repair the goods as an alternative to refunding the purchase price, at its absolute discretion.

10.3 Claims will not be considered where:

10.3.1 The goods have been improperly altered in any way whatsoever, or been subject to misuse or unauthorised repair;

10.3.2 The goods have been improperly installed or connected;

10.3.3 The goods have been opened, partly used or the seals or labels have been removed or tampered with;

10.3.4 The goods have been damaged by fire, water, smoke or chemicals;

10.3.5 Any maintenance requirements relating to the goods have not been complied with;

10.3.6 The goods have been specifically ordered by the Customer and are not stocked by the Company;

10.3.7 Any instructions as to the storage of the goods have not been complied with in all respects;

10.3.8 The Customer has failed to notify the Company of and visible or suspected defects or damage within 3 days of delivery where the defect or damage should be apparent on reasonable inspection, or within 5 days of the same coming to the knowledge of the Customer where the defect or damage is not one which should be apparent on reasonable inspection.

10.3.9 The damage is a result of willful damage, common neglect or fair wear and tear.

10.4 Any returned goods must be accompanied by a returns note, which the Company will supply to the Customer upon request. Failure to do so will render any claim for credit null and void. Any credit will only be raised after satisfactorily passing inspection by the Company's distribution centre.

10.5 The complete packaging should be retained if goods are to be returned.

10.6 Except as set out in this condition 10, the Company hereby excludes to the fullest extent permissible in law, all conditions, warranties and stipulations, express (other than those set out in the Contract) or implied, statutory, customary or otherwise which, but for such exclusion, would or might subsist in favour of the Customer.

11. CARRIAGE CHARGES

11.1 The Company reserves the right to make a small order charge of £7.50 ex VAT towards the carriage of orders under £75.00 ex VAT.

11.2 Delivery to most areas of mainland UK is free of charge, subject to 11.1 however any orders that are not to mainland UK or to certain areas of mainland UK may incur additional costs. These will be advised to the Customer prior to the Order being dispatched.

11.3 Goods shipped direct from suppliers may also be subject to additional carriage charges. Any additional charges will be advised prior to the Order being despatched to the Customer.

12. NON-DELIVERY

In the event of non-arrival of goods, Customers must inform the Company within 5 working days of the date of the invoice or advice of despatch, otherwise no claim can be considered or in the event of goods missing from a delivery within 3 days of the date of that delivery.

13. RETURN OF GOODS

13.1 Goods are not supplied on a sale or return basis and the company are under no obligation to accept goods for return unless

goods prove to be faulty. If a return is approved, the Goods must be unused and in original packaging and fit for resale. Returns will only be accepted with prior written permission of the Company. In so far as non-faulty goods this must be obtained within 5 working days of date of receipt. If we have agreed a collection date for your return, we reserve the right to charge £10 for each failed collection attempt.

13.2 Goods Accepted for return are subject to the following conditions:

13.2.1 All applications for a return must be made in accordance with condition 10.

13.2.2 Items made to Customer's own specification or have been specifically ordered or have been subject to a signed 'Order Confirmation' will not be accepted for return unless faulty in accordance with condition 10. Unless agreed with supplier such returns are subject to any charges and transit costs imposed by suppliers or collection charges imposed by the company.

13.2.3 No replacements are available whilst goods are exchanged, replaced or repaired.

13.2.4 Goods will not be acceptable for return if they have been re-labeled or used in any way, or if any tamper evident seals have been broken. A returns note in accordance with condition 10.4 needs to be provided by the customer in connection with all returns of goods.

13.2.5 Non faulty goods accepted at the Company's discretion for credit will be subject to a handling charge at a rate of 15% on net invoice value or a minimum of handling charge of £15.00.

14. LIABILITY OF THE COMPANY

14.1 The Company's entire liability under these Terms and Conditions and any Contract is as set out in conditions 7 and 10. The Company will be under no liability to the Customer whatsoever (whether in contract, tort (including negligence), breach of statutory duty, restitution or otherwise) for any injury, death, damage or direct, indirect or consequential loss (all three of which terms include, without limitation, pure economic loss, loss of profits, loss of business, depletion of goodwill and like loss) how-so-ever caused arising out of or in connection with:

14.1.1 Any of the goods, or the manufacture or sale or supply, or failure or delay in supply, of the goods by the Company or on the part of the Company's employees, agents or sub-contractors;

14.1.2 Any breach by the Company of any of the express or implied terms of the contract with the Customer;

14.1.3 Any use made or resale by the Customer of any of the goods, or of any product incorporating any of the goods; or

14.1.4 Any statement made or not made, or advice given or not given, by or on behalf of the Company or otherwise under a Contract and these Terms and Conditions.

14.2 The Company does not exclude its liability (if any) to the Customer for:

14.2.1 For breach of the Company's obligations arising under section 12 Sale of Goods Act 1979 or section 2 Sale and Supply of Goods and Services Act 1982;

14.2.2 For personal injury or death resulting from the Company's negligence;

14.2.3 Under section 2(3) Consumer Protection Act 1987;

14.2.4 For any matter which it would be illegal for the Company to exclude (or to attempt to exclude) its liability; or;

14.2.5 For fraud.

15. PROPER LAW

These Terms and Condition and any Contract shall be governed by and construed according to the law of England and the Customer submits to the jurisdiction of the English courts. These Terms and Conditions will prevail over any conditions that shall be issued by the customer. Customers should not rely on any representations made by staff of the Company as they do not form part of the Contract or collateral contract.

16. CUSTOMERS DEALING AS CONSUMERS

Where a Customer 'deals as a consumer' as defined in Section 12(1) of the Unfair Contract Terms Act 1977 (as amended) these Terms and Conditions are subject to the Consumer's statutory rights, including but not limited to the Consumer Protection (Distance Selling) Regulations 2000. The Company shall in no way be entitled to exclude or limit such statutory rights.

17. COLOUR REPRODUCTION

Our designers take great care when publishing this catalogue, however the limitations of printing may mean slight variation in the colour shown.

18. COMPANY DETAILS

Trading as:
Countrywide Healthcare Supplies Ltd., National Distribution Centre, Ferry Moor Way, Park Spring Road, Grimethorpe, Barnsley S72 7BN

VAT Number: 647663209

Company Registered Number: 3209242



 Countrywide
Interiors

IMPROVING EVERYDAY LIFE THROUGH
THE USE OF CONSIDERED DESIGN

COUNTRYWIDEHEALTHCARE.CO.UK



insider
George home
Outdoor living



CONTENTS

PAGE 11	BEDROOM FURNITURE
PAGE 27	BEDROOM SPECIALIST FURNITURE
PAGE 30	BATHROOM CABINETS
PAGE 31	LOUNGE FURNITURE
PAGE 37	OCCASIONAL, LOUNGE & DINING TABLES
PAGE 39	UPHOLSTERED FURNITURE
PAGE 55	XTREME & SPECIALIST SEATING
PAGE 61	UPHOLSTERY & WOOD FINISHES
PAGE 67	LAMPS, WATCHES & CLOCKS
PAGE 68	SAFES, NOTICE & WHITE BOARDS
PAGE 70	OFFICE STORAGE, DESKS & CHAIRS
PAGE 75	LOCKERS
PAGE 77	INDEX

At Countrywide Interiors
we are determined to offer
much more as standard.

- Professional Interior Design Service
- Bespoke Furniture Manufacture
- Seating and Tables
- Bedroom Furniture, Beds and Bedding
- Window Dressings
- Wall Art
- Plants
- Finishing Touches
- Daily Consumables
- One Stop Shop and much more...

It all adds up to much more
for your budget

We'd love to talk to you,
call our projects team on

01226 982454

projects@countrywidehealthcare.co.uk















Testimonial

We have worked closely with Countrywide Healthcare for the past 10 years. They have become our preferred FF & E provider for our Luxury Care Home new build & refurbishment projects.

Working with Countrywide over the past 10 years has given us the comfort of knowing that the whole process of providing a turnkey solution for our clients will be done efficiently, on time, and within the agreed budgets.

Countrywide, through their Projects team, have regularly pulled out all the stops to achieve sometimes the unachievable & we cannot recommend them highly enough!

Gill Jackson
Healthcare Consultants





Cadiz Bedroom



Image shows Truffle Oak Colour Option



Image shows Bavarian Beech Colour Option

Don't Forget
When Ordering
Please State
Wood Finish

Our
**BEST
SELLER**
★★★★★

5 YEARS
Furniture
Guarantee

WOOD COLOUR OPTIONS



Lissa Oak (O)



Sand Beech (SB)



Opera Walnut (OW)



Mountain Oak (MO)



Truffle Oak (T0)



Maple (MA)



Bavarian Beech (B)



Image shows Truffle Oak Colour Option



UA-5265
BEDSIDE 1
DRAWER

h	w	d
645	465	450



UA-5266
BEDSIDE DOOR
& DRAWER

h	w	d
645	465	450



UA-5277
BEDSIDE 3
DRAWER

h	w	d
645	465	450



UA-5267
28" 3 DRAWER
WIDE CHEST

h	w	d
645	715	540



UA-5268
28" 4 DRAWER
WIDE CHEST

h	w	d
820	715	540



UA-5269
40" DRESSING
TABLE / DESK

h	w	d
760	1200	450



UA-5278
SINGLE
WARDROBE

h	w	d
1820	465	540



UA-5270
30" DOUBLE
WARDROBE

h	w	d
1820	775	540



UA-5271
30" GENTS
WARDROBE

h	w	d
1820	775	540



UA-5272
36" COMBI
WARDROBE

h	w	d
1820	915	540



UA-5273
30" TOPBOX

h	w	d
430	775	540

UA-5274
36" TOPBOX

h	w	d
430	915	540

FEATURES AND BENEFITS



Glued, dowelled
and screwed



Large visual all
metal handles



Designed for
contract



Quality
fittings



15mm
Solid backs
to all units



Manufactured in
the UK



Durable
hanging rail



110° hinges



Optional locks



5 years
furniture
guarantee



Metal sided
drawer boxes



Tested to BS 4875
Part 7 Level 4



Tested to BS 4875
Part 8

Don't Forget
When Ordering
Please State
Wood Finish

Hartford Bedroom



Don't Forget
When Ordering
Please State
Wood Finish

5 YEARS
Furniture
Guarantee

Image shows Lava Oak and Cashmere Colour Option

WOOD COLOUR OPTIONS

Matching or contrasting fronts & tops



Mountain Oak **(MO)**



Mussel **(M)**



Alby Blue **(AB)**



Cashmere **(CS)**



Lava Oak **(LO)**



Graphite **(GO)**



Stone Gray **(SG)**



Image shows Mountain Oak & Mussel Colour Option



Image shows Mountain Oak & Mussel Colour Option



Image shows Mountain Oak Colour Option



FEATURES AND BENEFITS

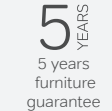
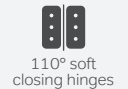
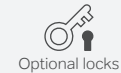
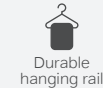
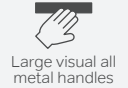

Don't Forget
When Ordering
Please State
Wood Finish

Madrid Bedroom



Don't Forget
When Ordering
Please State
Wood Finish

5 YEARS
Furniture
Guarantee

Image shows Medium Oak Colour Option



Image shows Elm Colour Option



Image shows Elm Colour Option

WOOD COLOUR OPTIONS



Lissa Oak **(LO)**



Medium Oak **(MEO)**



Maple **(M)**



Sand Beech **(SB)**



Opera Walnut **(OW)**



Elm **(E)**



Bavarian Beech **(B)**



UA-7100
BEDSIDE 1
DRAWER

h	w	d
645	465	450



UA-7101
BEDSIDE DOOR
& DRAWER

h	w	d
645	465	450



UA-7116
BEDSIDE 3
DRAWER

h	w	d
645	465	450



UA-7102
28" 3 DRAWER
WIDE CHEST

h	w	d
645	720	540



UA-7103
24" 4 DRAWER
WIDE CHEST

h	w	d
820	720	540



UA-7104
DRESSING TABLE
WITH SHELF

h	w	d
760	1200	460



UA-7115
SINGLE
WARDROBE

h	w	d
1820	470	540



UA-7106
30" DOUBLE
WARDROBE

h	w	d
1820	780	540



UA-7107
30" GENTS
WARDROBE

h	w	d
1820	780	540



UA-7108
36" COMBI
WARDROBE

h	w	d
1820	920	540



UA-7110
30" TOPBOX

h	w	d
430	780	540

UA-7111
36" TOPBOX

h	w	d
430	920	540

FEATURES AND BENEFITS



Glued, dowelled
and screwed



Large visual all
metal handles



Designed for
contract



Quality
fittings



15mm
Solid backs
to all units



Manufactured
in the UK



Durable
hanging rail



Tested to BS 4875
Part 7 Level 4



Metal sided
drawer boxes



Tested to BS 4875
Part 8



Soft rounded
corners



170° hinges



Optional locks



Anti microbial
finishing
lacquers



5 years
furniture
guarantee

Don't Forget
When Ordering
Please State
Wood Finish

Tuscany Bedroom



Don't Forget
When Ordering
Please State
Wood Finish

5 YEARS
Furniture
Guarantee

Image shows Elm and Cream Colour Option



Image shows Medium Oak Colour Option



Image shows Elm Colour Option

WOOD COLOUR OPTIONS



Lissa Oak (LO)



Medium Oak (MEO)



Sand Beech (SB)



Opera Walnut (OW)



Elm (E)

CONTRASTING COLOUR



Cream (CF)

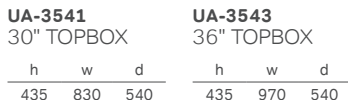

FEATURES AND BENEFITS

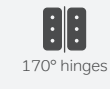
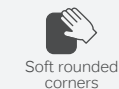
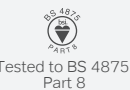
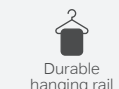
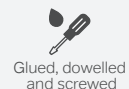

Don't Forget
When Ordering
Please State
Wood Finish



Ivy Bedroom



Don't Forget
When Ordering
Please State
Wood Finish

5 YEARS
Furniture
Guarantee

Image shows Alby Blue Colour Option



Image shows Mussel and Cashmere Colour Option

WOOD COLOUR OPTIONS

Matching or contrasting fronts & tops



Mountain Oak (MO)



Mussel (MF)



Cashmere (CS)



Alby Blue (AB)



Lava Oak (LO)



Graphite (GO)



Stone Grey (SG)



Image shows Stone Grey Option



UA-7400
BEDSIDE 1
DRAWER

h	w	d
650	540	460



UA-7401
BEDSIDE DOOR
& DRAWER

h	w	d
650	540	460



UA-7402
BEDSIDE
3 DRAWER

h	w	d
650	540	460



UA-7403
DRESSING
TABLE

h	w	d
765	1270	460



UA-7404
28" 3 DRAWER
WIDE CHEST

h	w	d
765	790	545



UA-7405
28" 4 DRAWER
WIDE CHEST

h	w	d
975	790	545



UA-7406
30" GENTS
TOPBOX

h	w	d
435	850	545



UA-7407
36" COMBI
TOPBOX

h	w	d
435	990	545



UA-7408
SINGLE
WARDROBE

h	w	d
1825	540	545



UA-7409
30" DOUBLE
WARDROBE

h	w	d
1825	850	545



UA-7410
30" GENTS
WARDROBE

h	w	d
1825	850	545



UA-7411
36" COMBI
WARDROBE

h	w	d
1825	990	545

FEATURES AND BENEFITS



Glued, dowelled
and screwed



Large visual all
metal handles



Designed for
contract



Quality
fittings



15mm
Solid backs
to all units



Manufactured
in the UK



Durable
hanging rail



110° hinges



Optional locks



5 years
furniture
guarantee



Metal sided
drawer boxes



Soft rounded
corners



Feature panelled
doors and
drawer fronts

Don't Forget
When Ordering
Please State
Wood Finish

Eden Bedroom



Don't Forget
When Ordering
Please State
Wood Finish

5 YEARS
Furniture
Guarantee

Image shows Sand Beech Colour Option



Image shows Opera Walnut and Cream Colour Option



Image shows Opera Walnut and Cream Colour Option

WOOD COLOUR OPTIONS



Lissa Oak **(LO)**



Medium Oak **(MEO)**



Sand Beech **(SB)**



Opera Walnut **(OW)**



Elm **(E)**

CONTRASTING COLOUR



Cream **(CF)**



White **(W)**

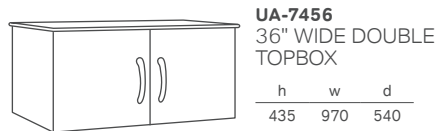
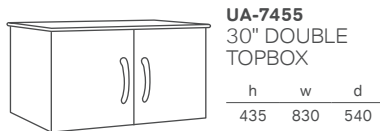
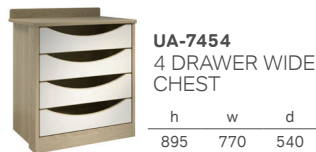

FEATURES AND BENEFITS

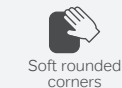

Don't Forget
When Ordering
Please State
Wood Finish

5 YEARS
5 years furniture guarantee

Evoked Bedroom



Don't Forget
When Ordering
Please State
Wood Finish

5 YEARS
Furniture
Guarantee

Image shows Bavarian Beech Colour Option



Image shows Bavarian Beech and White Colour Option

WOOD COLOUR OPTIONS



Lissa Oak (LO)



Medium Oak (MEO)



Sand Beech (SB)



Opera Walnut (OW)



Bavarian Beech (B)



Elm (E)

CONTRASTING COLOUR



Cream (CF)



White (W)



Image shows Lissa Oak Colour Option



UA-5175
BEDSIDE DOOR
& DRAWER

h	w	d
715	470	460



UA-5182
DRESSING TABLE
WITH SHELF

h	w	d
830	1200	460



UA-5177
28" 3 DRAWER
WIDE CHEST

h	w	d
715	720	540



UA-5179
28" 4 DRAWER
WIDE CHEST

h	w	d
835	770	460



UA-5190
SINGLE
WARDROBE

h	w	d
1820	620	540



UA-5184
DOUBLE
WARDROBE

h	w	d
1820	780	540



UA-5185
WIDE DOUBLE
WARDROBE

h	w	d
1820	920	540

FEATURES AND BENEFITS



Glued, dowelled
and screwed



Large visual all
metal handles



Designed for
contract



Quality
fittings



15mm
Solid backs
to all units



Manufactured
in the UK



Durable
hanging rail



Tested to BS 4875
Part 7 Level 4



Metal sided
drawer boxes



Tested to BS 4875
Part 8



Soft rounded
corners



170° hinges



Optional locks



Anti microbial
finishing
lacquers



Dementia
Friendly

Don't Forget
When Ordering
Please State
Wood Finish

Harper Bedroom



Don't Forget
When Ordering
Please State
Wood Finish

5 YEARS
Furniture
Guarantee

Image shows Alby Blue and Cashmere Colour Option



Image shows Stone Grey and Mountain Oak Colour Option

WOOD COLOUR OPTIONS



Mountain Oak (MO)



Stone Grey (SG)



Cashmere (CS)



Lava Oak (LO)



Alby Blue (AB)



Graphite (GO)



Mussel (MF)



Image shows Mountain Oak and Mussel Colour Option



UA-7470
BEDSIDE DOOR
& DRAWER

h	w	d
740	550	505



UA-7471
BEDSIDE 3
DRAWER

h	w	d
740	550	505



UA-7472
3 DRAWER
WIDE CHEST

h	w	d
855	800	505



UA-7473
4 DRAWER
WIDE CHEST

h	w	d
1065	800	505



UA-7474
DRESSING TABLE

h	w	d
855	1320	505



UA-7475
30" DOUBLE
TOPBOX

h	w	d
435	860	585



UA-7476
36" DOUBLE
TOPBOX

h	w	d
435	1000	585



UA-7477
SINGLE
WARDROBE

h	w	d
1845	860	585



UA-7478
GENTS
WARDROBE

h	w	d
1845	860	585



UA-7479
WIDE DOUBLE
WARDROBE

h	w	d
1845	1000	585

FEATURES AND BENEFITS



Glued, doweled
and screwed



Large visual all
metal handles



Designed for
contract



Quality
fittings



15mm
Solid backs
to all units



**UK
MADE**
Manufactured
in the UK



Durable
hanging rail



Dementia
Friendly



Metal sided
drawer boxes



Feature panelled
doors and
drawer fronts



Soft rounded
corners



170° hinges



Optional locks



Anti microbial
finishing
lacquers

Don't Forget
When Ordering
Please State
Wood Finish

Xtreme Anti Ligature Bedroom



Don't Forget
When Ordering
Please State
Wood Finish

5 YEARS
Furniture
Guarantee

Image shows Light Oak Colour Option

XTREME HIGH DEPENDENCY

BOXED IN BED

- Integral head and foot ends with smooth rounded corners
- Reinforced by internal linings and suitable to be fixed to floor
- Due to the sheer weight of the bed we deliver in 2 sections which need to be fastened together



**2 PIECE
BOXED BED**
with integral
headboard

UA-9640

h	w	d
500	960	1950

DELIVERY
3 to 4
Weeks

WOOD COLOUR OPTIONS



Lissa Oak (O)



Elm (E)



Medium Oak (MEO)



UA-9641
SKI BED - METAL
WITH FRAME

h	w	d
430	950	1950



UA-9652
GENTS
ANTI-LIGATURE
WARDROBE

h	w	d
1825	820	640



UA-9629
SLOPING TOP
(ANTI CLIMB)

h	w	d
255	820	620

XTREME MATTRESS

- Full foam divan depth mattress designed for use with our Xtreme bed
- Enclosed in a vapour permeable cover fire retardant to Crib 5 BS7177
- Welded to 3 sides and stitched to the 4th side

ED-4012

h	w	d
1900	910	190





UA-9635
BEDSIDE WITH
LOCKING
DRAWER

h	w	d
685	485	545



UA-9636
BEDSIDE 3
DRAWER WITH
LOCKING TOP
DRAWER

h	w	d
685	485	545



UA-9630
3 DRAWER
CHEST

h	w	d
685	780	545



UA-9631
4 DRAWER
CHEST

h	w	d
890	780	545



UA-9638
DESK WITH
3 DRAWER
PEDESTAL

h	w	d
745	1200	545



UA-9648
SINGLE
WARDROBE

h	w	d
1825	520	640



UA-9648
SINGLE ANTI-LIGATURE
WARDROBE

h	w	d
1825	620	620



UA-9626
DOUBLE ANTI-LIGATURE
WARDROBE

h	w	d
1825	820	620



UA-9644
BOOKSHELF

h	w	d
600	600	280



UA-9650
GENTS
WARDROBE

h	w	d
1825	820	640



UA-9649
DOUBLE
WARDROBE

h	w	d
1825	820	640

FEATURES AND BENEFITS

Meets the demands of most challenging environments by reducing the risk of self harm. Its design will help create a more domestic feel enhancing the clients rehabilitation.

Safety features include:

- Scoop handles
- Fixed drawers
- Sloping wardrobe door
- Piano hinge to wardrobe
- Smooth profile edges
- 18mm solid backs

Optional extras:

- Anti climb sloping top for wardrobe
- Wall fixed headboard suitable for blind fixings (not supplied)
- Semi-curved bookshelf
- Metal ski bed with welded mesh mattress platform - see our Xtreme high dependency furniture for the option of a boxed in bed



Tested to BS 4875
Part 7 Level 4



Tested to BS 4875
Part 8

**UK
MADE**

Manufactured
in the UK

Don't Forget
When Ordering
Please State
Wood Finish

Headboards



M	SB	MF	CS
B	O	OUO	
TO	LO	E	
MEO	OW	MO	

CLASSIC - MFC:

- MFC panel with 2mm ABS liping to all edges
- Includes struts to attach to the bed
- Easy to wipe clean and maintain

SINGLE	h	w	DOUBLE	h	w
UA-4790	515	915	UA-4791	515	1380



M	O
B	OW
MEO	E
SB	

ARCHED CLASSIC - MFC:

- Melamine faced MDF panel
- Contoured arch design with smooth edges
- Includes struts to attach to the bed
- Easy to wipe clean and maintain

SINGLE	h	w	DOUBLE	h	w
UA-4792	515	915	UA-4793	515	1380

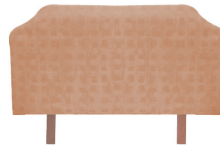

BA-1140 - GRANBY HEADBOARD:

- Padded and covered in a FR anti bacterial water resistant fabric
- Colour: Libra Gold
- Single
- 515h x 915w



TO	LO	MO
SG	OW	CS
SB	MF	AB
O	OUO	GO

FLAX - MDF:

- 18mm vinyl pressed MDF panel
- Simple flat design
- Includes struts to attach the headboard to the bed

SINGLE	h	w	DOUBLE	h	w
UA-4794	515	915	UA-4795	515	1380



TO	LO	MO
SG	OW	CS
SB	MF	AB
O	OUO	GO

FLAX ARCHED - MDF:

- Melamine faced MDF panel
- Contoured arch design with smooth edges
- Includes struts to attach to the bed
- Easy to wipe clean and maintain

SINGLE	h	w	DOUBLE	h	w
UA-4796	515	915	UA-4797	515	1380

WOOD COLOUR OPTIONS:



Maple (M)



Medium Oak (MEO)



Lava Oak (LO)



Bavarian Beech (B)



Mountain Oak (MO)



Opera Walnut (OW)



Lissa Oak (O)



Cashmere (CS)



Elm (E)



Alby Blue (AB)



Truffle Oak (TO)



Oyster Urban Oak (OUO)



Mussel (MF)



Stone Grey (SG)



Sand Beech (SB)



Graphite (GO)

Bathroom Cabinets

DOUBLE DOOR BATHROOM CABINET WITH LOCK AND MIRROR



FEATURES INCLUDE:

- Lockable door
- Mirror
- Double door



This item is available with Polycarbonate mirror. Please contact us for additional details

CABINET WITH MIRROR UA-6000

h	w	d
400	600	220

CABINET WITHOUT MIRROR UA-6001

h	w	d
400	600	220



XTREME BATHROOM CABINET WITH LOCK

Meets the demands of most challenging environments by reducing the risk of self harm.

FEATURES INCLUDE:

- Lockable door
- 2 Shelves

UA-6004

h	w	d
570	390	170

SINGLE DOOR BATHROOM CABINET WITH LOCK AND MIRROR



This item is available with Polycarbonate mirror. Please contact us for additional details

FEATURES INCLUDE:

- Lockable door
- Mirror
- Single door

CABINET WITH MIRROR UA-6002

h	w	d
400	300	220

CABINET WITHOUT MIRROR UA-6003

h	w	d
400	300	220



MEDICINE CABINET

- Mirrored glass sliding door with 160 degrees pivot hinge, increases accessibility
- Secure locking system for storage of medicines, keys supplied
- Fixed internal stainless steel shelf
- Supplied fully assembled
- Easy to install, all fixtures and fittings included

UA-6006

h	w	d
400	130	250

WOOD COLOUR OPTIONS



Truffle Oak (TO)



Lava Oak (LO)



Maple (M)



Opera Walnut (OW)



Mountain Oak (MO)

Harbury Lounge



Don't Forget
When Ordering
Please State
Wood Finish

5 YEARS
Furniture
Guarantee

Image shows Truffle Oak Colour Option

WOOD COLOUR OPTIONS



Lissa Oak (O)



Truffle Oak (TO)



Opera Walnut (OW)



Image shows Lissa Oak Colour Option



Image shows Lissa Oak Colour Option



UA-2000
SIDE BOARD

h	w	d
875	1000	520



UA-2001
DRESSER /
BOOKCASE

h	w	d
925	1000	340



UA-2003
TALL BOOKCASE

h	w	d
1800	800	340



UA-2005
CONSOLE TABLE
WITH DRAWERS

h	w	d
925	1000	400



UA-2002
WIDE TV UNIT

h	w	d
670	1300	450



UA-2004
SQUARE
COFFEE TABLE

h	w	d
450	600	600

FEATURES AND BENEFITS



Glued, dowelled
and screwed



Designed for
contract



15mm
Solid backs
to all units



Optional locks



110° soft
closing hinges



Large visual all
metal handles



5
YEARS
5 years
furniture
guarantee



**UK
MADE**
Manufactured
in the UK

Don't Forget
When Ordering
Please State
Wood Finish

Bronte Lounge



Don't Forget
When Ordering
Please State
Wood Finish

5 YEARS
Furniture
Guarantee

Image shows Oyster Urban Oak Colour Option

WOOD COLOUR OPTIONS



Mountain Oak (MO)



Lava Oak (LO)



Oyster Urban Oak (OUO)



Image shows Lava Oak Colour Option



Image shows Mountain Oak Colour Option



Image shows Lava Oak Colour Option



UA-0730
SIDE BOARD

h	w	d
905	1070	570



UA-0731
DRESSER /
BOOKCASE

h	w	d
920	1070	365



UA-9708
CONSOLE TABLE
WITH DRAWERS

h	w	d
905	1070	425



UA-0722
TALL
BOOKCASE

h	w	d
1825	870	365



UA-0732
SLIM COMBI
BOOKCASE

h	w	d
1825	580	425



UA-0733
SMALL TV UNIT

h	w	d
705	870	500



UA-0734
WIDE TV UNIT

h	w	d
705	1360	500



UA-0721
SIDE TABLE

h	w	d
625	600	600



UA-0728
SQUARE
COFFEE TABLE

h	w	d
475	600	600



UA-0725
RECTANGLE
COFFEE TABLE

h	w	d
475	900	500

FEATURES AND BENEFITS



Glued, dowelled
and screwed



Designed for
contract



15mm
Solid backs
to all units



Optional locks



110° soft
closing hinges



Large visual all
metal handles



Metal sided
drawer boxes



Soft rounded
corners



5 YEARS
5 years
furniture
guarantee



**UK
MADE**
Manufactured
in the UK

Don't Forget
When Ordering
Please State
Wood Finish

Dorset Lounge



Don't Forget
When Ordering
Please State
Wood Finish

5 YEARS
Furniture
Guarantee

Image shows Mountain Oak and Mussel Colour Option



Image shows Mountain Oak and Colour Option



Image shows Mountain Oak and Stone Grey Colour Option

WOOD COLOUR OPTIONS

Matching or contrasting fronts & tops



Mountain Oak (MO)



Mussel (MF)



Cashmere (CS)



Alby Blue (AB)



Lava Oak (LO)



Graphite (GO)



Stone Grey (SG)



UA-6100
SIDE BOARD

h	w	d
875	1070	545



UA-6101
DRESSER /
BOOKCASE

h	w	d
925	1070	365



UA-6102
CONSOLE TABLE
WITH DRAWERS

h	w	d
925	1070	425



UA-6103
SMALL
BOOKCASE

h	w	d
925	870	365



UA-6104
TALL
BOOKCASE

h	w	d
1800	870	365



UA-6105
SMALL TV UNIT

h	w	d
700	870	475



UA-6106
WIDE TV UNIT

h	w	d
700	1340	475



UA-6107
SQUARE
COFFEE TABLE

h	w	d
450	600	600



UA-6108
RECTANGLE
COFFEE TABLE

h	w	d
450	1000	600

FEATURES AND BENEFITS



Glued, dowelled
and screwed



Designed for
contract



15mm
Solid backs
to all units



Optional locks



110° soft
closing hinges



Large visual all
metal handles



Metal sided
drawer boxes



Soft rounded
corners



5
YEARS
5 years
furniture
guarantee



Feature panelled
doors and
drawer fronts



Manufactured
in the UK

Don't Forget
When Ordering
Please State
Wood Finish

Ripon Tables

RIPON - LOW COFFEE TABLE

Profiled rounded edges to suit all areas throughout your care home.



UA-9903



UA-9909-OV Oval

UA-9909-RT Rectangular



LINCOLN - NEST OF 3 TABLES UA-6010



LEG OPTIONS



SQUARE

TAPER

RIPON DINING

ROUND / SQUARE

UA-9012



UA-9013



UA-9014



RECTANGULAR

UA-9017



UA-9015



UA-9016



RIPON - HIGH COFFEE TABLE

Ideal height to sit alongside a lounge chair, allowing the user to place or reach objects on the table without having to bend down.

UA-9895



DELIVERY 4 TO 6 WEEKS
Upholstery options pg 61-64
Wood colour options pg 65



Dining Tables

AREZZO DINING



ROUND / SQUARE

UA-9253



UA-9254



UA-9255

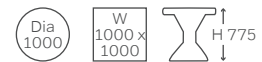

RECTANGULAR DINING TABLE



UA-9256



Dining Chairs

Available in a range of upholstery fabrics



DENBY

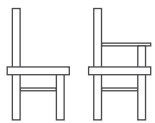

Chair With Arms

UA-9987 - Chair
UA-9989 - Chair with Arms

h	w	d	sh
940	480	540	510



ST IVES



With Arms

UA-6600 - Chair with Arms

h	w	d	sh
940	560	540	480



ELSIE

UA-6200

h	w	d	sh
760	590	610	460



With Arms



IRWIN

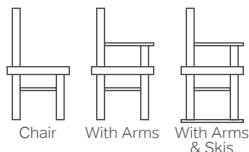

Chair With Arms With Arms & Skis

UA-6604 - Chair
UA-6605 - Chair with Arms
UA-6603 - Chair with Arms & Skis

h	w	d	sh
890	600	590	470



TUDOR

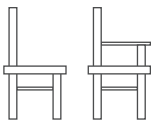

Chair With Arms

UA-9215 - Chair

h	w	d	sh
980	580	580	490

UA-9216 - Chair with Arms

h	w	d	sh
980	580	610	490



MILLIE

UA-6201

Chair with Arms

h	w	d	sh
850	545	535	480



With Arms

Our
BEST
SELLER
★★★★★



DELIVERY 4 TO 6 WEEKS
Upholstery options pg 61-64
Wood colour options pg 65



SKYE

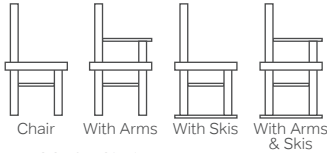

UA-3618 - Chair

h	w	d	sh
975	460	560	490

UA-3620 - Chair with Arms

h	w	d	sh
975	530	560	490

UA-3619 - Chair with Skis

h	w	d	sh
975	460	560	490

UA-3621 - Chair with Arms & Skis

h	w	d	sh
975	530	560	490



Our
BEST
SELLER
★★★★

APPLEBY

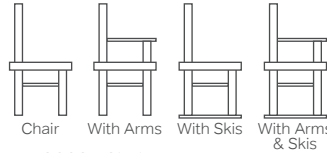

UA-9023 - Chair

h	w	d	sh
840	505	520	460

UA-9075 - Chair with Arms

h	w	d	sh
840	530	520	460

UA-9024 - Chair with Skis

h	w	d	sh
840	505	520	460

UA-9076 - Chair with Arms & Skis

h	w	d	sh
840	530	520	460



Our
BEST
SELLER
★★★★

MALTBY

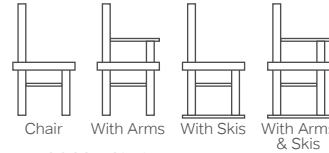

UA-9063 - Chair

h	w	d	sh
840	520	520	490

UA-9064 - Chair with Arms

h	w	d	sh
840	555	580	490

UA-9062 - Chair with Skis

h	w	d	sh
840	520	520	490

UA-9065 - Chair with Arms & Skis

h	w	d	sh
840	555	580	490



BRAMLEY

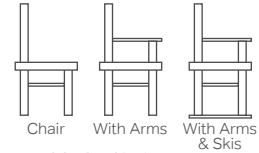

UA-9910 - Chair

h	w	d	sh
855	490	530	510

UA-9911 - Chair with Arms

h	w	d	sh
855	570	540	510

UA-9912 - Chair with Arms & Skis

h	w	d	sh
855	570	540	510



DELIVERY 4 TO 6 WEEKS
Upholstery options pg 61-64
Wood colour options pg 65



2 Way fabric Options

Mix & Match fabric for ease of cleaning and longevity of furniture



Example Option J

Don't Forget
When Ordering
Please State
Upholstery
Fabric

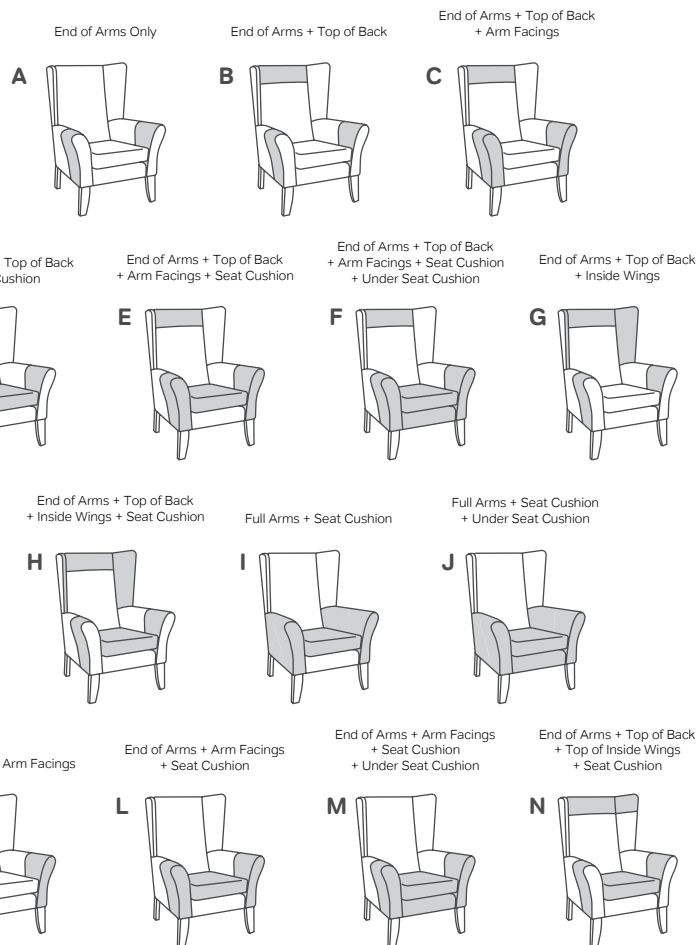

DELIVERY 4 TO 6 WEEKS
Upholstery options pg 61-64
Wood colour options pg 65

Upholstered Furniture

Available in a range of upholstery fabrics



DOVER
UA-9031

h	w	d	sh
800	530	630	470



DRIFT
UA-6610

h	w	d	sh
800	600	630	450



DEAL
UA-9032

h	w	d	sh
830	610	650	480



DARLEY
UA-5810

h	w	d	sh
810	770	680	500



DERBY
UA-7207

h	w	d	sh
720	700	700	415



DARTMOUTH
UA-5815

h	w	d	sh
800	760	640	510

Don't Forget
When Ordering
Please State
Upholstery
Fabric



DELIVERY 4 TO 6 WEEKS
Upholstery options pg 61-64
Wood colour options pg 65



LISBON

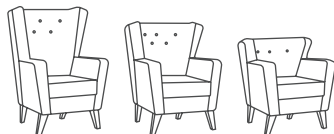

High Back Mid Back Low Back

UA-2006 - Low Back

h	w	d	sh
970	810	850	480

UA-2007 - Mid Back

h	w	d	sh
840	780	830	480

UA-3619 - High Back

h	w	d	sh
1110	840	870	480



ALNWICK

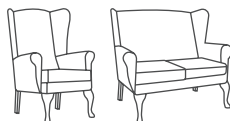

Chair 2 Seater

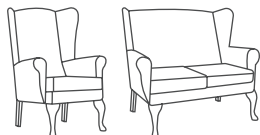

High Back 2 Seater High Back

UA-9009 - Chair

h	w	d	sh
980	720	765	460

UA-3329 - 2 Seater

h	w	d	sh
980	1230	765	460



LAUREL



UA-9258 - Chair

h	w	d	sh
1070	850	720	500

UA-7214 - High Back

h	w	d	sh
1050	720	780	460

UA-7215 - 2 Seater High Back

h	w	d	sh
1050	1230	780	460



Don't Forget
When Ordering
Please State
Upholstery
Fabric



DELIVERY 4 TO 6 WEEKS
Upholstery options pg 61-64
Wood colour options pg 65

Haven Chair



Don't Forget
When Ordering
Please State
Upholstery
Fabric



Cream vinyl stocked for delivery within 7 days

CHAIR WITH WINGS
UA-2009

CHAIR WITHOUT WINGS
UA-2010

h	w	d	sh
970	700	780	460

Our
BEST
SELLER
★★★★★



DELIVERY 4 TO 6 WEEKS
Upholstery options pg 61-64
Wood colour options pg 65



WORCESTER
UA-6618

h	w	d	sh
1070	770	770	480



REED
UA-6620

h	w	d	sh
970	780	820	480



CANOVA
UA-6621

h	w	d	sh
1100	800	840	490



TORONTO
UA-6622

h	w	d	sh
1100	800	840	490



HARDWICK
UA-6619

h	w	d	sh
1100	900	860	470



COMPLETE THE LOOK
With a matching foot stool



FOOTSTOOL
UA-7218

h	w	d
390	550	410



KEEL - Chair
UA-7235

h	w	d	sh
990	770	770	460



KEEL - 2 Seater
UA-7236

h	w	d	sh
990	1280	770	460



KEEL - Chair with wings
UA-7216

h	w	d	sh
990	770	770	460

KEEL - 2 Seater with wings
UA-7217

h	w	d	sh
990	1280	770	460

Don't Forget
When Ordering
Please State
Upholstery
Fabric.

 **DELIVERY 4 TO 6 WEEKS**
Upholstery options pg 61-64
Wood colour options pg 65



COMPLETE THE LOOK
With a matching foot stool

**ASHBY - Chair Medium Back
UA-6705**

h	w	d	sh
850	760	770	490

**ASHBY - Chair High back
UA-6706**

h	w	d	sh
1040	760	830	490

**FOOTSTOOL
UA-7218**

h	w	d
390	550	410



**LEWIS - Chair Medium Back
UA-9045**

h	w	d	sh
920	710	680	490

**LEWIS - Chair High back
UA-9044**

h	w	d	sh
1070	710	700	490

Don't Forget
When Ordering
Please Slate
Upholstery
Fabric



DELIVERY 4 TO 6 WEEKS
Upholstery options pg 61-64
Wood colour options pg 65



TAUNTON
UA-6624

h	w	d	sh
970	740	840	460



RICHMOND
UA-6625

h	w	d	sh
1000	860	810	500



CHATSWORTH Medium Back
UA-6626

h	w	d	sh
1020	850	700	470



WILTSHIRE Medium Back
UA-9233

h	w	d	sh
950	860	840	490



WILTSHIRE High Back
UA-9234

h	w	d	sh
1100	860	840	490



CHESTER High Back
UA-6627

h	w	d	sh
1060	850	710	500



OXFORD
UA-1232

h	w	d	sh
965	770	840	460



Don't Forget
When Ordering
Please State
Upholstery
Fabric



DELIVERY 4 TO 6 WEEKS
Upholstery options pg 61-64
Wood colour options pg 65

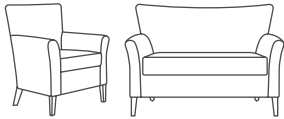

ASHTON Medium Back
UA-5825

h	w	d	sh
910	780	730	490

ASHTON 2 Seater
UA-5826

h	w	d	sh
910	1290	730	490

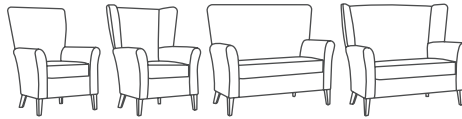

HOWDEN Chair
UA-6700

h	w	d	sh
1060	780	750	490

HOWDEN Chair with wings
UA-6701

h	w	d	sh
1060	780	750	490

HOWDEN 2 Seater
UA-6702

h	w	d	sh
1060	1290	750	490

HOWDEN 2 Seater with wings
UA-6704

h	w	d	sh
1060	1340	750	490



SUTTON Chair
UA-9111

h	w	d	sh
930	910	915	485

SUTTON 3 Seater
UA-9113

h	w	d	sh
930	1880	915	485

SUTTON 2 Seater
UA-9112

h	w	d	sh
930	1420	915	485

Don't Forget
When Ordering
Please State
Upholstery
Fabric



DELIVERY 4 TO 6 WEEKS
Upholstery options pg 61-64
Wood colour options pg 65



Don't Forget
When Ordering
Please State
Upholstery
Fabric

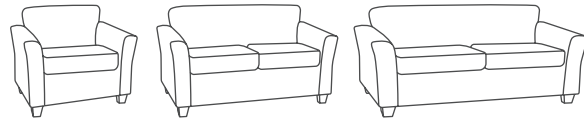

HUDSON Chair
UA-6643

h	w	d	sh
850	950	900	460

HUDSON 2 Seater
UA-6644

h	w	d	sh
850	1460	900	460

HUDSON 3 Seater
UA-6645

h	w	d	sh
850	1950	900	460



DELIVERY 4 TO 6 WEEKS
Upholstery options pg 61-64
Wood colour options pg 65

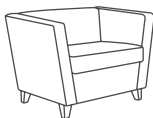

SELBY Chair
UA-7225

h	w	d	sh
750	860	780	480

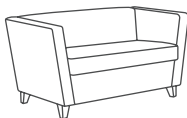

SELBY 2 Seater
UA-7226

h	w	d	sh
750	1370	780	480

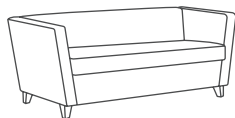

SELBY 3 Seater
UA-7227

h	w	d	sh
750	1830	780	480



TURIN Chair
UA-9247

h	w	d	sh
940	1220	920	430



TURIN 2 Seater
UA-9248

h	w	d	sh
940	1730	920	430

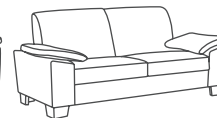

TURIN 3 Seater
UA-9249

h	w	d	sh
940	2650	920	430

TURIN Corner Seater
UA-9250

h	w	d	sh
370	233	360	430



Don't Forget
When Ordering
Please State
Upholstery
Fabric



DELIVERY 4 TO 6 WEEKS
Upholstery options pg 61-64
Wood colour options pg 65



STOCKTON Chair
UA-9265

h	w	d	sh
880	850	900	480

STOCKTON 2 Seater
UA-9266

h	w	d	sh
880	1300	900	480

STOCKTON 3 Seater
UA-9267

h	w	d	sh
880	1850	900	480

Don't Forget
When Ordering
Please State
Upholstery
Fabric



DELIVERY 4 TO 6 WEEKS
Upholstery options pg 61-64
Wood colour options pg 65

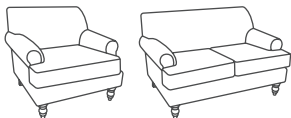

FARROW Chair
UA-6633

h	w	d	sh
870	970	900	430

FARROW 2 Seater
UA-6634

h	w	d	sh
870	1680	900	430

FARROW 3 Seater
UA-6635

h	w	d	sh
870	1950	900	430

Don't Forget
When Ordering
Please State
Upholstery
Fabric



DARTMOUTH Chair
UA-5815

h	w	d	sh
800	760	915	510

DARTMOUTH 2 Seater
UA-5814

h	w	d	sh
800	1250	915	510

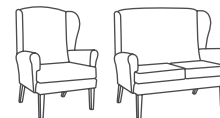

HARLEY Chair
UA-6630

h	w	d	sh
1020	700	770	480

HARLEY 2 Seater
UA-6631

h	w	d	sh
1020	1160	770	480

HARLEY 3 Seater
UA-6632

h	w	d	sh
1020	1720	770	480



DELIVERY 4 TO 6 WEEKS
Upholstery options pg 61-64
Wood colour options pg 65

High Dependency

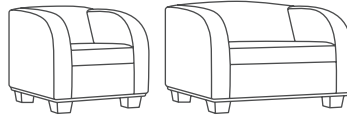

BELMONT Chair
UA-9804

h	w	d	sh
730	815	820	480

BELMONT 2 Seater
UA-9805

h	w	d	sh
730	1325	820	480

XTREME HIGH DEPENDENCY

A range of contemporary styles, reinforced with the addition of boarded out sides, solid seat base and backs. This adds weight to the piece discouraging abuse and movement by your client group.

Anti tamper and concealed staples.

Don't Forget
When Ordering
Please State
Upholstery
Fabric



DAWLISH Chair
UA-9810

h	w	d	sh
800	760	660	530

LINTON Chair
UA-9107

h	w	d	sh
960	860	900	530

LINTON 2 Seater
UA-9109

h	w	d	sh
960	1370	900	530

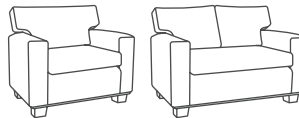

DELIVERY 4 TO 6 WEEKS
Upholstery options pg 61-64
Wood colour options pg 65

Brentwood Chair



The Brentwood features a waterfall back which gives a versatile ergonomic adjustment to the back cushions. Available in a full range of upholstery.



Dimensions: Standard
787w x 838d x 457sh x 508sw x 508 sd

Max
User
Weight

Brentwood Manual Recliner	UA-7600	120kg
Brentwood Electric Single Motor Recliner	UA-7601	120kg
Brentwood Electric Single Motor Tilt-in-Space Recliner	UA-7603	160kg
Brentwood Electric Dual Motor Recliner	UA-7602	120kg

Our
**BEST
SELLER**

Don't Forget
When Ordering
Please State
Upholstery
Fabric



GREAT VALUE

Installation available upon request
Delivery in 15 working days

Specialist Chairs



Maximum User Weight 158kg

**MARSH Manual Recliner
UA-2158**

h	w	d	sh
1060	830	880	500

**MARSH Electric Rise & Recliner
UA-2160**

h	w	d	sh
1060	830	880	500



Maximum User Weight 158kg

**BANBURY Manual Recliner
UA-2161**

h	w	d	sh
1130	780	855	510

**BANBURY Electric Rise & Recliner
UA-2162**

h	w	d	sh
1130	780	855	510

RECLINERS

The manual recliner is ideal for able bodied users, but if it's independency you require, then take a look at our electric dual motor rise and recline options.

CHAIR POSITIONS

Manual Recliner



Suitable for able bodied users who are capable of applying adequate pressure to activate the mechanism

Electric Rise & Recliner



Rise & recliner options have the benefit of a dual motor allowing the back and footrest to move independently



DELIVERY 4 TO 6 WEEKS
Upholstery options pg 61-64
Wood colour options pg 65

Sherbourne Chair



- Fixed back for controlled support
- Removable duvet seat pad for cleaning or updating rise and recline functions
- Unique 'swift-fit' easy chair assembly and disassembly
- Clean-lined zipped back cover with easy access to motor
- Integrated pressure relief seat pad options
- Available in a full range of upholstery

Accessories included:
Lumbar cushions
10 day battery backup
USB port



Dimensions: Standard
1090h 770w x 830d x 460sh x 510sw
x 510sd

Max
User
Weight

Sherbourne Manual Recliner	UA-7612	120kg
Sherbourne Single Motor Tilt in Space Recliner	UA-7613	120kg

Don't Forget
When Ordering
Please State
Upholstery
Fabric



GREAT VALUE

Installation available upon request
Delivery in 15 working days

Specialist Chairs

SHELLEY RISER RECLINER

The Shelley Riser Recliner is upholstered in modern and luxurious leather, with a dual motor mechanism for flexible support options. The chair has an excellent snooze position for supreme comfort and relaxation, while quiet motor provides a smooth and discreet operation.

- Faux Leather
- Flexible Support
- Quiet Motor
- Safety Key
- Extra Comfort

Dimensions: Standard
1140h x 875w x 970d x 500sh
x 455sw x 520sd

Max User
Weight

Shelley Recliner

UA-2192 150kg

Available in Black & Cream



RIPON RISE AND RECLINE

The Ripon Rise and Recliner Chair is a stylish addition to any living room. The Ripon offers superior comfort and is available in a variety of colours and fabrics and features both lift and recline action. Each chair has an easy to use 2 button control handset.

- Rise and recline
- Petite size
- High quality OKIN Single Motor



Dimensions: Standard
1095h x 720w x 650d x 435sh
x 500sw x 510sd

Max User
Weight

Ripon Rise and Recline

UA-2186 160kg

Available in Pebble Grey



Specialist Chairs

MORGAN RISE AND RECLINE

Our new Morgan model is a unique 3 motor mechanism chair with separate controls for the footboard and backrest and an independent function to operate the Tilt in Space feature.

- 3-motor mechanism
- Independent footboard/Back/tilt in space functions
- 3 tier waterfall back
- All back cushions on velcro
- Traditional scrolled arms
- 2 full-length side pockets
- Loop for wired controller

h	w	d	sh
762	508	508	457

MS-0002



SHELL CHAIR

Suitable for occupants with muscular problems and other special needs

- Velcro attached ergonomically designed headrest, easily adjustable
- Fitted lap belt for additional safety
- Storage pocket on backrest
- 12.5cm break wheels which integrally rotate 360 degrees
- Good hoist access for easy moving and handling
- High risk cushion supplied as standard

Available in sizes of:

- 16" width x 16" depth
- 18" width x 18" depth
- 20" width x 20" depth

Please specify size when placing your order

UA-1045



THE CQR MOBILE CHAIR

Suitable for occupants with muscular problems and other special needs

- Complete with washable lambswool cover
- Fully adjustable leg rest with self locking mechanism
- Lambswool cover delivers pressure relieving capabilities
- Four braked and swivel castors
- Gives maximum occupant comfort and security

CQR CHAIR With lambswool cover UA-1041

h	w	d	sh
970	640	1100	-
(1500 with leg rest extended)			

ADDITIONAL LAMBSWOOL COVER UA-1042



WIMBOURNE CHAIR

A contemporary styled day chair, the Wimbourne is specially designed for healthcare and nursing care environments. Featuring large, easy to manoeuvre wheels with comfortable and sturdy push handles. Built in 7 day battery pack for cable free operation of the smooth tilt-in-space and extending foot rest action.

- Mobile hoist friendly
- Motor tilt in space action
- 7 day remote power unit
- 4 hour quick charge
- Visco elastic pressure relief foam to seat
- Independent operation of the footboard and backrest
- Footrest folds under seat
- Easy to manoeuvre 4 inch diameter castors (braked to rear)
- Push handle to rear
- Wide choice of fabrics
- Optional wings
- Optional lateral supports
- Optional seat cut out for third party
- Available in a full range of upholstery



Dimensions: Standard
1194h 813w x 889d x 457sh x
482sw x 458sd

Max User
Weight

Wimbourne Portable Recliner **UA-7611 120kg**

Specialist Chairs

THE STIRLING

Elegant simplicity ensures the Stirling compliments many different environments; combined with lateral support and the ability to tailor the chair it also suits a wide range of users. Medium to high pressure relief as standard. (High to very high intelligell option available)

- Choice of 10 colours
- Fabric or vinyl option
- Elegant, simple design
- Correct positioning and support
- Fixed angle seat and back
- Lateral supports
- Built-in headrest support
- Comes on 4 x 75mm wheeled castors, 2 braked

UA-1000

Accessories - must be requested at time of ordering

UA-0893 Lap-Belt -
Requires D rings (Code UA-1001)

UA-1005 Tray with straps

UA-1004 Tray with velcro

UA-1008 Fleecy liner

UA-1026 Push handle

We recommend
the sliding footrest
and push handle
on all chairs.

UA-1003 Footrest

UA-1001 1" or 2" D rings

UA-1010 Sterling Dyna-Tek Intelligent Air
Seat Module (high - Very high)

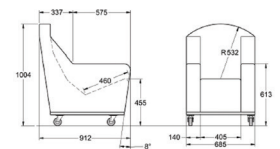

Fabric Upholstery

AGUA LIBRA Soft fabric for indoor seating

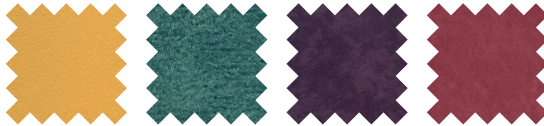

Honey

Teal

Purple

Rose

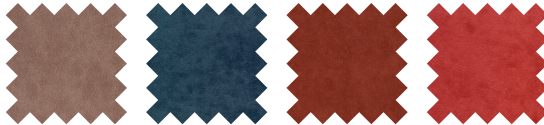

Brown

Navy

Terracotta

Red

AGUA LINETTA Linen style fabric for indoor upholstery

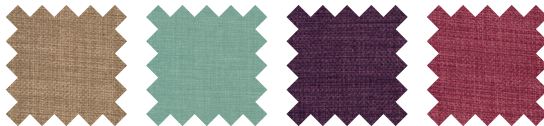

Sand

Duck Egg

Purple

Orchid



Truffle

Midnight

Gold

Red

KEY FEATURES

- Flame retardant to crib 5
- Waterproof
- AguaGuard365 anti-bacterial & anti-viral treatment against Sars
- Cov_2/Covid-19
- Stain resistant finish
- Phthalate free
- REACH compliant
- Martindale 100,000 + rubs

ILIV CHATSWORTH GRANDEUR

A textured finish waterproof upholstery



Mustard

Truffle

Taupe

Steel

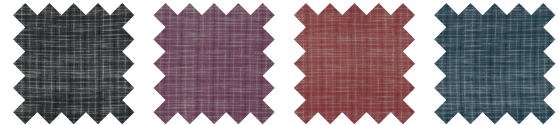

Charcoal

Damson

Claret

Petrol

KEY FEATURES

- Flame retardant to crib 5
- Waterproof
- Anti-microbial & Anti-fungal
- Stain resistant finish
- Martindale 100,000 + rubs

Fabric Upholstery

C & L SANTOS

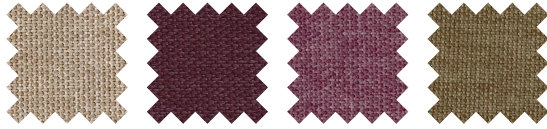

Almond

Aurberrine

Heather

Mink

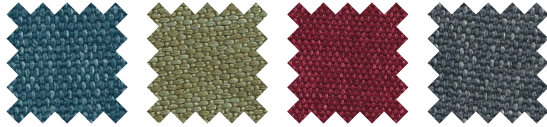

Ocean

Olive

Ruby

Steel

KEY FEATURES

- Flame retardant to crib 5
- Waterproof
- Anti-microbial & Anti-fungal
- Stain resistant finish
- Martindale 40,000 + rubs

ILIV CONNELL TWILL Traditional prints in soft country style colourways for upholstery, curtains and accessories



Slate

Pistachio

Damson



Charcoal

Petrol

Claret

KEY FEATURES

- Flame retardant to crib 5
- Waterproof
- Anti-microbial & Anti-fungal
- Stain resistant finish
- Martindale 50,000 + rubs

PANAZ HIGHLAND Simple texture that is vibrant and subdued. Forever versatile, fitting easily into any scheme

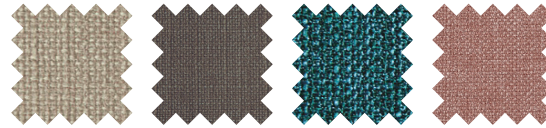

Chablis

Mink

Ocean

Blush

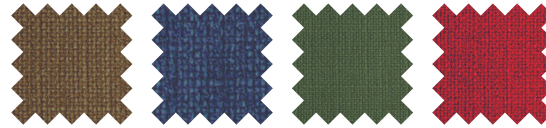

Biscotti

Navy

Olive

Red

KEY FEATURES

- Flame retardant to crib 5
- Waterproof
- Anti-microbial & Anti-fungal
- Stain resistant finish
- Martindale 70,000 + rubs

PANAZ ALBA

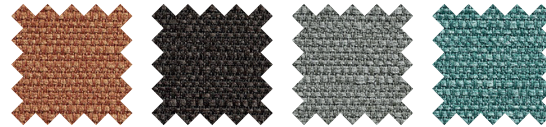

Burnt Orange

Chocolate

Nickel

Ocean

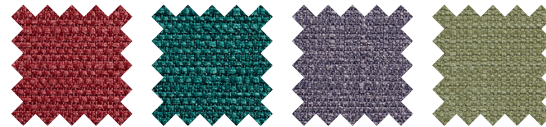

Scarlet

Teal

Thistle

Wasabi

KEY FEATURES

- Flame retardant to crib 5
- Waterproof
- Anti-microbial & Anti-fungal
- Stain resistant finish
- Martindale 70,000 + rubs

Vinyl Upholstery

AGUA PAINT POT Striking faux leather for indoor upholstery

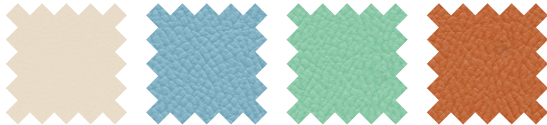

Ivory

Sky

Spearmint

Burnt Orange

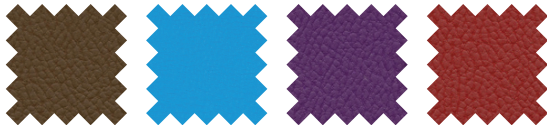

Chestnut

Azure

Purple

Scarlet

KEY FEATURES

- Flame retardant to crib 5
- Waterproof
- Anti-microbial & Anti-fungal
- Stain resistant protect
- Phthalate free
- REACH compliant
- Martindale 400,000 + rubs

AGUA AQUARIUS A hard wearing faux leather for indoor seating

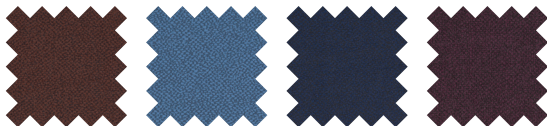

Chestnut

Cornflower

Navy

Plum

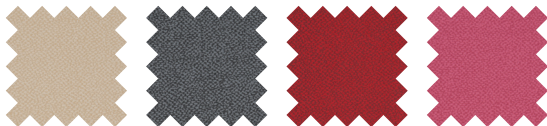

Cream

Grey

Red

Rose

KEY FEATURES

- Flame retardant to crib 5
- Waterproof
- Anti-microbial & Anti-funga
- Stain resistant finish
- Phthalate free
- REACH compliant
- Martindale 400,000 + rubs

AGUA SCORPIO A hard wearing faux leather for indoor seating

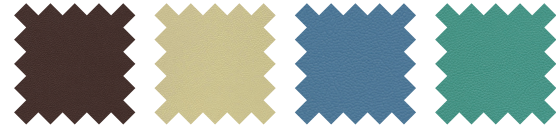

Chestnut

Cream

Cornflower

Teal



Rose

Plum

Green

Grey

KEY FEATURES

- Flame retardant to crib 5
- Waterproof
- Anti-microbial & Anti-fungal
- Stain resistant finish
- Phthalate free
- REACH compliant
- Martindale 100,000 + rubs

Vinyl Upholstery

C&L MANHATTAN Faux leather range

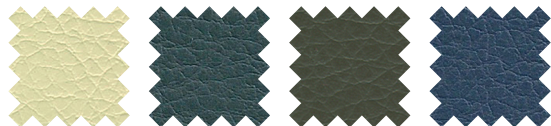

Cream

Forrest

Mushroom

Navy



Pewter

Purple

Red

Royal

KEY FEATURES

- Flame retardant to crib 5
- Waterproof - urine resistant
- Anti-microbial & Anti-fungal
- Stain resistant finish
- Martindale 200,000 + rubs

PANAZ CADET Zesty coloured plain vinyl upholstery



Cream

Chai

Teal

Cerise



Dove

Sky

Moss

Scarlet

KEY FEATURES

- Flame retardant to crib 5
- Waterproof
- Anti-microbial & Anti-fungal
- Stain resistant finish
- Martindale 350,000 + rubs

PANAZ ASTON A design classic to define or accent any interior

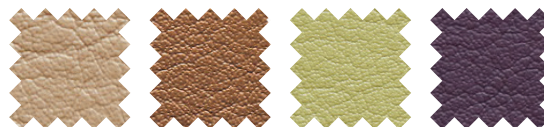

Oyster

Tan

Pistachio

Aubergine

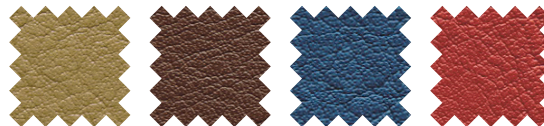

Gold

Chestnut

Blue

Red

KEY FEATURES

- Flame retardant to crib 5
- Waterproof
- Anti-microbial & Anti-fungal
- Stain resistant finish
- Martindale 750,000 + rubs

Wood Finishes



WOOD COLOUR OPTIONS



Beech



Light Oak

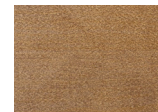

English Walnut

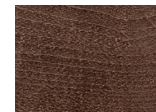

Dark Walnut



CHAIR RAISER OPTIONS **EB-6133** Set of 4

- Will raise chair 9cm
- Easy to fit and remove
- Manufactured from strong, durable polypropylene plastic
- Lightweight
- Anti-slip foam pads

5 YEARS
Furniture
Guarantee

BEDROOM & LIVING CARCASS FURNITURE

All furniture conforms to contract standards.



BEDROOM & LIVING CARCASS FURNITURE

Finished with ultra tough Medicote containing antibacterial agents to fight a wide range of bacteria including MRSA and Salmonella.

RECEPTION FURNITURE

Our range of reception furniture can be simple and stylish, or an elaborate configuration of sweeping curves. Whatever your needs, we can offer you much more than standard. We can offer a range in oak, beech and maple.

SWATCHES

For upholstery fabrics, call our projects team now on 01226 719090

- Upholstery colours & wood finishes may vary slightly from those shown due to colour reproduction
- Whilst all of our upholstery features waterproof backing, fluid ingress may occur in stitched or zipped areas
- For additional protection interliners are available on request

View our full range of home interiors and accessories at countrywideinteriors.co.uk



Stud finishing touches



Lush fabric mix



Piping



Colour pop



Contrasting cushions



Contrasting sides



Button back seat

THE CHOICE IS ALL YOURS!

From Dual fabrics, contrasting piping to button or fluted seat backs.

Request your FREE no obligation QUOTE today!

Our projects team will be able to give you help and advice as to which options work best with your chosen chairs. Simply call projects now on

01226 982454

projects@countrywidehealthcare.co.uk

Accessories



Our
BEST
SELLER
★★★★★

TOUCH
ACTIVATED

BEDSIDE ECLIPSE TOUCH LAMP

Chrome base and cream shade

- 34cm H x 16.5cm W x 16.5cm D
- Recommend Bulb: 5W E14 LED Dimmable Light Bulb (not included)

* Please note PAT testing exempt. For additional information please refer to the instruction leaflet.

UC-0220-CH



DELTA RADIO CONTROLLED LCD WALL/DESK CLOCK

- Radio Controlled Clock - Never worry about setting your clock again!
- Multifunction LCD display with calendar and temperature
- Wall or Desk Mounted - Place it wherever you want!
- Dimensions: 260 x 221 x 171mm
- Requires 2 x AAA batteries - not included

UC-0627



ACCTIM SUPERVISOR WALL CLOCK

- Day/Date display
- Chromed case
- Domed glass lens
- Quartz movement
- 320mm diameter

UC-0621

Our
BEST
SELLER
★★★★★



OCEANA WEATHER RESISTANT INDOOR/OUTDOOR WALL CLOCK

- IP55 rated against water and dust ingress - ideal for wet rooms, assisted bathrooms and garden
- Plastic case and lens
- 300mm Diameter

UC-0629

KEY LOCK



DRS VECTOR

The DRS Vector range is certified and approved for security standard S2 (EN14450) insurance rating and is available in various sizes, making it ideal for most commercial and domestic environments

- Key or Electronic lock available
- Double wall construction
- Adjustable shelves

FEATURES

Construction	Double Walled
Keys supplied	2 (No override for Elec Lock)
Key retaining	Key Lock - Yes
Live / dead locking bolts	10 / 40 / 50 / 45 - 2 / 65 / 85 - 4
Thickness of bolts	19mm
Programmable Users	1 Manager / 1 User
Batteries included Type	Yes / No AA/9V
Time delay	Yes
Shelves	Removable
Fixing bolts included	Yes
Colour	Grey
Warranty Period	2 years



Bolt Down Fixing
Wall & Floor



Lock Type
Key or Electronic



Lock
Certification
EN1300



Colour
Grey

ELECTRONIC LOCK



Batteries included with electronic locks.

* Price includes standard ground floor delivery and position. If bolt down is required please contact us for additional details.

MODEL	External sizes in mm			Internal sizes in mm			CAPACITY IN L	WEIGHT in KG	SHELVES	KEY LOCK CODE	ELECTRONIC LOCK CODE
	h	w	d	h	w	d					
1K/1E	330	450	385	270	390	296	31	44	1	RC-5866	RC-5861
2K/2E	450	450	385	390	390	296	45	52	1	RC-5867	RC-5862
3K/3E	600	450	385	540	390	296	62	65	1	RC-5868	RC-5863
4K/4E	810	450	385	750	390	296	87	83	2	RC-5869	RC-5864
7K/7E	700	500	450	640	440	361	102	87	1	RC-5870	RC-5865



Burglary Resistant Classification
LPCB - EN14450 S2

UK Cover
Cash: £4,000
Valuables: £40,000



Fire Resistant Classification
DIN 4102

DIN 4102 is an EN construction standard, which means that these units are not fire tested.

KEY SAFE PROTECTOR
available upon request

Notice Boards

COLOURS AVAILABLE

for Notice & Tamperproof boards.
Please state colour at time of ordering.
Felt fabric is fire retardant to BS 5867 Part 2 1980.



TAMPERPROOF NOTICE BOARD

- Satin silver anodised aluminium frame
- Locking doors for full protection with allen key
- Shatterproof 3mm PET clear glazing panel fire certified to BS476 Class 1Y
- Supplied with wall fixing screws

900 x 600 1200 x 900

RC-5788 RC-5789

NOTICE BOARD PINS

Pack of 100

RC-5808



NOTICE BOARD

- Deluxe aluminium frame
- Heavy duty frame, nylon corners conceal fixing screws
- Supplied with fixing screws

900 x 600 1200 x 900

RC-5797 RC-5798

WHITE BOARD STARTER KIT

CONTAINS:

- Felt eraser
- 250ml pump spray cleaning fluid
- 4 deluxe whiteboard markers (Black, Blue, Red & Green)
- 2 Non-abrasive wipes

RC-3589



NON-MAGNETIC DRY WHITE BOARD

- Satin silver anodised aluminium frame
- A neat clip-over cap covers the corners concealing screws from view
- Surface guarantee 5 years
- Comes with pen tray and a wall fixing kit

900 x 600 1200 x 900

RC-5800 RC-5799



BLACK MESH LEAFLET HOLDER

- 5 pockets
- Wall mounted
- h 623 x w 230 x d 80mm

RC-5873

COMPLETE WITH LOCKS FITTED



UA-9318
2 DRAWER
FILING CABINET

h	w	d
730	500	600

UA-9319
3 DRAWER
FILING CABINET

h	w	d
1020	500	600

UA-9320
4 DRAWER
FILING CABINET

h	w	d
1320	500	600

WOOD COLOUR OPTIONS



LIGHT OAK



BEECH

Wood finishes may vary slightly from those shown due to colour reproduction. Please state Wood/Steel finishes when placing your order

Office Furniture



RC-5816
SHORT STATIONERY
CUPBOARD
1 SHELF

h	w	d
800	800	600



RC-5817
MIDI STATIONERY
CUPBOARD
3 SHELF

h	w	d
1600	800	600



RC-5817
TALL STATIONERY
CUPBOARD
4 SHELF

h	w	d
2000	800	600

BOOKCASES

- Solid wood back panel
- Complete with fully adjustable shelves
- Available in oak or beech



UA-9328
1 SHELF
BOOKCASE

h	w	d
800	800	400



UA-9325
2 SHELF
BOOKCASE

h	w	d
1200	800	400



UA-9326
3 SHELF
BOOKCASE

h	w	d
1600	800	400



UA-9327
3 SHELF
BOOKCASE

h	w	d
2000	800	400



STATIONERY CUPBOARDS

Supplied with shelving
 • All units are lockable

COLOUR OPTIONS



GOOSE
GREY



COFFEE
CREAM

Wood finishes may vary slightly from those shown due to colour reproduction. Please state Wood/Steel finishes when placing your order



RC-5819
SHORT STATIONERY
CUPBOARD
1 SHELF

h	w	d
1016	914	400

RC-5813
SHORT STATIONERY
CUPBOARD
3 SHELVES

h	w	d
1806	914	400

KEY TAGS

- Assorted colour packs
- Complete with write-on labels

20 PACK 100 PACK

RC-5966 **RC-5967**



FILING CABINETS

All units are lockable



RC-5811
2 DRAWER
FILING CABINET

h	w	d
711	470	622



RC-5830
3 DRAWER
FILING CABINET

h	w	d
1016	470	622



RC-5830
4 DRAWER
FILING CABINET

h	w	d
1321	470	622

KEY CABINET

- Economy range
- Fixed position key hooks
- Metal key hanger strips
- Includes wall fixing kit, index sheet, key labelling strip, cylinder lock with two keys and a pack of key fobs.

RC-5950 **RC-5951**
48 KEY HOOKS 60 KEY HOOKS

h	w	d	h	w	d
258	202	63	292	299	90



UPHOLSTERED STACKING CHAIR

Popular comfortable economical practical stacking chair.

- Chrome frame
- Generous seat and back size
- Multi functional

FABRIC OPTIONS



CHARCOAL



BLUE

UA-1076



POLYPROPYLENE STACKING CHAIR

FABRIC OPTIONS



CHARCOAL



BLUE

UA-1075



MANAGERS ARMCHAIR - HIGH BACK

- Contemporary design with 5 star base
- Black faux leather chair with fixed arms
- Thick padding covered in soft and supple bonded leather
- Guarantees healthy working postures for every body
- Gas Lift Adjustment with weight tension control
- Weight capacity 115kg

UA-9329



OPERATOR CHAIR - HIGH BACK

Permanent Contact Back

* please specify colour when ordering

FABRIC OPTIONS



BLACK



BLUE



CHARCOAL

Operator Chair without Arms

UA-8061

Operator Chair with Arms

UA-8060



EXECUTIVE ARMCHAIR - MEDIUM BACK

- Bonded leather
 - Adjustable torsion control
 - Lock tilt mechanism
- Lock Tilt Adjustable torsion control and locking tilt mechanism. Gas seat height adjustment.



UA-8062



FINISH OPTIONS



OAK & GRAPHITE

BEECH & SILVER

Our range of Tables are available in the following options:

Wood finishes may vary slightly from those shown due to colour reproduction. Please state Wood/Steel finishes when placing your order

MULTI-PURPOSE TABLES

Ideal for activity, staff or meeting rooms.

- 18mm MFC with 3mm PVC lipping



CIRCULAR

1000 DIA

UA-9312

1200 DIA

UA-9313

FOLDING LEG

730H x 1200W x 800D

UA-9300

730H x 1400W x 800D

UA-9301

730H x 1600W x 800D

UA-9301

CYLINDRICAL LEG

720H x 1200W x 800D

UA-7080

WOOD COLOUR OPTIONS



OAK

BEECH



RECTANGULAR WORKSTATION

730H x 1200W x 800D

UA-8050

730H x 1600W x 800D

UA-8051



'L' SHAPED WORKSTATION

Please state Left or right hand workstation when ordering

730H x 1600W x 1200/800D

UA-8052 L/R

730H x 1800W x 1200/800D

UA-8053 L/R

LOW MOBILE PEDESTALS

3 Drawer Pedestal

600mm Deep

Fits easily under workstations.

510H x 430W x 500D

UA-9324



DESK HIGH PEDESTALS

Metal roller runners and locks. Butts up level to workstations

3 DRAWER PEDESTAL 600MM DEEP

730H x 419W x 600D

UA-9316



3 DRAWER PEDESTAL 800MM DEEP

730H x 419W x 800D

UA-9317





 Countrywide
Interiors

IMPROVING EVERYDAY LIFE THROUGH
THE USE OF CONSIDERED DESIGN

A comprehensive range of lockers with a superior finish, designed and built to last.



Single door



Two door



Three door



Four door



Six door

Meets the testing requirements of British Standard for Clothes Lockers BS 4680:1996 'Standard Duty'.

- Powder coated as standard, offering unbeatable value for money
- Single door lockers fitted with hat shelf, rail and double coat hook
- Two door lockers fitted with double coat hook in each compartment
- Semi-concealed hinges for security and clean line
- Vents in top and bottom for improved air circulation
- Lockers are 1800mm(H) x 300mm(W) x 450mm(D)



Security

Lockers fitted with a camlock with 2 keys as standard. Master key is available.

Please contact us for more information.

Camlock 4 digit tumbler



Hasp and staple



Coin return



Digital





Create your own locker solution in 2 easy steps

- 1 Choose from 5 door styles
- 2 Choose your door colour

	BL RAL5002	RD RAL3020	GR RAL7035	DG RAL7043
	Blue	Red	Grey	Dark Grey
1	UA-7901-BL	UA-7901-RD	UA-7901-GR	UA-7901-DG
2	UA-7902-BL	UA-7902-RD	UA-7902-GR	UA-7902-DG
3	UA-7903-BL	UA-7903-RD	UA-7903-GR	UA-7903-DG
4	UA-7904-BL	UA-7904-RD	UA-7904-GR	UA-7904-DG
6	UA-7906-BL	UA-7906-RD	UA-7906-GR	UA-7906-DG

Locker Accessories

Lockers with integrated sloping tops

- Popular in healthcare environment
- Sloping tops stop items and litter being placed on top of the lockers
- Locker height increases to 1950mm
- Available in the same four colours as flat top lockers



HeroShield

All HERO lockers incorporate HeroShield in the painting process. Aiding prevention of bacterial cross-contamination between personnel.



Locker stands

- Raise lockers to reduce impact damage
- Simplify cleaning, allow clearance, etc.
- 150mm high, light grey square steel tube

Code	W x D mm
UA-7607 (nest of 1)	300 x 450
UA-7608 (nest of 2)	600 x 450
UA-7609 (nest of 3)	900 x 450

Index

A

Anti Ligature Bedroom 27

B

Bathroom Cabinet 30

Bedrooms 11-27

Bookcase 32-36, 70

C

Chair CQR 59

Chest Of Drawers 11-28, 70-71

Clocks 67

Coffee Table 32-37

D

Dementia 25

Desk 12, 28, 67, 73

Dining Chairs 39

Dining Tables 38

E

Electric Recliner 55-56

Executive Chair 72

F

Fabric Upholstery 61-62

Filing Cabinet 70-71

Footstool 46-47

H

Headboards 29

High Back Chair 44, 48

High Dependency 54

L

Lamp 67

Locker 76

Lounge Furniture 31-35

M

Manual Recliner 55-57

Mattress 27

Medium Back Chair 47-49

Meeting Table 73

Mirror 30

N

Nest Of 3 Tables 37

Notice Boards 69

O

Office Furniture 70

R

Rise And Recline 56-59

S

Safes 68

Settee 44, 46, 49-54

Specialist Seating 56, 59, 60

Stacking Chair 72

Stationery Cupboard 70-71

T

TV Unit 32-36

W

Wardrobes 11-28

Whiteboard 69

Wood Finishes 65

X

Xtreme Furniture 27-28

Our full Terms and Conditions are featured at the back of the Countrywide Healthcare Catalogue.

Please check your order thoroughly as unless faulty or damaged, furniture cannot be returned due to the products being manufactured to customers individual requirements.





Countrywide Interiors

Creating inspirational living spaces

Request your FREE no obligation QUOTE today!

Our projects team will be able to give you help and advice as to which options work best with your chosen chairs. Simply call projects now on

01226 982454
projects@countrywidehealthcare.co.uk