

E-MAGAZINE

FEBRUARY 2023



A Message From Guidely To All Serious Bank Aspirants

Hai all,

Our Guidely platform has been doing a great job for the past eight years in supporting the banking aspirants. In this beautiful journey, we have been providing quality mock test packages, bundle PDF courses, and various other study materials at affordable prices. This journey will continue for the upcoming years to uplift all the banking aspirants.

Lakhs of students come into this competition with a passion to become bankers. In this battle, a majority of people have been starving for success for a long period of time. They have been facing failures for many years. Due to continuous failures, many are thinking of quitting this competition.

In reality, success will not come to you overnight. You must handle your failures in a calm and composed manner. More importantly, you have to learn more from your failures. Only after a fine-tuned practice and a perfect preparation for the long term can you attain success. In this period, you have to be motivated, work hard, and use smart strategies to find progress in your success journey

For that, Guidely will provide you with an enormous amount of quality study materials. You can rely on Guidely for standard mock test packages, bundle PDFs, and other materials at affordable price ranges. The only thing you have to do is follow us and work hard with a hundred percent hope. Guidely will end your journey with fruitful success. So, don't feel bad for your failures. Guidely will show you the best ways to crack the upcoming bank exams.

- Team Guidely

Index

Success Story	4
Tips to Follow for SBI PO Interview	6
Booster Dose	8
Important News Topic wise - Feb 2023	26
Article Related to Most Important News of the Month	101
Current Affairs Crossword Puzzle Activity	109
RBI Assistant Pre Practice set With Free video Solution	112
Zero to Infinity with Free Video Solution	137
IBPS RRB Clerk Pre Memory Based Paper	210
Hindu Editorial Vocabulary	227

SUCCESS STORY

Name : Aman Sharma
Email ID : amansharmaji.0510@gmail.com
DOB : 26-08-1998
State : U.P
Edu Qualification : Bsc (PCM)
Final Selection : RRB PO ARYAVART Bank



1

What is your special strategy that you followed to crack the bank exam ?

I don't want to study for a long time like 3-4 years. So I gave my 100% in my 1st attempt. I prepared a step above the level of the exam. So I am not afraid of results. Also I have got high marks in both pre and mains. It helped me to get the success in final result. Also, I never thought about cut-off and vacancies. I just fully dedicated myself to my studies. I gave up all the things that could distract me from my goal. I know my strengths and weakness. So i prepared in a standard way to make my weaker section much better. This is the reason I cleared every prelims and also did well in mains.

2

What would you advise the banking aspirants to prepare seriously for exams?

Firstly, have a faith that you can achieve and then do rigorous practice. Keep up your dedicated preparation till your final selection. Don't take any break till then. I would suggest you to give mock tests, only after completing the preparation of all the syllabus topics. Because, in banking exam you have to focus more on your accuracy and speed. Mock tests fetch you both these skills. First make you comfortable with prelims mocks. Then, give mains mock in every 7-15 days. So, you can keep in touch with mains level questions to will perform well in tougher mains exams.

3

What is the contribution of Guidely to your success ?

For increasing my speed and accuracy Guidely helped me a lot. Especially, the pdf course of every single exam is perfectly above the par. So, I felt my exam more easier. Also, Guidely gives me the sure-shot content, which not only improved my accuracy, but also a lot of exposure to the exam point-of-view questions. After practicing this content, you need not prepare from any other source. So, use guidely pdf course in a productive manner. Surely you can also achieve, as I did.

4 What is your real feeling after achieving your dream bank job ?

I felt very happy and proud to get a government job in this highly competitive scenario. Also, I am happy that I have fulfilled my mother's dream and made her proud. Just like any other aspirant, I also wanted to get a government job. The final result made my whole family members to feel happier and more proud.

5 To whom will you dedicate your success ?

I dedicate my success to my mom, because she is a single parent, and I have three elder brothers. So, she supported really hard to get me this success. Apart from my mother, I dedicate my success to Guidely team and the Guidely PDF course.

guidely ASPIRANTS FIRST CHOICE

Huge Selections in SBI Clerk 2022-23

Prime Bundle PDF Course 2023

12 Months Validity + 1 Year Mock Test + PDF Course 2022 (3 Months)

EXAMS COVERED: LIC, IBPS, SBI, RBI

- ✓ Daily Targets
- ✓ English & Hindi
- ✓ Detailed Video Solutions*
- ✓ PDF & Quiz Format*

120K Questions

FLAT 70% OFF + Extra 10% Off

USE CODE **GUIDELY10**

One Time Offer Ends Soon - Hurry !!

BUY NOW

Did you know? Guidely Users are finding pdf course very helpful in increasing their Accuracy and to boost up their preparation.

* Price will not be decreased below Rs. 1199/- | Special discount for Ultimate Bundle Users



Hello Everyone,

HERE ARE SOME TIPS TO FOLLOW FOR AN **SBI PO INTERVIEW**

1

Wear a formal dress with decent colors.

For Men: Formal Shirts and Trousers

For Women: A suit or formal trousers and shirt.



2

Enter the interview hall with a smile and greet everyone. A point to be noted is that you should not greet each member personally. You can say **“Good morning”** to all the respectable sirs and madams.

3

Once the interview starts, you should keep in mind that your knowledge has been checked in the prelims and mains.

Here they are checking your mental presence, your capabilities as a banker, and your confidence.

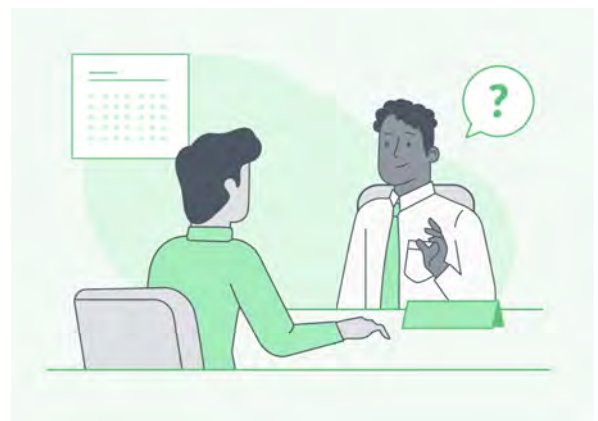

4

If you know the answer, give it confidently, without any doubt or hesitation. If you don't know the answer, simply say, **“Sorry, sir,”** with a smile.



5

Questions that are probably asked in interviews: educational qualifications; some questions might be from your academics or graduation; Questions related to banking terms, related to current news regarding banks

(For banking terms, we have already started an interview series for SBI PO on our Youtube channel.)

[Click here for a complete playlist of interview preparation tips](#)

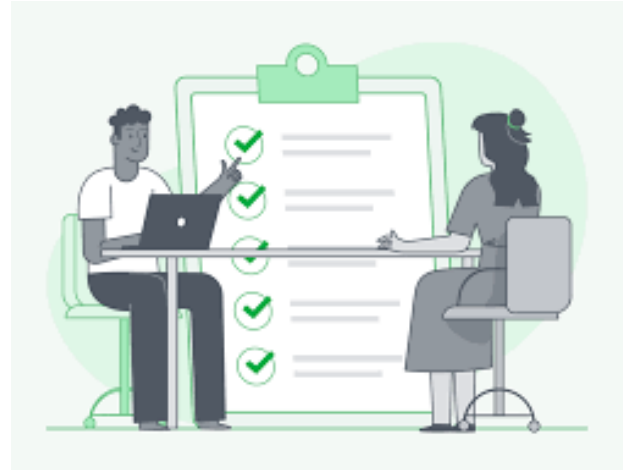

6

Once the interview is over, say 'Thank you everyone' with a smile on your face and leave.

Rudra 3.0 Complete Quant Batch For Bank & Insurance Exam 2022

80 दिन में पूरी quant की तैयार

- Exact Exam Level Content From Zero to Mains
- Learn Smart Approach to Score Max
- 80+ Live Classes + PDFs + (Recorded Form also Available)
- Topic Wise + Level Wise (DI + Arithmetic)
- Practice Test Available

Extra **10%** Off
USE CODE **GUIDELY10**

BUY NOW

1 YEAR VALIDITY



guidely





BOOSTER DOSE

February 2023





State Bank of India (SBI) has raised Rs 9,718 crore through its **second infrastructure bond issuance** at a coupon rate of 7.70% per annum for the 15-year money.

1



The Central Bank of Nigeria (CBN) governor **Godwin Emefiele** launched a **domestic card scheme AfriGo** to boost the **cashless economy & rival foreign cards like Mastercard and Visa**.

2



According to the **International Monetary Fund (IMF)**, the **Indian economy** is expected to grow by **6.1% in 2023 and 6.8% in 2024**.

3



Infibeam Avenues's **flagship payments brand - ICCAvenue**, has become the first payment gateway player to process **Central Bank Digital Currency (CBDC)** or Digital Rupee transactions for online retail merchants.

4



Australia plans to drop the head of the **British royal family** from its **five-dollar (\$5 banknote)** in favour of a design that honours the culture of the country's Indigenous people.

5



New India Assurance (NIA) has launched a '**Pay as You Drive' (PAYD) policy**, which offers a **comprehensive motor insurance policy** that charges a premium based on the usage of the vehicle.

6



Reliance Retail has become the **first Indian retailer** to introduce **Central Bank Digital Currency (CBDC)**, also known as the **digital rupee (₹-R)** at its stores.

7



Bajaj Allianz General Insurance in collaboration with **Allianz Partners** has announced the launch of a new health insurance product '**Global Health Care**'.

8



India's homegrown **Paytm Payments Bank Limited (PPBL)**, has partnered with the **National Payments Corporation of India (NPCI)** to enable users to **link RuPay credit cards** with **Unified Payments Interface (UPI)**.

9



MobiKwik, has become the **first fintech app** to support **RuPay Credit Cards** on **Unified Payment Interface (UPI)**.

10



Cashfree Payments, launched '**Co-lend**', India's first fully automated escrow management solution for co-lending.

11



The Volleyball World and the International Volleyball Federation (FIVB) have announced India as the host for the **men's Club World Championship for two years**.

12



Edelweiss General Insurance has rebranded as **Zuno General Insurance Limited (Zuno GI)**, a new-age digital insurer with an aspiration to reimagine and **redefine Insurance to make it easy, friendly, and transparent.**

13



Financial Literacy Week (FLW) is being organised by the **Reserve Bank of India (RBI)** from **February 13 to February 17, 2023.**

14



State Bank of India (SBI) has started its **3rd specialised branch** for start-ups in the country at **Gurugram** to support and provide all banking services required by Start-ups under one roof.

15



India's chess player **Vignesh NR** has become India's **80th Grandmaster** after he defeated Germany's IM Ilja Schneider and won the 24th NordWest Cup 2023 at Bad Zwischenahn in Germany.

16



The **Reserve Bank of India (RBI)** is organizing its **2nd** global hackathon – **"HARBINGER 2023 – Innovation for Transformation"** with the theme **'Inclusive Digital Services'**.

17



ADB has approved a **USD 130 million (over Rs 1,072 crore)** loan to increase **agricultural productivity** and promote horticulture agribusinesses to raise farmers' income in Himachal Pradesh.

18



HDFC Bank has become the **first private sector bank in India** to take up a service that allows customers to use **RuPay credit cards** on a **unified payments interface (UPI)** with **Bharat Interface for Money (BHIM)** and other UPI-enabled apps.

19



The **Prime Minister (PM)** of India **Shri Narendra Modi** and his Singapore counterpart **Lee Hsien Loong** launched **cross-border** connectivity between the **Unified Payments Interface (UPI)** of India and **PayNow** of Singapore through video conferencing.

20



The **Indore Municipal Corporation's Green Bonds** have been listed on **National Stock Exchange (NSE)**, marking the **first-ever green bond** issue by a municipal corporation in India.

21



HDFC Bank and **Lulu Exchange** have signed an agreement to **strengthen cross-border payments** between **India** and the **Gulf Cooperation Council (GCC)** region.

22



Delhi Environment minister **Gopal Rai** opened the **Neeli Jheel ecotourism site** in the **Asola Bhatti Wildlife Sanctuary** to the public.

23



Prime Minister **Narendra Modi** dedicated **75 Digital Banking Units (DBUs)** to the service of the nation on **October 16, 2022**. As on date, **84 DBUs are operational across India**.

24



India's first glass igloo restaurant in Gulmarg has become a popular destination for tourists who visit the area to experience scenic beauty.

25



Search giant Google confirmed it will soon start public testing for a new AI chatbot of its own called Bard, based on the company's Language Model for Dialogue Application (LaMDA).

26



Skye Air became the first company to launch traffic management system for drones in India called "Skye UTM".

27



According to the Ministry of Communications, 7% of Indian villages do not have a 4G mobile network.

28



Narendra Modi inaugurated Uttar Pradesh Global Investors Summit 2023 in Lucknow. Barabanki was the first district to organize a district-level investor summit.

29



The 14th edition of Aero India Show has been inaugurated by Prime Minister Narendra Modi in Bengaluru. 'The Runway to a Billion Opportunities' is the theme of the five-day event.

30



India's first frozen lake marathon is set to be held in Ladakh's Pangong Tso.

31



India's first solid waste-to-hydrogen plant will be set up in Pune at a cost of over Rs 430 crore.

32



Recently, the government has launched a mobile app namely '**Khanan Prahari**' and a web app **Coal Mine Surveillance and Management System (CMSMS)** for reporting unauthorized coal mining activities.

33



Under Project Cheetah, a total of **12 African cheetahs** including seven males and five females will reach **Kuno National Park, Madhya Pradesh**.

34



North India's first nuclear power plant will come up in Haryana in the village of **Gorakhpur in Fatehabad district**, 150 km north of the national capital.

35



As renewable energy sources gain prominence in India's power generation, the **share of coal is projected to decline to 69 percent by 2025 from 74 percent at present**

36



Australia's Usman Khawaja bagged the inaugural **Shane Warne Men's Test Player of the Year** award following brilliant performances in the last 12 months.

37



The Ministry of External Affairs has introduced the **'mPassport Police App'**, which will now digitize the process of sending the police verification report to the **Regional Passport Office (RPO)**.

38



Delhi Metro launches first-ever indigenously developed train control & supervision system.

39



The first International **Financial Architecture** Working Group meeting of **G-20** under the chairmanship of India was held in **Chandigarh**.

40



The first **G20 Energy Transition Working Group (ETWG)** meeting under **India's presidency** was held in Bengaluru, **Karnataka**.

41



India to be the focal country at **2025 Madrid International Book Fair**.

42



Spain is the theme country at the **46th International Kolkata Book Fair**, which will be held from 31st Jan, 2023 to 12th Feb, 2023.

43



Sri Lanka celebrated **75 years of Independence** on the 4th Feb, 2023 under the theme **Namo Namu Matha – A step towards a century**.

44



The **6th Meeting of the Heads of Supreme Audit Institutes (SAIs) of Shanghai Cooperation Organisation (SCO) Member States** is being hosted by the **Comptroller and Auditor General (CAG)** in Lucknow, Uttar Pradesh.

45



The **Ministry of Culture** is organizing the **First G20 Culture Group (CWG) meeting** in Khajuraho, Madhya Pradesh (MP) from **22nd to 25th February 2023**.

46

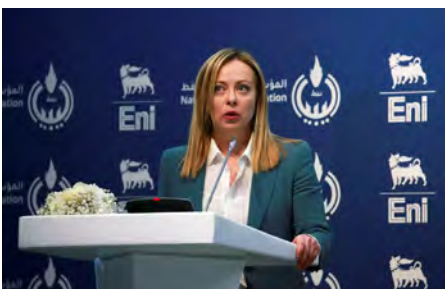

Italy's Prime Minister **Giorgia Meloni** will be the **chief guest** in the **next Raisina dialogue**.

47



The **United Arab Emirates (UAE)** is set to host the **first vice-ministerial meeting of the I2U2** in **Abu Dhabi** from **20-26 February 2023**.

48



The world's first international summit on the responsible use of artificial intelligence (AI) in the military (REAIM) 2023 commenced in The Netherlands.

49



Andhra Pradesh CM YS Jagan Mohan Reddy announced that Visakhapatnam will be the new capital of Andhra Pradesh.

50



India's first green energy-based solar panel factory will be built by Delhi-based Luminous Power Technologies in Uttarakhand.

51



Uttar Pradesh has launched the 'Aarohini Initiative Training Programme' for the safety and security of girls in all 746 Kasturba Gandhi Balika Vidyalayas (KGBV) in the state.

52



Asia's second and India's first cable suspension bridge "Bajrang Setu" is being constructed in Rishikesh, Uttarakhand

53



Delhi Deputy Chief Minister (CM) Manish Sisodia launched the WhatsApp chatbot named Bal Mitra.

54



The 4-day Jaisalmer 'Desert Festival', locally called **Maru Mahotsav**, is celebrated in **Rajasthan** during **February** every year.

55



The **Government of Jammu and Kashmir (J&K)** is set to host its first of its kind **SARAS Fair 2023** at **Bagh-e-Bahu** in **J&K**.

56



India's first glass igloo restaurant in the middle of the snow-covered mountains in **Gulmarg** has become the centre of attraction for tourists in the hill station in **Kashmir**.

57



Goa Chief Minister Pramod Sawant launched the **1st premium Helicopter Service**, Heli-Tourism service under the **Public Private Partnership (PPP)** model in **Goa**.

58



The **Madhya Pradesh (MP)** government has announced that **Islam Nagar village**, situated in the **Bhopal district**, has been renamed **Jagdishpur**.

59



Geological Survey of India (GSI) announced that "for the first time" it has established **Lithium inferred resources of 5.9 million tonnes** in the **Salal-Haimana** area of **Reasi District of Jammu & Kashmir (J&K)**.

60



Governor of **Odisha** has launched **India's first artificial intelligence (AI) driven ChatBot** for agriculture named **Ama KrushAI**.

61



Madhya Pradesh Governor **Mangubhai Patel** inaugurated the **7-day-long 49th Khajuraho Dance Festival-2023** at the world-famous tourist destination **Khajuraho**, Chhatarpur district of Madhya Pradesh.

62



The **Kerala High Court (HC)** has published two of its recent judgments in Malayalam thereby becoming the **first High Court** in India to publish it in a regional language.

63



Union External Affairs Minister **Shri S Jaishankar** inaugurated **Jammu and Kashmir's first-ever International Education Fair** in New Delhi

64



According to production data of FAOSTAT, **India** is the **highest milk producer in the world** contributing **twenty-four per cent of global milk production** in the year **2021-22**.

65



The **International Cricket Council** announced that the **ICC World Test Championship 2021-23** final will take place at **The Oval, London** from **June 7 to 11**.

66



Zomato has launched **The Shelter Project** to support the entire gig Food delivery major economy and delivery partners of various companies.

67



Morgan Stanley has named **Mr Arun Kohli** as its new country head for India.

68



The Union Public Service Commission (UPSC) has recommended **Dr Rajeev Singh Raghuvanshi** as the new **Drugs Controller General of India (DCGI)**.

69



Manuela Roka Botey became the first female Prime Minister of **Equatorial Guinea**.

70



Former Union Commerce Secretary and retired bureaucrat **Mr BVR Subrahmanyam** has been appointed as the **new Chief Executive Officer (CEO)** of **NITI Aayog** for a period of **2 years**.

71



The United Nations Children's Fund (UNICEF) India named Hindi film star **Ayushmann Khurrana** as a **National Ambassador**.

72



Ms. Vardhini Kalyanaraman has been appointed as **Additional Director** (Independent Category) on the **Board of Dhanlaxmi Bank**.

73



Associated Chambers of Commerce and Industry (ASSOCHAM) has appointed global financial markets expert **Sanjay Nayar** as its new vice president.

74



United States (US) President **Mr. Joe Biden** has nominated former Mastercard chief executive **Mr. Ajay Banga** as **president of the World Bank**.

75



Mr. **Girish Chandra Murmu** (G.C.Murmu), the **Comptroller and Auditor General (CAG)** of India, has been selected as **External Auditor** of the **International Labour Organization (ILO)**, Geneva for a 4-year term from 2024 to 2027.

76



Former foreign minister, **Nikos Christodoulides**, has been elected the **8th president of Cyprus**, beating the career diplomat **Andreas**.

77



The **Indian Air Force (IAF)** has developed an innovative indigenous platform '**Vayulink**' that would help pilots in dealing with bad weather and also provide **jammer-proof uninterrupted communication** with the base station.

78



The **4th edition** of the annual joint military exercise, “**EX DHARMA GUARDIAN**”, between **India** and **Japan** is being conducted at **Camp Imazu** in **Shiga province, Japan**.

79



The **4th edition** of annual bilateral joint military exercise **Exercise DUSTLIK (2023)** between the **India-Uzbekistan** military training was held in **Pithoragarh, Uttarakhand**.

80



Ola Electric Mobility Pvt Ltd (OEM) signed an MoU with the **Tamil Nadu** to set up a cell manufacturing plant and electric 4-wheeler manufacturing plant in **Krishnagiri district** at a **combined investment of ₹7,614 crore**.

81



Uber has signed a Memorandum of Understanding (MoU) with **Tata Motors** to bring **25,000 electric vehicles** onto the platform.

82



The **Union Government** has chosen the **Indian Institute of Technology-Madras (IIT-M)** for undertaking research on **Lab Grown Diamonds (GDs)** and will provide a grant of **Rs. 242 crore** over a period of **5 years**.

83



Qualcomm Technologies, Inc. has introduced the **world’s first satellite-based two-way capable messaging solution** for premium smartphones, called **Snapdragon Satellite**, at the **Consumer Electronics Show (CES) 2023**.

84



For the first time in the history of India, the Indian Space Research Organisation (ISRO) is set to launch a scientific mission to study the sun - **Aditya-L1 mission** in June or July, 2023.

85



Homegrown financial technology firm Velocity launched India's first Artificial Intelligence (AI) chatbot integrated with OpenAI's ChatGPT, called "**Lexi**".

86



India's first hybrid sounding rocket made by the school students from various states launched as part of **Dr APJ Abdul Kalam Satellite Launch Vehicle Mission 2023** from Pattipulam Village in **Chengalpattu**, Tamil Nadu The World's highest altitude weather station has been **rebuilt on Mount Everest**.

87



World's highest weather station was **destroyed** due to **hurricane- winds on Mount Everest**.

88

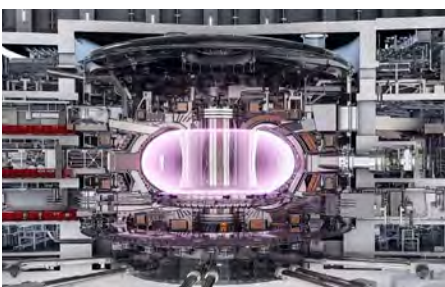

Tokamak Energy has built a **world-first set of high-temperature superconducting (HTS) magnets**, to be assembled and tested in fusion power plants-relevant scenarios.

89



Mr. Raju is among the seven persons from **Andhra Pradesh** who have been selected for the **Padma awards** announced by the **Union Home Ministry**.

90



The Hindu Group has bagged four awards at the **WAN-IFRA Digital Media South Asia Awards 2022** for its various products and services.

91



NTPC has bagged “**ATD Best Awards 2023**” for the sixth consecutive year. NTPC has won this award for demonstrating enterprise success in the field of talent development.

92



Rakhi Kapoor has won the award for her book “**Now You Breathe - Overcoming Toxic Relationships and Abuse**” in the category Powerful Relationship Guide.

93



The prestigious “**Raja Ram Mohan Roy National Award**” will be given to the Veteran Journalist **Dr. ABK Prasad for Excellence in Journalism-2020** for his outstanding contribution to the field of journalism.

94



Former prime minister **Manmohan Singh** was recently conferred a Lifetime Achievement Honour by the **India-UK Achievers Honours in London** for his contribution to economic and political life.

95



Tata Consultancy Services (TCS) has been named to **FORTUNE**® magazine’s list of the World’s Most Admired Companies.

96



Rayyana Barnawi will be the first woman astronaut from Saudi Arabia to Visit **International Space Station (ISS)**.

97



Angela Merkel has been awarded the Felix Houphouët-Boigny **UNESCO Peace Prize** in Yamoussoukro, the capital of the Ivory Coast.

98



A renowned writer **Subhash Chandran** bagged the **Akbar Kakkattil award** for his novel '**Samudrasila**'.

99

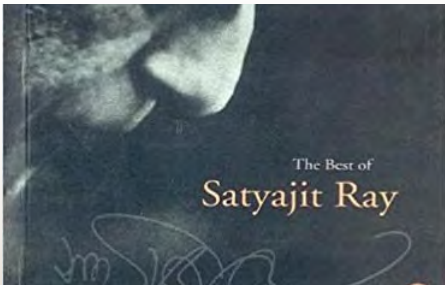

A new book titled '**Best of Satyajit Ray**' has been released by **Penguin India on Satyajit Ray**

100

E-MAGAZINE

FEBRUARY 2023





INDIAN COAST GUARD DAY

1ST FEBRUARY

Patrolling Our Borders
Since 1978

The ICG Day or Indian Coast Guard Day is celebrated on 01st February every year.

The Indian Coast Guard is a multi-mission organization, conducting round-the-year real-life operations at sea

The Indian Coast Guard Day is established on 01st February 1977. This year Indian Coast Guard celebrates its 45th Raising Day on 01st February 2023.

The interim of the Indian Coast Guard was created in 1977 to

prevent the smuggling of goods on the Sea.

On the 18th of August, 1978 the Indian Coast Guard was established officially and was declared by the Parliament of India by the **Coast Guard Act, 1978**.

World Wetlands Day 2023: 2nd February

World Wetlands Day is celebrated on 2nd February every year aims to raise global awareness about the vital role of wetlands for people and the planet.

The World Wetlands Day 2023 theme this year is "It's Time for Wetlands Restoration," which highlights the urgent need to prioritize wetland Restoration. This day also marks the date of the adoption of the Convention on Wetlands on 2 February 1971, in the Iranian city of Ramsar. On this day, The Convention on Wetlands was adopted in 1971.

This year is especially significant as World Wetlands Day 2023 will

be observed as a United Nations international day for the second time.

On August 30 last year, the United Nations General Assembly adopted a resolution to mark the day.

The day is celebrated to mark the date of the adoption of the Convention on Wetlands on February 2, 1971, in the Iranian city of Ramsar on the shores of the Caspian Sea. World Wetlands Day was first celebrated in 1997.





World Cancer Day is an international day marked on 4 February to raise awareness of cancer and to encourage its prevention, detection, and treatment.

The multi-year theme for World Cancer Day 2022-2024 is 'Close the Care Gap.'

The day aims to get various stakeholders like the government, healthcare professionals, and the general public to work on the single goal of reducing cancer at a global level. World Cancer Day is led by

the Union for International Cancer Control to support the goals of the World Cancer Declaration, written in 2008. The day first began in the

year 2000 at the World Summit Against Cancer for the New Millennium in Paris. The Union for International Cancer Control (UICC) is an organisation

that works to create awareness among people to detect cancer at an early stage.

National Productivity Day: 12th February

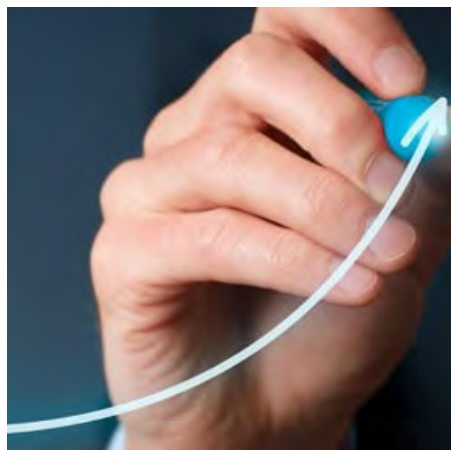

National Productivity Day 2023 is observed on the 12th of February 2023. The National Productivity Day 2023 theme set for this year is **"A chance to set goals"**.

On February 12, 1958, the National Productivity Council of India got Registered under Societies Registration Act XXI, 1860.



World Radio Day 2023: 13th February

World Radio Day is celebrated on 13 February a date proclaimed by UNESCO to celebrate radio broadcasts, improve international cooperation among radio broadcasters, and encourage decision-makers to create and provide access to information through radio, including community radios.

"Yes to Radio, Yes to trust" is the theme of this year's World Radio Day, being held on 13 February. Many people in history have

contributed to perfecting radio waves and frequencies, but it was **Italian inventor Guglielmo Marconi who proved the feasibility of communication over the radio.**

He sent and received a telegram over the **first radio signal in history from Italy in 1895.**

The **first radio station in America was established in Pittsburgh in 1919**, and FM radio debuted in 1939. Broadcasting over radio went digital in 1994 when radio streaming started via the internet.



World Day of Social Justice 2023: 20th February

The United Nations (UN) World Day of Social Justice is annually observed on February 20 to encourage people to look at how social justice affects poverty eradication.

The theme this year of the

World Day of Social Justice is “Overcoming Barriers and Unleashing Opportunities for Social Justice”

The Copenhagen Declaration and Programme of Action for Social Development were reviewed by

the UN member states a decade later in New York in 2005.

The International Labour Organization (ILO) is the first specialized agency of the United Nations that was formed on October 29, 1919.

Central Excise Day 2023: February 24

Every year February 24 is celebrated as the central Excise day all over the world.

The day is being celebrated to honor the service of the Central Board of Excise and Customs (CBEC) to the country.

In recognition of the establishment of laws, the CBEC has celebrated Central Excise day since the passing of the salt act which was signed into law on February 24, 1944.



World NGO Day Feb 27

World NGO Day is observed every year on February 27.

N.G.O. is an acronym for non-governmental organization.

World NGO Day was originally founded in 2009 by Marcis Liors Skadmanis, a social entrepreneur. However, it was observed for the first time on February 27, 2014.



National Science Day 2023: February 28

Every year, national science is celebrated on February 28 all over India.

It is celebrated every year to mark the discovery of the “Raman effect”.

The National Science Day 2023 Theme is “Global Science for Global Wellbeing”

Sukumar Chandra Sirkar (1898-1983) is one who invented science day.

In 1928, when Raman made the discovery in his laboratory at the **Indian Association for the Cultivation of Science (IACS)** in Kolkata, 32 research scholars were working under his guidance and Sukumar was one among them.



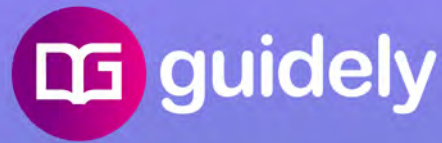

BANKING

AND

FINANCE



SBI raises Rs 9,718 crore in a second tranche of infrastructure bonds at 7.70%

The country's largest lender, **State Bank of India (SBI)** has raised **Rs 9,718 crore** through its **second infrastructure bond issuance at a coupon rate of 7.70% per annum for the 15-year money.**

The coupon rate of 7.70% represents a spread of **17 basis points** over the corresponding

government **security yield curve (G-Sec curve)** provided by the **Financial Benchmarks of India Limited.**

Prior to the latest bond sale, SBI had issued **10-year infrastructure bonds worth Rs 10,000 crore** at a coupon of **7.51%** on December 6, 2022.



Nigeria launches domestic card scheme AfriGo to boost the cashless economy

The **Central Bank of Nigeria (CBN) governor Godwin Emefiele** launched a **domestic card scheme AfriGo** to boost the **cashless economy & rival foreign cards like Mastercard and Visa.**

Nigeria was joining **China, Russia, India and Turkey** with a domestic card scheme.

AfriGo is **owned by CBN and Nigerian banks.**



IMF expects Indian economy to grow at 6.1% in 2023 & 6.8% in 2022

According to the **International Monetary Fund (IMF)**, the Indian economy is expected to grow by **6.1% in 2023 and 6.8% in 2024.**

IMF Chief Economist and Research Department Director **Pierre-Olivier Gourinchas** attributed the decline in India's growth

rate during 2023 largely due to external headwinds.

The IMF World Outlook further stated that global growth is projected to fall from around **3.4% in 2022 to 2.9% in 2023 and rise to 3.1% in 2024.**

The growth in emerging and developing Asia is likely to rise to



5.3% in 2023 and 5.2% in 2024 after the slowdown to **4.3% in 2022** due to China's uncertain economic conditions.



Infibeam Avenues becomes India's first payments platform to process retail CBDC transactions

Infibeam Avenues's flagship payments brand - CCAvenue, has become the first payment gateway player to process Central Bank Digital Currency (CBDC) or Digital Rupee transactions for online retail merchants.

CBDC, is a **robust, efficient, trusted** and legal tender based

real-time payment option.

The aim of the Indian government and the Reserve Bank of India (RBI) in launching the Digital Rupee is to reduce the ₹32 lakh crore of cash in circulation and to save costs associated with cash like currency printing, solve fake currency problems, avoid wear and tear, etc.



Australia to remove British monarchy from new bank notes



Australia plans to drop the head of the British royal family from its five-dollar (\$5) banknote in favour of a design that honours the culture of the country's Indigenous people. The new note will replace the portrait of the late Queen

Elizabeth II with a tribute to the First Australians, rather than an image of King Charles III.

Earlier in Sep 2022, the government had already hinted shortly after the Queen's death, that it wouldn't use her son's image on the new banknote.

New India Assurance (NIA) Launches 'Pay As You Drive' Vehicle Insurance Policy

New India Assurance (NIA) has launched a 'Pay as You Drive' (PAYD) policy, which offers a comprehensive motor insurance policy that charges a premium based on the usage of the vehicle.

The policy has two components - third-party cover and own-damage cover.

Discounts on renewals, coverage beyond distance limit, and enhanced protections such as nil depreciation, roadside help, return to invoice, etc.

Edelweiss Mutual Fund Introduces launches India's first passive short-term index fund

Edelweiss Mutual Fund has launched India's first open-ended passive short-duration index scheme, called Edelweiss CRISIL IBX 50:50 Gilt Plus SDL Short Duration Index Fund.

The scheme will invest in a diversified portfolio of **Indian Government Bonds (IGBs)** and **State Development Loans (SDLs)**.



Reliance Retail becomes the first Indian retailer to accept the Digital Rupee



Reliance Retail has become the first Indian retailer to introduce Central Bank Digital Currency (CBDC), also known as the digital rupee (e₹-R) at its stores.

The launch of this facility was in collaboration with **Innoviti Technologies**, **ICICI Bank**, and **Kotak Mahindra Bank**.

Indians remitted Nearly USD 2 billion under LRS scheme in Nov 2022 - RBI Data

According to the latest data released by the **Reserve Bank of India (RBI)** Indians remitted close to **\$2 billion** in November, 2022 under the Reserve Bank of India's (RBI's) **liberalised remittance scheme (LRS)**.

Outward remittances under the scheme jumped **29%** to **\$1.99 billion** compared to **\$1.54 billion** in Nov 2021.

Sequentially, outward remittances under the scheme were up about **3.5%**.



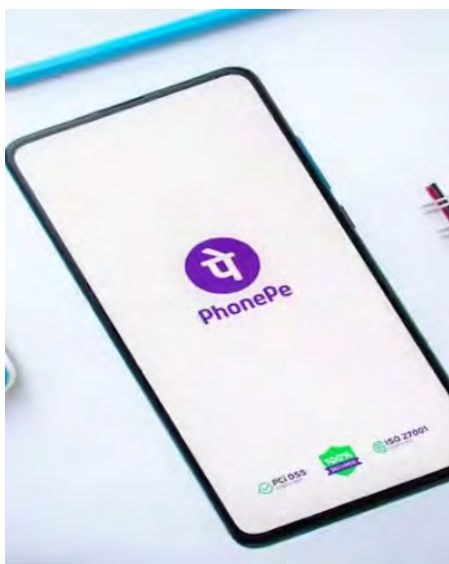

PhonePe launches UPI international service in 5 countries

FinTech firm PhonePe stated that its users will now be able to pay to international merchant outlets in 5 countries, including the United Arab Emirates (UAE), Singapore, Mauritius, Nepal, and Bhutan using Unified Payments Interface (UPI) system.

Airtel Payments Bank launches BizKhata for Small Businesses and Merchants

Airtel Payments Bank has launched - BizKhata, a current account with unlimited transactions and instant activation for small merchants and business partners across India.



RBI allow lending and borrowing of G-Secs & raises market trading hours

Reserve Bank of India (RBI) Governor **Shaktikanta Das** proposed to permit the lending and borrowing of **government securities (G-Secs)** to further develop the government securities market.

This will provide investors with an avenue to deploy their idle

securities, enhance **portfolio returns** and facilitate wider participation.

The **market hours** for the government securities market were restored to pre-pandemic timing of **9 am - 5 pm** (from the current 9 am to 3.30 pm) to move towards normalising liquidity and market operations.

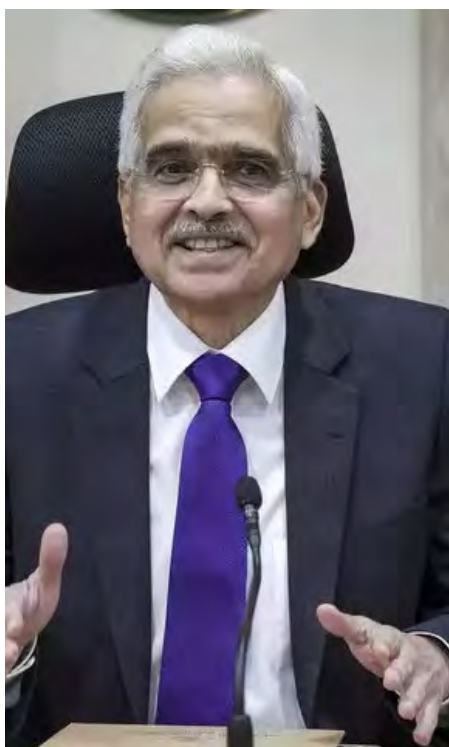

MobiKwik becomes India's first app to offer RuPay Credit Cards on UPI



India's leading fintech company, MobiKwik, has become the **first fintech app** to support **RuPay Credit Cards on Unified Payment Interface (UPI)**.

quickly make payments to merchants by scanning the UPI QR code and using the UPI PIN for payment authentication now that RuPay Credit Cards are directly linked to UPI IDs.

Recently, **PhonePe** has become the first **fintech company in India** to allow UPI payments abroad.

Customers of MobiKwik **can**

Cashfree Payments introduces India's 1st automated escrow management solution - 'Co-lend'

India's leading payments and API banking solutions company, Cashfree Payments, launched '**Co-lend**', **India's first fully automated escrow** management solution for co-lending.



It has been developed in line with the **digital lending guidelines** announced by the RBI.

SEBI amends rules governing the mode of payment by market intermediaries

Securities and Exchange Board of India (SEBI) has notified rules asking all market intermediaries and companies to make regulatory payments to it by way of direct credit into the bank account through **digital payments systems**.

Under the rules, market companies are required to intermediaries and **pay various fees** to the SEBI.





Ujjivan Small Finance Bank launches Hello Ujjivan – India’s first voice, visual, vernacular banking app

Ujjivan Small Finance Bank (SFB) launched Hello Ujjivan, India’s first mobile banking application with 3 V’s – voice, visual, and vernacular-enabled features to provide banking access to individuals who have limited reading and writing skills.

‘Hello Ujjivan’, co-created with Navana. AI.



Edelweiss General Insurance rebranded as Zuno General Insurance

Edelweiss General Insurance has rebranded as Zuno General Insurance Limited (Zuno GI), a new-age digital insurer with an aspiration to reimagine and redefine Insurance to make it **easy, friendly, and**

transparent.

Along with the new identity, the company has launched a consumer study titled **‘Usage Based Insurance: Decoding Awareness, Perception, and Behaviour’.**

RBI renews the authorization for White Label ATMs to Vakrangee

The RBI has extended the validity of authorization issued to Vakrangee to set up, own and operate **White Label Automated Teller Machines (ATMs)** in India till **March 31, 2024.**

The company currently operates **6,283 White Label ATMs** and **77%** of these are in **Tier 4 and 6 locations**





SBI opens 3rd specialised Startup branch in Gurugram



RBI's financial literacy week starts from Feb 13 to Feb 17, 2023

Financial Literacy Week (FLW) is being organised by the Reserve Bank of India (RBI) from February 13 to February 17, 2023.

The **theme** selected for current year Financial Literacy Week (FLW) is **"Good Financial Behaviour - Your Saviour"**.

In 2022, RBI observed 'financial

literacy week' from February 14 to February 18, 2022 with the theme **"Go Digital - Go Secure"**.

Since 2016, the RBI has been organising Financial Literacy Week (FLW) every year to disseminate financial education messages on a particular theme among the public across the country.

State Bank of India (SBI) has started its 3rd specialised branch for start-ups in the country at Gurugram to support and provide all banking services required by Start-ups under one roof.

Gurugram has the **3rd highest number of unicorns** - startups valued at \$100 billion or more in India, behind **Bengaluru and Mumbai**.



Paytm launches G20-theme QR Code to celebrates India's presidency

One97 **Communications Limited** that owns leading payments and financial services company **Paytm**, launched a special **G20-theme, QR Code** to celebrate India's presidency of the inter-governmental forum and the country's leadership in mobile payments.

Minister for Railways, Communications and Electronics & Information Technology, Ashwini Vaishnaw, launched the QR code at **'Digital Payments Utsav'** at India Habitat Centre in Delhi.

The special commemorative

QR Code includes the logos of the **Ministry of Electronics and Information Technology's (MeitY's) 'DigiDhan Mission'**, along with those of the G20 2023 and 75th year of India's independence.

RBI updates 'Alert List' of entities unauthorised to deal in forex trading

The Reserve Bank of India (RBI) updated its 'Alert List' for the public on unauthorised forex trading platforms to include **14 more names** of entities/platforms/ websites which appear to be promoting unauthorised entities/Electronic Trading Platform (ETPs), including through advertisements of such unauthorised entities or claiming to be providing training/advisory services

In **September, 2022** the RBI came out with an 'Alert List' containing the names of **34 entities** & currently the list has **48 entries**.



It covers those entities/platforms/websites which are neither authorised to

deal in foreign exchange (forex) under the **Foreign Exchange Management Act, 1999 (FEMA)**.

Reserve Bank of India launches its 2nd Global Hackathon - HARBINGER 2023



The Reserve Bank of India (RBI) is organizing its 2nd global hackathon - "HARBINGER 2023 - Innovation for Transformation" with the theme 'Inclusive Digital Services'.

Registration for the hackathon starts on **February 22, 2023**.

The hackathon is hosted on **Application Programming Interface Exchange (APIX) platform**.



Paytm Payments Bank becomes first to launch UPI LITE feature

Paytm Payments Banks Limited (PPBL) has launched the Unified Payments Interface (UPI LITE), enabled by the National Payments Corporation of India (NPCI) for multiple small-value UPI transactions. The PPBL is the first payments

bank to launch such a UPI LITE feature.

The UPI LITE feature enables faster real-time transactions with a single click through Paytm as the bank aims to drive the adoption of digital payments across the country.

Huge Selections in SBI Clerk 2022-23

Platinum Mock Test Series

Complete Mock Test Series for
All Major Bank Exams 2023

9 Years of Paving the Students Towards Their
Success & Still Counting

3000+ Mock Tests | Language (Eng + Hindi)

Extra **10% OFF**

USE COUPON
GUIDELY10

☆☆☆

BUY NOW

European Investment Bank Joins India Hydrogen Alliance

The **European Investment Bank (EIB)**, the bank of the European Union, formally agreed to join the **India Hydrogen Alliance (IH2A)** and expand support for large-scale green hydrogen hubs and projects across India with indicative funding of **€1 billion**

However, the funding will be subject to approval from the Indian government and EIB clearances.



ADB approves USD 130 million loans for promoting horticulture in HP



The **Asian Development Bank (ADB)** has approved a **USD 130 million (over Rs 1,072 crore)** loan to increase agricultural productivity and promote horticulture agribusinesses to raise farmers' income in Himachal Pradesh (HP) under the **HP Subtropical Horticulture, Irrigation, and Value Addition Project**.

The Project will help increase the income and resilience to the effects of climate change of at least **15,000 farm households** in Bilaspur, Hamirpur, Kangra, Mandi, Sirmour, Solan, and Una.

EbixCash becomes the first entity to enable UPI for foreign nationals

EbixCash Limited, a subsidiary of US-based Ebix Inc, has become the **first company in India** to launch and enable **Unified Payments Interface (UPI)** transactions for foreign nationals visiting India.

In **February 2023**, the RBI proposed permitting inbound travelers access to UPI for merchant payments (P2M) while they are in the country.

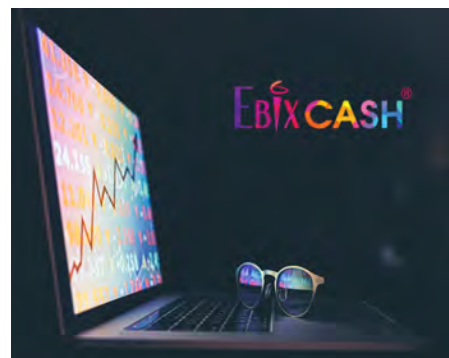

HDFC Bank becomes 1st Private sector bank to enable linking of 'RuPay Credit on UPI'

HDFC Bank has become the first private sector bank in India to take up a service that allows customers to use **RuPay credit cards on a unified payments interface (UPI)** with **Bharat Interface for Money (BHIM)** and other UPI-enabled apps.

To enable **safe**, and **secure**

payment transactions.

Till 2022, UPI was being linked to savings accounts from where the payments used to be debited. From now on, HDFC Bank RuPay credit cards can be linked to a UPI ID enabling a customer to use the credit card on popular payments platforms.



Housing Development Finance Corporation Ltd (HDFC) concluded a sale of **10-year non-convertible debentures (NCDs)** worth **Rs 25,000 crore**, marking the largest domestic rupee bond issuance by a corporate in India.

The housing financier's bonds carry an annualised coupon or the rate of interest periodically paid out to investors of **7.97%**.

The 10-year benchmark government bond yield closed at 7.35% in the secondary market.

The deal was arranged by ICICI Bank, Axis Bank, HDFC Bank, and ICICI Securities Primary Dealership.

HDFC raises Rs 25,000 crore via India's largest rupee bond sale



The issue was oversubscribed and received 92 bids amounting to **Rs. 27,863 crore** of which the

company retained 55 investor bids totaling to Rs. 25,000 crore

20 Russian banks open rupee vostro accounts to settle foreign trade in rupees



20 Russian banks, including Gazprom, Rosbank, Tinkoff Bank, Centro Credit Bank, and Credit Bank of Moscow, have opened **rupee vostro accounts** with authorized dealer banks in India to enable rupee trade between the two countries.

The **Indian banks** that are part of the process include UCO Bank, IndusInd Bank Ltd., Union Bank of India Ltd., Canara Bank Ltd., HDFC Bank Ltd., Yes Bank Ltd., State Bank of India, IDBI Bank Ltd., Indian Bank, Punjab National Bank, Bank of Baroda Ltd. and Axis Bank Ltd.

RBI Issued Draft Guidelines For Minimum Capital Requirements For Market Risk

The Reserve Bank of India (RBI) has issued **draft guidelines on minimum capital requirements** for market risk as a part of the convergence of banking regulations with **Basel III standards**.

The central bank has sought feedback on the norms by **April 15, 2023**, and has proposed that the final norms will come into effect from **April 1, 2024**.

The guidelines apply to all **commercial banks**, excluding local area banks, payments banks, regional rural banks small

finance banks, and all types of co-operative banks—urban, state, and central co-operative banks. The **capital requirement** for both specific risk and general

market risk will be **9%** of each of the core capital of the bank and the exposure to the specified instruments.



India & Singapore launch joint digital payment mechanism enabling easy and faster cross-border transactions

The Prime Minister (PM) of India **Shri Narendra Modi** and his Singapore counterpart **Lee Hsien Loong** launched **cross-border connectivity** between the **Unified Payments Interface (UPI)** of India and **PayNow** of Singapore through video conferencing.

The launch was done by RBI Governor **Shaktikanta Das** and **Ravi Menon**, Managing Director, Monetary Authority of Singapore. The linkage of UPI and PayNow will make it possible for citizens of both nations to send remittances across borders more **quickly** and

affordably.

This allows apps' users to use their Indian bank accounts to pay at merchant outlets in the **UAE, Singapore, Mauritius, Nepal and Bhutan**.

BoM Leads Public Sector Lenders In Loan Growth & Asset Quality



According to a review of the latest financial data of public sector banks (PSBs), the **Bank of Maharashtra (BoM), Pune, Maharashtra** has emerged as the **top performer**

among state-owned lenders in terms of loan growth percentage during the third quarter of 2022-23.

The lender recorded a **21.67%** increase in gross advances on a year-on-year basis

BoM was followed by the **Union Bank of India with 19.80% growth**. Country's largest lender State Bank of India (SBI) stood at **4th spot** with **16.91% rise** in advances growth.

However, SBI's total loans were about **17 times higher** at **Rs 26,47,205 crore** as compared to **Rs 1,56,962 crore** of BoM in absolute terms.

Exim Bank's GOI-supported LOC for USD 100 million to GO-MDV

Export-Import Bank of India (Exim Bank) has entered into an **agreement** dated October 02, 2022 with the **Government of the Republic of Maldives**, for making available to the latter, **Government of India supported Line of Credit (LoC)** of **USD 100 million** for financing new developmental projects and to meet spillover costs from developmental projects in Maldives already included under Lines of credit extended to **GO-MDV** by Exim Bank.



NSE lists first ever green bonds issued by Indore Municipal Corporation

The **Indore Municipal Corporation's Green Bonds** have been listed on **National Stock Exchange (NSE)**, marking the **first-ever green bond issue** by a municipal corporation in India.

Green bonds are **debt securities** designated to finance environmentally friendly projects.

In 2008, the **World Bank** issued its first green bond in response to such increasing demand.





SBI launches BHIM SBIPay for Singapore-India transfer after UPI-PayNow linkage

State Bank of India (SBI) integrated its mobile application **BHIM SBIPay**, with **UPI-PayNow** linkage facilitating **fund transfers** from **India to Singapore** through registered mobile numbers and from Singapore to India using UPI (Unified Payments Interface) ID.



HDFC Bank Partners with Lulu Exchange to facilitate cross-border payments between India and GCC region

India-based private sector bank, **HDFC Bank**, and the UAE-based financial services company, **Lulu Exchange**, have signed an agreement to **strengthen cross-border payments** between India and the **Gulf Cooperation Council (GCC)** region.

Under the partnership, a digital inward remittance service

titled **'RemitNow2India'** will be launched.

'RemitNow2India' will allow UAE residents to send money to any Indian bank account via **Immediate Payment Service (IMPS)** and **National Electronic Funds Transfer (NEFT)** through HDFC Bank's digital banking channels.

State Bank of India raises Rs 4,544 cr via allotment of AT-1 bonds

State Bank of India (SBI) announced that it has raised **Rs. 4,544 crore** through allotment of **Basel III compliant AT-1 bonds** like debentures.

These **non-convertible, taxable, perpetual, subordinated, unsecured, fully paid up Basel III compliant AT-1 bonds** like debentures have a coupon rate of **8.20% per annum (p.a.)**.

The bonds are perpetual and there is no maturity date.



NATIONAL



Chennai hosts first G20 Education Working Group meet:

Chennai is all set to host the first G20 Education Working Group meeting on February 1 and 2 and as a precursor a seminar on the 'Role of Digital Technology in Education' - a unique initiative under India's Presidency, is held at the IIT Madras Research Park.



As many as 75 delegates from G20 members and invited countries and three international organisations are attending.

The seminar also includes other activities such as an audio walkthrough to showcase the history, vision and mission of IIT

Madras and a visit to the three Centres of Excellence - the Heritage Center, the Center for Innovation and the Brain Center.

Finance minister Nirmala Sitharaman provided an outlay of ₹ 35,000 crore to achieve energy transition and net zero objectives and listed green growth among seven priorities of the government.



Prime minister has given vision for LiFE, or lifestyle for environment. To spur a movement for environmentally conscious lifestyle, India is moving firmly for the pancharit, the net zero carbon emission by 2070, usher in green industrial and economic transition.

Centre announced Rs. 35,000 Crore Investment For Green Energy Transition:

Aadhaar Mitra: UIDAI launches new AI chatbot

Aadhaar issuing body UIDAI (Unique Identification Authority of India) has launched a new AI/ML-based chatbot called Aadhaar Mitra.

formation on enrolment centres.

At present, the service is available in Hindi and English.

The AI-powered chatbot will let individuals check their Aadhaar enrolment status, track their Aadhaar PVC card status, and in-



84 DBUs are operational across the country



Prime Minister Shri Narendra Modi dedicated 75 Digital Banking Units (DBUs) to the service of the nation on October 16, 2022.

As on date, 84 DBUs are operational across the country. DBUs have been introduced to further the objective of improving the availability of digital infrastructure while accelerating and widening the reach of digital banking services.

Google has launched AI service called Bard:



Search giant Google confirmed it will soon start public testing for a new AI chatbot of its own called Bard, based on the company's Language Model for Dialogue Application (LaMDA). Technically, ChatGPT can be categorised as a type of generative AI - a broad label that's used to describe any type of artificial intelligence (AI) that can be used to create new text, images, video, audio, code or synthetic data.



India's first glass igloo restaurant was opened in Gulmarg:

India's first glass igloo restaurant in Gulmarg has become a popular destination for tourists who visit the area to experience scenic beauty.

This glass-wall restaurant was built a few days ago in the middle

of snow by the Kolahoi Green Heights hotel of Gulmarg in north Kashmir's Baramulla district.

In 2021, the same hotel built a snow igloo in Gulmarg which was the biggest snow igloo in Asia that also attracted tourists.



Skye Air became the first company to launch traffic management system for drones in India called Skye UTM:

Skye Air, a Gurugram-based drone solutions provider launched traffic management system for drones in India.

Launched in the presence of Minister of Road Transport and

Highways of India Nitin Gadkari, the software will allow drone operators to plan routes, make flight plans and assess risks before running drone-based operations in the country.

The solution, called Skye UTM, is a first-of-its-kind for India.

NITI Aayog recently launched a report titled “Transforming Industrial Training Institutes”

NITI Aayog recently launched a report titled “Transforming Industrial Training Institutes (ITIs)”.

On the lines of education boards such as the central board of secondary education, NITI Aayog has proposed setting up a separate central board for vocational education.

NITI Aayog also suggested conducting of national centralised examinations for admission to Industrial Training Institute (ITIs).

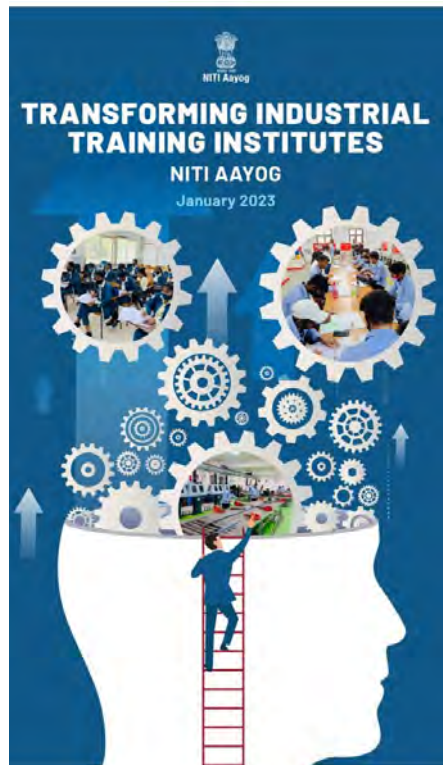

Urban - 20 City Sherpas meeting was held in Ahmedabad

A two-day Urban-20 City Sherpas meeting was held in Ahmedabad, Gujarat.

The purpose of the meeting was to focus on fostering solidarity between cities to find common solutions that are in line with the overall objectives of the G20.

It is the third of the G20 events being held in Gujarat as part of India's presidency of the Group of 20.



PM inaugurates Uttar Pradesh Global Investors Summit 2023

PM Modi inaugurated Uttar Pradesh Global Investors Summit 2023 in Lucknow.

He also inaugurated Global Trade Show and launched Invest UP 2.0.

Global Investors Summit brings together policymakers, industry leaders, think tanks, and leaders from across the world to explore business opportunities and forge partnerships.

Barabanki was the first district to organize a district-level investor summit.

Jhansi came in first position. It brought in an investment of Rs 1.84 lakh crore, the highest among districts.

Kanpur came in second position. Lucknow came in third position with investments of Rs 56,299 crore.

GUIDELY SUPER PLAN
All in one Package

- ✓ Includes 3000+ Mock Tests
- ✓ All Bundle PDF Courses
- ✓ All Bank Exam Video Courses
- ✓ Personalized Mentorship From Experts
- ✓ Special Printed Beginners Kit

Extra
10% Off

USE CODE
GUIDELY10

BUY NOW

1
YEAR
VALIDITY

The National Philatelic Exhibition – AMRITPEX 2023 was inaugurated by Shri Ashwini Vaishnav

The National Philatelic Exhibition – AMRITPEX 2023 was inaugurated by Union Minister of Communications **Ashwini Vaishnav** at Pragati Maidan in New Delhi. The event will be held from 11-15 February 2023 at **Pragati Maidan, New Delhi**.

The five-day event has been organized by the Department of Posts under the Ministry of Communications. It will showcase India's rich culture, heritage and history through postage stamps. As part of the Amrit Mahotsav



celebrations of Independence, AMRITPEX 2023 is one of the biggest initiatives to comprehensively document and showcase the story of India from various aspects.



PM inaugurates 14th edition of Aero India 2023 in Bengaluru

14th edition of Aero India Show has been inaugurated by Prime Minister Narendra Modi in Bengaluru.

'**The Runway to a Billion Opportunities**' is the theme of the five-day event.

The exhibition will showcase indigenous defense equipment, technology and fighter aircraft.

India's first frozen lake marathon at Ladakh's Pangong Tso

India's first frozen lake marathon is set to be held on **February 20**, with the Indian Army and the Indo-Tibetan Border Police (ITBP) tasked with executing a "**proper action plan**" for the event in **Ladakh's Pangong Tso**.

The frozen lake marathon will take place at an **altitude of 13,862 feet**.



75 selected athletes from India and abroad will be participating in the event, giving them an opportunity to set their names

in the Guinness world record for the world's highest "frozen-lake marathon".



The President inaugurates the 2nd Indian Rice Congress in Cuttack

President inaugurates 2nd edition of Indian Rice Congress in Cuttack.

The Indian Rice Congress-2023 at ICAR-National Rice Research Institute was inaugurated by President Smt. Droupadi Murmu. Rice production in India has increased from **89 million tonnes in 2010 to 130 MT in 2022**.

India is the **second-largest producer of rice** and the largest exporter of rice. President said that rice is the basis of food security in India and also a major factor for our economy. **West Bengal** is the highest rice-producing state in India.

Country's first waste-to-hydrogen plant to be set up in Pune:

The country's first solid waste-to-hydrogen plant will be set up in Pune at a cost of over Rs 430 crore.

The plant will be set up by sustainability solutions provider TheGreenBillions Ltd (TGBL), who has entered into a 30-year-long agreement with Pune Municipal Corporation (PMC).



Khanan Prahari Mobile app to Curb Illegal Mining

Recently, government has launched a mobile app namely 'Khanan Prahari' and a web app Coal Mine Surveillance and Management System (CMSMS) for reporting unauthorized coal



mining activities. Its main aim is to use space technology for curbing illegal

coal mining activity in the coalfield areas of country.

It has been hosted on the National Centre of Geo-Informatics (NCoG) portal.

Twelve cheetahs from South Africa arrive at Kuno National Park



North India's first nuclear power plant will come up in Haryana in the village of Gorakhpur in Fatehabad district, 150 km north of the national capital.

Union Minister of State for Science and Technology, and Earth Sciences Jitendra Singh said that

during Prime Minister Narendra Modi's regime, one of the major achievements would be the installation of nuclear/atomic energy plants in other parts of the country, which were earlier confined mostly to south Indian states like Tamil Nadu and Andhra Pradesh or in the west in Maharashtra,

Despite funding winter, India is the third largest startup ecosystem globally: NASSCOM



According to a report produced by NASSCOM in collaboration with Zinnov, a management consulting firm despite a slowdown in startup funding, India continues to be the third largest tech start-up ecosystem globally, with over 1,300 active tech start-ups added in CY2022.

According to the report, India added the second highest number of Unicorns in the world, with over 23 added in CY2022.



IIT Delhi builds 'Time Capsule' to lock in letters and postcards for 2047

The researchers at the Indian Institute of Technology (IIT)-Delhi have designed and developed a time capsule that is scheduled to be opened in 2047. The time capsule is meant to store written letters or postcards by the people on their vision for India in 2047.

the activity was part of an event organized by the Government of India that planned a "Time Capsule: Share Your Vision of India @ 2047" concept for the five-day National Philately Exhibition AM-RITPEX 2023.

MEA introduces 'mPassport Police App' to expedite police verification of passport issuance

In a bid to reduce the time taken for police verification of persons applying for passports in the national capital, the Ministry of External Affairs has introduced the 'mPassport Police App', which will now digitize the process of sending the police verification report to the Regional Passport Office (RPO).

Home Minister Amit Shah made



an announcement in this regard at Delhi Police's 76th Raising Day ceremony.

Delhi Metro launches first-ever indigenously developed train control & supervision system

India achieved another milestone by launching the first ever indigenously developed Train Control and Supervision System.

The i-ATS (Indigenous-Automatic Train Supervision) system has been launched by Delhi Metro Rail Corporation (DMRC) on its first corridor i.e. Red line (from Rithala to Shaheed Sthal).

With the launch of i-ATS, India becomes the sixth country which has its own ATS products after France, Germany, Japan, Canada, and China.



The i-ATS (Indigenous-Automatic Train Supervision) has been launched from the Operations Control Centre (OCC) located at Shastri Park by Manoj Joshi, Secretary, Ministry of Housing and Urban Affairs, Government of India and Chairman, Delhi Metro.

India has joined the Agricultural Innovation Mission

India has joined the Agricultural Innovation Mission for Climate. With an aim to accelerate investment and support for climate-smart agriculture and food systems innovation, the US and the UAE have launched this global platform.

India has joined the Agriculture

Innovation Mission for Climate (AIM4C), which was launched by the two nations in November 2021. At the I2U2 business forum, a letter was signed by the Joint Secretary of the Ministry of External Affairs, Dumu Ravi, in which the Indian intention was expressed to join the AIM4C.

The inaugural I2U2 (Israel, India,



Shri Nitin Gadkari lays Foundation Stone of the world's largest and unique Divyang Park

Union Minister for Road Transport and Highways, Nitin Gadkari laid the foundation stone for the world's largest Divyang Park -- Anubhuti Inclusive Park -- in Nagpur.

The park will have adapted facilities for all 21 types of disabilities like touch and smell garden, hydrotherapy unit, water therapy, independent room for mentally challenged children, mother.

In 2016, the Central government had passed the Rights of Persons with Disabilities Act.

World's first inclusive disabled park has been made from a provision of about Rs 12 crore by the Ministry of Social Justice and Empowerment built this park in an area of 90 thousand square feet.



United States, and United Arab Emirates) business forum was held in Abu Dhabi.



G7 finance chiefs meeting held in Bengaluru.

G7 finance chiefs meeting held in Bengaluru. Financial chiefs of the Group of Seven (G7) meet to discuss measures against Russia so that it could end the Ukraine war.

finance ministers and central bank governors from the G7 nations.

The main focus of the meeting was on the **Ukraine war and the global economy.**

Summit from May 19–21 in 2023. G7 is an intergovernmental organization that was formed in 1975.

The G7 comprises **Britain, Canada, France, Germany, Italy, Japan, and the United States.** India is not a member of the G7 group.

Japan chaired the meeting of

Japan will host the G7 Hiroshima



Huge Selections in **SBI Clerk 2022-23** Prime Bundle PDF Course 2023

Daily Targets	English & Hindi	Detailed Video Solutions*	PDF & Quiz Format*
12 Months Validity + 1 Year Mock Test + PDF Course 2022 (3 Months)			

EXAMS COVERED:



- ✓ Beginners Bundle Course
- ✓ Topic wise Bundle PDF Course
- ✓ Exam wise Bundle PDF Course
- ✓ Section wise Bundle PDF Course
- ✓ Memory Based Question Bundle Course
- ✓ Special Prelims Part Bundle PDF Course
- ✓ Mains Booster PDF Course



FLAT **70% OFF** Extra **10% Off**
USE CODE **GUIDELY10**

One Time Offer Ends Soon - Hurry !!!

BUY NOW

DID YOU KNOW?

Guidely Users are finding pdf course very helpful in increasing their Accuracy and to boost up their preparation.

* Price will not be decreased below Rs. 1199/- | Special discount for Ultimate Bundle Users



INTER NATIONAL

Current Affairs Magazine
Feb 2023

South Africa to host 15th BRICS summit at Durban in August 2023

Russian Foreign Minister Sergei Lavrov & Foreign Minister of the State of Eritrea Osman Saleh announced that the 15th BRICS



(Brazil, Russia, India, China, and South Africa) summit is set to take place in South Africa's Durban in late August, 2023.

The foreign ministers of Brazil, Russia, India, and China met for the first time on the sidelines of the

United Nations General Assembly (UNGA) in 2006, kicking off BRIC cooperation.

South Africa participated in the 3rd BRICS summit in

China for the first time in April 2011.

Earlier in 2013, the 5th annual BRICS summit was held in Durban, South Africa.

Since 2009, the BRICS leaders have convened 14 formal meetings and 9 informal meetings.



G-20 International Financial Architecture Working Group Meeting to be held in Chandigarh

The first International Financial Architecture Working Group meeting of G-20 under the chairmanship of India will be held in Chandigarh on 30-31 January 2023.

The meeting will be inaugurated by the Union Agriculture and Farmers Welfare Minister **Shri Narendra Singh Tomar** and Food Processing Industries Minister **Shri Pashupati Kumar Paras**.

The first meeting of the G-20 Finance Ministers and Central Bank Governors is scheduled to be held in Bengaluru on 24-25 February 2023.



India to be focal country at 2025 Madrid International Book Fair

The Ambassador of Spain to the country **Jose Maria Ridao** announced that India will be invited as the focal country at the Madrid International Book Fair in 2025.

Spain is the theme country at the 46th International Kolkata Book Fair which will be held from **31st Jan, 2023 to 12th Feb, 2023**.

Jose Maria Ridao announced that a football dictionary of Spanish to Bengali will be launched at the **Kolkata Book Fair**, containing

terms and phrases used in the Spanish league.

Kolkata book fair has kicked off at Salt Lake.

More than 950 stalls will be set up at the fair, which has been inaugurated by **Chief Minister Mamata Banerjee**.

Eminent Bengali writer **Shirshendu Mukhopadhyay** was felicitated at the inaugural ceremony. geopolitical turmoil triggered by the conflict in Ukraine.



Bengaluru to host 1st G20 ETWG meeting under India's Presidency

The first G20 Energy Transition Working Group (ETWG) meeting under India's presidency will be held in Bengaluru, Karnataka from Feb 5 to 7, 2023.

Sri Lanka celebrated 75 years of independence



Sri Lanka celebrated 75 years of Independence on the 4th Feb, 2023 under the theme **Namo Namu Matha – A step towards a century.**

The main celebration of the National Independence Day Celebrations was held at Galle Face Green in Colombo.

Union Minister of State for External Affairs, **V. Muraleedharan** participated in the Independence Day celebrations.



Ministry of Culture to Host 1st G20 Culture Group Meet in Khajuraho, Madhya Pradesh

The Ministry of Culture is organizing the First G20 Culture Group (CWG) meeting in Khajuraho, Madhya Pradesh (MP) from 22nd to 25th February 2023.

The theme of the Khajuraho meet is **“Protection and Restitution of Cultural Property”.**



CAG to host 6th Shanghai Cooperation Organisation SAI Leaders' Meeting in Lucknow

The 6th Meeting of the Heads of Supreme Audit Institutes (SAIs) of Shanghai Cooperation Organisation (SCO) Member States is being hosted by the Comptroller and Auditor General (CAG) in Lucknow, Uttar Pradesh (UP).

Governor of Uttar Pradesh Anandiben Patel is the chief guest & inaugurated the meeting. Comptroller and Auditor General of India, Girish Chandra Murmu led the discussion on the theme **“Integrating Emerging Technologies in Audit”.**

India & US to jointly develop UAVs and share IP rights

India and the United States (US) have moved ahead to jointly develop air-launched unmanned aerial vehicles (ALUAV) that will be used for surveillance missions, in a massive boost to Indo-US defence ties

This is the **first UAV project** under which common **intellectual**



property (IP) rights will be generated, giving the Indian ecosystem a significant technology boost.

Russian arms supplies to India worth \$13 billion in past 5 years

Russia supplied India with around **\$13 billion** of arms during the past 5 years.

As per Russian state news agencies, New Delhi has orders placed with Moscow for weapons and military equipment exceeding **\$10 billion.**

India is the **world's biggest buyer of Russian arms**, accounting for around **20%** of Moscow's current order book.

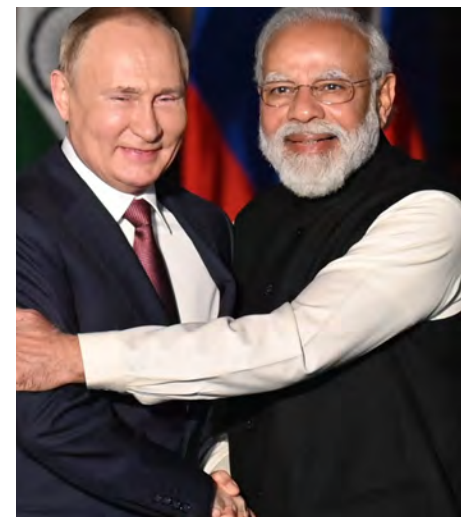

Italian PM Meloni chief guest at Raisina Dialogue

Europe's right-wing poster girl and **Italy's Prime Minister (PM) Giorgia Meloni** will be the **chief guest in the next Raisina dialogue.**

This will be the **2nd year** in a row that a major European leader will attend the talks as chief guest in

the midst of the Ukraine war. President of the European Commission **Ursula von der Leyen** was the chief guest in **2022.** Meloni, who formed Italy's most far-right government since the days of Mussolini following his election victory in 2022, is also **Italy's first female prime minister.**



UAE to host first I2U2 vice-ministerial meeting in Abu Dhabi

The **United Arab Emirates (UAE)** is set to host the first vice-ministerial meeting of the **I2U2 in Abu Dhabi** from **20-26 February 2023.**



by **President Joe Biden, Israeli Prime Minister Lapid, UAE President Mohamed bin Zayed Al Nahyan, and Indian Prime Minister**

Senior officials from India, Israel, the United States, and the UAE will attend the meeting.

Narendra Modi. Under Secretary of State for Economic Growth, Energy, and the Environment **Jose W. Fernandez** will lead the U.S. delegation at the meeting.

It is the **first vice-ministerial meeting** since the grouping (I2U2) was jointly announced

Financial Action Task Force Suspends Russia's Membership



Global anti-money laundering watchdog the **Financial Action Task Force (FATF)** has **suspended Russia's membership** for its **"illegal, unprovoked and unjustified"** full-scale military invasion of Ukraine.

World's first global summit on Responsible AI in the Military kicks off in The Netherlands

The world's first international summit on the responsible use of artificial intelligence (AI) in the military (REAIM) 2023 commenced in The Netherlands. REAIM 2023 brings together governments, corporations,

academia, startups, and civil societies to raise awareness, discuss issues, and possibly, agree on common principles for deploying and using AI in armed conflicts.





Jharkhand's First Survey of Migrants launched for a better understanding of the migrant population

First Jharkhand Migrant Survey (JMS), a key exercise to draft state-level policy has been launched by Jharkhand for a better understanding of the migrant population, and their numbers.

The initiative is part of the state's Safe and Responsible Migration Initiative (SRMI), which was launched in 2021-end and includes the preparation of a database of migrant workers.

Visakhapatnam to be Andhra Pradesh's new capital - CM Jagan Mohan Reddy

Andhra Pradesh (AP) Chief Minister (CM) Shri YS Jagan Mohan Reddy announced that Visakhapatnam popularly known as Vizag will be the new capital of the AP at the International Diplomatic Alliance meeting in New Delhi.

The CM further announced that the AP government is organising the 'Global Investors Summit' in Visakhapatnam on March 3 and 4, 2023.



India's 1st Green Solar Panel Manufacturing Facility to Build by Luminous in Uttarakhand



India's first green energy based solar panel factory will be built by Delhi-based Luminous Power Technologies in Uttarakhand.

Rudrapur, Uttarakhand based new manufacturing plant is expected to be fully operational by the end of 2023.

Uttarakhand – Construction of “Bajrang Setu” to be completed by July 2023

Uttarakhand, Asia's second and country's first cable suspension bridge “Bajrang Setu” is being constructed at Rishikesh.

The construction of the new bridge would cost Rs 67 crores and all efforts are made to complete it by July 2023.

This bridge is coming up next to the famous 90-year-old Laxman Jhula.

Laxman Jhula has been closed



since 2022 when it was found that it wasn't safe for pedestrians anymore & however, it will not be removed and will be preserved as a heritage.

Proposal to rename Etawah as Mulayam Nagar in memory of Samajwadi Party founder Mulayam Singh

A proposal was made at the District Panchayat Board meeting in Etawah to change the name of Etawah district to Mulayam Nagar in the memory of the Samajwadi Party (SP) founder and former Uttar Pradesh (UP) Chief Minister Mr Mulayam Singh.



DCPCR launches WhatsApp chatbot – Bal Mitra

Delhi Deputy Chief Minister (CM) Manish Sisodia launched the WhatsApp chatbot named Bal Mitra.

The Chatbot was developed by the Delhi Commission for Protection of Child Rights (DCPCR) which is an effort to enable two-way communication between people and the child rights panel.



‘Desert Festival’ of Rajasthan set to take off in Jaisalmer in February

The 4-day Jaisalmer ‘Desert Festival’, locally called Maru Mahotsav’, is celebrated in Rajasthan during February every year.

The festival is being organized by the Rajasthan Tourism Department in collaboration with Jaisalmer District Administration.

Along the way, groups of artists performed folk dances like Kalbelia, Horse, Kachhi Ghodi, Gair, etc.

SPECIAL OFFER

Rudra Mini 2023
Quants Batch (Pre to Mains)

- ✓ Basic to Advance Quant Course
- ✓ Live + Recorded Classes + PDFs
- ✓ Weekly Assessment
- ✓ 1 year Validity
- ✓ Covers All subtopics

Extra **10% Off** USE CODE **GUIDELY10**

FREE

RUDRA 3.0+
VIKRAM
DI BATCH

Grab It Now



J&K govt to host its first ever SARAS Fair 2023

The Government of Jammu and Kashmir (J&K) is going to host its first of its kind SARAS Fair 2023 from February 4 to 14, 2023 (11-day long) at Baghe-Bahu in J&K.

Union Minister for Rural Development & Panchayat Raj, Giriraj Singh and Lieutenant Governor of the UT of Jammu and Kashmir, Manoj Sinha, inaugurated the fair.

Goa CM Pramod Sawant launches new Heli-Tourism service in Panaji

Goa Chief Minister Dr. Pramod Sawant launched the 1st premium Helicopter Service, Heli-Tourism service under the Public Private Partnership (PPP) model in Goa.

The service is provided by the Department of Tourism, Government of Goa through its Operation & Maintenance Operator M/s Soaring Aerospace Pvt.



Madhya Pradesh Govt Renames Bhopal's Historic Islam Nagar As Jagdishpur



The Madhya Pradesh (MP) government announced that Islam Nagar village, situated in the Bhopal district, has been renamed Jagdishpur.

Islam Nagar village is located at a distance of around 12 km from Bhopal and is famous for forts. The name of Islam Nagar used to be Jagdishpur 308 years ago.

In 1719, Islam Nagar was made the capital of Bhopal and its control was held by the ruler Dost Mohammad Khan.

In a first, GSI discovered Lithium reserves in J&K

Geological Survey of India (GSI) announced that "for the first time" it has established Lithium inferred resources of 5.9 million tonnes in the Salal-Haimana area of Reasi District of Jammu & Kashmir (J&K). The announcement was made

by the mines secretary Vivek Bharadwaj at the 62nd meeting of the Central Geological Programming Board (CGPB) meeting in Delhi. The Ministry of Mines stated that 51 mineral blocks including Lithium and Gold were handed over to the state governments.



Odisha Launched India's First AI-Chatbot - Ama KrushAI for Farmers

Governor of Odisha **Shri Ganeshi Lal** launched India's first artificial intelligence (AI) driven ChatBot for agriculture named Ama KrushAI in Bhubaneswar at the annual **Krusha Odisha event 2023**.

To provide farmers with the best agronomic practices, government schemes, and loan products from over 40 commercial and cooperative banks.



49th edition of 'Khajuraho Dance Festival' 2023 kicks off in Madhya Pradesh

Madhya Pradesh (MP) Governor **Mangubhai Patel** inaugurated the 7-day long 49th Khajuraho Dance Festival-2023 at the world famous tourist destination Khajuraho, Chhatarpur district, MP.



Kerala High Court becomes first in India to publish judgments in regional language

The Kerala High Court (HC) has published two of its recent judgments in Malayalam thereby becoming the first High Court in the country to publish it in a regional language.



EAM Jaishankar inaugurates the first International Education Fair of Jammu-Kashmir - JK Education Fair 2023

Union External Affairs Minister **Shri S Jaishankar** inaugurated Jammu and Kashmir's first-ever **International Education Fair in New Delhi**

It is being organized in a collaborative effort of the Sher-e-Kashmir **University of Agricultural Science and Technology (SKUAST-Kashmir)** and the **Indian Council for Cultural Relations (ICCR)**.

Education Minister Dharmendra Pradhan, Minister of State at PMO Jitendra Singh, Jammu, and Kashmir Lieutenant Governor Manoj Sinha also attended the event held at Sushma Swaraj Bhawan.

Government of Telangana to host \$100bn Life Sciences industry ecosystem by 2028

Telangana government is aiming to **increase the size of the pharma-life sciences ecosystem** in the State from **\$50 billion to \$100 billion by 2028**.

This was announced by the State Industries Minister **KT Rama Rao** while speaking at the inaugural

session of the **20th edition of Bio Asia, 2023** the flagship pharma-life sciences

conference of the State. The upcoming Hyderabad Pharma City with a life sciences



university and B-Hub to encourage start-ups will further boost the pharma-life sciences industry in the State.

Himachal Pradesh Becomes First State in India to Begin Organized Cultivation of Mulethi



Himachal Pradesh (HP) has become the **first state in India** to start the organised **commercial cultivation of Licorice (Mulethi)**.

For the first time, planting material of Mulethi (**Glycyrrhiza glabra**) was distributed to the farmers to cultivate it commercially.

The distribution of planting materials among the farmers was done by the **Council of Scientific and Industrial Research (CSIR)-Institute of Himalayan Bioresource Technology (IHBT)**.

Best Practice Materials to Crack Bank Exams 2023

Topic-Wise Bundle PDF Course 2023

- 15,000+ questions (Prelims + Mains)
- Covered questions from individual topics in each subject
- Explanations with Detailed Video Solutions

Exams Covered: IBPS RRB PO/ Clerk, IBPS PO/ Clerk, SBI PO/ Clerk & Other important Bank & Insurance Exams

FLAT **70% OFF** Extra **10% Off** USE CODE **GUIDELY10**

Grab It Now

12

MONTHS VALIDITY

BUSINESS



MAGAZINE FEB 2023

GST Collection At ₹ 1.55 Lakh Crore In January, Second Highest-Ever:

The GST collection in January surged to over ₹ 1.55 lakh crore, the second highest-ever mop-up, the finance ministry.

The revenues in the current financial year up to **January 2023** are **24 per cent higher** than the **GST revenues** during the same period last year.

This is for the third time, in the



current financial year, GST collection has crossed ₹ 1.50 lakh crore mark.



RIL, Ashok Leyland unveil India's first hydrogen-powered truck

Mi **u k e s h**
Ambani-
e d

India ranks first in milk production in the world contributing 24% of global milk production

According to production data of **Food and Agriculture Organization Corporate Statistical Database (FAOSTAT)**, India is the highest milk producer in the world contributing **twenty-four per cent** of global milk production in the year 2021-22.

Milk production of India has registered a **fifty-one per cent increase** during the last eight



years- during the year 2014-15 and 2021-22 and increased to

twenty-two crore tonne in the year 2021-22.

Due to the implementation of various schemes by the department, Milk Production in the country has increased from **146.31 Million Tonnes in 2014-15 to 221.**

Egg production in the country is growing at the rate of **8 per cent per annum.**

NSE gets SEBI approval to launch Social Stock Exchange as a separate segment

The **National Stock Exchange (NSE)** has received final approval from the **Securities and Exchange Board of India (Sebi)** to set up a **Social Stock Exchange (SSE)** as a separate segment of the **NSE**

SSE is a novel idea in India, and a stock exchange of this kind is intended to benefit the private and non-profit sectors by

directing more capital to them. The SSE will function as a distinct division of the current stock exchanges under the new regulations.

According to **Sebi's framework**, a **minimum issue size of ₹1 crore** and a **minimum application size for the subscription of ₹2 lakhs** are currently required for **SSE.**



APPOINTMENTS & RESIGNATIONS

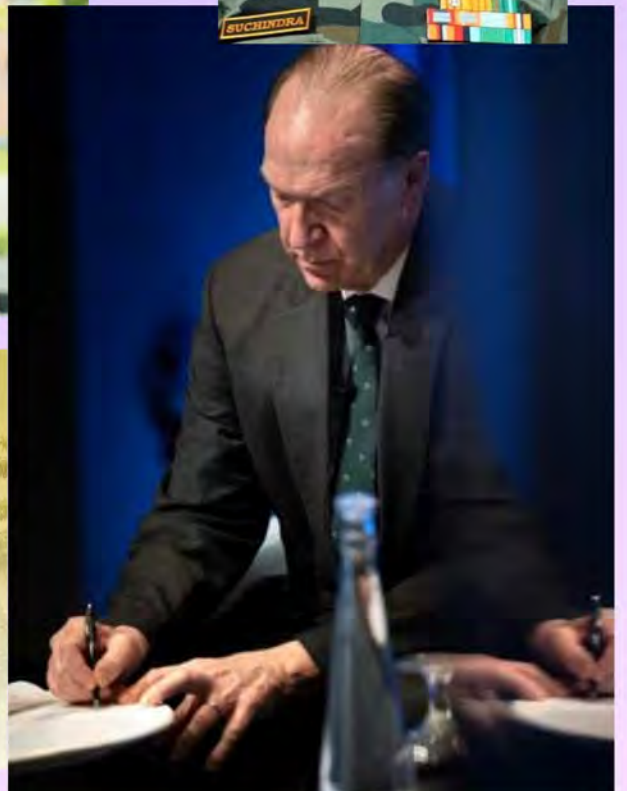
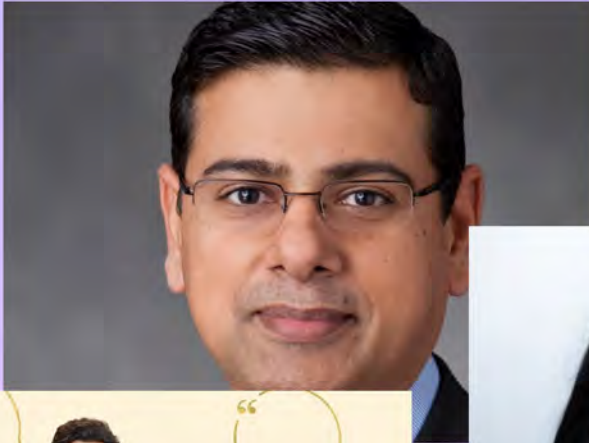

Indian-American Ms Shasti Conrad became the 1st South Asian to be elected for the post of Washington State Democratic Party chair

The Washington State Democrats have elected Indian-American political consultant Ms Shasti Conrad as the new chair of the Washington State Democrats at its Reorganisation Meeting and Officer Elections event.

She is the youngest person as well as the first South Asian and

first Indian American woman to serve as a State Democratic Party Chair



United States (US). Ms Conrad replaced Tina Podlodowski, who served as party chair since 2017.



Morgan Stanley appoints Mr Arun Kohli as the new country head for India

Morgan Stanley has named Mr Arun Kohli as its new country head for India.

Mr Kohli will be replacing Mr Sanjay Shah, a veteran of 26 years at the firm, who is retiring. Mr Kohli, based in London, has been associated with Morgan Stanley for the past 15 years.

Unilever appoints Mr Hein Schumacher as new CEO

Consumer goods giant Unilever appointed Mr Hein Schumacher as its new chief executive officer (CEO), set to take on the role on July 1, 2023.

This is the first time Unilever has appointed a CEO from outside the company.

Mr Hein will replace Mr Alan Jope, who announced in September



2022 his intention to retire from Unilever.

RBI Appoints Mr V Ramachandra As Member Of Advisory Committee Of Srei Group NBFCs

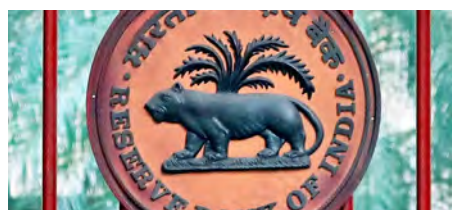

The Reserve Bank of India (RBI) has appointed Mr V. Ramachandra as a member of the Advisory Committee of Srei Infrastructure Finance Ltd. (SIFL) and Srei Equipment Finance Ltd. (SEFL)

This follows the resignation of Mr Farokh N. Subedar from the Advisory Committee with effect from January 31, 2023.

The Advisory Committee will now comprise of following members:

Shri Venkat Nageshwar Chalasani, former Deputy Managing Director, State Bank of India

Shri T T Srinivasaraghavan, former Managing Director, Sundaram Finance Limited

GUIDELY SUPER PLAN
All in one Package

- ✓ Includes 3000+ Mock Tests
- ✓ All Bundle PDF Courses
- ✓ All Bank Exam Video Courses
- ✓ Personalized Mentorship From Experts
- ✓ Special Printed Beginners Kit

Extra
10% Off

USE CODE
GUIDELY10

BUY NOW

1
YEAR
VALIDITY



Dr. Rajeev Singh Raghuvanshi appointed as new Drugs Controller General of India

The Union Public Service Commission (UPSC) has recommended **Dr Rajeev Singh Raghuvanshi** as the **new Drugs Controller General of India (DCGI)**.

The recommendation will be approved by the **Health Ministry**, followed by approval of the Appointments Committee of Cabinet (ACC) led by PM Narendra Modi.

He will succeed **Dr V G Somani** whose extended tenure ends mid-February, 2023.

Equatorial Guinea appoints Ms Manuela Roka Botey as first female PM

Equatorial Guinea's President **Mr Teodoro Obiang Nguema** appointed **Ms Manuela Roka Botey**, as **Prime Minister (PM)**, of Equatorial Guinea.

She is the **first woman** to hold the position in the country.

She succeeded former Prime Minister **Mr Francisco Pascual Obama Asue**, who has held the position since 2016.



Mr Teodoro Obiang has served as the President of Equatorial Guinea **since August 1979**.

CJI DY Chandrachud administers the oath to 5 new SC judges

Chief Justice of India (CJI) **DY Chandrachud** administered the oath of office to **5 new judges** of the **Supreme Court** in a ceremony held at the Supreme Court's auditorium in its new building complex.

List of 5 new Judges :

1. Pankaj Mithal
2. Sanjay Karol
3. PV Sanjay Kumar
4. Ahsanuddin Amanullah
5. Manoj Misra

Their names were recommended for elevation as apex court judges

by the **6 member Supreme Court Collegium on December 13, 2022**. With the addition of 5 new judges, the strength of the apex court has gone up to 32 judges, 2 short of its full strength.

Actual sanctioned judge strength of the Supreme **Court is 34** (including the Chief Justice of India). Earlier, Pankaj Mithal, P V Sanjay Kumar, Manoj Misra were the chief justices of the high courts of Rajasthan, Manipur and Allahabad respectively, while Sanjay Karol and Ahsanuddin Amanullah were both chief justices of Patna HC.



Rajan Pental appointed as Executive Director of YES BANK

The Reserve Bank of India (RBI) appointed Mr Rajan Pental as the Executive Director of YES Bank for a period of 3 years.

He will continue to spearhead the YES bank's retail banking portfolio, apart from his appointment as an executive director.



Lieutenant General MV Suchindra Kumar appointed as new Army Vice Chief



Lieutenant general MV Suchindra Kumar has been appointed as the new Vice Chief of Army Staff.

He succeeds Lt Gen B S Raju as the Vice Chief of Army Staff.

At present, Suchindra Kumar is serving as Deputy Chief of Staff (Strategic) at the Army Headquarters.

Lt Gen NSR Subramani has been posted as the Central Command chief in Lucknow, Uttar Pradesh (UP).

He is at present serving as the Chief of Staff at the headquarters of the Northern Command in Udhampur.

Mr BVR Subrahmanyam appointed as new CEO of NITI Aayog



Former Union Commerce Secretary and retired bureaucrat Mr BVR Subrahmanyam has been appointed as the new Chief Executive Officer (CEO) of NITI Aayog for a period of 2 years.

He succeeded Mr Parameswaran Iyer, who was appointed NITI Aayog's CEO in July 2022.

Meanwhile, Mr Parameswaran Iyer has been appointed as Executive Director (ED), World Bank headquarters, Washington DC, USA for a tenure of 3 years.

The government also appointed Mr Rajesh Rai as Chairman & Managing Director (CMD) of ITI Limited, a PSU under the Department of Telecommunications (DoT).

UNICEF India Appoints Bollywood Actor Ayushmann Khurrana as National Ambassador for Child Rights



The United Nations Children's Fund (UNICEF) India named Hindi film star Ayushmann Khurrana as a National Ambassador.

As a National Ambassador, Khurrana will support UNICEF in ensuring rights of every child "to survive, thrive, be protected as well as promoting their voice and agency in decisions that concern them.

ASSOCHAM appoints Sanjay Nayar as the new vice-president

Associated Chambers of Commerce and Industry (ASSOCHAM) has appointed global financial markets expert Sanjay Nayar as its new vice president.

Mr. Nayar is a senior finance professional in the Indian Private Equity and Banking landscape with nearly four decades of experience in the Global and Indian financial markets.

US nominates former Mastercard CEO Mr. Ajay Banga for World Bank president

United States (US) President Mr. Joe Biden has nominated former Mastercard chief executive Mr. Ajay Banga as president of the World Bank.



completing his tenure in April 2024.

Notably, he is the first Indian-born nominee for the role of World Bank President.

He would replace Mr. David Malpass, who will step down from his role this June before

Mr. Ajay Banga was born in Pune, Maharashtra, India.

He is the Honorary Chairman of the International Chamber of Commerce, serving as Chairman from 2020-2022.

India's CAG Mr. Girish Chandra Murmu selected as External Auditor of ILO in Geneva

Mr. Girish Chandra Murmu (G.C.Murmu), the Comptroller and Auditor General (CAG) of India, has been selected as External Auditor of the International Labour Organization (ILO), Geneva for a 4-year term from 2024 to 2027.



He will take over from the incumbent External Auditor of ILO, Jose Callangan Calida,

Chairperson of the Commission on Audit (COA), the Supreme Audit Institution of the Philippines.

Myntra appointed Ranbir Kapoor as a brand ambassador

Flipkart-owned Myntra Designs Private Limited has appointed Indian Bollywood actor Ranbir Kapoor as its brand ambassador.



Kapoor will be seen focusing on men's fashion wear, in its upcoming brand campaign.

Kapoor joins Tamannaah Bhatia and Vijay Deverakonda in representing the brand.

Shamika Ravi appointed as member of EAC-PM



Economics professor and researcher Shamika Ravi has been appointed as a member of the Economic Advisory Council to Prime Minister (EAC-PM)

Currently, Shamika Ravi is non-resident senior fellow of the governance studies program at the Brookings Institution Washington D.C.

Canara bank appoints Mr. K Satyanarayana Raju as the new MD & CEO



The Government of India (GoI) appointed Shri. K Satyanarayana Raju as Managing Director (MD) and Chief Executive Director (CEO) of Canara bank.

He replaced L V Prabhakar who demitted office on December 31, 2022.

Earlier, he had served Canara Bank as Executive Director since March 10, 2021.

President Droupadi Murmu appoints 6 new governors & reshuffles 7 others



President of India Droupadi Murmu appointed governors in 12 states and a Union Territory (UT).

These include the 6 new appointments & 7 reshuffles.

List of 6 new appointed Governors :

1. Lt. General Kaiwalya Trivikram Parnaik – governor of Arunachal Pradesh.
2. Lakshman Prasad Acharya – governor of Sikkim.
3. C.P. Radhakrishnan – governor of Jharkhand.
4. Shiv Pratap Shukla – governor of Himachal Pradesh.
5. Gulab Chand Kataria – governor of Assam.
6. Justice (Retd.) S. Abdul Nazeer – governor of Andhra Pradesh.

List of 7 Reshuffled Governors :

1. Biswa Bhusan Harichandan, the governor of Andhra Pradesh has been appointed as governor of Chhattisgarh.
2. Sushri Anusuiya Uikye, currently governor of Chhattisgarh will take over as governor of Manipur.
3. La. Ganesan, governor of Manipur will now be the governor of Nagaland
4. Phagu Chauhan, governor of Bihar is now the governor of Meghalaya
5. Rajendra Vishwanath Arlekar, governor of Himachal Pradesh will take over as governor of Bihar.
6. Ramesh Bais, governor of Jharkhand has been appointed as governor of Maharashtra.
7. Brig. (Dr.) Shri B.D. Mishra (Retd.), governor of Arunachal Pradesh has now been appointed as Lt. governor of Ladakh.

This comes as the resignations of Maharashtra governor Bhagat Singh Koshiyari and lieutenant governor of Ladakh RK Mathur have been accepted by President of India Droupadi Murmu.



Former foreign minister Nikos Christodoulides elected as President of Cyprus

Former foreign minister, Nikos Christodoulides, has been elected the 8th president of Cyprus, beating the career diplomat Andreas Mavroyiannis. He will take up his new role on March 1, 2023.

He will Succeed Nicos Anastasiades.

Christodoulides (49) won 51.92% of the vote compared with 48.09% for his opponent.



Mohd Shahabuddin Chappu set to become 22nd President of Bangladesh

Former judge and freedom fighter, Mohammad Shahabuddin Chappu, has been declared as the next president-elect of Bangladesh by the country's Election Commission.

He will be the 22nd President of Bangladesh

Centre notifies appointment of Chief Justices for 4 high courts of Gujarat, Tripura, Gauhati, J-K and Ladakh



The Ministry of Law and Justice, Government of India (GoI) notified the appointment of Chief Justices (CJ) in 4 High Courts namely, Gujarat High Court, Tripura High Court, Gauhati High Court and Jammu-Kashmir and Ladakh High Court.

They are appointed in exercise of the powers conferred by clause(1) of Article 217 of the Constitution of India.

List of 4 Chief Justices :

Justice Name & Current High Court	Appointed as CJ to
Ms Sonia Giridhar Gokani, Judge, Gujarat High Court	Chief Justice of Gujarat High Court
Shri Justice Jaswant Singh, Judge, Orissa High Court	Chief Justice of Tripura High Court
Shri Justice N. Kotiswar Singh, Judge, Gauhati High Court	Chief Justice of the High Court of J & K and Ladakh.
Shri Justice Sandeep Mehta, Judge, Rajasthan High Court	Chief Justice of Gauhati High Court

Justice **Giridhar** would be the **first woman** to head the Gujarat High Court.

India has **25 high courts**.

Also, the Union of India notified the appointments of 2 more judges to the Supreme Court of India.

The Government issued a notification of the appointment of **Justice Rajesh Bindal** and **Justice Aravind Kumar** as Judges of the Supreme Court.

With their appointment, the apex court will have a full working strength of **34 judges**.



ICAI Elects Mr Aniket Sunil Talati as New President & Mr Ranjeet Kumar Agarwal as Vice President for the Year 2023-24

The Institute of Chartered Accountants of India (ICAI) has elected Chartered Accountant (CA) Mr Aniket Sunil Talati as President of ICAI & CA Mr Ranjit Kumar Aagarwal as Vice President (VP) for the year 2023-24.

Both will be responsible for organising the **three-tiered CA exam** and looking after all administrative affairs.

Moldovan PM Ms Natalia Gavrilita resigns & Mr Dorin Recean appointed as new PM of Moldova



Moldovan Prime Minister (PM) Ms Natalia Gavrilita stepped down from her position citing a lack of support in the former Soviet Republic.

The pro-Western government had been in power for just 18 months (Aug 2021 to Feb 2023). Moldova's President Mr Maia Sandu, appointed former interior minister Mr Dorin Recean as the new Prime Minister (PM).



World Bank Chief Mr. David Malpass to Resign before his Tenure end



Mr. David Malpass would step down from the post of **World Bank (WB) President** by the end of June 2023, before his five-year term expires.

The United States (US), the World Bank's largest shareholder, has always traditionally nominated a citizen of the United States to serve as the president of the World Bank.

His five-year term was due to end in April 2024.

GENERAL AWARENESS SMART ANALYSIS

Specially for SBI Clerk & SBI PO Mains 2022-23

- ✓ Good Standard Questions based on Recent Mains Examination
- ✓ Topic-wise Performance comparison (Part-1 Vs Part-2)
- ✓ Detailed Performance Analysis on Each Current Affairs Topics
- ✓ Possibilities of Questions from each topic
- ✓ Check the Questions instantly which you missed out
- ✓ Revise and Re-attempt the questions on the solution page

Extra
10% Off

USE CODE
GUIDELY10

1
Year
Validity

Grab It Now







ACQUISITIONS & MERGERS

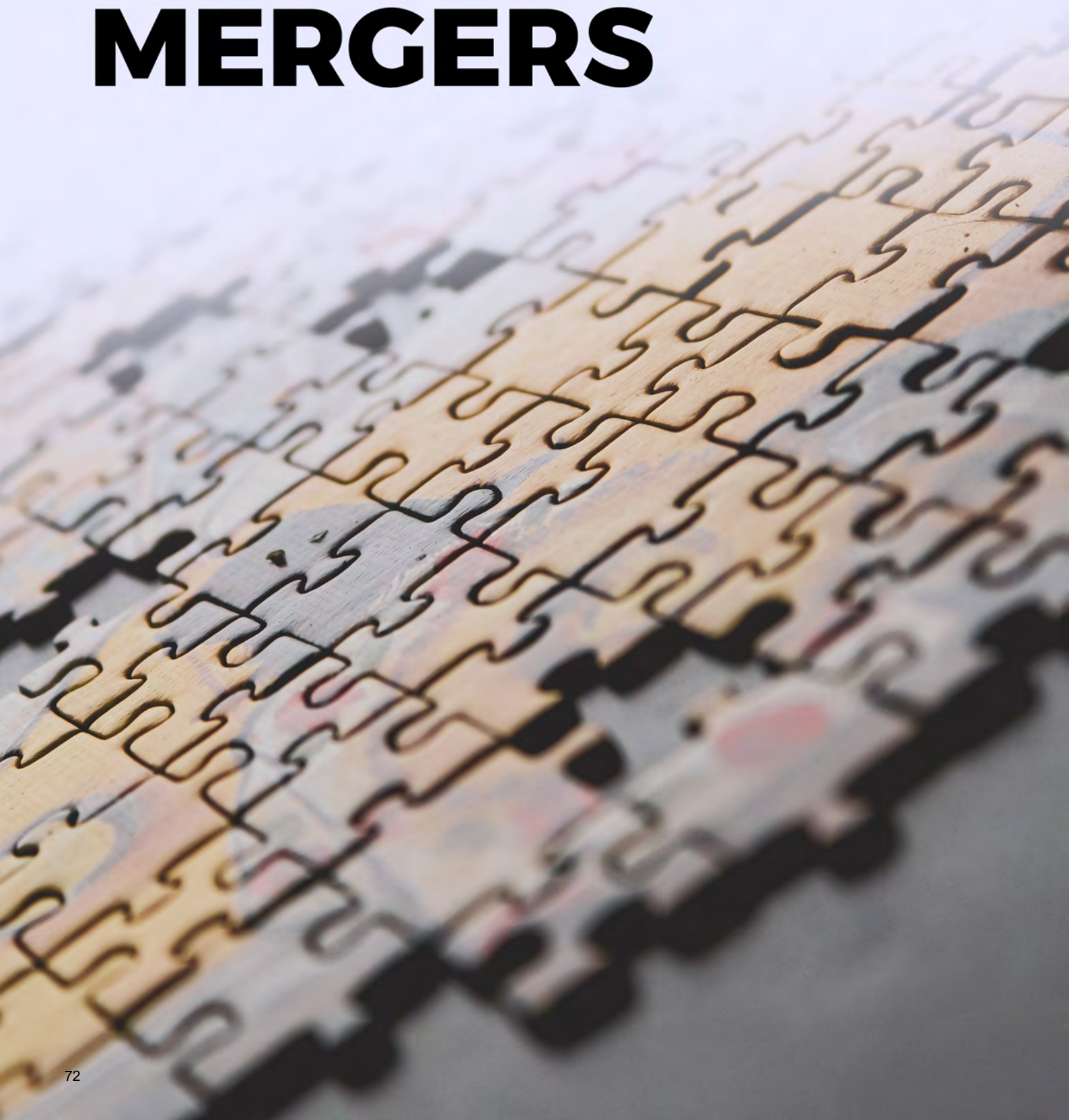

Tata Steel to merge 7 firms by FY24

Tata Steel Chief Executive Officer (CEO) and managing director (MD) **TV Narendran** stated that the **merger of 7 subsidiary companies** with Tata Steel is expected to be completed in **2023-24 fiscal year (FY24)**.

The plans were announced earlier in **September, 2022**.

The 7 subsidiaries to be merged with Tata Steel : **Angul Energy, Tata Steel Long Products, The Tinplate Company of India, Tata**



Metaliks, TRF, Indian Steel & Wire Products and Tata Steel Mining and S&T Mining Company.

China's Alibaba Group sells its entire stake holdings of 3.16% stake in Paytm

Chinese company **Alibaba** is learnt to have **sold 3.16% direct stake** or 2.1 crore shares in digital financial services firm **One97 Communications Limited (OCL)**, which operates under **Paytm** brand, for about **Rs 13,600 crore** in a block deal.

At the end of December 2022, Alibaba had **6.26% stake** in the fintech firm and sold around 3.1% of it in January, 2023.



In November 2022, the Japanese **SoftBank Group** sold **29 million shares** of Paytm, or a **4.5% stake**, worth about **\$200 million** through a block deal.

Private wireless network companies to invest \$250 million by 2027: Nokia MBIT report

India's total spend on private wireless networks is expected to reach around **\$250 million** by 2027, which will have 2,000+ sites for private wireless networks by then, a **Nokia's annual Mobile Broadband Index (MBIT) report**. It also said with **5G gaining momentum** since the first



launch in October, 4G and 5G data combined account for nearly 100 per cent of the mobile data traffic.

Zomato launches The Shelter Project, a network of rest points for delivery partners



Food delivery major **Zomato** has launched **The Shelter Project**, under which the company has started building public infrastructure (called Rest Points) to support the entire gig economy and delivery partners of various companies.

Carlsberg's India & Nepal partner to sell entire 33% stake at ₹6,155 cr to brewer



Danish brewer **Carlsberg** has stated that the **Khetan Group** which owns **33% shares** in the holding company which manages businesses in **India and Nepal** has put a formal notice to sell its entire stake to the brewer for **\$744 million (₹6,155 crore)**.

Carlsberg is the third **largest brewer globally** and **Carlsberg South Asia Pte Ltd (CSAPL)** is the holding company for India businesses (**100%**) and Nepal (**90%**).



DEFENCE



IAF develops indigenous 'Vayulink' platform for jammer-proof communication

The Indian Air Force (IAF) has developed an innovative indigenous platform 'Vayulink' that would help pilots in dealing with bad weather and also provide jammer-proof uninterrupted communication with the base station.

Vayulink is an ad-hoc data link communication system.

It uses the Indian Regional Navigation Satellite System (IRNSS) that is also known as NAVIC, to send radio communication to the base



station when the signals are low Vayulink, when installed in an aircraft, gives the position of other aircraft close by encrypted traffic data over a secure channel.

4th edition of India-Japan joint military exercise 'Dharma Guardian' 2023 begins



The 4th edition of the annual joint military exercise, "EX DHARMA GUARDIAN", between India and Japan is being conducted at Camp Imazu in Shiga province, Japan from 17 February to 02 March 2023.

Troops of the Garhwal Rifles Regiment of the Indian Army and an Infantry Regiment from the Middle Army of the Japan Ground Self Defence Force (JGSDF) will be participating in the exercise.

4th edition of India-Uzbekistan Joint Military Exercise - Dustlik begins in Uttarakhand

The 4th edition of annual bilateral joint military exercise Exercise DUSTLIK (2023) between the India-Uzbekistan military training is being conducted from 20 February, 2023 till 5th March, 2023 (14 days) in Pithoragarh, Uttarakhand.



2023 (14 days) in Pithoragarh, Uttarakhand.

INS Sumedha Visits Abu Dhabi To Participate In IDEX And NAVDEX 23



Indian Naval Ship (INS) Sumedha has participated in NAVDEX 23 (Naval Defense Exhibition) and IDEX 23 (International Defense Exhibition) in Abu Dhabi, United Arab Emirates (UAE).

Indian Army's 'Exercise Topchi' 2023 held in Maharashtra



The Indian Army's 'Exercise Topchi', annual firepower demonstration and training exercise of the Regiment of Artillery was conducted by the School of Artillery at Devlali Field Firing Ranges in Nashik's Devlali, Maharashtra.

The highlight of the exercise was display and firing by indigenously manufactured Artillery equipment viz K-9 Vajra, Dhanush, Indian Field Gun (IFG) / Light Field Gun (LFG) System and Pinaka Multi Barrel Rocket Launchers

The exercise involving the SWATHI radar system has been made in India.



Indian Army organises integrated exercise Trishakti Prahar in North Bengal

The Indian military concluded exercise **Trishakti Prahar** – 10-day joint training exercise in the strategically vital Siliguri corridor, in **North Bengal**.

To practise battle preparedness of using the latest weapons and equipment in a networked environment, involving all arms and services of the **Indian Army**, the **Indian Air Force (IAF)** and **central armed police forces (CAPF)**.

The fire power exercise was reviewed by **Lt Gen R P Kalita**, Army Commander, Eastern Command.



Special Beginners' Bundle Quiz

- ✔ Specially for Beginners (Basic Level)
- ✔ 5000+ Questions
- ✔ Covered All Topics
- ✔ Best Source to Practice Basic Questions

Guidely's Special Beginners' Kit (Printed Edition)



Extra **10%** Off

USE CODE **GUIDELY10**

Grab It Now

MOUs & AGREEMENT

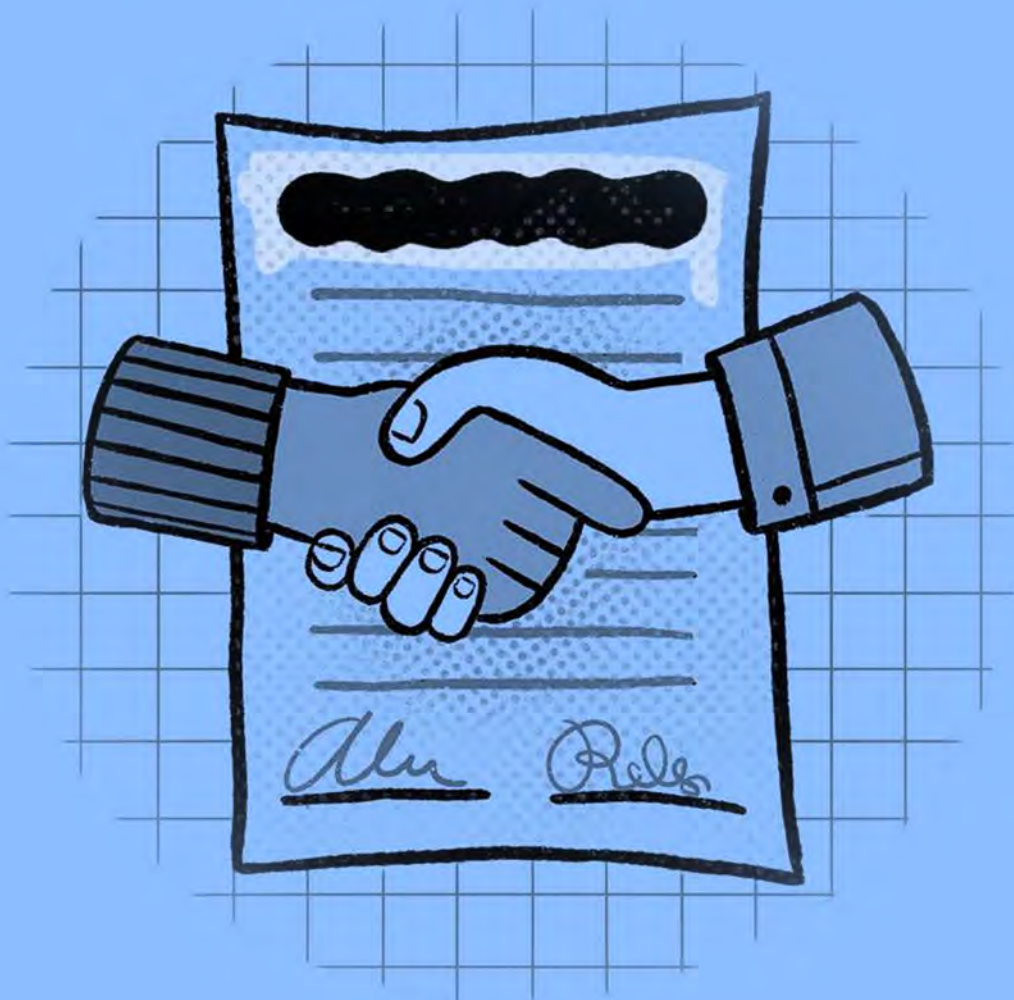



Ola signs MoU with T.N. to set up 'world's biggest' EV hub



Polycab has announced an official partnership with ICC.

Polycab India Limited. (Polycab), India's leading electrical goods company with a consolidated turnover of INR 122+ billion in FY22, announced an official partnership with the International Cricket Council (ICC).

The partnership will include

Polycab's sponsorship of all major men's and women's ICC global events scheduled until the end of 2023, including the ICC Women's T20 World Cup in South Africa, the ICC World Test Championship Final in the United Kingdom and the ICC Men's Cricket World Cup 2023 scheduled in India.

Ola Electric Mobility Pvt Ltd (OEM) signed an MoU with the Tamil Nadu government to set up a cell manufacturing plant and electric 4-wheeler manufacturing plant in SIPCOT Pochampalli, Bargur, Krishnagiri district at a combined investment of ₹7,614 crore.

India and Spain agreed to collaborate on digital infrastructure, climate action, and sustainable development

India and Spain agreed to collaborate on digital infrastructure, climate action, and sustainable development.

Prime Minister Narendra Modi and his Spanish counterpart Mr. Pedro Sanchez agreed to strengthen the growing relationship between both countries. Both leaders discussed many bilateral and international issues of mutual interest.

India and Spain leaders reviewed ongoing bilateral initiatives and expressed satisfaction at the recent high-level exchanges.



Both leaders agreed to collaborate on issues such as digital infrastructure, climate action, clean energy transition, and sustainable development.

The manufacturing facilities will be set up through OEM's subsidiaries Ola Cell Technologies Pvt Ltd and Ola Electric Technologies Pvt Ltd. The new manufacturing facilities will provide direct employment for 3,111 persons.

Raftaar Reasoning Batch 1.0

- ✓ 40+ Class of Live Session
- ✓ Topic PDF By Faculty
- ✓ 5 Days Class (Mon - Fri)
- ✓ Class Time 5 Pm
- ✓ Content English & Hindi
- ✓ Exam Covered SBI, IBPS PO / Clerk, RRB PO Clerk
- ✓ Zoom 1 - 1 Interaction

1 Year Validity

Mr. Rohit Sir
Reasoning Expert
5+ Years

Extra **10% Off**

USE CODE **GUIDELY10**

Grab It Now

India, Seychelles sign pact on information sharing in maritime security



In order to further the existing cooperation in the realm of maritime safety and security, IFC-IOR signed an MoU with Regional Coordination Operations Centre (RCOC), Seychelles.

IFC-IOR, hosted by the Indian Navy, was established by the Government of India at Gurugram on 22 Dec 2018 to enhance collaborative maritime safety and security in the Indian Ocean Region in line with India's vision of Security and Growth for All in the Region (SAGAR).



India and Fiji sign MoU on visa exemption for holders of diplomatic and official passports



India and Fiji on signed a Memorandum of Understanding (MoU) on visa exemption for holders of diplomatic and official passports.

S Jaishankar also thanked the Fiji government for partnering with India for the 12th World Hindi Conference.

The external affairs minister is on an official visit to Fiji from February 15-17 to attend the 12th World Hindi Conference in Nadi.

The main theme of the Conference is 'Hindi: From Traditional Knowledge to Artificial Intelligence'.



SCIENCE

&

TECHNOLOGY



NASA hands over payload of NISAR satellite to ISRO

The National Aeronautics Space Administration (NASA) handed over the payload for the NISAR (NASA-Isro Synthetic Aperture Radar) satellite to Indian Space Research Organisation (ISRO).

NISAR, is an earth science satellite & jointly built Synthetic aperture radar (SAR) by NASA and the ISRO.



IIT Madras to receive grant worth Rs 242 crore for research on Lab Grown Diamonds

The Union Government has chosen the Indian Institute of Technology-Madras (IIT-M) for undertaking research on Lab Grown Diamonds (GDs) and will provide a grant of Rs. 242 crore over a period of 5 years.



The India Centre for Lab Grown Diamonds (InCent-LGD) at IIT-Madras was identified for this prestigious project based on our nearly two decades of work

experience in diamond research wherein we have developed many technologies for industry, space and defence sectors.

Qualcomm launched world's first satellite-based two-way messaging solution - Snapdragon Satellite

Qualcomm Technologies, Inc. has introduced the world's first satellite-based two-way capable messaging solution for premium smartphones, called Snapdragon Satellite, at the Consumer Electronics Show (CES) 2023.

Qualcomm and global satellite communications company, Iridium, have entered into an



agreement to bring the satellite-based connectivity to next-generation premium Android smartphones.

Jupiter becomes a planet with most moons with 12 newly discovered

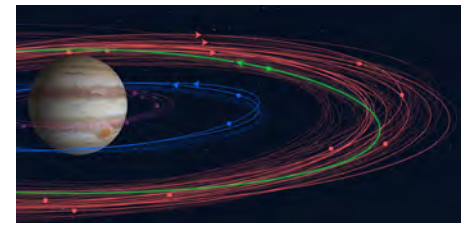

With the discovery of 12 new moons, Jupiter becomes the planet with the highest number of moons. With this, the count of Jupiter's moons increased to 92 from 80 moons. Saturn is in the second position with 83 moons.

ISRO launches SSLV-D2 rocket with 3 satellites from Sriharikota, AP

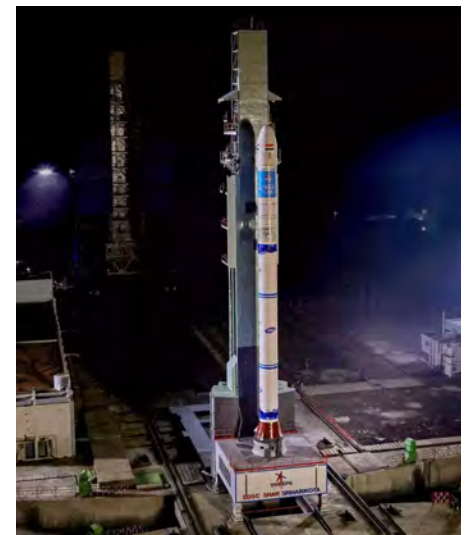

The Indian Space Research Organisation (ISRO) launched the second developmental flight of the Small Satellite Launch Vehicle (SSLV-D2) from the First Launch Pad, Satish Dhawan Space Centre, Sriharikota, Andhra Pradesh (AP).

India's first mission to study the sun Aditya-L1 is to be launched by June-July 2023

For the first time in the history of India, the Indian Space Research Organisation (ISRO) is set to launch a scientific mission to study the sun - Aditya-L1 mission in June or July, 2023.

Aditya L1 is India's first space-based mission to observe the Sun and the solar corona.

To study the sun from a halo orbit around the Sun-Earth system's Lagrangian point 1 (L1).

Scientists at the Indian Institute of Astrophysics (IIA), Bengaluru



have spent over 15 years building and assembling nearly 40 different optical elements in a payload.

World's First Cloud-Built Demonstration Satellite - JANUS-1 Launched By ISRO's mini-Rocket SSLV-D2

JANUS-1 satellite that rode on Indian Space Research Organisation's (ISRO's) new mini-rocket SSLV-D2 and reached its orbit successfully.

JANUS-1 satellite is the world's first satellite fully conceived, designed and manufactured using an Indian company's end-to-end cloud platform.

Integration and test for JANUS-1 has been conducted in Bengaluru by Ananth Technologies Ltd (ATL).

JANUS-1 is a software defined



6U technology demonstration satellite designed and built using the Antaris cloud software platform and SatOS software, as well as XDLinx's modular spacecraft bus.

Velocity launches India's 1st ChatGPT-integrated AI chatbot - Lexi

Homegrown financial technology firm Velocity launched India's first Artificial Intelligence (AI) chatbot integrated with OpenAI's ChatGPT, called "Lexi".

Velocity has integrated this



latest advancement in AI with its existing analytics tool, Velocity Insights.



IIT Patna Partners with Drone Destination to open Bihar's 1st govt-approved UAV training center

One of India's leading unmanned aerial vehicle (UAV) training and manufacturing groups, Delhi-based Drone Destination (DD) Private Limited, has signed a memorandum of Understanding (MoU) with the Indian Institute of Technology (IIT) Patna to open Bihar's first government-approved drone training hub.

NASA developed heartbeat-detecting tech to help with Turkey's earthquake relief effort



The National Aeronautics and Space Administration (NASA) has developed a technology that can remotely detect the tiniest motions of the body that will be used by disaster relief teams in earthquake-stricken Turkey.

The devices, called FINDERS (Finding Individuals for Disaster Emergency Response).

IBM has partnered with NASA to gain new findings on Earth's climate:

IBM has partnered with NASA to gain new findings on Earth's climate through the power of AI technology.

The two organizations will use AI tech developed by IBM together with the large amounts of Earth observation and geospatial data that NASA has available to share.

Earth observation is the gathering

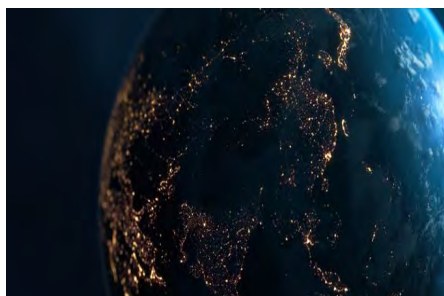

of information about Earth's physical, chemical, and biological systems, usually through the use of satellite imaging.

India first hybrid sounding rocket launched in Chengalpattu

India's first hybrid sounding rocket made by the school students from various states launched as part of Dr APJ Abdul Kalam Satellite Launch Vehicle Mission 2023 from Pattipulam Village in Chengalpattu, Tamil Nadu (TN).

It was launched in the presence of Tamilisai Soundararajan, Governor of Telangana and Lieutenant Governor of Puducherry.

The Dr APJ Abdul Kalam Satellite Launch Vehicle Mission- 2023



has been launched by Martin Foundation in association with Dr APJ Abdul Kalam International Foundation and Space Zone India.

NASA to launch Israel's 1st space telescope mission in 2026

The United States (US) National Aeronautics and Space Administration (NASA) and Israel's Ministry of Innovation, Science and Technology signed a partnership that will send Israel's first space telescope mission, the Ultraviolet Transient Astronomy Satellite (ULTRASAT) in early 2026.

The Israel Space Agency and the Weizmann Institute of Science are behind the premier project.

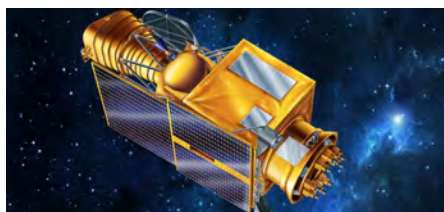

ULTRASAT is an ultraviolet observatory with a large field of view that will investigate the secrets of short-duration events in the universe, such as supernova explosions and mergers of neutron stars.



World's highest weather station rebuilt on Mount Everest

The World's highest altitude weather station has been rebuilt on Mount Everest.

World's highest weather station was destroyed due to hurricane-winds on Mount Everest.

A team of scientists and Sherpa have again placed its new version & the group has been led by a 31-year-old electrician and mountain guide Tenzing Gyalzen Sherpa.

World-first 'super' magnets for fusion plant testing



Tokamak Energy has built a world-first set of high-temperature superconducting (HTS) magnets, to be assembled and tested in fusion power plants-relevant scenarios.

The new Demo4 facility will consist of 44 individual magnetic coils recently manufactured using 38 km of HTS tape, which carries currents with zero electrical resistance and requires 5 times less cooling power than traditional superconducting materials.

AWARDS & HONORS



The Hindu Group bags four WAN-IFRA Digital Media South Asia Awards 2022

The Hindu Group has bagged four awards at the WAN-IFRA Digital Media South Asia Awards 2022 for its various products and services.

TH Newsletters won silver in Best Digital Subscription initiative and The Hindu e-paper bagged gold in Best ePaper concept.

In the Best Use of Short Form Video category, Trending and Current Affairs, The Hindu won gold award.

World Association of News Publishers (WAN-IFRA)



recognises outstanding digital media projects delivered by south Asian news publishers.

The Quint, The Hindu, Prothom Alo and The Indian Express emerged as the award winners.



NTPC has bagged "ATD Best Awards 2023"

NTPC has bagged "ATD Best Awards 2023" for the sixth consecutive year.

NTPC has been awarded by the Association for Talent Development (ATD), USA.

NTPC has won this award for demonstrating enterprise success in the field of talent development.

Rakhi Kapoor has won the Golden Book Awards 2023 in the category Powerful Relationship Guide

Rakhi Kapoor has won the award for her book "Now You Breathe - Overcoming Toxic Relationships and Abuse" in the category Powerful Relationship Guide.

Now You Breathe is author Rakhi Kapoor's twenty-fifth book.

The Golden Book Awards is one of Asia's prestigious award programs that celebrates the best works on literature.



Former PM Manmohan Singh Conferred With Lifetime Achievement Honour In UK



"Raja Ram Mohan Roy National Award" will be given to the Veteran Journalist Dr. ABK Prasad:

The prestigious "Raja Ram Mohan Roy National Award" will be given to the Veteran Journalist Dr. ABK Prasad.

He has been selected for the prestigious "Raja Ram Mohan Roy National Award for Excellence in Journalism-2020" for his outstanding contribution to the



field of journalism.

Former prime minister Dr Manmohan Singh was recently conferred a Lifetime Achievement Honour by the India-UK Achievers Honours in London for his contribution to economic and political life. The Honour, announced at an awards ceremony last week, will be handed over to Dr Singh in New Delhi by the National Indian Students and Alumni Union (NISAU) UK at a later date.

Rayyana Barnawi Becomes First Woman Astronaut from Saudi Arabia to Visit Space Station

Rayyana Barnawi will be the first woman astronaut from Saudi Arabia to Visit International Space Station (ISS). She will join fellow Saudi male astronaut Ali Al-Qarni on a 10-day mission to the International Space Station (ISS) “during the second quarter of 2023”.

She also has around 9 years of experience in Research for **Cancer Stem Cells** and worked as a research laboratory technician. The astronauts “will join the crew



of the **AX-2 space mission**” and the space flight will “launch from the USA”

Angela Merkel receives UNESCO Peace Prize in Ivory Coast

Angela Merkel has been awarded the Felix Houphouet-Boigny UNESCO Peace Prize in Yamoussoukro, the capital of the Ivory Coast.

The jury for **Felix Houphouet-Boigny Peace Prize** was impressed by Merkel’s courageous decision in 2015 to open her country to refugees.

2018 Nobel Peace Prize laureate Denis Mukwege was the jury president.

Former German chancellor



Angela Merkel said she will donate the prize money to an Ivorian NGO called “**L’enfance en danger.**”

Union Home Minister Amit Shah to present President’s Colour Award to Haryana Police

Union Home Minister will present the **President’s Colour Award** to the state police at a ceremony at the **Haryana Police Academy.**

The **President’s Colour** is one of the highest honour that can be awarded to any military unit, military training establishments, and state/UT Police Forces of



India. It is bestowed upon in recognition of exceptional service rendered to the Nation, both in peace and in war. It is also known as “**Rashtrapati ka Nishaan**” in Hindi.



TCS Named to World’s Most Admired Companies List by FORTUNE® Magazine

Tata Consultancy Services (TCS) has been named to FORTUNE® magazine’s list of the World’s Most Admired Companies.

Regarded as a barometer of corporate reputation, the list is based on a survey of business executives, directors and analysts around the globe.

Writer Subhash Chandran bagged the Akbar Kakkattil award

Arenowned writer Subhash Chandran bagged the **Akbar Kakkattil award** for his novel ‘**Samudrasila**’.

Samudrashila was published by Mathrubhumi books.



Karnataka Bank wins 'Prathista Puraskar – Digidhan Award' from MeitY

Karnataka Bank has won Prathista Puraskar under Digidhan Awards 2021-22.

The bank has won the award for highest percentage in BHIM-UPI transactions in private sector bank category.

The bank has won Prathista Puraskar under Digidhan Awards 2021-22 by the Union Ministry



of Electronics and Information Technology.

Dadasaheb Phalke International Film Festival Award Ceremony was held in Mumbai

The Dadasaheb Phalke International Film Festival Award Ceremony was held. The grand celebration took place at Taj Lands End in Mumbai.

The Indian drama film '**Kashmir Files**' was honoured with the 'Best Film' award at the festival. This tragic tale has been directed by Indian filmmaker Vivek Ranjan Agnihotri.

Along with this, the iconic actor Anupam Kher took the Most Versatile Actor Of The Year award for the film.

The list of all the winners who won the prestigious level awards at the Dadasaheb Phalke International Film Festival 2023 is mentioned below.

1. Outstanding Contribution In The Film Industry – Rekha
2. Best Film – The Kashmir Files
3. Most Versatile Actor Of The Year – Anupam Kher for The Kashmir Files
4. Best Actor – Ranbir Kapoor for Brahmastra: Part 1
5. Best Actress – Alia Bhatt for Gangubai Kathiawadi
6. Best Director – R Balki for Chup: Revenge of The Artist
7. Best Web Series: Rudra – The Edge of Darkness
8. Critics Best Actor – Varun Dhawan for Bhediya
9. Film of The Year – RRR
10. Television Series of The Year – Anupamaa
11. Best Male Singer – Sachet Tandon for Maiyya Mainu
12. Best Female Singer – Neeti Mohan for Meri Jaan

About Dadasaheb Phalke Award

India's most prestigious award is Dadasaheb Phalke Award in the cinematic industry.

It is conducted on annual basis by the Directorate of Film Festivals, an organisation which is established by the Ministry of Information and Broadcasting



Indian-origin software engineer wins top National Geographic photography contest

National Geographic has announced the winners of its annual Picture of the Year awards.

Indian origin **Karthik Subramaniam** has been declared winner for his photo titled "**Dance of the Eagles**".

Sajjan Jindal has won the EY Entrepreneur of the Year Award

Sajjan Jindal has won the EY Entrepreneur of the Year Award 2022.

Sajjan Jindal, Chairman and Managing Director, JSW Group, has been awarded the EY Entrepreneur of the Year 2022.

He will now represent India at the EY **World Entrepreneur of the Year Award (WEOY)** in Monte Carlo in June 2023.

The 7-member jury led by **K V Kamath**, former Chairman of **ICICI Bank**, selected Jindal as the EOY 2022 winner.



RANKING & REPORTS



With \$10.8 billion, Bengaluru top city on start-up funding in 2022

Bengaluru topped the startup funding chart in India with \$10.8 billion in 2022, followed by Mumbai at \$3.9 billion, and Gurugram at a distant \$2.6 billion.

Startups based in Delhi and Chennai registered \$1.2 billion each in funding, followed by Pune at \$1 billion, according to data provided by Tracxn, a leading global market intelligence platform.



Indore Municipal Corporation, ranked top in cleanliness survey for six consecutive years:



Indore Municipal Corporation, ranked top in cleanliness survey for six consecutive years, has become the country's second civic body to launch green bonds, seeking to raise Rs 244 crore for a 60-mw solar plant at its water pumping station.

The issue will be listed on the National Stock Exchange.

Indore's green bonds, which have been rated AA+ by India Ratings and AA by Care Ratings, are in the form of four strips.

India drops to third spot in MSCI EM index amid rout in Adani group stocks

India's ranking on the MSCI (Morgan Stanley Capital International) Emerging Markets (EM) Index, which is said to be tracked by passive funds with assets under management of more than \$350 billion, has slipped, following last month's underperformance amid rout in Adani Group shares.

With a weighting of 12.97 per cent, India is now ranked third after



China and Taiwan which have a weighting of 33.49 per cent and 14.42 per cent, respectively.

PM Modi emerges as world's most popular leader, with approval rating of 78%

Prime Minister Narendra Modi has been pegged as the world's most popular leader with an approval rating of 78 per cent as per a survey by a US-based consulting firm 'Morning Consult.'

As per the rating PM Modi's ratings trump those of other leaders including US President Joe Biden, French President Emmanuel



Macron and UK Prime Minister Rishi Sunak.

India ranks 42 among 55 countries on International IP Index



India ranks 42nd among 55 leading global economies on the recently released International IP Index.

It is released annually by the US Chamber of Commerce.

The index evaluates IP rights in 55 global economies across 50 unique indicators.

Mumbai, Bengaluru among five best performing residential markets in APAC: Knight Frank

Mumbai and Bengaluru are among five best performing residential markets in Asia Pacific in terms of annual price growth with 7 per cent increase in rates in both the cities, according to Knight Frank.

In its Asia-Pacific Residential Review Index, real estate consultant Knight Frank said that **Mumbai and Bengaluru** have found place in the top five best performing **Asia-Pacific residential markets** in terms of annual price growth in **H2 (second half) of 2022**.

As many as 14 out of 23 Asia-Pacific (APAC) cities have recorded positive annual price growth with **Metro Manila ranked as the best-performing Asia-Pacific market with 24 per cent**



year-on-year (YoY) growth.

Singapore was at second position with 9.3 per cent growth in price, while Tokyo ranked third with 9 per cent appreciation in residential prices.

Mumbai and Bengaluru shared the **4th position** on the **Asia-Pacific Residential Review Index** as both registered a price growth of **7 per cent YoY (year-on-year)** in H2 2022.



FT MBA Rankings 2023: Top 6 Indian business schools feature in the list

IIMs Indore and Lucknow have secured their place in the Master of Business Administration (MBA) 2023 rankings released by the Financial Times.

According to the rankings released by the FT, the Indian School of Business (ISB) and Indian Institutes of Management at Ahmedabad, Bangalore, Calcutta Indore and Lucknow make it to the list.

This year, the ISB slipped to 39th rank from 32nd IIM Ahmedabad improved its position to 51 from 62 in 2022.

However, ISB managed to retain its **No. 1 position** in India.

These include the Indian School of Business (ISB) Hyderabad (39th), Indian Institute of Management (IIM) Ahmedabad (51), IIM Bangalore (52), IIM Calcutta (76), IIM Indore (89) and IIM Lucknow (90).

India Ranks Fourth In Quality Entrepreneurship Ecosystem:

India has been ranked **fourth out of 51 countries** in having a quality entrepreneurship ecosystem reflecting the steady rise in the **nation's business environment over the years**.

It's ranking of India in the **Global Entrepreneurship Monitor (GEM) National Entrepreneurship Context Index (NECI)** report is a drastic turnaround following a much **lower score in 2021 which was 16th overall**.



**BO
OKs**

& Author

Dr Peggy Mohan has bagged the 'Mathrubhumi Book of The Year' award:



Author Dr Peggy Mohan has bagged the 'Mathrubhumi Book of The Year' award at the fourth edition of Mathrubhumi International Festival of Letters (MBIFL 2023).

Her book 'Wanderers, Kings and Merchants,' portraying the evolution of language as the outcome of migrations, and won the award that carries Rs two lakh as a cash prize and a sculpture.

Salman Rushdie releases new novel six months after stabbing attack

Author Salman Rushdie has launched his new novel called "Victory City" nearly six months after a man repeatedly stabbed the writer onstage during a lecture in New York state.

Rushdie's 15th novel "Victory City" is published by Penguin Random House and takes the form of a translation of



a mythical epic originally written in Sanskrit about the Vijayanagara Empire that ruled over much of southern India in the 14th century.

A new book titled 'Best of Satyajit Ray' has been released by Penguin India

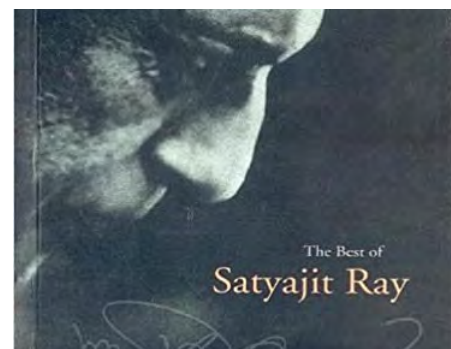

A new book titled 'Best of Satyajit Ray' has been released by Penguin India on Satyajit Ray

The 'Best of Satyajit Ray' has 21 best short stories of Satyajit Ray. It also has all eight stories that Satyajit Ray translated himself into English.

JP Nadda launches book 'Modi: Shaping a Global order in flux'

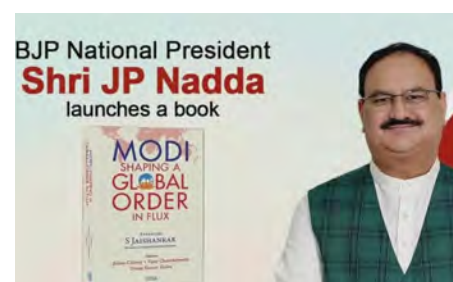

BJP national president JP Nadda launched a book "Modi: Shaping a Global Order in Flux" in Chanakyapuri. Book is forwarded by Union External Affairs Minister S. Jaishankar.

Editors are **Sujan Chinoy, Vijay Chauthaiwala, and Uttam Kumar Sinha.**

Rudra 3.0 Complete Quant Batch For Bank & Insurance Exam 2022

80 दिन में पुरी quant की तैयार

- ✓ Exact Exam Level Content From Zero to Mains
- ✓ Learn Smart Approach to Score Max
- ✓ 80+ Live Classes + PDFs + (Recorded Form also Available)
- ✓ Topic Wise + Level Wise (DI + Arithmetic)
- ✓ Practice Test Available

Extra **10%** Off

USE CODE **GUIDELY10**

Grab It Now

SPORTS



Hockey World Cup: Germany lifts title, Netherlands finishes 3rd

Germany beat Belgium 5-4 in the penalty shootout to win the **FIH Men's Hockey World Cup 2023** at the Kalinga Stadium in Bhubaneswar, India.

Jean-Paul Danneberg proved to be the hero for Germany as the goalkeeper made three saves in the penalty shootout.

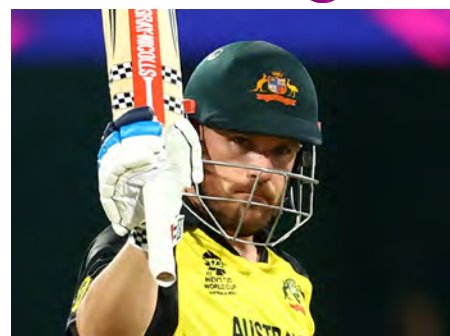

Aaron Finch announces retirement from international cricket

Aaron Finch has announced his retirement from international T20Is.

It has ended his 12-year-long international cricket career.

Earlier, he had announced retirement from the 50-over format in September last year.

Australian Open: Sania Mirza ends her Grand Slam

India's tennis ace **Sania Mirza** signed off her career with six Grand Slam titles after failing to win the Australian Open mixed doubles trophy with compatriot Rohan Bopanna at the Rod Laver Arna in Melbourne.

Coming into her final Major tournament, Sania had six Grand Slam titles - three women's doubles and as many mixed doubles - in her cabinet.



Usman Khawaja bags inaugural Shane Warne Men's Test Player of the Year award

Federation (FIVB) have announced India as the host for the men's Club World Championship for two years.

The champions of the **RuPay Prime Volleyball league** will compete in the **Club World Championship in 2023 and 2024** against some of the top teams from countries like **Italy, Brazil and Iran**.

Sony Sports Network will telecast the matches.



Indian pacer Joginder Sharma from Haryana has announced their retirement



Indian pacer **Joginder Sharma** from Haryana has announced their retirement from all formats of cricket.

The cricketer is known for his exceptional bowling in the T20 World Cup 2007 Final, where India defeated Pakistan to grab the prestigious trophy.

Joginder Sharma played his first international match in an ODI against Bangladesh in Chattogram in 2004.

Ranji Trophy: Saurashtra beat Bengal by 9 wickets to bag the second title

Saurashtra defeated Bengal by nine wickets in the final at the Eden Gardens in Kolkata.

Saurashtra fast bowler **Jaydev Unadkat** was declared player of the match.

Saurashtra has won the Ranji Trophy title for the second time.

Mumbai won the first-ever edition and also won the most Ranji Trophies.



Vignesh and Visakh NR become India's first brothers to become Grandmasters

India's chess player **Vignesh NR** has become India's **80th Grandmaster** after he defeated Germany's IM Ilja Schneider and won the 24th NordWest Cup 2023 at Bad Zwischenahn in Germany.



After IPL, Tata bags title rights for WPL

Tata Group bagged the title rights for the inaugural Women's Premier League beginning in Mumbai on March 4. Tata has secured the rights for five years.

The Indian multinational conglomerate had last year replaced Vivo as the title sponsor for the Indian Premier League.

The first edition will be played in Mumbai across two venues – Brabourne Stadium and DY Patil Stadium.

The sale of media rights had



fetched the BCCI Rs 951 crore and the five teams were sold for Rs 4700 crore.

Sports Minister unveils mascot, theme song, jersey for 3rd edition of Khelo India Winter Games:



In Jammu and Kashmir, the Youth Affairs and Sports Minister Anurag Singh Thakur along with the **Lieutenant Governor of Jammu and Kashmir, Manoj Sinha** and other dignitaries launched the **Mascot, Theme Song and Jersey** for the 3rd edition of Khelo India Winter Games at Raj Bhawan, Jammu.

The beginning of the biggest sporting extravaganza at the world-famous Ski resorts of Gulmarg in the Baramulla district of Kashmir division from the 10th of this month.

The **3rd edition of Khelo India Winter Games is scheduled to be held from the 10th to the 14th of this month** and is supported by the Ministry of Youth Affairs and Sports and is being organised by the Jammu and Kashmir Sports Council as well as the Winter Games Association of Jammu and Kashmir.

The **1st edition of the Khelo India Winter Games took place in 2020 and hosts Jammu and Kashmir topped both editions of the games so far.**

Oval to host ICC World Test Championship 2021-23 final

The International Cricket Council announced that the ICC World Test Championship 2021-23 final will take place at The Oval, London from June 7 to 11.

The reserve day is scheduled on June 12.

New Zealand had won the inaugural edition, defeating India by eight wickets in the 2021 final in Southampton.

Australia leads the nine-team points table for the ongoing cycle



with a healthy points percentage of 75.56, followed by India at 58.93.



32-year-old Jeje Lalpekhlua announces his retirement

32-year-old Jeje Lalpekhlua has announced his retirement.

Jeje represented seven clubs across 13 years and scored 23 goals from 56 games for the National Team.

He is a 2-time Indian Super League winner with Chennaiyin FC, lifting the cup in 2015-16 and 2017-18 and winning the 2015 Emerging Player of the League.

He is the **third-highest Indian goalscorer** in the ISL.

Real Madrid win 2022 FIFA Club World Cup by beating Al Hilal

Real Madrid won the Club World Cup by defeating Saudi Arabia's Al-Hilal by 5-3 in the final in Rabat, Morocco. Madrid last won the club world cup in 2018 while it won the Club World Cup also in 2014, 2016 and 2017.

Madrid also won three Intercontinental Cups in 1960, 1998 and 2002.



The 2023 FIFA Club World Cup has been hosted by Morocco.

Chelsea was the winner of the 2021 FIFA Club World Cup.

Singapore replaces Kazan as host of 2025 World Aquatics Championships

Singapore has been awarded the hosting rights for the 2025 World Aquatics Championships, replacing Russian city Kazan which is hoping to secure the event in 2029.

Kazan was named as host of the 2025 edition in 2019, but the event that features swimming, water polo, diving, artistic swimming, open water swimming and



high diving competitions has now been moved to Singapore.

The **World Championship in Kazan has not been cancelled**, it has been postponed to 2029.

Deepti Sharma becomes first Indian to take 100 T20I wickets

Deepti Sharma has become the first Indian bowler to complete 100 wickets in T20Is. The 25-year-old reached the landmark in the ICC Women's T20 World Cup match against West Indies. The all-rounder has scalped 100 wickets in 89 T20Is.

She surpassed Poonam Yadav, who has taken 98 wickets in 72 games. Overall, **Anisa Mohammad of WI-W is at the top** of the bowling charts with 125 dismissals in 117 games. No India men's player has completed 100 wickets in the shortest format of the game. Yuzvendra Chahal has 91 scalps in 75 matches.



OBITUARY

Veteran lawyer and former Union Law Minister Shanti Bhushan Passed away

Former Union Law Minister and veteran lawyer **Shanti Bhushan** who was a strong voice against corruption and a defender of **civil liberties** passed away at the age of 97.

Shanti Bhushan was an Indian politician and lawyer.

He served as the Law Minister of India holding office at the Ministry of Law and Justice from **1977 to 1979** in the Morarji Desai Ministry.

He authored a book titled **Court-ing Destiny: A Memoir** in 2008.

He became a **founding member**

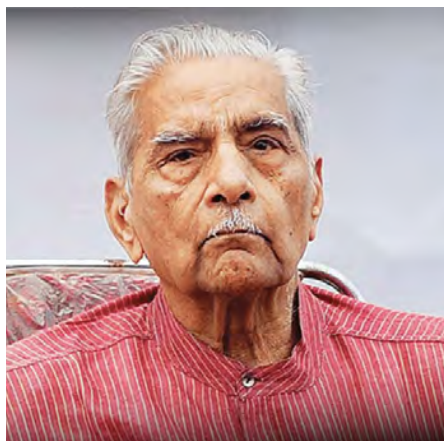

of the **Aam Aadmi Party** after its formal launch on 26 November 2012.

Padma Shri awardee & Veteran director K Viswanath passed away

Veteran film director and Dadasaheb Phalke award winner **Kasinathuni Vishwanath** passed away at the age of 92 in Hyderabad, Telangana.

He was fondly called "**Kalatapasvi**" (a sage of arts).

In 1992 he received the **Raghupathi Venkaiah Award – Lifetime achievement for outstanding contributions to Telugu cinema.**

In **1992**, he was awarded the **Padma Shri**, the fourth-highest civilian award in India.

In **2016**, he received the prestigious **Dadasaheb Phalke award**, the highest recognition in Indian cinema, as the 48th recipient of the award.

In **2016**, he received the prestigious **Dadasaheb Phalke award**, the highest recognition in Indian cinema, as the 48th recipient of the award.



He received **5 National Awards, 20 Nandi Awards** (given by the Andhra Pradesh government), and **10 Filmfare trophies.**

Former Indian National Team Footballer Parimal Dey Passed Away



Former Indian National Team footballer **Parimal Dey** was born on May 4, 1941, **West Bengal.**

He holds the distinction of winning the **Calcutta Football League and IFA Shield double thrice** in **1966, 1970, and 1973.**

He also won the **Durand Cup** (1967, 1970), and **Rovers Cup** (1967, 1969, 1973)

Having played as a forward for East Bengal, he netted **84 goals** and also captained the club in 1968.

He received the lifetime achievement award from East Bengal in 2014.

Legendary Playback Singer & Padma Bhushan Awardee Vani Jayaram Passed Away

A legendary playback singer & Padma Bhushan awardee Vani Jayaram passed away at the age of 78 in Chennai, Tamil Nadu (TN).

Vani Jayaram born on November 30, 1945 in **Vellore, TN**.

She started her career as a singer in 1971 & she recorded her first Telugu song for the film 'Abhimanavanthulu' (1973).

Vani won the **National Film Awards for Best Female Playback Singer three times in 1975, 1980 and 1991**.

She also has won **State Government awards from the states of Odisha, Andhra Pradesh, Tamil Nadu and Gujarat**.



On **January 25, 2023** Vani was bestowed with the **Padma Bhushan**, the **third-highest civilian award** of the country by the Government of India, for her over 50 years of dedication to Indian music.

Delhi Zoo's oldest white tigress Vina Rani died



The **oldest white tigress** at the **National Zoological Park** (also known as the Delhi Zoo), **Vina Rani** died at the age of 17.

She was a **third-generation** white tigress born in the zoo.

Currently there are now 5 white tigers and 4 Royal Bengal tigers at the zoo.

The white tiger or bleached tiger is a leucistic pigmentation variant of the Mainland tiger.

A white tiger has a lifespan of 12 to 14 years in the wild.

Pakistan's former President Pervez Musharraf passed away

Pakistan's former president and military leader **General Pervez Musharraf** (Retd), passed away at the age of 79 in Dubai, United Arab Emirates (UAE).

He **ruled Pakistan from 1999 to 2008**.

He has been declared a **fugitive** in the former Prime Minister Benazir Bhutto murder case and Red Mosque cleric killing case.

He published his autobiography titled **In the Line of Fire: A Memoir in 2006**



He received the **Imtiaz Sanad medal** for gallantry during the Indo-Pakistan war of 1965.

Legendary Oscar- and Grammy-winning composer Burt Bacharach Passed away



Oscar- and Grammy-winning composer, pianist, arranger and producer **Burt Bacharach** Passed away at the age of 94.

He won **3 Oscar awards** in 1970 (twice) - **Butch Cassidy and the Sundance Kid** & **"Raindrops Keep Fallin' On My Head"** & 1982 - **"Arthur's Theme (Best That You Can Do)"**

He won **8 Grammy Awards** (1968, 1970 (twice), 1987, 1997, 1999, 2006, 2008), and an Emmy Award in 1971.

Noted painter Lalitha Lajmi passed away

Noted painter & late actor-filmmaker Guru Dutt's sister, **Lalitha Lajmi**, Passed away at the age of 90.

Lalita Lajmi was born in 1932 in Kolkata, **West Bengal**, India.

She has held several exhibitions in international art galleries in Paris, London and the Netherlands.



Olympian and Asian Games gold medallist Tulsidas Balaram Passed away

One of India's finest footballers and a member of the golden era of **Indian football** (1951-1962), **Tulsidas Balaram**, passed away at the age of 84 in Kolkata.

Balaram was born in Hyderabad, Telangana, India.

He played in **two Olympics** in **1956 and 1960** and reached the pinnacle of Asian football when India, under the guidance of legendary coach **Syed Abdul Rahim**, won the Asian Games gold in Jakarta, beating South Korea 2-1 in 1962.



ARTICLE RELATED TO MOST IMPORTANT NEWS OF THE MONTH

F E B R U A R Y 2 0 2 3

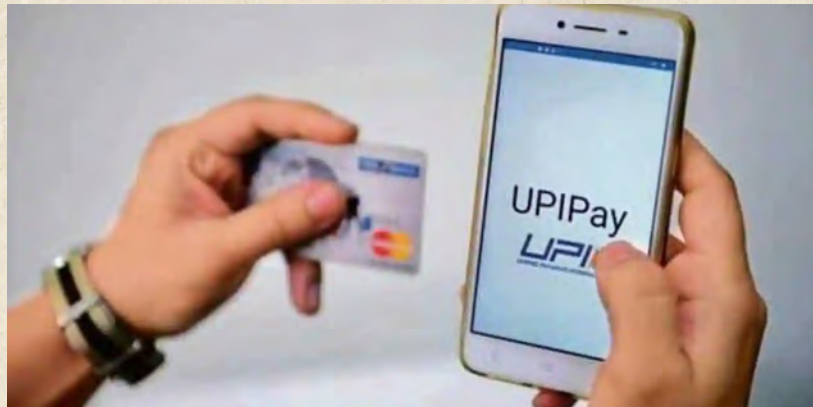

Union Budget 2023-24 Key Highlights:

The Union Finance Minister **Nirmala Sitharaman** has presented the **Union Budget 2023-24** on **01 February 2023**. The Union Budget is the annual financial report of India, which deals with the expected income and expenditure of the economy in the upcoming fiscal year.

The Budget adopts the following seven priorities. They complement each other and act as the 'Saptarishi' guiding us through the Amrit Kaal.

1. Inclusive Development
2. Reaching Last Mile
3. Infrastructure Investment
4. Unleashing Potential
5. Green Growth
6. Youth Power
7. Financial Sector



Here's how this year's Budget proposes to allocate money to various ministries when compared to the last one:

Ministries	Previous year Budget allocations	Current year Budget allocations
Defence Ministry	Rs 5.25 trillion	Rs 5.94 trillion
Road Transport and Highways Ministry	Rs 1.99 trillion	Rs 2.70 trillion
Railways Ministry	Rs 1.4 trillion	Rs 2.41 trillion
Consumer Affairs, Food and Public Distribution Ministry	Rs 2.17 trillion	Rs 2.06 trillion
Home Affairs Ministry	Rs 1.85 trillion	Rs 1.96 trillion
Chemicals and Fertiliser Ministry	Rs 1.07 trillion	Rs 1.78 trillion
Rural Development Ministry	Rs 1.38 trillion	Rs 1.60 trillion
Agriculture and Farmers' Welfare Ministry	Rs 1.32 trillion	Rs 1.25 trillion
Communications Ministry	Rs 1.05 trillion	Rs 1.23 trillion

Allocation for Specific Ministries



Here's how this year's Budget proposes to allocate money to various ministries when compared to the last one:

Government Schemes	Previous year Budget allocations	Current year Budget allocations
Development of the Pharmaceuticals Industry	Rs 100 crore	Rs 1,250 crore
Jal Jeevan Mission	Rs 60,000 crore	Rs 70,000 crore
Eklavya Model Residential Schools	Rs 2,000 crore	Rs 5,943 crore
Pradhan Mantri Awas Yojana	Rs 48,000 crore	Rs 79,590 crore
Scheme For faster Adoption and Manufacturing of EVs (FAME)	Rs 2,908 crore	Rs 5,172 crore
North East Special Infrastructure Development Scheme	Rs 1,419 crore	Rs 2,491 crore

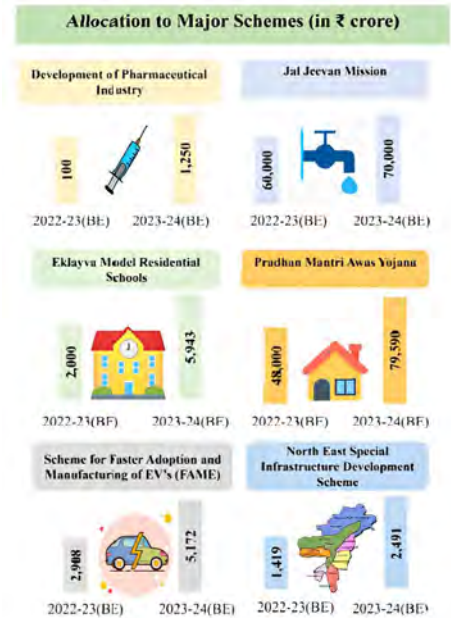

Major Takeaways

- Finance Minister has announced the increment of capital investment outlay in the third year by **33 per cent to ₹10 lakh crore, which will be 3.3 per cent of GDP.**
- Capital outlay of **Rs. 2.40 lakh crore** has been provided for the **Railways**, which is the **highest ever outlay** and about nine times the outlay made in 2013-14.
- Fiscal deficit for Fiscal Year 2024 is projected at **5.9 per cent of GDP.**
- PAN** will be used as the common identifier for all digital systems of specified government agencies to bring in **Ease of Doing Business.** Outlay for **Pradhan Mantri Awas Yojana** is being enhanced by **66% to over Rs. 79,000 crore.** To promote healthcare, a promise to establish **157 new nursing colleges** has been made.
- Urban infra-development** funds will be managed by **National Housing Bank (NHB)** and will be used by public agencies. An allocation of **₹10,000 crore p.a.** for urban infra development fund has been made. **100 labs** to be setup for 5G services based application development to realize a new range of opportunities, business models, and employment potential.
- Mahila Savings Certificate for 2 years** up to March 2025, a new small savings scheme announced for women. **NITI Ayog** policy expanded to continue for another 3 years. Finance Minister said **₹2 lakh crore** for the entire year will be borne by the central government

Incentives to boost Investment in Infrastructure and productive capacity

Multiplier Impact

Rise in growth and employment



Increased capital investment outlay by 33.4% to ₹10 lakh crore



Continuation of 50 year interest free loan to State Governments to incentivize infrastructure investment



Highest ever Capital outlay of ₹2.4 lakh crore for Railways



100 transport infrastructure projects identified for end-to-end connectivity for ports, coal, steel, fertilizer sectors



Creating Urban Infrastructure in Tier 2 and 3 cities via establishment of UIDF⁰⁹

under the 'PM Garib Kalyan Anna Yojana' scheme.

Allocation of **₹35 crore** for energy transition and net-zero carbon emission target will be made. The maximum deposit for **senior citizen saving scheme** to be enhanced to **₹30 lakh from for ₹15 lakh**.

The maximum deposit limit for Monthly Income Account Scheme to be enhanced from **Rs 4.5 lakh to Rs 9 lakh for single account** and from **Rs 9 lakh to Rs 15 lakh for joint account**.

Per capita income has more than doubled to ₹1.97 lakh in around nine years.

Indian economy has increased in size from being 10th to 5th largest in the world in the past nine years.

Credit guarantee for MSMEs of **₹9,000 crores** infused in the corpus, allowing additional collateral-free credit of **₹2 lakh crores**, starting from **April 1, 2023**.

EPFO membership has more than doubled to **27 crore**.

Atmanirbhar Clean Plant Program with an outlay of ₹2200 crore to be launched to boost availability of disease-free, quality planting material for high value horticultural crops.

500 new '**waste to wealth**' plants under **GOBARdhan** (Galvanizing Organic Bio-Agro Resources Dhan) scheme to be established for promoting circular economy at total investment of **Rs 10,000 crore**. **5 per cent** compressed biogas mandate to be introduced for all organizations marketing natural and bio gas.

30 Skill India International Centres to be set up across different States to skill youth for international opportunities.

Revamped credit guarantee scheme for MSMEs to take effect from 1st April 2023 through infusion of Rs 9,000 crore in the corpus. This scheme would enable additional collateral-free guaranteed credit of Rs 2 lakh crore and also reduce the cost of the credit by about 1 per cent. Targeted Fiscal Deficit to be below 4.5% by 2025-26.

To make India a global hub for 'Shree Anna', the Indian Institute of Millet Research, Hyderabad will be supported as the Centre of Excellence for sharing best practices, research and technologies at the international level.

157 new nursing colleges to be established in co-location with the existing 157 medical colleges established since 2014.

Rs. 5,300 crore to be given as central assistance to Upper Bhadra Project to provide sustainable

micro irrigation and filling up of surface tanks for drinking water.

"PM Programme for Restoration, Awareness, Nourishment and Amelioration of Mother Earth" (PM-PRANAM) to be launched to incentivize States and Union Territories to promote alternative fertilizers and balanced use of chemical fertilizers.

Education and Skilling

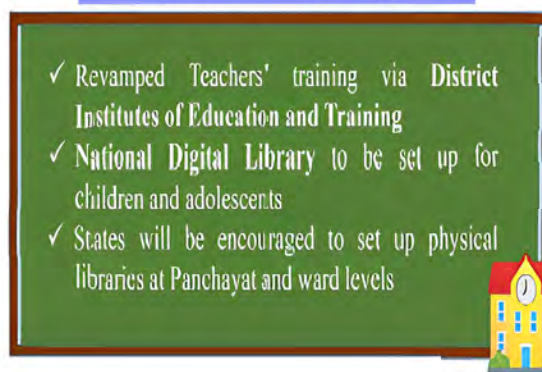

Agriculture and Cooperatives

Building Digital Public Infrastructure
Building an accessible, inclusive and informative solution for Farmers



Setting up Agriculture Accelerator Fund
For encouraging innovative start-ups in rural areas

ANB* Horticulture Clean Plant Program to be launched
To boost production of high value horticultural crops



Targeted Funding
₹20 lakh crore agricultural credit targeted at Animal Husbandry, Dairy and Fisheries sector

Making India Global Hub For Millets: 'Shree Anna'
Support to be given to IIMR*, Hyderabad for promoting research



Setting-up of widely available storage capacity
Will enhance Farmers' remuneration by enabling sale at appropriate times

'Mangrove Initiative for Shoreline Habitats & Tangible Incomes' (MISHTI), to be taken up for mangrove plantation along the coastline and on salt pan lands, through convergence between MGNREGS, CAMPA Fund and other sources.

Amrit Dharohar scheme to be implemented over the next three years to encourage optimal use of wetlands, enhance bio-diversity, carbon stock, eco-tourism opportunities and income generation for local communities.

Pradhan Mantri Kaushal Vikas Yojana 4.0, to be launched to skill lakhs of youth within the next three years covering new age courses for Industry 4.0 like coding, AI, robotics, mechatronics, IOT, 3D printing, drones, and soft skills.

States to be encouraged to set up a Unity Mall for promotion and sale of their own and also all others states' ODOPs (One District, One Product), GI products and handicrafts.

Direct Benefit Transfer under a pan-India National Apprenticeship Promotion Scheme to be rolled out to provide stipend support to 47 lakh youth in three years.

Sector specific skilling and entrepreneurship development to be dovetailed to achieve the objectives of the 'Dekho Apna Desh' initiative.

Centre to recruit 38,800 teachers and support staff for the 740 Eklavya Model Residential Schools, serving 3.5 lakh tribal students over the next three years.

Rs. 15,000 crore for implementation of Pradhan Mantri PVTG Development Mission over the next three years under the Development Action Plan for the Scheduled Tribes.

To commemorate Azadi Ka Amrit Mahotsav, a one-time new small savings scheme, Mahila Samman Savings Certificate to be launched. It will offer deposit facility upto Rs 2 lakh in the name of women or girls for tenure of 2 years (up to March 2025) at fixed interest rate of 7.5 per cent with partial withdrawal option.

11.7 crore household toilets constructed under Swachh Bharat Mission.

9.6 crore LPG connections provided under Ujjwala.

47.8 crore Pradhan Mantri Jan Dhan bank accounts.

Insurance cover for 44.6 crore persons under Pradhan Mantri Suraksha Bima and Pradhan Mantri Jeevan Jyoti Yojana.

Cash transfer of ₹2.2 lakh crore to over 11.4 crore farmers under Pradhan Mantri Kisan Samman Nidhi.

DIRECT TAXES

Direct Tax proposals aim to maintain continuity and stability of taxation, further simplify and rationalise various provisions to reduce the compliance burden, promote the entrepreneurial spirit and provide tax relief to citizens.

Rebate limit of Personal Income Tax to be increased to Rs. 7 lakh from the current Rs. 5 lakh in the new tax regime. Thus, persons in the new tax regime, with income up to Rs. 7 lakh to not pay any tax.

Tax structure in new personal income tax regime, introduced in 2020 with six income slabs, to change by reducing the number of slabs to five and increasing the tax exemption limit to Rs. 3 lakh. Change to

provide major relief to all tax payers in the new regime.

Under the new personal tax regime, six income slabs have been reduced to six. The government has also increased the tax exemption limits in some of these categories.

The new income tax regime to be made the default tax regime. However, citizens will continue to have the option to avail the benefit of the old tax regime.

Proposal to limit income tax exemption from proceeds of insurance policies with very high value. Where aggregate of premium for life insurance policies (other than ULIP) issued on or after 1st April, 2023 is above Rs. 5 lakh, income from only those policies with aggregate premium up to Rs. 5 lakh shall be exempt.

Minimum threshold of Rs. 10,000/- for TDS to be removed and taxability relating to online gaming to be clarified. Proposal to provide for TDS and taxability on net winnings at the time of withdrawal or at the end of the financial year.

New Tax Rates

Total Income (Rs)	Rate (per cent)
Up to 3,00,000	Nil
From 3,00,001 to 6,00,000	5
From 6,00,001 to 9,00,000	10
From 9,00,001 to 12,00,000	15
From 12,00,001 to 15,00,000	20
Above 15,00,000	30

INDIRECT TAXES

Number of basic customs duty rates on goods, other than textiles and agriculture, reduced to 13 from 21.

Excise duty exempted on GST-paid compressed bio gas contained in blended compressed natural gas.

Customs Duty on specified capital goods/machinery for manufacture of lithium-ion cell for use in battery of electrically operated vehicle (EVs) extended to 31.03.2024

Basic customs duty reduced on parts of open cells of TV panels to 2.5 per cent.

Basic customs duty on heat coil for manufacture of electric kitchen chimneys reduced to 15 per cent from 20 per cent.

Basic customs duty on crude glycerin for use in manufacture of epichlorhydrin reduced to 2.5 per cent from 7.5 per cent.

Basic customs duty reduced on seeds used in the manufacture of lab grown diamonds.

Duties on articles made from dore and bars of gold and platinum increased.

Import duty on silver dore, bars and articles increased.

Basic customs duty rate on compounded rubber increased to 25 per cent from 10 per cent or 30 per kg whichever is lower.

National Calamity Contingent Duty (NCCD) on specified cigarettes revised upwards by about 16 per cent.

Legislative Changes in Customs Laws

Customs Act, 1962 to be amended to specify a time limit of nine months from date of filing application for passing final order by Settlement Commission.

Customs Tariff Act to be amended to clarify the intent and scope of provisions relating to Anti-Dumping Duty (ADD), Countervailing Duty (CVD), and Safeguard Measures.

To raise the minimum threshold of tax amount for launching prosecution under GST from 1 crore to 2 crore.

To reduce the compounding amount from the present range of 50 to 150 per cent of tax amount to the range of 25 to 100 per cent;

To restrict filing of returns/statements to a maximum period of three years from the due date of filing of the relevant return/statement; and

To enable unregistered suppliers and composition taxpayers to make intra-state supply of goods through E-Commerce Operators (ECOs).

FISCAL DEFICIT:

The fiscal deficit is estimated to be 5.9% of the GDP in FY 2023-24.

Net borrowings to finance the fiscal deficit is estimated to be Rs 11.8 lakh crore.

CAPITAL INVESTMENT:

The capital investment outlay increased for the third year in a row by 33% to ₹10 lakh crore. This accounts for 3.3% of the GDP.

AGRICULTURE:

Agriculture credit target would be raised to ₹20 lakh crore with a focus on animal husbandry and fisheries.

FOR MICRO, SMALL AND MEDIUM ENTERPRISES:

PM Vishwakarma Kaushal Samman (PM VIKAS): The first-of-its-kind package assistance endeavours to improve the quality of, scale and reach of the products made by traditional artisans and craftspeople. Components of the scheme would not provide for financial support but also access to advanced skill training, knowledge of modern digital techniques and efficient green technologies, digital payments and social security.

Vivad se Vishwas I: If MSMEs failed to execute contracts during the pandemic period, 95% of the forfeited amount relating to bid or performance security would be returned to them by the government or its undertakings.

CREDIT GUARANTEE:

The scheme for MSMEs has been revamped with an infusion of ₹9,000 crore in the corpus. It will be enforced from April 1, 2023. This would enable an additional collateral-free guaranteed credit of Rs 2 lakh crore.

The cost of credit would be reduced by about 1 per-cent, the finance minister informed.

GREEN ENERGY:

The budget provided ₹35,000 crore for priority capital investments towards achieving energy transition and net-zero objectives as well as energy security by the Ministry of Petroleum and Natural gas.

Huge Selections in **SBI Clerk 2022-23** Prime Bundle PDF Course 2023

Daily Targets	English & Hindi	Detailed Video Solutions*	PDF & Quiz Format*
---------------	-----------------	---------------------------	--------------------

12 Months Validity + 1 Year Mock Test + PDF Course 2022 (3 Months)

- ✓ Beginners Bundle Course
- ✓ Topic wise Bundle PDF Course
- ✓ Exam wise Bundle PDF Course
- ✓ Section wise Bundle PDF Course
- ✓ Memory Based Question Bundle Course
- ✓ Special Prelims Part Bundle PDF Course
- ✓ Mains Booster PDF Course

EXAMS COVERED:

FLAT **70% OFF**

Extra **10% Off**

USE CODE **GUIDELY10**

One Time Offer Ends Soon - Hurry !!!

BUY NOW

120K

Questions

DID YOU KNOW? Guidely Users are finding pdf course very helpful in increasing their Accuracy and to boost up their preparation.

* Price will not be decreased below Rs. 1199/- | Special discount for Ultimate Bundle Users

Current Affairs

CROSSWORD

PUZZLE



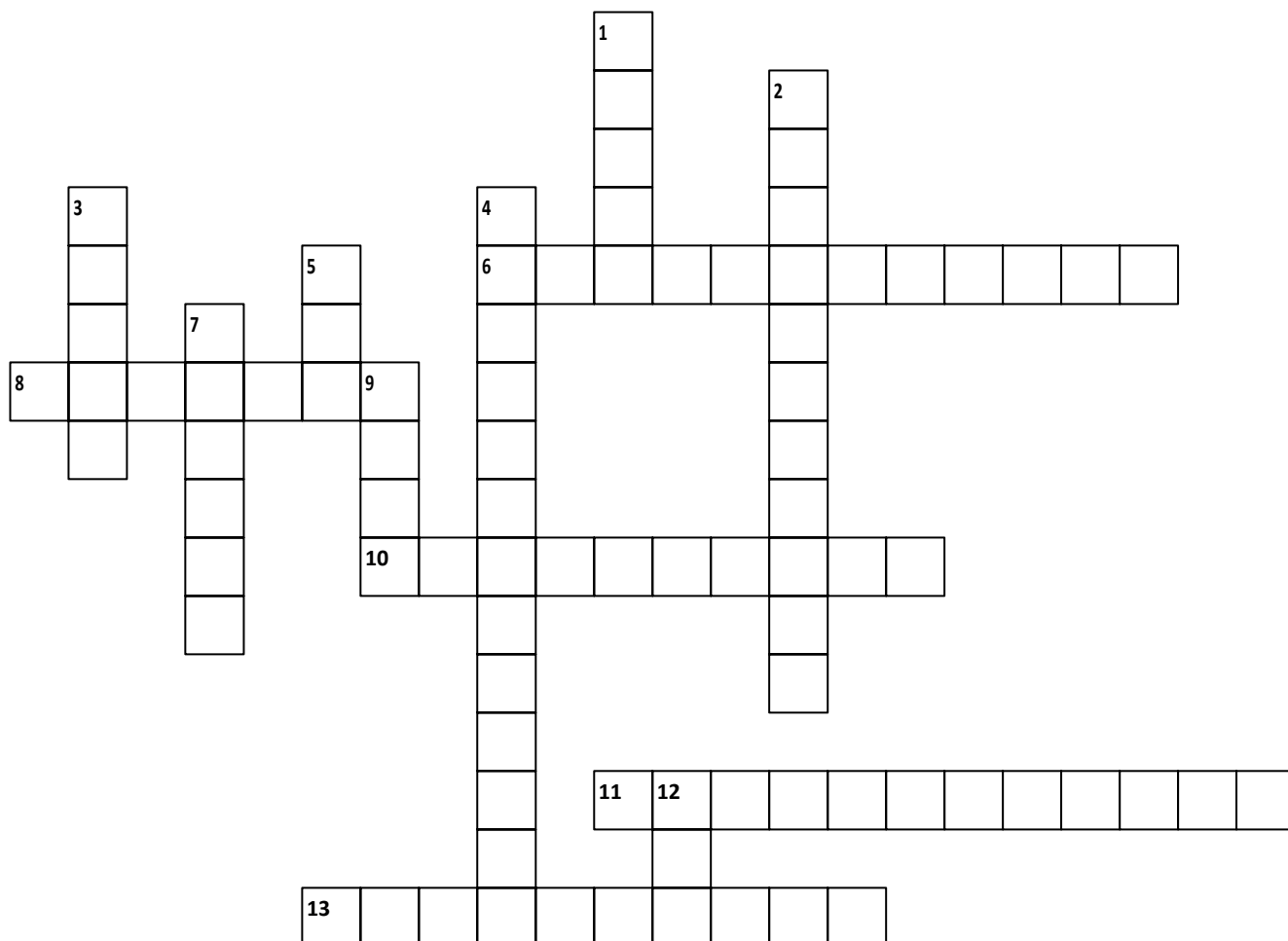

Across

6. Felix Houphouet-Boigny UNESCO Peace Prize

- a) Narendra Modi
- b) Kamala Harris
- c) Angela Merkel
- d) Rajnath Singh
- e) Antonio Guterres

10. First International Financial Architecture Working Group meeting of G-20 held

- a) Chattisgarh
- b) Haryana
- c) Karnataka
- d) Chandigarh
- e) Uttarakhand

13. First-ever indigenously developed train control & supervision system

- a) Mumbai Metro
- b) Chennai Metro
- c) Pune Metro
- d) Delhi Metro
- e) Kochi Metro

8. India's 80th Grandmaster

- a) Rahul
- b) Pravin
- c) Pranav
- d) Vignesh
- e) Kausav

11. Chief Executive Officer (CEO) of NITI Aayog

- a) Ramakrishnan
- b) Subrahmanyam
- c) Rajasekaran
- d) Gopala Krishnan
- e) Suresh Krishna

Down

1. **New capital of Andhra Pradesh**
 - a) Vizag
 - b) Amaravati
 - c) Eluru
 - d) Kakinada
 - e) Manyam
2. **Venue of the 4th edition of Exercise DUSTLIK (2023) between the India-Uzbekistan military Training**
 - a) Rajasthan
 - b) Uttarakhand
 - c) Tamil Nadu
 - d) Karnataka
 - e) Punjab
3. **Focal country at 2025 Madrid International Book Fair**
 - a) Spain
 - b) France
 - c) Japan
 - d) China
 - e) India
4. **Lifetime Achievement Honour by the India-UK Achievers Honours in London**
 - a) Narendra Modi
 - b) Manmohan Singh
 - c) Pratibha Patel
 - d) Venkaiah Naidu
 - e) Rajnath Singh
5. **FORTUNE® magazine's list of the World's Most Admired Companies.**
 - a) HCL
 - b) SBI
 - c) TCS
 - d) CTS
 - e) IBM
7. **City have been listed on NSE marking the first-ever green bond issue by a municipal corporation in India**
 - a) Bhopal
 - b) Indore
 - c) Kochi
 - d) Aluva
 - e) Mumbaie
9. **First private sector bank in India to take up a service that allows customers to use RuPay credit cards on UPI with BHIM**
 - a) Axis
 - b) HDFC
 - c) Federal
 - d) ICICI
 - e) CUB
12. **Host the first vice-ministerial meeting of the I2U2**
 - a) UAE
 - b) India
 - c) USA
 - d) UK
 - e) Iran

[Click here to Get Current Affairs Crossword Answer](#)

RBI Assistant Prelims 2023 Practice Set

Reasoning Ability

Directions (1-5): Study the following information carefully and answer the questions given below.

In a certain code language,

“Volume level books page” is coded as “tr bd th ma”

“Secondary level school programme” is coded as “bd ok qw fg”

“Quality certificate books programme” is coded as “th fg yc vz”

“New magazine volume school” is coded as “aj ma qw zy”

(Note: All the given codes are two letter codes only)

1. What is the code for the word “Secondary” in the given code language?

- a) bd
- b) fg
- c) qw
- d) ok
- e) None of these

2. What is the code for the phrase “Volume books” in the given code language?

- a) ma tr
- b) th yc
- c) ma th
- d) tr ok
- e) bd ma

3. What is the phrase for the code “aj qw ” in the given code language?

- a) New school
- b) Programme school
- c) Magazine school
- d) Volume quality
- e) Either a or c

4. If “Certificate upload” is coded as “vz ab”, then what is the code for the phrase

“Level Quality” in the given coded language?

- a) bd fg
- b) yc bd
- c) th zy
- d) ma yc
- e) Cannot be determined

5. What is the code for the word “page” in the given code language?

- a) tr
- b) fg
- c) ok
- d) bd
- e) th

Directions (6-10): Study the following information carefully and answer the questions given below.

Eight people – A, B, C, D, E, F, G and H are standing in a queue one after another. No other people standing in the queue other than the given people.

Only three people stand between F and H. A stands immediately before H. B stands two persons after A. As many people stand between F and B as between A and E, who stands before F. Only two people stand between E and D. Only one person stands between D and C, who stands before G. G doesn't stand adjacent to A.

6. As many people stand before E as after —.

- a) B
- b) A
- c) H
- d) C
- e) D

7. If B is related to H and C is related to E in a certain way, then in the same way who

among the following person is related to

A?

- a) D
- b) H
- c) F
- d) E
- e) G

8. Who among the following person stands two persons before G?

- a) H
- b) A
- c) B
- d) D
- e) F

9. How many people stand between H and C?

- a) One
- b) Two
- c) Three
- d) Four
- e) No one

10. If all the people are standing in the queue in reverse alphabetical order from the first person, then who among the following person remain unchanged in their position?

- a) E
- b) H
- c) G
- d) C
- e) F

Directions (11-14): Study the following information carefully and answer the questions given below.

3 W A 5 @ G P ^ R 1 6 V J D 8 * M K 4 \$ E H 9 Z 2 L S & O

11. How many such symbols are there in the given series each of which is immediately preceded by a number and immediately followed by a consonant?

- a) Four
- b) One

- c) Three
- d) Two
- e) None

12. If all the odd numbers and symbols are dropped from the given series, then which of the following element is seventeenth from the right end?

- a) G
- b) P
- c) 2
- d) R
- e) L

13. How many consonants are there between the element which is fifth from the left end and seventh from the right end of the given series?

- a) Seven
- b) Ten
- c) Nine
- d) Four
- e) Six

14. Which of the following element is fifteenth to the right of the ninth element from the left end of the given series?

- a) 9
- b) 2
- c) H
- d) &
- e) Z

Directions (15-19): Study the following information carefully and answer the questions given below.

Ten persons are sitting in two parallel rows containing five persons each in such a way that there is an equal distance between adjacent persons. In row 1 S, T, U, V and W are seated and all of them are facing south. In row 2 A, B, C, D and E are seated and all of them are facing north. Each person in row 1 faces exactly one person in row 2.

Only two persons sit between E and D, who sits at one of the extreme ends. Only one person sits between U and the one who faces E. W sits immediate right of U. The one who faces W sits two places away from

A. C sits second to the right of A. T faces one of the immediate neighbours of B. S sits third to the right of T.

15. As many persons sit to the left of V as to the right of___.

- a) W
- b) S
- c) D
- d) A
- e) E

16. What is the position of U with respect to S?

- a) Third to the right
- b) Fourth to the left
- c) Second to the left
- d) Immediate right
- e) None of these

17. How many persons sit between C and B?

- a) Four
- b) Two
- c) Three
- d) One
- e) No one

18. Four of the following five are alike in a certain way based on the given arrangement and thus form a group. Which one of the following does not belong to the group?

- a) W
- b) V
- c) E
- d) C
- e) U

19. Who among the following person is facing D?

- a) The one who sits second to the left of W
- b) U
- c) V
- d) W
- e) The one who sits immediate left of V

Directions (20-22): Study the following information carefully and answer the questions given below.

T is the only brother of D. E is the only daughter of F, who is the sister-in-law of D. R is the sibling of E. R is not the child of T. U is the maternal uncle of R and has only one sibling. P is the son of U. I is the son-in-law of J, who is the spouse of F.

20. If K is the wife of P, then how is K related to U?

- a) Sister-in-law
- b) Sister
- c) Mother
- d) Niece
- e) Daughter-in-law

21. How is P related to T?

- a) Son
- b) Nephew
- c) Cousin
- d) Brother
- e) Father

22. Which of the following statements is/are true based on the given information?

- a) P is the son of F
- b) Both F and U are brothers
- c) I is the uncle of P
- d) R and U are of the same gender
- e) Both b and d

Directions (23-27): Study the following information carefully and answer the questions given below.

Eight persons – P, Q, R, S, T, U, V and W attend the seminar on two different dates either 3rd or 16th of four different months viz. March, May, July and September of the same year.

T attends the seminar in the month having 30 days. Only three attend between T and P. U attends two persons before P. As many persons attend before U as after Q. Only one person attends between Q and S. V attends either immediately before or

immediately after S. Only two persons attend between V and R. W doesn't attend in March.

23. Who among the following person attends the seminar on May 16?

- a) The one who attends two persons after U
- b) S
- c) T
- d) The one who attends immediately before V
- e) Q

24. If R is related to U and Q is related to T in a certain way, then in the same way who among the following person is related to V?

- a) S
- b) Q
- c) U
- d) R
- e) P

25. How many persons attend the seminar between T and W?

- a) Three
- b) Two
- c) One
- d) More than three
- e) No one

26. V attends the seminar on which of the following month and date?

- a) March 16
- b) September 3
- c) July 3
- d) May 16
- e) March 3

27. Who among the following person attends the seminar immediately after R?

- a) S
- b) T
- c) U
- d) W
- e) P

Directions (28-31): Study the following statements and then decide which of the given conclusions logically follows from the given statements disregarding the commonly known facts.

28. Statements:

Only a few orders are rules
All orders are protocol
No rule is law

Conclusions:

I. Some orders being law is a possibility

II. Some rules are not protocol

- a) Only conclusion I follows
- b) Either conclusion I or II follows
- c) Both conclusions I and II follow
- d) Only conclusion II follows
- e) Neither conclusion I nor II follows

29. Statements:

At least some stars are hash
All hashes are dollar
Only a few dollars are percentage

Conclusions:

I. Some hash is percentage

II. No hash is percentage

- a) Only conclusion I follows
- b) Either conclusion I or II follows
- c) Both conclusions I and II follow
- d) Only conclusion II follows
- e) Neither conclusion I nor II follows

30. Statements:

Only a few dinners are feast
All fiestas are feast
No dinner is lunch

Conclusions:

I. All feasts being lunch is a possibility

II. All dinners can never be fiesta

- a) Only conclusion I follows
- b) Either conclusion I or II follows
- c) Both conclusions I and II follow
- d) Only conclusion II follows
- e) Neither conclusion I nor II follows

31. Statements:

Only a few ants are act
All ants are ate

All acts are art

Conclusions:

I. Some acts are not art

II. Some acts can be ate

- a) Only conclusion I follows
- b) Either conclusion I or II follows
- c) Both conclusions I and II follow
- d) Only conclusion II follows
- e) Neither conclusion I nor II follows

32. If 1 is added to the odd positioned digits and 1 is subtracted from the even positioned digits from the left end of the number "436859437", then what is the sum of the digits which are third from the left end and fourth from the right end?

- a) 10
- b) 4
- c) 12
- d) 15
- e) 14

33. How many such pairs of letters are in the word "SPLINTER" each of which has as many letters between them in the word as in the English alphabetical series (both forward and backward directions)?

- a) One
- b) Two
- c) Three
- d) More than three
- e) None

Directions (34-35): Study the following information carefully and answer the questions given below.

Six persons – D, E, F, G, H and I are of different heights. F is taller than only two persons. D is taller than G but shorter than I, who is shorter than E. G is not the shortest person. The height of the second shortest person is 150 cm.

34. As many persons taller than D as shorter ____.

- a) E
- b) H
- c) G

- d) I
- e) F

35. If the sum of the height of G and I is 330 cm and the sum of the height of H and I is 320, then what is the difference between the height of H and G?

- a) 12cm
- b) 10cm
- c) 15cm
- d) 13cm
- e) None of these

Quantitative Aptitude

Directions (36-45): What value should come in the place of (?) in the following questions?

36) ?% of 1200 + 14² + 288 = 604

- a) 12
- b) 18
- c) 25
- d) 15
- e) 10

37) 15% of 380 + 60% of 600 = ? – 48 * 20

- a) 1345
- b) 1444
- c) 1377
- d) 1300
- e) 1415

38) 180 ÷ (6 * 5 + 6 – 18) = ? ÷ 8

- a) 80
- b) 70
- c) 60
- d) 90
- e) 50

39) 3³ * 9^{?+2} ÷ 3⁴ = 27^{? - 1}

- a) -2
- b) 6
- c) 0
- d) 1
- e) -4

Directions (46-50): Read the following information carefully and answer the given questions.

The given line graph shows the demand for rice in state Ain MT in four different years namely 2010, 2012, 2014 and 2016 and also given the actual production of rice in state Ain MT in these years.

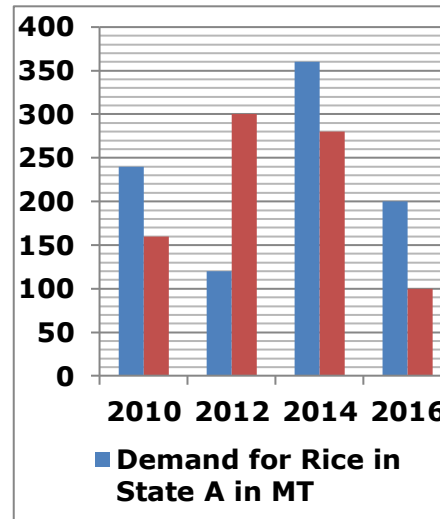

40) $16 * 28 + 15 * 14 = ? + 8^3$

- a) 152
- b) 167
- c) 178
- d) 146
- e) 184

41) $7/8$ of 160 of 30% + ? * $8/9 = ?$

- a) 378
- b) 385
- c) 364
- d) 328
- e) 340

42) 45% of 900 + $\sqrt{(6^2 + 2^2 + 3^2)} = ?$

- a) 464
- b) 490
- c) 412
- d) 484
- e) 440

43) 220% of $^3\sqrt{27000} + \sqrt{1156} = ?^2$

- a) 14
- b) 12
- c) 15
- d) 13
- e) 10

44) $450 * 4^2 \div 5^2 + 482 = ?$

- a) 660
- b) 680
- c) 720
- d) 750
- e) 770

45) $350 \div 7 + 480 \div 6 = 26 * ? + 26$

- a) 4
- b) 15
- c) 10
- d) 6
- e) 8

46) If the demand for wheat in state Ain 2010 is 25% more than the actual production of rice in state Ain 2012 and the actual production of wheat in state Ain 2010 is the average of the actual production of rice in state Ain 2010 and 2014, then find the sum of the demand and actual production of wheat in state Ain 2010.

- a) 580 MT
- b) 590 MT
- c) 595 MT
- d) 480 MT
- e) None of these

47) If in 2018, there is a shortage of 120MT in the production of Rice and the demand for rice in 2018 is 20% more than that of 2016, then find the actual production of rice in 2018.

- a) 140 MT
- b) 180 MT
- c) 100 MT
- d) 120 MT
- e) None of these

48) Find the difference between the shortage of production of Rice in 2014 and 2016.

- a) 20 MT
- b) 10 MT
- c) 15 MT
- d) 18 MT
- e) None of these

49) The demand for Rice in 2010 is what percentage of the actual production of rice in 2016?

- a) 75%
- b) 150%
- c) 240%
- d) 100%
- e) None of these

50) Find the ratio of the actual production of rice in State A in 2010 to the demand for rice in State A in 2012.

- a) 4:3
- b) 3:2
- c) 1:1
- d) 7:5
- e) None of these

51) A invested Rs.5000 at $x\%$ rate of simple interest per annum for 10 years and B invested Rs.8000 at 20% rate of simple interest per annum for $(x/5)$ years. The interest obtained by A is Rs.4500 more than that of B. Find the value of x .

- a) 25
- b) 20
- c) 18
- d) 15
- e) None of these

52) A vessel contains milk and water in the ratio of 3:2 and the difference between the quantity of milk and water is 36 liters. If 50% of mixture is removed and x liters of water is added, then the ratio of milk to water becomes 9:16. Find the value of x .

- a) 75
- b) 30
- c) 45
- d) 60
- e) None of these

53) A car travels from City A to City B in 8 hours with a speed of a km/hr and also travels from City B to City C in 12 hours with a speed of 50 km/hr. If the average speed of the car is 46 km/hr, find the distance between City A and City B.

- a) 560 km
- b) 320 km
- c) 480 km
- d) 600 km
- e) None of these

54) The total wages offered for A and B to complete a work is Rs.1500 and the wages obtained by B is Rs.900. If the total time taken by A and B together to complete the work is 12 days, then find the time taken by A alone to complete the work.

- a) 20 days
- b) 24 days
- c) 15 days
- d) 30 days
- e) None of these

55) The time taken by the boat to cover x km in downstream is $(x/30)$ hours and the time taken by the same boat to cover the same distance in upstream is $(x/18)$ hours. Find the speed of the boat in still water.

- a) 24 km/hr
- b) 20 km/hr
- c) 18 km/hr
- d) 28 km/hr
- e) None of these

56) Raja bought a watch for Rs.4000 and marked its price by 25% above its cost price. He sold it after giving two consecutive discounts of 10% and $x\%$ respectively. Find the value of x , if Raja obtained a loss of Rs.400.

- a) 10
- b) 12
- c) 20
- d) 15
- e) None of these

57) The average present age of A, B and C is 24 years and the average present age of A and B is 24 years. The average age of B and C after 4 years is 26 years. Find the ratio of the present age of A to the age of C after 6 years.

- a) 14:15
- b) 15:11
- c) 8:9
- d) 9:7
- e) None of these

58) Mani scored 30% marks in an exam and failed in the exam by x marks and Jaya scored $(6x + 56)$ marks in the same exam. Find the maximum marks in the exam, if Jaya scored 68% of marks and the pass percentage is 40%.

- a) 600
- b) 500
- c) 480
- d) 700
- e) None of these

59) A, B and C entered into a partnership with an investment of Rs. x , Rs.4000 and Rs.6000 respectively and invested for 20 months, 15 months and 10 months. At the end of one year, the total profit obtained is Rs.11000 and the profit obtained by A is Rs.5000. Find the investment of A.

- a) Rs.7000
- b) Rs.5000
- c) Rs.4500

- d) Rs.6000
- e) None of these

60) Ratio of the lateral surface area of cube to the area of the square is 64:25 and the perimeter of the square is 60 m. Find the total surface area of the cube.

- a) 600 m^2
- b) 726 m^2
- c) 486 m^2
- d) 864 m^2
- e) None of these

Directions (61-65): What value should come in the place of (?) in the following number series?

61) 60, 100, 148, 212, 300, ?

- a) 480
- b) 380
- c) 400
- d) 420
- e) 450

62) 90720, 10080, 1260, ?, 30, 6

- a) 140
- b) 150
- c) 180
- d) 120
- e) 160

63) ?, 61, 57, 84, 68, 193

- a) 60
- b) 61
- c) 58
- d) 63
- e) 64

64) 3, 6, ?, 58, 241, 1216

- a) 11
- b) 15
- c) 17
- d) 13
- e) 12

65) 1285, 1585, 1874, 2150, 2409, ?

- a) 2728

- b) 2664
- c) 2628
- d) 2738
- e) 2649

Directions (66-70): Read the following information carefully and answer the questions.

The given Line graph shows the number of vanilla icecreams sold in five different shops namely A, B, C, D and E and also given the number of strawberry icecreams sold in these shops.

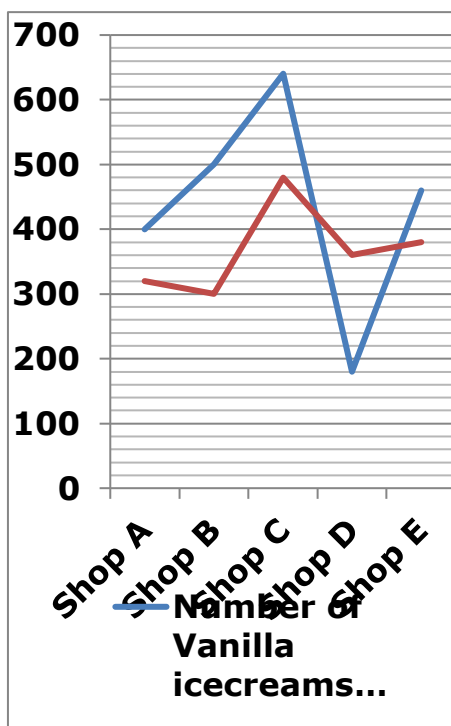

66) If the number of vanilla ice creams sold in Shop F is 10% less than that of Shop B and the number of strawberry ice creams sold in Shop F is $\frac{2}{3}$ rd of the average number of strawberry ice creams sold in Shop C and D, then find the sum of the

number of vanilla and strawberry ice creams sold in Shop F.

- a) 600
- b) 780
- c) 730
- d) 650
- e) None of these

67) If the ratio of the number of sold to unsold Vanilla ice creams in Shop C and Shop D is 4:1 and 3:2 respectively, then find the difference between the total number of Vanilla ice creams in Shop C and Shop D.

- a) 500
- b) 400
- c) 350
- d) 600
- e) None of these

68) If the price of each Vanilla ice cream in Shop A is Rs.30 and the price of each strawberry ice cream in Shop A is Rs.40, then find the total revenue generated in Shop A.

- a) Rs.20000
- b) Rs.22400
- c) Rs.24800
- d) Rs.21600
- e) None of these

69) Find the ratio of the number of strawberry ice creams sold in Shop E to the number of Vanilla ice creams sold in Shop D.

- a) 11:13
- b) 15:11
- c) 17:19
- d) 19:9
- e) None of these

70) The number of vanilla ice creams sold in Shop E is what percentage more/less than the number of vanilla ice creams sold in Shop B?

- a) 6% more
- b) 8% less

- c) 10% less
- d) 15% more
- e) None of these

English Language

Directions (71-78): Read the given passage carefully and answer the questions that follow.

The use of technology, including hardware, software, practice, and educational theory for a student's entire growth is known as education technology. The term "ed-tech" describes businesses and organisations that specialize in developing educational technology. It incorporates online learning, computer-based training, mobile learning, and many other learning methods. It is proper to integrate technology into education to produce beneficial and constructive results. It also encourages a diverse learning environment for pupils of all ages and locations. After China and the United States, India has risen to become one of the top three countries in the world for receiving venture capital funding in the ed-tech industry. India occupies a **significant** position in the global education sector. With 260 million students registered in more than 1.5 million schools and roughly 39,000 colleges, making it one of the largest networks of higher education institutions in the world, it offers a profitable prospect for monetization as well as social growth.

The ed-tech startup explosion that followed the global epidemic has revolutionized the education industry. Education technology and online learning allowed for uninterrupted learning even while schools, universities, and coaching facilities were closed for days or even months at a time. The online education market is expected to reach \$11.6 billion by 2026, according to projections. These figures imply that educational technology (ed-tech) is not merely a short-term adaptation to the COVID times, but has

established itself as a long-term answer to all the problems the education industry has previously faced.

Another critical driver of the Ed-Tech industry is the growing adoption of artificial intelligence (AI) and machine learning (ML) technologies. AI and ML are increasingly being used to create intelligent learning platforms that can personalize learning experiences based on the learner's individual needs and preferences. These platforms can analyse student performance data to identification areas where the learner may need additional support, and provide targeted recommendations and feedback to help them improve. The rise of online learning and educational technology seems to have increased **access** to education. It is always growing and daily achieving new heights. Online education has no demographic restrictions, so anyone with a smartphone and an internet connection can learn new things. With the help of partnerships with Indian schools and universities, many renowned foreign universities are now able to offer a wide range of courses online, sparing students the time-consuming process of moving abroad and the cost of large student loans. Students can now easily obtain a top-notch education from the convenience of their homes.

The education system has become so flexible that anyone can learn anything from anywhere. After the critical times of the pandemic, we have discovered that technology can be able to provide education to students, as many Universities, as well as schools, have adopted the online mode of education which gives a great boost to the ed-tech industry. Through the help of these online facilities, one can learn any course from anywhere in the world, by this ed-tech industry has become the future of India.

71. What is the benefit of ed-tech as per the first paragraph?

A. Learning has become flexible for everyone

- B. It creates diverse learning environment for all pupils
- C. The education industry has witnessed a revolution
- D. It helps in better analysis of the students' performance
- E. All of these

72. Which of the given option is true in the context of the passage?

- A. The pandemic has taught us that the offline mode of education cannot be replaced
- B. India is one of the top five countries receiving venture capital for ed-tech business
- C. Online education is paralysed due to the digital divide
- D. The rise of online learning has increased the access to education
- E. All sentences are false

73. What do the growth projections of the online education tell us?

- A. These figures show that anyone can learn from anywhere
- B. That the ed-tech industry has gotten a great boost
- C. That ed-tech is not just a short-term but a long-term solution
- D. Ed-tech has become the future of India
- E. All of these

74. What is the central idea of the passage given above?

- A. How will the Ed-Tech industry grow in the future...
- B. The global epidemic has revolutionized the education industry
- C. What is ed-tech and how has it helped the students
- D. Education technology is a boon for the world
- E. None of these

75. Which of the given options is not true as per the passage?

- A. The use of hardware for education is known as ed-tech
- B. Education system has become flexible for everyone
- C. Integration of technology into education brings constructive results
- D. Online education market is expected to reach \$11.6 billion by 2026
- E. All options are true

76. Which of the given parts is erroneous?

- A. These platforms can analyse student performance
- B. data to identification areas where the learner may need
- C. additional support, and provide targeted
- D. recommendations and feedback to help them improve.
- E. No Error

77. Which of the given words is the correct synonym to 'significant' as used above?

- A. Important
- B. Primary
- C. Secondary
- D. Consulting
- E. None of these

8. Which of the given words is the correct antonym to 'access' as used above?

- A. Entry
- B. Reach
- C. Contact
- D. Refusal
- E. None of these

Directions (79-83):The paragraph given below carries blanks in which words from the options given in each question can be filled to complete the paragraph meaningfully. Choose the correct word for each question given below.

The ____**(A)**____ of incorporating sports in education has been widely acknowledged because sports ____**(B)**____ holistic development by improving physical and psychological well-being while also enhancing cognitive capacities. As stated in Sustainable Development Goal 4 (Ensure inclusive and quality education for all and promote lifelong learning), holistic education ____**(C)**____ physical education and sports with the education curriculum. While participating in sports and taking part in physical activities outside of the classroom, the students learn real-life ____**(D)**____ through the fundamental principles of sports such as fair play, working as a team, spirit of ____**(E)**____ and losing, cooperation, discipline, tolerance, respect for rules etc.

89. Which of the given words would best fill the first blank in the paragraph above?

- A. Patience
- B. Timing
- C. Significance
- D. Emphasis
- E. Practicality

80. Choose the word that fits the best in the second blank given above.

- A. Encouraged
- B. Fosters
- C. Gains
- D. Neglects
- E. Destroys

81. Which of the given options would best fill the third blank above?

- A. Fixes
- B. Mixed
- C. Integrates
- D. Connect
- E. None of these

82. Choose the best word that fills the fourth blank given above.

- A. Lessons
- B. Chapters

- C. Example
- D. Situation
- E. All of these

83. Which of the given words would fit best in the fifth blank?

- A. Loss
- B. Winning
- C. Successful
- D. Gains
- E. All except (a)

Directions (84-86):The sentences given below carry blanks in which words from the options given below them can be filled. You must read the sentences carefully and choose an option that best completes the given sentences.

84. Our schools, colleges, and universities _____ large untapped potential.

- A. Train
- B. Seek
- C. Possess
- D. Look for
- E. Employ

85. Many clients are not satisfied with the transaction fees _____ with the bank accounts.

- A. Associated
- B. Imposed
- C. Charged
- D. Applied
- E. None of these

86. G-20 Summit is an excellent opportunity to _____ rural tourism in Punjab.

- A. Sale
- B. Prefer
- C. Support
- D. Promotion
- E. Maintain

Directions (87-91):The sentences given above have been divided into parts. One of these might be

erroneous and need to be improved.

Choose the same as your

answer...

- 87.**
 A. Womens limited access to
 B. healthcare is a complex problem,
 C. and social determinants like lack
 D. of financial autonomy and power
 imbalance
 E. at home hinder women from seeking
 medical care.
- 88.**
 A. In India, a new programme
 B. to promote research and innovation
 C. in pharmaceuticals has also been
 D. planned through centres of excellence.
 E. No Error
- 89.**
 A. E-waste release harmful
 B. chemicals, such as lead, on
 C. burning, which adversely
 D. impacts human blood, kidney
 E. and the peripheral nervous system.
- 90.**
 A. Recognising his devotion, dedication
 B. and potential in science, the university
 C. management offered him unlimited
 D. access in the laboratory of the college
 E. to pursue his research work.
- 91.**
 A. The rules established by CHIPS
 B. and IRA is a sad reminder of the
 C. United States fear regarding its nearest
 D. foe and its quest for supremacy.
 E. No Error
- 92.** Low-cost video **animation** gives brands
 an **edge** with its high-quality **content** while
 costing comparatively less than **traditional**
 animation.
 A. Animation
 B. Contend
 C. Edge
 D. Traditional
 E. All correct
- 93.** One of the **biggest barrier** B2B buyers
 face during online **shopping** is **finding**
 products.
 A. Shopping
 B. Finding
 C. Barrier
 D. Biggest
 E. All correct
- 94.** The course **includes** two months of
theory and one month of **practical training** in
 hospitals.
 A. Theory
 B. Training
 C. Practicel
 D. Includes
 E. All correct
- 95.** He **should** be **appointed** after **effective**
consultations.
 A. Effective
 B. Appointed
 C. Should
 D. Consultations
 E. All correct
- 96.** This is a statement **borne** out by India's
inherent potential to become the **leading**
 economic **power** of the world.
 A. Leading
 B. Inherent
 C. Power
 D. Borne
 E. All correct

Directions (92-96):The questions given
 below carry sentences in which words have
 been highlighted. One of these might be
 incorrectly spelt or inappropriate in usage.
 Choose the same as your answer.

Directions (97-100):The words highlighted in the sentence might be placed incorrectly and need to be swapped in order to make sense. The pairs to be swapped have been given in the options. Choose the pair of words that should be interchanged so that the sentence would make sense.

97. Here are a few quick tips to **(A) endless** the basic **(B) requirements** for a smooth **(C) ride** as you go on **(D) understand** adventures.

- A. A-B
- B. C-D
- C. A-C, B-D
- D. A-D
- E. No swapping needed

98. Life **(A) principles** are most **(B) religious** for the people, institutions, **(C) relevant** bodies and others to make **(D) changes** to become climate correct.

- A. B-C
- B. A-D
- C. A-B
- D. B-D
- E. No swapping needed

99. Despite such **(A) fights**, bitter word wars in some cases, and a few **(B) failures** on some fronts, the UDAN **(C) scheme** has been successful to a great **(D) extent**.

- A. A-D
- B. B-C
- C. A-B
- D. B-D
- E. No swapping needed

100. The credit **(A) rupees** of the **(B) banking** system is **(C) over** Rs 130 trillion **(D) portfolio**.

- A. B-C
- B. A-D
- C. A-C
- D. B-D
- E. No swapping needed

ANSWER WITH EXPLANATION

[Click Here to Get the Detailed Video Solution for the above given Reasoning Questions](#)

Or Scan the QR Code to Get the Detailed Video Solutions



Directions (1-5):

- 1) Answer: D
- 2) Answer: C
- 3) Answer: E
- 4) Answer: B
- 5) Answer: A

Words	Codes
Volume	ma
Level	bd
Books	th
Page	tr
Secondary	ok
School	qw
Programme	fg
Quality/Certificate	yc/vz
New/Magazine	aj/zy

Directions (6-10):

- 6) Answer: D

- 7) Answer: B
- 8) Answer: E
- 9) Answer: B
- 10) Answer: A

Final arrangement

Persons
A
H
B
E
C
F
D
G

We have,

- Only three people stand between F and H.
 - A stands immediately before H.
- From the above conditions, there are two

Case-1	Case-2
Persons	Persons
F	A
	H
A	
H	
	F

possibilities

Again, we have

- B stands two persons after A.

- As many people stand between F and B as between A and E, who stands before F.

Case-1	Case-2
Persons	Persons
E	A
	H
F	B
D	E
A	F
H	D
B	

- Only two people stand between E and D.

Again we have,

- Only one person stands between D and C, who stands before G.
- G doesn't stand adjacent to A.

After applying the above conditions case-1 gets eliminated because G stands adjacent to A, hence case-2 shows the final arrangement.

Case-1	Case-2
Persons	Persons
E	A
C	H
F	B
D	E
G	C
A	F
H	D
B	G

11) Answer: D

Given series:

3 W A 5 @ G P ^ R 1 6 V J D 8 * M K 4 \$ E H
9 Z 2 L S & O

12) Answer: B

Given series:

3 W A 5 @ G P ^ R 1 6 V J D 8 * M K 4 \$ E H
9 Z 2 L S & O
W A G P R 6 V J D 8 M K 4 E H Z 2 L S O

13) Answer: C

Given series:

3 W A 5 @ G P ^ R 1 6 V J D 8 * M K 4 \$ E H
9 Z 2 L S & O
3 W A 5 @ G P ^ R 1 6 V J D 8 * M K 4 \$ E H
9 Z 2 L S & O

Fifth from the left end is @ and seventh from the right end is 9 and there are nine consonants between them.

14) Answer: E

Given series:

3 W A 5 @ G P ^ R 1 6 V J D 8 * M K 4 \$ E H
9 Z 2 L S & O

Ninth element from the left end is R, then fifteenth to the right of R is Z.

Directions (15-19):

15) Answer: D

16) Answer: C

17) Answer: E

18) Answer: B (All the persons sit in the middle of the row except option b)

19) Answer: A

Final arrangement

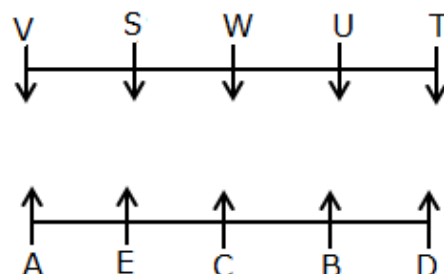

We have,

- Only two persons sit between E and D, who sits at one of the extreme ends.
- Only one person sits between U and the one who faces E.

From the above conditions, there are two possibilities

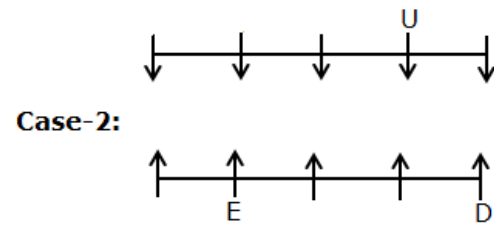
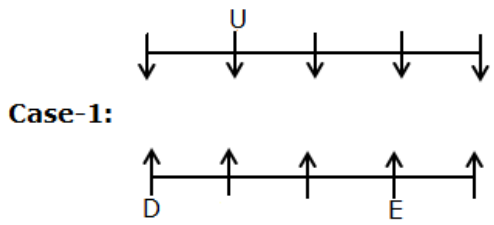

Again, we have

- W sits immediate right of U.
- The one who faces W sits two places away from A.
- C sits second to the right of A.

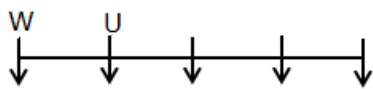

Case-1:



Case-2:



Again, we have

- T faces one of the immediate neighbours of B.
- S sits third to the right of T.

After applying the above conditions case-1 gets eliminated because there is no possibility to place S, hence case-2 shows the final arrangement.



~~Case-1:~~



Case-2:



Directions (20-22):

- 20) Answer: E
 21) Answer: B
 22) Answer: D

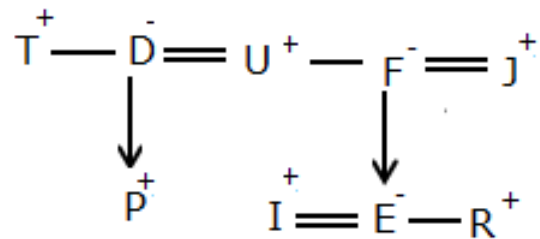

Directions (23-27):

- 23) Answer: D
 24) Answer: A
 25) Answer: B
 26) Answer: C
 27) Answer: E

Final arrangement

Month	Date	Person
March	3	U
	16	R
May	3	P
	16	W
July	3	V
	16	S
September	3	T

	16	Q
--	----	---

We have

- T attends the seminar in the month having 30 days.
- Only three persons attend between T and P.
- U attends two persons before P.

From the above conditions, there are two possibilities

		Case -1	Case -2
Month	Date	Pers on	Pers on
March	3	U	
	16		U
May	3	P	
	16		P
July	3		
	16		
September	3	T	
	16		T

Again, we have

- As many persons attend before U as after Q.
- Only one person attends between Q and S.

		Case-1	Case -2
Month	Date	Pers on	Pers on
March	3	U	
	16		U
May	3	P	
	16		P
July	3		S
	16	S	
September	3	T	Q
	16	Q	T

Again, we have

- V attends either immediately before or immediately after S.
- Only two persons attend between V and R.
- W doesn't attend in March.

After applying the above conditions case-2 gets eliminated because W attends in March, hence case-1 shows the final arrangement.

		Case-1	Case 2
Month	Date	Person	Person
March	3	U	W
	16	R	U
May	3	P	R
	16	W	P
July	3	V	S
	16	S	V
September	3	T	Q
	16	Q	T

28) Answer: A

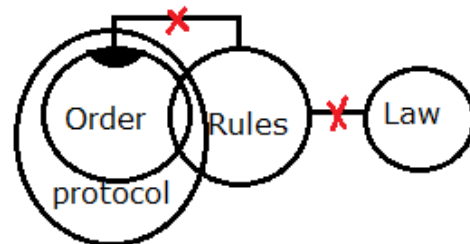

29) Answer: B

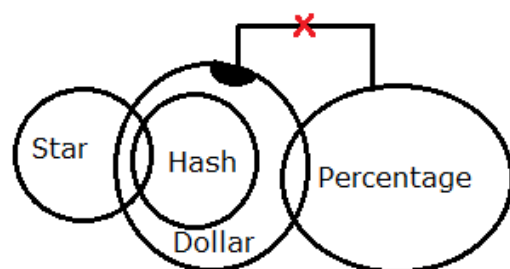

30) Answer: D

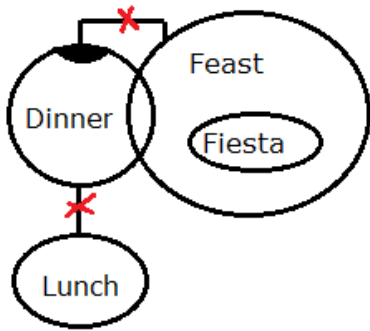

31) Answer: E

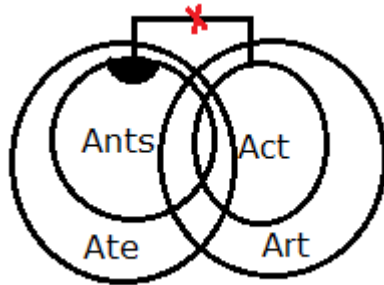

32. Answer: D

4 3 6 8 5 9 4 3 7
 5 2 7 7 6 8 5 2 8
 7+8=15

33. Answer: C

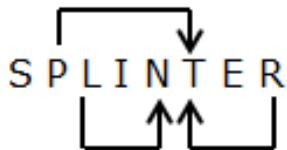

Directions (34-35):

34) Answer: E

35) Answer: B

E>I>D>F>G (150 cm)>H

[Click Here to Get the Detailed Video Solution for the above given Quants Questions](#)

Or Scan the QR Code to Get the Detailed Video Solutions

36. Answer: E

$$\begin{aligned} ?/100 * 1200 + 14^2 + 288 &= 604 \\ ? * 12 + 484 &= 604 \\ ? * 12 &= 120 \\ ? &= 10 \end{aligned}$$

37. Answer: C

$$\begin{aligned} 15/100 * 380 + 60/100 * 600 &= ? - 48 * 20 \\ 57 + 360 &= ? - 960 \\ ? &= 1377 \end{aligned}$$

38. Answer: A

$$\begin{aligned} 180 \div (6 * 5 + 6 - 18) &= ? \div 8 \\ 180 \div 18 &= ? \div 8 \\ ? &= 80 \end{aligned}$$

39. Answer: B

$$\begin{aligned} 3^3 * 9^{?+2} \div 3^4 &= 27^{?-1} \\ 3^3 * 3^{2*?+4} \div 3^4 &= 3^{3*?-3} \\ 3^{2*?+3} &= 3^{3*?-3} \\ 2 * ? + 3 &= 3 * ? - 3 \\ ? &= 6 \end{aligned}$$

40. Answer: D

$$\begin{aligned} 16 * 28 + 15 * 14 &= ? + 8^3 \\ 448 + 210 &= ? + 512 \\ ? &= 146 \end{aligned}$$

41. Answer: A

$$\begin{aligned} 7/8 * 160 * 30/100 + ? * 8/9 &= ? \\ 42 = ? - 8 * ?/9 \\ 42 &= ?/9 \\ ? &= 378 \end{aligned}$$

42. Answer: C

$$45/100 * 900 + \sqrt{(6^2 + 2^2 + 3^2)} = ?$$

$$405 + \sqrt{49} = ?$$

$$? = 412$$

43. Answer: E

$$220/100 * \sqrt[3]{27000} + \sqrt{1156} = ?^2$$

$$22/10 * 30 + 34 = ?^2$$

$$66 + 34 = ?^2$$

$$?^2 = 100$$

$$? = 10$$

44. Answer: E

$$450 * 4^2 \div 5^2 + 482 = ?$$

$$450 * 16 \div 25 + 482$$

$$? = 288 + 482 = 770$$

45. Answer: A

$$350 \div 7 + 480 \div 6 = 26 * ? + 26$$

$$50 + 80 = 26 * ? + 26$$

$$104 = 26 * ?$$

$$? = 4$$

46. Answer: C

Demand for wheat in state A in 2010 = $300 * 125/100 = 375$ MT

Actual production of wheat in state A in 2010 = $(160 + 280)/2 = 440/2 = 220$ MT

Required sum = $220 + 375 = 595$ MT

47. Answer: D

Demand for rice in 2018 = $200 * 120/100 = 240$ MT

Actual production of rice in 2018 = $240 - 120 = 120$ MT

48. Answer: A

Deficient production in Rice in 2014 = $360 - 280 = 80$ MT

Deficient production in Rice in 2016 = $200 - 100 = 100$ MT

Required difference = $100 - 80 = 20$ MT

49. Answer: C

Required percentage = $240/100 * 100 = 240\%$

50. Answer: A

Required ratio = $160:120 = 4:3$

51. Answer: A

$$5000 * x * 10/100 - 8000 * 20 * x/5 * 1/100 = 4500$$

$$500x - 320x = 4500$$

$$180x = 4500$$

$$x = 25$$

52. Answer: D

Initial quantity of milk = $36 * 3 = 108$ litres

Initial quantity of water = $36 * 2 = 72$ litres

Initial quantity of mixture = $108 + 72 = 180$ litres

$$(108 - 90 * 3/5)/(72 - 90 * 2/5 + x) = 9/16$$

$$(108 - 54)/(72 - 36 + x) = 9/16$$

$$54/(36 + x) = 9/16$$

$$6 * 16 = 36 + x$$

$$x = 96 - 36 = 60$$
 litres

53. Answer: B

Let the distance between City A and City B be x km and the distance between City B and City C be y km.

$$x = 8a$$

$$y = 12 * 50 = 600$$
 km
$$46 = (8a + 600)/(8 + 12)$$

$$46 * 20 = 8a + 600$$

$$920 = 8a + 600$$

$$8a = 320$$

$$a = 40$$
 km/hr
$$x = 8 * 40 = 320$$
 km

54. Answer: D

Wages obtained by A = $1500 - 900 = \text{Rs.}600$

Ratio of the wages obtained by A and B is equal to the efficiency ratio of A and B.

Efficiency ratio of A and B = $600:900 = 2:3$

Ratio of the time taken by A to B alone to complete the work = $3:2$

Time taken by A alone to complete the work = $3x$

Time taken by B alone to complete the work = $2x$

$$1/3x + 1/2x = 1/12$$

$$(2 + 3)/6x = 1/12$$

$$5/x = 1/2$$

$$x = 10 \text{ days}$$

Time taken by A alone to complete the work =

$$3 * 10 = 30 \text{ days}$$

55. Answer: A

Let the speed of the boat in still water be B km/hr and the speed of the current be C km/hr.

$$B + C = x/(x/30)$$

$$B + C = 30$$

$$B - C = x/(x/18)$$

$$B - C = 18$$

$$2B = 48$$

$$B = 24 \text{ km/hr}$$

56. Answer: C

$$4000 * 125/100 * (100 - 10)/100 * (100 - x)/100 = 4000 - 400$$

$$5000 * 90/100 * (100 - x)/100 = 3600$$

$$45 * (100 - x) = 3600$$

$$100 - x = 80$$

$$x = 20$$

57. Answer: A

$$A + B + C = 24 * 3 = 72 \text{ years}$$

$$A + B = 24 * 2 = 48 \text{ years}$$

$$C = 72 - 48 = 24 \text{ years}$$

$$B + 4 + C + 4 = 26 * 2$$

$$B + C = 52 - 8 = 44 \text{ years}$$

$$A = 72 - 44 = 28 \text{ years}$$

$$\text{Required ratio} = 28:(24 + 6) = 28:30 = 14:15$$

58. Answer: D

$$(6x + 56) * 100/68 * 30/100 + x = (6x + 56) * 100/68 * 40/100$$

$$(6x + 56) * 15/34 + x = (6x + 56) * 10/17$$

$$x = (6x + 56) * 10/17 - (6x + 56) * 15/34$$

$$x = ((6x + 56) * 20 - (6x + 56) * 15)/34$$

$$34x = 120x + 1120 - 90x - 840$$

$$4x = 280$$

$$x = 70$$

$$\text{Maximum marks} = (6 * 70 + 56) * 100/68 =$$

$$476 * 100/68 = 700$$

59. Answer: B

$$x * 20/(x * 20 + 4000 * 15 + 6000 * 10) = 5000/11000$$

$$20x/(20x + 60000 + 60000) = 5/11$$

$$220x = 100x + 600000$$

$$120x = 600000$$

$$x = \text{Rs.}5000$$

60. Answer: D

Let the side of the square be x m and the side of the cube be y m.

$$4 * x = 60$$

$$x = 15 \text{ m}$$

$$(4 * y * y)/(15 * 15) = 64/25$$

$$y^2/9 = 16$$

$$y^2 = 16 * 9$$

$$y^2 = 144$$

$$y = 12 \text{ m}$$

$$\text{Total surface area of the cube} = 6 * 12 * 12 = 864 \text{ m}^2$$

61. Answer: D

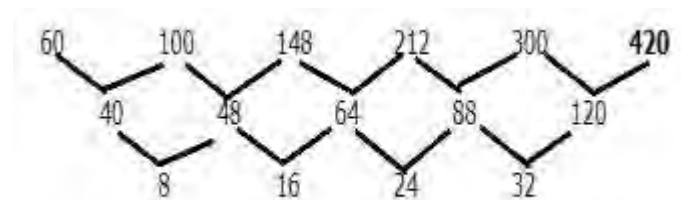

62. Answer: C

$$90720 \div 9 = 10080$$

$$10080 \div 8 = 1260$$

$$1260 \div 7 = \mathbf{180}$$

$$180 \div 6 = 30$$

$$30 \div 5 = 6$$

63. Answer: A

$$60 + 1^3 = 61$$

$$61 - 2^2 = 57$$

$$57 + 3^3 = 84$$

$$84 - 4^2 = 68$$

$$68 + 5^3 = 193$$

64. Answer: C

$$3 * 1 + 3 = 6$$

$$6 * 2 + 5 = 17$$

$$17 * 3 + 7 = 58$$

$$58 * 4 + 9 = 241$$

$$241 * 5 + 11 = 1216$$

65. Answer: E

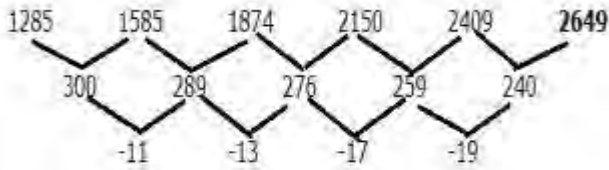

66. Answer: C

Number of vanilla ice creams sold in Shop F = $500 * 90/100 = 450$
 Number of strawberry ice creams sold in Shop F = $(480 + 360)/2 * 2/3 = 280$
 Required sum = $450 + 280 = 730$

67. Answer: A

Total number of Vanilla ice creams in Shop C = $640 * (4 + 1)/4 = 640 * 5/4 = 800$
 Total number of Vanilla ice creams in Shop D = $180 * (3 + 2)/3 = 180 * 5/3 = 300$
 Required difference = $800 - 300 = 500$

68. Answer: C

Total revenue generated in Shop A = $400 * 30 + 320 * 40 = 12000 + 12800 = \text{Rs.}24800$

69. Answer: D

Required ratio = $380:180 = 19:9$

70. Answer: B

Required percentage = $(500 - 460)/500 * 100 = 40/500 * 100 = 8\%$ less

[Click Here to Get the Detailed Video Solution for the above given English Questions](#)

Or Scan the QR Code to Get the Detailed Video Solutions



71. Answer: B

Every option other than the second one has been discussed but not in the first paragraph. We need to find an option that should have been discussed in the first paragraph. So, for this simple reason we can eliminate the options and mark (b) as the answer.

72. Answer: D

The fourth option given in the question is correct as it has been discussed in the second-last paragraph. The first option is not discussed by the author so, is not correct. The second option is incorrect as it has been given that India is one of the top three and not five. (c) has not been discussed anywhere. So, option (d) should be correct.

73. Answer: C

Refer to the lines from the second paragraph given below:
 The online education market is expected to reach \$11.6 billion by 2026, according to projections. These **figures imply** that **educational technology** (ed-tech) **is not merely a short-term adaptation** to the COVID times, but has established itself **as a long-term answer to all the problems the education industry** has previously faced. These lines tell us that the third option ie; (c) should be correct.

74. Answer: A

The entire passage explains the growth potential of the ed-tech. In almost all paragraphs, data related to the same has been given. The first option puts forth the theme perfectly. The second option is a single aspect of the main idea so it can be eliminated. The third option is merely a generalised statement so it can be ruled out. The fourth option is too general and it can be eliminated as well.

This makes option (a) the most appropriate answer.

75. Answer: A

The first option is incorrect as it is not just the hardware that makes ed-techs. It is much more than that as given in the first lines of the passage. So, this is incorrect. The second option is correct as given in the last paragraph. The third option is also correct as it has been discussed in the passage. The fourth option is also directly given. So, the correct answer is option (a).

76. Answer: B

The word identification makes the sentence grammatically incorrect. The first form of the verb should be used after 'to'

The correct usage should be 'to identify' Therefore, the correct answer is option (b).

77. Answer: A

The meaning of **significant** is **important**. India holds an important position... is what the sentence intends to say.

The correct option hence, should be the first one.

The other options do not match and should be eliminated.

So, the correct answer is option (a).

78. Answer: D

The words in options (a), (b) and (c) are similar in meaning to access. We need an

opposite. So, **refusal** which means to deny, should be correct.

This makes option (d) the most appropriate answer.

79. Answer: C

The sentence intends to explain that the importance of including sports in education has become widely acceptable. The whole idea is clear through the sentence but, the word that means **importance** is missing in the blank. The word **patience** does not fit the context nor does **timing**. Out of the three remaining words, the word **significance** makes the most sense in the paragraph. This makes option (c) the best answer for the given blank.

80. Answer: B

The word needed in the blank should mean to help or encourage the development of something... The word **encouraged** is one such option but, grammatically it does not fit so we can rule the same out. It should have been **encourage**... to be correct. The second option **fosters** is both contextually and grammatically correct. The words **gains**, **neglects** and **destroys** are all contextually and grammatically incorrect.

Thus, the correct answer is option (b).

81. Answer: C

The word **integrates** means to join things so that they become one thing or work together... In the sentence above, physical education integrates with the curriculum is what is being meant...

(a) makes no sense in the context. **Mixed** is grammatically incorrect. **Connect** is also grammatically incorrect.

This makes option (c) the most logical answer choice.

82. Answer: A

The word **lessons** should be correct because 'life-lessons' is a phrase which means

something from which useful knowledge or principles can be learned...

Chapters makes the sentence incorrect because this meaning is not intended here.

Example and **situation** are two words which are grammatically incorrect and also, contextually, the word **lessons** already contains these two meanings as well. This makes the word in option (a) the most suitable choice...

83. Answer: B

The word **winning** is the perfect match for the word **losing**...

The other words won't be parallel with **losing** as we need a gerund for the same. None of the options except winning fulfils the same. The word **loss** is contextually opposite of what's needed so it can be ruled out as well. This makes option (b) the most appropriate answer choice.

84. Answer: C

The word **train** is not fit in the context. How can one train **untapped** (something that has still not been found) potential? So, (a) can be ruled out. The word **seek** and the phrase **look for** are both same and correct as well grammatically. But two options together cannot be correct. So, both will be ruled out. the universities do not **employ** potential but **have** the same...

This makes the word **possess** the most logical answer choice making (c) the correct option.

85. Answer: A

The word **imposed** is used when the government imposes some ruled or things like that. It has that kind of usage... we have better words in the options that can be used in its place. The word **charged** can be taken to be true but it should not be followed by **with** in the given sentence. Same logic goes for **applied**.

The word **associated** can be followed by **with** and we can correctly use charges associated with in the given sentence.

Therefore, option (a) is correct.

86. Answer: C

The sentence given above can take the word **support** as it makes perfect sense in the same. The word **sale** makes no sense and can be ruled out. **promotion** is not a verb and the blank must take a verb...**maintain** is a verb but it is out of context...

This makes option (c) the best answer for the question above...

87. Answer: A

The limited access of women is being talked about which means a possessive should be used in the first part.

The correct usage in this case should be **women's**

The other parts are correct and need no improvement.

This makes option (a) the most appropriate answer option.

88. Answer: E

The given sentence is correct.

Therefore, the best option would be (e).

89. Answer: A

The subject in the given sentence is **e-waste** which is singular. For this a singular verb should be used. The same would go as, **e-waste --- releases**.

The correct answer should hence, be option (a).

90. Answer: D

The sentence carries an error of preposition. The fourth part of the sentence should use the preposition '**to**' after access as; **access to** is the correct phrasal usage. It means the ability, right, or permission to approach, enter, speak with, or use; admittance... the sentence talks about the access to the laboratory.

This makes option (d) the most logical answer choice.

91. Answer: B

The **rules** -- **are** and not **is**... should be the correct usage.

This makes option (b) the most logical answer choice.

92. Answer: B

The word **contend** used above means to have to deal with a problem or a difficult situation. The sentence isn't about anything like that. It talks about **content** which means that the word in option (b) should be improved.

93. Answer: C

The spellings of all the given words are correct but, the word **barriers** should instead be used because as a rule, **one of the** should be followed by a plural noun...

The best would hence, be to mark option (c) as the answer.

94. Answer: C

The word **practicel** is incorrectly spelt. The correct spelling of the same should be **practical**.

This makes option (c) the most logical answer choice...

95. Answer: E

All the highlighted words given above have been correctly spelt and need no correction. Therefore, the best would be to go with option (e) as the answer.

96. Answer: B

The spelling that needs a correction is given

in the second option. **Inherent** is the correct spelling which means something that is a basic or permanent part of somebody/something and that cannot be removed.

Borne out means proven...

The correct answer is option (b).

97. Answer: D

The word **understand** should come in A because, '**...understand the requirements...**' would make sense but not the way in which it has been given.

The words in A and D should be interchanged for this.

This makes option (d) the most logical answer choices

98. Answer: A

The words in B and C should be interchanged to make the given sentence correct. The word **relevant** should come in B. '**religious bodies**' should also be the correct usage which tells us that the word in B should come in C.

This makes option (a) the most logical answer option.

99. Answer: E

The words given in the sentence are all correctly placed.

So, option (e) should be correct.

100. Answer: B

The most obvious hint for the above statement is the usage of the word **rupees** which should come in D. This makes the words in A and D interchange their positions.

Therefore, the correct answer should be option (b).

Zero to Infinity

Importance of Zero to Infinity:

Seating arrangement and Puzzles are the most important topics that need more practice for every “Banking Aspirant”. Here, we are providing the content for all topics in a monthly basis for regular practice. It consists of the questions from “Basics to Hard level” (Prelims-Mains level), also we add some extra notes in a detailed manner to avoid confusion in the statements of seating arrangement and puzzles, this will help you to get a crystal clear view of each and every topic. We are providing questions based on the recent exam analysis, so that you can be the “Expert” in a particular topic if you are practicing the complete questions provided by us.

Circular Arrangement

Circular arrangement is one of the major topics asked in bank exams. Some time we get confused in some statements of circular arrangement, so we should give special attention to that kinds of statements, for those we are giving all kind of possible confusing statements related to circular arrangement. Go through it once before solving practice questions.

Confusing Statement In Circular Arrangement

Statement – 1: B sits three places away from A.

The above statement implies the following possible statements:

- Two persons sit between A and B.
- A sits third to the left of B or B sits third to the left of A.
- B sits third to the right of A or A sits third to the right of B.

Short Hint: Subtract one from the number of places according to the respective statements.

Three places away $\rightarrow 3-1=2$ persons sit between them

Four places away $\rightarrow 4-1=3$ persons sit between them

This is similar for the remaining cases.

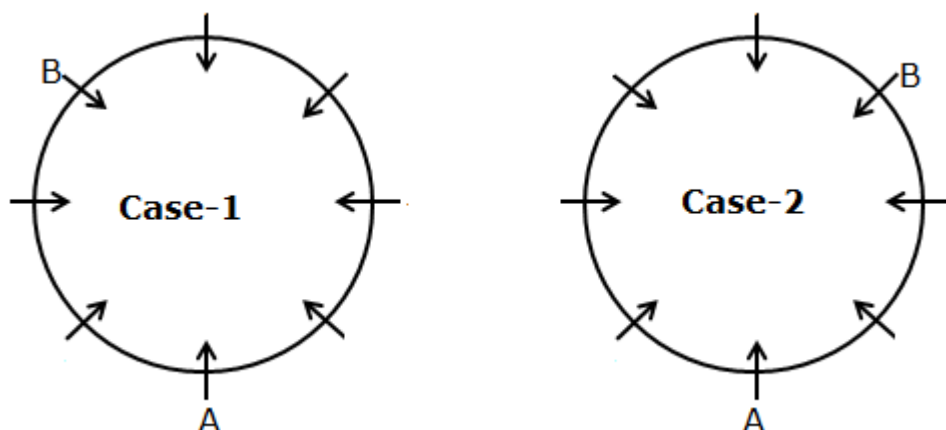

Statement – 2: As many persons sit between A and B as between B and C.

- Here, the number of persons sitting between A and B should be equal to the number of persons sitting between B and C. It can be one/two/three persons seated between A and B so the same number of persons should be seated between B and C.

Short Hint:

- I. Persons between A and B = Persons between B and C.
- II. B must be seated exactly between A and C.

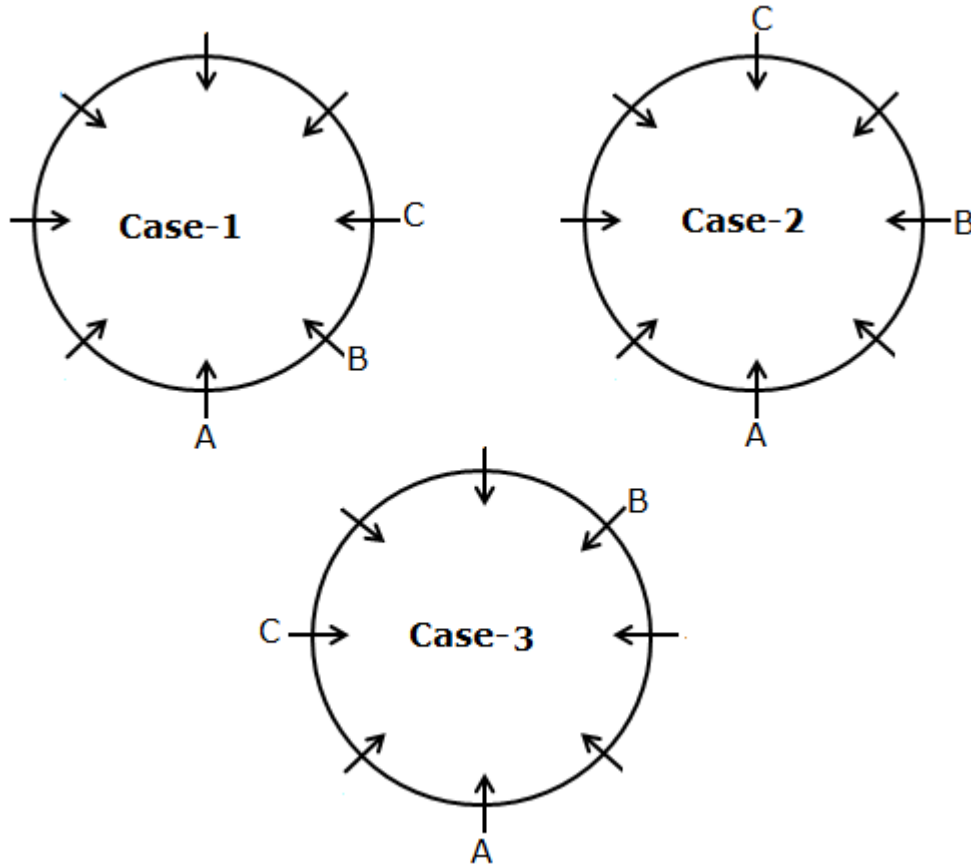

Statement – 2: As many persons sit between A and B as between C and D, when counted from the right of B and left of D.

- Here, the number of persons sitting between A and B should be equal to the number of persons sitting between C and D, when counted from the right of B and left of D. It can be one/two/three persons seated between A and B so the same number of persons should be seated between C and D, when counted from the right of B and left of D.

Short Hint:

- I. Persons between A and B = Persons between C and D.

In the below diagram, One person sits between A and B, when counted from the right of B, which is same as the number of persons sitting between C and D, when counted from the left of D.

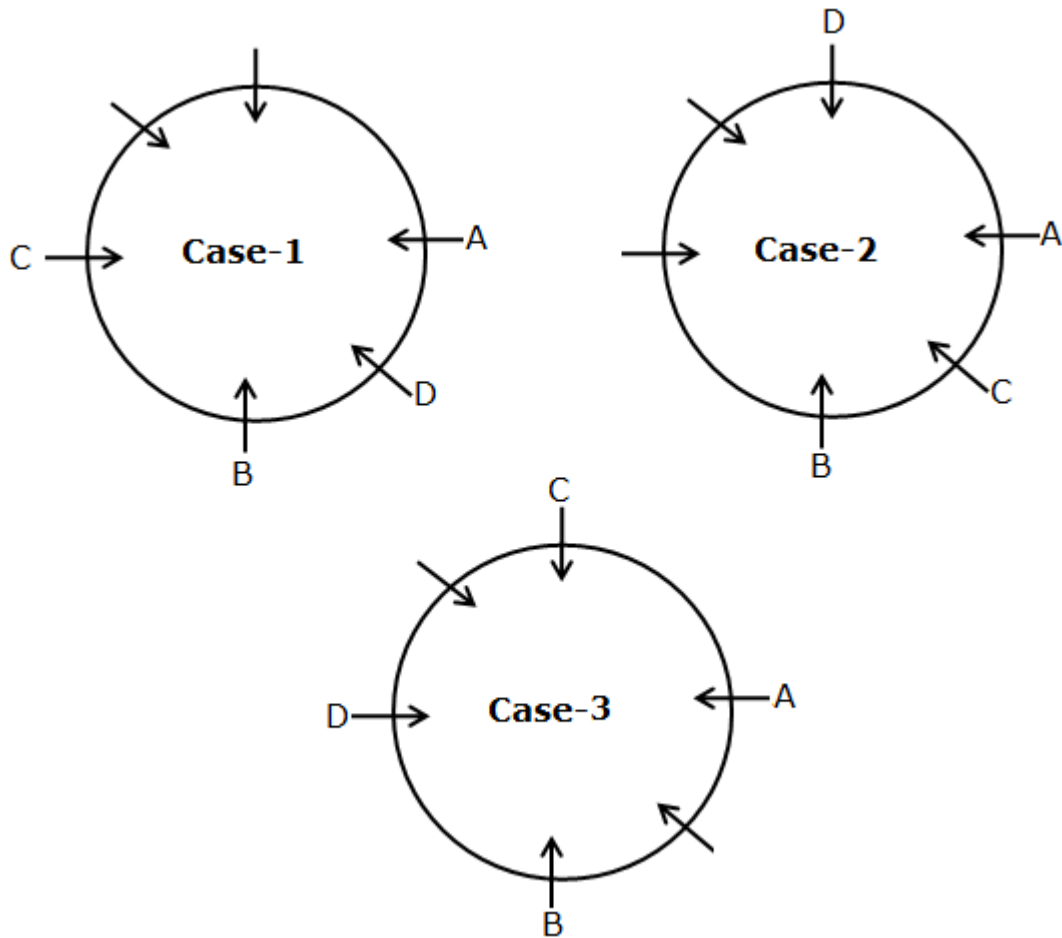

Statement – 3: At most three persons sit between A and B, when counted from the right of A.

The above statement implies the following possible statements:

- No person sits between A and B
- One/Two/Three persons sit between A and B

Short Hint: At most=Maximum, so as per the statement maximum of three persons sit between A and B, when counted from the right of A.

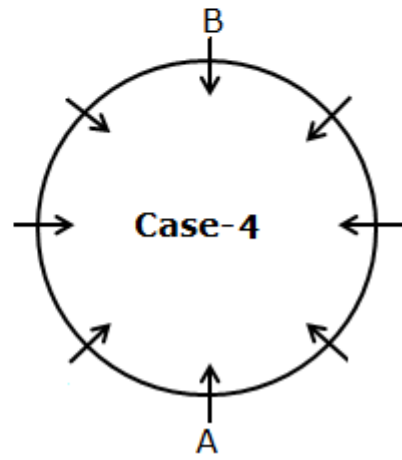
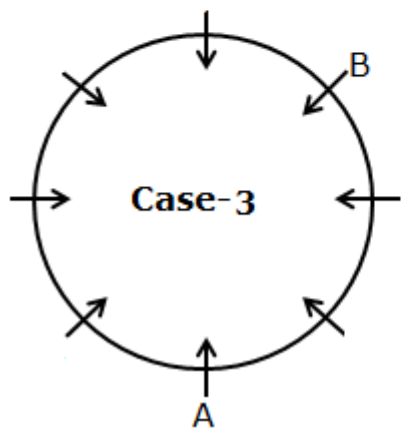
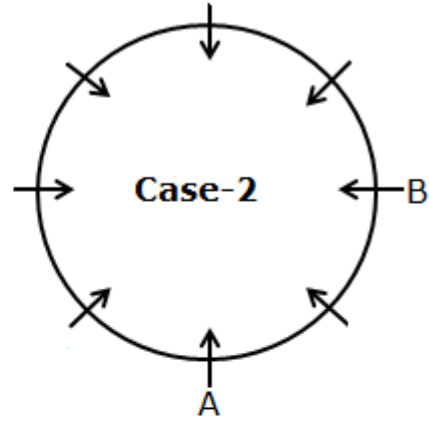
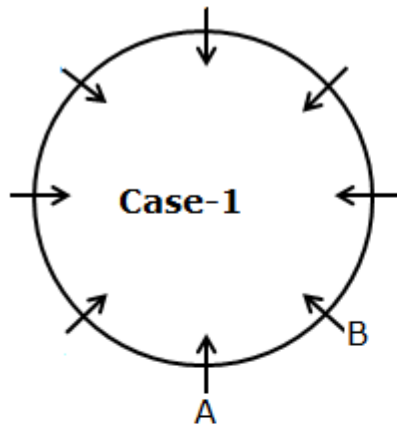

Statement – 4: At least two persons sit between A and B, when counted from the right of A.

The above statement implies the following possible statements:

- Two persons sit between A and B
- Three/Four/Five/Six persons sit between A and B

Note: The number of persons may be varied based on the total number of persons sitting at the circular table.

Short Hint: At least= Minimum, so as per the statement minimum of two persons sit between A and B, when counted from the right of A.

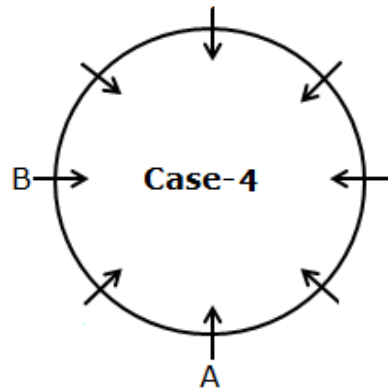
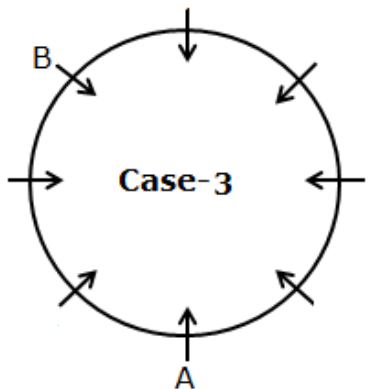
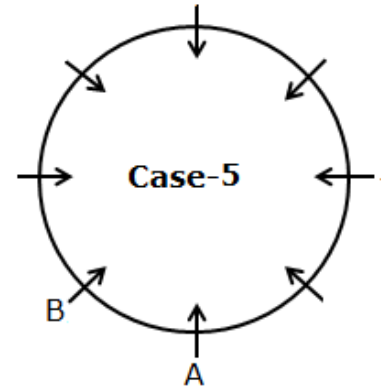
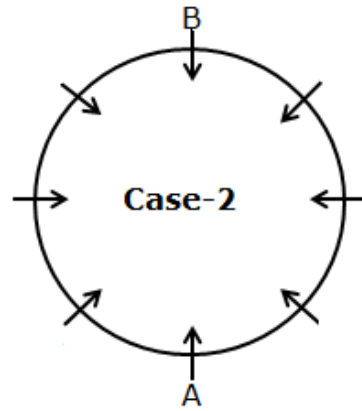
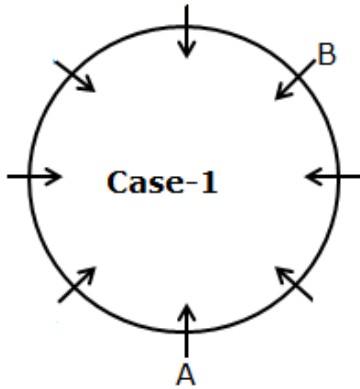

Statement – 5: Not more than two persons sit between A and B, when counted from the right of A.
The above statement implies the following possible statements:

- No person sits between A and B.
- One/Two persons sit between A and B.

Short Hint: Not more than =Maximum, so as per the statement maximum two persons sit between A and B, when counted from the right of A.

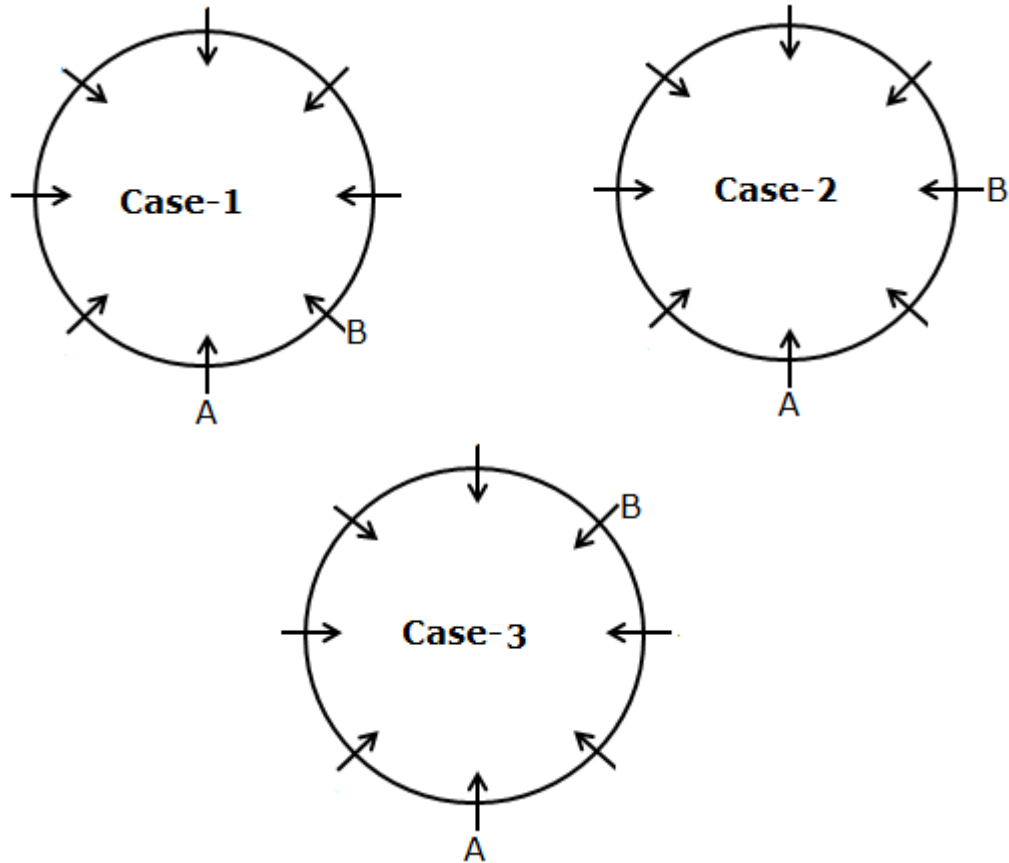

Statement – 6: At most/not more than three persons sit between A and B, when counted from the right of A.

The above statement implies the following possible statements:

- No person sits between A and B.
- One/Two/Three persons sit between A and B.

Short Hint: Not more than/At most=Maximum, so as per the statement maximum of three persons sit between A and B, when counted from the right of A.

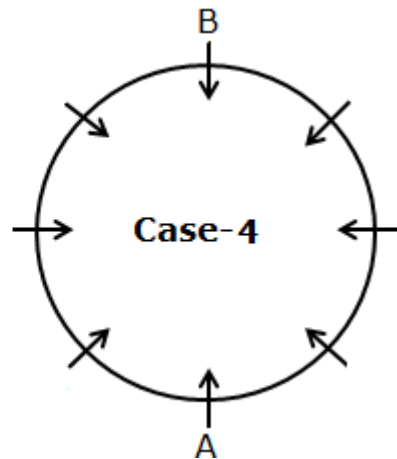
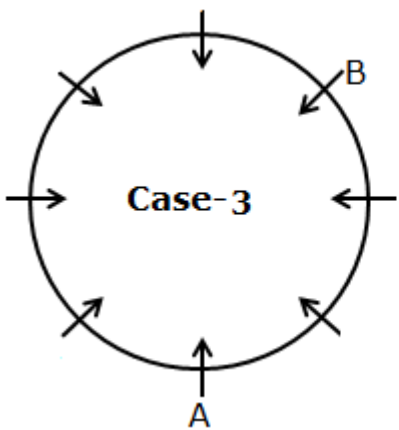
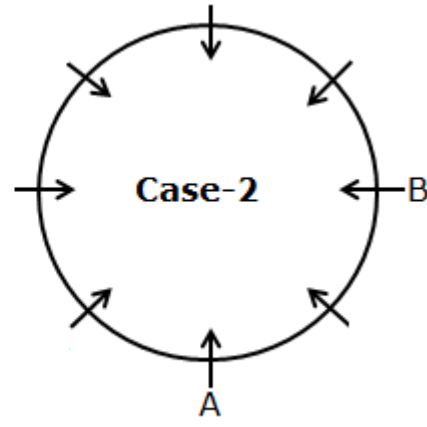
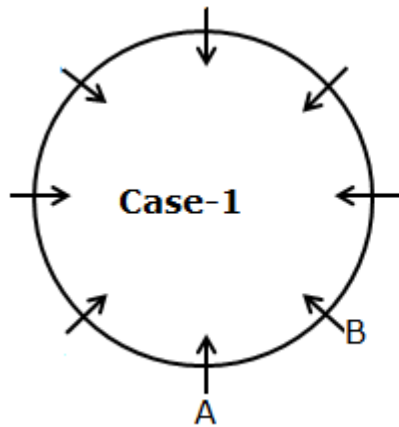

Statement – 7: C sits between A and B.

- Here, it is mentioned C sits between A and B, which means C can be seated at any position between A and B.

Short Hint: Between= In the space of middle two persons, so C can be seated at a gap of None/one/two/three persons between A and B, based on the number of persons sitting at the circular table.

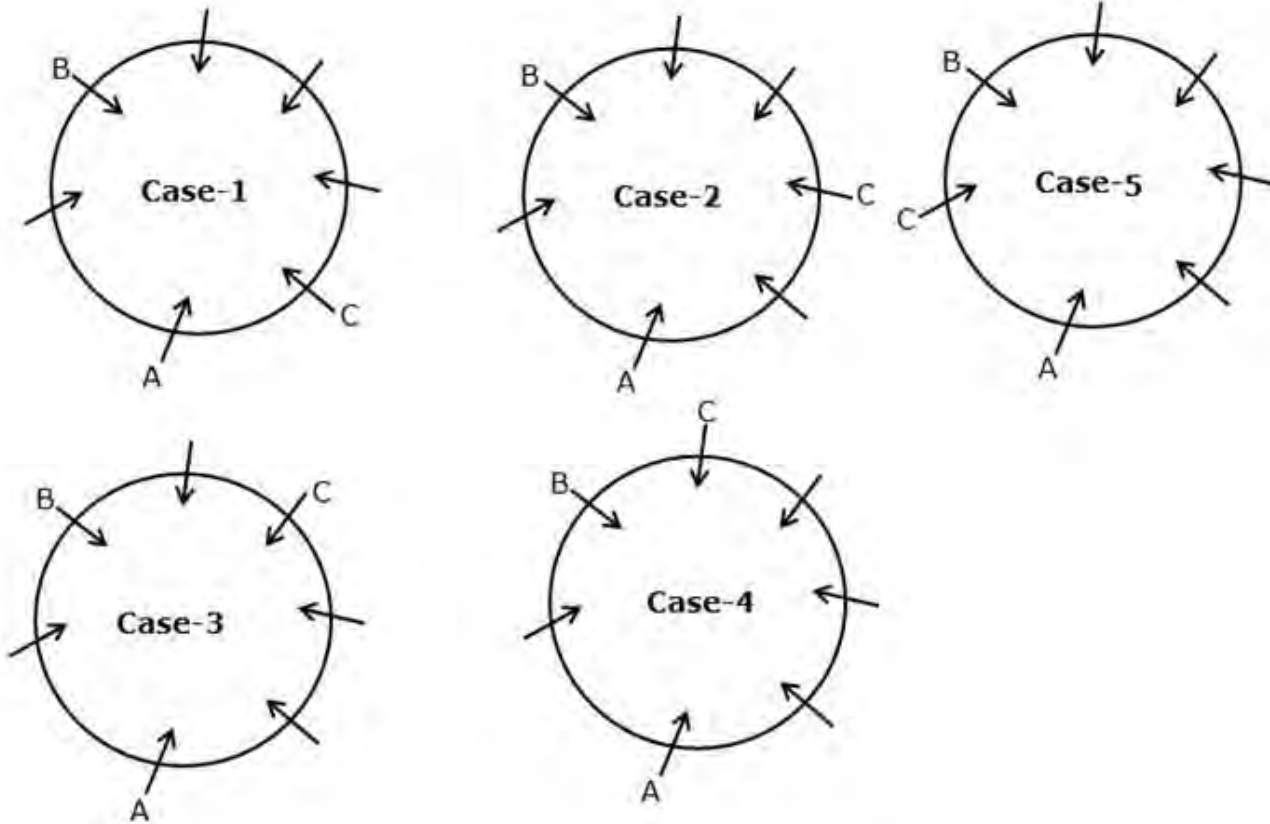

Statement – 8: C sits exactly between B and A.

Here, it is mentioned C sits exactly between A and B, which means there must be equal number of persons sitting between C and A and C and B.

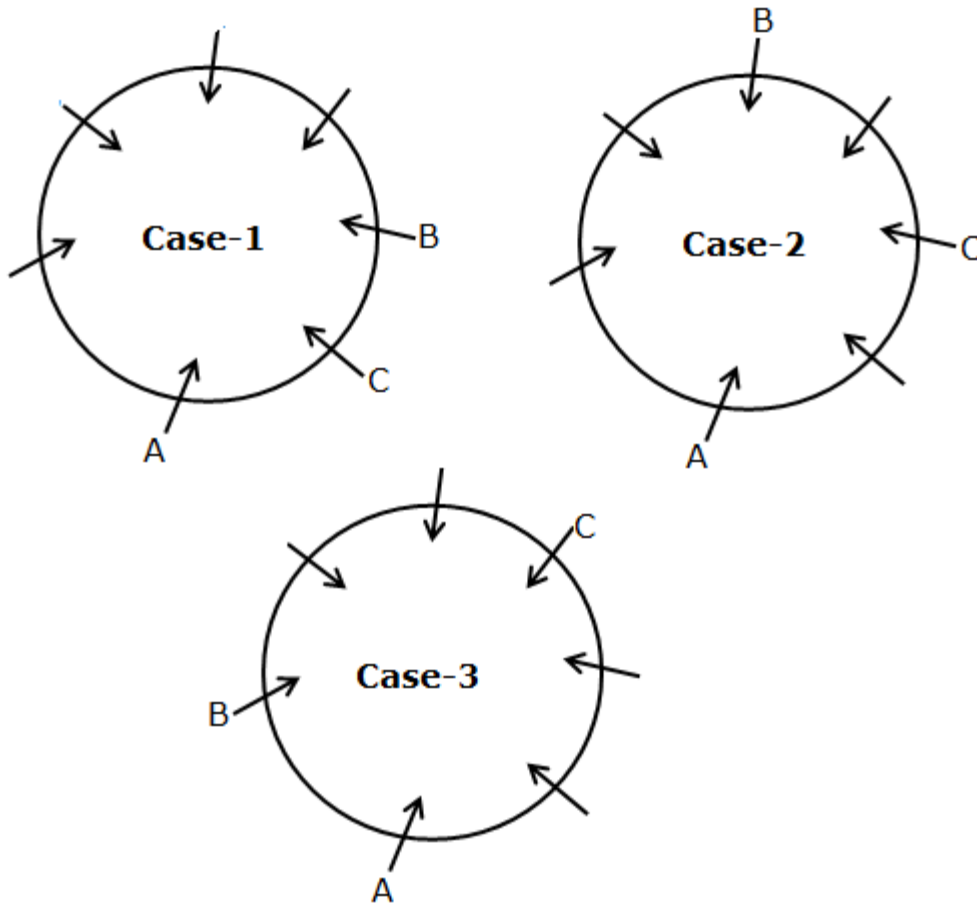

Statement – 9: One person sits between A and B. (If one vacant seat at the circular table)

The above statement implies the following possible statements:

- B sits second to the left of A or B sits second to the right of A.
- B sits third to the left of A or B sits third to the right of A

The above statement implies the following possible diagrams: (If seven persons sitting at the eight seated circular table)

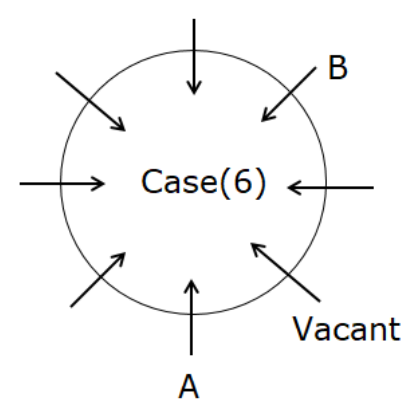
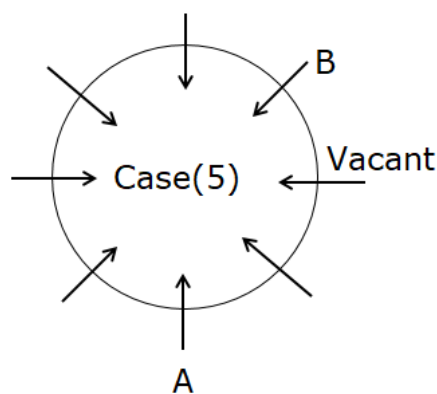
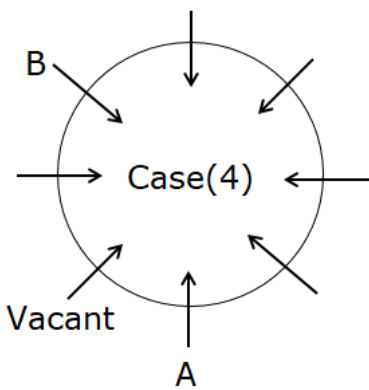
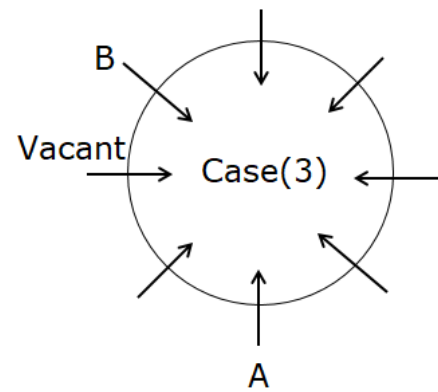
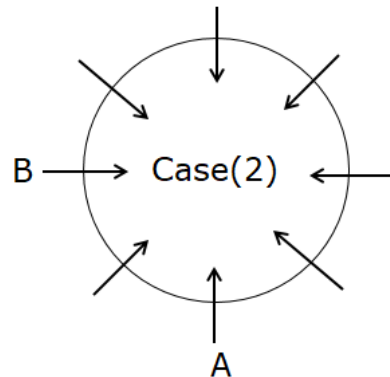
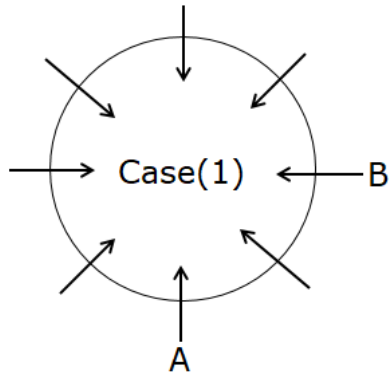

Statement – 10: The number of persons sitting between A and B is one less than the number of persons sitting between B and C, when counted from the right of A and left of C.

Short Hint: Persons between A and B = (Persons between B and C) – 1

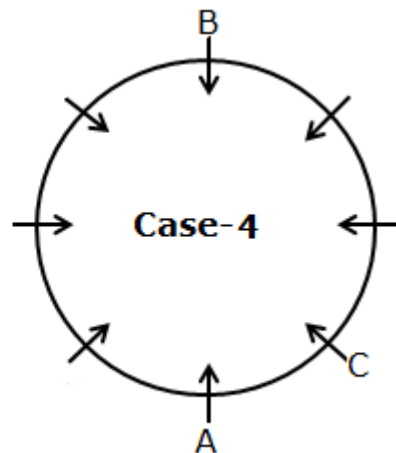
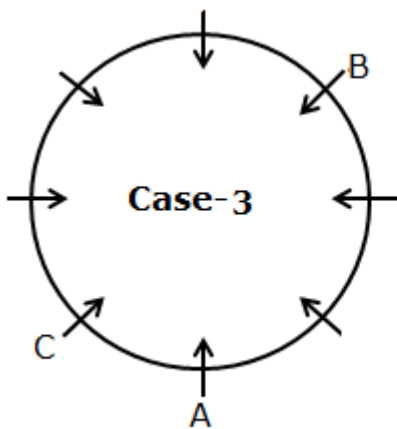
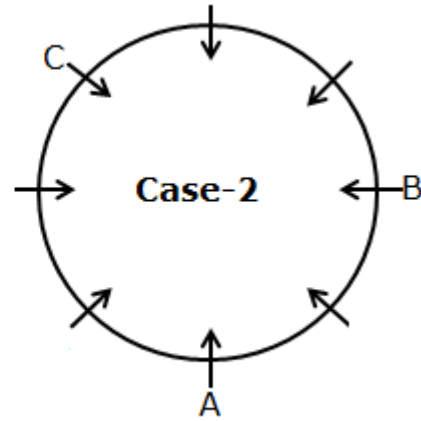
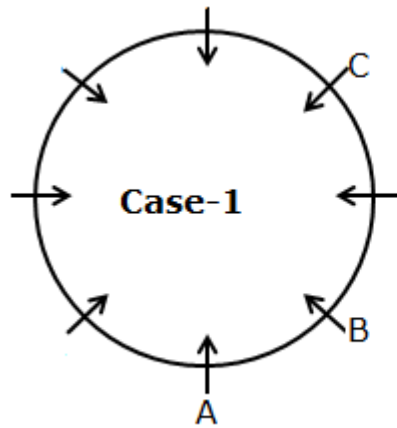

Note: This is similar for the number of persons sitting between A and B is **two/three less** than the number of persons sitting between B and C.

Persons between A and B = (Persons between B and C) – 2

Persons between A and B = (Persons between B and C) – 3

Statement – 11: The number of persons sitting between B and C is one more than the number of persons sitting between A and B when counted from the right of A and left of C

Short Hint: Persons between B and C = (Persons between A and B)+1

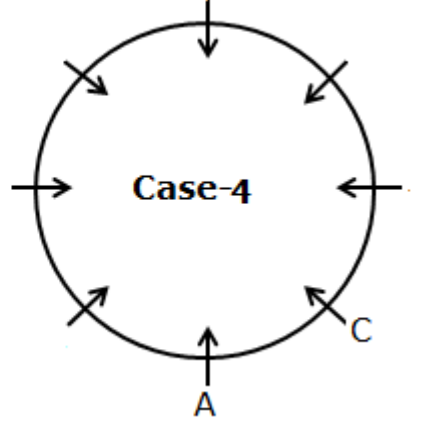
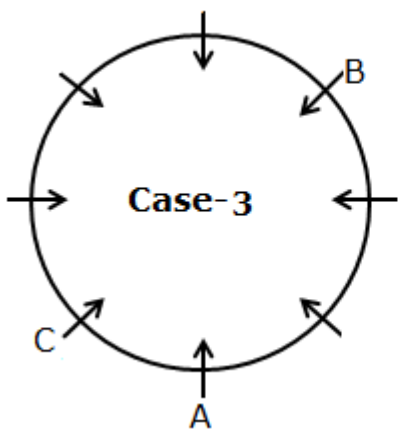
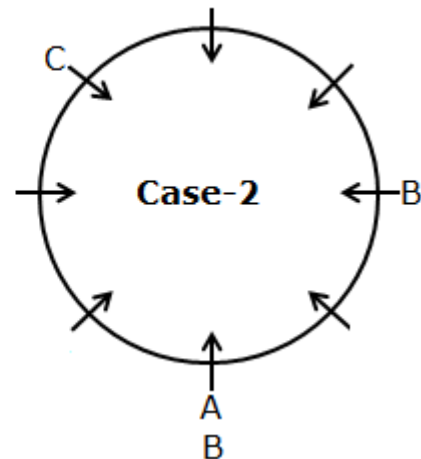
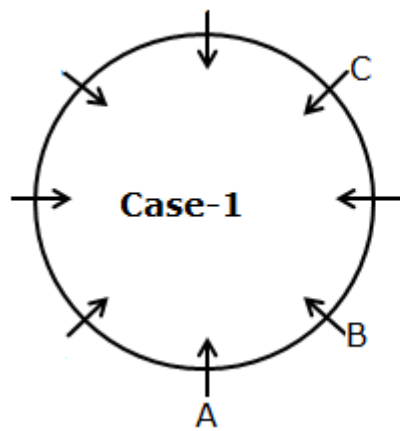

Note: The number of persons sitting between B and C is **two/three more** than the number of persons sitting between A and B.

Persons between B and C = (Persons between A and B)+2

Persons between B and C = (Persons between A and B)+3

Statement – 12: Not more than two persons sitting together are facing the same direction. A and D are facing the same direction but opposite direction of F. G and E are facing the same direction. B and H are facing opposite directions.

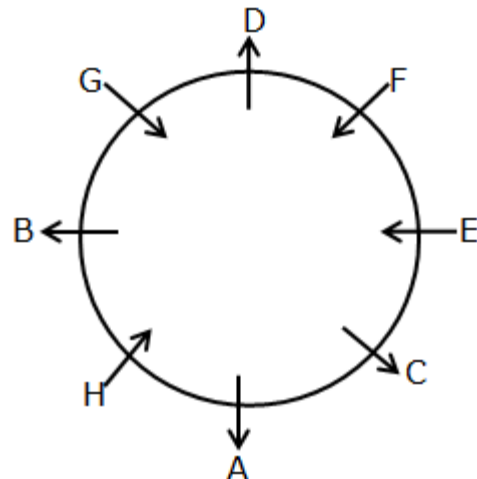

Short note: Only two adjacent persons are facing the same direction, the third person must face the opposite direction of that two persons.

Statement – 13: A is 40m away from B

Circumference of the circular table=320m, then it is given as eight persons facing towards the centre then the distance between the adjacent person becomes $320/8=40\text{m}$

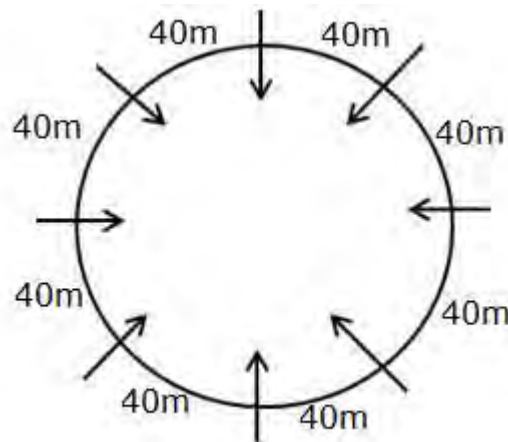

The above statement implies the following possible statements:

- A sits immediate right of B or A sits immediate left of B.
- No person sits between A and B.

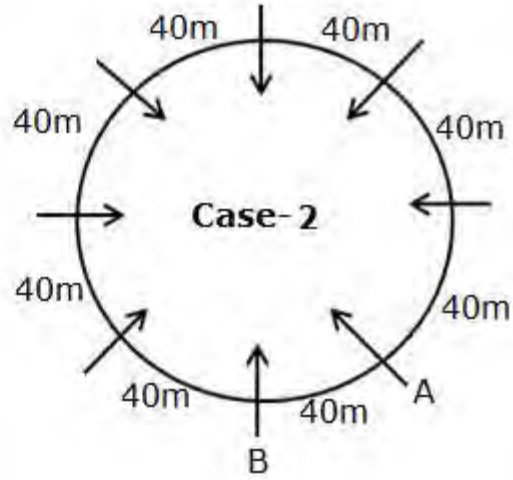
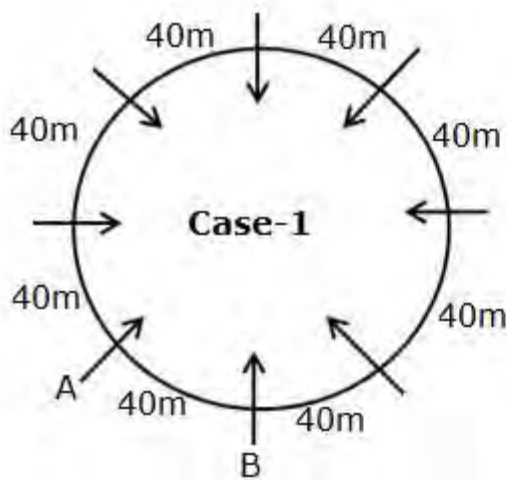

→ A is 80m away from B.

The above statement implies the following possible statements:

- A sits second to the left of B or A sits second to the right of B.
- One person sits between A and B.

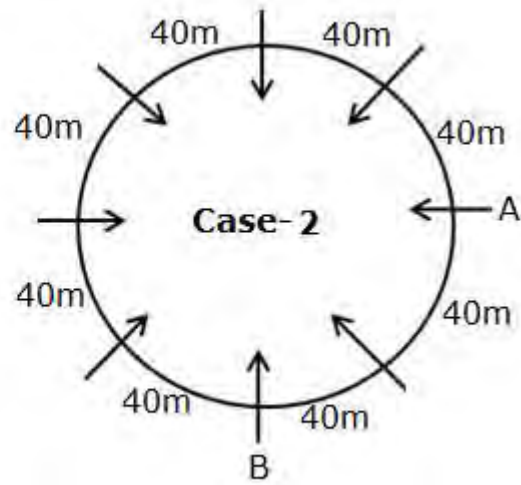
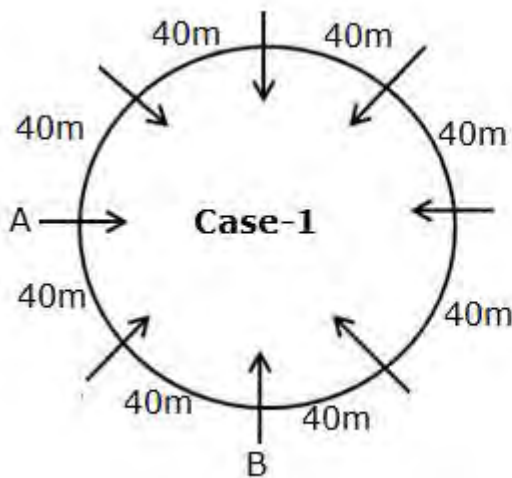

Statement – 13: If A faces B, then both are sitting at different circular tables.

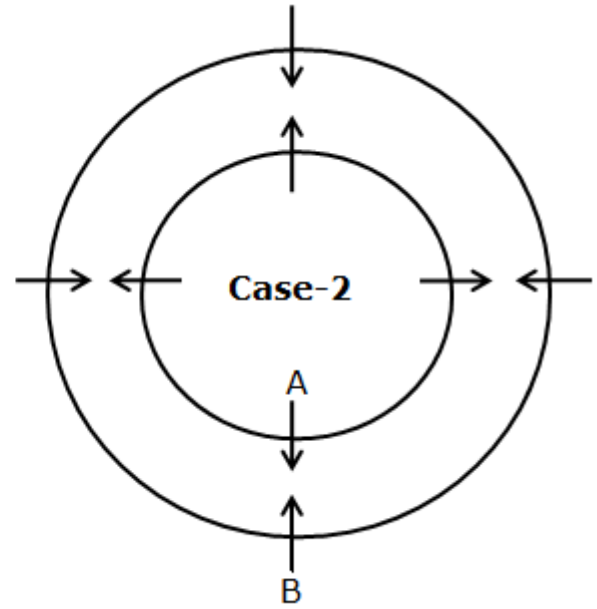
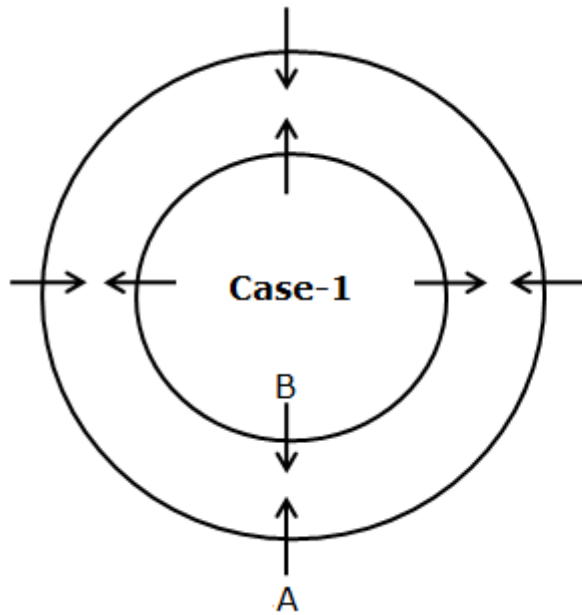

- A sits opposite to B, then both are sitting at the same table.

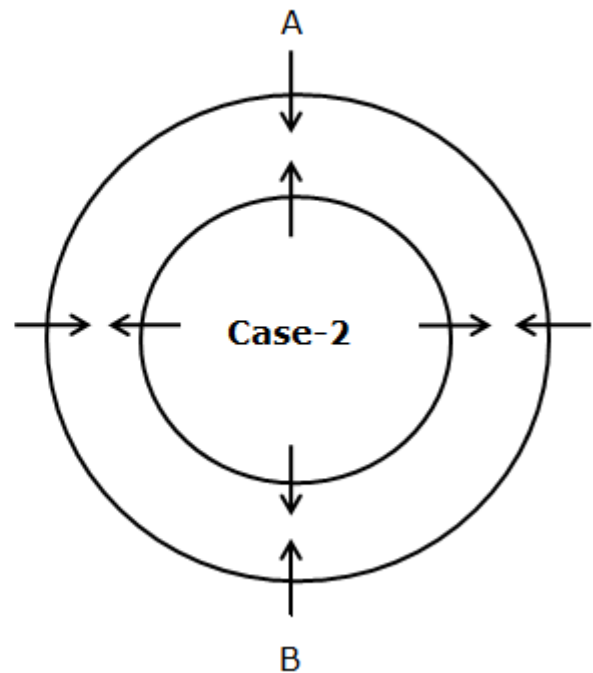
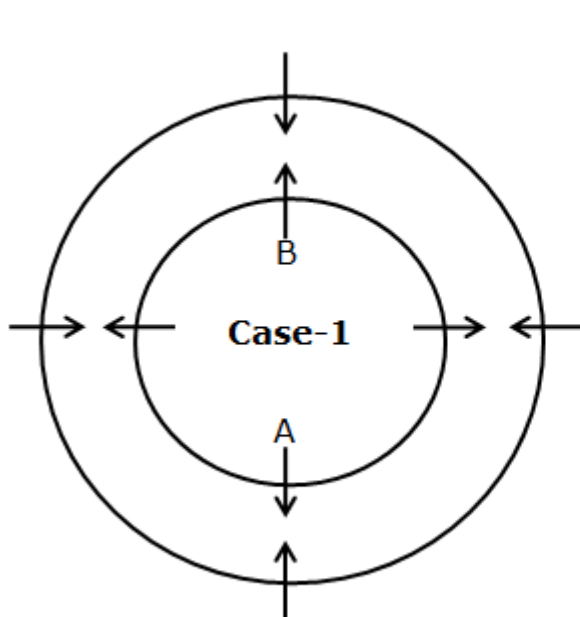

Statement – 14: The persons sitting adjacent to each other have neither common factors nor common multiple.

Short Note:

If A likes 24, then both the immediate neighbours of A (B and C) do not like the number which is common multiples and common factors of 24.

Common multiple of two numbers is a multiple that is shared by two or more numbers. For example, A likes 24 which is the common multiple of 2, 3, 4, 6, 8 and 12. So B and C are like the numbers which are not a multiple of 2, 3, 4, 6, 8 and 12.

Common factor states that when two or more numbers are exactly divided by the same number. For example, A likes 24 which is exactly divided by 2, 3, 4, 6, 8 and 12., So B and C like the numbers which are not exactly divided by 2, 3, 4, 6, 8 and 12.

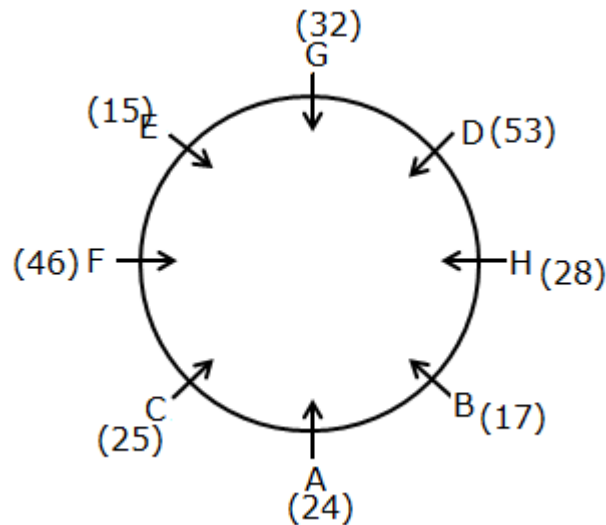

[Click Here to Get the Detailed Video Solution for the above given Questions](#)

Or Scan the QR Code to Get the Detailed Video Solutions



Practice Questions

Set 1 (Clerk Pre)

Directions (1-5): Study the following information carefully and answer the question given below

Eight persons - J, K, L, M, N, O, P and Q are sitting around a circular table facing the centre but not necessarily in the same order.

Only one person sits between L and N (either from left or right). L faces the one who sits immediate right of Q. O sits third to the right of N. J is an immediate neighbour of O. M sits second to the right of J. P is not an immediate neighbour of M. K does not sit opposite to Q.

1) Who among the following person sits immediate left of K?

- a) M
- b) O
- c) L
- d) P
- e) N

2) ___ and ___ are immediate neighbours of P.

- a) N and O
- b) J and M
- c) L and N

- d) Q and K
- e) K and M

3) What is the position of L with respect to J?

- a) Second to the left
- b) Third to the right
- c) Immediate right
- d) Fourth to the left
- e) Immediate left

4) ___ sits opposite to Q.

- a) N
- b) M
- c) J
- d) P
- e) None of these

5) How many persons sit between M and O, when counted from the right of O?

- a) Three
- b) None
- c) Four
- d) One
- e) Two

[Click Here to Get the Detailed Video Solution for the above given Questions](#)

Or Scan the QR Code to Get the Detailed Video Solutions



Answer Key with Explanation

Directions (1-5):

- 1) Answer: A
- 2) Answer: C
- 3) Answer: A
- 4) Answer: D
- 5) Answer: E

Final Arrangement:

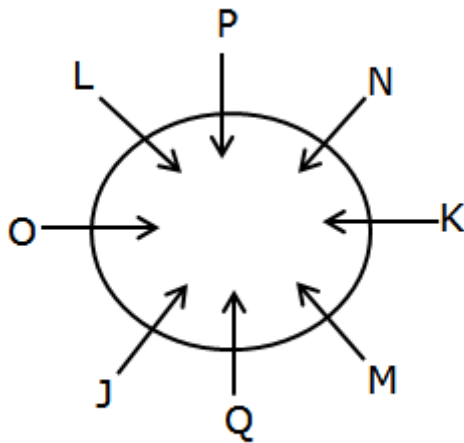

We have,

- L faces the one who sits immediate right of Q.
- Only one person sits between L and N(either from left or right).

From the above condition, there are two possibilities.

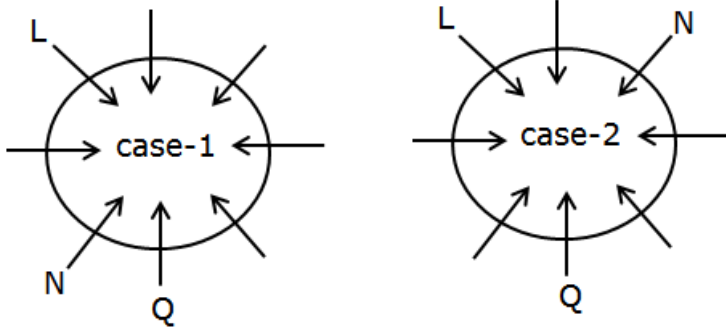

Again we have,

- O sits third to the right of N.
- J is an immediate neighbour of O.
- M sits second to the right of J.

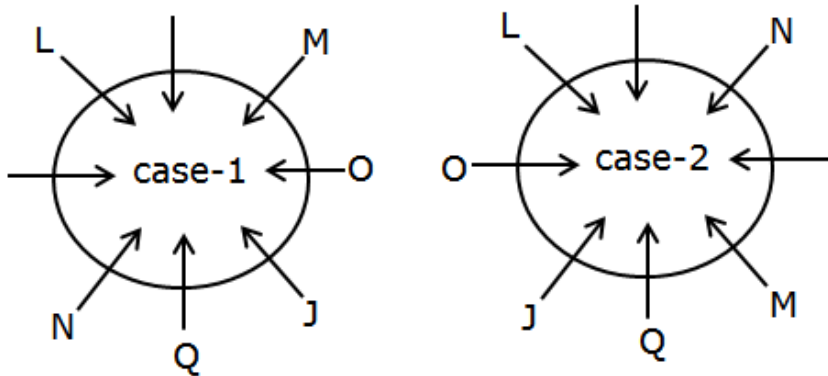

Again we have,

- P is not an immediate neighbour of M.
- K does not sit opposite to Q.

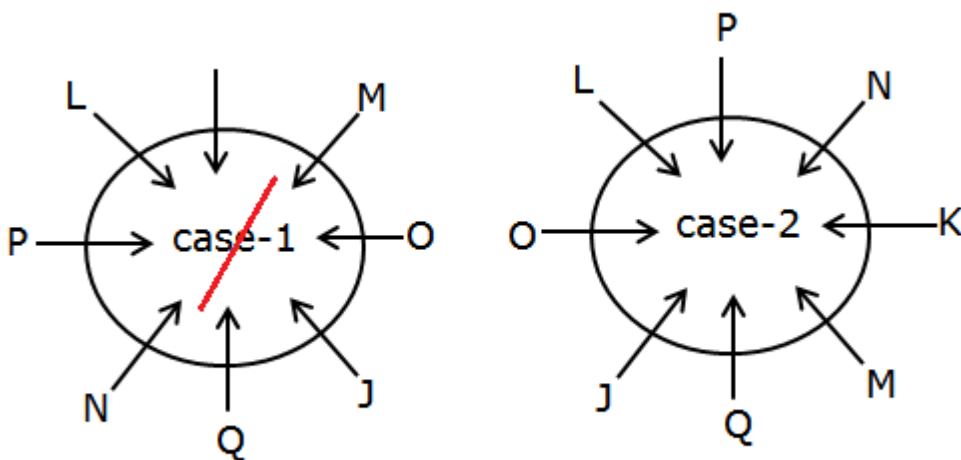

From the above condition, case-1 gets eliminated.

Set 2 (Clerk Pre)

Direction (6-10): Study the following information carefully and answer the question given below Eight persons- P, Q, R, S, T, U, V and W are sitting around a circular table facing away from the centre but not necessarily in the same order.

Only two persons sit between Q and V (either from left or right). T sits second to the left of V. S sits third to the right of T. Only three persons sit between S and W. U sits second to the left of P.

6) Who among the following person sits third to the left of V?

- a) U
- b) R
- c) W
- d) S
- e) P

7) How many persons sit between U and W, when counted from the left of U?

- a) One
- b) Three
- c) None
- d) Two

e) Four

8) What is the position of P with respect to S?

- a) Third to the right
- b) Fourth to the left
- c) Second to the right
- d) Immediate left
- e) Fifth to the right

9) Who among the following person sits immediate right of U?

- a) The one who sits opposite to R
- b) S
- c) P
- d) The one who sits opposite to T
- e) V

10) Which of the following statement(s) is/are false based on the given information?

- a) W sits adjacent to P
- b) S sits second to the left of Q
- c) T does not sit opposite to U
- d) R sits second to the right of W
- e) None is false

[Click Here to Get the Detailed Video Solution for the above given Questions](#)

Or Scan the QR Code to Get the Detailed Video Solutions



Answer Key with Explanation

Direction (6-10):

6) Answer: C

7) Answer: E

8) Answer: A

9) Answer: A

10) Answer: C

Final arrangement

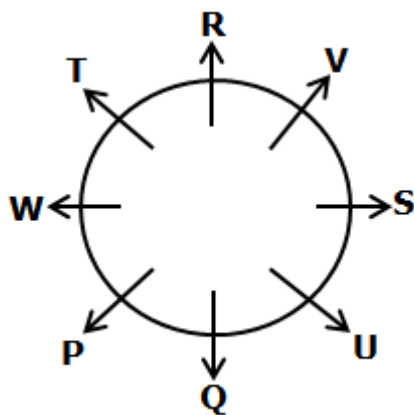

We have,

- Only two persons sit between Q and V (either from left or right).
- T sits second to the left of V.

From the above condition, there are two possibilities.

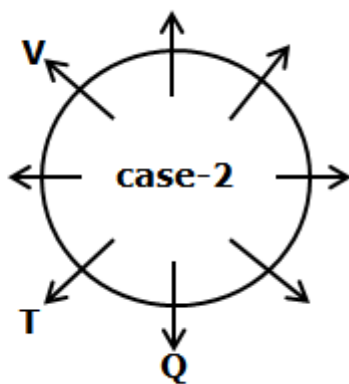
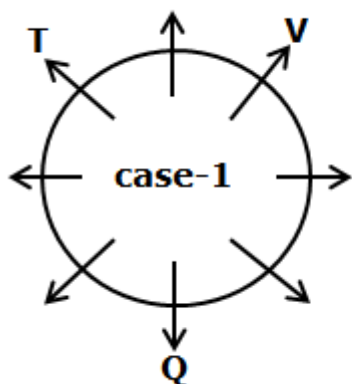

Again we have,

- S sits third to the right of T.

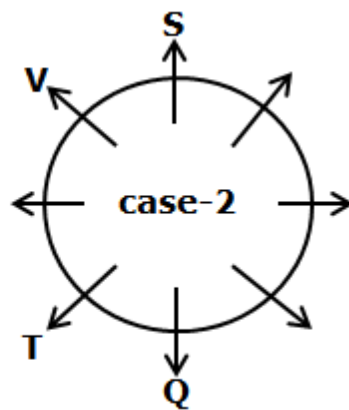
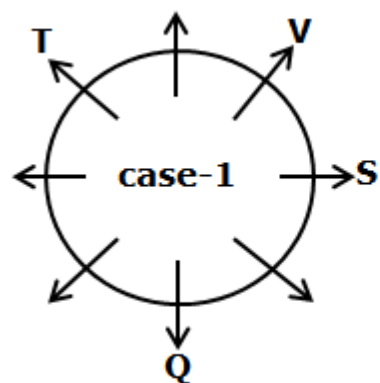

Again we have,

- Only three persons sit between S and W.
- U sits second to the left of P.

From the above conditions, case-2 gets eliminated, hence case 1 shows the final arrangement

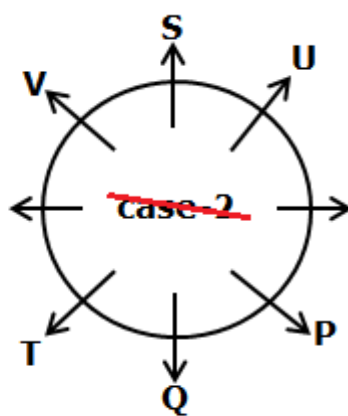
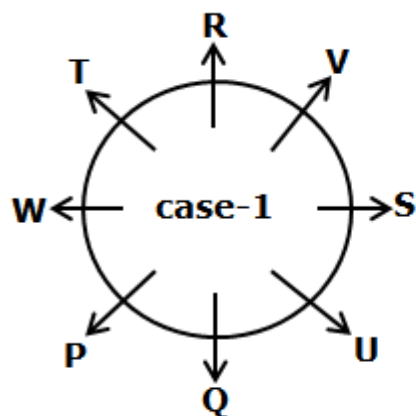

Set 3 (Clerk Pre)

Directions (11-15): Study the following information carefully and answer the questions given below.

Certain number of persons are sitting around a circular table facing the centre. At least fifteen persons are sitting around the table.

L sits second to the left of O. Three persons sit between O and E. E sits second to the right of K. As many persons sit between L and E as between E and B. F sits third to the right of B. F is an immediate neighbour of L. T sits exactly in the middle of both B and E when counted from the right of E.

11) How many persons sit between E and T, when counted from the right of E?

- a) Three
- b) Two
- c) Four
- d) Five
- e) One

12) How many persons are sitting around the circular table?

- a) 16
- b) 17
- c) 18

- d) 15
- e) 19

13) Who among the following person sits third to the left of O?

- a) E
- b) K
- c) F
- d) T
- e) B

14) What is the position of T with respect to F?

- a) Fifth to the right
- b) Fifth to the left
- c) Sixth to the right
- d) Seventh to the left
- e) Sixth to the left

15) If the positions of E and K are interchanged followed by L and O, then who among the following person sits second to the right of L?

- a) K
- b) E
- c) O
- d) B
- e) None of the above

[Click Here to Get the Detailed Video Solution for the above given Questions](#)

Or Scan the QR Code to Get the Detailed Video Solutions



Answer Key with Explanation

Directions (11-15):

- 11) Answer: B
- 12) Answer: A
- 13) Answer: C
- 14) Answer: E
- 15) Answer: B

Final Arrangement

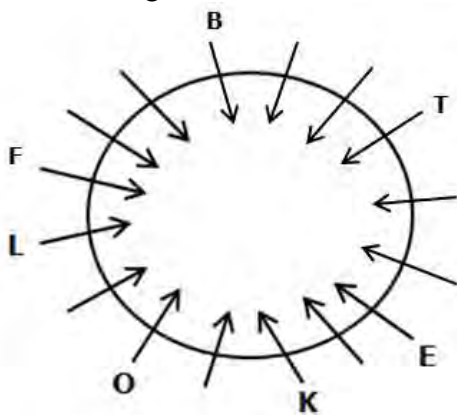

We have,

- L sits second to the left of O.
- Three persons sit between O and E.
- E sits second to the right of K.

From the above condition, there are two possibilities.

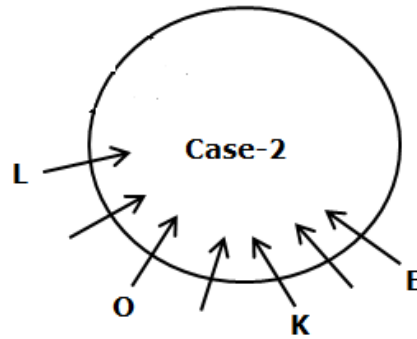
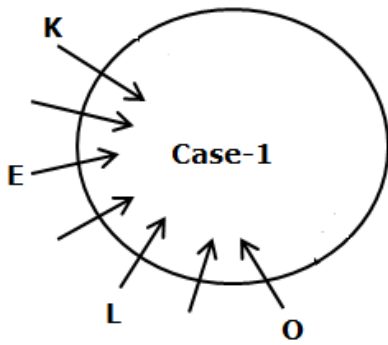

Again we have,

- As many persons sit between L and E as between E and B.
- F sits third to the right of B.
- F is an immediate neighbour of L.
- T sits exactly in the middle of both B and E, when counted from the right of E.

From the above condition, Case-1 gets eliminated. Case-2 shows the final arrangement.

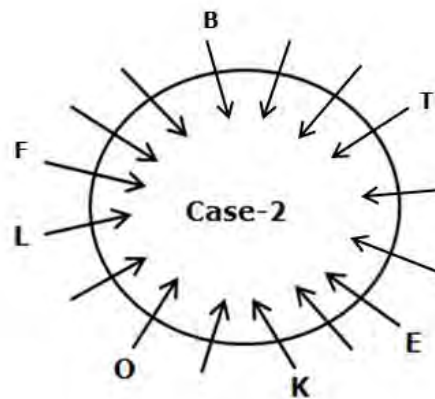
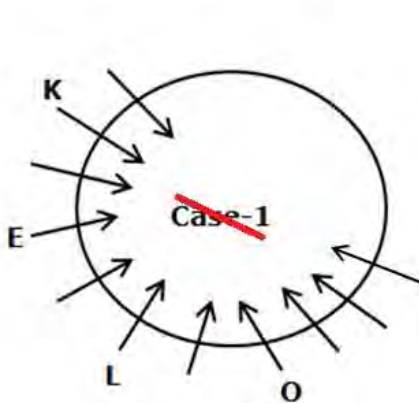

Set 4 (PO Pre)

Direction (16-20): Study the following information carefully and answer the questions given below. Ten persons - A, B, C, D, E, F, G, H, I and J are sitting around a circular table facing the centre.

J sits second to the right of A. G sits three places away from A. B neither sits adjacent to G nor A. B sits second to the left of C. As many persons sit between B and C as between B and G. E is an immediate neighbour of C. Three persons sit between E and H. F sits third to the left of D.

16) Who among the following person sits fifth to the left of I?

- J
- H
- D
- F
- E

17) How many persons sit between G and B, when counted from the left of G?

- None
- One

- c. Four
- d. Five
- e. More than Five

18) Which of the following statement is true based on the given information?

- a. B sits second to the left of I
- b. G sits adjacent to A
- c. Four persons sit between C and J
- d. No one sits between J and E
- e. F sits to the immediate left of B

19) If all the persons are made to sit in alphabetical order from A in an anti-clockwise

direction, then how many persons remain unchanged in their position(excluding A)?

- a. One
- b. None
- c. Two
- d. Three
- e. More than Three

20) As many persons sit between F and I as between G and _____?

- a. E
- b. J
- c. H
- d. A
- e. C

[Click Here to Get the Detailed Video Solution for the above given Questions](#)

Or Scan the QR Code to Get the Detailed Video Solutions



Answer Key with Explanation

Direction (16-20):

16) Answer: D

17) Answer: E

18) Answer: C

19) Answer: B

20) Answer: A

Final arrangement

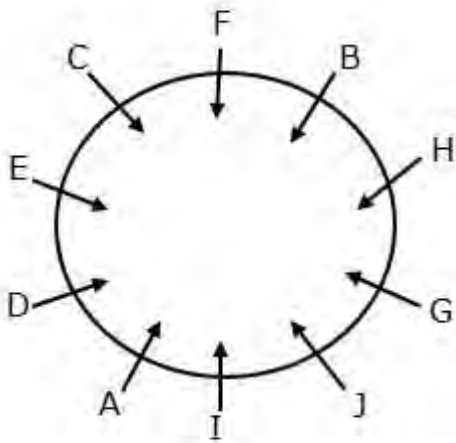

We have,

- J sits second to the right of A.
- G sits three places away from A.

From the above conditions, there are two possibilities

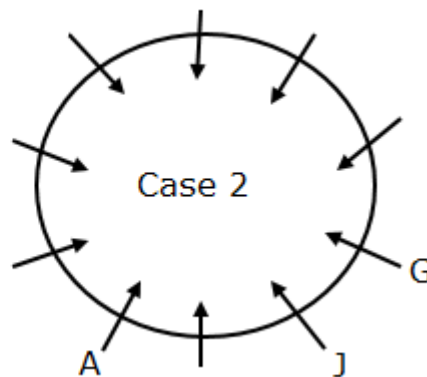
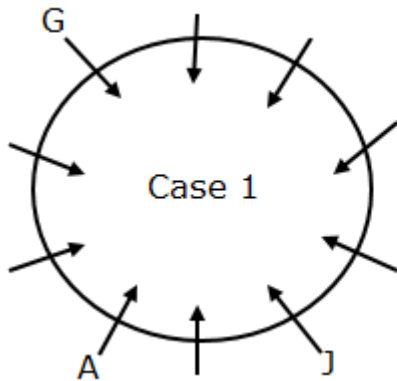

Again we have,

- B neither sits adjacent to G nor A.
- B sits second to the left of C.
- As many persons sit between B and C as between B and G.

From the above conditions, case 1 gets eliminated

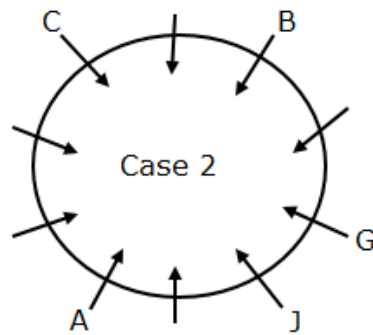
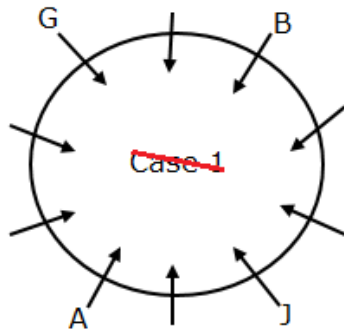

Again we have,

- E is an immediate neighbour of C.
- Three persons sit between E and H.
- F sits third to the left of D.

From the above conditions, case 2 shows the final arrangement

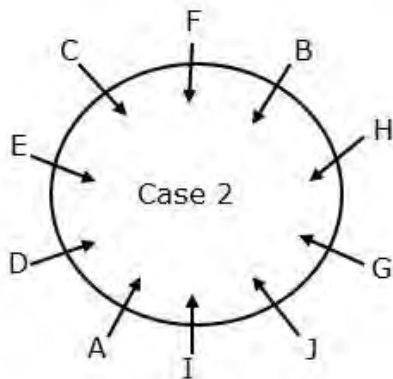

Set 5 (PO Pre)

Directions (21-25): Study the following information carefully and answer the questions given below Eight persons - P, Q, R, S, T, U, V and W are sitting around a circular table in such a way that some of them are facing towards the centre while some of them are facing away from the centre.

S sits third to the right of T, where both of them face the same direction. One person sits between T and U, who is not an immediate neighbour of S. P sits immediate right of U and opposite to S. W and R are facing each other. As many persons sit between U and Q as between Q and V, who sits adjacent to R. Both V and P

face the opposite direction of W, who sits immediate right of Q. Q is not facing T.

21. If all the persons are facing the opposite direction of the actual direction, then who sits second to the right of the one who sits immediate left of W?

- R
- V
- S
- T
- Q

22. Who among the following person sits third to the left of R?

- a) The one who faces S
- b) T
- c) W
- d) U
- e) The one who sits opposite to T

23. Four of the following five are alike in a certain way based on the given arrangement and thus form a group. Which one of the following does not belong to the group?

- a) U
- b) S
- c) Q
- d) R
- e) T

24. How many persons are sitting between U and V?

- a) Two
- b) One
- c) Three
- d) Five
- e) Four

25. If all the persons are made to sit in alphabetical order from P in a clockwise direction, then how many persons remain in the same position(Excluding P)?

- a) One
- b) Two
- c) Three
- d) More than three
- e) None

[Click Here to Get the Detailed Video Solution for the above given Questions](#)

Or Scan the QR Code to Get the Detailed Video Solutions



Answer Key with Explanation

Directions (21-25):

21. Answer: B

22. Answer: E

23. Answer: D (In the given options, all the persons are facing away from the centre, except in option d)

24. Answer: C

25. Answer: A

Final arrangement:

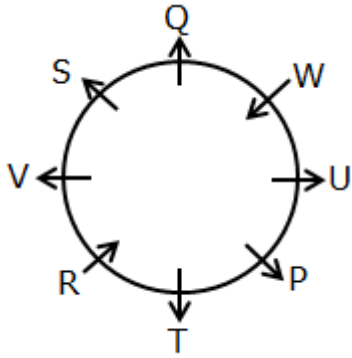

We have,

- S sits third to the right of T, where both of them face the same direction.
- One person sits between T and U, who is not an immediate neighbour of S.

While applying above conditions, we have two possibilities:

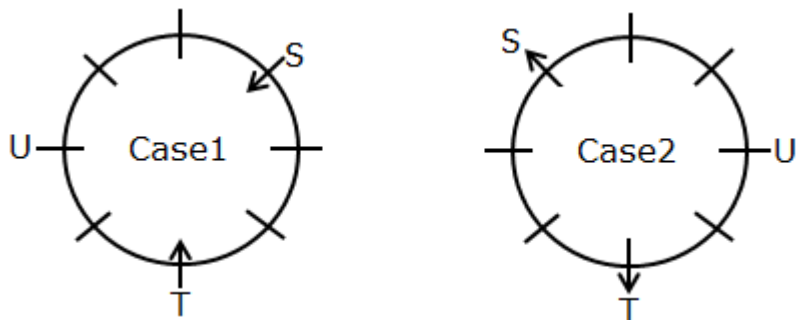

Again we have,

- P sits immediate right of U and opposite to S.
- W and R are facing each other.
- As many persons sit between U and Q as between Q and V, who sits adjacent to R.
- Both V and P face the opposite direction of W, who sits immediate right of Q.
- Q is not facing T.

While applying the above conditions, case 1 gets eliminated. Thus, case 2 gives the final arrangement.

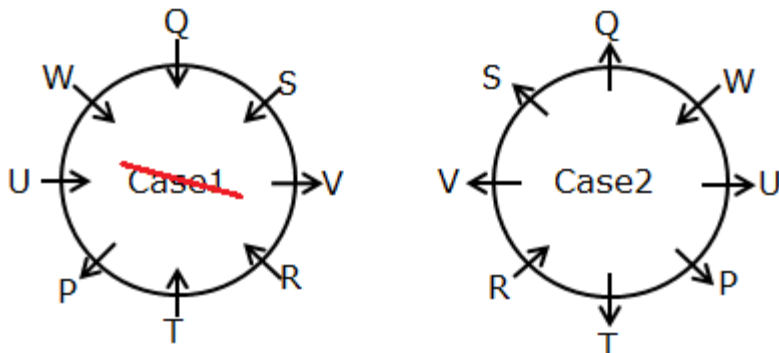

Set 6 (PO Pre)

Directions (26-30): Study the following information carefully and answer the questions given below.

Six persons - C, D, E, F, G and H are sitting around a circular table facing the centre. Each person works in different banks viz. HDFC, AXIS, ICICI, KVB, IOB and UCO.

F sits second to the left of the one who works in HDFC bank. One person sits between the one who works in HDFC and the one who works in UCO bank. The one who works in ICICI bank sits third to the right of G, who works in HDFC bank. E sits second to the right of the one who works in ICICI. D sits second to the right of the one who works in AXIS bank. The one who works in KVB sits adjacent to the one who works in AXIS bank. H sits immediate right of the one who works in IOB bank.

26. How many persons sit between C and the one who works in Axis bank when counted from the left of C?

- a) One
- b) Three
- c) Four
- d) Two
- e) No one

27. Which of the following bank does H work?

- a) IOB
- b) ICICI
- c) KVB
- d) UCO

e) AXIS

**28. What will come in the place of ___?
FE, GD, CF, ____.**

- a) CG
- b) FD
- c) HE
- d) CD
- e) DH

29. If all the persons are made to sit in alphabetical order in a clockwise direction from C, then who among the following person works in IOB bank (Banks remain in the same position)?

- a) F
- b) E
- c) G
- d) H
- e) C

30. Which of the following statement(s) is/are true based on the given information?

- I. Both C and H are immediate neighbours
 - II. D sits immediate right of the one who works in UCO bank
 - III. E works in IOB bank
- a) Only I
 - b) Only III
 - c) Only I and II
 - d) Only II and III
 - e) All I, II and III

[Click Here to Get the Detailed Video Solution for the above given Questions](#)

Or Scan the QR Code to Get the Detailed Video Solutions



Answer Key with Explanation

Directions (26-30):

26. Answer: B

27. Answer: D

28. Answer: E

29. Answer: B

30. Answer: A

Final arrangement

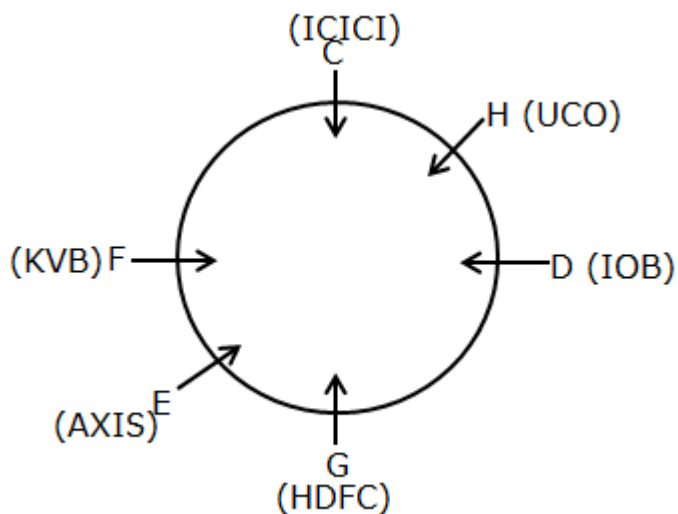

We have,

- F sits second to the left of the one who works in HDFC bank.
- One person sits between the one who works in HDFC and the one who works in UCO bank.

From the above conditions, there are two possibilities

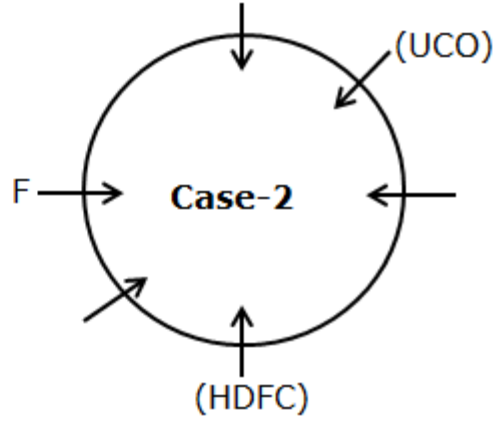
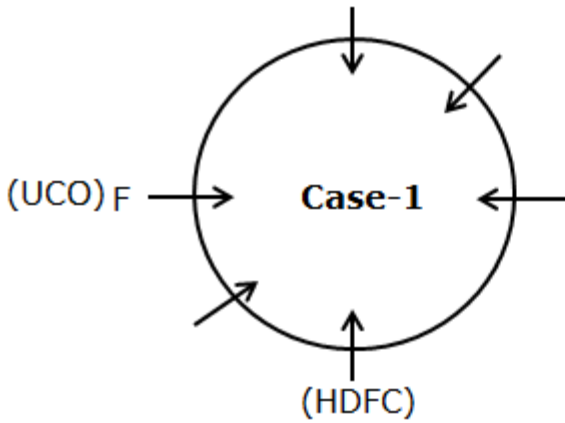

Again we have,

- The one who works in ICICI bank sits third to the right of G, who works in HDFC bank.
- E sits second to the right of the one who works in ICICI.

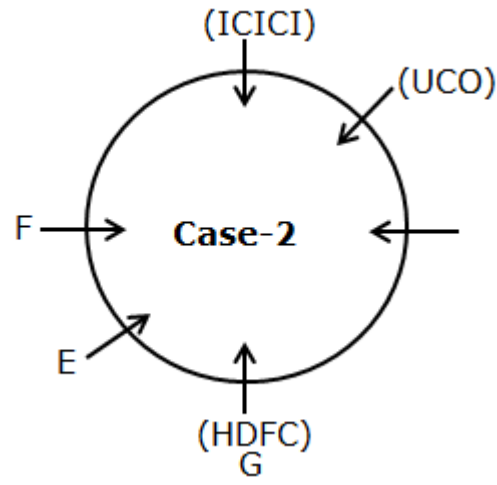
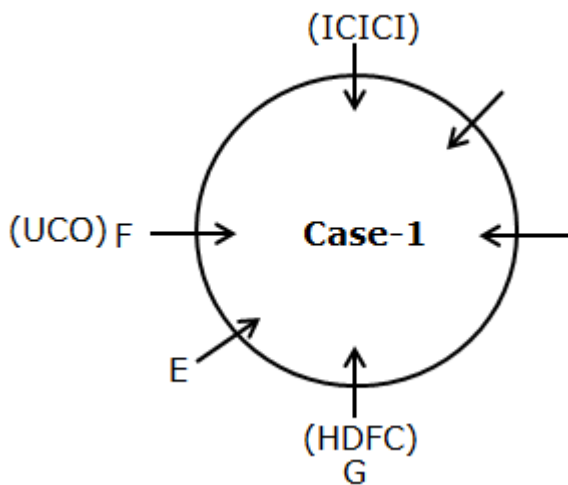

Again we have,

- D sits second to the right of the one who works in AXIS bank.
- The one who works in KVB sits adjacent to the one who works in AXIS bank.
- H sits immediate right of the one who works in IOB bank.

After applying the above conditions case-1 gets eliminated, hence case-2 shows the final arrangement

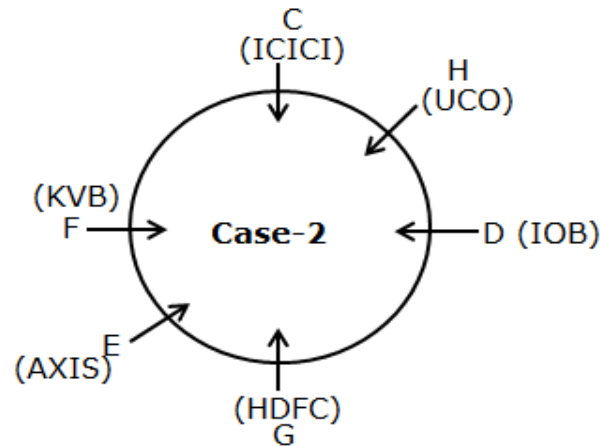
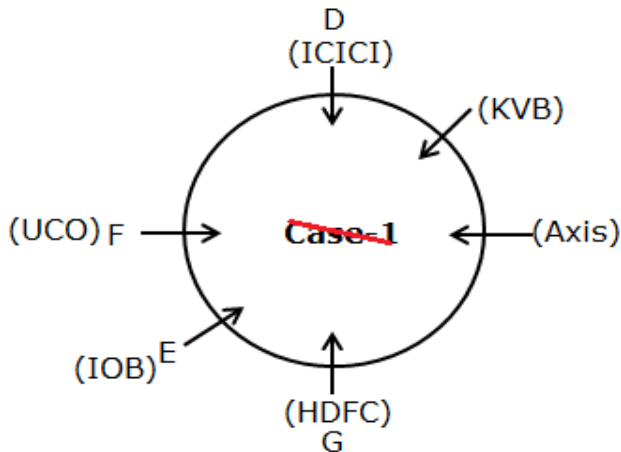

Set 7 (PO Pre)

Directions (31-35): Study the following information carefully and answer the questions given below. Seven persons – F, G, H, I, J, K and L are sitting around a circular table which has eight seats. One of the seats is vacant. All seats are facing towards the centre.

J sits second to the left of L. One person sits between L and H. K sits third to the left of H. F sits second to the right of K. Two persons sit between F and G, who doesn't sit adjacent to J. Both G and I are not immediate neighbours.

31. Who among the following person sits adjacent to the vacant seat?

- F
- H
- I
- G
- L

32. How many persons sit between G and I, when counted from the right of G?

- One
- Two
- Three
- More than three
- No one

33. Which of the following statement(s) is/are true based on the given information?

- H sits second to the left of G
 - G sits immediate right of L
 - Only two persons sit between I and L, when counted from the left of L
- Only III
 - Only I and III
 - Only I and II
 - Only I
 - Only II

34. What is the position of J with respect to F?

- Third to the left
- Second to the right
- Fourth to the left
- Immediate right
- Second to the left

35. Who among the following person sits immediate right of H?

- The one who sits opposite to G
- I
- The one who sits second to the right of F
- Vacant seat
- L

[Click Here to Get the Detailed Video Solution for the above given Questions](#)

Or Scan the QR Code to Get the Detailed Video Solutions



Answer Key with Explanation

Directions (31-35):

31) Answer: E

32) Answer: A

33) Answer: E

34) Answer: B

35) Answer: C

Final arrangement

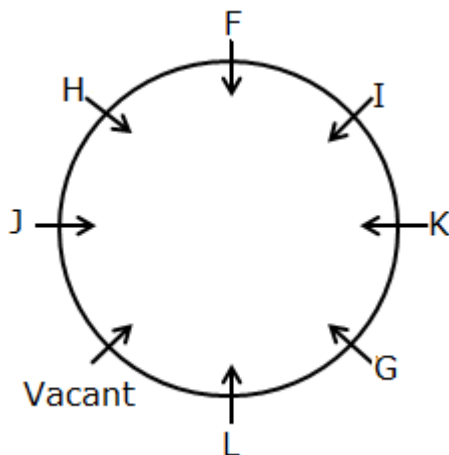

We have,

- J sits second to the left of L.
- One person sits between L and H.
- K sits third to the left of H.

From the above conditions, there are two possibilities

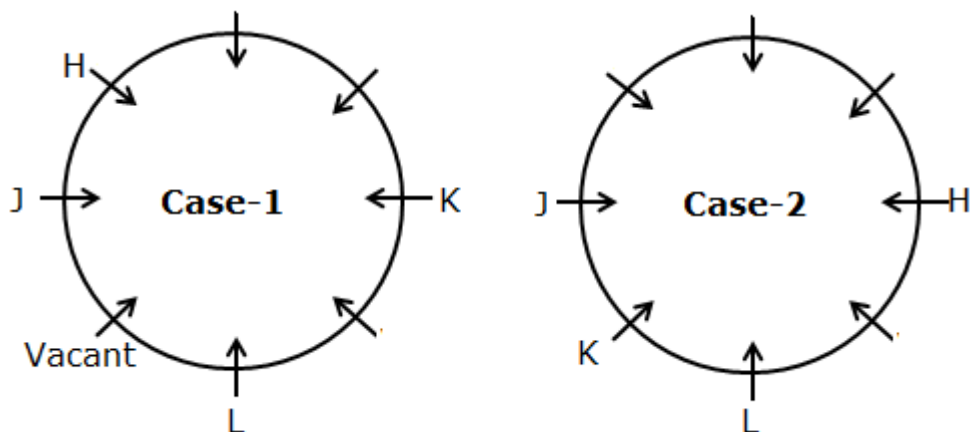

Again, we have

- F sits second to the right of K.
- Two persons sit between F and G, who doesn't sit adjacent to J.
- Both G and I are not immediate neighbours.

After applying the above conditions case-2 gets eliminated because G and I are immediate neighbours, hence case-1 shows the final arrangement.

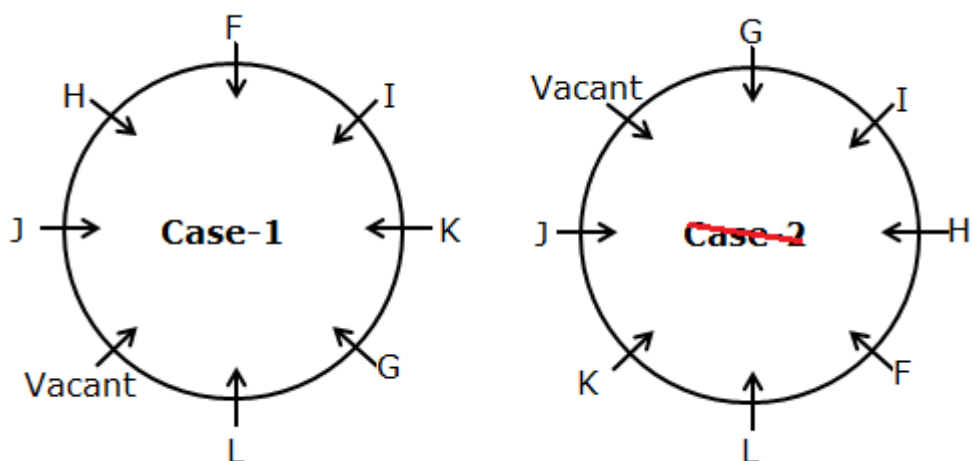

Set 8 (Clerk Mains)

Directions (36-40): Study the following information carefully and answer the questions given below.

Eight persons K, L, M, N, O, P, Q and R are sitting around a circular table facing the centre. Each of them has different brand bags viz. Reebok, Puma, Sky bags, Adidas, Aristocrat, Nike,

Fastrack and Woodland. All the information is not necessarily in the same order.

The one who has Puma bag sits second to the right of L. The one who has Sky bag sits adjacent to L. The one who has woodland bag sits adjacent to the one who has Sky bag. O sits opposite to K. R sits second to the left of O, who sits immediate left of the one who has Puma

bag. The one who has aristocrat bag sits immediate left of R. One person sits between the one who has Aristocrat bag and the one who has fastrack bag. M sits second to the left of the one who has Nike bag. One person sits between the one who has Adidas and Nike bags. Q sits immediate right of the one who has reebok bag. N sits second to the right of P.

36. Who among the following person sits immediate left of the one who has Reebok bag?

- a) The one who sits second to the left of L
- b) The one who sits opposite to P
- c) K
- d) P
- e) The one who sits immediate right of O

37. What is the position of the one who has Adidas bag with respect to P?

- a) Fourth to the right
- b) Immediate right
- c) Third to the right
- d) Immediate left
- e) Second to the left

38. Four of the following five are alike in a certain way as per the given arrangement and

hence form a group. Find the one that doesn't belong to that group.

- a) MP
- b) NQ
- c) LO
- d) KN
- e) RL

39. How many persons sit between the one who has Woodland bag and Q, when counted from the right of Q?

- a) Six
- b) Four
- c) Two
- d) None
- e) Five

40. Which of the following statement(s) is/are true with respect to the final arrangement?

- a) Two persons sit between M and K, when counted from the left of K
- b) P has Aristocrat bag
- c) O sits second to the right of the one who has Sky bags
- d) The one who has Nike bag sits opposite to N
- e) All the statements are true

[Click Here to Get the Detailed Video Solution for the above given Questions](#)

Or Scan the QR Code to Get the Detailed Video Solutions



Answer Key with Explanation

Directions (36-40):

36. Answer: B

37. Answer: D

38. Answer: B (First person sits immediate left of the second person for all pairs except for option b)

39. Answer: E

40. Answer: C

Final arrangement

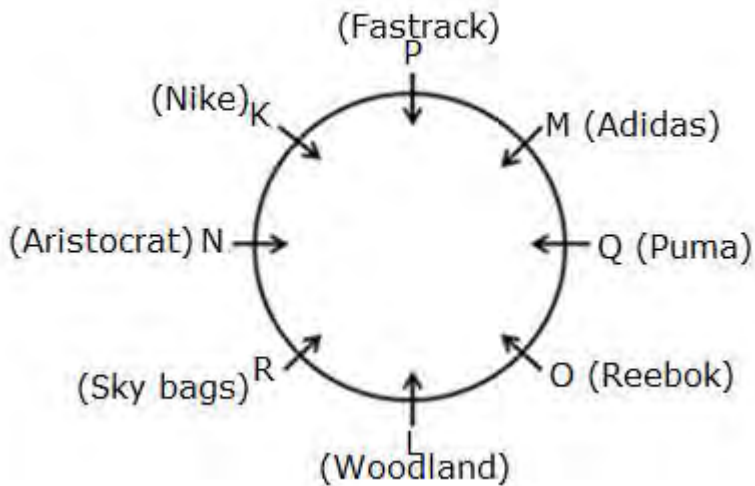

We have,

- The one who has Puma bag sits second to the right of L.
- The one who has Sky bag sits adjacent to L.
- The one who has woodland bag sits adjacent to the one who has Sky bag.

From the above conditions, there are three possibilities

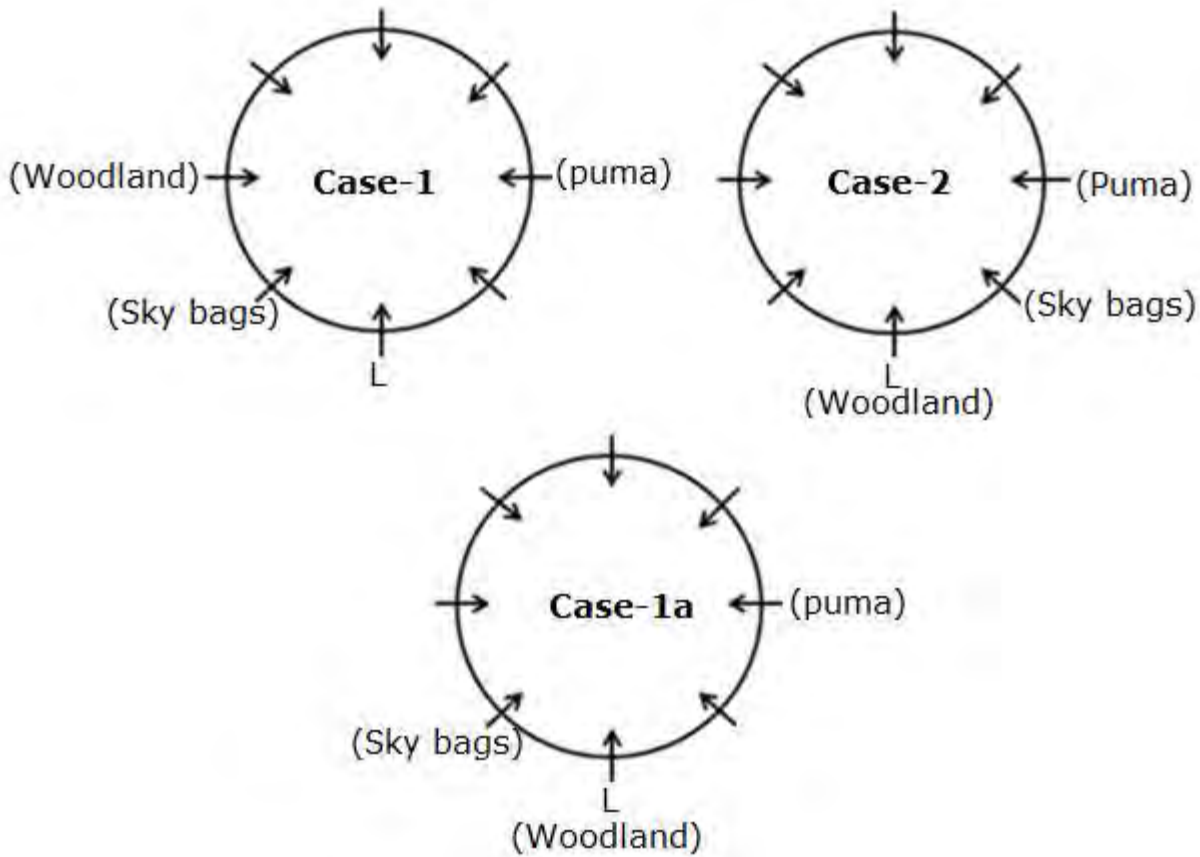

Again we have,

- O sits opposite to K.
- R sits second to the left of O who sits immediate left of the one who has Puma bag.
- The one who has aristocrat bag sits immediate left of R.
- One person sits between the one who has Aristocrat bag and the one who has fastrack bag.

After applying the above conditions, case-1 gets eliminated

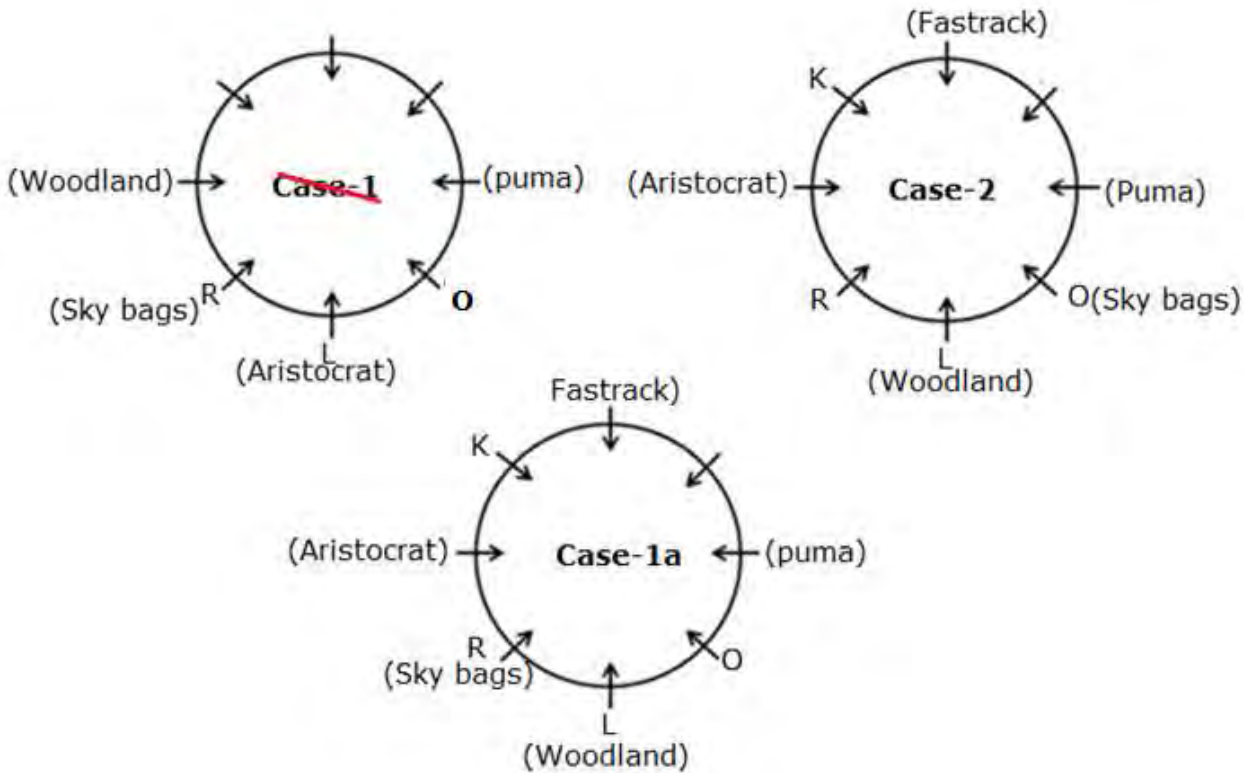

Again we have,

- M sits second to the left of the one who has Nike bag.
- One person sits between the one who has Adidas and Nike bags.
- Q sits immediate right of the one who has reebok bag.
- N sits second to the right of P.

After applying the above conditions, case-2 gets eliminated, hence case-1a shows the final arrangement

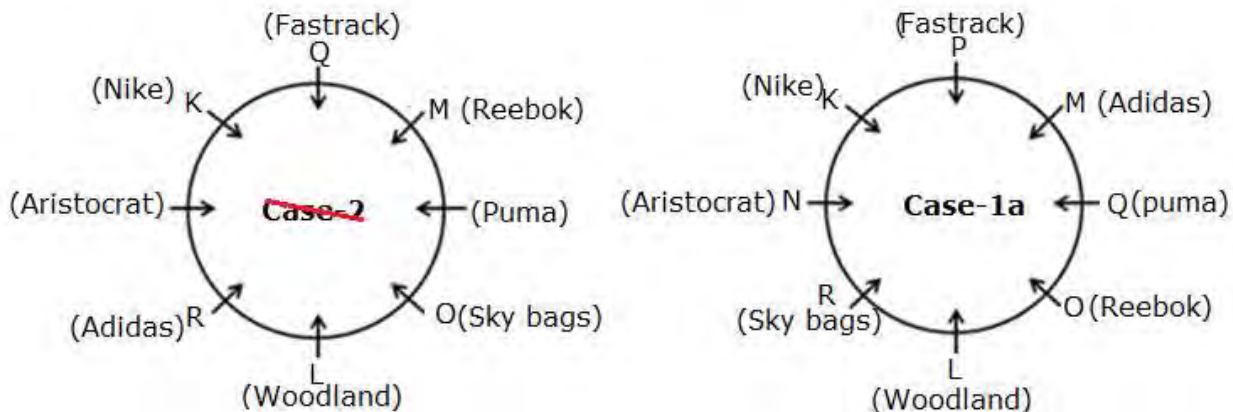

Set 9 (Clerk Mains)

Directions (41-45): Study the following information carefully and answer the questions given below.

Eight persons- E, F, G, H, I, J, K and L are sitting around a circular table facing away from the center. Each of them has a different lucky number viz. 12, 15, 25, 28, 29, 32, 46 and 53. All the information is not necessarily in the same order.

Note: Lucky numbers of the persons sitting adjacent to each other have neither common factors nor common multiple.

G's lucky number is a multiple of 5 and sits third to the right of F. One person sits between G and one of the persons whose lucky number is a prime number. L sits third to the right of the one whose lucky number is 28 and sits adjacent to F. L's lucky number is 10 more than G's lucky number. As many persons sit between F and the one whose lucky number is 28 as between K and the one whose lucky number is 12, when counted from the left of both F and K. J's lucky number is 7 more than K's lucky number. I sits third to the right of the one whose lucky number is 32. Two persons sit between H and the one whose lucky number is 29.

41. Who among the following person sits second to the right of the one whose lucky number is 12?

- a) The one whose lucky number is 53
- b) H
- c) The one who sits immediate left of G
- d) J
- e) The one who sits immediate right of E

42. Which of the following statement(s) is/are true?

I. The one whose lucky number is 15 sits third to the right of E

II. Two persons sit between L and the one whose lucky number is 53

III. The sum of lucky numbers of I and L is 54

- a) Only II
- b) Only III
- c) Only I and II
- d) Only II and III
- e) All I, II and III

43. Four of the following five are alike in a certain way based on the given arrangement and thus form a group. Which one of the following doesn't belong to the group?

- a) F-32
- b) L-53
- c) K-28
- d) I-15
- e) G-12

44. Who among the following person sits immediate left of L?

- a) The one whose lucky number is 15
- b) E
- c) The one whose lucky number is 32
- d) The one whose lucky number is 12
- e) K

45. How many persons sit between F and the one whose lucky number is 29, when counted from the right of F?

- a) As many persons sit between I and G
- b) Two
- c) As many persons sit between H and L
- d) Six
- e) No one

[Click Here to Get the Detailed Video Solution for the above given Questions](#)

Or Scan the QR Code to Get the Detailed Video Solutions



Answer Key with Explanation

Directions (41-45):

41. Answer: C

42. Answer: B

43. Answer: E(All pairs of person and lucky number are opposite to each other,except option e)

44. Answer: D

45. Answer: D

Final arrangement

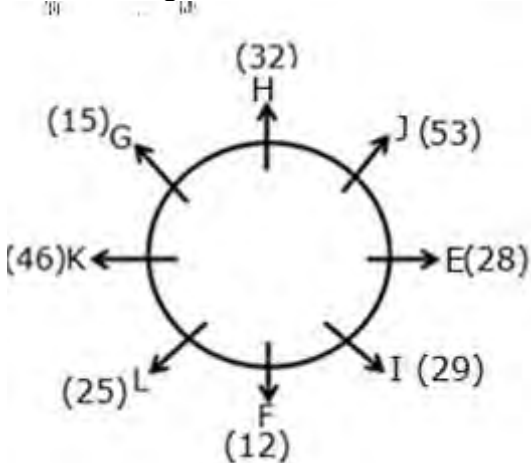

We have,

- G's lucky number is a multiple of 5 and sits third to the right of F.
- One person sits between G and the one whose lucky number is a prime number.

From the above conditions, there are two possibilities

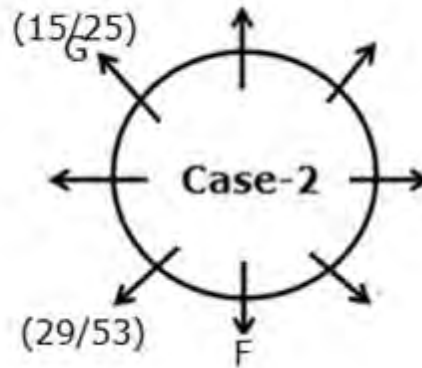
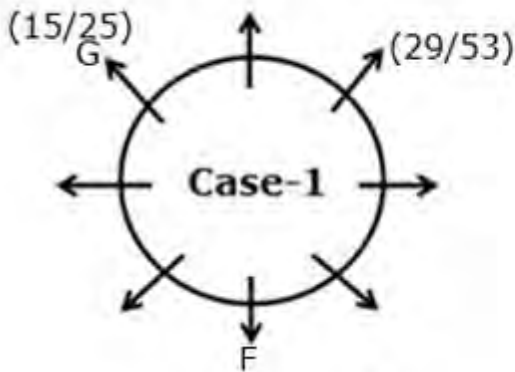

Again we have,

- L sits third to the right of the one whose lucky number is 28 and sits adjacent to F.
- L's lucky number is 10 more than G's lucky number.
- As many persons sit between F and the one whose lucky number is 28 as between K and the one whose lucky number is 12, when counted from the left of both F and K.
- J's lucky number is 7 more than K's lucky number.

In (Case1) 12 is a multiple of 2 and 3 so the one whose lucky number is 15 and 28 doesn't sit adjacent to the one whose lucky number is 12. In (Case2 and 3), the one whose lucky number is 12 doesn't sit adjacent to G and J's lucky number is 53 and K's lucky number is 46.

Here the one whose lucky number is 32 doesn't sit adjacent to F, so the one whose lucky number is 32 sits adjacent to G in (Case-1). In (case2) both 12 and 32 are multiple of 2 so both of them do not sit adjacent to each other. In (Case3) both 46 and 32 are multiple of 2 so both of them do not sit adjacent to each other.

From the above conditions, there are three possibilities

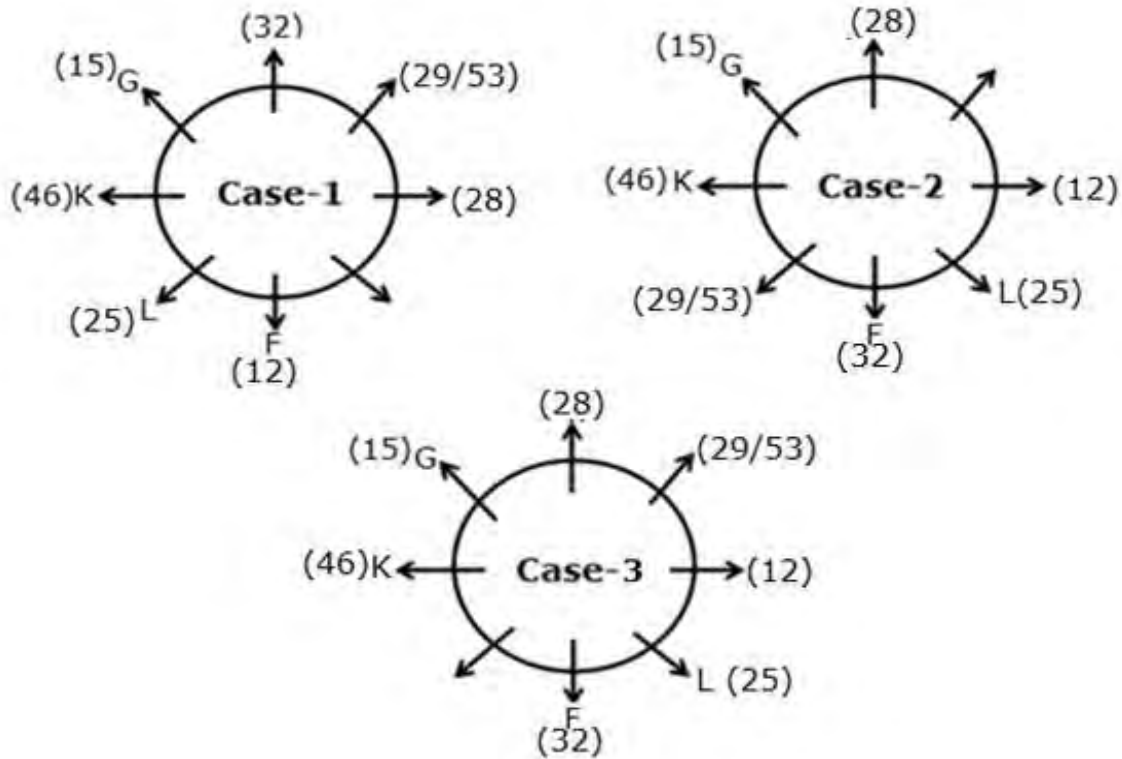

Again we have,

- I sit third to the right of the one whose lucky number is 32.
- Two persons sit between H and the one whose lucky number is 29.

From Here J's lucky number is 53 then I's lucky number is 29.

After applying the above conditions, Cases 2 and 3 get eliminated, hence Case-1 shows the final arrangement

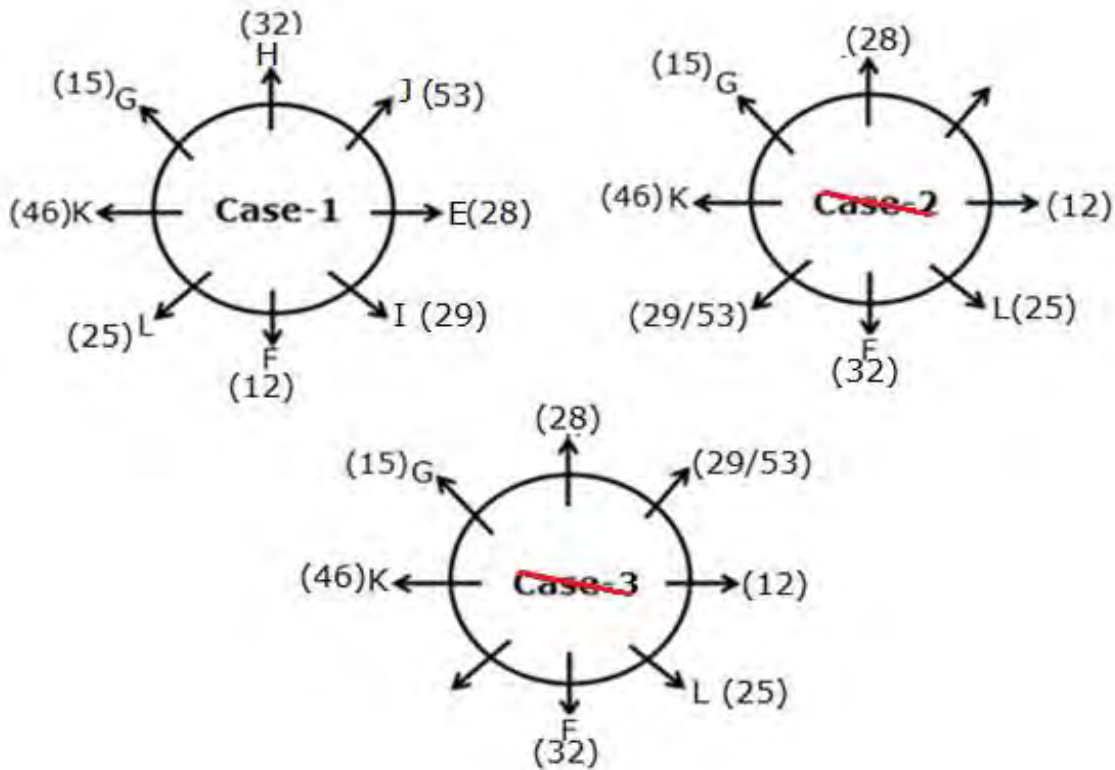

Set 10 (Clerk Mains)

Directions (46-50): Study the following information carefully and answer the below questions

Six persons- P, Q, R, S, T, and U, in which three are married couples are sitting around a circular table facing the centre but not necessarily in the same order. They are of different ages. The couples are not sitting together. In couples, the husband's age is more than the wife's age.

U sits second to the left of the one whose age is 34. U and the spouse of Q are sitting adjacent to each other. Q sits immediate right of the one who sits opposite to the person whose age is 45. Q does not sit adjacent to U. P sits immediate right of the one who is the husband of U. P is not the spouse of Q. S, who is a male, sits opposite to the one whose age is 25. The age of T is three years more than S's spouse. Neither S nor R is the spouse of Q. U's spouse

age is five years more than the one who sits immediate right of T. The age difference between S and Q is one year less than the age difference between R and Q. The age of Q is less than the age of P's spouse.

46) What is the age of the one who sits second to the right of P's spouse?

- a) 30
- b) 45
- c) 25
- d) 34
- e) None of the above

47) How many persons are sitting between Q's spouse and S's spouse, when counted from the right of Q's spouse?

- a) Two
- b) One
- c) None

- d) Three
- e) Four

48) What is the sum of the age of S, T, and R?

- a) 92
- b) 97
- c) 96
- d) 83
- e) 86

49) Who among the following person sits immediate right of S?

- a) T

- b) The one whose age is 25
- c) The one whose age is 28
- d) The one who sits second to the right of T's spouse
- e) The one who sits immediate left of Q

50) Who among the following pairs are couples?

- a) SQ
- b) TP
- c) UP
- d) PR
- e) None of the above

[Click Here to Get the Detailed Video Solution for the above given Questions](#)

Or Scan the QR Code to Get the Detailed Video Solutions



Answer Key with Explanation

Directions (46-50):

46) Answer: A

47) Answer: C

48) Answer: B

49) Answer: D

50) Answer: D

Final Arrangement

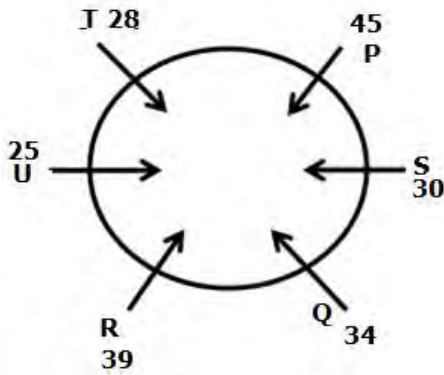

$S(+)$ \equiv $U(-)$

$Q(+)$ \equiv $T(-)$

$P(+)$ \equiv $R(-)$

We have,

- U sits second to the left of the one whose age is 34.
- U and the spouse of Q are sitting adjacent to each other.

From the above condition, there are two possibilities.

Q's spouse

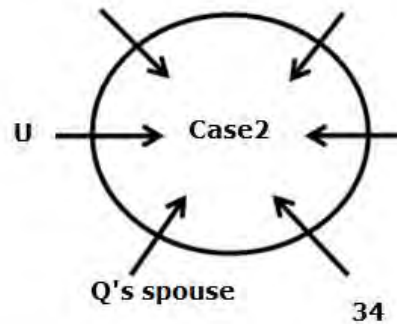
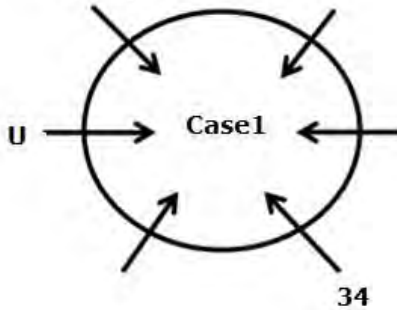

Again we have,

- Q sits immediate right of the one who sits opposite to the person whose age is 45.
- Q doesn't sit adjacent to U.

From the above condition, there are four possibilities.

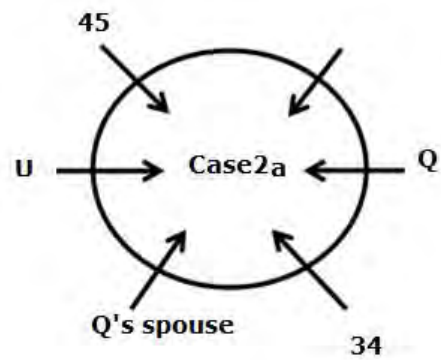
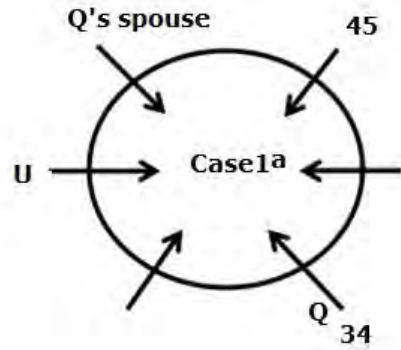
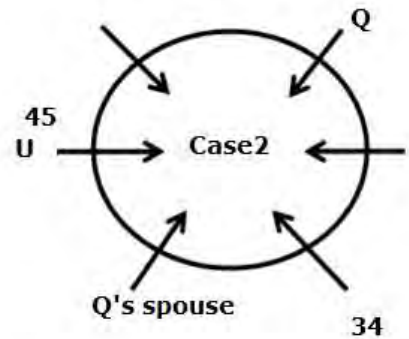
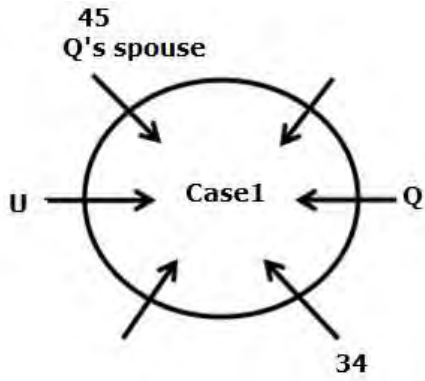

Again we have,

- P sits immediate right of the one who is the husband of U. P is not the spouse of Q.
- In couples, the husband's age is more than the wife's age

From the above condition and note, case1 and case2 get eliminated.

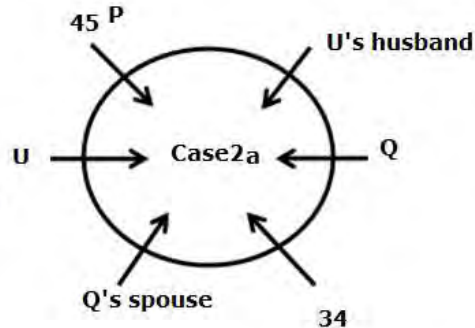
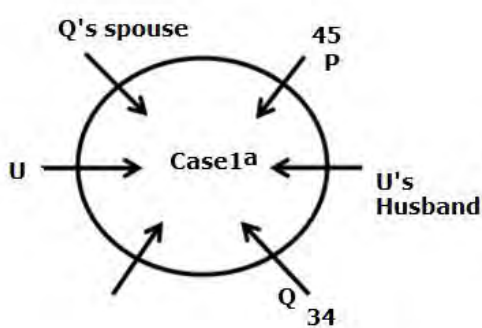
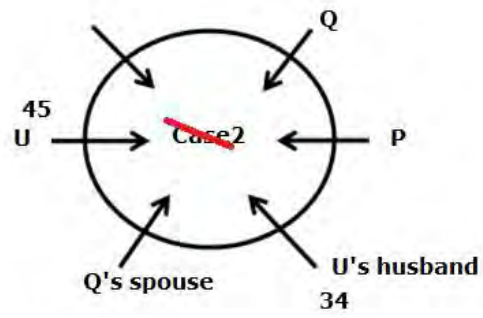
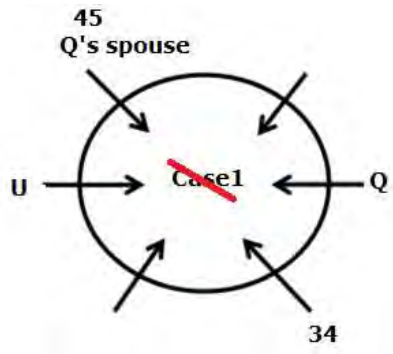

Again we have,

- S is the male who sits opposite to the one whose age is 25.
- The age of T is three years more than S's spouse.
- Neither S nor R is the spouse of Q.
- U's spouse's age is five years more than the one who sits immediate right of T.

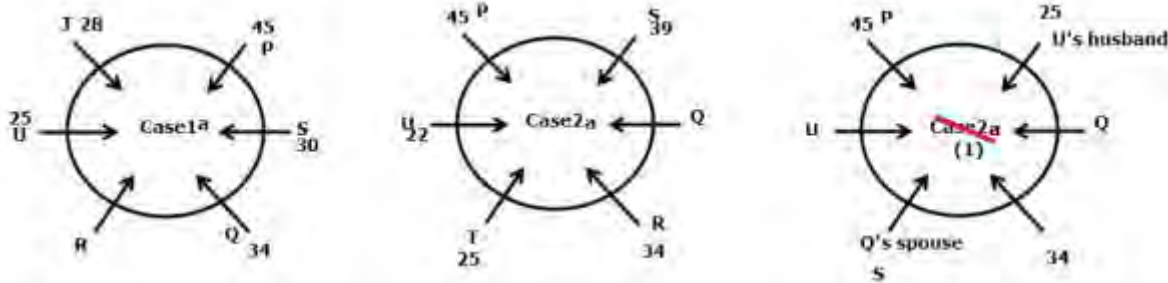

$S(+)=U(-)$

$P=R$

$T=Q$

Again we have,

- The age difference between S and Q is one year less than the age difference between R and Q.
- The age of Q is less than the age of P's spouse.

From the above condition, case2a gets eliminated. case1a shows the final arrangement.

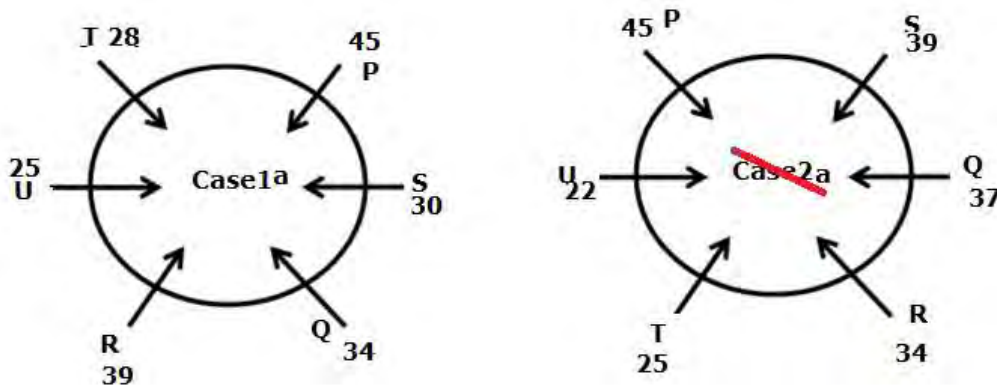

$S(+)=U(-)$

$Q(+)=T(-)$

$P(+)=R(-)$

Set 11 (PO Mains)

Directions (51-55): Study the following information carefully and answer the questions given below

Eight people are sitting around a circular table and reading different types of newspapers viz., Times of India (TOI), Hindustan, Indian Express, The Statesman, The telegraph, The Hindu, Deccan chronicle and The Asian age. Some of them are facing towards the center and some are facing away from the center. Not more than two persons facing the same direction are sitting together.

Neither N nor L reads Hindustan. I sit second to the right of the one who reads The Statesman and both face opposite directions. The one who reads the Statesman is not sitting adjacent to the one who reads Hindustan. Two people sit between K, who doesn't read The Asian age and I, who is not sitting opposite to O. The one who reads The Hindu sits second to the left of K and sits opposite to the one who reads Hindustan. As many people sit between the one who reads Hindustan and Deccan chronicle as between the one who reads Deccan chronicle and N. The one who reads Indian Express sits third to the left of N. The one who reads The Asian age and Indian Express are sitting together. Two people sit between the one who reads TOI and M, who sits second to the right of L. J sits opposite to the one who reads the telegraph, who faces towards the center. M and P face opposite directions of O. The one who reads Deccan chronicle is not sitting immediate right of P.

51. Who among the following person reads the Asian age newspaper?

- a) The one who sits third to the left of the one who reads TOI.
- b) The one who sits opposite the one who reads Deccan chronicle
- c) O
- d) The one who sits immediate right of N

e) K

52. Which of the following statement is/are not true with respect to the final arrangement?

- a) Only two people sit between N and the one who reads the telegraph, when counted from the left of N
- b) M reads Hindustan and faces towards the center
- c) The one who reads Indian express faces J
- d) All the given statements are false
- e) All the given statements are true

53. Which of the following combination is true?

- a) K-Statesman
- b) N-Hindustan
- c) I-Deccan chronicle
- d) L-TOI
- e) O-Telegraph

54. Four of the following five are alike in a certain way based on the given arrangement and thus form a group. Which one of the following does not belong to the group?

- a) MP
- b) LO
- c) KI
- d) PL
- e) JK

55. Who among the following person sits second to the left of the one who reads Deccan chronicle?

- a) The one who faces the one who reads The Hindu
- b) The one who sits immediate right of J
- c) I
- d) The one who sits third to the right of the one who reads Indian Express
- e) Both a and d

[Click Here to Get the Detailed Video Solution for the above given Questions](#)

Or Scan the QR Code to Get the Detailed Video Solutions



Answer Key with Explanation

Directions (51-55):

51. Answer: B

52. Answer: D

53. Answer: E

54. Answer: E (In the given options, the second person sits third to the right of first person, except in option e)

55. Answer: D

Final arrangement:

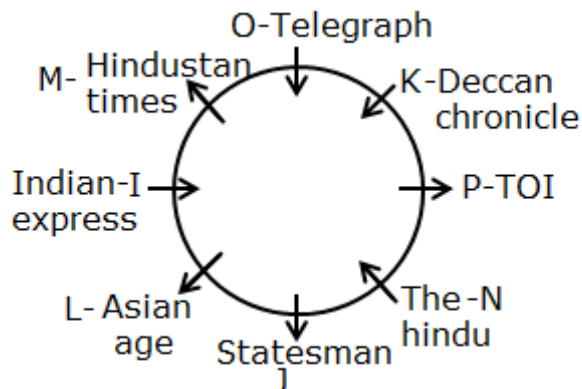

We have,

- Neither N nor L reads Hindustan.
- I sit second to the right of the one who reads The Statesman and both faces opposite directions.
- The one who reads the statesman is not sitting adjacent to the one who reads Hindustan.
- Two people sit between K, who doesn't read The Asian age and I, who is not sitting opposite to O.
- The one who reads The Hindu sits second to the left of K and sits opposite to the one who reads Hindustan.

From above conditions, we have four possibilities:

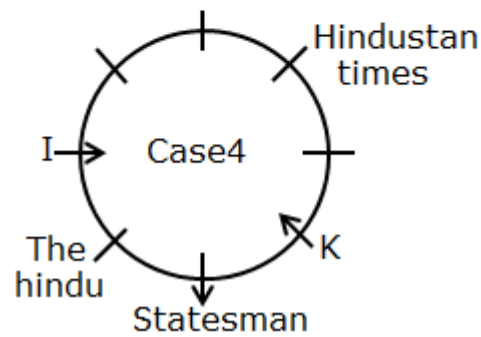
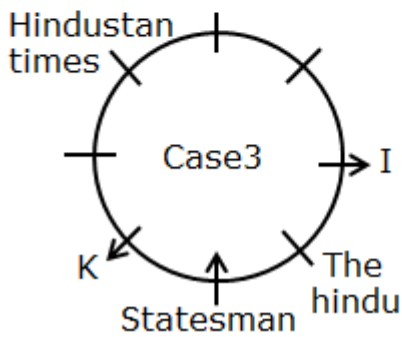
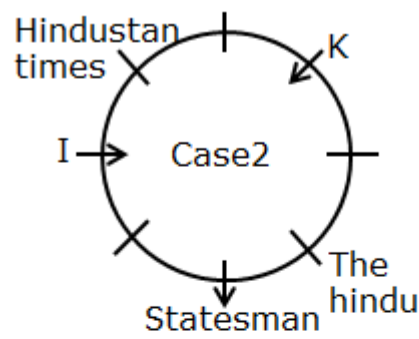
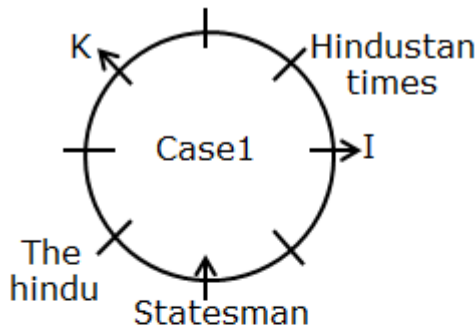

Again we have,

- As many people sit between the one who reads Hindustan and Deccan chronicle as between the one who reads Deccan chronicle and N.
- The one who reads Indian Express sits third to the left of N.
- The one who reads The Asian age and Indian Express sit together.

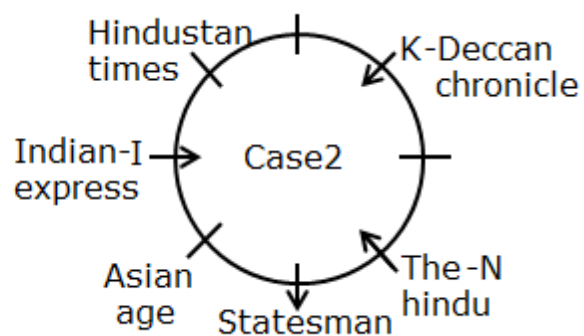
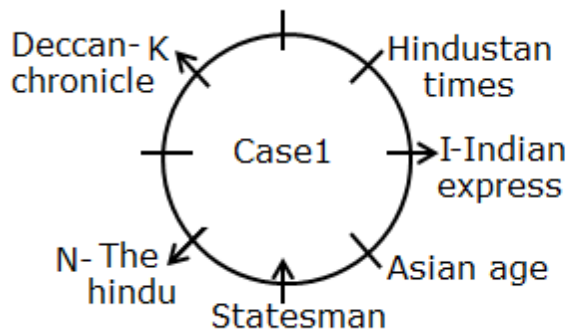

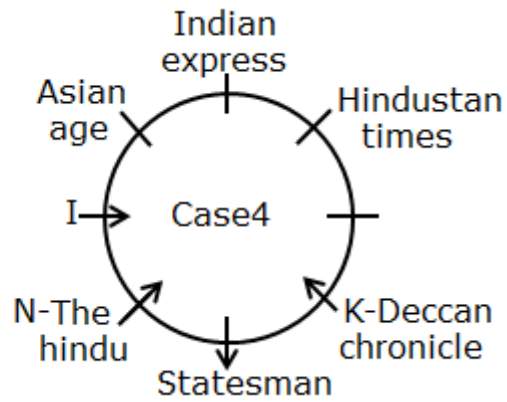
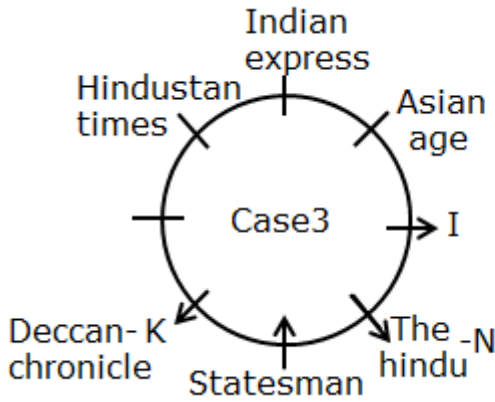

Again we have,

- Two people sit between the one who reads TOI and M, who sits second to the right of L.
- J sits opposite to the one who reads the telegraph, who faces towards the center.
- M and P face opposite directions of O.
- The one who reads Deccan chronicle is not sitting immediate right of P.

While applying the above conditions, case 1, 3 and 4 get eliminated. Thus, case 2 gives the final arrangement.

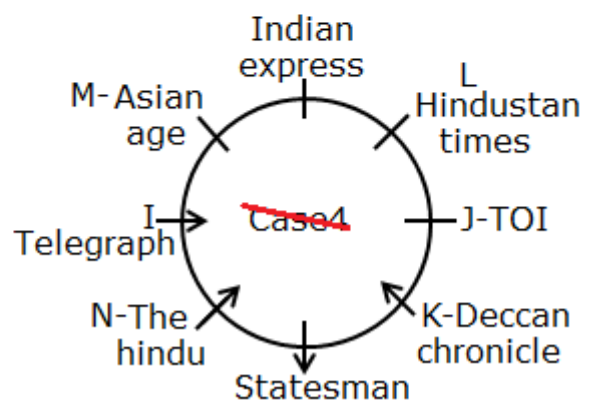
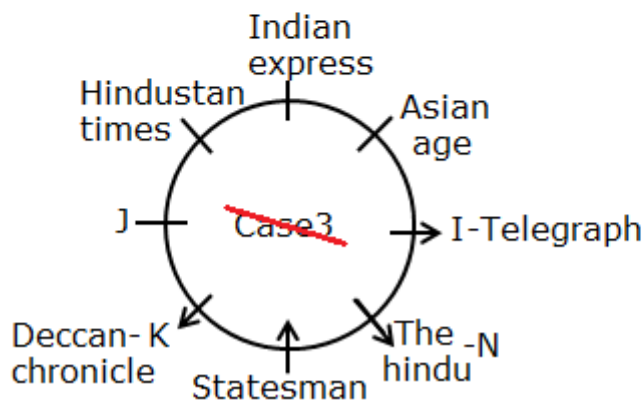
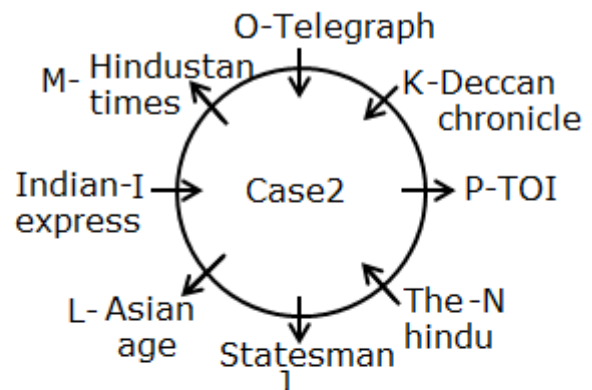
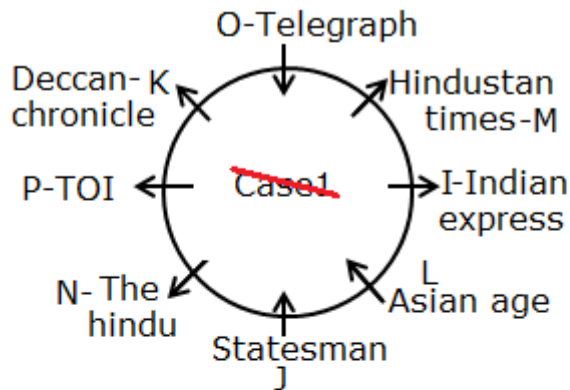

Set 12 (Clerk Mains)

Directions (56-60): Study the following information carefully and answer the below questions. Certain number of persons are sitting around a circular table of diameter 273cm. All the persons are facing outside the table. The distance between the adjacent persons is different and is a consecutive multiple of eleven in a clockwise direction. The minimum distance between each person is 11cm. The number of persons sitting around the table is divisible by six also not exceeding fifteen.

A sits 165cm to the left of G. The number of persons sitting between A and G is a prime number. D sits third to the left of B. One person sits between D and E. As many persons sit between B and E, when counted from the left of B as between G and D, when counted from the right of G. The distance between E and D is same as the distance between F and C, when counted from the right of both D and C. Neither F nor C is sitting adjacent to E.

56) Who among the following sits third to the left of A?

- a) G
- b) The one who sits to the immediate left of F
- c) B
- d) The one who sits sixth to the right of D
- e) None of these

57) What is the distance between G and E, when measuring from the right of G?

- a) 165cm
- b) 143cm
- c) 121cm
- d) 132cm
- e) None of these

58) Which of the following statements is/are true with respect to the final arrangement?

- a) A sits second to the right of F
- b) B sits third to the right of G
- c) E sits adjacent to A
- d) All are true
- e) None of these

59) If Z sits fourth to the right of B, then what is the distance between Z and C, when measuring from the left of Z?

- a) 210cm
- b) 280cm
- c) 297cm
- d) 209cm
- e) None of these

60) How many persons are sitting at the table?

- a) Eleven
- b) Fourteen
- c) Twelve
- d) Thirteen
- e) None of these

[Click Here to Get the Detailed Video Solution for the above given Questions](#)

Or Scan the QR Code to Get the Detailed Video Solutions



Answer Key with Explanation

Directions (56-60):

56. Answer: B

57. Answer: D

58. Answer: A

59. Answer: D

60. Answer: C

Final arrangement:

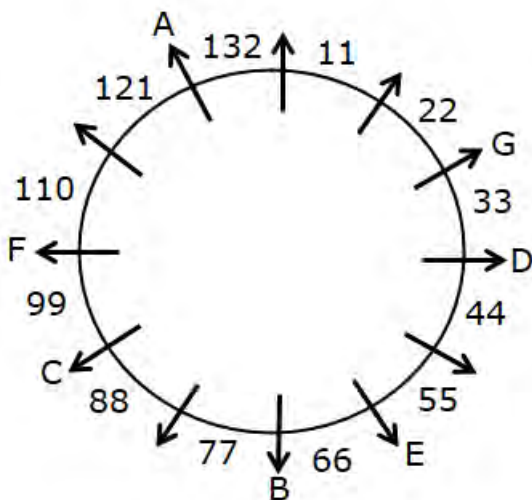

We have,

Since, diameter of the table = 273cm.

Thus, circumference = $2 \times \frac{22}{7} \times \frac{273}{2} = 858\text{cm}$.

- A sits 165cm to the left of G.
- The number of persons sitting between A and G is a prime number.

From the above conditions, there are two possibilities

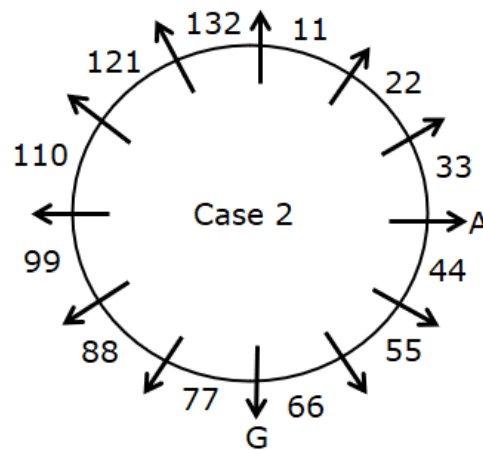
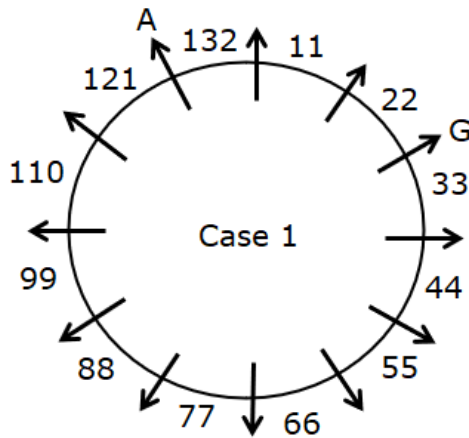

Again we have,

- D sits third to the left of B.
- One person sits between D and E.
- As many persons sit between B and E when counted from the left of B as between G and D when counted from the right of G.

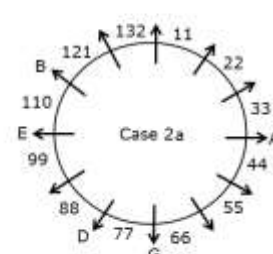
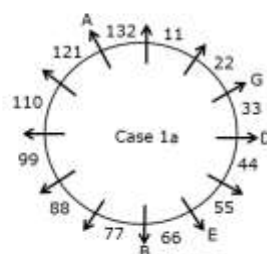
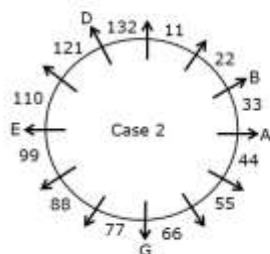
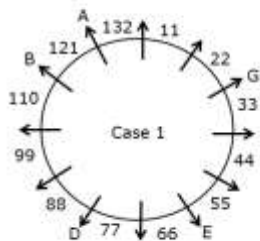

Again we have,

- The distance between E and D is same as the distance between F and C when counted from the right of both D and C.
- Neither F nor C is sitting adjacent to E.

So Case 1, Case 2 and Case 2a get eliminated, hence Case 1a shows the final arrangement.



Set 13 (PO Mains)

Directions (61-65): Study the following information carefully and answer the below questions Twelve persons N, O, P, Q, R, S, T, U, V, W, X and Y are sitting around two circles such that one circle is inscribed in another circle but not necessarily in the same order. The persons are sitting in the inner circle facing outside and the persons are sitting in the outer circle facing inside.

Note: If it is given that, A sits opposite to B then both A and B are sitting in the same circle i.e. either in the inner circle or in the outer circle.

N sits second to the left of the one who faces P. Q sits third to the right of N. O faces the one who is the immediate neighbour of Q. T sits opposite to O. The number of persons sitting between T and O is one less than the number of persons sitting between S and U when counted from the left of S. U does not sit in the same circle where P is sitting. V faces one of the immediate neighbours of S but not N. W faces the one who sits immediate left of X, who does not sit in the inner circle. Y is facing R who sits opposite to P. R does not sit adjacent to W.

61. Who among the following person faces the one who sits fourth to the right of V?

- a) N
- b) The one who sits immediate right of W
- c) Q
- d) The one who sits third to the left of S
- e) None of these

62. Four of the following five are alike in a certain way and hence form a group as per the

given arrangement. Which of the following one does not belong to the group?

- a) OY
- b) NT
- c) PQ
- d) XR
- e) WV

63. Who among the following person does not sit in the outer circle?

- a) R
- b) V
- c) U
- d) T
- e) P

64. If N is related to X and V is related to Q in a certain way, then who among the following is related to P?

- a) The one who sits second to the right of U
- b) O
- c) The one who sits immediate left of X
- d) Y
- e) The one who sits fifth to the right of Q

65. Which of the following statement is true as per the final arrangement?

- a) Only three persons sit between X and O when counted from the left of O
- b) W faces the one who sits immediate left of P
- c) U and V are facing each other
- d) S and Y sit in the different circle
- e) None is true

[Click Here to Get the Detailed Video Solution for the above given Questions](#)

Or Scan the QR Code to Get the Detailed Video Solutions



Answer Key with Explanation

Directions (61-65):

- 61) Answer: D
- 62) Answer: D (X and R sit in the same circle)
- 63) Answer: C
- 64) Answer: E
- 65) Answer: E

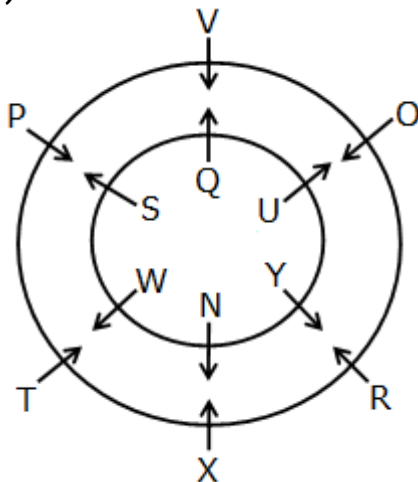

We have,

- N sits second to the left of the one who faces P.
- Q sits third to the right of N.
- O faces the one who is the immediate neighbour of Q.

From the above conditions there are two possibilities.

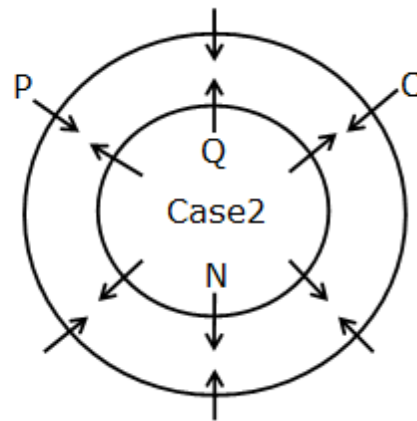
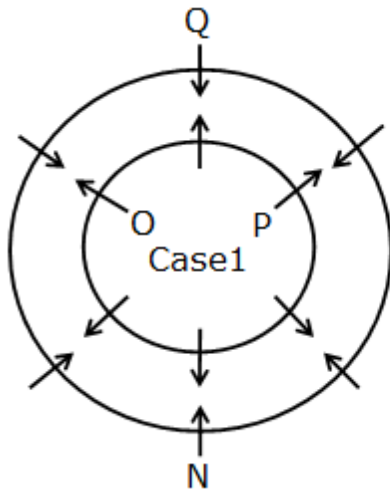

Again we have,

- T sits opposite to O.
- The number of persons sits between T and O is one less than the number of persons sits between S and U when counted from the left of S.
- U does not sit in the same circle where P is sitting.

From the above conditions Case1a and Case2a is formed.

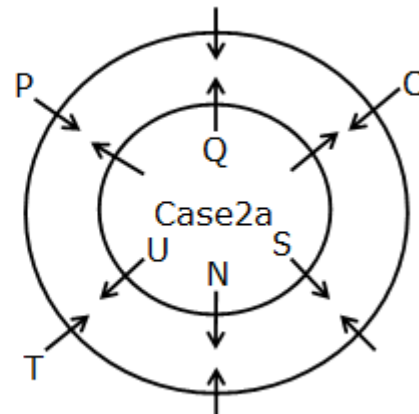
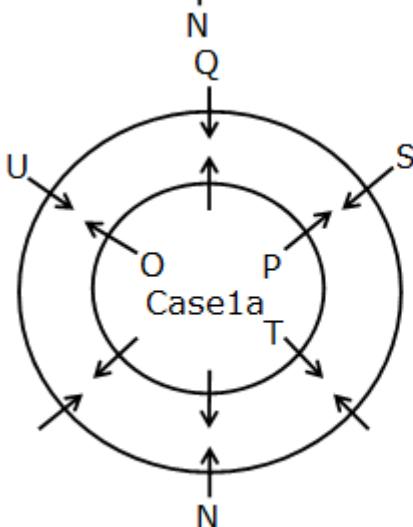
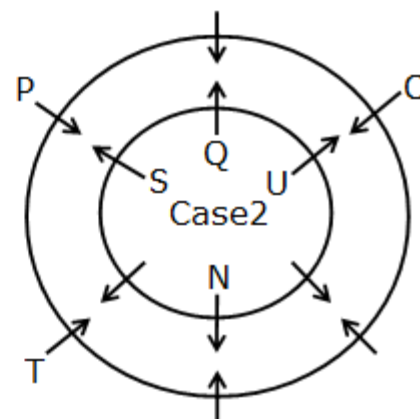
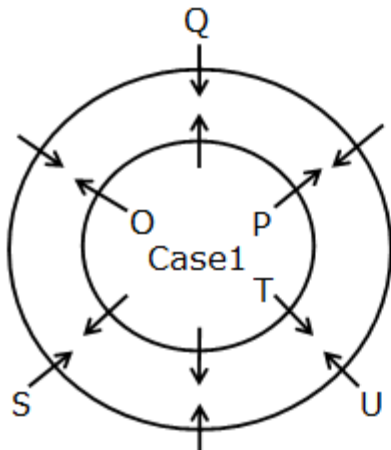

Again we have,

- V faces one of the immediate neighbours of S but not N.
- W faces the one who sits immediate left of X who does not sit in the inner circle.
- Y is facing R who sits opposite to P.
- R does not sit adjacent to W.

From the above conditions Case1, Case1a and Case2a get eliminated. Hence Case2 shows the final arrangement.

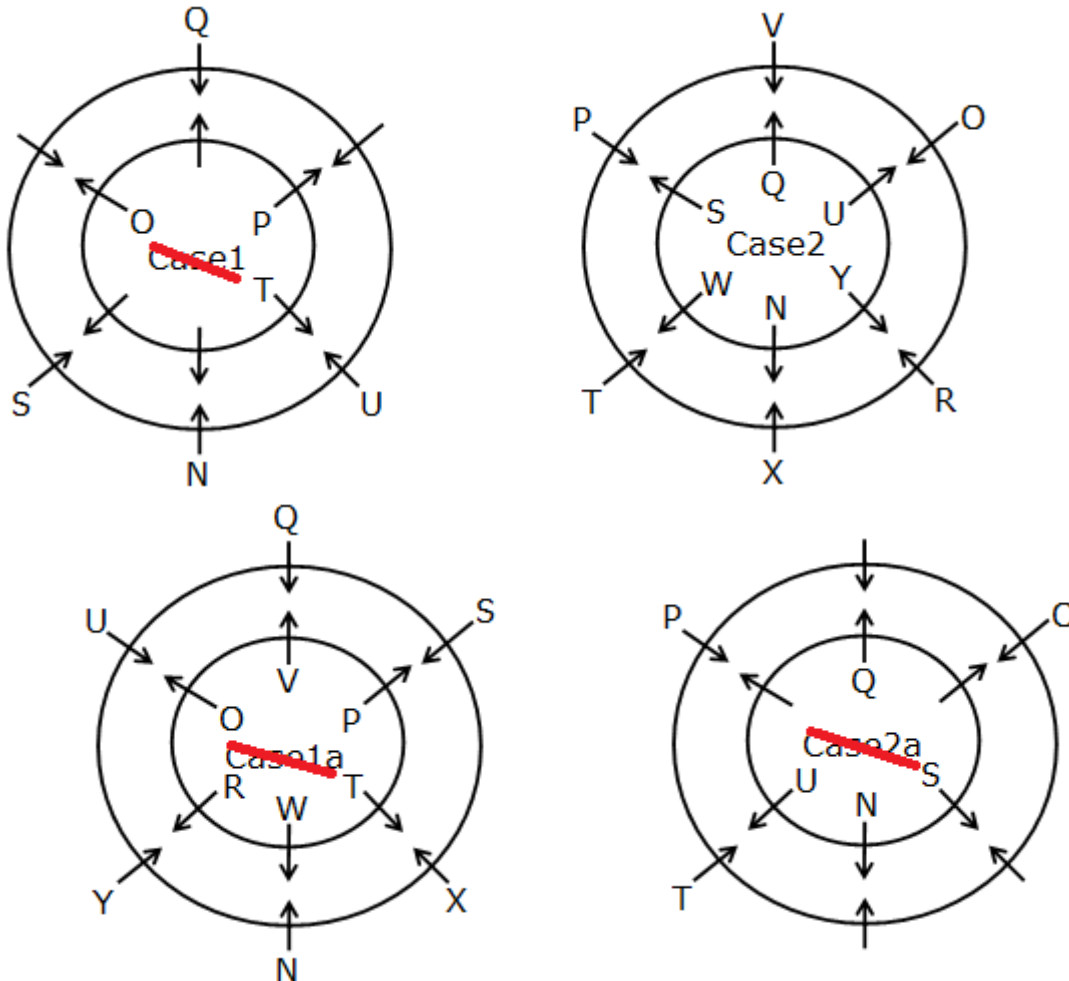

Set 14 (PO Mains)

Directions (66-70): Study the following information carefully and answer the questions given below. Fourteen persons – A, B, C, D, E, F, G, T, U, V, W, X, Y and Z are sitting around the two circular tables viz. T1 and T2, where the persons sitting in T1 are facing towards the center and the persons sitting in T2 are facing

away from the center, but not necessarily in the same order. Seven persons sit at each circular table.

Note: The consecutive alphabetically named persons and the complementary paired persons are not sitting together.

D sits second to the left of G. A sits third to the right of T. One person sits between T and F, who is not sitting adjacent to A. As many persons sit between D and U as between U and W. Z sits second to the left of V. Two persons sit between E and X, who sits at the same table as G. Y faces away from the center. The number of persons sitting between U and B is one less than the number of persons sitting between T and C, when counted from the right of both U and T.

66. Which of the following pair of persons are sitting at the same table?

- a) U-T
- b) C-W
- c) Z-A
- d) B-V
- e) X-Y

67. In which of the following option, the second person sits second to the left of the first person and immediate right of the third person?

- a) GDU
- b) WEU
- c) VZT
- d) ZYA
- e) TFC

68. Who among the following person sits third to the left of the one who sits immediate right of G?

- a) The one who sits immediate left of B
- b) E
- c) The one who sits third to the right of E
- d) X
- e) The one who sits second to the right of X

69. Four of the following five are alike in a certain way based on the given arrangement and thus form a group. Which one of the following doesn't belong to that group?

- a) VZ
- b) FA
- c) EG
- d) DU
- e) CY

70. How many persons sit between Y and T, when counted from the left of T?

- a) As many persons sit between V and C
- b) Two
- c) Four
- d) As many persons sit between A and F
- e) Both b and d

[Click Here to Get the Detailed Video Solution for the above given Questions](#)

Or Scan the QR Code to Get the Detailed Video Solutions



Answer Key with Explanation

Directions (66-70):

66. Answer: C

67. Answer: D

68. Answer: C

69. Answer: E (In all the given options, the second person sits second to the left of the first person, except option e)

70. Answer: B

Final arrangement:

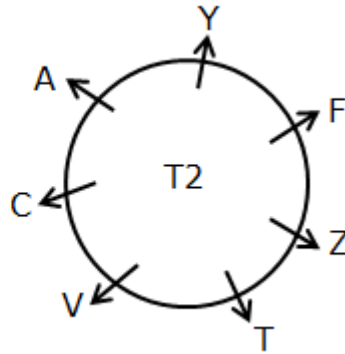
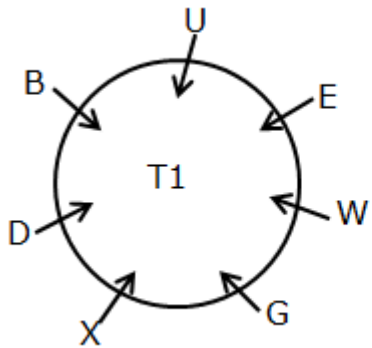

We have,

- D sits second to the left of G.
- A sits third to the right of T.
- One person sits between T and F, who is not sitting adjacent to A.

From the above conditions, there are two possibilities:

Case1:

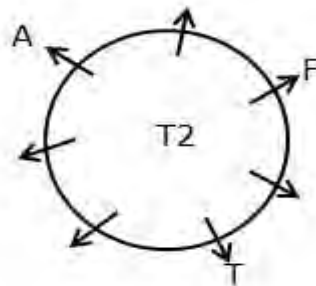
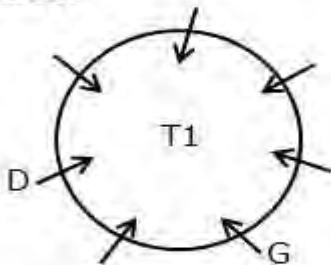

Case2:

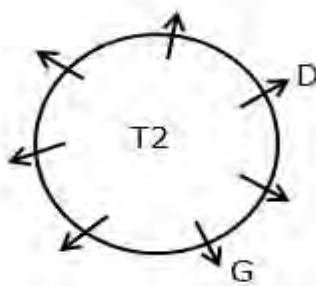
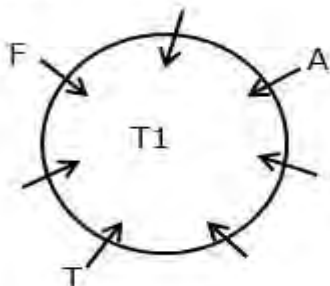

Again we have,

- As many persons sit between D and U as between U and W.
- Z sits second to the left of V.
- Two persons sit between E and X, who sits at the same table as G.

From the above conditions, there are two more possibilities.

Case1:

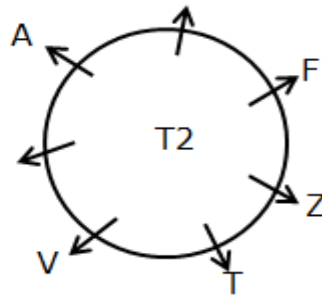
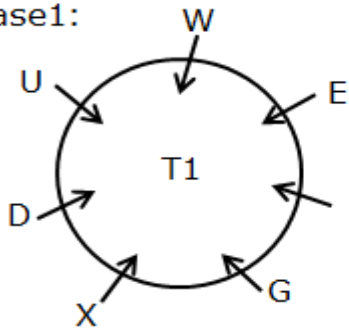

Case2:

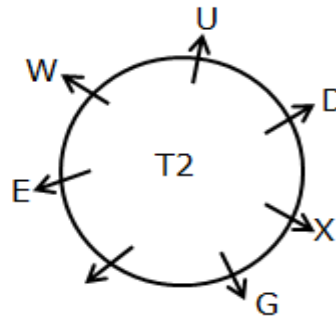
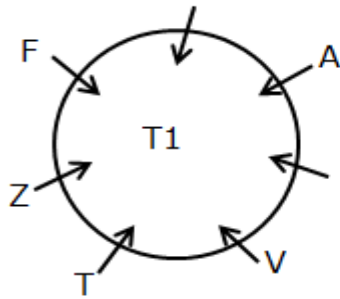

Case3:

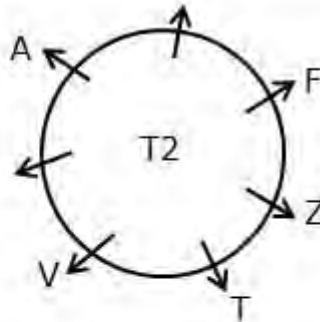
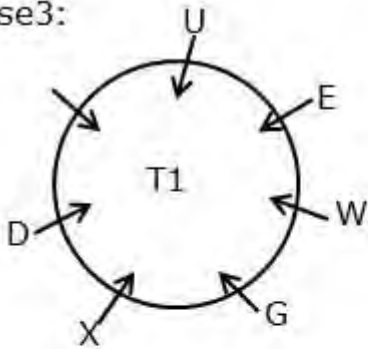

Case4:

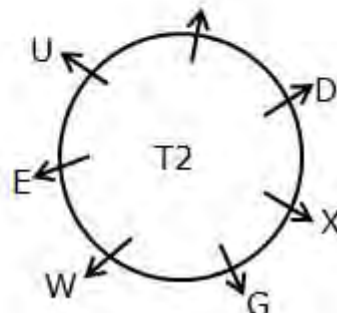
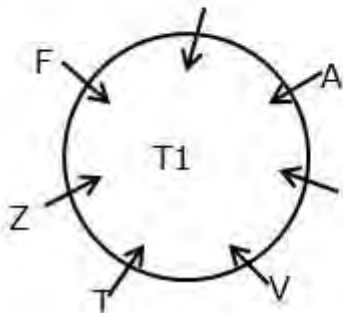

Again we have,

- Y faces away from the center.
- The number of persons sitting between U and B is one less than the number of persons sitting between T and C, when counted from the right of both U and T.

From the above conditions, case 1, case 2 and case 4 gets eliminated. Thus, case 3 shows the final arrangement.

~~Case 1:~~

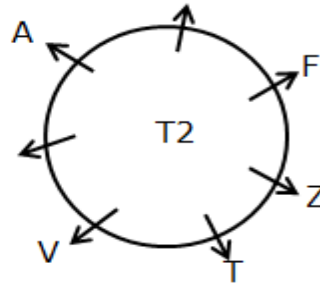
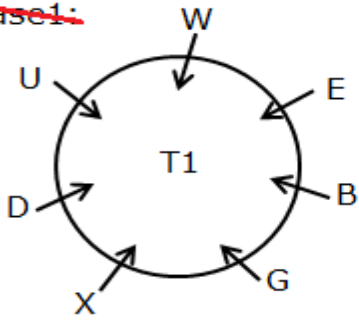

~~Case 2:~~

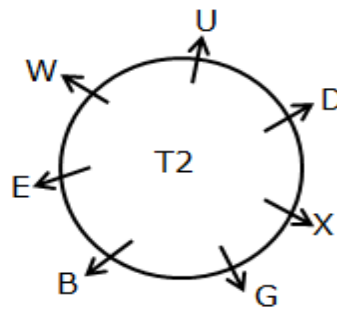
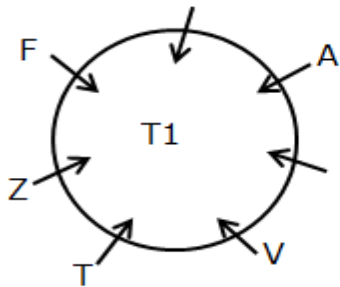

Case 3:

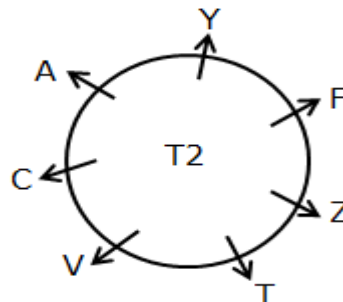
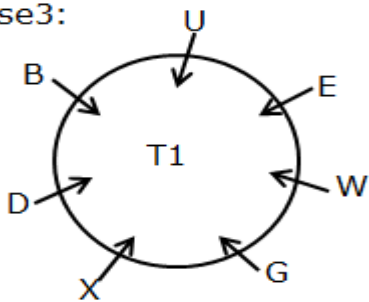

~~Case 4:~~

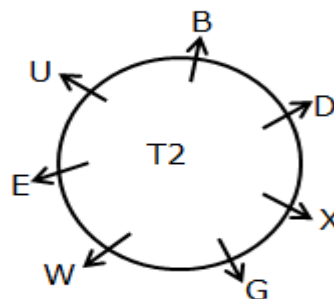
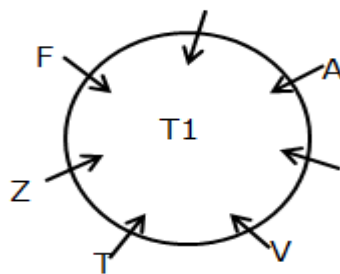

Set 15 (PO Mains)

Directions (71-75) Study the following information carefully and answer the below questions.

Eight persons – P, Q, R, S, T, U, V, and W are sitting around a circular table facing the center. Each person likes different numbers viz.- 9, 11, 12, 14, 17, 18, 21, and 24. All the information is not necessary in the same order.

“A@B” means “A sits second to the right of B”.

“A%B” means “Two persons are sitting between A and B”.

“A&B” means “A sits facing B”.

“A#B” means “A and B are not sitting together”.

“A\$B” means “A likes a number which is four more than B”.

Note: “A@12” means “A sits second to the right of the one who likes 12”.

Condition: **R@24, W%V@11, 24%P&11, 18&T@Q, V\$U&12, S%14&21, 11#W, 12@S.**

71) What is the position of U with respect to T?

- a) Third to the left
- b) Second to the right
- c) Immediate left
- d) Fourth to the right
- e) None of these

72) Who among the following person sits facing Q?

I. The one who likes 21

II. The one who sits immediate right of R

III. The one who sits third to the right of U

- a) Both I and III
- b) Both I and II
- c) Both II and III

- d) All I, II, and III
- e) None

73) How many persons are sitting between T and the one who likes 21 when counted from the right of T?

- a) Three
- b) As many persons are sitting between W and the one who likes 17 when counted from the right of W
- c) As many persons are sitting between Q and the one who sits facing S
- d) Four
- e) None of these

74) Four of the following five are alike in a certain way as per the given arrangement and hence form a group. Find the one that doesn't belong to that group.

- a) The one who sits immediate right of R
- b) S
- c) The one who sits facing V
- d) R
- e) The one who sits second to the left of S

75) Which of the following information is not true?

- a) R sits immediate left of P
- b) V and the one who likes 24 are sitting together
- c) R sits facing the one who likes 17
- d) W likes 11
- e) All the above statements are true

[Click Here to Get the Detailed Video Solution for the above given Questions](#)

Or Scan the QR Code to Get the Detailed Video Solutions



Answer Key with Explanation

Direction (71-75):

- 71. Answer: C
- 72. Answer: A
- 73. Answer: B
- 74. Answer: E(all of them like even numbers except option E)
- 75. Answer: D

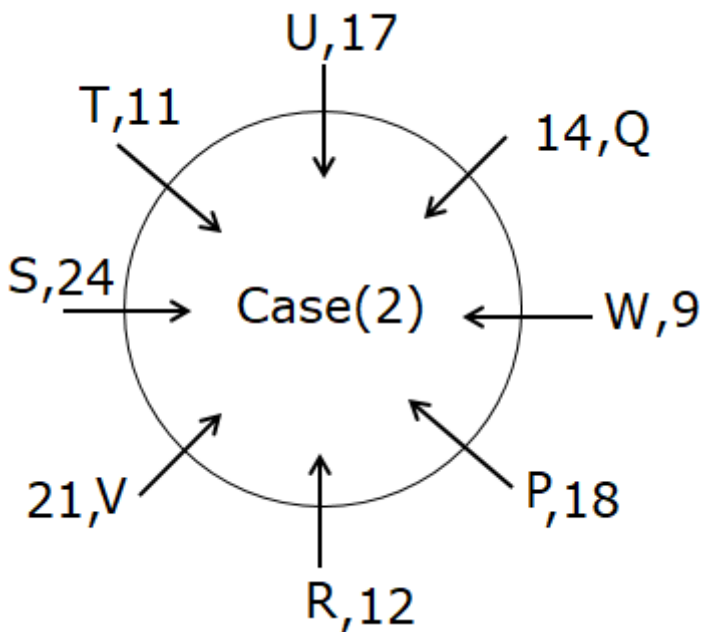

We have:

- **R@24:** R sits second to the right of the one who likes 24.
- **24%P&11:** Two persons are sitting between the one who likes 24 and P.

- P sits facing the one who likes 11.

That means, in case (1) P sits third to the right of R, in case (2) P sits immediate right of R, Based on the above given information we have:

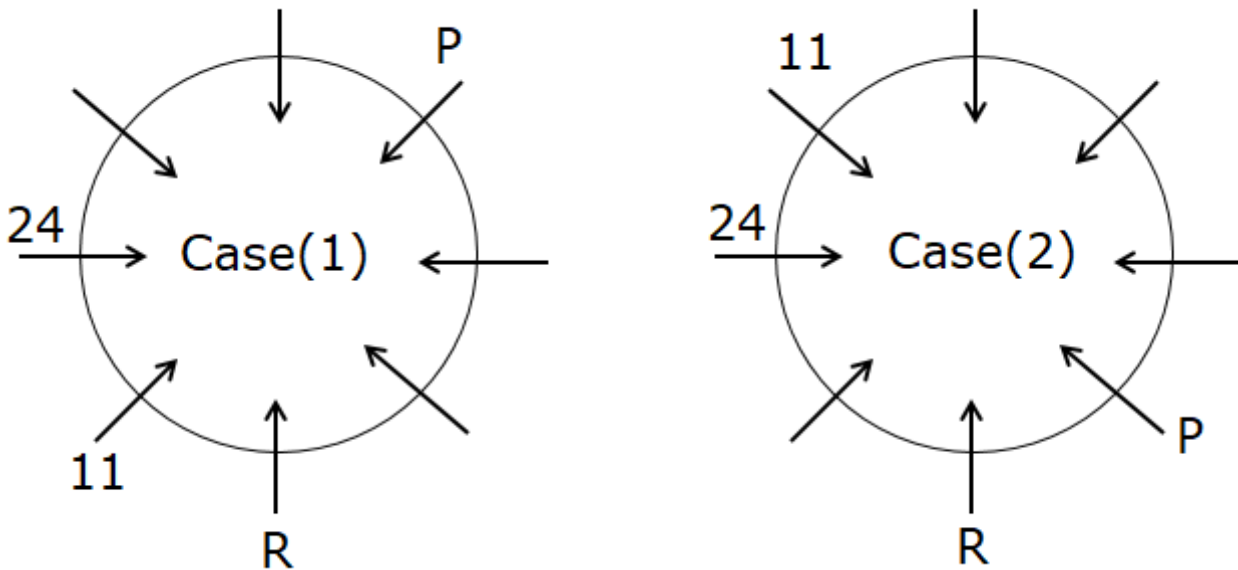

Again, we have:

- **W%V@11**: Two persons are sitting between W and V.
- V sits second to the right of the one who likes 11.
- **11#W**: The one who likes 11 and W are not sitting together.
That means, in case (1) & case (2) W sits immediate right of P.

Based on the above given information we have:

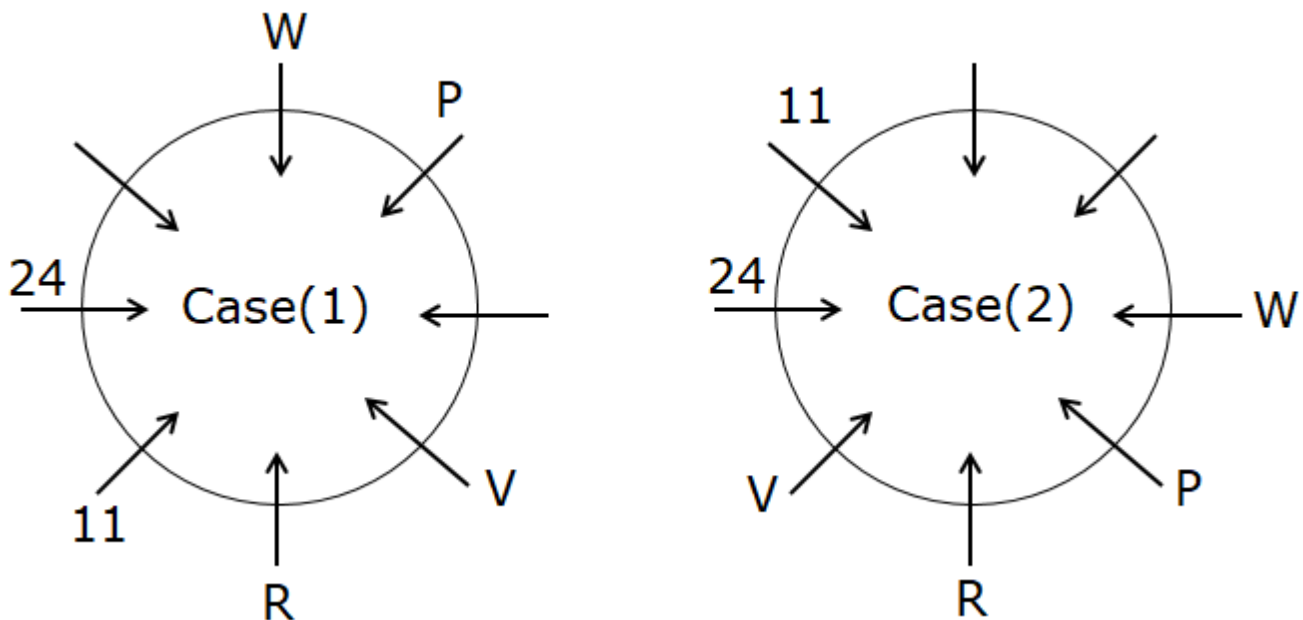

Again, we have:

- **V\$U&12**: V likes a number which is four more than U.

Since, only such possible combinations are (14, 18), and (17, 21).

- U sits facing the one who likes 12.
 - That means, in case (2) U sits third to the left of V, case (1) is not valid.
 - **12@S**: The one who likes 12 sits second to the right of S.
 - **S%14&21**: Two persons are sitting between S and the one who likes 14.
 - The one who likes 14 sits facing the one who likes 21.
- Since, V likes 21, thus U must like 17.

Based on the above given information we have:

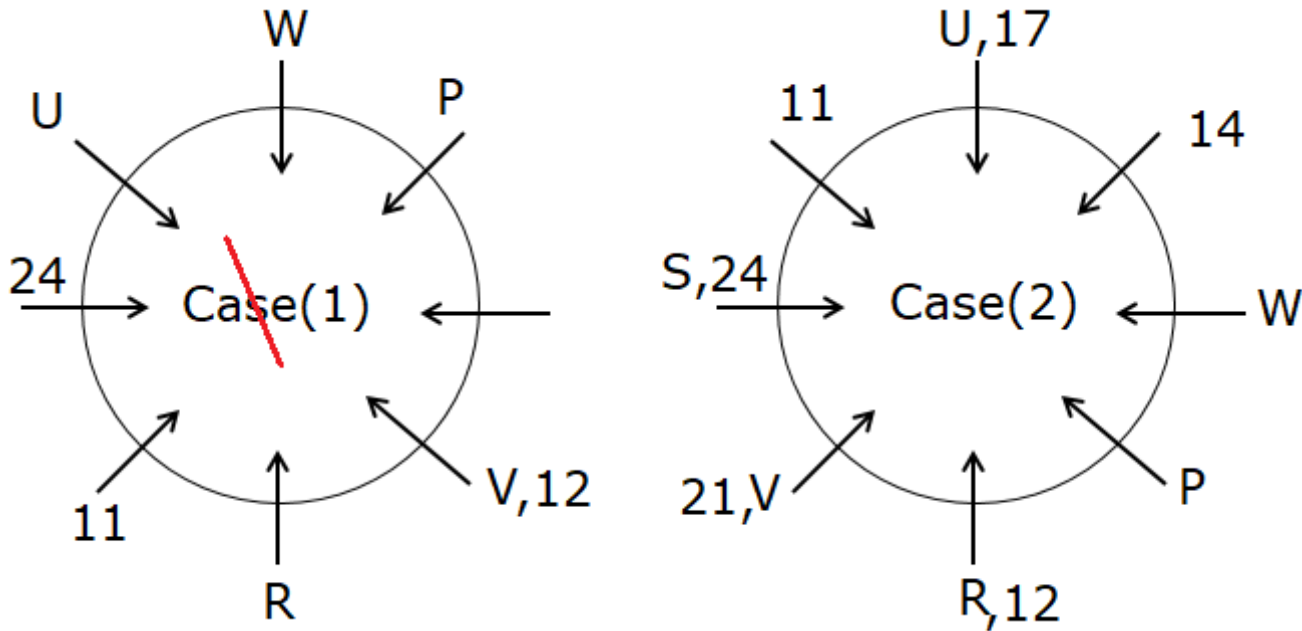

Case (1) is not valid as V doesn't like 12.

Again, we have:

- **18&T@Q**: The one who likes 18 sits facing T.
 - T sits second to the right of Q.
- That means, T likes 11, and W likes 9.

Based on the above given information we have:

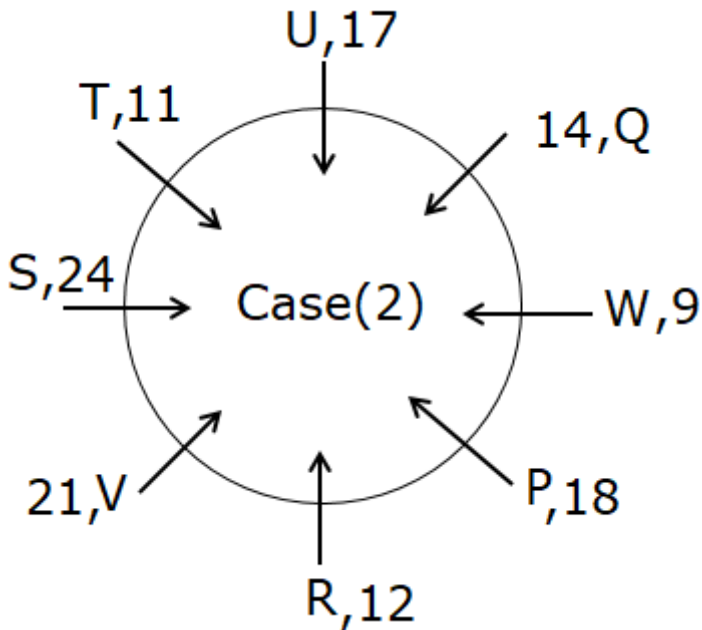

Set 16 (PO Mains)

Directions (76-80): Study the following information carefully and answer the below questions.

Ten persons – B, C, D, E, F, G, H, I, J, and K of three generations family are sitting around two concentric circular tables facing each other in such a way that five persons are sitting at each table. The person sitting in the outer circular table is facing the center and the person sitting in the inner circular table is facing away from the center.

Note: Four married couples are there in the family and none of the married couples are facing each other.

K sits second to the right of the one who sits facing H's husband. H is the daughter-in-law of B. H's husband sits third to the right of E, who sits facing center. C is the only daughter of B and sits adjacent to E. K is the son of G's sister and sits two places away from G's father. G's father sits facing G, who is the brother of F's father. F and K are related to I in such a way that I is the paternal and maternal grandmother

respectively. One person sits between G's mother and G. I sits facing the one who sits third to the right of H, who is the mother-in-law of J. The persons sitting adjacent to F are of the opposite gender. F sits facing the one who sits immediate left of D, who is the father of F. E's wife sits facing the one who sits third to the left of F's spouse.

76) What is the position of J with respect to F's mother?

- a) Second to the left
- b) Third to the right
- c) Second to the right
- d) Immediate left
- e) None of these

77) How the one who sits second to the right of I is related to E?

- a) Husband
- b) Brother-in-law
- c) Nephew
- d) Uncle
- e) None of these.

78) Who among the following person sits immediate right of E's wife?

- a) The one who sits third to the left of F
- b) E
- c) The one who is the wife of B
- d) J
- e) None

79) Four of the following five are alike in a certain way based on the given arrangement and thus form a group. Which one of the following doesn't belong to the group?

- a) CF

- b) HG
- c) JI
- d) BF
- e) KE

80) Which of the following statement(s) is/are not true?

- I. I is the maternal Uncle of F's mother
- II. K sits second to the right of F's wife
- III. H sits facing G's sister-in-law

- a) Both II and III
- b) Only III
- c) Only II
- d) Both I and III
- e) None of these

[Click Here to Get the Detailed Video Solution for the above given Questions](#)

Or Scan the QR Code to Get the Detailed Video Solutions



Answer Key with Explanation

Directions (76-80):

- 76. Answer: C**
- 77. Answer: B**
- 78. Answer: C**
- 79. Answer: D**
- 80. Answer: D**

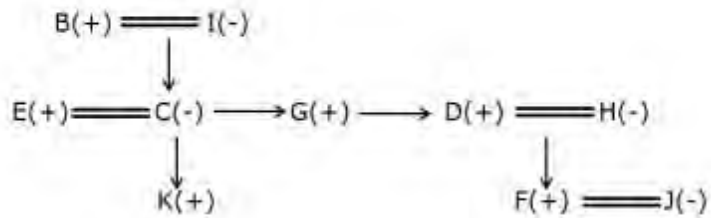
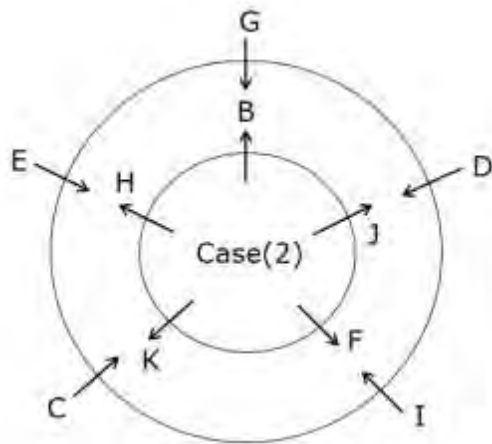

We have:

- K sits second to the right of the one who sits facing H's husband.
- H is the daughter-in-law of B.
- H's husband sits third to the right of E, who sits facing center.
- C is the only daughter of B and sits adjacent to E.

That means, in case (1) C sits immediate left of E, in case (2) C sits immediate right of E.

Based on the above given information we have:

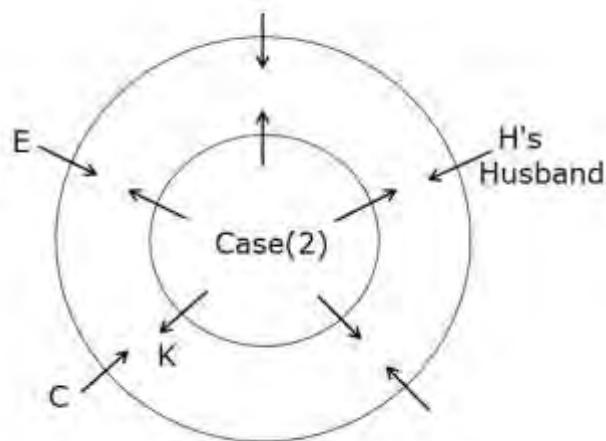
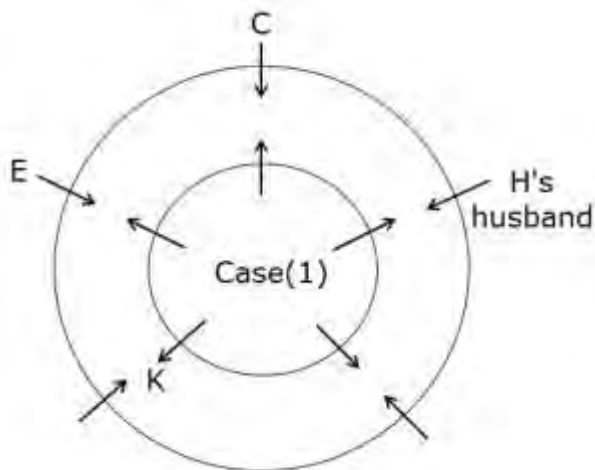

For Blood Relation:

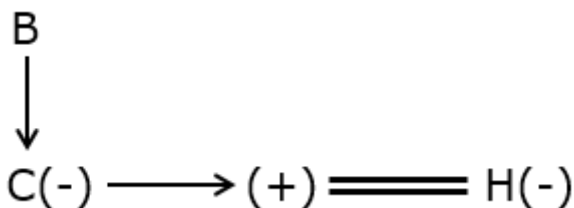

Again, we have:

- K is the son of G's sister and sits two places away from G's father.
- G's father sits facing G, who is the brother of F's father.
- F and K are related to I in such a way that I is the paternal and maternal grandmother respectively.

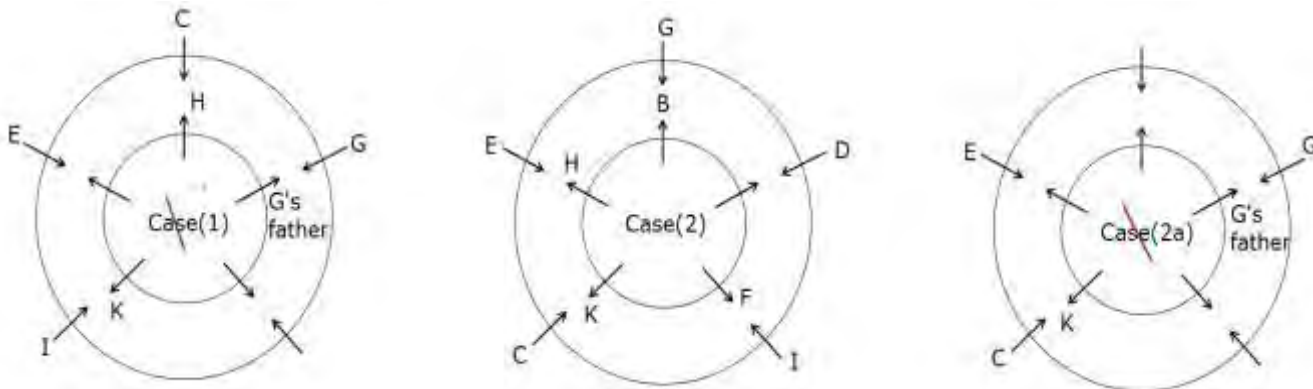

Case (1) is not valid as F sits facing the one who sits immediate left of D, case (2a) is not valid as one person sits between G's mother and G.

For Blood Relation:

$$B(+) \equiv I(-)$$



$$C(-) \longrightarrow G(+) \longrightarrow D(+) \equiv H(-)$$

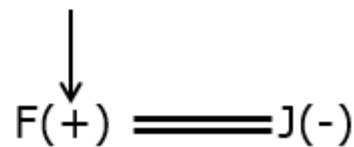
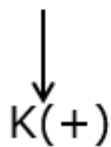

Again, we have:

- E's wife sits facing the one who sits third to the left of F's spouse. That means, E must be married to C.

Based on the above given information we have:

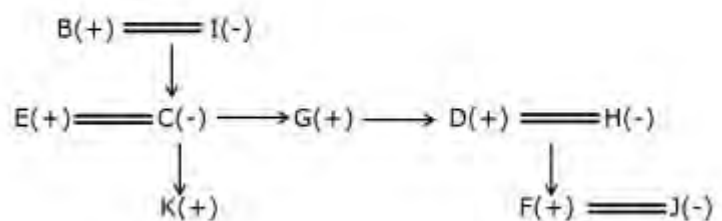
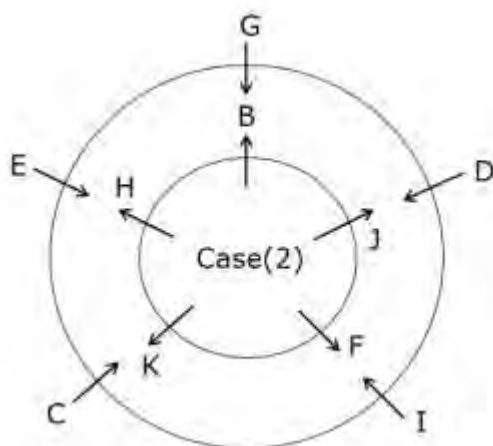

IBPS RRB Clerk Prelims Memory Based Paper

(Memory Based Paper held on 7th August 2022)

Reasoning Ability

Directions (1-5): Study the following information carefully and answer the questions given below. (Level: Easy)

Seven persons A, B, C, D, E, F and G are living in a seven storey building but not necessarily in the same order. The bottommost floor is numbered as 1 and the floor immediately above is numbered as 2 and so on.

Less than three persons live above E. Only two persons live between E and D. As many persons live above D as below B. A lives immediately below G. C lives below A.

1) Who among the following person lives three floors above G?

- a) E
- b) C
- c) B
- d) F
- e) None of these

2) Which of the following statements is/are true with respect to the final arrangement?

- a) F lives two floors above E
- b) Only three persons live between G and C
- c) D lives immediately above B
- d) All are true
- e) None of these

3) Four of the following five are alike in a certain way as per the given arrangement and hence form a group. Find the one who doesn't belong to that group.

- a) A
- b) D
- c) C
- d) E

e) F

4) How many persons live between B and C?

- a) Two
- b) Five
- c) Four
- d) Three
- e) None of these

5) Who among the following person lives immediately above E?

- a) C
- b) F
- c) G
- d) B
- e) None of these

Direction (6-8): Study the following information carefully and answer the questions given below.

J is the father of only X and Y. Z is the wife of Y and daughter of C. B is the grandson of J. B has only one aunt.

6. How is C related to B?

- a) Grandson
- b) Grandmother
- c) Grandfather
- d) Granddaughter
- e) Either b or c

7. How is Z related to X?

- a) Brother-in-law
- b) Cousin Sister
- c) Maternal aunt
- d) Sister-in-law
- e) Cannot be determined

8. If E is the aunt of X, then how is E related to J?

- a) Sister
- b) Mother
- c) Son
- d) Sister-in-law
- e) Cannot be determined

9. If in the word "QUALITY" all the vowels are changed to the immediate previous letter and all the consonants are changed to the immediate next letter as per the English alphabetical series, then which of the following letter is fourth from the left end?

- a) H
- b) U
- c) Z
- d) M
- e) R

10. How many such pairs of digits are there in the number "95426313" each of which has as many digits between them as there are in the number series (both forward and backward)?

- a) One
- b) Two
- c) Three
- d) More than three
- e) None

Directions (11-15): Read both the conclusions and then decide which of the given conclusions logically follows from the given statements disregarding the commonly known facts.

11. Statements:

Only a few masks are sanitizer
Some sanitizers are Vaccine
All Vaccine are tablets

Conclusions:

- I. Some sanitizers are tablets
- II. No vaccine is Mask
- a) Only conclusion I follows
- b) Either conclusion I or II follows
- c) Both conclusions I and II follow

- d) Only conclusion II follows
- e) Neither conclusion I nor II follows

12. Statements:

All invasions are seizure
Only a few seizures are ride
No ride is attack

Conclusions:

- I. All attacks can be invasions
- II. All seizures can never be attack
- a) Only conclusion I follows
- b) Either conclusion I or II follows
- c) Both conclusions I and II follow
- d) Only conclusion II follows
- e) Neither conclusion I nor II follows

13) Statements:

Only a few Drums are Cello.
All Cello are Banjo.
No Banjo is Guitar.

Conclusions:

- I. Some Cello can be Guitar.
- II. Some Banjo are Drums.
- a) Only conclusion I follows
- b) Either conclusion I or II follows
- c) Both conclusions I and II follow
- d) Only conclusion II follows
- e) Neither conclusion I nor II follows

14) Statements:

Some mouse is keyboard.
All keyboards are laptops.
Only a few laptops are CPU.

Conclusions:

- I. All keyboards can be CPU.
- II. Some mouse is laptops.
- a) Only conclusion I follows
- b) Either conclusion I or II follows
- c) Both conclusions I and II follow
- d) Only conclusion II follows
- e) Neither conclusion I nor II follows

15) Statements:

Few channels are commercial.
No Sports is channel.
Every commercial is entertainment.

Conclusions:

- I. Few channels are entertainment.
- II. No entertainment is sport.
- a) Only conclusion I follows
- b) Either conclusion I or II follows
- c) Both conclusions I and II follow
- d) Only conclusion II follows
- e) Neither conclusion I nor II follows

Directions (16-20): Study the following information carefully and answer the questions given below.

Six persons A, B, C, Q, R and S were born on two different dates viz., 11 and 22 of three different months viz., September, October and November but not necessarily in the same order.

C was born in the month having an odd number of days. Only two persons were born between C and R. As many persons born before R as after A. B was born immediately before S. Q was not born on an even numbered date.

16) S was born on which of the following day?

- a) October 22
- b) October 11
- c) September 11
- d) November 11
- e) None of these

17) Four of the following five are alike in a certain way as per the given arrangement and hence form a group. Find the one that doesn't belong to that group.

- a) Q-A
- b) R-B
- c) B-S
- d) C-Q
- e) R-S

18) How many persons were born

between R and Q?

- a) Three
- b) Two
- c) Four
- d) One
- e) None of these

19) Which of the following statements is/are true with respect to the final arrangement?

- a) S was born after Q
- b) B was born two persons before C
- c) Only four persons were born between A and B
- d) All are true
- e) None of these

20) Who among the following person was born immediately after S?

- a) R
- b) B
- c) C
- d) Q
- e) None of these

Direction (21-25): Study the following information carefully and answer the questions given below.

A@ \$Z56E7!@K5+L90*G3U%PJEDH%

21) What is the sum of the numbers which are between ! and * in the given series?

- A.10
- B.14
- C.13
- D.12
- E.15

22) How many vowels are immediately followed by a symbol in the given series?

- A.One
- B.Two
- C.Three
- D.Four

E.None

23) Four of the following five are alike in a certain way as per the given arrangement and hence form a group. Find the one that doesn't belong to that group.

- A.AZ
- B.6!
- C.+0
- D.KL
- E.%H

24) How many consonants are there which are immediately preceded by a consonant and immediately followed by a symbol?

- A.One
- B.Two
- C.Three
- D.Four
- E.None

25) Which of the following element is tenth to the right of the ninth element from the left end?

- A.A
- B.*
- C.3
- D.U
- E.None of these

Directions (26-30): In these questions, the relationship between different elements is shown in the statement. The statements are followed by two conclusions. Choose the conclusion(s) which is/are definitely true. (Level: Easy)

26. Statement:

$$R = P \geq U > T \leq O < Q \leq X$$

Conclusions:

- I. $X > T$
- II. $T \leq X$
- a) Only conclusion I is true
- b) Only conclusion II is true
- c) Both conclusions I and II are true
- d) Either conclusion I or II is true
- e) Neither conclusion I nor II is true

27. Statements:

$$P > R \leq S = T < Q \geq W > Y \geq X$$

Conclusions:

- I. $R < W$
- II. $T > X$
- a) Only conclusion I is true
- b) Only conclusion II is true
- c) Both conclusions I and II are true
- d) Either conclusion I or II is true
- e) Neither conclusion I nor II is true

28. Statements:

$$M \leq R < O \leq D \leq G = J \geq K$$

Conclusions:

- I. $M \leq G$
- II. $O \geq K$
- a) Only conclusion I is true
- b) Only conclusion II is true
- c) Both conclusions I and II are true
- d) Either conclusion I or II is true
- e) Neither conclusion I nor II is true

29) Statements:

$$Z \geq E < F \leq O; O \geq K > M \geq L$$

Conclusions:

- I. $L < O$
- II. $Z > M$
- A. Only conclusion I is true
- B. Only conclusion II is true
- C. Either conclusion I or II is true
- D. Both conclusions I and II are true
- E. Neither conclusion I nor II is true

30) Statements:

$$P \geq Q = R \leq S \leq T < W \geq X$$

Conclusions:

- I) $T > Q$
- II) $T = Q$
- A. Only conclusion I is true
- B. Only conclusion II is true
- C. Either conclusion I or II is true
- D. Both conclusions I and II are true
- E. Neither conclusion I nor II is true

Direction (31-35): Study the following information carefully and answer the questions given below.

Seven persons M, N, O, P, R, S and T are sitting around a circular table such that all of them are facing towards the centre, but not necessarily in the same order.

Only one person sits between P and M. T sits second to the right of P. N sits immediate right of T. R sits third to the right of O.

31. Who among the following person sits second to the right of S?

- a) T
- b) N
- c) O
- d) P
- e) M

32. Who among the following person sits adjacent to R?

- a) M
- b) N
- c) T
- d) P
- e) Both a and b

33. What is the position of P with respect to R?

- a) Second to the right
- b) Third to the right
- c) Immediate right
- d) Immediate left
- e) Fourth to the right

34. If N is related to T and M is related R, then who among the following person is related to O?

- a) T
- b) N
- c) M
- d) S
- e) O

35. If all the persons are made to sit in the alphabetical order in a clockwise direction with respect to M, then how many persons remain unchanged in their position (excluding M)?

- a) One
- b) Two
- c) Three
- d) More than three
- e) No one

Direction (36-39): Study the following information carefully and answer the questions given below.

SIN ICY XOS AOW KLY

36. If the first letter in each word is replaced by "L", then how many 3- letter meaningful words can be formed?

- a) One
- b) Two
- c) Three
- d) More than three
- e) None

37. If only the first and second letter of each word is changed to the immediate next letter as per the English alphabetical series, then how many words thus formed will have vowel?

- a) One
- b) Two
- c) Three
- d) More than three
- e) None

38. If all the words are arranged in the dictionary order from the left end, then which of the following word is fourth from the right end?

- a) SIN
- b) AOW
- c) ICY
- d) XOS
- e) None of these

39. If the first and the third letters of each word are interchanged, then how many new words thus formed end with a vowel?

- a) One
- b) Two
- c) Three
- d) More than three
- e) None

40) If in the number 57935861426, the digits at the odd position (from the left end) are dropped, then which of the following digit is second from the right end? (Level: Easy)

- a) 1
- b) 8
- c) 2
- d) 3
- e) 7

Numerical Ability

Directions (41-45): What value should come in the place of (?) in the following number series?

41) 183, ?, 248, 283, 313, 348

- a) 218
- b) 203
- c) 195
- d) 212
- e) 194

42) 1211, 1242, 1273, 1304, ?, 1366

- a) 1355
- b) 1345
- c) 1335
- d) 1325
- e) 1315

43) 6, 6, 12, 36, 144, ?

- a) 360
- b) 720
- c) 200
- d) 480
- e) 540

44) 0.5, 1, 3, 15, 105, ?

- a) 840
- b) 1050
- c) 735
- d) 945
- e) 1155

45) ?, 40, 55, 80, 115, 160

- a) 30
- b) 20
- c) 15
- d) 35
- e) 25

Directions (46-50): What value should come in the place of (?) in the following questions?

46) ${}^3\sqrt{1728} + \sqrt{256} * 10 = ? * 2$

- a) 90
- b) 75
- c) 84
- d) 86
- e) 70

47) 45% of 200 + 280 = ? + 13 * 5

- a) 290
- b) 305
- c) 320
- d) 340
- e) 360

48) $6 \left(\frac{3}{2}\right) + 4 \left(\frac{1}{4}\right) - \frac{3}{4} = ?$

- a) 20
- b) 17
- c) 23
- d) 11
- e) 13

49) $\sqrt{900} + \sqrt{1600} + 16 * 4 = ?$

- a) 120
- b) 140
- c) 125
- d) 130
- e) 134

50) $81 * 9^4 * 3^6 \div 3^9 = 3^{? * 3}$

- a) 3

- b) 5
- c) 10
- d) 11
- e) 6

51) $16 * 15 \div 8 \div 3 = ? \div 2$

- a) 16
- b) 40
- c) 30
- d) 20
- e) 15

52) $5/6$ of 360 + $8/9$ of 270 + 360 = ?

- a) 1000
- b) 900
- c) 960
- d) 840
- e) 880

53) ?% of 600 + $150 * 3 = 12 * 80$

- a) 95
- b) 70
- c) 85
- d) 100
- e) 75

54) $?^2 - \sqrt{(12^2 - 6^2 + 13)} = 25$

- a) 6
- b) 10
- c) 12
- d) 15
- e) 4

55) $5^3 + 15^2 = ? - 20^2$

- a) 640
- b) 880
- c) 720
- d) 680
- e) 750

56) $\sqrt{676} * 5 + 110 = ?^2 + 15$

- a) 11
- b) 15
- c) 19
- d) 12

- e) 10

57) 12.05% of 400 + $120 \div 4 - ? = 50$

- a) 28
- b) 16
- c) 20
- d) 32
- e) 15

58) $2(1/5) + 1(1/10) + ? = 3(1/5) + 4(1/5)$

- a) $4(1/5)$
- b) $2(1/10)$
- c) $3(1/10)$
- d) $4(1/10)$
- e) $2(1/5)$

59) $30 \div 5 + 12 * 10 - \sqrt{?} = 11^2$

- a) 16
- b) 36
- c) 25
- d) 81
- e) 49

60) $(310 - 80 - \sqrt{900}) \div ? = 25$

- a) 2
- b) 7
- c) 3
- d) 5
- e) 8

Directions (61-65): Study the following information carefully and answer the questions.

The given table chart shows the quantity of sunflowers sold (in kg) in three different months i.e. January, February and March and also given the quantity of lilies sold (in kg) in three different months and the quantity of roses sold in three different months.

Flowers	January	February	March
Sunflower	150	90	50
Lily	80	100	70
Rose	110	75	120

61) Find the ratio of the quantity of sunflowers sold in January and March together to the quantity of lilies sold in February?

- a) 2:1
- b) 5:4
- c) 3:2
- d) 4:1
- e) None of these

62) Find the difference between the total quantity of roses sold in January and February together and the quantity of lilies sold in February?

- a) 95
- b) 85
- c) 105
- d) 65
- e) None of these

63) If the ratio of the quantity of roses sold in February to April is 5:4, then the quantity of roses sold in April is what percentage of the quantity of lilies sold in January?

- a) 75%
- b) 50%
- c) 25%
- d) 60%
- e) None of these

64) The quantity of sunflowers sold in January is how much more/less than the total quantity of sunflowers and lilies sold in March?

- a) 50 less
- b) 40 more
- c) 10 less
- d) 30 more
- e) None of these

65) If the average quantity of sunflowers and marigolds sold in February is 105, then find the ratio of the quantity of marigold sold in February to the quantity of roses sold in March?

- a) 9:8
- b) 7:6
- c) 1:1
- d) 3:4
- e) None of these

66) A boat covers 64 km downstream in 4 hours. If the difference between the downstream and upstream speed of the boat is 8 km/hr, then find the speed of the boat in still water?

- a) 12 km/hr
- b) 10 km/hr
- c) 16 km/hr
- d) 20 km/hr
- e) None of these

67) A vessel contains 180 liters of milk and water in the ratio of 5:4. If 20 liters of milk is added to the mixture, then find the ratio of milk to water in the final mixture?

- a) 3:2
- b) 4:1
- c) 2:1
- d) 5:2
- e) None of these

68) Ratio of the present age of A to B is 4:5. If the difference between the age of A 6 years hence and B 4 years hence is 8, then find the sum of the present age of A and B together?

- a) 54 years
- b) 90 years
- c) 63 years
- d) 45 years
- e) None of these

69) The number x is 4 more than that of y. If the difference between the square of numbers x and y is 72, then find the number x?

- a) 10
- b) 8
- c) 11
- d) 15

e) None of these

a) 336 cm²

b) 420 cm²

c) 560 cm²

d) 896 cm²

e) None of these

70) The perimeter of the rectangle is 120 cm and the ratio of the length to the breadth of the rectangle is 7:8. Find the area of the rectangle?

Directions (71-75): Read the following information carefully and answer the questions.

The given line graph shows the quantity of five different nuts namely walnuts, almonds, cashew nuts, groundnuts and fox nuts sold in kg.

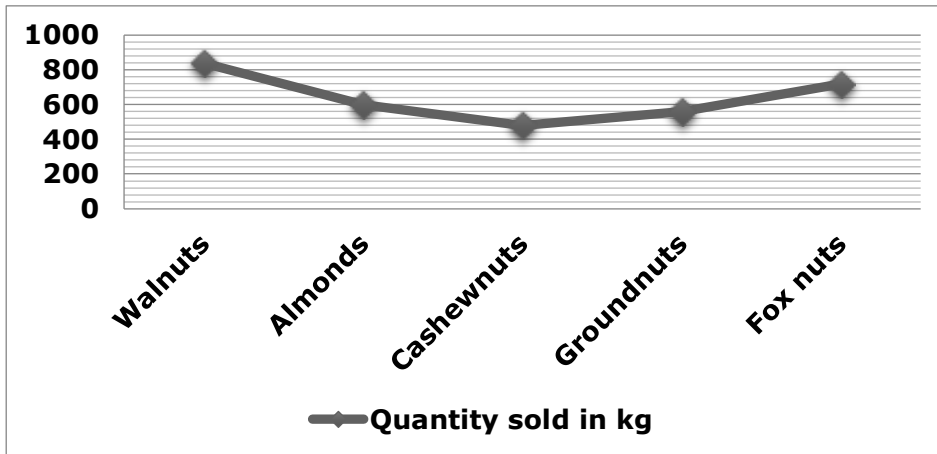

71) If the price of walnuts and cashew nuts sold is Rs.100 per kg and Rs.150 per kg respectively, then find the total revenue generated by selling walnuts and cashew nuts.

a) Rs.156000

b) Rs.160000

c) Rs.184000

d) Rs.172000

e) None of these

72) Find the difference between the total quantity of almonds and cashew nuts sold and the quantity of fox nuts sold.

a) 380 kg

b) 240 kg

c) 360 kg

d) 480 kg

e) None of these

73) Find the ratio of the quantity of almonds sold to the total quantity of cashew nuts and fox nuts sold.

a) 5:6

b) 4:3

c) 3:2

d) 7:5

e) None of these

74) Find the average of the quantities of almonds, cashew nuts and fox nuts.

a) 450

b) 540

c) 640

d) 600

e) None of these

75) The quantity of walnuts and cashew nuts sold is what percentage of the quantity of almonds sold?

a) 100%

b) 125%

c) 220%

d) 150%

e) None of these

76) A invested Rs.x in SI at 8% rate of interest per annum for 10 years. B invested the same amount in SI at 5% rate of interest per annum for 6 years and the difference between the interest obtained by A and B is Rs.1000. Find the amount invested by B.

- a) Rs.2400
- b) Rs.2000
- c) Rs.1500
- d) Rs.1800
- e) None of these

77) A train crosses a moving man travelling in the opposite direction with a speed of x m/s in 15 seconds and the train crosses a pole in 18 seconds. Find the speed of the man, if the length of the train is 450 m.

- a) 8 m/s
- b) 2 m/s
- c) 6 m/s
- d) 5 m/s
- e) None of these

78) The average of five numbers is 32 and the average of last three numbers is 40 and the ratio of the 1st and 2nd number is 3:5. Find the difference between first and second number.

- a) 18
- b) 10
- c) 25
- d) 20
- e) None of these

79) A and B together can complete a work in 12 days. A alone can complete the work in 20 days. If the total wages obtained by A and B together is Rs.5000, then find the wages obtained by A alone.

- a) Rs.3000
- b) Rs.2000
- c) Rs.2400
- d) Rs.3600

e) None of these

80) A shopkeeper sold a book at a loss of 10%. If he had sold the same book at a profit of 20%, then he would have earned Rs.150 more. Find the cost price of the book?

- a) Rs.700
- b) Rs.450
- c) Rs.500
- d) Rs.320
- e) None of these

ANSWER WITH EXPLANATION

Direction (1-5):

- 1. Answer: D
- 2. Answer: A
- 3. Answer: B
- 4. Answer: C
- 5. Answer: D

Final arrangement:

Floor	Name
7	F
6	B
5	E
4	G
3	A
2	D
1	C

We have,

- Less than three persons live above E
 - Only two persons live between E and D
- From the above condition, there are three possibilities.

	Case1	Case2	Case3
Floor	Name	Name	Name
7			E
6		E	
5	E		
4			D
3		D	
2	D		
1			

Again we have,

- As many persons live above D as below B
- A lives immediately below G
- C lives below A

From the above condition, Case2 and Case3 gets eliminated. Case1 shows the final arrangement.

	Case1	Case2	Case3
Floor	Name	Name	Name
7	F		E
6	B	E	
5	E	B	
4	G		D
3	A	D	
2	D	G	
1	C	A	

Direction (6-8):

- 6. Answer: E
- 7. Answer: D
- 8. Answer: E

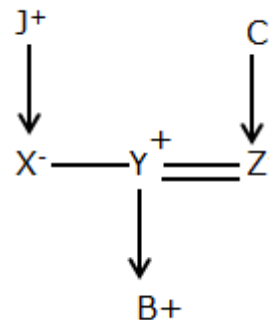

9. Answer: D
QUALITY
RTZMHUZ

10. Answer: C

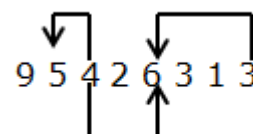

11. Answer: A

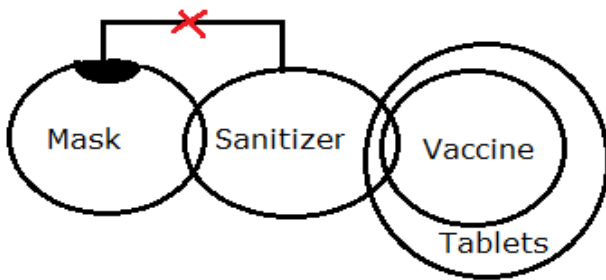

12. Answer: C

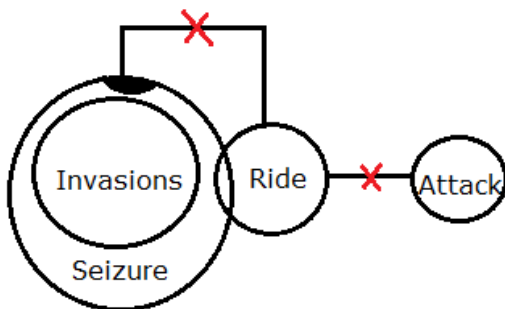

13. Answer: D

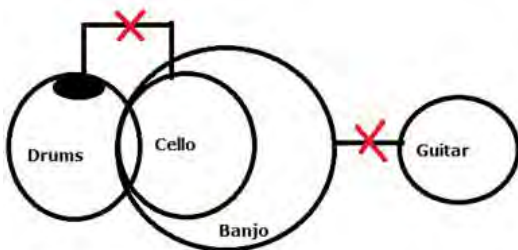

14. Answer: C

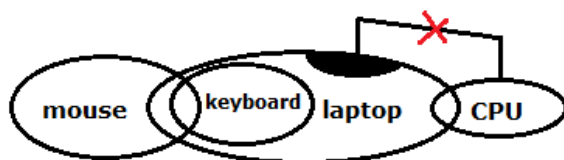

15. Answer: A

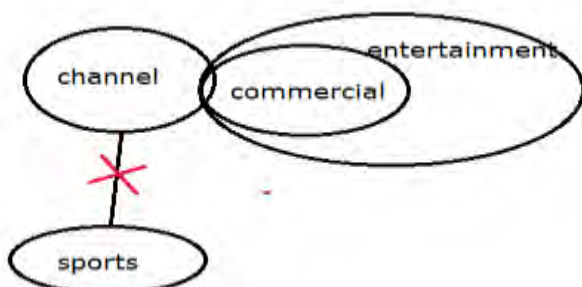

Direction (16-20):

16. Answer: B

17. Answer: E (The first person was born immediately before the second person, except in option e)

18. Answer: A

19. Answer: B

20. Answer: C

Final arrangement:

Month	Date	Name
September	11	R
	22	B
October	11	S
	22	C
November	11	Q
	22	A

We have,

- C was born in the month having an odd number of days
- Only two persons were born between C and R
- As many persons born before R as after A.

From the above condition, there are two possibilities.

	Case1		Case2	
Month	Date	Name	Date	Name
September	11	A	11	R
	22		22	
October	11	C	11	
	22		22	C
November	11		11	
	22	R	22	A

Again we have,

- B was born immediately before S

- Q was not born on an even numbered date

From the above condition, Case1 gets eliminated. Case2 shows the final arrangement.

	Case1		Case2	
Month	Date	Name	Date	Name
September	11	A	11	R
	22		22	B
October	11	C	11	S
	22	B	22	C
November	11	S	11	Q
	22	R	22	A

Direction (21-25):

21. Answer: B

$$5+9=14$$

22. Answer: C

A@ \$Z56E7!@K5+L9O*G3U%PJEDH%

These are the vowels that are immediately followed by a symbol are A @, O *, and U %

23. Answer: E (Only two elements are there between both elements except option e)

24. Answer: B

A@ \$Z56E7!@K5+L9O*G3U%PJEDH%

The consonants that are immediately preceded by another consonant and immediately followed by a symbol are P J £ and D H %.

25. Answer: C

A@ \$Z56E7!@K5+L9O*G3U%PJEDH%

26. Answer: A

I. $X > T (X \geq Q > O \geq T) \rightarrow \text{True}$

II. $T \leq X (X \geq Q > O \geq T) \rightarrow \text{False}$

27. Answer: E

I. $R < W (R \leq S = T < Q \geq W) \rightarrow \text{False}$

II. $T > X (T < Q \geq W > Y \geq X) \rightarrow$

False

28. Answer: E

I. $M \leq G (M \leq R < O \leq D \leq G) \rightarrow \text{False}$

II. $O \geq K (O \leq D \leq G = J \geq K) \rightarrow$

False

29. Answer: A

$Z \geq E < F \leq O \geq K > M \geq L$

II. $L < O \rightarrow O \geq K > M \geq L$ (true)

II. $Z > M \rightarrow Z \geq E < F \leq O \geq K > M$ (false)

30. Answer: C

I) $T > Q (Q = R \leq S \leq T)$ False

II) $T = Q (Q = R \leq S \leq T)$ False

But, we can combine both to get either I or II follow

Direction (31-35):

31. Answer: C

32. Answer: E

33. Answer: B

34. Answer: A

35. Answer: E

Final arrangement

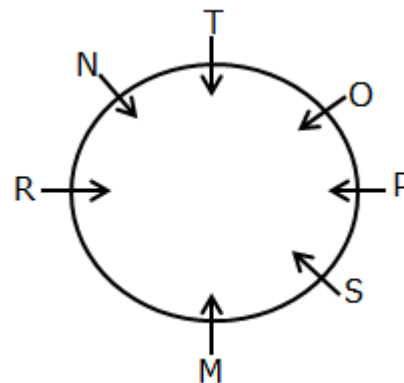

We have,

- One person sits between P and M
- From the above condition, there are two possibilities. And case2 gets eliminated.

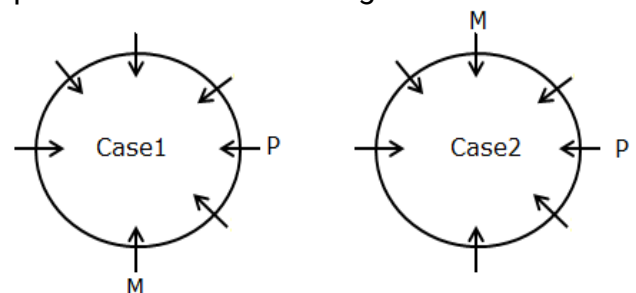

Again we have,

- T sits second to the right of P
- N sits immediate right of T
- R sits third to the right of O

From the above condition, Case2 gets eliminated. Case1 shows the final arrangement.

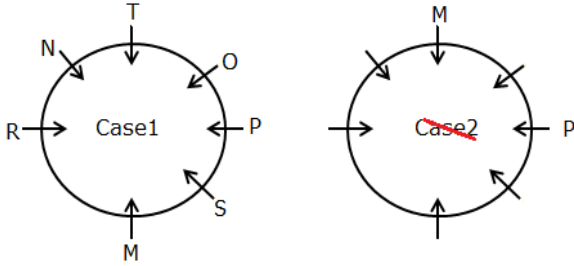

Directions (36-39):

36) Answer: A

The given series,

SIN ICY XOS AOW KLY

In this question, we have to replace the first letter in each word by "L", then we

have to find out the how many meaningful words can be formed after replacing

the first letter in each word by "L".

LIN LCY LOS LOW LLY

Only one meaningful word can be formed that is **LOW**

37) Answer: E

In this question, first we have to change first and second letter (from the left) of the each word to the immediate next letter as per the alphabetical series.

The given series,

SIN ICY XOS AOW KLY

TJN JDY YPS BPW LMY

Then, we have to find out the how many words will have vowel.

No vowel can be formed.

38) Answer: C

The given series,

SIN ICY XOS AOW KLY

In this question, first we have to arrange all the words in the dictionary order from the left end, Then we have to find out the fourth word from the right end.

AOW ICY KLY SIN XOS

Answer is **ICY**.

39) Answer: B

The given series,

SIN ICY XOS AOW KLY

In this question, first we have to interchange the first and third letter of each word, then we have to find out the how many new words thus formed ends with a vowel.

NIS **YCI** SOX **WOA** YLK

So, two new words will be formed by ending with a vowel.

Answer is **Two**.

40. Answer: A

57935861426

73812

41. Answer: A

183 + 35 = 218

218 + 30 = 248

248 + 35 = 283

283 + 30 = 313

313 + 35 = 348

42. Answer: C

1211 + 31 = 1242

1242 + 31 = 1273

1273 + 31 = 1304

1304 + 31 = 1335

1335 + 31 = 1366

43. Answer: B

6 * 1 = 6

6 * 2 = 12

12 * 3 = 36

36 * 4 = 144

144 * 5 = 720

44. Answer: E

0.5 * 2 = 1

1 * 3 = 3

3 * 5 = 15

15 * 7 = 105

105 * 11 = 1155

45. Answer: D

35 + 5 = 40

40 + 15 = 55

55 + 25 = 80

80 + 35 = 115

115 + 45 = 160

46. Answer: D

$$\begin{aligned} \sqrt[3]{1728} + \sqrt{256} * 10 &= ? * 2 \\ 12 + 16 * 10 &= ? * 2 \\ 172 &= ? * 2 \\ ? &= 86 \end{aligned}$$

47. Answer: B

$$\begin{aligned} 45/100 * 200 + 280 &= ? + 13 * 5 \\ 90 + 280 &= ? + 65 \\ ? &= 370 - 65 = 305 \end{aligned}$$

48. Answer: D

$$\begin{aligned} 6(3/2) + 4(1/4) - 3/4 &= ? \\ 15/2 + 17/4 - 3/4 &= ? \\ (30 + 17 - 3)/4 &= ? \\ 44/4 &= ? \\ ? &= 11 \end{aligned}$$

49. Answer: E

$$\begin{aligned} \sqrt{900} + \sqrt{1600} + 16 * 4 &= ? \\ 30 + 40 + 64 &= ? \\ ? &= 134 \end{aligned}$$

50. Answer: A

$$\begin{aligned} 81 * 9^4 * 3^6 \div 3^9 &= 3^{? * 3} \\ 3^4 * 3^8 * 3^6 \div 3^9 &= 3^{? * 3} \\ 3^9 &= 3^{? * 3} \\ ? * 3 &= 9 \\ ? &= 3 \end{aligned}$$

51. Answer: D

$$\begin{aligned} 16 * 15 \div 8 \div 3 &= ? \div 2 \\ 10 &= ? \div 2 \\ ? &= 20 \end{aligned}$$

52. Answer: B

$$\begin{aligned} 5/6 * 360 + 8/9 * 270 + 360 &= ? \\ 300 + 240 + 360 &= ? \\ ? &= 900 \end{aligned}$$

53. Answer: C

$$\begin{aligned} ?/100 * 600 + 150 * 3 &= 12 * 80 \\ 6 * ? + 450 &= 960 \\ 6 * ? &= 510 \end{aligned}$$

$$? = 85$$

54. Answer: A

$$\begin{aligned} ?^2 - \sqrt{(12^2 - 6^2 + 13)} &= 25 \\ ?^2 - \sqrt{(144 - 36 + 13)} &= 25 \\ ?^2 - \sqrt{121} &= 25 \\ ?^2 - 11 &= 25 \\ ?^2 &= 36 \\ ? &= 6 \end{aligned}$$

55. Answer: E

$$\begin{aligned} 5^3 + 15^2 &= ? - 20^2 \\ 125 + 225 &= ? - 400 \\ ? &= 750 \end{aligned}$$

56. Answer: B

$$\begin{aligned} \sqrt{676} * 5 + 110 &= ?^2 + 15 \\ 26 * 5 + 110 &= ?^2 + 15 \\ ?^2 &= 130 + 110 - 15 \\ ?^2 &= 225 \\ ?^2 &= 15^2 \\ ? &= 15 \end{aligned}$$

57. Answer: A

$$\begin{aligned} 12.05\% \text{ of } 400 + 120 \div 4 - ? &= 50 \\ 12 * 400/100 + 30 - ? &= 50 \\ ? &= 48 + 30 - 50 \\ ? &= 28 \end{aligned}$$

58. Answer: D

$$\begin{aligned} 2(1/5) + 1(1/10) + ? &= 3(1/5) + 4(1/5) \\ 2(2/10) + 1(1/10) + ? &= 3(2/10) + 4(2/10) \\ 3(3/10) + ? &= 7(4/10) \\ ? &= 4(1/10) \end{aligned}$$

59. Answer: C

$$\begin{aligned} 30 \div 5 + 12 * 10 - \sqrt{?} &= 11^2 \\ 6 + 120 - 121 &= \sqrt{?} \\ \sqrt{?} &= 126 - 121 \\ \sqrt{?} &= 5 \\ ? &= 25 \end{aligned}$$

60. Answer: E

$$(310 - 80 - \sqrt{900}) \div ? = 25$$

$$(310 - 80 - 30) = 25 * ?$$

$$? = 200/25$$

$$? = 8$$

61. Answer: A

The quantity of sunflowers sold in January and March together = $150 + 50 = 200$

Required ratio = $200:100 = 2:1$

62. Answer: B

The total quantity of roses sold in January and February together = $110 + 75 = 185$

Required difference = $185 - 100 = 85$

63. Answer: A

The quantity of roses sold in April = $75 * 4/5 = 60$

Required percentage = $60/80 * 100 = 75\%$

64. Answer: D

The total quantity of sunflower and lilies sold in March = $50 + 70 = 120$

Required difference = $150 - 120 = 30$

65. Answer: C

The quantity of marigold sold in February = $105 * 2 - 90 = 210 - 90 = 120$

Required ratio = $120:120 = 1:1$

66. Answer: A

The upstream speed of the boat = 8 km/hr

The downstream speed of the boat = $64/4 = 16 \text{ km/hr}$

The speed of the boat in still water = $(16 + 8)/2 = 24/2 = 12 \text{ km/hr}$

67. Answer: A

The quantity of milk in the initial mixture = $180 * 5/(5 + 4) = 180 * 5/9 = 100 \text{ liters}$

The quantity of water in the initial mixture = $180 - 100 = 80 \text{ liters}$

The ratio of milk to water in the final mixture = $(100 + 20) : 80 = 120:80 = 3:2$

68. Answer: B

Let the present age of A = $4x$

And the present age of B = $5x$

$$(5x + 4) - (4x + 6) = 8$$

$$x - 2 = 8$$

$$x = 10$$

The present age of A = $4 * 10 = 40 \text{ years}$

The present age of B = $5 * 10 = 50 \text{ years}$

Required total = $40 + 50 = 90 \text{ years}$

69. Answer: C

Let the number y = a

And the number x = a + 4

$$(a + 4)^2 - a^2 = 72$$

$$a^2 + 16 + 8a - a^2 = 72$$

$$8a = 72 - 16$$

$$a = 56/8$$

$$a = 7$$

The number x = $7 + 4 = 11$

70. Answer: D

$$2 * (7x + 8x) = 120$$

$$15x = 60$$

$$x = 4$$

The length of the rectangle = $7 * 4 = 28 \text{ cm}$

The breadth of the rectangle = $8 * 4 = 32 \text{ cm}$

The area of the rectangle = $28 * 32 = 896 \text{ cm}^2$

71. Answer: A

Revenue obtained by selling walnuts = $840 * 100 = \text{Rs.}84000$

Revenue obtained by selling cashew nuts = $480 * 150 = \text{Rs.}72000$

Total revenue generated = $84000 + 72000 = \text{Rs.}156000$

72. Answer: C

Required difference = $(600 + 480) - 720 = 360 \text{ kg}$

73. Answer: A

Required ratio = $600:(480 + 720) = 600 : 1200 = 1:2$

74. Answer: D

$$\text{Required average} = (600 + 480 + 720)/3 = 1800/3 = 600$$

75. Answer: C

$$\text{Required percentage} = 1320/600 * 100 = 220\%$$

76. Answer: B

$$x * 8 * 10/100 - x * 5 * 6/100 = 1000$$

$$80x/100 - 30x/100 = 1000$$

$$50x/100 = 1000$$

$$x = \text{Rs.}2000$$

77. Answer: D

$$\text{Speed of the train} = 450/18 = 25 \text{ m/s}$$

$$450/(25 + x) = 15$$

$$30 = 25 + x$$

$$x = 5 \text{ m/s}$$

78. Answer: B

$$\text{Smallest number} = 3x$$

$$\text{Largest number} = 5x$$

$$\text{Sum of the 1}^{\text{st}} \text{ and 2}^{\text{nd}} \text{ number} = 5 * 32 - 3 *$$

$$40 = 160 - 120 = 40$$

$$3x + 5x = 40$$

$$8x = 40$$

$$x = 5$$

$$\text{Difference} = 5x - 3x = 2x = 2 * 5 = 10$$

79. Answer: A

$$1/A + 1/B = 1/12$$

$$1/20 + 1/B = 1/12$$

$$1/B = 1/12 - 1/20 = (5 - 3)/60 = 2/60 = 1/30 \\ = 30 \text{ days}$$

$$\text{Ratio of the efficiency of A and B} = 1/20 : 1/30 = 3:2$$

$$\text{Wages obtained by A} = 5000 * 3/5 = \text{Rs.}3000$$

80. Answer: C

$$\text{Let the cost price of the book} = x$$

$$x * 120/100 - x * 90/100 = 150$$

$$120x - 90x = 150 * 100$$

$$x = 150 * 100/30$$

$$x = 500$$

$$\text{The cost price of the book} = \text{Rs.}500$$

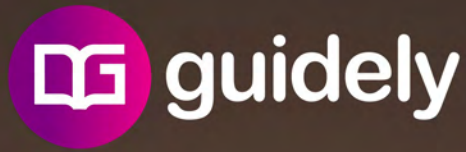

ENGLISH VOCABULARY

FEBRUARY 2023



1 REMINISCE (VERB)

Recall the past

Synonyms - Look back on, Recognize, Call up

Antonyms - Forget, ignore, Neglect

Example I likely to reminisce my childhood in the night time



2 GLOOM AND DOOM (PHRASAL VERB)

A feeling that a situation is very bad and without hope

Synonyms - Pessimism, Despondency

Antonyms - Pleasure, Cheer

Example The national feeling of doom and gloom



3 SILVER LINING (NOUN)

An advantage that comes from a difficult or unpleasant situation.

Synonyms - Consolation, Solace

Antonyms - Trouble, Weakness

Example Now aged two, she is the silver lining, but he and the mother are not together



4 FADING (VERB)

A gradual loss of strength or importance

Synonyms - Dim, Dull

Antonyms - Increase

Example The light had faded

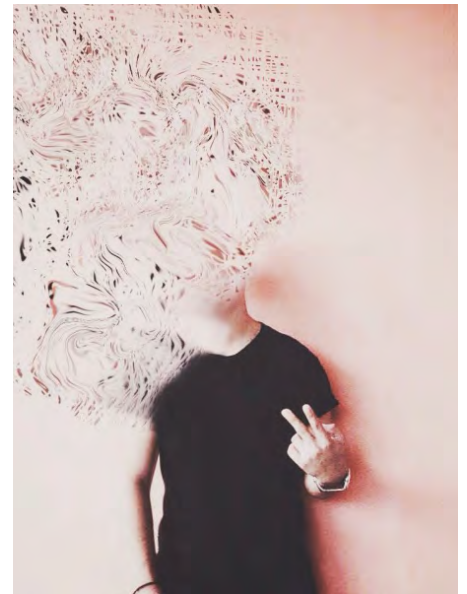

5 SHORING UP (PHRASAL VERB)

To make something stronger by

Synonyms - Sustaining, Carrying

Antonyms - Undermining, Weakening

Example The shored up the wall

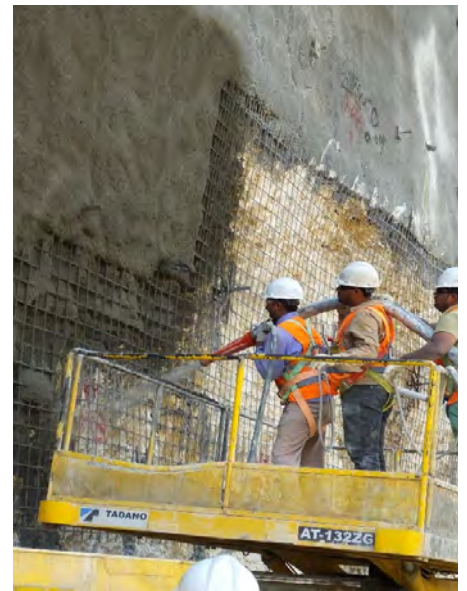

6 BURNOUT (NOUN)

Extreme tiredness caused by working too hard.

Synonyms - Exhausted, Overwork

Antonyms - Be Idle

Example Doing one task for too long can cause you to burnout



7

SETBACK (NOUN)



Something that causes delay or stop progress

Synonyms - Problem, Difficulty, Issue

Antonyms - Breakthrough, Step Forward

Example A serious setback for the peace process



8

FORMIDABLE (ADJECTIVE)



Of great strength

Synonyms - Forceful, Powerful

Antonyms - Comforting, Easy

Example We have a formidable task ahead of us



9

WARINESS (NOUN)



Caution about possible dangers or problems

Synonyms - Suspicion, Distrust, Caution

Antonyms - Recklessness

Example They had all regarded her with wariness

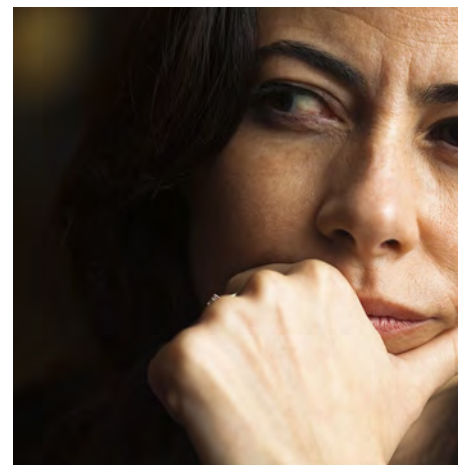

10

CALL ON (PHRASAL VERB)



Officially asks someone to do something.

Synonyms - Visit, Avail oneself of

Example He is planning to call on suba today



11

DE FACTO (ADJECTIVE)



Existing in fact, but not officially decided or approved.

Example The general who sits at the head of the military is the de facto ruler of the nation.



12

REFERENDUM (NOUN)



An occasion when all the people of a country can vote on a particular political question.

Synonyms - Plebiscite, Ballot, Poll

Antonyms - Abstain, Barring

Example A nationwide referendum will be held tomorrow



13 SLOPPY (ADJECTIVE)

Careless

Synonyms - Slapdash, Slipshod

Antonyms - Careful

Example We gave away a goal through sloppy defending.



14 SABOTAGE (VERB)

Destroy

Synonyms - Wreck, Vandalise

Antonyms - Strengthen

Example Power lines from South Africa were sabotaged by rebel's Forces.



15 INCUMBENT (NOUN)

A person who is currently in an person in an official position

Synonyms - Current, Present

Antonyms - Optional, Future

Example The present incumbent will soon be retiring.



16 LUKEWARM (ADJECTIVE)

 **Not showing much interest**

Synonyms - Not keen, Tepid

Antonyms - Enthusiastic

Example They drank bitter lukewarm coffee



17 TRANSCEND (VERB)

 **To go further than the usual of something**

Synonyms - Surpass, Excel, Exceed

Antonyms - Lose, Fail

Example He surpassed the team head

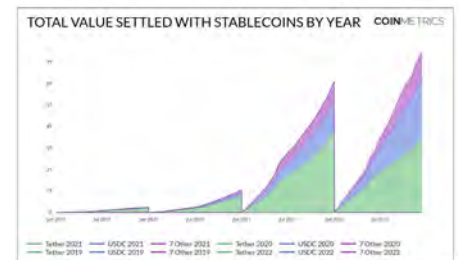

18 ARDUOUS (ADJECTIVE)

 **Full of difficulties; needing a lot of effort.**

Synonyms - Onerous, Taxing, Difficult

Antonyms - Easy, Effortless

Example An arduous journey



19 MENIAL (ADJECTIVE)

Of work not requiring much skill and lacking prestige.

Synonyms - Unskilled, Lowly, Humble

Antonyms - Noble, Elevated, Skilled

Example Menial factory jobs

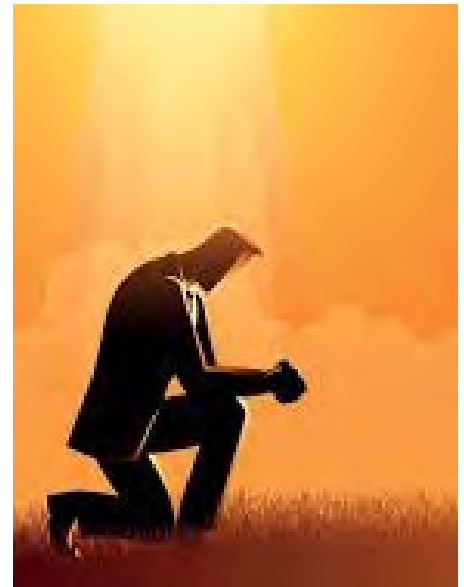

20 PENURY (NOUN)

The state of being very poor

Synonyms - Destitution, Pennilessness, Impoverishment

Antonyms - Wealth, Affluence

Example He could not face another year of penury

WORD OF THE DAY

Penury

(अत्यधिक गरीबी/ दरिद्रता)



Example:

People in Africa are living in penury.
अफ्रीका में लोग अत्यधिक गरीबी में जी रहे हैं।

21 EROSION (NOUN)

The gradual destruction of something

Synonyms - Decay, Decomposition

Antonyms - Purification, Forgiveness

Example The problem of soil erosion



22 IMPERIUM (NOUN)

 **Absolute power**

Synonyms - Superpower, Sovereignty

Antonyms - Impotence, Weakness

Example An outpost of their economic imperium

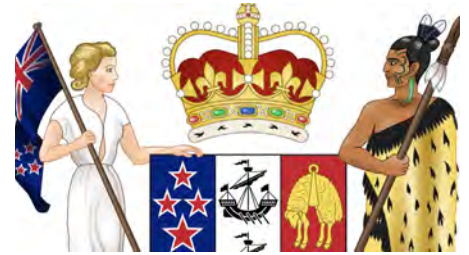

23 DEVIIOUS (ADJECTIVE)

 **Clever but not honest or direct**

Synonyms - Underhand, Roundabout

Antonyms - Direct, Above board

Example They arrived at the town by devious route



24 VITIATED (VERB)

 **To make something less effective, to spoil something.**

Synonyms - Deprave, Pervert, Debauch

Antonyms - Allow, Help

Example Programs have been vitiated by virus



25 WIELD (VERB)

To have and use power , authority

Synonyms - Flourish, Exert

Antonyms - Ignore, Misuse

Example A masked rider wielding a handgun



26 DUBIOUS (ADJECTIVE)

Not sure or certain

Synonyms - Hesitating, Unsure

Antonyms - Certain, Definite

Example Extremely dubious assumptions

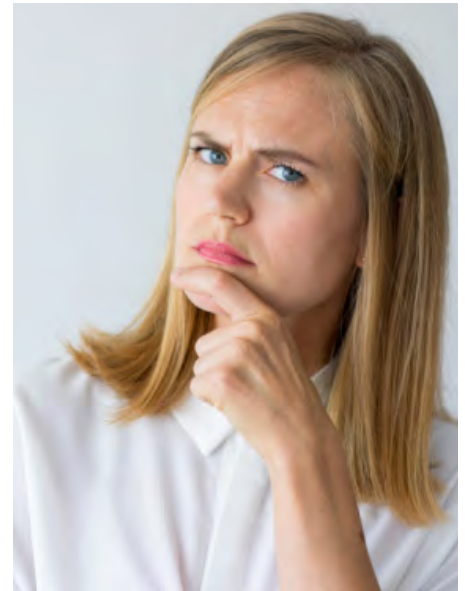

27 PERTINENT (ADJECTIVE)

Closely connected with the subject being discussed.

Synonyms - Relevant, Apposite

Antonyms - Irrelevant, Inappropriate

Example She asked me a lot of pertinent questions



28 PATRONAGE (NOUN)

Is the support, encouragement, privilege or financial aid that an organization or individual

Synonyms - Sponsorship, Backing

Antonyms - Attack, Harm, Hindrance

Example The arts could no longer depend on private patronage



29 EXPUNGE (VERB)

Obliterate or remove completely something unwanted

Synonyms - Erase, Remove, Delete

Antonyms - Restore, Retain

Example I have expunged phone number from my mobile



30 PRIVILEGE (NOUN)

A special right or advantage that granted only one person or group

Synonyms - Advantage, Right

Antonyms - Hindrance, Refusal

Example Education is a right, not a privilege



31 CURTAIL (VERB)

To make something shorter or smaller.

Synonyms - To reduce, diminish

Antonyms - Increase, lengthen

Example Civil liberties were further curtailed

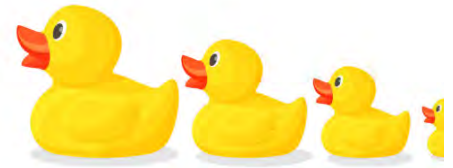

32 UNDER A CLOUD (PHRASAL VERB)

Under a suspicion

Synonyms - Discredited, Disgraced

Example The left under something of a cloud accused of misappropriating funds



33 LEGITIMACY (NOUN)

The quality of being reasonable and acceptable.

Synonyms - Lawfulness, Rightfulness

Antonyms - Illegality, Illegitimacy

Example The legitimacy of this procedure was identified by a range of tests.



34 REBELLION (NOUN)



Opposition to one in authority or dominance

Synonyms - Uprising, Revolt

Antonyms - Authority, Command

Example An act of teenage rebellion



35 COERCE (VERB)



To force somebody to do something

Synonyms - Constrain, Compel

Antonyms - Persuade

Example He was forced to go for shop



36 TOUCHSTONE (NOUN)



An established standard or principle by which something is judged

Synonyms - Gauge, Criterion

Antonyms - Aberration, Deviation

Example Japanese car industry was the touchstones of international success



37 OVERRULED (VERB)



To officially change a decision that someone else has made.

Synonyms - Cancel, Reverse

Antonyms - Allow, Accept

Example Welfare staff overruled an experienced detective.



38 PROLIFERATION (NOUN)



Rapid increase in the number or amount of something.

Synonyms - Growth, Snowballing, Burgeoning, Mushrooming

Antonyms - Decrease

Example A continuing threat of nuclear proliferation



39 DELEGATE (NOUN)



A person empowered to act on behalf of another.

Synonyms - Representative, Envoy

Antonyms - Separation, Division

Example The delegates rejected the proposal

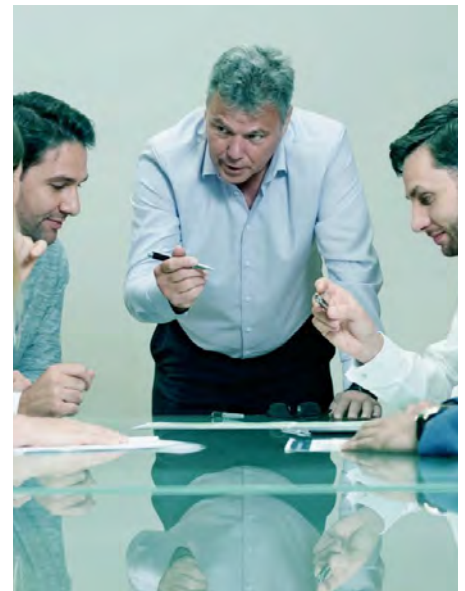

40 STEM FROM (PHRASAL) VERB)

 **To be caused by something or someone**

Synonyms - Arrive, Proceed, and Rise

Example Her problem stem from her difficult childhood



41 MUNDANE (ADJECTIVE)

 **Lacking interest or excitement**

Synonyms - Dull, Humdrum

Antonyms - Extraordinary

Example His mundane, humdrum existence

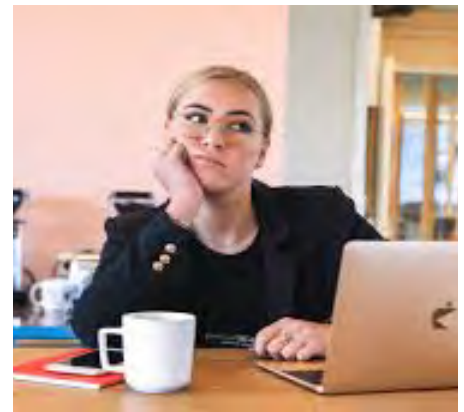

42 CATASTROPHIC (ADJECTIVE)

 **Causing sudden and very great harm or destruction.**

Synonyms - Disastrous, Calamitous

Antonyms - Happy, Fortunate

Example Catastrophic mismanagement of the economy



43 THE BACK BURNER (PHRASAL VERB)

 **A state temporary suspension, low priority**

Example A planned test of the new ale has been back-burned

High Medium Low Priority Monotone Icon

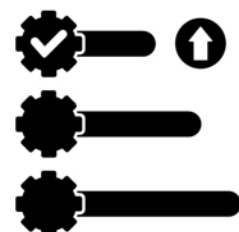

44 ECHELON (NOUN)

A level or rank in an organization, a profession or society

Synonyms - Level, Rank, Grade

Antonyms - Insignificance, Lowliness

Example The upper echelon of the business world



45 LANGUID (ADJECTIVE)

Lacking energy or causing a lack of energy or enthusiasm

Synonyms - Relaxed, Unhurried

Antonyms - Energetic, Active

Example His languid demeanor irritated



46 VEXED (ADJECTIVE)

Difficult to deal with and causing a lot of disagreements or arguments

Synonyms - Contentious, Debated

Antonyms - Undisputed, Content

Example I am very vexed with you

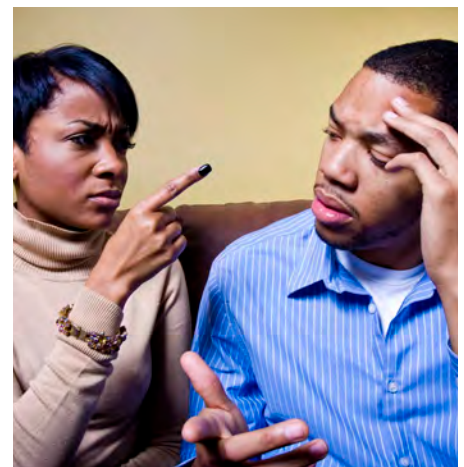

47

LOW KEY (ADJECTIVE)



Simple and not attracting attention.

Synonyms - Discreet, Modest

Antonyms - Ostentatious

Example Their marriage was a quiet, low-key affair.



48

STATUTORY (ADJECTIVE)



Decided, Controlled or required by law

Synonyms - Permitted

Antonyms - Illegal, Illicit

Example Statutory control over prices



49

IMPLICATIONS (NOUN)



Possible effects or results of an action or a decision.

Synonyms - Effect, Consequence

Antonyms - Explicit Statement

Example Our implication in the problems

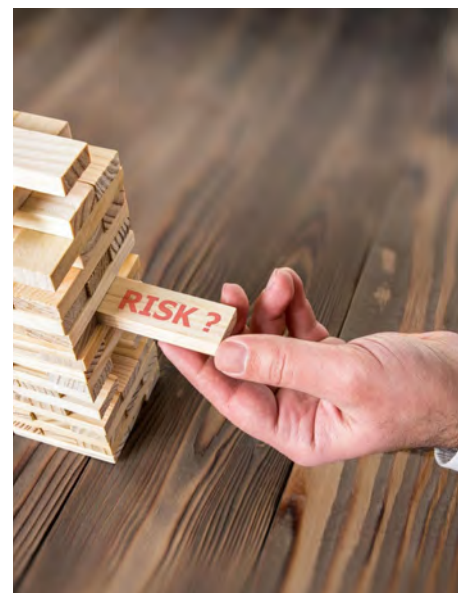

50 CONUNDRUM (NOUN)

 **A confusing problem or question that is very difficult to solve**

Synonyms - Enigma, Dilemma

Antonyms - Congruity

Example One of the most difficult conundrums for the experts

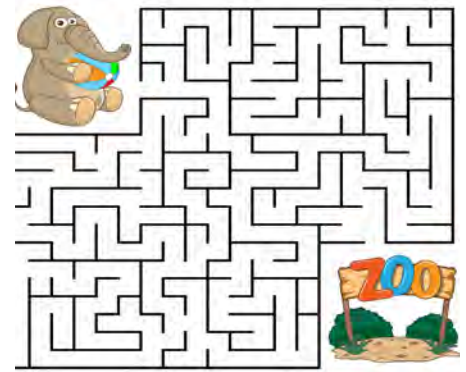

51 EUPHEMISM (NOUN)

 **A word or phrase used to avoid saying an unpleasant or offensive word.**

Synonyms - Substitute, Genteelism

Antonyms - Dysphemism

Example The jargon has given us downsizing as a euphemism for Cuts.

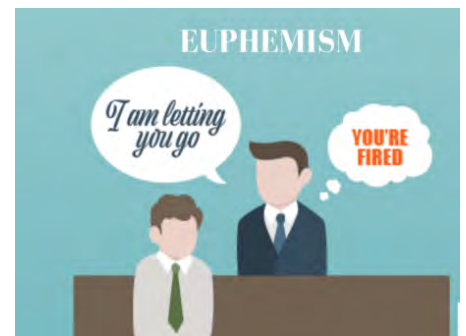

52 DECIMATED (VERB)

 **Severely damaged or made weaker.**

Synonyms - Ravage, Devastate, Havoc

Antonyms - Bear, Build

Example Youth decimated by thief

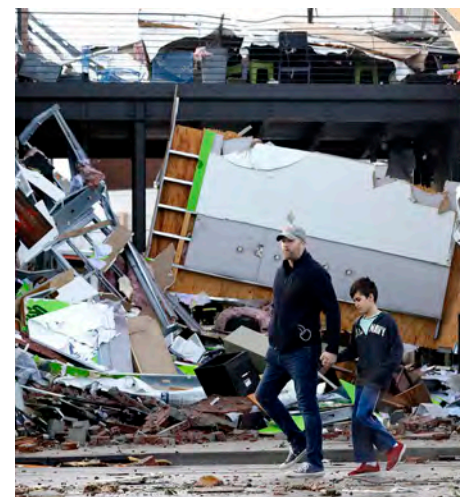

53 STALEMATE (NOUN)



A situation in which neither group involved in an argument can win or get an advantage and no action can be taken.

Synonyms - Deadlock, Impasse

Antonyms - Advance, Headway

Example The war again reached stalemate



54 OUTFITS (NOUN)



Groups of people working together as an organization, business, team, etc.

Synonyms - Uniform, Array

Antonyms - Irregular, Non-standard

Example The wedding outfit



55 HINGES ON (PHRASAL VERB)



Depends on something , or needs something in order to be successful

Example The outcome of election hinges on how the candidates perform in the debate



56 CARVING OUT (PHRASAL VERB)

To create or obtain something that helps you by skillful activities



57 ADDED INJURY TO INSULT (IDIOM)

Made bad situation worse with unfair treatment.

Example

They told me I was too old for the job, and then to add insult to injury, they refused to pay my expenses



58 HAVE ITS HANDS FULL (IDIOM)

To be very busy or involved with something

Synonyms - I would love to help but I have got my hands full



59 FILLIP (NOUN)

Something that causes a sudden improvement.

Synonyms - Padding, Wadding

Antonyms - Empty, Open

Example

Duvets with synthetic fillings



60 ENDURING (ADJECTIVE)

Continuing for a long time

Synonyms - Lasting, Durable

Antonyms - Die, Cease

Example We endured the lecture for as long as we could

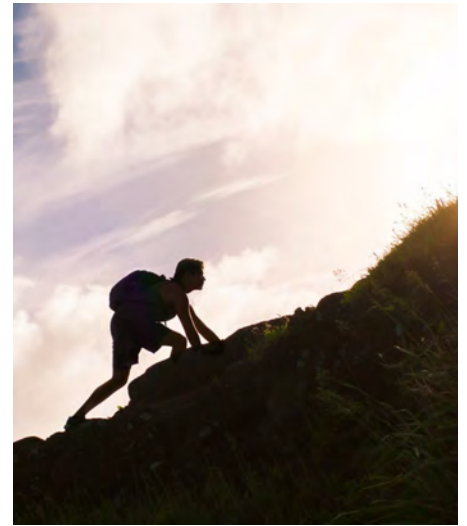

61 PENT-UP- (OF FEELING, ENERGY, ETC)

That cannot be expressed or released.

Synonyms - Suppressed

Example Pent-up frustrations



62 TRANCHE (NOUN)

One of the parts into which an amount of money or a number of shares in a company is divided.

Synonyms - Share, Proportion

Antonyms - Whole Event, Unity

Example They released the first tranche of the loan

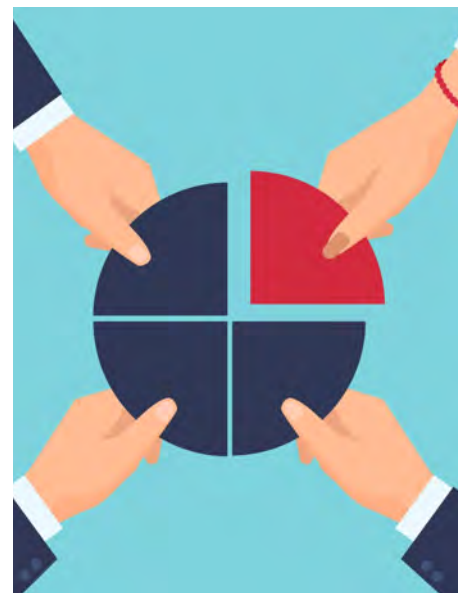

63 PERILOUS (ADJECTIVE)

 **Extremely dangerous**

Synonyms - Dangerous, Precarious

Antonyms - Safe, Secure

Example A perilous journey



64 PREPONDERANT (ADJECTIVE)

 **Larger in number or more important than other people or things in a group**

Synonyms - Predominant

Antonyms - Inferiority, Weakness

Example The preponderant influence of the US



65 FOREBODE (VERB)

 **To warn of or indicate an event, result, etc in advance**

Synonyms - Augur, Foresee

Antonyms - Good omen, Luck

Example She had foreboding of danger

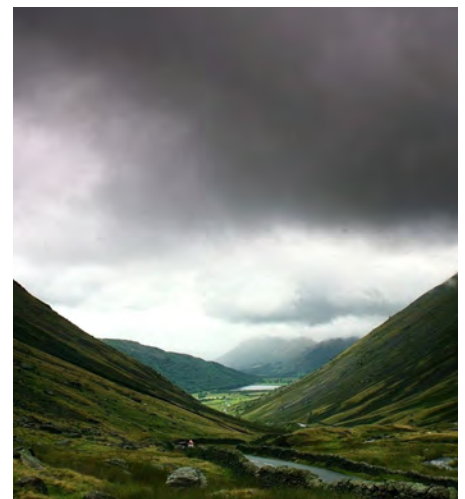

66 BLEAK (ADJECTIVE)

 **Of a situation not giving any reason to have hope or expect anything good**

Synonyms - Bare, Exposed

Antonyms - Lush, Verdant

Example A bleak midwinter's day



67 WEIGH ON (PHRASAL VERB)

 **To make someone feel worried and upset.**

Example His unhappiness would weigh on my mind so much

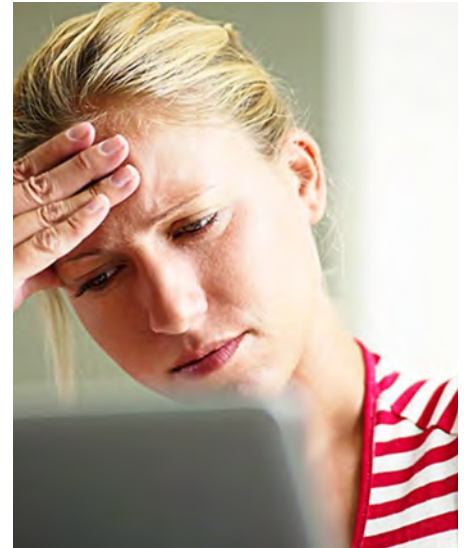

68 TAKE A BACK SEAT (IDIOM)

 **To be given a low priority.**

Example In future he would take a back seat in politic



69

WEIGHED DOWN (PHRASAL VERB)



Caused problems or difficulties for someone or something

Example

Too much responsibility when too young can weigh down on a child.



70

PIPE DREAM (NOUN)



An idea or plan that is impossible or very unlikely to happen

Synonyms - Fantasy, Illusion

Antonyms - Ignore, Neglect

Example

Free trade in international aviation will remain a pipe dream



71

POTABLE (ADJECTIVE)



Clean and safe to drink

Synonyms - Drinkable, Clean, Fresh

Antonyms - Undrinkable

Example

People always like potable water to drink



72 SHUN (VERB)

 **To avoid or refuse to accept someone or something**

Synonyms - Avoid, Eschew

Antonyms - Accept, Seek

Example She shuns fashionable society



73 EVIDENT (ADJECTIVE)

 **Easily seen or understood.**

Synonyms - Obvious, Apparent

Antonyms - Obscure

Example She ate biscuits with evident enjoyment

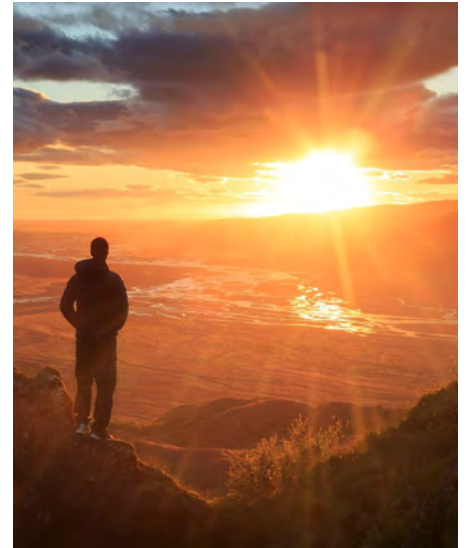

74 EMBELLISHMENT (NOUN)

 **Made something more beautiful or interesting by additions or details**

Synonyms - Decoration, Ornamentation

Antonyms - Plainness, Simplification

Example Architectural embellishments



75

SCOURGE (VERB)



Cause great suffering to.

Synonyms - Torment, Beset, Punish

Antonyms - Comfort, Aid

Example

Political methods used to scourge and oppress workers



76

ORNAMENTAL (NOUN)



Beautiful rather than useful

Synonyms - Decoration, Embellishment

Antonyms - Scar, Blemish

Example

Table covered with ornaments



77

PRECEDENT (NOUN)



A similar action or event that happened earlier.

Synonyms - Model, Exemplar

Antonyms - Atypical, Nonrepresentative

Example

The precedent solution is fit correctly



78 REVERT TO (PHRASAL VERB)

 To return to a former state; to start something again that you used to do in the past



79 RAISING EYEBROWS (IDIOM)

 Causing surprise or shock



80 SPORADICALLY (ADJECTIVE)

 Sometimes, but not regularly or continuously.

Synonyms - Irregularly, Occasionally, Sometimes

Antonyms - Frequently, Routinely

Example Sporadic fighting broke out



81 ERASURE (NOUN)

 The act of causing a feeling, memory, or a period of time to be completely forgotten.

Synonyms - Deletion, Expunging

Antonyms - Enactment, Institution

Example The erasure of prior history



82 APPROPRIATION



The act of taking something for your own use, usually without permission.

Synonyms - Relevant, Suitable

Antonyms - Inappropriate, Irrelevant

Example This is not the appropriate time



83 FOOTING (NOUN)



The basis on which something is established or organized.

Synonyms - Grip, Hold

Antonyms - Disconnect, Finish

Example He suddenly lost his footing



84 VANDALISM (NOUN)



The crime of intentionally damaging property belonging to other people

Synonyms - Defacement, Looting, Pillaging, Marauding

Antonyms - Protection, Conservation

Example An act of mindless vandalism



85 DISCONCERTING (ADJECTIVE)

 **Making someone feel uncertain and uncomfortable or worried.**

Synonyms - Unsettling, Unnerving

Antonyms - Relieve, Soothe

Example He had a disconcerting habit of offering jobs to people

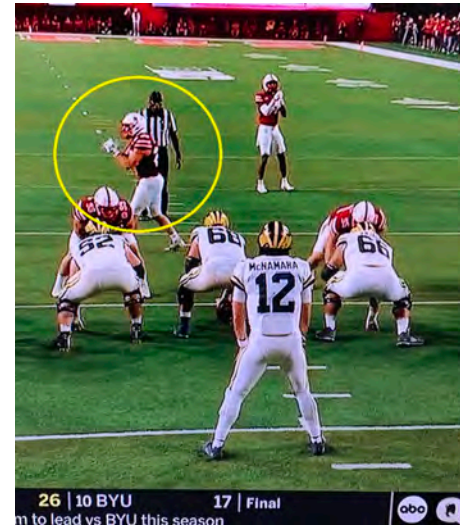

86 DISQUIET (VERB)

 **Feeling of worry and unhappiness about something.**

Synonyms - Perturb, Upset

Antonyms - Calm

Example He found Jean's gaze disquieting



87 SANS (PREPOSITION)

 **Without**

Synonyms - Devoid, Bereft

Antonyms - Flesh, Full

Example A picture of Mohan sans specs



88

OUTSTRIPPED (VERB)



Became greater than something or someone in amount, degree, or success.

Synonyms - Surpass, Exceed

Antonyms - Fall, Give up

Example Supply far outstripped demand



89

DILATION (NOUN)



Act or action of enlarging, expanding, or widening.

Synonyms - Amplify, Inflate

Antonyms - Contraction, Compression

Example Nitric oxide causes dilation of the blood vessels.



90

DE FACTO



Existing in fact, although perhaps not intended

Example Subjects obeyed de facto holders of power in exchange for Protection



91 TAMPING DOWN (PHRASAL VERB)

 Reducing the amount, level, size, or importance of something.

Synonyms - Self-satisfaction, Self-approval

Antonyms - Dissatisfaction

Example He tamped down the soil with his foot



92 FLAGRANT (ADJECTIVE)

 That shocks you because it is done in a very way and shows no respect for people, laws, etc.

Synonyms - Blatant, Glaring

Antonyms - Unobtrusive, Slight

Example A flagrant violation of the law.



93 SORDID (ADJECTIVE)

 Morally wrong and shocking

Synonyms - Dirty, Mucky

Antonyms - High-minded, Immaculate

Example The story paints a sordid picture



94 FRINGES (NOUN)



The outer or less important parts of an area, group, or activity.

Synonyms - Perimeter, Periphery

Antonyms - Middle, Mainstream

Example The southern fringes of the city



95 CHRONIC (ADJECTIVE)



Continuing for a long time

Synonyms - Persistent, Incurable

Antonyms - Acute, Good, Excellent

Example Chronic bronchitis

Chronic bronchitis

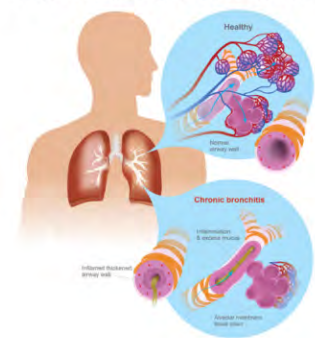

96 CRUSHING (VERB)



Causing overwhelming disappointment or embarrassment.

Synonyms - Severe, Suppress, Stamp out

Antonyms - Clear, Understanding

Example The news came as a crushing blow

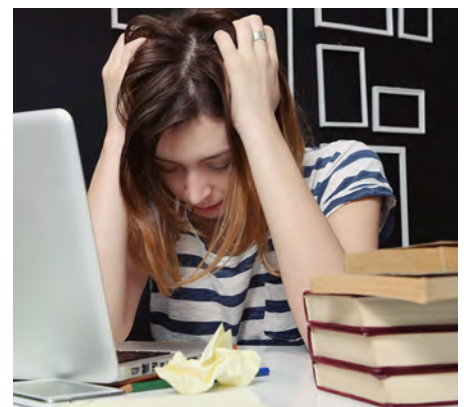

97 FOOLPROOF (ADJECTIVE)



So simple and easy to understand that it is unable to go wrong or be used wrongly.

Synonyms - Never failing, Reliable, Dependable

Antonyms - Flawed

Example A foolproof security system



98 TANTAMOUNT (ADJECTIVE)

 **Being almost the same or having the same effect as something, usually something bad.**

Synonyms - Equal to, Amounting to

Antonyms - Dissimilar, Unlike

Example The resignations were tantamount to an admission of guilt



99 INCONCEIVABLE (ADJECTIVE)

 **Impossible to imagine or think of.**

Synonyms - Unimaginable, Unthinkable

Antonyms - Likely

Example It seemed inconceivable that he had been unaware of what was going on



100 DISCRETION (NOUN)

 **The quality of behaving or speaking in such a way as to avoid causing offence.**

Synonyms - Care, Circumspection

Antonyms - Indiscretion

Example She know she could rely on his discretion

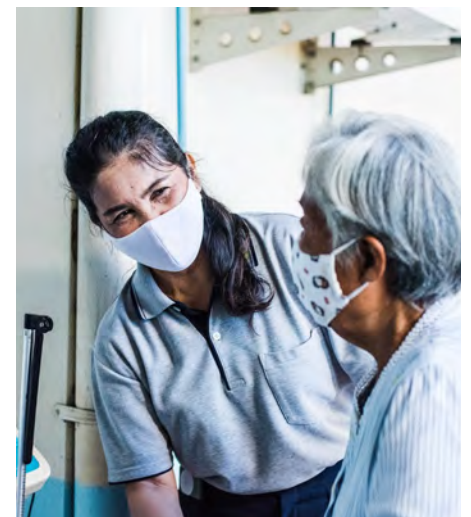

101 IN THE WAKE OF (IDIOM)

 **Happening after or as result of event.**

Example The committee was set up in the wake of the inquiry.



Current Affairs
CROSSWORD
PUZZLE

ANSWERS



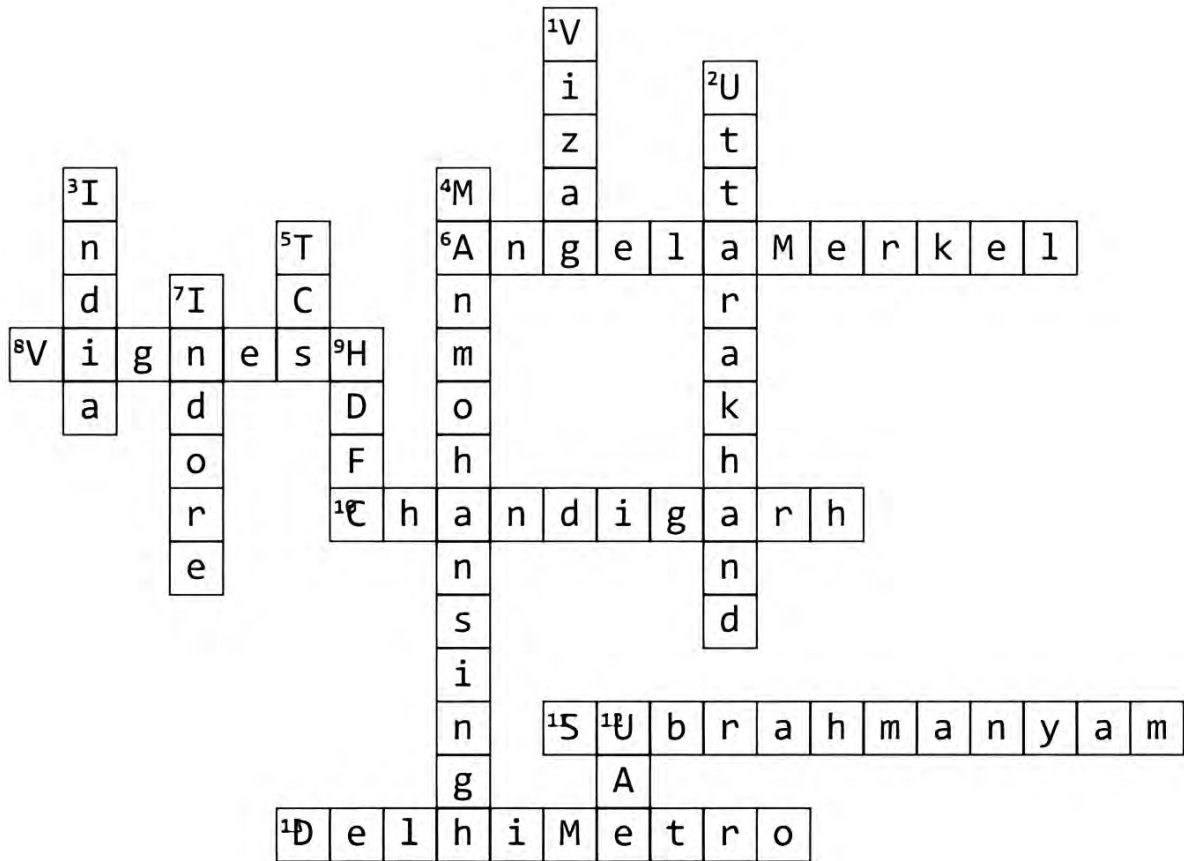

Across

- 6**
Felix Houphouet-Boigny UNESCO Peace Prize
- 8**
India's 80th Grandmaster
- 10**
First International Financial Architecture Working Group meeting of G-20 held
- 11**
Chief Executive Officer (CEO) of NITI Aayog
- 13**
First-ever indigenously developed train control & supervision system

Down

- 1** New capital of Andhra Pradesh
- 2** Venue of the 4th edition of Exercise DUSTLIK (2023) between the India-Uzbekistan military training
- 3** Focal country at 2025 Madrid International Book Fair
- 4** Lifetime Achievement Honour by the India-UK Achievers Honours in London
- 5** FORTUNE® magazine's list of the World's Most Admired Companies.
- 7** City have been listed on NSE marking the first-ever green bond issue by a municipal corporation in India
- 9** First private sector bank in India to take up aservice that allows customers to use RuPay credit cards on UPI with BHIM
- 12** Host the first vice-ministerial meeting of the I2U2